

Inspiron 15 5000

2-in-1

Service Manual

Computer Model: Inspiron 15-5579
Regulatory Model: P58F
Regulatory Type: P58F001



Notes, cautions, and warnings



NOTE: A NOTE indicates important information that helps you make better use of your product.



CAUTION: A CAUTION indicates either potential damage to hardware or loss of data and tells you how to avoid the problem.



WARNING: A WARNING indicates a potential for property damage, personal injury, or death.

Copyright © 2017 Dell Inc. or its subsidiaries. All rights reserved. Dell, EMC, and other trademarks are trademarks of Dell Inc. or its subsidiaries. Other trademarks may be trademarks of their respective owners.

2017 - 08

Rev. A00

Contents

Before working inside your computer.....	11
Before you begin	11
Safety instructions.....	11
Recommended tools.....	12
Screw list.....	13
After working inside your computer.....	15
Removing the base cover.....	16
Procedure.....	16
Replacing the base cover.....	19
Procedure.....	19
Removing the battery.....	20
Prerequisites.....	20
Procedure.....	20
Replacing the battery.....	22
Procedure.....	22
Post-requisites.....	22
Removing the memory modules.....	23
Prerequisites.....	23
Procedure.....	24



Replacing the memory modules.....	26
Procedure.....	26
Post-requisites.....	28
Removing the hard drive.....	29
Prerequisites.....	29
Procedure.....	29
Replacing the hard drive.....	34
Procedure.....	34
Post-requisites.....	34
Removing the coin-cell battery.....	35
Prerequisites.....	35
Procedure.....	35
Replacing the coin-cell battery.....	37
Procedure.....	37
Post-requisites.....	37
Removing the wireless card.....	38
Prerequisites.....	38
Procedure.....	38
Replacing the wireless card.....	40
Procedure.....	40
Post-requisites.....	41
Removing the status-light board.....	42
Prerequisites.....	42
Procedure.....	42



Replacing the status-light board.....	44
Procedure.....	44
Post-requisites.....	44
Removing the touchpad.....	45
Prerequisites.....	45
Procedure.....	45
Replacing the touchpad.....	48
Procedure.....	48
Post-requisites.....	48
Removing the speakers.....	49
Prerequisites.....	49
Procedure.....	49
Replacing the speakers.....	52
Procedure.....	52
Post-requisites.....	52
Removing the fan.....	53
Prerequisites.....	53
Procedure.....	53
Replacing the fan.....	55
Procedure.....	55
Post-requisites.....	55
Removing the heat sink.....	56
Prerequisites.....	56
Procedure.....	56



Replacing the heat sink.....	58
Procedure.....	58
Post-requisites.....	58
Removing the power-adapter port.....	59
Prerequisites.....	59
Procedure.....	59
Replacing the power-adapter port.....	61
Procedure.....	61
Post-requisites.....	61
Removing the power and volume-buttons board.....	62
Prerequisites.....	62
Procedure.....	62
Replacing the power and volume-buttons board.....	64
Procedure.....	64
Post-requisites.....	64
Removing the I/O board.....	65
Prerequisites.....	65
Procedure.....	65
Replacing the I/O board.....	68
Procedure.....	68
Post-requisites.....	68
Removing the system board.....	69
Prerequisites.....	69
Procedure.....	69



Replacing the system board.....	73
Procedure.....	73
Post-requisites.....	73
Entering the Service Tag in the BIOS setup program.....	74
Removing the display assembly.....	75
Prerequisites.....	75
Procedure.....	76
Replacing the display assembly.....	78
Procedure.....	78
Post-requisites.....	78
Removing the palm rest and keyboard assembly.....	79
Prerequisites.....	79
Procedure.....	79
Replacing the palm rest and keyboard assembly.....	81
Procedure.....	81
Post-requisites.....	81
Removing the display panel.....	82
Prerequisites.....	82
Procedure.....	82
Replacing the display panel.....	85
Procedure.....	85
Post-requisites.....	85
Removing the display cable.....	86
Prerequisites.....	86
Procedure.....	86



- Replacing the display cable..... 89**
 - Procedure..... 89
 - Post-requisites..... 89

- Removing the display back-cover and antenna assembly..... 90**
 - Prerequisites..... 90
 - Procedure..... 90

- Replacing the display back-cover and antenna assembly..... 92**
 - Procedure..... 92
 - Post-requisites..... 92

- Removing the camera..... 93**
 - Prerequisites..... 93
 - Procedure..... 93

- Replacing the camera..... 95**
 - Procedure..... 95
 - Post-requisites..... 95

- Removing the sensor board..... 96**
 - Prerequisites..... 96
 - Procedure..... 96

- Replacing the sensor board..... 98**
 - Procedure..... 98
 - Post-requisites..... 98



Downloading drivers.....	99
Downloading the audio driver.....	99
Downloading the graphics driver.....	99
Intel USB 3.0 xHCI.....	100
Downloading the Wi-Fi driver.....	100
Downloading the media-card reader driver.....	100
Downloading the chipset driver.....	101
Downloading the network driver.....	101
System setup.....	103
Boot Sequence.....	103
Navigation keys.....	103
BIOS overview.....	104
Entering BIOS setup program.....	104
System setup options.....	105
System and setup password.....	112
Assigning a system password and setup password.....	113
Deleting or changing an existing system and/or setup password.....	113
Clearing CMOS settings.....	114
Clearing forgotten passwords.....	114
Troubleshooting.....	115
Flashing the BIOS.....	115
Flashing BIOS (USB key).....	115
Enhanced Pre-Boot System Assessment (ePSA) diagnostics.....	116
Running the ePSA diagnostics.....	116
System diagnostic lights.....	117
Flea power release.....	118
Wi-Fi power cycle.....	119



Getting help and contacting Dell.....120
Self-help resources..... 120
Contacting Dell..... 121





Before working inside your computer



NOTE: The images in this document may differ from your computer depending on the configuration you ordered.

Before you begin

- 1 Save and close all open files and exit all open applications.
- 2 Shut down your computer. Click **Start** →  **Power** → **Shut down**.
 -  **NOTE:** If you are using a different operating system, see the documentation of your operating system for shut-down instructions.
- 3 Disconnect your computer and all attached devices from their electrical outlets.
- 4 Disconnect all attached network devices and peripherals, such as keyboard, mouse, and monitor from your computer.
- 5 Remove any media card and optical disc from your computer, if applicable.

Safety instructions

Use the following safety guidelines to protect your computer from potential damage and ensure your personal safety.



WARNING: Before working inside your computer, read the safety information that shipped with your computer. For more safety best practices, see the Regulatory Compliance home page at www.dell.com/regulatory_compliance.



WARNING: Disconnect all power sources before opening the computer cover or panels. After you finish working inside the computer, replace all covers, panels, and screws before connecting to the electrical outlet.



CAUTION: To avoid damaging the computer, ensure that the work surface is flat and clean.



- △ **CAUTION:** To avoid damaging the components and cards, handle them by their edges, and avoid touching pins and contacts.
- △ **CAUTION:** You should only perform troubleshooting and repairs as authorized or directed by the Dell technical assistance team. Damage due to servicing that is not authorized by Dell is not covered by your warranty. See the safety instructions that shipped with the product or at www.dell.com/regulatory_compliance.
- △ **CAUTION:** Before touching anything inside your computer, ground yourself by touching an unpainted metal surface, such as the metal at the back of the computer. While you work, periodically touch an unpainted metal surface to dissipate static electricity, which could harm internal components.
- △ **CAUTION:** When you disconnect a cable, pull on its connector or on its pull tab, not on the cable itself. Some cables have connectors with locking tabs or thumb-screws that you must disengage before disconnecting the cable. When disconnecting cables, keep them evenly aligned to avoid bending any connector pins. When connecting cables, ensure that the ports and connectors are correctly oriented and aligned.
- △ **CAUTION:** Press and eject any installed card from the media-card reader.













Recommended tools

The procedures in this document may require the following tools:





- Philips screwdriver #1
- Plastic scribe

Screw list

Table 1. Screw list

Component	Secured to	Screw type	Quantity	Screw image
Base cover	Palm rest and keyboard assembly	M2.5x7	10	
Battery	Palm rest and keyboard assembly	M2x3	2	
Display hinge	Palm rest and keyboard assembly	M2.5x7	2	
Display hinge	Display back-cover and antenna assembly	M2.5x2.5 Big Head	6	
Display hinge	Display back-cover and antenna assembly	M2x3	2	
Fan	Palm rest and keyboard assembly	M2x3	2	
Hard-drive bracket	Palm rest and keyboard assembly	M2x3	3	
Hard drive	Hard-drive bracket	M3x3	4	
I/O board	Palm rest and keyboard assembly	M2x3	2	
Power-adaptor port	Palm rest and keyboard assembly	M2x3	1	
Power and volume-buttons board	Palm rest and keyboard assembly	M2x3	1	
System board	Palm rest and keyboard assembly	M2x2 Big Head	5	



Component	Secured to	Screw type	Quantity	Screw image
Sensor board	Display panel	M2.5x2.5 Big Head	1	
Touchpad	Palm rest and keyboard assembly	M2x2	4	
Touchpad bracket	Palm rest and keyboard assembly	M2x2.5	3	
Wireless card	Palm rest and keyboard assembly	M2x3	1	

After working inside your computer



CAUTION: Leaving stray or loose screws inside your computer may severely damage your computer.

- 1 Replace all screws and ensure that no stray screws remain inside your computer.
- 2 Connect any external devices, peripherals, or cables you removed before working on your computer.
- 3 Replace any media cards, discs, or any other parts that you removed before working on your computer.
- 4 Connect your computer and all attached devices to their electrical outlets.
- 5 Turn on your computer.



Removing the base cover



WARNING: Before working inside your computer, read the safety information that shipped with your computer and follow the steps in [Before working inside your computer](#). After working inside your computer, follow the instructions in [After working inside your computer](#). For more safety best practices, see the Regulatory Compliance home page at www.dell.com/regulatory_compliance.

Procedure

- 1 Close the display and turn the computer over.

- 2 Remove the ten screws (M2.5x7) that secure the base cover to the palm rest and keyboard assembly.

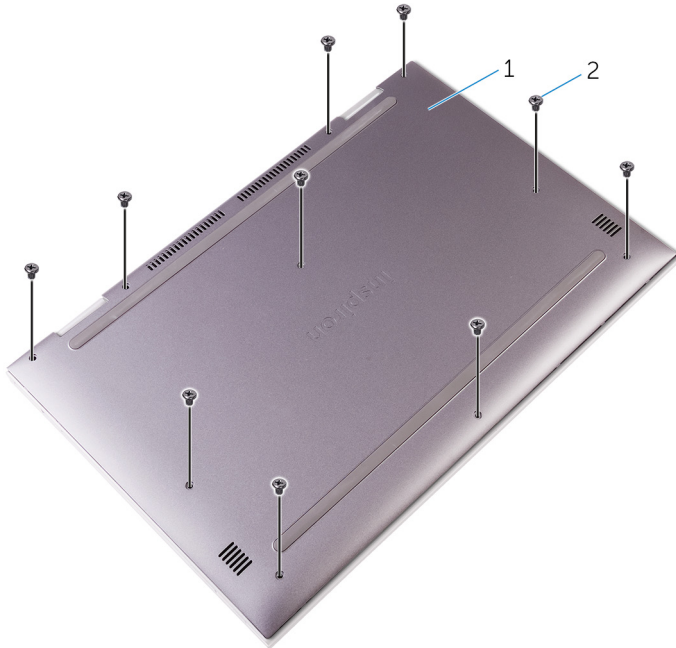

Figure 1. Removing screws from the base cover

1 base cover

2 screws (10)



- 3 Using a plastic scribe, pry the base cover off the palm rest and keyboard assembly.

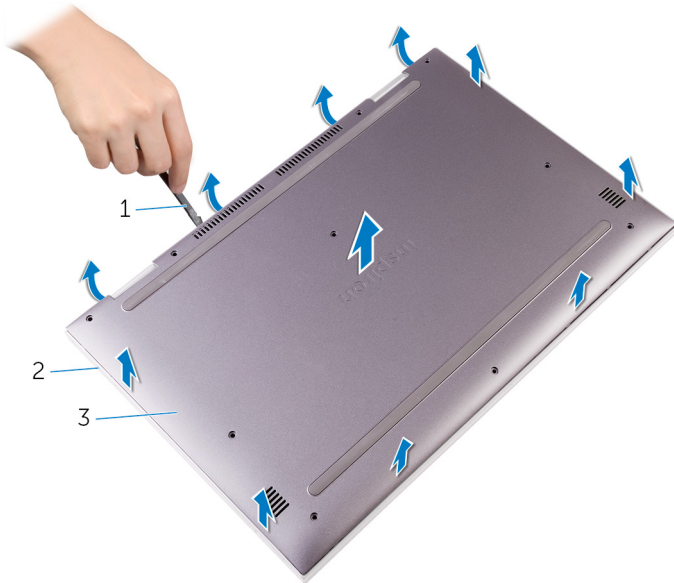

Figure 2. Removing the base cover

- | | | | |
|---|----------------|---|---------------------------------|
| 1 | plastic scribe | 2 | palm rest and keyboard assembly |
| 3 | base cover | | |

Replacing the base cover



WARNING: Before working inside your computer, read the safety information that shipped with your computer and follow the steps in [Before working inside your computer](#). After working inside your computer, follow the instructions in [After working inside your computer](#). For more safety best practices, see the Regulatory Compliance home page at www.dell.com/regulatory_compliance.

Procedure

- 1 Slide the tabs on the base cover into the slots on the palm rest and keyboard assembly and snap the base cover into place.
- 2 Replace the ten screws (M2.5x7) that secure the base cover to the palm rest and keyboard assembly.



Removing the battery



WARNING: Before working inside your computer, read the safety information that shipped with your computer and follow the steps in [Before working inside your computer](#). After working inside your computer, follow the instructions in [After working inside your computer](#). For more safety best practices, see the Regulatory Compliance home page at www.dell.com/regulatory_compliance.

Prerequisites

Remove the [base cover](#).

Procedure

- 1 Disconnect the battery cable from the system board.
- 2 Press and hold the power button for 5 seconds to ground the system board.
- 3 Remove the two screws (M2x3) that secure the battery to the palm rest and keyboard assembly.

- 4 Lift the battery along with its cable off the palm rest and keyboard assembly.

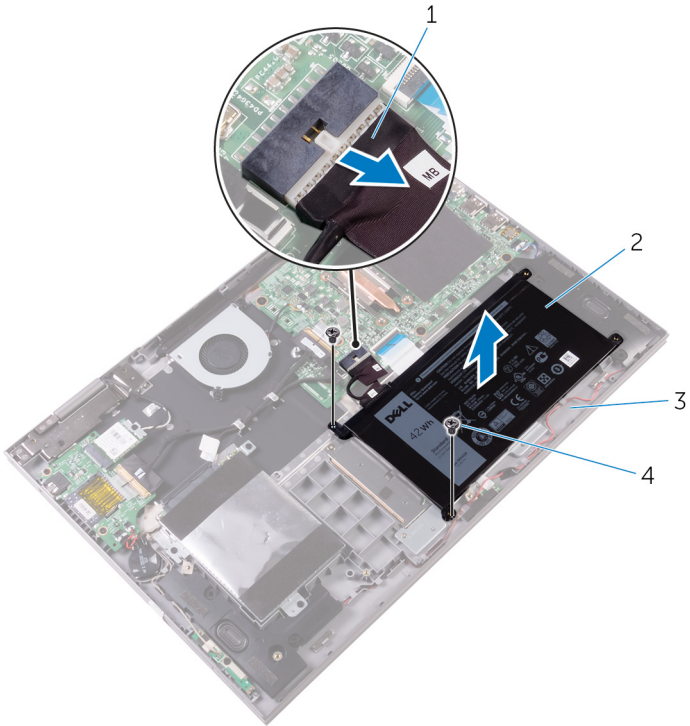

Figure 3. Removing the battery

- | | | | |
|---|---------------------------------|---|------------|
| 1 | battery cable | 2 | battery |
| 3 | palm rest and keyboard assembly | 4 | screws (2) |

Replacing the battery



WARNING: Before working inside your computer, read the safety information that shipped with your computer and follow the steps in [Before working inside your computer](#). After working inside your computer, follow the instructions in [After working inside your computer](#). For more safety best practices, see the Regulatory Compliance home page at www.dell.com/regulatory_compliance.

Procedure

- 1 Align the screw holes on the battery with the screw holes on the palm rest and keyboard assembly.
- 2 Replace the two screws (M2x3) that secure the battery to the palm rest and keyboard assembly.
- 3 Connect the battery cable to the system board.

Post-requisites

Replace the [base cover](#).

Removing the memory modules



WARNING: Before working inside your computer, read the safety information that shipped with your computer and follow the steps in [Before working inside your computer](#). After working inside your computer, follow the instructions in [After working inside your computer](#). For more safety best practices, see the Regulatory Compliance home page at www.dell.com/regulatory_compliance.

Prerequisites

- 1 Remove the [base cover](#).
- 2 Remove the [battery](#).



Procedure

- 1 Lift the Mylar from to access the memory module.

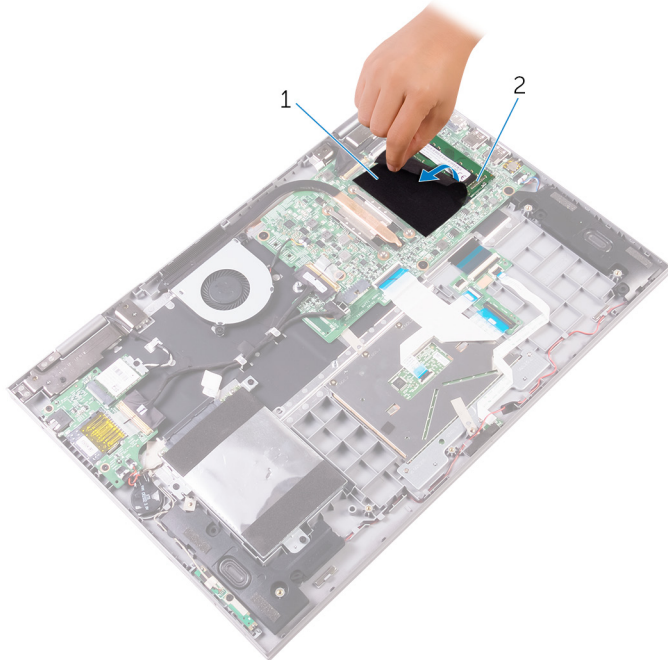

Figure 4. Removing the memory modules

- 1 Mylar
 - 2 memory module
- 2 Use your fingertips to carefully spread apart the securing-clips on each end of the memory-module slot until the memory module pops up.

- 3 Remove the memory module from the memory-module slot.

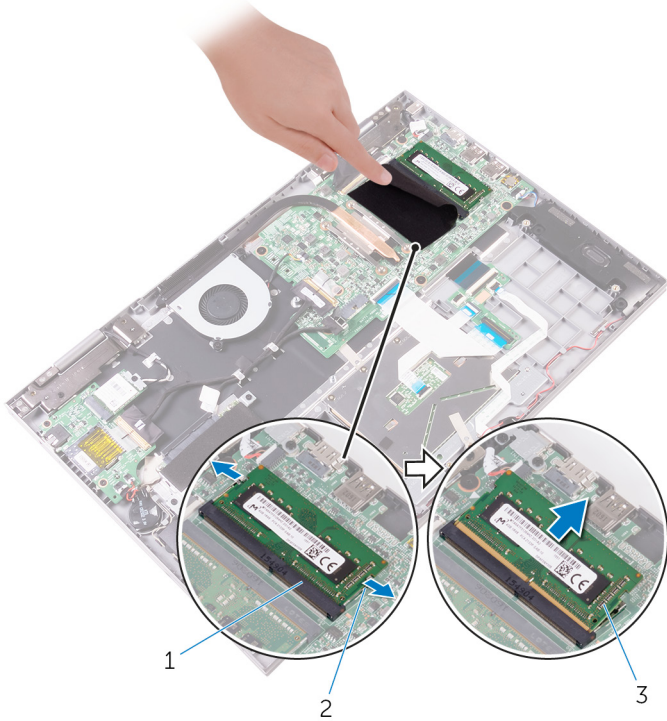

Figure 5. Removing the memory modules

- | | | | |
|---|--------------------|---|--------------------|
| 1 | memory-module slot | 2 | securing clips (2) |
| 3 | memory module | | |

Replacing the memory modules



WARNING: Before working inside your computer, read the safety information that shipped with your computer and follow the steps in [Before working inside your computer](#). After working inside your computer, follow the instructions in [After working inside your computer](#). For more safety best practices, see the Regulatory Compliance home page at www.dell.com/regulatory_compliance.

Procedure

- 1 Lift the Mylar to access the memory-module slot.
- 2 Align the notch on the memory module with the tab on the memory-module slot.

- Slide the memory module firmly into the slot at an angle and press the memory module down until it clicks into place.

 **NOTE: If you do not hear the click, remove the memory module and reinstall it.**

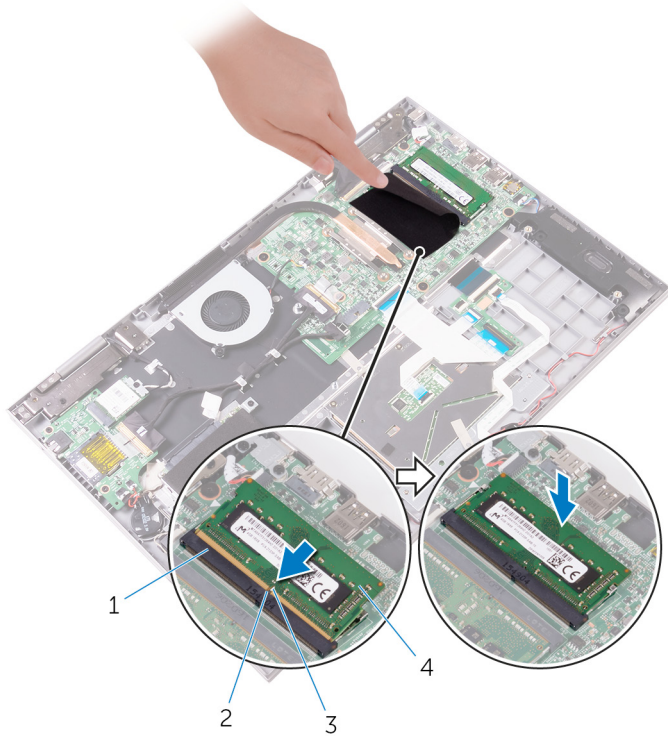

Figure 6. Replacing the memory modules

- | | | | |
|---|--------------------|---|---------------|
| 1 | memory-module slot | 2 | tab |
| 3 | notch | 4 | memory module |

Post-requisites

- 1 Replace the [battery](#).
- 2 Replace the [base cover](#).



Removing the hard drive

 **WARNING:** Before working inside your computer, read the safety information that shipped with your computer and follow the steps in [Before working inside your computer](#). After working inside your computer, follow the instructions in [After working inside your computer](#). For more safety best practices, see the Regulatory Compliance home page at www.dell.com/regulatory_compliance.

 **CAUTION:** Hard drives are fragile. Exercise care when handling the hard drive.

 **CAUTION:** To avoid data loss, do not remove the hard drive while the computer is in sleep or on state.

Prerequisites

- 1 Remove the [base cover](#).
- 2 Remove the [battery](#).

Procedure

- 1 Using the pull tab, disconnect the hard-drive cable from the system board.
- 2 Peel off the tape that secures the hard-drive cable to the palm rest and keyboard assembly.



- 3** Note the hard-drive cable routing and remove the cable from the routing guides.

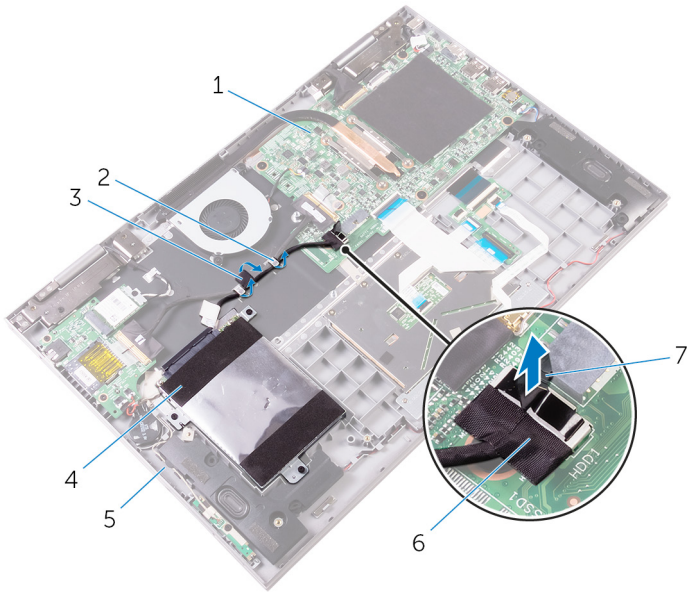

Figure 7. Removing the hard-drive assembly

- | | | | |
|---|---------------------------------|---|---------------------|
| 1 | system board | 2 | routing guides |
| 3 | tape | 4 | hard-drive assembly |
| 5 | palm rest and keyboard assembly | 6 | hard-drive cable |
| 7 | pull tab | | |

- 4** Remove the three screws (M2x3) that secure the hard-drive assembly to the palm rest and keyboard.

- 5 Lift the hard-drive assembly along with its cable off the palm rest and keyboard assembly.

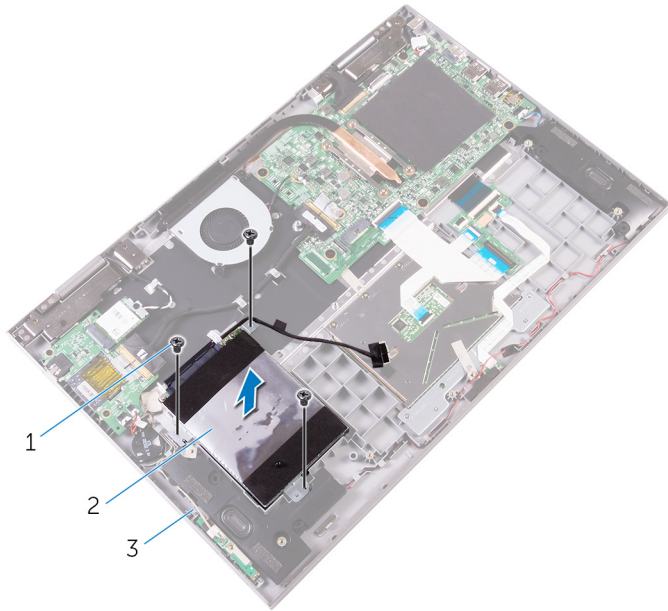

Figure 8. Removing the hard-drive assembly

- | | | | |
|---|---------------------------------|---|---------------------|
| 1 | screws (3) | 2 | hard-drive assembly |
| 3 | palm rest and keyboard assembly | | |

- 6 Disconnect the interposer from the hard-drive assembly.

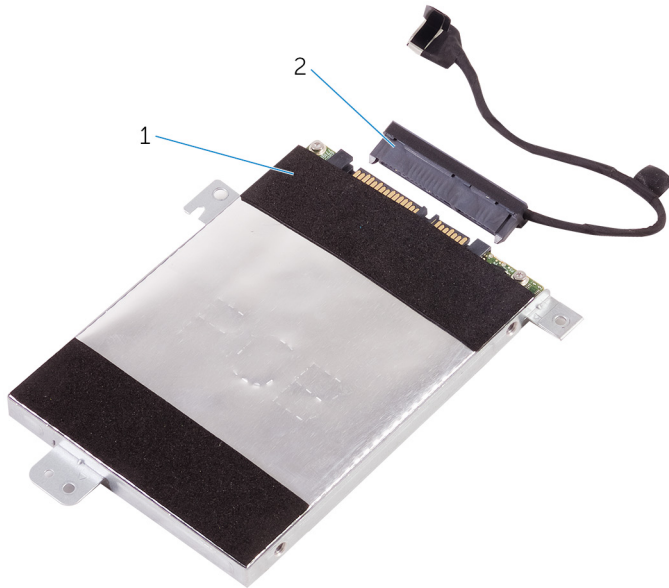

Figure 9. Disconnecting the interposer

1 hard-drive assembly

2 interposer

- 7 Remove the four screws (M3x3) that secure the hard-drive bracket to the hard drive.

- 8 Lift the hard drive off the hard-drive bracket.

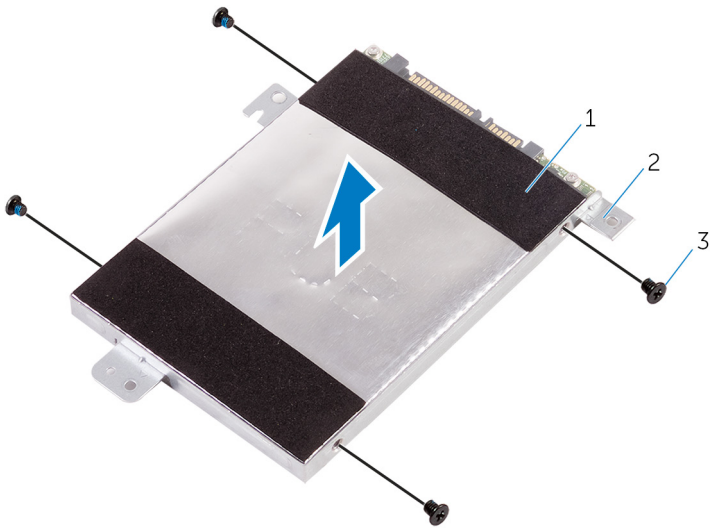



Figure 10. Removing the hard-drive bracket

- 1 hard drive
3 screws (4)

- 2 hard-drive bracket

Replacing the hard drive

 **WARNING:** Before working inside your computer, read the safety information that shipped with your computer and follow the steps in [Before working inside your computer](#). After working inside your computer, follow the instructions in [After working inside your computer](#). For more safety best practices, see the Regulatory Compliance home page at www.dell.com/regulatory_compliance.

 **CAUTION:** Hard drives are fragile. Exercise care when handling the hard drive.

Procedure

- 1 Align the screw holes on the hard-drive bracket with the screw holes on the hard drive.
- 2 Replace the four screws (M3x3) that secure the hard-drive bracket to the hard drive.
- 3 Connect the interposer to the hard-drive assembly.
- 4 Align the screw holes on the hard-drive assembly with the screw holes on the palm rest and keyboard assembly.
- 5 Replace the screws three (M2x3) that secure the hard-drive assembly to the palm rest and keyboard assembly.
- 6 Route the hard-drive cable through the routing guides on the palm rest and keyboard assembly.
- 7 Connect the hard-drive cable to the system board.
- 8 Adhere the tape that secures the hard-drive cable to the palm rest and keyboard assembly.

Post-requisites

- 1 Replace the [battery](#).
- 2 Replace the [base cover](#).

Removing the coin-cell battery

 **WARNING:** Before working inside your computer, read the safety information that shipped with your computer and follow the steps in [Before working inside your computer](#). After working inside your computer, follow the instructions in [After working inside your computer](#). For more safety best practices, see the Regulatory Compliance home page at www.dell.com/regulatory_compliance.

 **CAUTION:** Removing the coin-cell battery resets the BIOS setup program's settings to default. It is recommended that you note the BIOS setup program's settings before removing the coin-cell battery.

Prerequisites

- 1 Remove the [base cover](#).
- 2 Remove the [battery](#).

Procedure

- 1 Disconnect the coin-cell battery cable from the I/O board.



- 2 Peel the coin-cell battery off the palm rest and keyboard assembly.

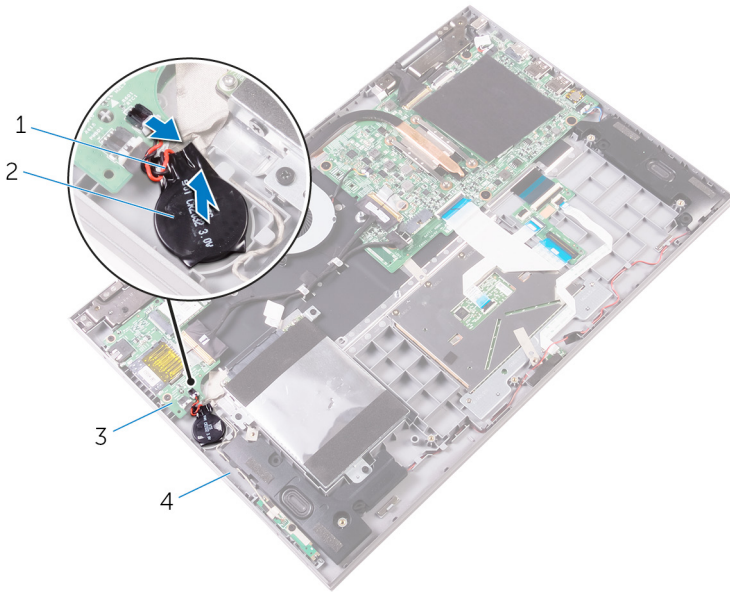

Figure 11. Removing the coin-cell battery

- | | | | |
|---|-------------------------|---|---------------------------------|
| 1 | coin-cell battery cable | 2 | coin-cell battery |
| 3 | I/O board | 4 | palm rest and keyboard assembly |

Replacing the coin-cell battery



WARNING: Before working inside your computer, read the safety information that shipped with your computer and follow the steps in [Before working inside your computer](#). After working inside your computer, follow the instructions in [After working inside your computer](#). For more safety best practices, see the Regulatory Compliance home page at www.dell.com/regulatory_compliance.

Procedure

- 1 Adhere the coin-cell battery to the palm rest and keyboard assembly.
- 2 Connect the coin-cell battery cable to the I/O board.

Post-requisites

- 1 Replace the [battery](#).
- 2 Replace the [base cover](#).



Removing the wireless card



WARNING: Before working inside your computer, read the safety information that shipped with your computer and follow the steps in [Before working inside your computer](#). After working inside your computer, follow the instructions in [After working inside your computer](#). For more safety best practices, see the Regulatory Compliance home page at www.dell.com/regulatory_compliance.

Prerequisites

- 1 Remove the [base cover](#).
- 2 Remove the [battery](#).

Procedure

- 1 Remove the screw (M2x3) that secures the wireless-card bracket to the wireless card and the palm rest and keyboard assembly.
- 2 Remove the wireless-card bracket and disconnect the antenna cables from the wireless card.

- 3 Slide and remove the wireless card from the wireless-card slot.

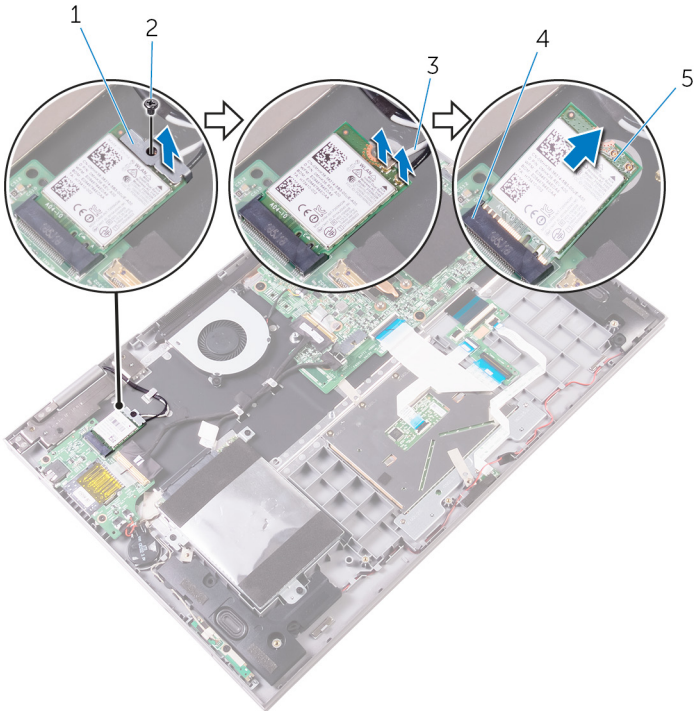



Figure 12. Removing the wireless card

- | | | | |
|---|-----------------------|---|--------------------|
| 1 | wireless-card bracket | 2 | screw |
| 3 | antenna cables (2) | 4 | wireless-card slot |
| 5 | wireless card | | |

Replacing the wireless card

 **WARNING:** Before working inside your computer, read the safety information that shipped with your computer and follow the steps in [Before working inside your computer](#). After working inside your computer, follow the instructions in [After working inside your computer](#). For more safety best practices, see the Regulatory Compliance home page at www.dell.com/regulatory_compliance.

Procedure

 **CAUTION:** To avoid damage to the wireless card, do not place any cables under it.

- 1 Align the notch on the wireless card with the tab on the wireless-card slot.
- 2 Insert the wireless card at an angle into the wireless-card slot.
- 3 Connect the antenna cables to the wireless card.

The following table provides the antenna-cable color scheme for the wireless card supported by your computer.

Table 2. Antenna-cable color scheme

Connectors on the wireless card	Antenna-cable color
Main (white triangle)	White
Auxiliary (black triangle)	Black

- 4 Align the screw hole on the wireless-card bracket with the screw hole on the wireless card and the palm rest and keyboard assembly.

- 5 Replace the screw (M2x3) that secures the wireless-card bracket to the wireless card and the palm rest and keyboard assembly.

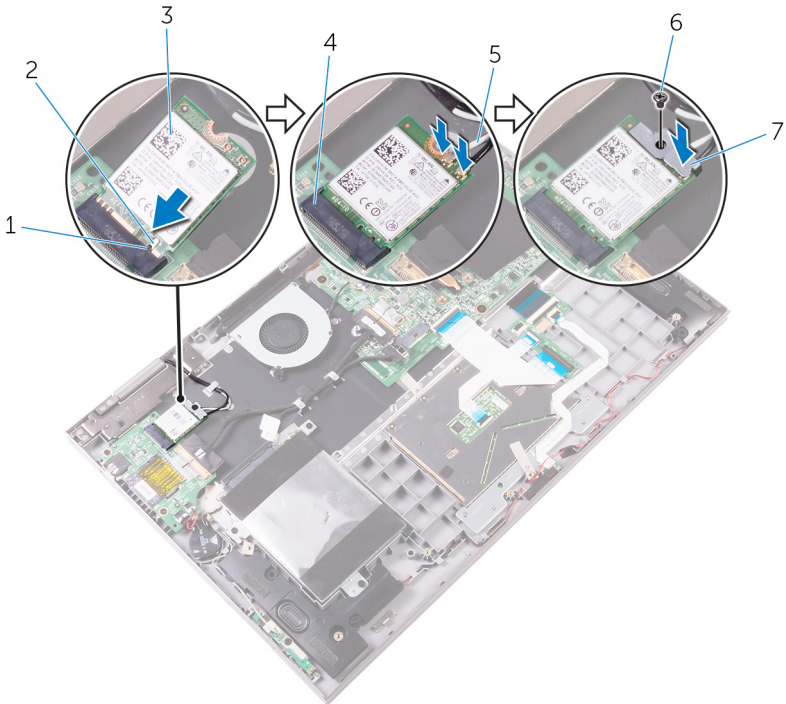

Figure 13. Replacing the wireless card

- | | | | |
|---|-----------------------|---|--------------------|
| 1 | tab | 2 | notch |
| 3 | wireless card | 4 | wireless-card slot |
| 5 | antenna cables (2) | 6 | screw |
| 7 | wireless-card bracket | | |

Post-requisites

- 1 Replace the [battery](#).
- 2 Replace the [base cover](#).



Removing the status-light board



WARNING: Before working inside your computer, read the safety information that shipped with your computer and follow the steps in [Before working inside your computer](#). After working inside your computer, follow the instructions in [After working inside your computer](#). For more safety best practices, see the Regulatory Compliance home page at www.dell.com/regulatory_compliance.

Prerequisites

- 1 Remove the [base cover](#).
- 2 Remove the [battery](#).

Procedure

- 1 Open the latch and disconnect the status-light board cable from the system board.
- 2 Peel off the foam that secures the status-light board to the palm rest and keyboard assembly.

- 3 Lift the status-light board along with its cable off the palm rest and keyboard assembly.

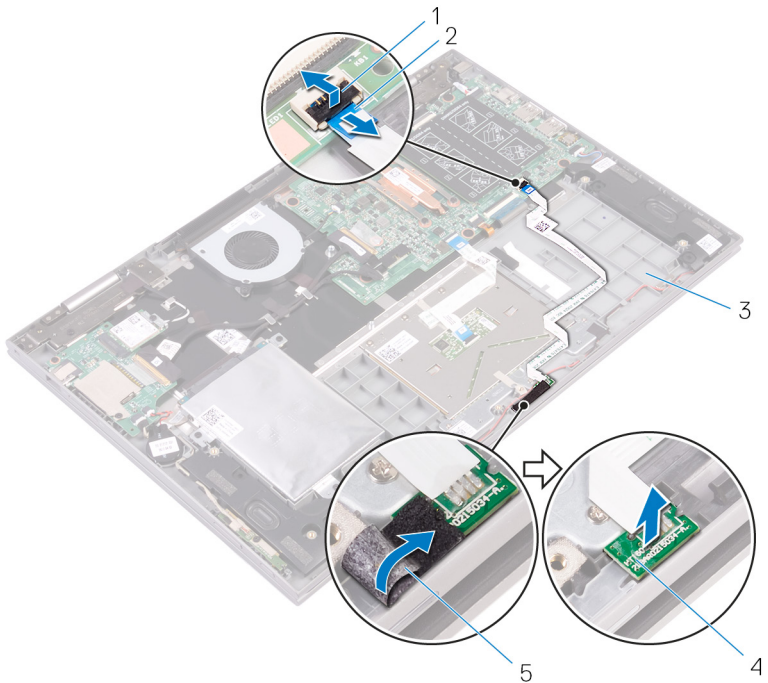

Figure 14. Removing the status-light board

- | | | | |
|---|---------------------------------|---|--------------------------|
| 1 | latch | 2 | status-light board cable |
| 3 | palm rest and keyboard assembly | 4 | status-light board |
| 5 | foam | | |

Replacing the status-light board



WARNING: Before working inside your computer, read the safety information that shipped with your computer and follow the steps in [Before working inside your computer](#). After working inside your computer, follow the instructions in [After working inside your computer](#). For more safety best practices, see the Regulatory Compliance home page at www.dell.com/regulatory_compliance.

Procedure

- 1 Place the status-light board into the slot on the palm rest and keyboard assembly.
- 2 Slide the status-light board cable into the connector on the system board and close the latch to secure the cable.
- 3 Adhere the foam that secures the status-light board to the palm rest and keyboard assembly.

Post-requisites

- 1 Replace the [battery](#).
- 2 Replace the [base cover](#).

Removing the touchpad



WARNING: Before working inside your computer, read the safety information that shipped with your computer and follow the steps in [Before working inside your computer](#). After working inside your computer, follow the instructions in [After working inside your computer](#). For more safety best practices, see the Regulatory Compliance home page at www.dell.com/regulatory_compliance.

Prerequisites

- 1 Remove the [base cover](#).
- 2 Remove the [battery](#).
- 3 Remove the [status-light board](#).

Procedure

- 1 Open the latch, and then disconnect the touchpad cable from the system board.
- 2 Peel off the touchpad cable from the touchpad.



- 3 Peel off the tape that secures the touchpad assembly to the palm rest and keyboard assembly.

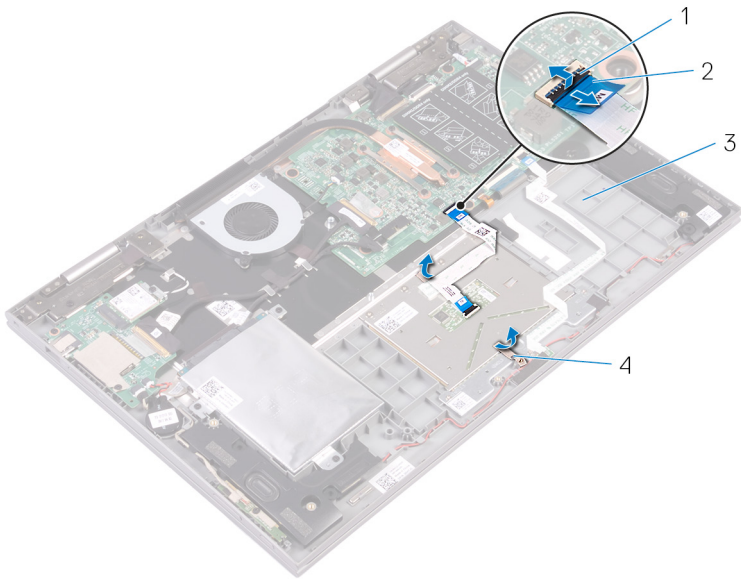

Figure 15. Disconnecting the touchpad cable

- | | | | |
|---|---------------------------------|---|----------------|
| 1 | latches | 2 | touchpad cable |
| 3 | palm rest and keyboard assembly | 4 | tape |
- 4 Remove the four screws (M2x2) that secure the touchpad to the palm rest and keyboard assembly.

- 5 Lift the touchpad at an angle off the palm rest and keyboard assembly.

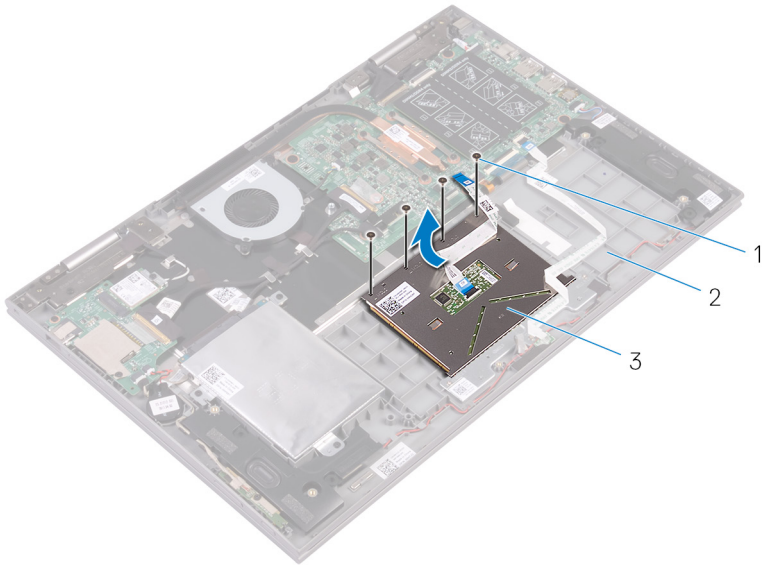

Figure 16. Removing the touchpad

- | | | | |
|---|------------|---|---------------------------------|
| 1 | screws (4) | 2 | palm rest and keyboard assembly |
| 3 | touchpad | | |

Replacing the touchpad



WARNING: Before working inside your computer, read the safety information that shipped with your computer and follow the steps in [Before working inside your computer](#). After working inside your computer, follow the instructions in [After working inside your computer](#). For more safety best practices, see the Regulatory Compliance home page at www.dell.com/regulatory_compliance.

Procedure

- 1 Slide the touchpad into the slot on the palm rest and keyboard assembly.
- 2 Align the screw holes on the touchpad with the screw holes on the palm rest and keyboard assembly.
- 3 Replace the four screws (M2x2) that secure the touchpad to the palm rest and keyboard assembly.
- 4 Adhere the tape that secures the touchpad to the palm rest and keyboard assembly.
- 5 Adhere the touchpad cable to the touchpad.
- 6 Slide the end of the touchpad cable into the connector on the system board and close the latch to secure the cable.

Post-requisites

- 1 Replace the [status-light board](#).
- 2 Replace the [battery](#).
- 3 Replace the [base cover](#).

Removing the speakers



WARNING: Before working inside your computer, read the safety information that shipped with your computer and follow the steps in [Before working inside your computer](#). After working inside your computer, follow the instructions in [After working inside your computer](#). For more safety best practices, see the Regulatory Compliance home page at www.dell.com/regulatory_compliance.

Prerequisites

- 1 Remove the [base cover](#).
- 2 Remove the [battery](#).

Procedure

- 1 Disconnect the speaker cable from the system board.
- 2 Disconnect the power and volume-buttons board cable and the coin-cell battery cable from the I/O board.
- 3 Note the cable routing and remove the power and volume-buttons board cable from the routing guides on the palm rest and keyboard assembly and the speaker.
- 4 Note the cable routing and remove the speaker cable from the routing guides on the palm rest and keyboard assembly.



- 5 Peel off the tape that secures the speaker cable to the palm rest and keyboard assembly.

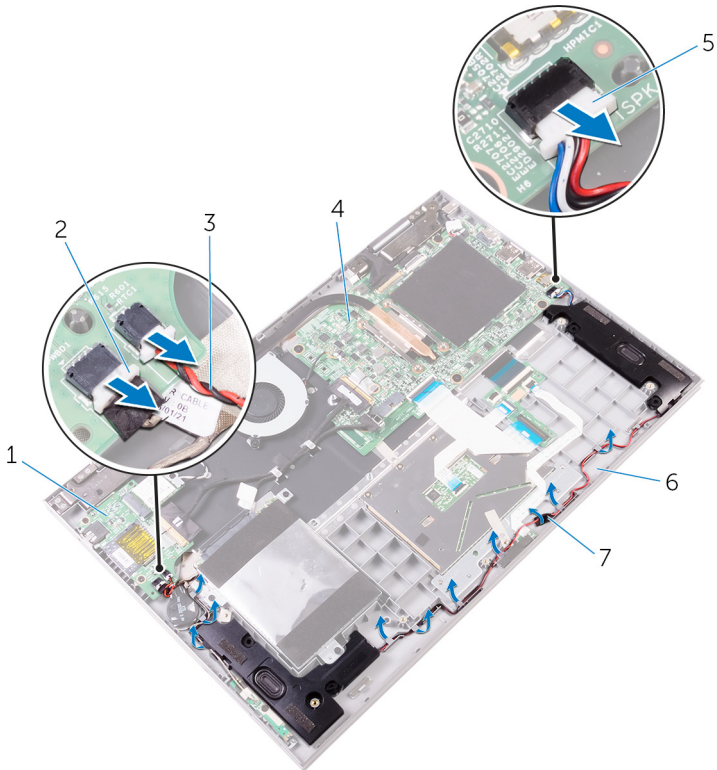

Figure 17. Removing the speakers

- | | | | |
|---|-------------------------|---|--------------------------------------|
| 1 | I/O board | 2 | power and volume-buttons board cable |
| 3 | coin-cell battery cable | 4 | system board |
| 5 | speaker cable | 6 | palm rest and keyboard assembly |
| 7 | tape | | |

- 6 Release the tabs on the speakers from the slots on the palm rest and keyboard assembly and lift the speakers along with the cable off the palm rest and keyboard assembly.

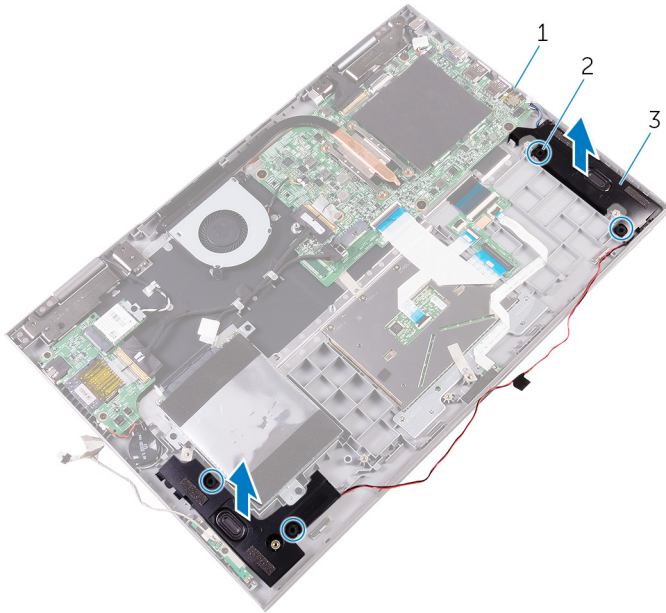

Figure 18. Removing the speakers

- | | | | |
|---|--------------|---|----------|
| 1 | system board | 2 | tabs (4) |
| 3 | speakers (2) | | |

Replacing the speakers



WARNING: Before working inside your computer, read the safety information that shipped with your computer and follow the steps in [Before working inside your computer](#). After working inside your computer, follow the instructions in [After working inside your computer](#). For more safety best practices, see the Regulatory Compliance home page at www.dell.com/regulatory_compliance.

Procedure

- 1 Using the tabs on the speakers, place the speakers in the slots on the palm rest and keyboard assembly and snap the speakers into place.
- 2 Route the speaker cable through the routing guides on the palm rest and keyboard assembly.
- 3 Adhere the tape that secures the speaker cable to the palm rest and keyboard assembly.
- 4 Connect the speaker cable to the system board.
- 5 Route the power and volume-buttons board cable through the routing guides on the speaker and the palm rest and keyboard assembly.
- 6 Connect the power and volume-buttons board cable and the coin-cell battery cable to the I/O board.

Post-requisites

- 1 Replace the [battery](#).
- 2 Replace the [base cover](#).

Removing the fan



WARNING: Before working inside your computer, read the safety information that shipped with your computer and follow the steps in [Before working inside your computer](#). After working inside your computer, follow the instructions in [After working inside your computer](#). For more safety best practices, see the Regulatory Compliance home page at www.dell.com/regulatory_compliance.

Prerequisites

- 1 Remove the [base cover](#).
- 2 Remove the [battery](#).

Procedure

- 1 Disconnect the fan cable from the system board.
- 2 Remove the two screws (M2x3) that secure the fan to the palm rest and keyboard assembly.



- 3 Lift the fan along with its cable off the palm rest and keyboard assembly.

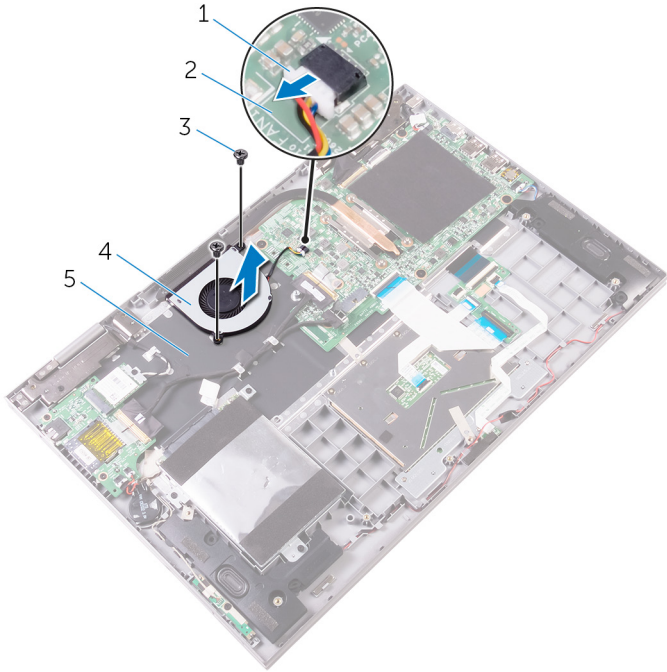

Figure 19. Removing the fan

- | | | | |
|---|---------------------------------|---|--------------|
| 1 | fan cable | 2 | system board |
| 3 | screws (2) | 4 | fan |
| 5 | palm rest and keyboard assembly | | |

Replacing the fan



WARNING: Before working inside your computer, read the safety information that shipped with your computer and follow the steps in [Before working inside your computer](#). After working inside your computer, follow the instructions in [After working inside your computer](#). For more safety best practices, see the Regulatory Compliance home page at www.dell.com/regulatory_compliance.

Procedure

- 1 Align the screw holes on the fan with the screw holes on the palm rest and keyboard assembly.
- 2 Replace the two screws (M2x3) that secure the fan to the palm rest and keyboard assembly.
- 3 Connect the fan cable to the system board.

Post-requisites

- 1 Replace the [battery](#).
- 2 Replace the [base cover](#).



Removing the heat sink

 **WARNING:** Before working inside your computer, read the safety information that shipped with your computer and follow the steps in [Before working inside your computer](#). After working inside your computer, follow the instructions in [After working inside your computer](#). For more safety best practices, see the Regulatory Compliance home page at www.dell.com/regulatory_compliance.

 **WARNING:** The heat sink may become hot during normal operation. Allow sufficient time for the heat sink to cool before you touch it.

 **CAUTION:** For maximum cooling of the processor, do not touch the heat transfer areas on the heat sink. The oils in your skin can reduce the heat transfer capability of the thermal grease.

Prerequisites

- 1 Remove the [base cover](#).
- 2 Remove the [battery](#).

Procedure

- 1 In sequential order (as indicated on the heat sink), loosen the captive screws that secure the heat sink to the system board.

- 2 Lift the heat sink off the system board.

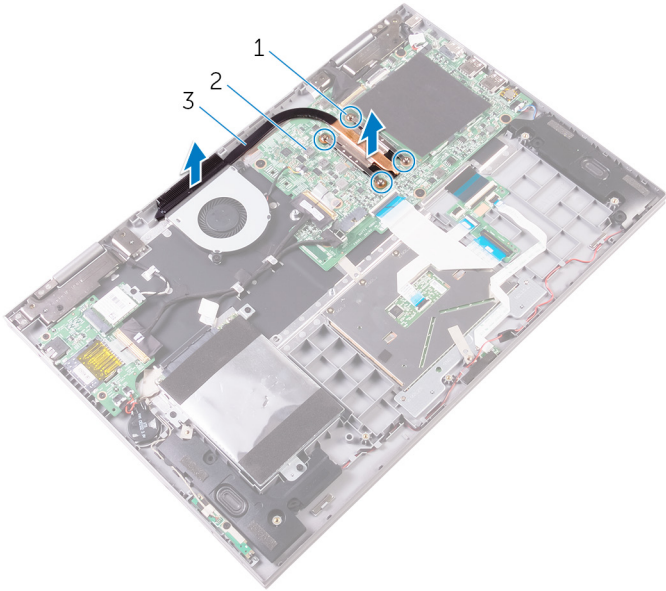



Figure 20. Removing the heat sink

- | | | | |
|---|--------------------|---|--------------|
| 1 | captive screws (4) | 2 | system board |
| 3 | heat sink | | |

Replacing the heat sink

 **WARNING:** Before working inside your computer, read the safety information that shipped with your computer and follow the steps in [Before working inside your computer](#). After working inside your computer, follow the instructions in [After working inside your computer](#). For more safety best practices, see the Regulatory Compliance home page at www.dell.com/regulatory_compliance.

 **CAUTION:** Incorrect alignment of the heat sink can damage the system board and processor.

 **NOTE:** The original thermal grease can be reused if the original system board and heat sink are reinstalled together. If either the system board or the heat sink is replaced, use the thermal pad provided in the kit to ensure that thermal conductivity is achieved.

Procedure

- 1 Align the screw holes on the heat sink with the screw holes on the system board.
- 2 In sequential order (indicated on the heat sink), tighten the captive screws that secure the heat sink to the system board.

Post-requisites

- 1 Replace the [battery](#).
- 2 Replace the [base cover](#).

Removing the power-adapter port



WARNING: Before working inside your computer, read the safety information that shipped with your computer and follow the steps in [Before working inside your computer](#). After working inside your computer, follow the instructions in [After working inside your computer](#). For more safety best practices, see the Regulatory Compliance home page at www.dell.com/regulatory_compliance.

Prerequisites

- 1 Remove the [base cover](#).
- 2 Remove the [battery](#).

Procedure

- 1 Disconnect the power-adapter port cable from the system board.
- 2 Remove the screw (M2x3) that secures the power-adapter port to the palm rest and keyboard assembly.



- 3 Lift the power-adapter port along with its cable off the palm rest and keyboard assembly.

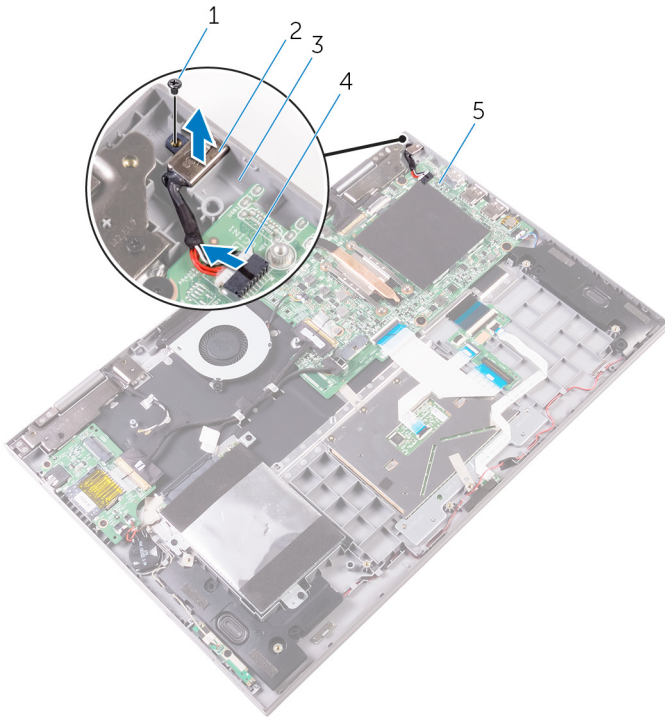

Figure 21. Removing the power-adapter port

- | | | | |
|---|---------------------------------|---|--------------------------|
| 1 | screw | 2 | power-adapter port |
| 3 | palm rest and keyboard assembly | 4 | power-adapter port cable |
| 5 | system board | | |

Replacing the power-adapter port



WARNING: Before working inside your computer, read the safety information that shipped with your computer and follow the steps in [Before working inside your computer](#). After working inside your computer, follow the instructions in [After working inside your computer](#). For more safety best practices, see the Regulatory Compliance home page at www.dell.com/regulatory_compliance.

Procedure

- 1 Place the power-adapter port into the slot on the palm rest and keyboard assembly.
- 2 Align the screw hole on the power-adapter port with the screw hole on the palm rest and keyboard assembly.
- 3 Replace the screw (M2x3) that secures the power-adapter port to the palm rest and keyboard assembly.
- 4 Connect the power-adapter port cable to the system board.

Post-requisites

- 1 Replace the [battery](#).
- 2 Replace the [base cover](#).



Removing the power and volume-buttons board



WARNING: Before working inside your computer, read the safety information that shipped with your computer and follow the steps in [Before working inside your computer](#). After working inside your computer, follow the instructions in [After working inside your computer](#). For more safety best practices, see the Regulatory Compliance home page at www.dell.com/regulatory_compliance.

Prerequisites

- 1 Remove the [base cover](#).
- 2 Remove the [battery](#).

Procedure

- 1 Disconnect the coin-cell battery cable from the I/O board.
- 2 Disconnect the power and volume-buttons board cable from the I/O board.
- 3 Peel off the tape that secures the power and volume-buttons board cable to the palm rest and keyboard assembly.
- 4 Remove the power and volume-buttons board cable from the routing guides on the palm rest and keyboard assembly and the speaker.
- 5 Remove the screw (M2x3) that secures the power and volume-buttons board to the palm rest and keyboard assembly.

- 6 Lift the power and volume-buttons board along with its cable off the palm rest and keyboard assembly.

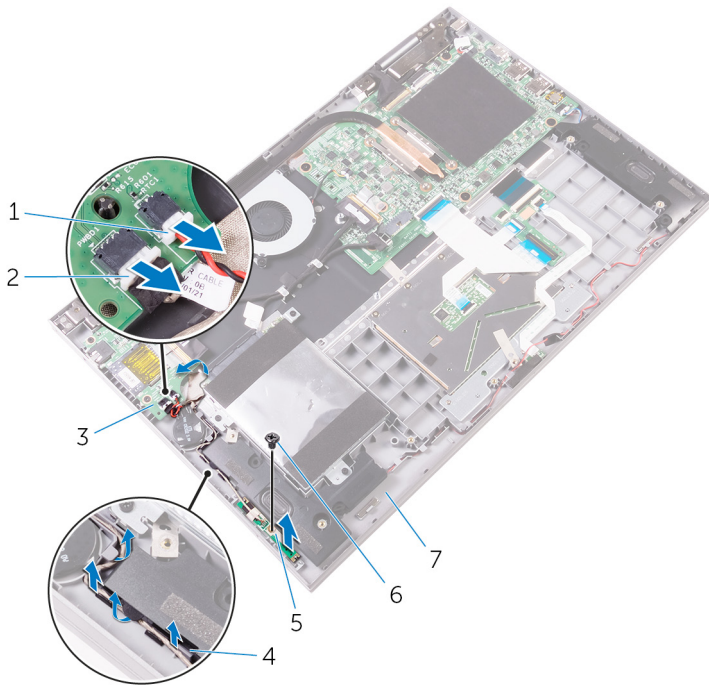

Figure 22. Removing the power and volume-buttons board

- | | | | |
|---|---------------------------------|---|--------------------------------------|
| 1 | coin-cell battery cable | 2 | power and volume-buttons board cable |
| 3 | I/O board | 4 | routing guides |
| 5 | power and volume-buttons board | 6 | screw |
| 7 | palm rest and keyboard assembly | | |

Replacing the power and volume-buttons board



WARNING: Before working inside your computer, read the safety information that shipped with your computer and follow the steps in [Before working inside your computer](#). After working inside your computer, follow the instructions in [After working inside your computer](#). For more safety best practices, see the Regulatory Compliance home page at www.dell.com/regulatory_compliance.

Procedure

- 1 Using the alignment posts, place the power and volume-buttons board on the palm rest and keyboard assembly.
- 2 Replace the screw (M2x3) that secures the power and volume-buttons board to the palm rest and keyboard assembly.
- 3 Route the power and volume-buttons board cable through the routing guides on the palm rest and keyboard assembly and the speaker.
- 4 Connect the power and volume-buttons board cable to the I/O board.
- 5 Adhere the tape that secures the power and volume-buttons board to the palm rest and keyboard assembly.
- 6 Connect the coin-cell battery cable to the I/O board.

Post-requisites

- 1 Replace the [battery](#).
- 2 Replace the [base cover](#).

Removing the I/O board



WARNING: Before working inside your computer, read the safety information that shipped with your computer and follow the steps in [Before working inside your computer](#). After working inside your computer, follow the instructions in [After working inside your computer](#). For more safety best practices, see the Regulatory Compliance home page at www.dell.com/regulatory_compliance.

Prerequisites

- 1 Remove the [base cover](#).
- 2 Remove the [battery](#).
- 3 Remove the [wireless card](#).

Procedure

- 1 Peel off the tape that secures the I/O-board cable to the I/O board.
- 2 Open the latch and disconnect the I/O-board cable from the I/O board.



- 3** Disconnect the coin-cell battery cable and the power and volume-buttons board cable from the I/O board.

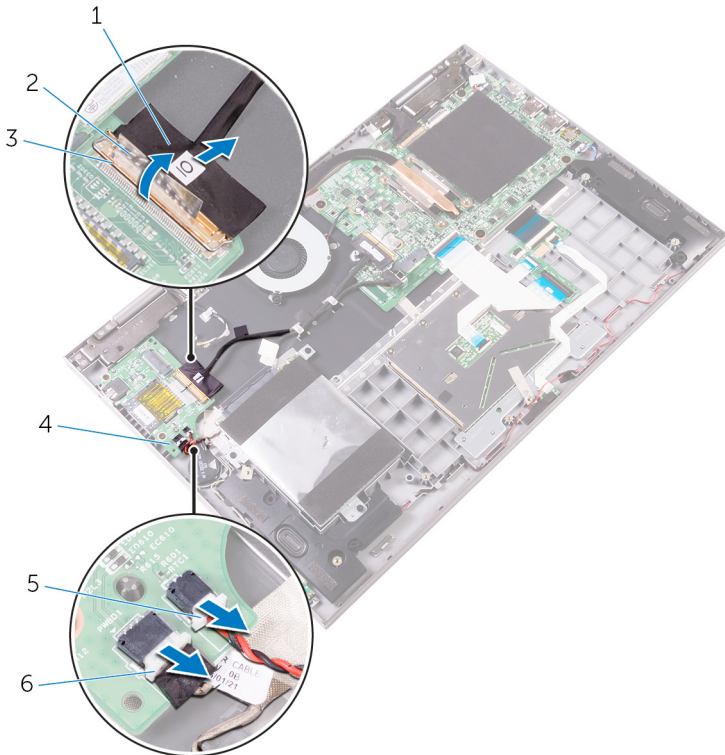

Figure 23. Removing the I/O board

- | | | | |
|---|-------------------------|---|--------------------------------------|
| 1 | I/O-board cable | 2 | tape |
| 3 | latch | 4 | I/O board |
| 5 | coin-cell battery cable | 6 | power and volume-buttons board cable |

- 4** Remove the two screws (M2x3) that secure the I/O board to the palm rest and keyboard assembly.

- 5 Lift the I/O board off the palm rest and keyboard assembly.

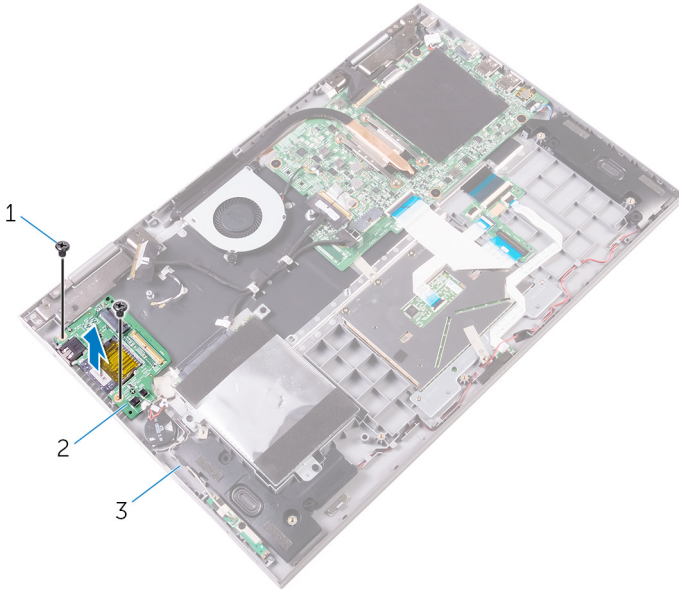

Figure 24. Removing the I/O board

- | | | | |
|---|---------------------------------|---|-----------|
| 1 | screws (2) | 2 | I/O board |
| 3 | palm rest and keyboard assembly | | |

Replacing the I/O board



WARNING: Before working inside your computer, read the safety information that shipped with your computer and follow the steps in [Before working inside your computer](#). After working inside your computer, follow the instructions in [After working inside your computer](#). For more safety best practices, see the Regulatory Compliance home page at www.dell.com/regulatory_compliance.

Procedure

- 1 Using the alignment posts, place the I/O board on the palm rest and keyboard assembly.
- 2 Align the screw holes on the I/O board with the screw holes on the palm rest and keyboard assembly.
- 3 Replace the two screws (M2x3) that secure the I/O board to the palm rest and keyboard assembly.
- 4 Connect the power and volume-buttons board cable and the coin-cell battery cable to the I/O board.
- 5 Slide the I/O-board cable into the connector on the I/O board and close the latch to secure the cable.
- 6 Adhere the tape that secures the I/O-board cable to the I/O board.

Post-requisites

- 1 Replace the [wireless card](#).
- 2 Replace the [battery](#).
- 3 Replace the [base cover](#).

Removing the system board

 **WARNING:** Before working inside your computer, read the safety information that shipped with your computer and follow the steps in [Before working inside your computer](#). After working inside your computer, follow the instructions in [After working inside your computer](#). For more safety best practices, see the Regulatory Compliance home page at www.dell.com/regulatory_compliance.

 **NOTE:** Your computer's Service Tag is stored in the system board. You must enter the Service Tag in the BIOS setup program after you replace the system board.

 **NOTE:** Replacing the system board removes any changes you have made to the BIOS using the BIOS setup program. You must make the appropriate changes again after you replace the system board.

 **NOTE:** Before disconnecting the cables from the system board, note the location of the connectors so that you can reconnect the cables correctly after you replace the system board.

Prerequisites

- 1 Remove the [base cover](#).
- 2 Remove the [battery](#).
- 3 Remove the [memory modules](#).
- 4 Remove the [heat sink](#).

Procedure

- 1 Disconnect the fan cable from the system board.
- 2 Peel off the pieces of tape that secure the display cable and touch-screen board cable from their respective connectors.
- 3 Open the latches and disconnect the display cable and the touch-screen board cable from the system board.



- 4 Open the latch and disconnect the I/O-board cable from the system board.

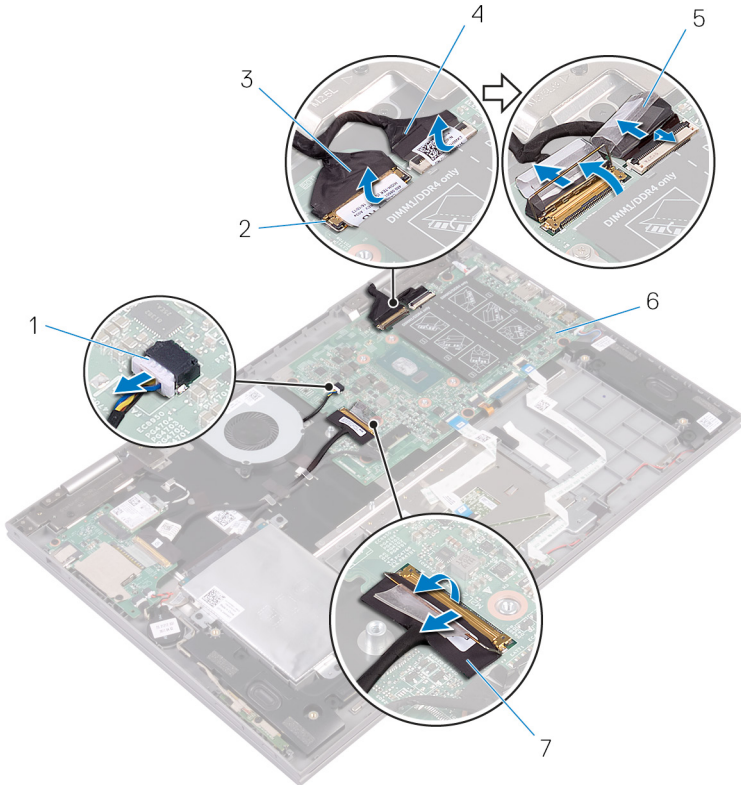

Figure 25. Removing the system board cables

- | | | | |
|---|-----------------|---|--------------------------|
| 1 | fan cable | 2 | latches (2) |
| 3 | display cable | 4 | touch-screen board cable |
| 5 | tape (2) | 6 | system board |
| 7 | I/O-board cable | | |

- 5 Using the pull tab, disconnect the hard-drive cable from the system board.
- 6 Disconnect the power-adaptor port cable and speaker cable from the system board.

- 7 Open the latches and disconnect the status-light board cable, keyboard cable, keyboard-backlight cable, and touchpad cable from the system board.

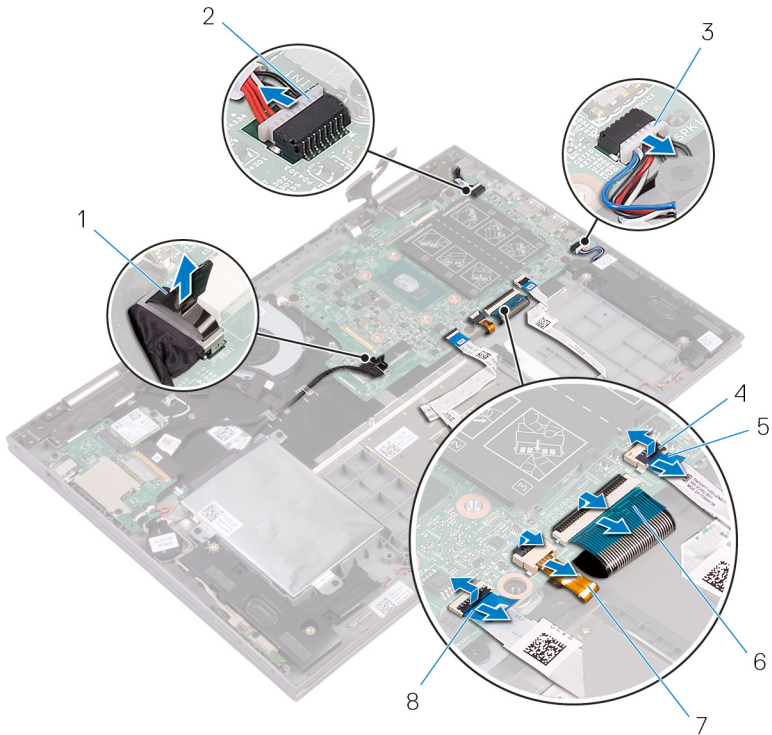

Figure 26. Removing the system board cables

- | | | | |
|---|--------------------------|---|--------------------------|
| 1 | hard-drive cable | 2 | power-adaptor port cable |
| 3 | speaker cable | 4 | latches (4) |
| 5 | status-light board cable | 6 | keyboard cable |
| 7 | keyboard-backlight cable | 8 | touchpad cable |
- 8 Remove the five screws (M2x2 Big Head) that secure the system board to the palm rest and keyboard assembly.



9 Lift the system board off the palm rest and keyboard assembly.

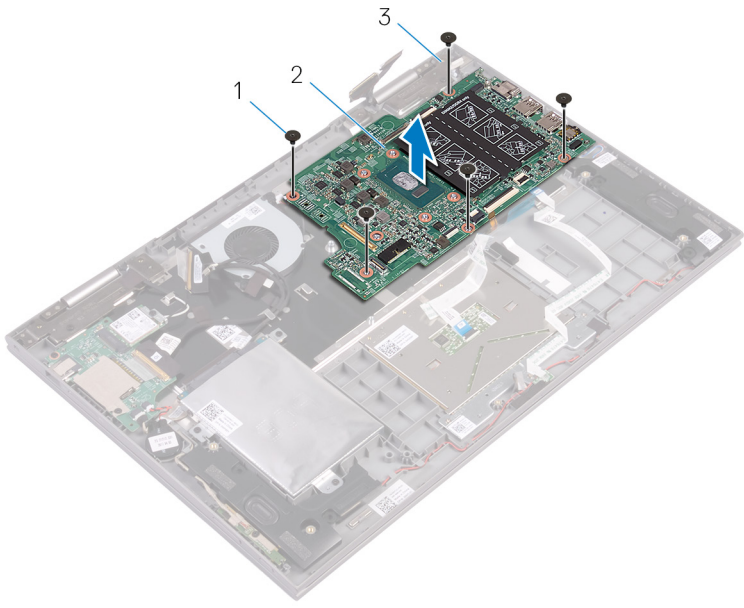

Figure 27. Removing the system board

- 1 screws (5)
- 2 system board
- 3 palm rest and keyboard assembly



Replacing the system board



WARNING: Before working inside your computer, read the safety information that shipped with your computer and follow the steps in [Before working inside your computer](#). After working inside your computer, follow the instructions in [After working inside your computer](#). For more safety best practices, see the Regulatory Compliance home page at www.dell.com/regulatory_compliance.



NOTE: Your computer's Service Tag is stored in the system board. You must enter the Service Tag in the BIOS setup program after you replace the system board.



NOTE: Replacing the system board removes any changes you have made to the BIOS using the BIOS setup program. You must make the appropriate changes again after you replace the system board.

Procedure

- 1 Align the screw holes on the system board with the screw holes on the palm rest and keyboard assembly.
- 2 Replace the five screws (M2x2 Big Head) that secure the system board to the palm rest and keyboard assembly.
- 3 Connect the fan cable, hard-drive cable, power-adaptor port cable and speaker cable to the system board.
- 4 Slide the touchpad cable, status-light board cable, keyboard cable, keyboard-backlight cable, and I/O-board cable into their respective connectors on the system board and close the latches to secure the cables.
- 5 Slide the display cable and the touch-screen board cable into their respective connectors on the system board and close the latches to secure the cables.
- 6 Adhere the pieces of tape that secure the display cable and the touch-screen board cable to their respective connectors on the system board.

Post-requisites

- 1 Replace the [heat sink](#).
- 2 Replace the [memory modules](#).



- 3 Replace the [battery](#).
- 4 Replace the [base cover](#).

Entering the Service Tag in the BIOS setup program

- 1 Turn on or restart your computer.
- 2 Press F2 when the Dell logo is displayed to enter the BIOS setup program.
- 3 Navigate to the **Main** tab and enter the Service Tag in the **Service Tag Input** field.



Removing the display assembly



WARNING: Before working inside your computer, read the safety information that shipped with your computer and follow the steps in [Before working inside your computer](#). After working inside your computer, follow the instructions in [After working inside your computer](#). For more safety best practices, see the Regulatory Compliance home page at www.dell.com/regulatory_compliance.

Prerequisites

- 1 Remove the [base cover](#).
- 2 Remove the [battery](#).
- 3 Remove the [wireless card](#).
- 4 Remove the [memory modules](#).
- 5 Remove the [heat sink](#).
- 6 Remove the [system board](#).



Procedure

- 1 Turn the computer over and open the display to 180-degree angle.

⚠ CAUTION: Place the computer on a soft and clean surface to avoid scratching the display.



Figure 28. Removing the display assembly

- | | | | |
|---|---------------------------------|---|------------------|
| 1 | palm rest and keyboard assembly | 2 | display assembly |
|---|---------------------------------|---|------------------|
- 2 Place the computer on a flat surface with the display facing down.
 - 3 Remove the two screws (M2.5x7) that secure the display assembly to the palm rest and keyboard assembly.
 - 4 Remove the antenna cables from the routing guide on the palm rest and keyboard assembly.

- 5 Lift the display assembly off the palm rest and keyboard assembly.

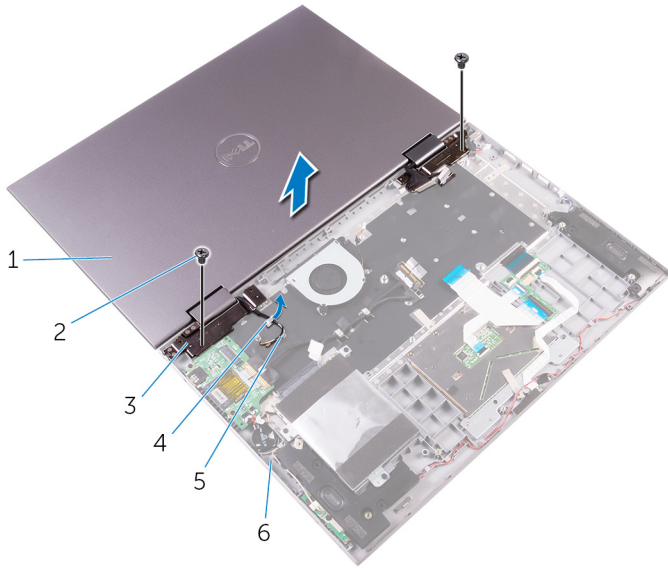



Figure 29. Removing the display assembly

- | | | | |
|---|--------------------|---|---------------------------------|
| 1 | display assembly | 2 | screws (2) |
| 3 | display hinges (2) | 4 | routing guide |
| 5 | antenna cables (2) | 6 | palm rest and keyboard assembly |

Replacing the display assembly

 **WARNING:** Before working inside your computer, read the safety information that shipped with your computer and follow the steps in [Before working inside your computer](#). After working inside your computer, follow the instructions in [After working inside your computer](#). For more safety best practices, see the Regulatory Compliance home page at www.dell.com/regulatory_compliance.

Procedure

 **CAUTION:** Place the computer on a soft and clean surface to avoid scratching the display.

- 1 With the display facing down, align the screw holes on the display hinges with the screw holes on the palm rest and keyboard assembly.
- 2 Replace the two screws (M2.5x7) that secure the display assembly to the palm rest and keyboard assembly.
- 3 Turn the computer over and close the display.

Post-requisites

- 1 Replace the [system board](#).
- 2 Replace the [heat sink](#).
- 3 Replace the [memory modules](#).
- 4 Replace the [wireless card](#).
- 5 Replace the [battery](#).
- 6 Replace the [base cover](#).

Removing the palm rest and keyboard assembly



WARNING: Before working inside your computer, read the safety information that shipped with your computer and follow the steps in [Before working inside your computer](#). After working inside your computer, follow the instructions in [After working inside your computer](#). For more safety best practices, see the Regulatory Compliance home page at www.dell.com/regulatory_compliance.

Prerequisites

- 1 Remove the [base cover](#).
- 2 Remove the [battery](#).
- 3 Remove the [memory modules](#).
- 4 Remove the [wireless card](#).
- 5 Remove the [coin-cell battery](#).
- 6 Follow the procedure from step 1 to step 5 in "[Removing the hard drive](#)".
- 7 Remove the [fan](#).
- 8 Remove the [heat sink](#).
- 9 Remove the [I/O board](#).
- 10 Remove the [power and volume-buttons board](#).
- 11 Remove the [power-adaptor port](#).
- 12 Remove the [status-light board](#).
- 13 Remove the [speakers](#).
- 14 Remove the [touchpad](#).
- 15 Remove the [system board](#).
- 16 Remove the [display assembly](#).

Procedure

After performing the steps in prerequisites, we are left with the palm rest and keyboard assembly.



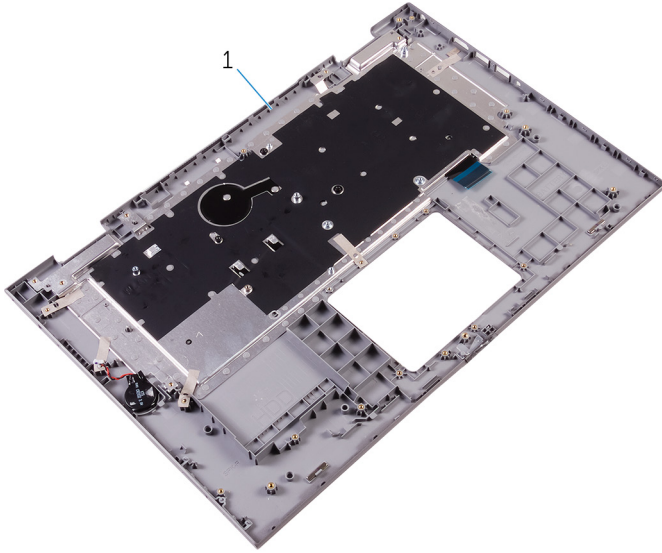

Figure 30. Removing the palm rest and keyboard assembly

- 1 palm rest and keyboard assembly

Replacing the palm rest and keyboard assembly



WARNING: Before working inside your computer, read the safety information that shipped with your computer and follow the steps in [Before working inside your computer](#). After working inside your computer, follow the instructions in [After working inside your computer](#). For more safety best practices, see the Regulatory Compliance home page at www.dell.com/regulatory_compliance.

Procedure

Place the palm rest and keyboard assembly on a clean and flat surface.

Post-requisites

- 1 Replace the [display assembly](#).
- 2 Replace the [system board](#).
- 3 Replace the [touchpad](#).
- 4 Replace the [status-light board](#).
- 5 Replace the [speakers](#).
- 6 Replace the [power-adapter port](#).
- 7 Replace the [power and volume-buttons board](#).
- 8 Replace the [I/O board](#).
- 9 Replace the [heat sink](#).
- 10 Replace the [fan](#).
- 11 Follow the procedure from step 4 to step 8 in "[Replacing the hard drive](#)".
- 12 Replace the [coin-cell battery](#).
- 13 Replace the [wireless card](#).
- 14 Replace the [memory modules](#).
- 15 Replace the [battery](#).
- 16 Replace the [base cover](#).



Removing the display panel



WARNING: Before working inside your computer, read the safety information that shipped with your computer and follow the steps in [Before working inside your computer](#). After working inside your computer, follow the instructions in [After working inside your computer](#). For more safety best practices, see the Regulatory Compliance home page at www.dell.com/regulatory_compliance.

Prerequisites

- 1 Remove the [base cover](#).
- 2 Remove the [battery](#).
- 3 Remove the [display assembly](#).

Procedure

- 1 Remove the display cable from inside the hinge covers.

- Using a plastic scribe, pry up the display-panel assembly to release the tabs that secure display-panel assembly to the display back-cover and antenna assembly.

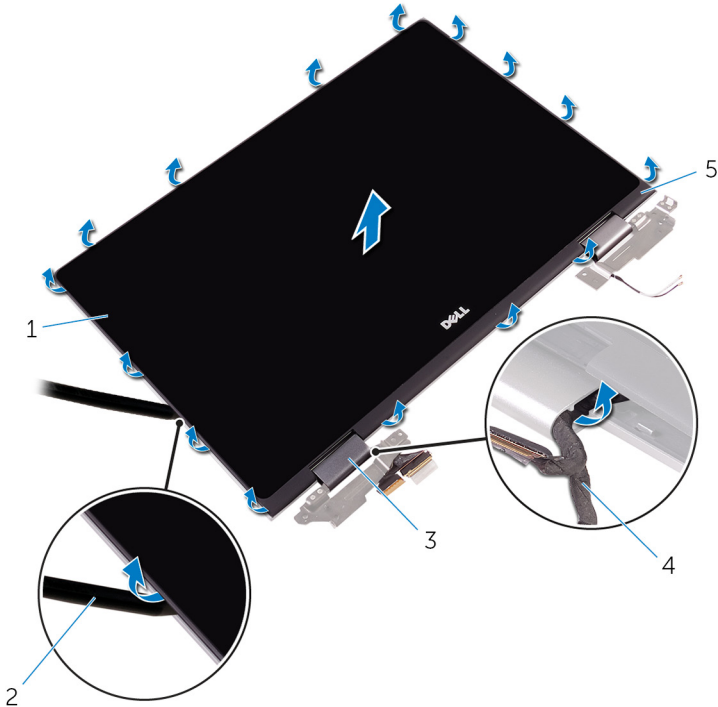

Figure 31. Removing the display back cover and antenna assembly

- | | | | |
|---|---|---|----------------|
| 1 | display-panel assembly | 2 | plastic scribe |
| 3 | hinge covers (2) | 4 | display cable |
| 5 | display back-cover and antenna assembly | | |
- Remove the [camera](#).
 - Remove the [sensor board](#).



- 5 Remove the [display cable](#).

After performing the preceding steps, we are left with the display panel.



Figure 32. Display panel

- 1 display panel

Replacing the display panel



WARNING: Before working inside your computer, read the safety information that shipped with your computer and follow the steps in [Before working inside your computer](#). After working inside your computer, follow the instructions in [After working inside your computer](#). For more safety best practices, see the Regulatory Compliance home page at www.dell.com/regulatory_compliance.

Procedure



CAUTION: Place the display panel on a soft and clean surface to avoid scratching the display.

- 1 Place the display panel on a flat surface with the display facing down.
- 2 Replace the [display cable](#).
- 3 Replace the [sensor board](#).
- 4 Replace the [camera](#).
- 5 Turn over the display-panel assembly.
- 6 Align the display-panel assembly with the display back-cover and antenna assembly and gently snap the display-panel assembly into place.

Post-requisites

- 1 Replace the [display assembly](#).
- 2 Replace the [battery](#).
- 3 Replace the [base cover](#).



Removing the display cable



WARNING: Before working inside your computer, read the safety information that shipped with your computer and follow the steps in [Before working inside your computer](#). After working inside your computer, follow the instructions in [After working inside your computer](#). For more safety best practices, see the Regulatory Compliance home page at www.dell.com/regulatory_compliance.

Prerequisites

- 1 Remove the [base cover](#).
- 2 Remove the [battery](#).
- 3 Remove the [display assembly](#).
- 4 Follow the procedure from step 1 to step 2 in “[Removing the display panel](#)”.
- 5 Remove the [camera](#).

Procedure

- 1 Peel off the tape on the sensor-board connector.

- 2 Open the latch and disconnect the sensor-board cable from the sensor board.

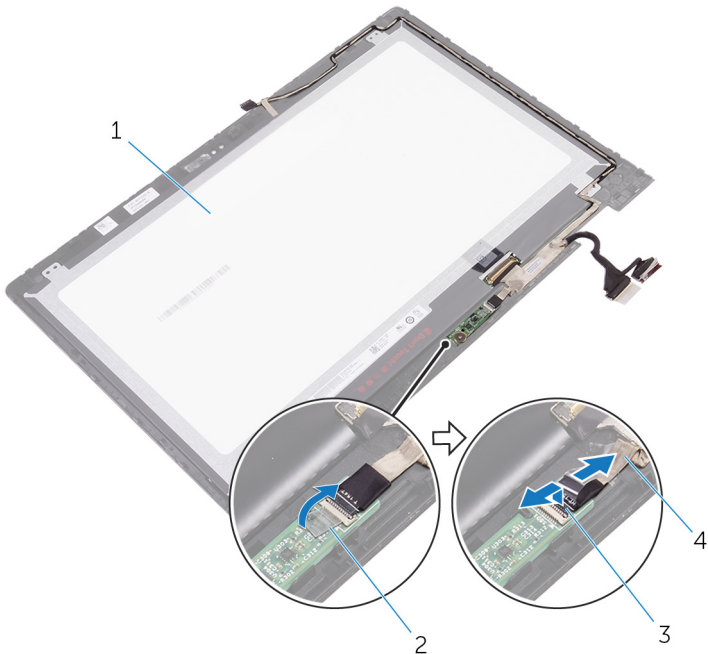

Figure 33. Removing the sensor-board cable

- | | | | |
|---|---------------|---|--------------------|
| 1 | display panel | 2 | tape |
| 3 | latch | 4 | sensor-board cable |

- 3 Peel off the tape on the display-cable connector.
- 4 Open the latch and disconnect the display cable from the display panel.
- 5 Note the display cable routing and remove the display cable from the routing guides on the display-panel assembly.
- 6 Peel off the tape that secures the display cable from the display-panel assembly.

7 Lift the display cable off the display-panel assembly.

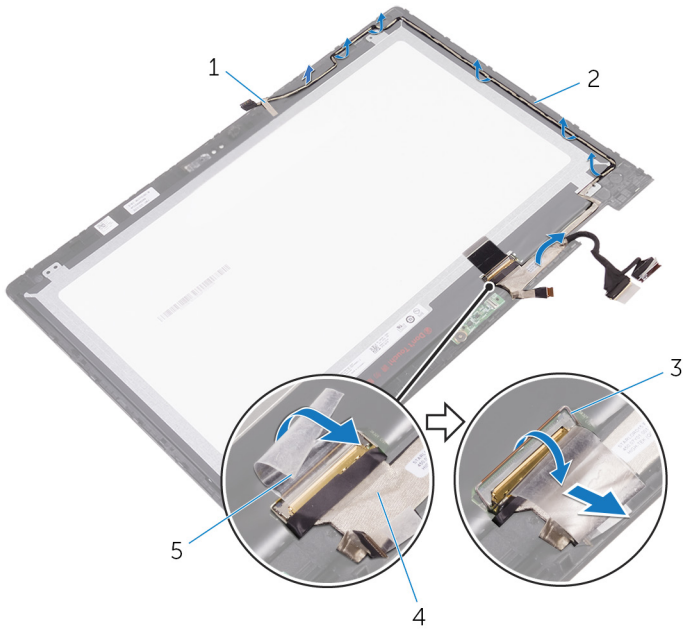

Figure 34. Removing the display cable

1 tape

2 display-panel assembly

3 latch

4 display cable

5 tape

Replacing the display cable



WARNING: Before working inside your computer, read the safety information that shipped with your computer and follow the steps in [Before working inside your computer](#). After working inside your computer, follow the instructions in [After working inside your computer](#). For more safety best practices, see the Regulatory Compliance home page at www.dell.com/regulatory_compliance.

Procedure

- 1 Adhere the tape that secures the display cable to the display-panel assembly.
- 2 Route the display cable through the routing guides on the display-panel assembly.
- 3 Slide the display cable into the connector on the display panel and close the latch to secure the cable.
- 4 Adhere the tape on the display-cable connector.
- 5 Slide the sensor-board cable into the connector on the sensor board and close the latch to secure the cable.
- 6 Adhere the tape on the sensor-board connector.

Post-requisites

- 1 Replace the [camera](#).
- 2 Follow the procedure from step 5 to step 6 in "[Replacing the display panel](#)".
- 3 Replace the [display assembly](#).
- 4 Replace the [battery](#).
- 5 Replace the [base cover](#).



Removing the display back-cover and antenna assembly



WARNING: Before working inside your computer, read the safety information that shipped with your computer and follow the steps in [Before working inside your computer](#). After working inside your computer, follow the instructions in [After working inside your computer](#). For more safety best practices, see the Regulatory Compliance home page at www.dell.com/regulatory_compliance.

Prerequisites

- 1 Remove the [base cover](#).
- 2 Remove the [battery](#).
- 3 Remove the [display assembly](#).
- 4 Follow the procedure from step 1 to step 2 in "[Removing the display panel](#)".

Procedure

After performing the steps in prerequisites, we are left with the display back-cover and antenna assembly.

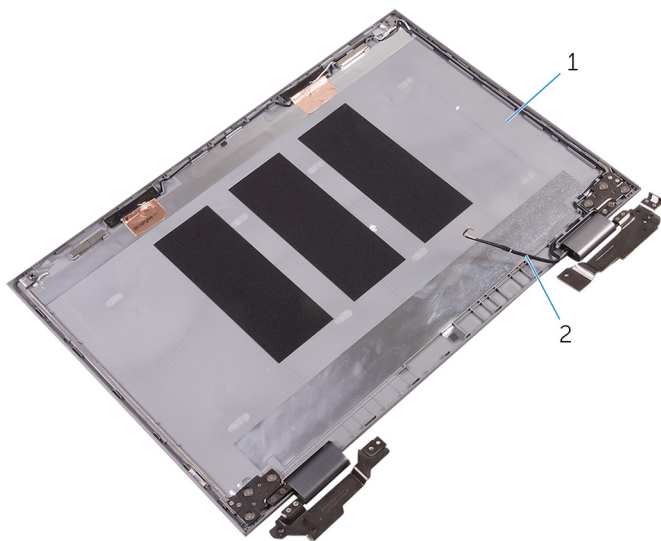

Figure 35. Display back-cover and antenna assembly

- | | | | |
|---|---|---|-------------------------|
| 1 | display back-cover and antenna assembly | 2 | antenna cables assembly |
|---|---|---|-------------------------|

Replacing the display back-cover and antenna assembly



WARNING: Before working inside your computer, read the safety information that shipped with your computer and follow the steps in [Before working inside your computer](#). After working inside your computer, follow the instructions in [After working inside your computer](#). For more safety best practices, see the Regulatory Compliance home page at www.dell.com/regulatory_compliance.

Procedure

Place the display back-cover and antenna assembly on a flat surface.

Post-requisites

- 1 Follow the procedure from step 5 to step 6 in "[Replacing the display panel](#)".
- 2 Replace the [display assembly](#).
- 3 Replace the [battery](#).
- 4 Replace the [base cover](#).

Removing the camera



WARNING: Before working inside your computer, read the safety information that shipped with your computer and follow the steps in [Before working inside your computer](#). After working inside your computer, follow the instructions in [After working inside your computer](#). For more safety best practices, see the Regulatory Compliance home page at www.dell.com/regulatory_compliance.

Prerequisites

- 1 Remove the [base cover](#).
- 2 Remove the [battery](#).
- 3 Remove the [display assembly](#).
- 4 Follow the procedure from step 1 to step 2 in "[Removing the display panel](#)".

Procedure



CAUTION: Place the display-panel assembly on a soft and clean surface to avoid scratching the display.

- 1 Place the display-panel assembly face down on a flat surface.
- 2 Using a plastic scribe, pry the camera module off the display-panel assembly.



- 3 Turn the camera over and disconnect the display cable from the camera module.

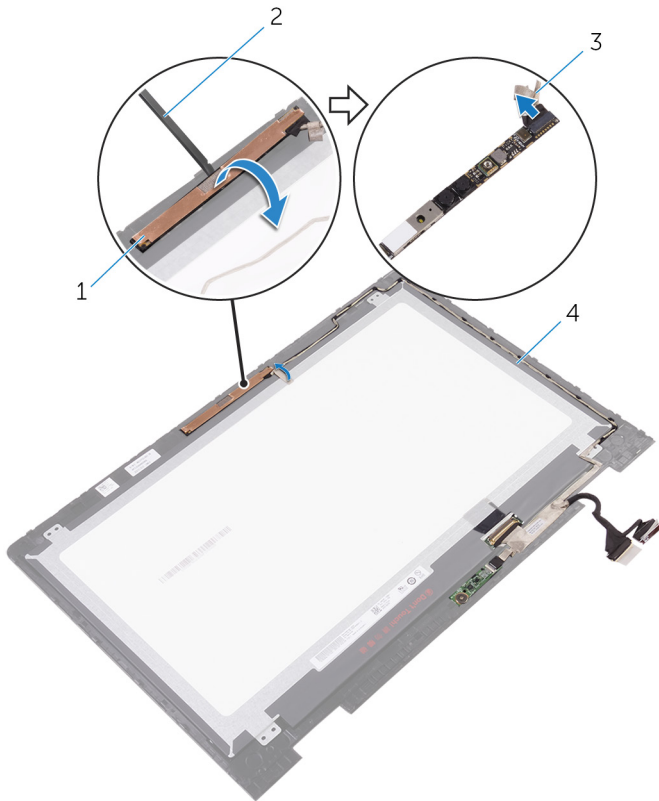

Figure 36. Removing the camera

- | | | | |
|---|---------------|---|------------------------|
| 1 | camera module | 2 | plastic scribe |
| 3 | display cable | 4 | display-panel assembly |

Replacing the camera



WARNING: Before working inside your computer, read the safety information that shipped with your computer and follow the steps in [Before working inside your computer](#). After working inside your computer, follow the instructions in [After working inside your computer](#). For more safety best practices, see the Regulatory Compliance home page at www.dell.com/regulatory_compliance.

Procedure

- 1 Connect the display cable to the camera module.
- 2 Using the alignment posts, place the camera module on the display panel and snap it into place.

Post-requisites

- 1 Follow the procedure from step 5 to step 6 in "[Replacing the display panel](#)".
- 2 Replace the [display assembly](#).
- 3 Replace the [battery](#).
- 4 Replace the [base cover](#).



Removing the sensor board



WARNING: Before working inside your computer, read the safety information that shipped with your computer and follow the steps in [Before working inside your computer](#). After working inside your computer, follow the instructions in [After working inside your computer](#). For more safety best practices, see the Regulatory Compliance home page at www.dell.com/regulatory_compliance.

Prerequisites

- 1 Remove the [base cover](#).
- 2 Remove the [battery](#).
- 3 Remove the [display assembly](#).
- 4 Follow the procedure from step 1 to step 2 in "[Removing the display panel](#)".

Procedure



CAUTION: Place the display-panel assembly on a soft and clean surface to avoid scratching the display.

- 1 Place the display-panel assembly face down on a flat surface.
- 2 Remove the screw that secures the sensor board to the display panel.
- 3 Peel off the tape that secures the sensor-board cable to the sensor board.
- 4 Open the latch to disconnect the sensor-board cable from the sensor board.

5 Lift the sensor board off the display-panel assembly.

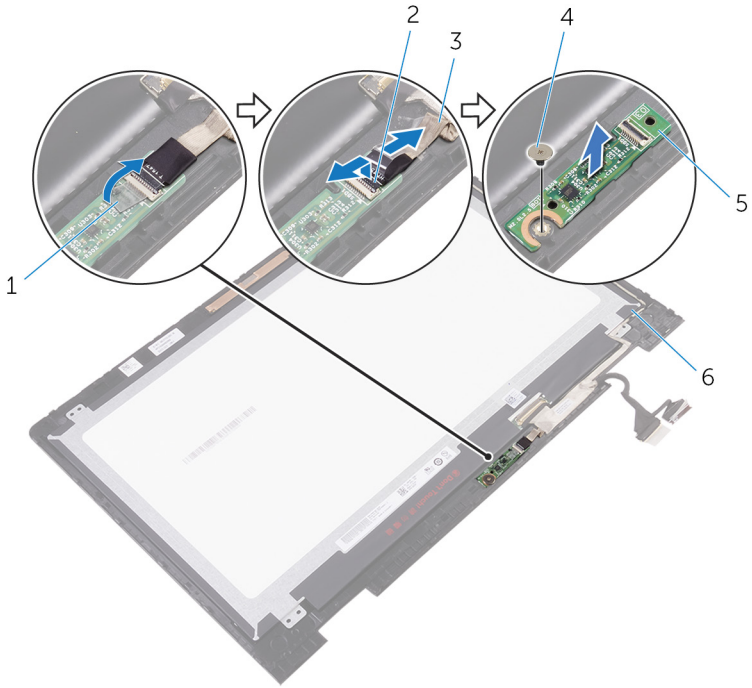

Figure 37. Removing the sensor board

- | | | | |
|---|--------------------|---|------------------------|
| 1 | tape | 2 | latch |
| 3 | sensor-board cable | 4 | screw |
| 5 | sensor board | 6 | display-panel assembly |



Replacing the sensor board



WARNING: Before working inside your computer, read the safety information that shipped with your computer and follow the steps in [Before working inside your computer](#). After working inside your computer, follow the instructions in [After working inside your computer](#). For more safety best practices, see the Regulatory Compliance home page at www.dell.com/regulatory_compliance.

Procedure

- 1 Align the screw hole on the sensor board with the screw hole on the display-panel assembly and snap the sensor board in place.
- 2 Slide the sensor-board cable into the connector on the sensor board and close the latch to secure the cable.
- 3 Adhere the tape on the sensor-board connector to secure the cable.
- 4 Replace the screw that secures the sensor board to the display-panel assembly.

Post-requisites

- 1 Follow the procedure from step 5 to step 6 in "[Replacing the display panel](#)".
- 2 Replace the [display assembly](#).
- 3 Replace the [battery](#).
- 4 Replace the [base cover](#).

Downloading drivers

Downloading the audio driver

- 1 Turn on your computer.
- 2 Go to www.dell.com/support.
- 3 Click or tap **Product support**, enter the Service Tag of your computer, and then click or tap **Submit**.



NOTE: If you do not have the Service Tag, use the auto-detect feature or manually browse for your computer model.

- 4 Click or tap **Drivers & downloads** → **Find it myself**.
- 5 Scroll down the page and expand **Audio**.
- 6 Click or tap **Download** to download the audio driver for your computer.
- 7 After the download is complete, navigate to the folder where you saved the audio driver file.
- 8 Double-click or double-tap the audio driver file icon and follow the instructions on the screen.

Downloading the graphics driver

- 1 Turn on your computer.
- 2 Go to www.dell.com/support.
- 3 Click or tap **Product support**, enter the Service Tag of your computer, and then click or tap **Submit**.



NOTE: If you do not have the Service Tag, use the auto-detect feature or manually browse for your computer model.

- 4 Click or tap **Drivers & downloads** → **Find it myself**.
- 5 Scroll down the page and expand **Video**.
- 6 Click or tap **Download** to download the graphics driver for your computer.
- 7 After the download is complete, navigate to the folder where you saved the graphics driver file.
- 8 Double-click or double-tap the graphics driver file icon and follow the instructions on the screen.



Intel USB 3.0 xHCI

Install the Intel USB 3.0 xHCI driver update from www.dell.com/support.

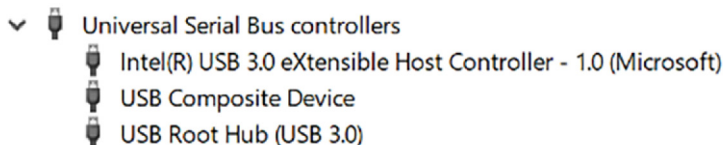

Figure 38. USB controllers

 **NOTE: USB 3.0 driver supports USB 3.1 Gen 1 features.**

Downloading the Wi-Fi driver

- 1 Turn on the computer.
- 2 Go to www.dell.com/support.
- 3 Click or tap **Product support**, enter the Service Tag of your computer, and then click or tap **Submit**.

 **NOTE: If you do not have the Service Tag, use the auto-detect feature or manually browse for your computer model.**

- 4 Click or tap **Drivers & downloads** → **Find it myself**.
- 5 Scroll down the page and expand **Network**.
- 6 Click or tap **Download** to download the Wi-Fi driver for your computer.
- 7 After the download is complete, navigate to the folder where you saved the Wi-Fi driver file.
- 8 Double-click or double-tap the driver file icon and follow the instructions on the screen.

Downloading the media-card reader driver

- 1 Turn on your computer.
- 2 Go to www.dell.com/support.

- 3 Click or tap **Product support**, enter the Service Tag of your computer, and then click or tap **Submit**.



NOTE: If you do not have the Service Tag, use the auto-detect feature or manually browse for your computer model.

- 4 Click or tap **Drivers & downloads** → **Find it myself**.
- 5 Scroll down the page and expand **Chipset**.
- 6 Click or tap **Download** to download the media-card reader driver for your computer.
- 7 After the download is complete, navigate to the folder where you saved the card reader driver file.
- 8 Double-click or double-tap the card reader driver file icon and follow the instructions on the screen.

Downloading the chipset driver

- 1 Turn on your computer.
- 2 Go to www.dell.com/support.
- 3 Click or tap **Product support**, enter the Service Tag of your computer, and then click or tap **Submit**.



NOTE: If you do not have the Service Tag, use the auto-detect feature or manually browse for your computer model.

- 4 Click or tap **Drivers & downloads** → **Find it myself**.
- 5 Scroll down the page and expand **Chipset**.
- 6 Click or tap **Download** to download the chipset driver for your computer.
- 7 After the download is complete, navigate to the folder where you saved the chipset driver file.
- 8 Double-click or double-tap the chipset driver file icon and follow the instructions on the screen.

Downloading the network driver

- 1 Turn on your computer.
- 2 Go to www.dell.com/support.
- 3 Click **Product support** enter the Service Tag of your computer and click **Submit**.



NOTE: If you do not have the Service Tag, use the auto-detect feature or manually browse for your computer model.



- 4 Click **Drivers & downloads** → **Find it myself**.
- 5 Scroll down the page and expand **Network**.
- 6 Click **Download** to download the network driver for your computer.
- 7 Save the file, and after the download is complete, navigate to the folder where you saved the network driver file.
- 8 Double-click the network driver file icon and follow the instructions on screen.



System setup

 **NOTE: Depending on the computer and its installed devices, the items listed in this section may or may not be displayed.**

Boot Sequence

Boot Sequence allows you to bypass the System Setup–defined boot device order and boot directly to a specific device (for example: optical drive or hard drive). During the Power-on Self Test (POST), when the Dell logo appears, you can:

- Access System Setup by pressing F2 key
- Bring up the one-time boot menu by pressing F12 key

The one-time boot menu displays the devices that you can boot from including the diagnostic option. The boot menu options are:

- Removable Drive (if available)
- STXXXX Drive

 **NOTE: XXX denotes the SATA drive number.**

- Optical Drive (if available)
- Diagnostics

 **NOTE: Choosing Diagnostics, will display the ePSA diagnostics screen.**

The boot sequence screen also displays the option to access the System Setup screen.

Navigation keys

 **NOTE: For most of the System Setup options, changes that you make are recorded but do not take effect until you restart the system.**

Keys

Navigation

Up arrow

Moves to the previous field.



Keys

Navigation

Down arrow

Moves to the next field.

Enter

Selects a value in the selected field (if applicable) or follow the link in the field.

Spacebar

Expands or collapses a drop-down list, if applicable.

Tab

Moves to the next focus area.



NOTE: For the standard graphics browser only.

Esc

Moves to the previous page until you view the main screen. Pressing Esc in the main screen displays a message that prompts you to save any unsaved changes and restarts the system.

BIOS overview



CAUTION: Unless you are an expert computer user, do not change the settings in the BIOS Setup program. Certain changes can make your computer work incorrectly.



NOTE: Before you change BIOS Setup program, it is recommended that you write down the BIOS Setup program screen information for future reference.

Use the BIOS Setup program for the following purposes:

- Get information about the hardware installed in your computer, such as the amount of RAM and the size of the hard drive.
- Change the system configuration information.
- Set or change a user-selectable option, such as the user password, type of hard drive installed, and enabling or disabling base devices.

Entering BIOS setup program

- 1 Turn on (or restart) your computer.

- 2 During POST, when the DELL logo is displayed, watch for the F2 prompt to appear, and then press F2 immediately.



NOTE: The F2 prompt indicates that the keyboard is initialized. This prompt can appear very quickly, so you must watch for it, and then press F2. If you press F2 before the F2 prompt, this keystroke is lost. If you wait too long and the operating system logo appears, continue to wait until you see the desktop. Then, turn off your computer and try again.

System setup options



NOTE: Depending on this computer and its installed devices, the items listed in this section may or may not appear.

Table 3. System setup options—System information menu

General-System Information

System Information

BIOS Version	Displays the BIOS version number.
Service Tag	Displays the Service Tag of the computer.
Asset Tag	Displays the Asset Tag of the computer.
Ownership Tag	Displays the ownership tag of the computer.
Manufacture Date	Displays the manufacture date of the computer.
Ownership Date	Displays the ownership date of the computer.
Express Service Code	Displays the express service code of the computer.

Memory Information

Memory Installed	Displays the total computer memory installed.
Memory Available	Displays the total computer memory available.
Memory Speed	Displays the memory speed.
Memory Channel Mode	Displays single or dual channel mode.
Memory Technology	Displays the technology used for the memory.
DIMM A Size	Displays the DIMM A memory size.
DIMM B Size	Displays the DIMM B memory size.



General-System Information

Processor Information

Processor Type	Displays the processor type.
Core Count	Displays the number of cores on the processor.
Processor ID	Displays the processor identification code.
Current Clock Speed	Displays the current processor clock speed.
Minimum Clock Speed	Displays the minimum processor clock speed.
Maximum Clock Speed	Displays the maximum processor clock speed.
Processor L2 Cache	Displays the processor L2 Cache size.
Processor L3 Cache	Displays the processor L3 Cache size.
HT Capable	Displays whether the processor is HyperThreading (HT) capable.
64-Bit Technology	Displays whether 64-bit technology is used.

Device Information

SATA-0	Displays the SATA-0 device information of the computer.
SATA-2	Displays the SATA-2 device information of the computer.
M.2 PCIe SSD-0	Displays the M.2 PCIe SSD information of the computer.
Video Controller	Displays the video controller type of the computer.
dGPU Video Controller	Displays the discrete graphics information of the computer.
Video BIOS Version	Displays the video BIOS version of the computer.
Video Memory	Displays the video memory information of the computer.
Panel Type	Displays the Panel Type of the computer.
Native Resolution	Displays the native resolution of the computer.
Audio Controller	Displays the audio controller information of the computer.

General-System Information

Wi-Fi Device	Displays the wireless device information of the computer.
Bluetooth Device	Displays the bluetooth device information of the computer.

Battery Information Displays the battery health information.

Boot Sequence

Boot Sequence	Displays the boot sequence.
Boot List Option	Displays the available boot options.

Advanced Boot Options

Enable Legacy Option ROMs	Enable or disable the Legacy Option ROMs.
Enable UEFI Network Stack	Enable or disable UEFI Network Stack.

UEFI Boot Path Security Enable or disable the system to prompt the user to enter the Admin password when booting a UEFI boot path from the F12 boot menu.

Date/Time Displays the current date in MM/DD/YY format and current time in HH:MM:SS AM/PM format.

Table 4. System setup options—System Configuration menu

System Configuration

SATA Operation	Configure operating mode of the integrated SATA hard drive controller.
Drives	Enable or disable various drives on board.
SMART Reporting	Enable or disable SMART Reporting during system startup.
USB Configuration	
Enable Boot Support	Enable or disable booting from USB mass storage devices such as external hard drive, optical drive, and USB drive.



System Configuration

Enable External USB Port	Enable or disable booting from USB mass storage devices connected to external USB port.
USB PowerShare	Enable or disable charging external devices through the USB PowerShare port.
Audio	Enable or disable the integrated audio controller.
Keyboard Illumination	Configure the operating mode of the keyboard illumination feature.
Keyboard Backlight with AC	Enable or disable the keyboard backlight.
Miscellaneous Devices	Enable or disable various onboard devices.
Enable Camera	Enable or disable the camera.
Enable Secure Digital (SD) Card	Enable or disable the SD card.

Table 5. System setup options—Video menu

Video

LCD Brightness	Set the panel brightness independently for Battery and AC power.
----------------	--

Table 6. System setup options—Security menu

Security

Strong Password	Enable or disable strong passwords.
Password Configuration	Control the minimum and maximum number of characters allowed for Admin and System passwords.
Password Bypass	Bypass the System (Boot) Password and the internal HDD password prompts during a system restart.
Password Change	Enable or disable changes to the System and Hard Disk passwords when an administrator password is set.

Security

Non-Admin Setup Changes	Determines whether changes to the setup option are permitted when an administrator password is set.
UEFI Capsule Firmware Updates	Enable or disable BIOS updates through UEFI capsule update packages.
PTT Security	Enable or disable Platform Trust Technology (PTT) visibility to the operating system.
Computrace(R)	Enable or disable the BIOS module interface of the optional Computrace(R) Service from Absolute Software.
CPU XD Support	Enable or disable the Execute Disable mode of the Processor.
Admin Setup Lockout	Enable to prevent users from entering Setup when an Admin Password is set.

Table 7. System setup options—Secure Boot menu

Secure Boot

Secure Boot Enable	Enable or disable the secure boot feature.
--------------------	--

Expert Key Management

Expert Key Management	Enable or disable Expert Key Management.
Custom Mode Key Management	Select the custom values for expert key management.

Table 8. System setup options—Intel Software Guard Extensions menu

Intel Software Guard Extensions

Intel SGX Enable	Enable or disable Intel Software Guard Extensions.
Enclave Memory Size	Set the Intel Software Guard Extensions Enclave Reserve Memory Size.

Performance

Multi Core Support	Enable multiple cores. Default: Enabled.
--------------------	---



Intel Software Guard Extensions

Intel SpeedStep Enable or disable Intel Speedstep Technology.
Default: Enabled.



NOTE: If enabled, the processor clock speed and core voltage are adjusted dynamically based on the processor load.

C-States Control Enable or disable additional processor sleep states.
Default: Enabled.

Intel TurboBoost Enable or disable Intel TurboBoost mode of the processor.
Default: Enabled.

HyperThread control Enable or disable HyperThreading in the processor.
Default: Enabled.

Power Management

AC Behavior Enables the system to turn on automatically, when AC is inserted.

Enable Intel Speed Shift Technology Enable or disable Intel Speed Shift Technology.

Auto on Time Enable to set the computer to turn on automatically every day or on a preselected date and time. This option can be configured only if the Auto On Time is set to Everyday, Weekdays or Selected Days.
Default: Disabled.

USB Wake Support Enable the USB devices to wake the computer from Standby.

Advanced Battery Charge Configuration Enable Advanced Battery Charge Configuration from the beginning of the day to a specified work period.

Primary Battery Charge Configuration Set the primary battery charge settings with a preselected custom charge start and stop.
Default: Adaptive.

POST Behavior

Adapter Warnings Enable adapter warnings.

Intel Software Guard Extensions

	Default: Enabled.
Numlock Enable	Enable or disable Numlock. Default: Enable Numlock.
Fn Lock Options	Enable or disable the Fn lock mode.
Fastboot	Enable to set the speed of the boot process. Default: Thorough.
Extend BIOS POST Time	Configure additional pre-boot delay.
Pull Screen Logo	Enable or disable to display full screen logo.
Warnings and Errors	Select an action on encountering a warning or error.

Table 9. System setup options—Virtualization Support menu

Virtualization Support

Virtualization	Specify whether a Virtual Machine Monitor (VMM) can utilize the additional hardware capabilities provided by Intel Virtualization Technology.
VT for Direct I/O	Specify whether a Virtual Machine Monitor (VMM) can utilize the additional hardware capabilities provided by Intel Virtualization Technology for Direct I/O.

Table 10. System setup options—Wireless menu

Wireless

Wireless Switch	Determine which wireless devices can be controlled by the Wireless Switch.
Wireless Device Enable	Enable or disable internal wireless devices.

Table 11. System setup options—Maintenance menu

Maintenance

Service Tag	Display the system's Service Tag.
Asset Tag	Create a system Asset Tag.



Maintenance

BIOS Downgrade	Control flashing of the system firmware to previous revisions.
Data Wipe	Enable to securely erase data from all internal storage devices.
BIOS Recovery	Enable the user to recover from certain corrupted BIOS conditions from a recovery file on the user primary hard drive or an external USB key.

Table 12. System setup options—System Logs menu

System Logs

BIOS Events	Display BIOS events.
Thermal Events	Display Thermal events.
Power Events	Display Power events.

Table 13. System setup options—SupportAssist System Resolution menu

SupportAssist System Resolution

Auto OS Recovery Threshold	Control the automatic boot flow for SupportAssist System Resolution Console and for Dell OS Recovery tool.
SupportAssist OS Recovery	Enable or disable the boot flow for SupportAssist OS Recovery tool in the even of certain system errors.

System and setup password

You can create a system password and a setup password to secure your computer.

Password type	Description
System password	Password that you must enter to log on to your system.
Setup password	Password that you must enter to access and make changes to the BIOS settings of your computer.

 **CAUTION: The password features provide a basic level of security for the data on your computer.**

 **CAUTION:** Anyone can access the data stored on your computer if it is not locked and left unattended.

 **NOTE:** Your computer is shipped with the system and setup password feature is disabled.

Assigning a system password and setup password

You can assign a new **System Password** only when the status is in **Not Set**. To enter the system setup, press F2 immediately after a power-on or re-boot.

- 1 In the **System BIOS** or **System Setup** screen, select **Security** and press Enter. The **Security** screen is displayed.
- 2 Select **System Password** and create a password in the **Enter the new password** field.
Use the following guidelines to assign the system password:
 - A password can have up to 32 characters.
 - The password can contain the numbers 0 through 9.
 - Only lower case letters are valid, upper case letters are not allowed.
 - Only the following special characters are allowed: space, ("), (+), (,), (-), (.), (/), (:), ([), (\), (]), (^).
- 3 Type the system password that you entered earlier in the **Confirm new password** field and click **OK**.
- 4 Press Esc and a message prompts you to save the changes.
- 5 Press Y to save the changes.
The computer reboots.

Deleting or changing an existing system and/or setup password

Ensure that the **Password Status** is Unlocked (in the System Setup) before attempting to delete or change the existing System and/or Setup password. You cannot delete or change an existing System or Setup password, if the **Password Status** is Locked.

To enter the System Setup, press F2 immediately after a power-on or reboot.

- 1 In the **System BIOS** or **System Setup** screen, select **System Security** and press Enter.
The **System Security** screen is displayed.



- 2 In the **System Security** screen, verify that **Password Status** is **Unlocked**.
- 3 Select **System Password**, alter or delete the existing system password and press Enter or Tab.
- 4 Select **Setup Password**, alter or delete the existing setup password and press Enter or Tab.
 -  **NOTE: If you change the System and/or Setup password, re-enter the new password when promoted. If you delete the System and/or Setup password, confirm the deletion when promoted.**
- 5 Press Esc and a message prompts you to save the changes.
- 6 Press Y to save the changes and exit from System Setup.
The computer reboots.

Clearing CMOS settings



CAUTION: Clearing CMOS settings will reset the BIOS settings on your computer.

- 1 Remove the [base cover](#).
- 2 Remove the [battery](#).
- 3 Disconnect the [coin-cell battery](#).
- 4 Wait for one minute.
- 5 Connect the [coin-cell battery](#).
- 6 Replace the [battery](#).
- 7 Replace the [base cover](#).

Clearing forgotten passwords

Contact Dell technical support to clear the forgotten passwords, see www.dell.com/contactdell.

Troubleshooting

Flashing the BIOS

You may need to flash (update) the BIOS when an update is available or when you replace the system board.

Follow these steps to flash the BIOS:

- 1 Turn on your computer.
- 2 Go to www.dell.com/support.
- 3 Click **Product support**, enter the Service Tag of your computer, and then click **Submit**.



NOTE: If you do not have the Service Tag, use the auto-detect feature or manually browse for your computer model.

- 4 Click **Drivers & downloads** → **Find it myself**.
- 5 Select the operating system installed on your computer.
- 6 Scroll down the page and expand **BIOS**.
- 7 Click **Download** to download the latest version of the BIOS for your computer.
- 8 After the download is complete, navigate to the folder where you saved the BIOS update file.
- 9 Double-click the BIOS update file icon and follow the instructions on the screen.

Flashing BIOS (USB key)

- 1 Follow the procedure from step 1 to step 7 in "[Flashing the BIOS](#)" to download the latest BIOS setup program file.
- 2 Create a bootable USB drive. For more information see the knowledge base article [SLN143196](#) at www.dell.com/support.
- 3 Copy the BIOS setup program file to the bootable USB drive.
- 4 Connect the bootable USB drive to the computer that needs the BIOS update.
- 5 Restart the computer and press **F12** when the Dell logo is displayed on the screen.
- 6 Boot to the USB drive from the **One Time Boot Menu**.
- 7 Type the BIOS setup program filename and press **Enter**.



- 8 The **BIOS Update Utility** appears. Follow the instructions on the screen to complete the BIOS update.

Enhanced Pre-Boot System Assessment (ePSA) diagnostics

The ePSA diagnostics (also known as system diagnostics) performs a complete check of your hardware. The ePSA is embedded with the BIOS and is launched by the BIOS internally. The embedded system diagnostics provides a set of options for particular devices or device groups allowing you to:

- Run tests automatically or in an interactive mode
- Repeat tests
- Display or save test results
- Run thorough tests to introduce additional test options to provide extra information about the failed device(s)
- View status messages that inform you if tests are completed successfully
- View error messages that inform you of problems encountered during testing



CAUTION: Use the system diagnostics to test only your computer. Using this program with other computers may cause invalid results or error messages.



NOTE: Some tests for specific devices require user interaction. Always ensure that you are present at the computer terminal when the diagnostic tests are performed.

For more information, see [Dell EPSA Diagnostic 3.0](#).

Running the ePSA diagnostics

- 1 Power-on the computer.
- 2 As the computer boots, press the F12 key as the Dell logo appears.
- 3 On the boot menu screen, select the **Diagnostics** option.
- 4 Click the arrow key at the bottom left corner.
Diagnostics front page is displayed.
- 5 Press the arrow in the lower-right corner to go to the page listing.
The items detected are listed.
- 6 To run a diagnostic test on a specific device, press Esc and click **Yes** to stop the diagnostic test.

- 7 Select the device from the left pane and click **Run Tests**.
- 8 If there are any issues, error codes are displayed.
Note the error code and validation number and contact Dell.

System diagnostic lights

Power and battery-status light/hard-drive activity light

Indicates the battery-charge status or the hard-drive activity.



NOTE: Press Fn+H to toggle this light between power and battery-status light and hard-drive activity light.

Hard-drive activity light

Turns on when the computer reads from or writes to the hard drive.



NOTE: Hard-drive activity light is supported only on computers shipped with hard drive.

Power and battery-status light

Indicates the power and battery-charge status

Solid white — Power adapter is connected and the battery has more than 5 percent charge.

Amber — Computer is running on battery and the battery has less than 5 percent charge.

Off

- Power adapter is connected and the battery is fully charged.
- Computer is running on battery and the battery has more than 5 percent charge.
- Computer is in sleep state, hibernation, or turned off



NOTE: Hard-drive activity light is supported only on computers shipped with hard drive.

The power and battery-status light blinks amber along with beep codes indicating failures.

For example, the power and battery-status light blinks amber two times followed by a pause, and then blinks white three times followed by a pause. This 2,3 pattern continues until the computer is turned off indicating no memory or RAM is detected.

The following table shows different light patterns and describes what they indicate.



Table 14. Diagnostics

Light pattern	Problem description
2,1	CPU failure
2,2	System board: BIOS and ROM failure
2,3	No memory or RAM detected
2,4	Memory or RAM failure
2,5	Invalid memory installed
2,6	System board or chipset error
2,7	LCD failure
3,1	CMOS battery failure
3,2	PCI or video card or chip failure
3,3	Recovery image not found
3,4	Recovery image found but invalid

Camera status light: Indicates whether the camera is in use.

- Solid white — Camera is in use.
- Off — Camera is not in use.

Caps Lock status light: Indicates whether Caps Lock is enabled or disabled.

- Solid white — Caps Lock enabled.
- Off — Caps Lock disabled.

Flea power release

Flea power is the residual static electricity that remains on the computer even after it has been powered off and the battery has been removed. The following procedure list the steps to conduct a flea power release for the computer.

- 1 Turn off your computer.
- 2 Remove the [base cover](#).
- 3 Disconnect the battery cable from the system board.
- 4 Press and hold down the power button for 15 seconds to drain the flea power.

- 5** Connect the battery cable to the system board.
- 6** Replace the [base cover](#).
- 7** Turn on your computer.

Wi-Fi power cycle

If your computer is unable to access the internet due to Wi-Fi connectivity issues a Wi-Fi power cycle procedure may be performed. The following procedure provides the instructions on how to conduct a Wi-Fi power cycle:

- 1** Turn off your computer.
- 2** Turn off the modem.
- 3** Turn off the wireless router.
- 4** Wait for 30 seconds.
- 5** Turn on the router.
- 6** Turn on the modem.
- 7** Turn on your computer.



Getting help and contacting Dell

Self-help resources

You can get information and help on Dell products and services using these self-help resources:

Table 15. Self-help resources

Information about Dell products and services

www.dell.com

Dell Help & Support app



Get started app



Accessing help

In Windows search, type **Help** and **Support**, and press Enter.

Online help for operating system

www.dell.com/support/windows

www.dell.com/support/linux

Troubleshooting information, user manuals, setup instructions, product specifications, technical help blogs, drivers, software updates, and so on.

www.dell.com/support

Dell knowledge base articles for a variety of computer concerns.

- 1 Go to www.dell.com/support.
- 2 At the top-right corner, type the subject or keyword in the **Search** box.
- 3 Click **Search** to retrieve the related articles.

Learn and know the following information about your product:

See *Me and My Dell* at www.dell.com/support/manuals.

- Product specifications



- Operating system
- Setting up and using your product
- Data backup
- Troubleshooting and diagnostics
- Factory and system restore
- BIOS information

To locate the *Me and My Dell* relevant to your product, identify your product through one of the following:

- Select **Detect Product**.
- Locate your product through the drop-down menu under **View Products**.
- Enter the **Service Tag number** or **Product ID** into the search bar.

Contacting Dell

To contact Dell for sales, technical support, or customer service issues, see www.dell.com/contactdell.



NOTE: Availability varies by country and product, and some services may not be available in your country.



NOTE: If you do not have an active internet connection, you can find contact information on your purchase invoice, packing slip, bill, or Dell product catalog.

