

Dell Precision 5820 Tower

Owner's Manual



Notes, cautions, and warnings

 | **NOTE:** A NOTE indicates important information that helps you make better use of your product.

 | **CAUTION:** A CAUTION indicates either potential damage to hardware or loss of data and tells you how to avoid the problem.

 | **WARNING:** A WARNING indicates a potential for property damage, personal injury, or death.

© 2017 2018 Dell Inc. or its subsidiaries. All rights reserved. Dell, EMC, and other trademarks are trademarks of Dell Inc. or its subsidiaries. Other trademarks may be trademarks of their respective owners.

1 Working on your computer	7
Safety instructions	7
Turning off your computer — Windows 10	7
Before working inside your computer	8
After working inside your computer	8
2 Removing and installing components	9
Screw size list	9
Recommended tools	10
Side cover	11
Removing the side cover	11
Installing the side cover	12
Power supply unit (PSU)	13
Removing the PSU	13
Installing the PSU	13
Front bezel	14
Removing the front bezel	14
Installing the front bezel	15
Hard Disk Drive bezel	15
Removing HDD bezel	15
Installing HDD bezel	16
Hard disk drive assembly	16
Removing the HDD bracket	16
Installing the HDD carrier	18
Removing the HDD	18
Installing the HDD	20
Slim Optical Disk Drive	20
Removing the slim ODD	20
Installing the slim ODD	22
Front input and output bezel	22
Removing front input and output bezel	22
Installing front input and output bezel	24
Optical Disk Drive	24
Removing the ODD	24
Installing the ODD	26
5.25 inch ODD bracket	26
Removing the 5.25 ODD bracket	26
Installing the 5.25 ODD bay	28
Front input and output panel	28
Removing front input and output panel	28
Installing front input and output panel	30
Input and output panel bracket	31
Removing input and output panel bracket	31

Installing input and output panel bracket.....	32
Intruder switch.....	32
Removing the Intruder switch.....	32
Installing the intruder switch.....	33
Internal chassis speaker.....	33
Removing the internal chassis speaker.....	34
Installing the internal chassis speaker.....	35
Air shroud.....	35
Removing the air shroud.....	35
Installing the air shroud.....	37
Memory.....	37
Removing the memory module.....	37
Installing the memory module.....	37
Expansion card.....	38
Removing the expansion card.....	38
Installing the expansion card.....	38
Coin cell battery.....	39
Removing the coin cell battery.....	39
Installing the coin cell battery.....	40
System fan.....	40
Removing the System fan.....	40
Installing the system fan.....	42
Fan bracket.....	42
Removing the fan from the fan bracket.....	42
Installing the fan into the fan bracket.....	43
PCIe holder.....	44
Removing PCIe holder	44
Installing the PCIe holder.....	45
Heat sink and CPU fan assembly.....	45
Removing the heat sink and CPU fan assembly.....	45
Installing heat sink and CPU fan assembly.....	46
Removing the CPU fan.....	47
Installing the CPU fan.....	49
Processor.....	49
Removing the processor.....	49
Installing the processor.....	50
Front system fan.....	50
Removing the front system fan.....	50
Installing the front system fan.....	52
System board.....	52
Removing system board.....	52
Installing the system board.....	58
System board components.....	59
3 Technology and components.....	61
Memory configuration.....	61
Technologies list.....	61



Teradici PCoIP.....	62
MegaRAID 9440-8i and 9460-16i controller.....	63
Key Features:.....	64
Expansion card installation guidelines.....	65
4 System specifications.....	68
System specifications.....	68
Memory specifications.....	68
Video specifications.....	68
Audio specifications.....	69
Network specifications.....	69
Card slots.....	69
Storage specifications.....	70
External connectors.....	70
Power specifications.....	70
Physical specifications.....	70
Environmental specifications.....	71
5 System Setup.....	72
General options.....	72
System configuration.....	73
Video.....	76
Security.....	76
Secure boot.....	79
Performance.....	79
Power management.....	80
Post behaviour.....	82
Manageability.....	82
Virtualization support.....	83
Maintenance.....	83
System logs.....	84
Advanced configurations.....	84
SupportAssist system resolution.....	84
Updating the BIOS in Windows	84
Updating BIOS on systems with bitlocker enabled.....	85
Updating your system BIOS using a USB flash drive.....	85
Updating the Dell BIOS in Linux and Ubuntu environments.....	86
System and setup password.....	86
Assigning a system password and setup password.....	86
Deleting or changing an existing system setup password.....	87
6 Software.....	88
Supported operating systems.....	88
Downloading drivers.....	88
Chipset drivers.....	89
Graphics controller driver.....	89
Ports.....	89



USB drivers.....	90
Network driver.....	90
Audio drivers.....	90
Storage controller drivers.....	90
Other drivers.....	90
Security device drivers.....	90
Software device drivers.....	91
Human Interface Device drivers.....	91
Firmware.....	91
7 Troubleshooting.....	92
Dell Enhanced Pre-Boot System Assessment — ePSA diagnostic 3.0.....	92
Running the ePSA diagnostics.....	92
Preboot blinking power button codes.....	92
PCIe slots.....	95
8 Contacting Dell.....	96



Working on your computer

Topics:

- Safety instructions
- Turning off your computer — Windows 10
- Before working inside your computer
- After working inside your computer

Safety instructions

Use the following safety guidelines to protect your computer from potential damage and to ensure your personal safety. Unless otherwise noted, each procedure included in this document assumes that the following conditions exist:

- You have read the safety information that shipped with your computer.
- A component can be replaced or, if purchased separately, installed by performing the removal procedure in reverse order.

- ⚠ WARNING:** Disconnect all power sources before opening the computer cover or panels. After you finish working inside the computer, replace all covers, panels, and screws before connecting to the power source.
- ⚠ WARNING:** Before working inside your computer, read the safety information that shipped with your computer. For additional safety best practices information, see the Regulatory Compliance Homepage at www.Dell.com/regulatory_compliance
- ⚠ CAUTION:** Many repairs may only be done by a certified service technician. You should only perform troubleshooting and simple repairs as authorized in your product documentation, or as directed by the online or telephone service and support team. Damage due to servicing that is not authorized by Dell is not covered by your warranty. Read and follow the safety instructions that came with the product.
- ⚠ CAUTION:** To avoid electrostatic discharge, ground yourself by using a wrist grounding strap or by periodically touching an unpainted metal surface at the same time as touching a connector on the back of the computer.
- ⚠ CAUTION:** Handle components and cards with care. Do not touch the components or contacts on a card. Hold a card by its edges or by its metal mounting bracket. Hold a component such as a processor by its edges, not by its pins.
- ⚠ CAUTION:** When you disconnect a cable, pull on its connector or on its pull-tab, not on the cable itself. Some cables have connectors with locking tabs; if you are disconnecting this type of cable, press in on the locking tabs before you disconnect the cable. As you pull connectors apart, keep them evenly aligned to avoid bending any connector pins. Also, before you connect a cable, ensure that both connectors are correctly oriented and aligned.
- ⓘ NOTE:** The color of your computer and certain components may appear differently than shown in this document.
- ⚠ CAUTION:** System will shut down if side covers are removed while the system is running. The system will not power on if the side cover is removed.

Turning off your computer — Windows 10

- ⚠ CAUTION:** To avoid losing data, save and close all open files and exit all open programs before you turn off your computer or remove the side cover.

- 1 Click or tap .
- 2 Click or tap  and then click or tap **Shut down**.



 **NOTE:** Ensure that the computer and all attached devices are turned off. If your computer and attached devices did not automatically turn off when you shut down your operating system, press and hold the power button for about 6 seconds to turn them off.

Before working inside your computer

To avoid damaging your computer, perform the following steps before you begin working inside the computer.

- 1 Ensure that you follow the [Safety Instruction](#).
- 2 Ensure that your work surface is flat and clean to prevent the computer cover from being scratched.
- 3 Ensure you follow the [Turning off your computer](#).
- 4 Disconnect all network cables from the computer.

 **CAUTION:** To disconnect a network cable, first unplug the cable from your computer and then unplug the cable from the network device.

- 5 Disconnect your computer and all attached devices from their electrical outlets.
- 6 Press and hold the power button while the computer is unplugged to ground the system board.

 **NOTE:** To avoid electrostatic discharge, ground yourself by using a wrist grounding strap or by periodically touching an unpainted metal surface at the same time as touching a connector on the back of the computer.

After working inside your computer

After you complete any replacement procedure, ensure that you connect any external devices, cards, and cables before turning on your computer.

- 1 Connect any telephone or network cables to your computer.

 **CAUTION:** To connect a network cable, first plug the cable into the network device and then plug it into the computer.

- 2 Connect your computer and all attached devices to their electrical outlets.
- 3 Turn on your computer.
- 4 If required, verify that the computer works correctly by running **ePSA diagnostics**.

Removing and installing components

Topics:

- Screw size list
- Recommended tools
- Side cover
- Power supply unit (PSU)
- Front bezel
- Hard Disk Drive bezel
- Hard disk drive assembly
- Slim Optical Disk Drive
- Front input and output bezel
- Optical Disk Drive
- 5.25 inch ODD bracket
- Front input and output panel
- Input and output panel bracket
- Intruder switch
- Internal chassis speaker
- Air shroud
- Memory
- Expansion card
- Coin cell battery
- System fan
- Fan bracket
- PCIe holder
- Heat sink and CPU fan assembly
- Processor
- Front system fan
- System board

Screw size list

Table 1. Screw list

Component	Screw type	Quantity
Slim ODD Bracket	#6-32 UNC X6.0mm	1
FIO Cable Clip	#6-32X1/4 inches	1
FIO Board	M3X6.5mm	2
FIO Bracket	#6-32 UNC X6.0mm	1
Front System Fan Bracket	#6-32 UNC X6.0mm	1



Component	Screw type	Quantity
Intruder Holder	M3X6.5mm	1
PDB Board	#6-32X1/4 inches	3
PDB Bracket	M3X6.5mm	1
Slim ODD Plug	M3X6.5mm	2
HDD Bracket	M3X6.5mm	1
5.25" ODD Bracket	<ul style="list-style-type: none"> · #6-32 UNC X6.0mm · M3X6.5mm 	<ul style="list-style-type: none"> · 2 · 2
System Board	#6-32X1/4 inches	10
Middle Fan Fixed Bracket	#6-32X1/4 inches	1
Middle Fan Bracket	#6-32X1/4 inches	3
Rear Fan Bracket	#6-32X1/4 inches	2
HSBP Board	M3X6.5mm	2
Slim ODD Fixed Bracket	M2X2.0mm	2
Slim ODD	M3X6.5mm	1
5.25" ODD	M3X4.5mm	4
3.5" HDD Bracket	M3X4.5mm	4
2.5" HDD Bracket	M3X4.5mm	4
2nd CPU Support Bracket	#6-32X1/4 inches	2
2nd CPU Board	#6-32X1/4 inches	5
UPI Fixed Bracket	M3X5.0mm	1
CPU Cooler	T-30 torx bolt	4
Liquid Cooler Module	<ul style="list-style-type: none"> · #6-32X1/4 inches · #6-32 UNC X3.5mm · T-30 torx bolt 	<ul style="list-style-type: none"> · 4 · 6 · 4
M.2 Carrier Cover	<ul style="list-style-type: none"> · M2X6mm · M2X3mm 	<ul style="list-style-type: none"> · 1 · 2

Recommended tools

The procedures in this document require the following tools:

- Phillips #0 screwdriver
- Phillips #1 screwdriver
- Philips #2 screwdriver
- Plastic scribe

① | NOTE: The #0 screw driver is for screws 0-1 and the #1 screw driver is for screws 2-4

Side cover

Removing the side cover

- 1 Follow the procedure in [Before working inside your computer](#).

CAUTION: The system will not power on while the side cover is off. Also, the system will shut down if the side cover is removed while the system is on.

- 2 To remove the side cover:
- 3 Press the latch



- 4 Pull the latch [1] upward and rotate it to release the cover [2].





- 5 Lift the cover to remove it from the system.

Installing the side cover

- 1 First hold and align the bottom of the side cover to the chassis.
- 2 Ensure that the hook on the bottom of the side cover snaps into the notch on the system.
- 3 Press the system cover until it clicks into place.

CAUTION: The system will not power on without the side cover. Also, the system will shut down if the side cover is removed while the system is on.

- 4 Follow the procedure in [After working inside your computer](#) .

Power supply unit (PSU)

Removing the PSU

- 1 Follow the procedure in [Before working inside your computer](#).
- 2 Disconnect the power cable from the system.
- 3 Press the PSU release latch [1] and slide the power supply away from the system [2].

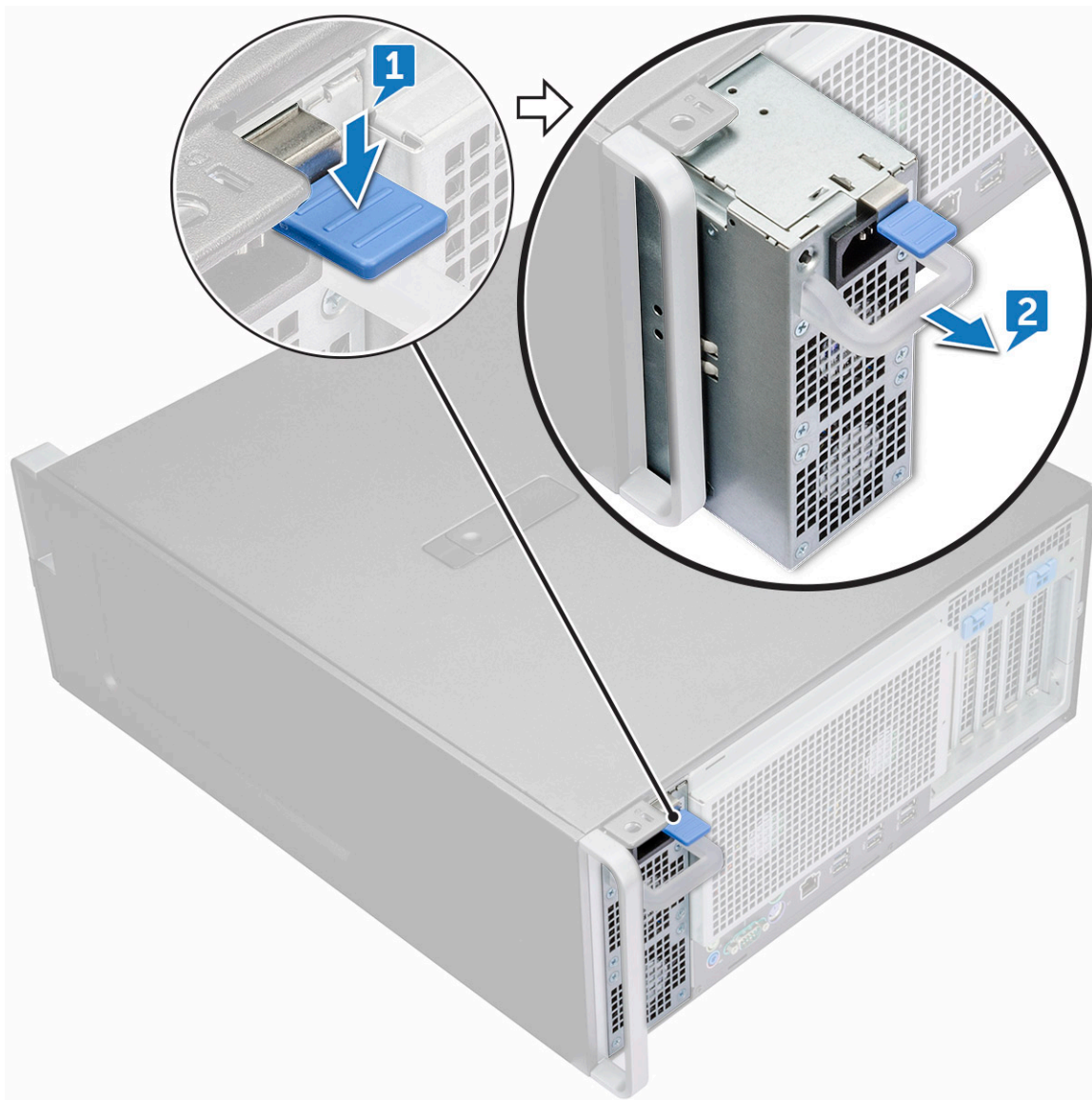

Installing the PSU

- 1 Slide in the power supply unit to the PSU slot on the system.
- 2 Connect the power cable to the system.
- 3 Follow the procedure in [After working inside your computer](#)



Front bezel

Removing the front bezel

- 1 Follow the procedure in [Before working inside your computer](#).
- 2 Remove the [side cover](#).
- 3 To remove the front bezel:
 - a Pry the retention tabs to release the front bezel from the system.

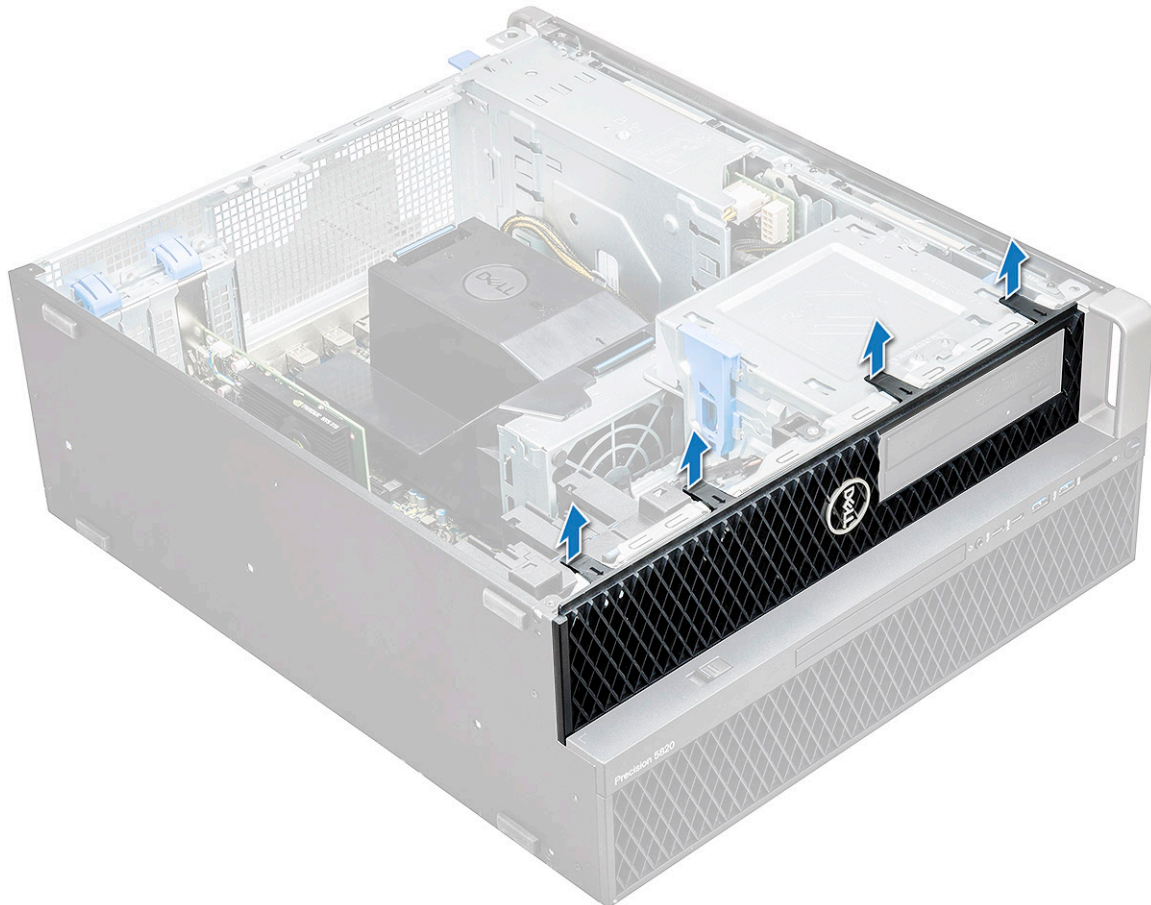

- b Rotate the bezel forward and lift the front bezel away from the system.



Installing the front bezel

- 1 Hold the bezel and ensure that the hooks on the bezel snap into the notches on the system.
- 2 Rotate the bezel forward and press the front bezel until the tabs click into place.
- 3 Follow the procedure in [After working inside your computer](#).

Hard Disk Drive bezel

Removing HDD bezel

- 1 Follow the procedure in [Before working inside your computer](#).
- 2 Remove the [side cover](#).
- 3 To remove the HDD bezel:
 - a Press the blue unlock button [1] on the edge of ODD bay.
 - b Slide the latch [2] to the unlock position, on the front I/O bezel.
 - c Rotate forward and lift the HDD bezel [3] away from the system.

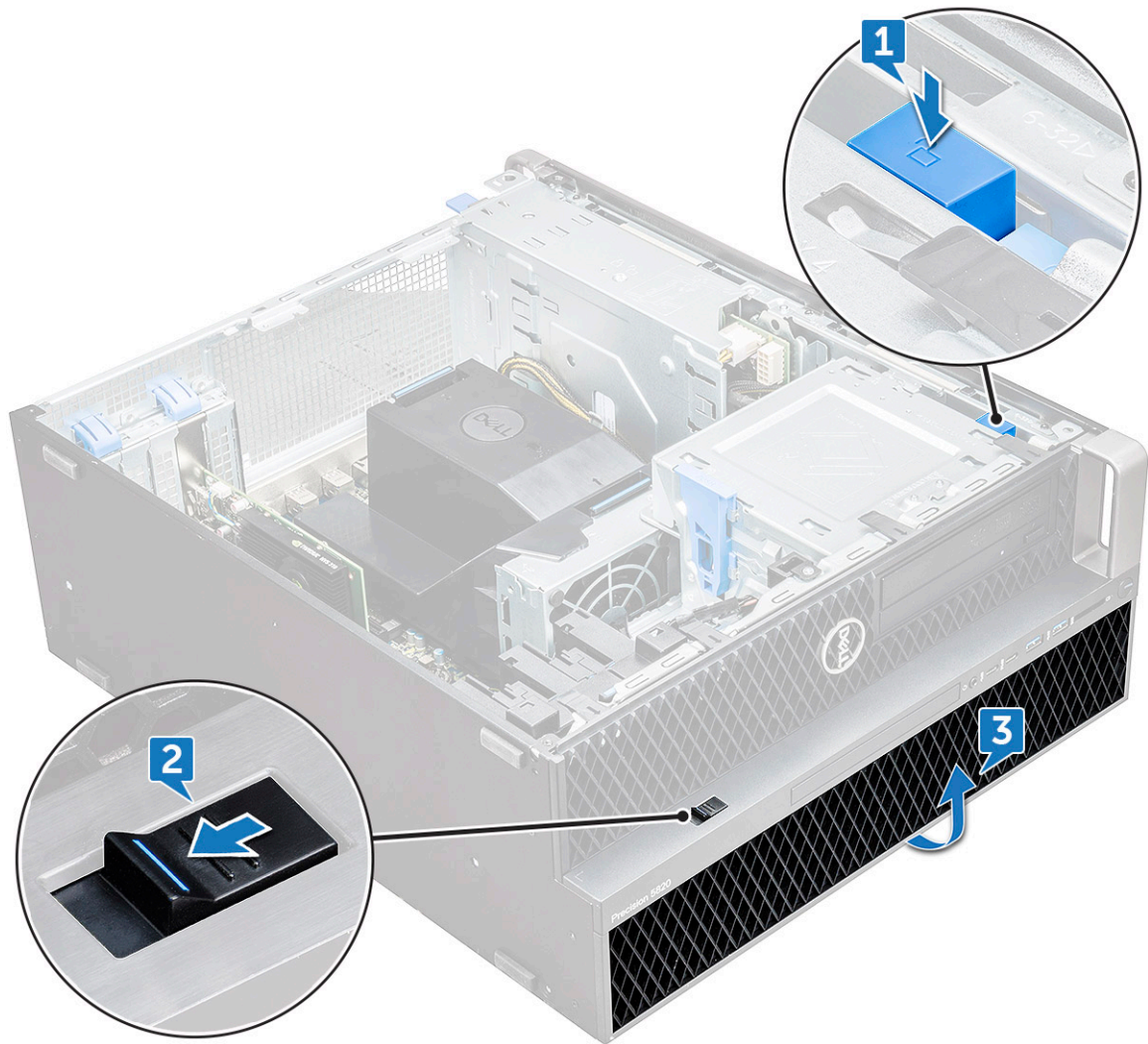

Installing HDD bezel

- 1 Hold the bezel and ensure that the hooks on the bezel snap into the notches on the system.
- 2 Press the blue lock button on the left edge of the ODD bay to secure the bezel to the system.
- 3 Install the [side cover](#).
- 4 Follow the procedure in [After working inside your computer](#).

Hard disk drive assembly

Removing the HDD bracket

- 1 Follow the procedure in [Before working inside your computer](#).
- 2 Remove the:
 - a [side cover](#)
 - b [HDD bezel](#)
- 3 To remove the HDD bracket:
 - a **NOTE:** Do not remove the side cover, if the front I/O bezel is unlocked.

- a Press the release button [1] to unlock the latch [2].

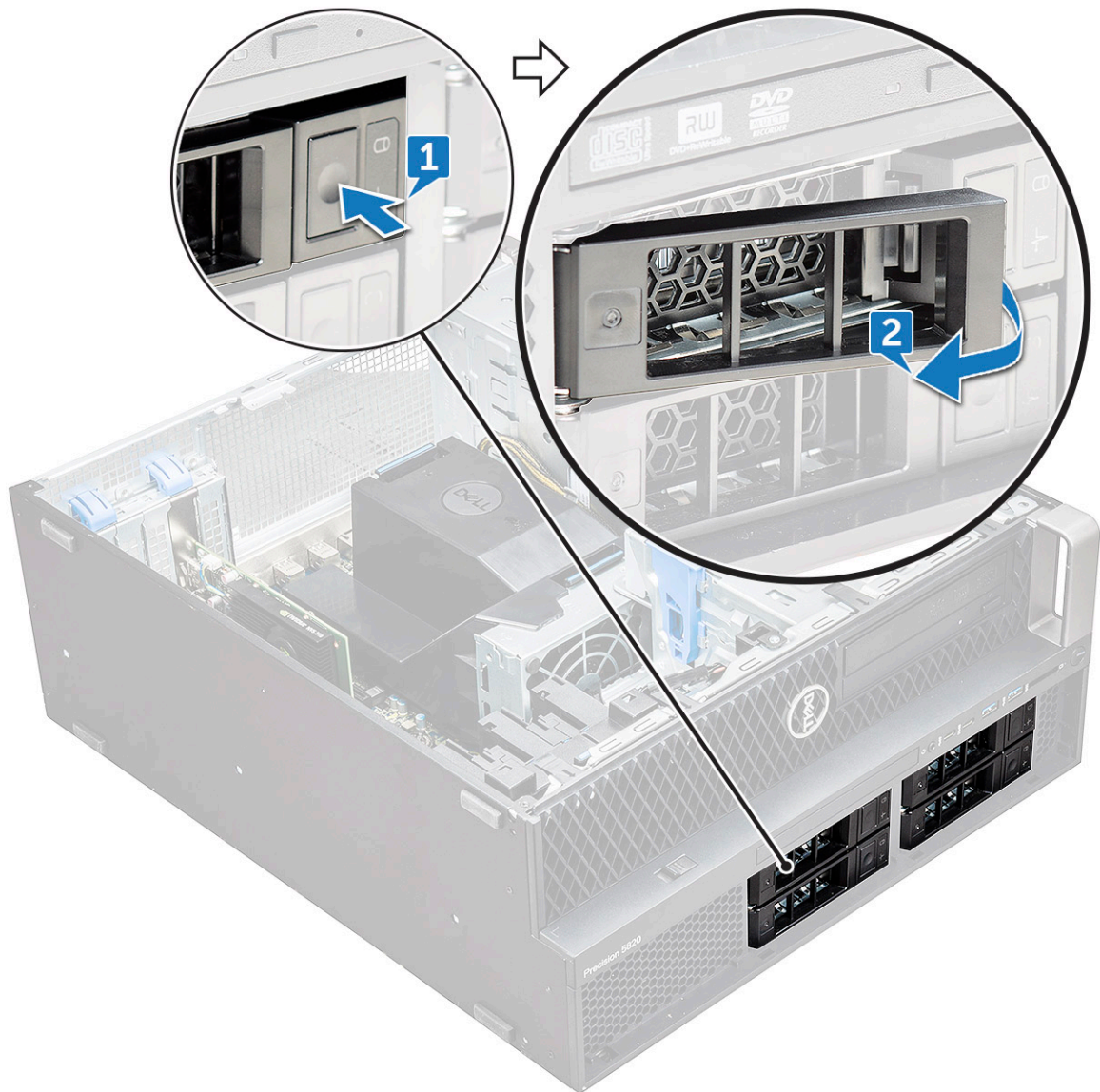

- b Pull the latch to slide the bracket out of the HDD slot.



Installing the HDD carrier

- 1 Slide the bracket into the drive bay until it clicks into place.
⚠ CAUTION: Ensure that the latch is open before installing the bracket.
- 2 Lock the latch.
- 3 Install the following components:
 - a HDD bezel
 - b side cover
- 4 Follow the procedure in [After working inside your computer](#).

Removing the HDD

- 1 Follow the procedure in [Before working inside your computer](#).
- 2 Remove the following:
 - a side cover

- b HDD bezel
 - c HDD bracket
- 3 To remove the HDD:
- a Expand one side of the bracket.



- b Lift the hard drive out of the bracket.



Installing the HDD

- 1 Insert the HDD into the 3.5" bracket with the connector end of the hard drive towards the back of the HDD bracket.
- 2 Slide the HDD bracket back into the hard drive bay.
- 3 Install the following:
 - a [HDD bracket](#)
 - b [HDD bezel](#)
 - c [side cover](#)
- 4 Follow the procedure in [After working inside your computer](#)

Slim Optical Disk Drive

Removing the slim ODD

- 1 Follow the procedure in [Before working inside the computer](#).
- 2 Remove the [side cover](#).
- 3 To remove the slim ODD:
 - a Remove the screw [1] that secures the slim ODD and push the slim ODD [2] out of the chassis.

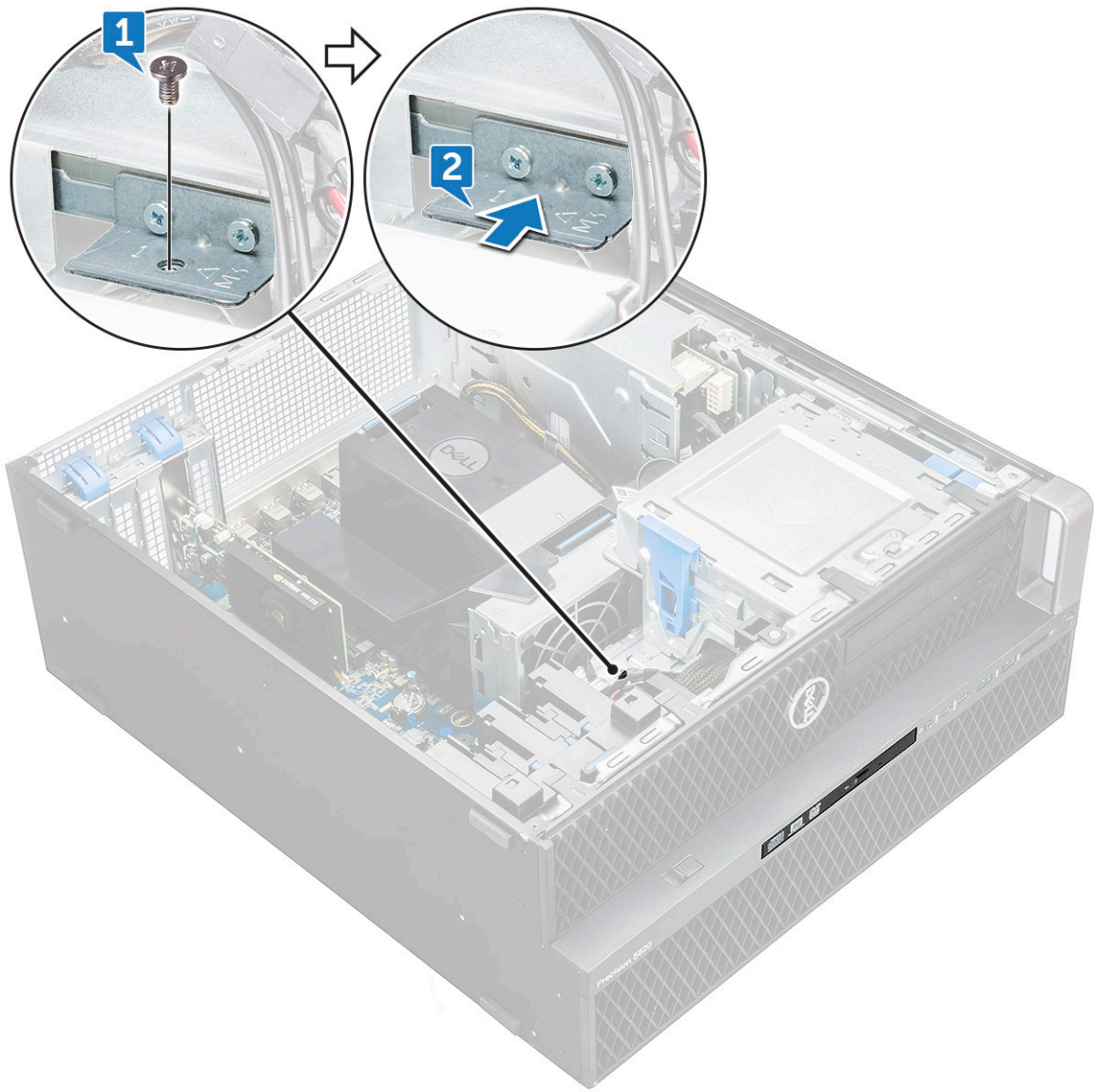

b Slide the slim ODD out of the system.



Installing the slim ODD

- 1 Slide the slim ODD into the slot on the chassis.
- 2 Tighten the screw to secure the slim ODD to the chassis.
- 3 Install the [side cover](#).
- 4 Follow the procedure in [After working inside your computer](#).

Front input and output bezel

Removing front input and output bezel

- 1 Follow the procedure in [Before working inside your computer](#).
- 2 Remove the:
 - a [side cover](#)
 - b [front bezel](#)
- 3 To remove the front input and output(I/O) bezel:
 - a Pry the four retention tabs[1] from the chassis and push the bezel out from the chassis[2].

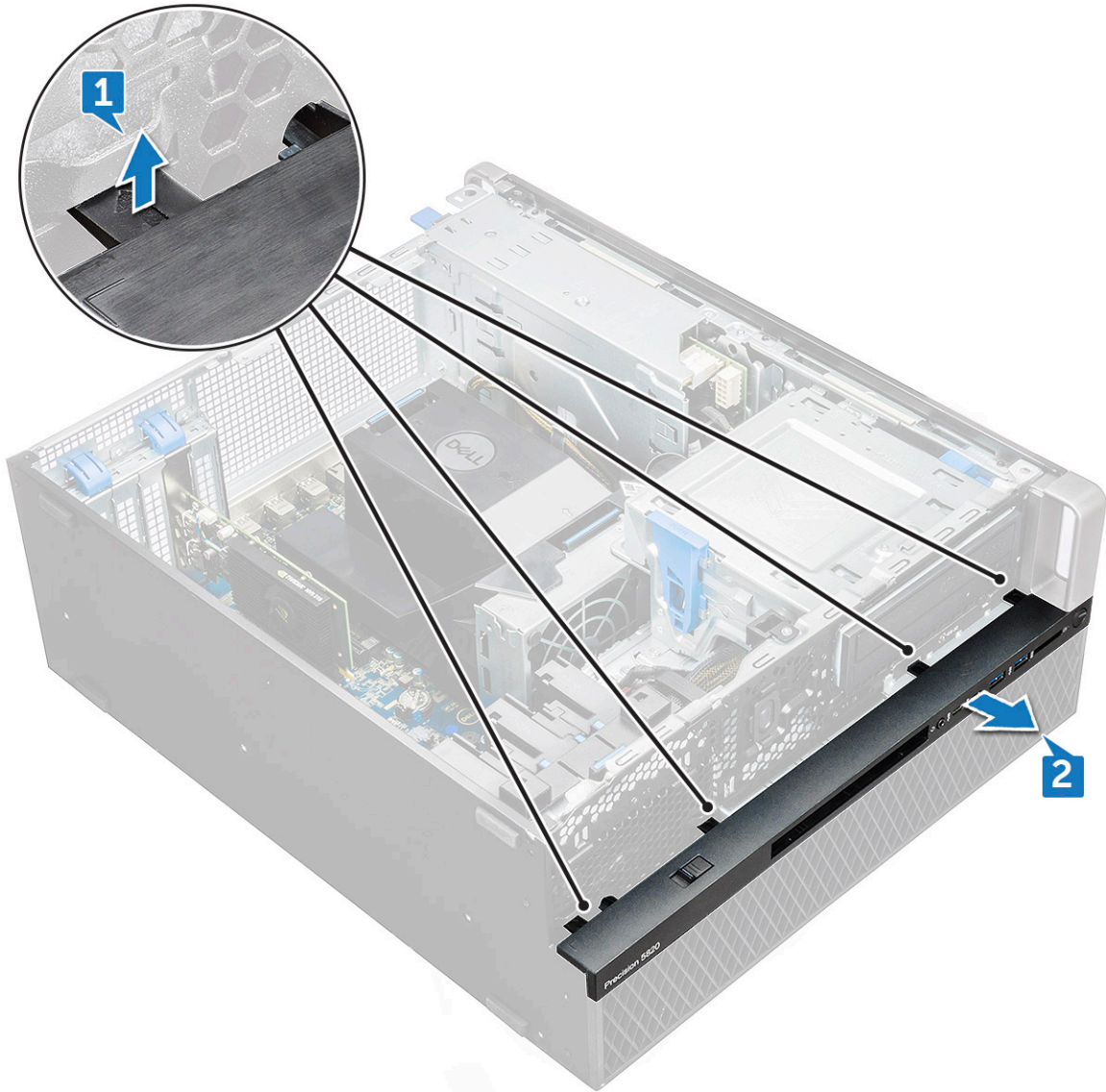

b Lift the bezel from the chassis.

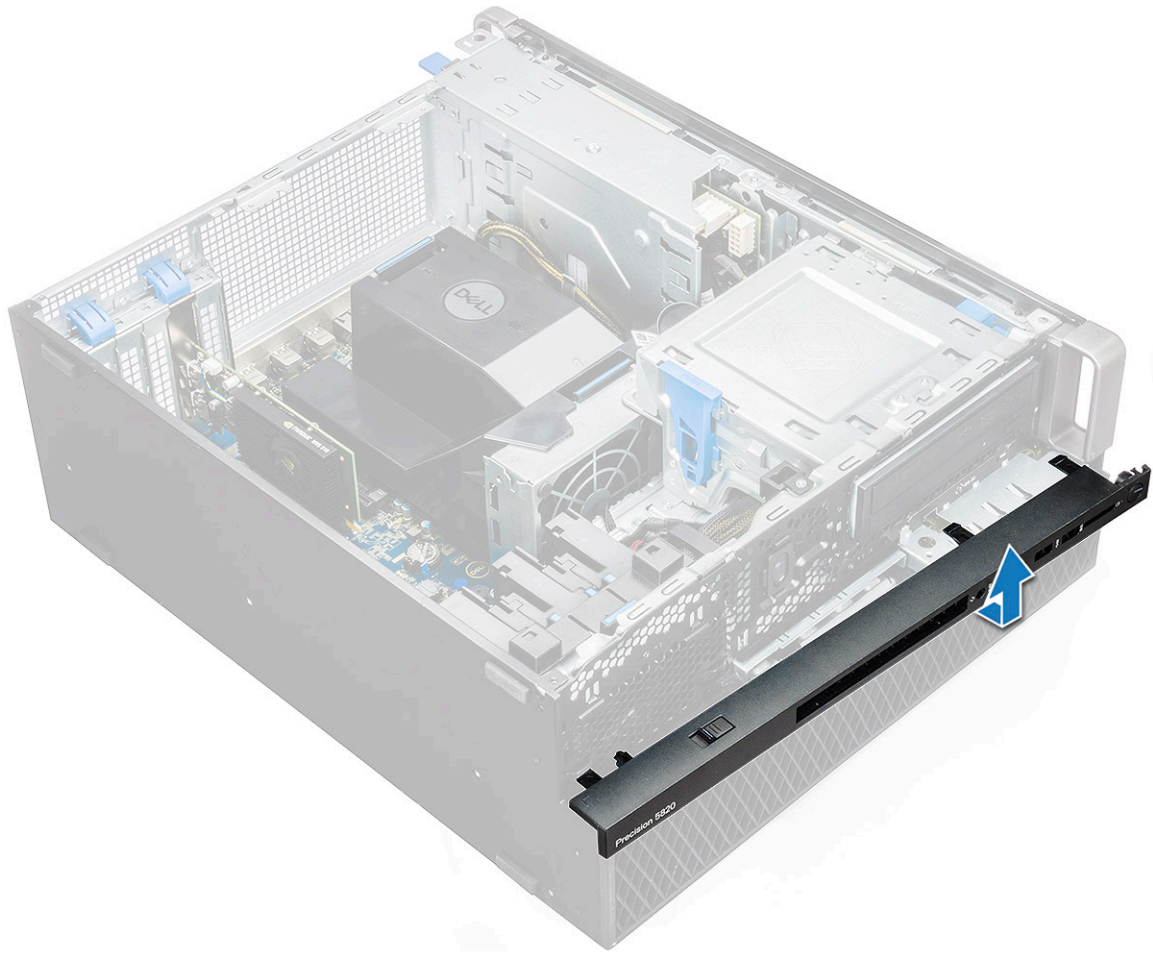

Installing front input and output bezel

- 1 Hold the input and output(I/O) bezel and ensure that the hooks on the bezel snap into the notches on the system.
- 2 Press the retention tabs and secure them to the chassis.
- 3 Install the :
 - a front bezel
 - b side cover
- 4 Follow the procedure in [After working inside your computer](#).

Optical Disk Drive

Removing the ODD

- 1 Follow the procedure in [Before working inside your computer](#).
- 2 Remove the:
 - a side cover
 - b front bezel
- 3 To remove the ODD:
 - a Remove the optical drive data cable and optical drive power cable from the ODD.

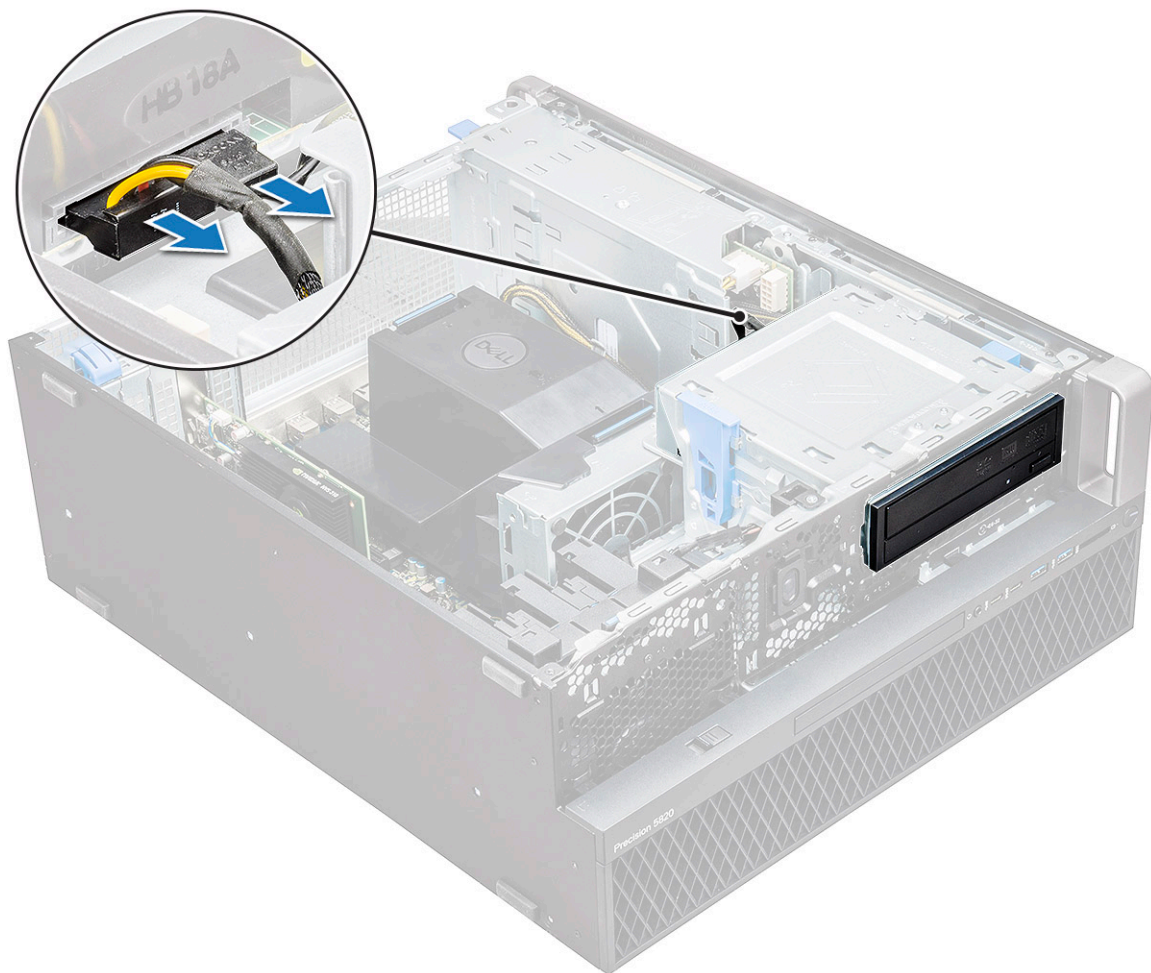

- b Push the optical drive release button[1] and push the optical drive out of the system.
- c Slide the ODD[2] from the ODD bracket.

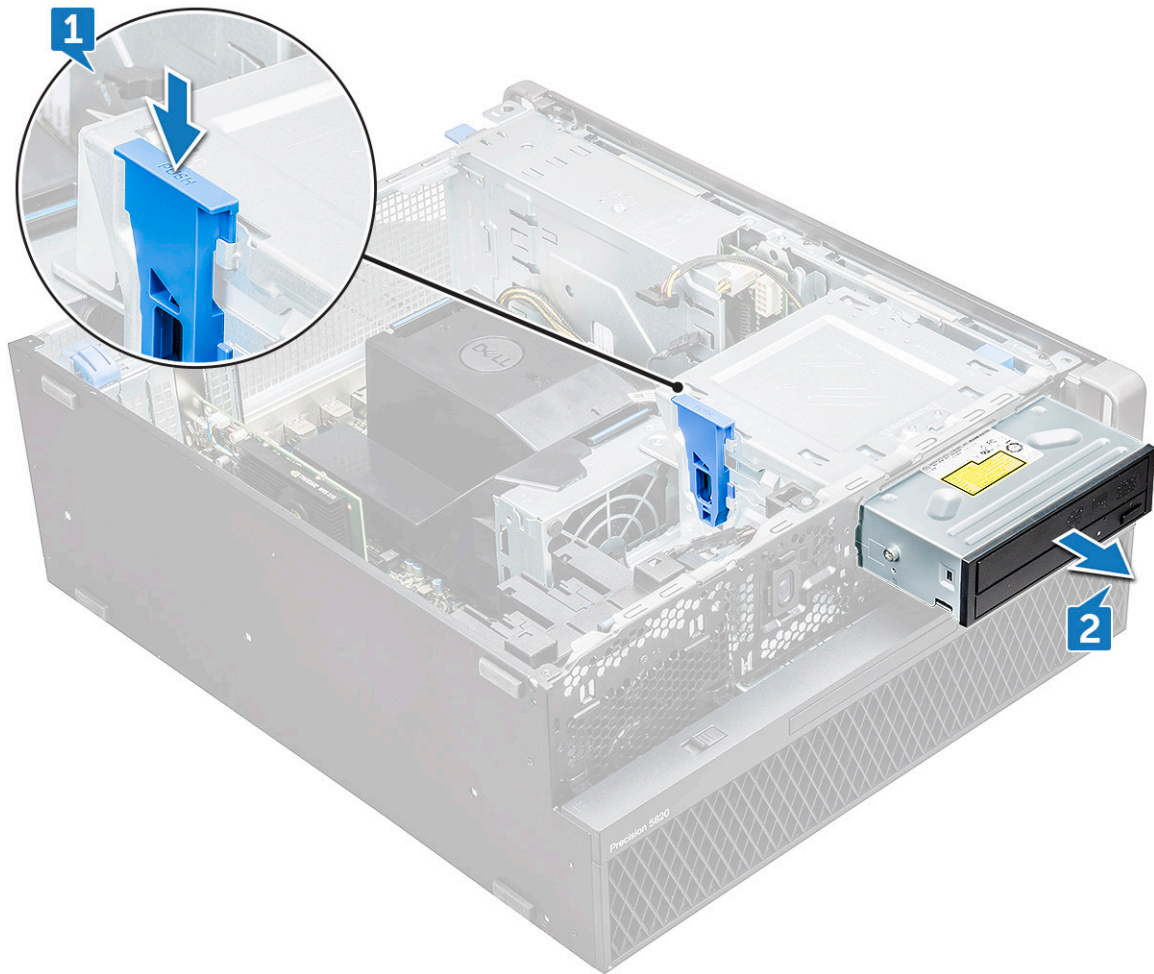

Installing the ODD

- 1 Place the ODD into the 5.25" ODD bracket.
- 2 Slide the ODD and lock the latch by a click.
- 3 Connect the optical drive data cable and optical drive power cable to the ODD.
- 4 Install the:
 - a [front bezel](#)
 - b [side cover](#)
- 5 Follow the procedure in [After working inside your computer](#)

5.25 inch ODD bracket

Removing the 5.25 ODD bracket

- 1 Follow the procedure in [Before working inside your computer](#).
- 2 Remove the:
 - a [side cover](#)
 - b [front bezel](#)
 - c [ODD](#)
- 3 To remove the ODD bracket:

- a Remove the five screws[1,2] that secure the bracket to the chassis.

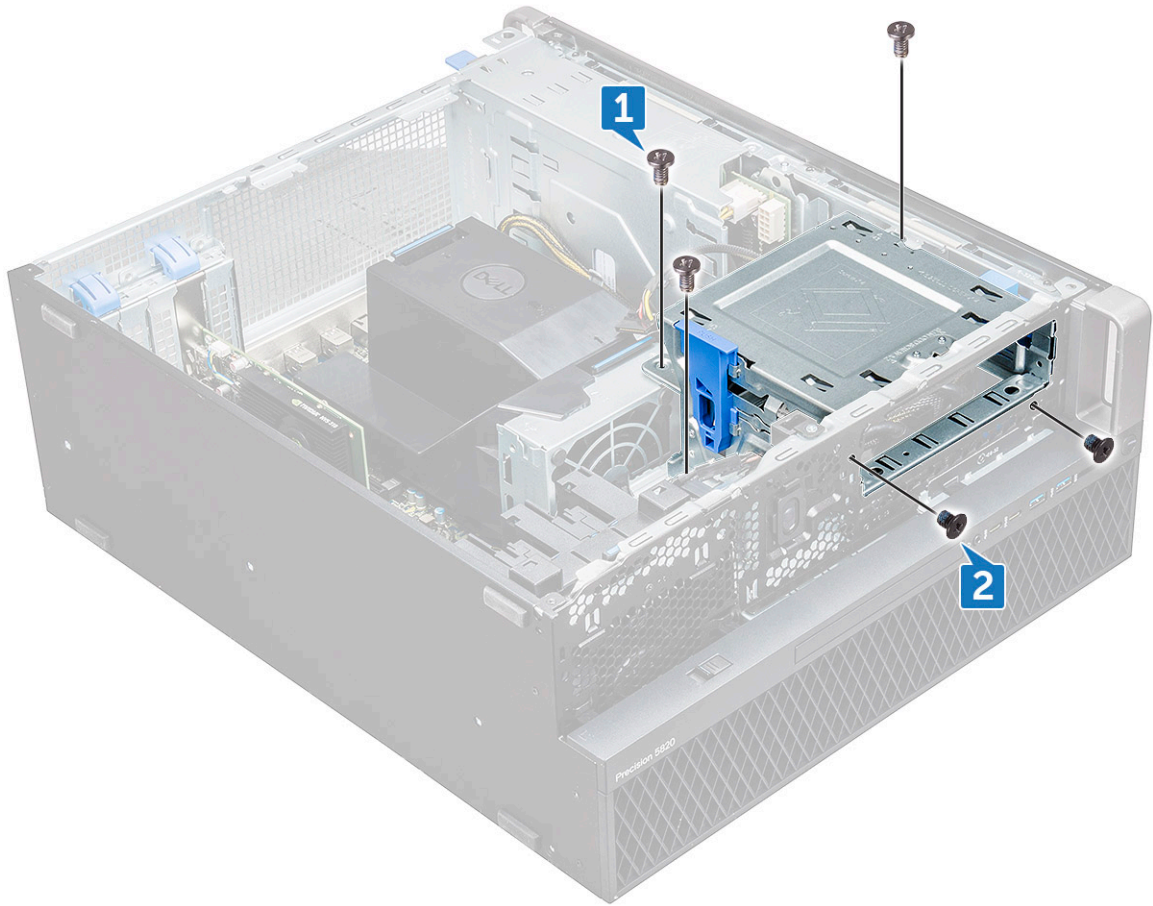

- b Slide the ODD bracket toward the rear of the system and lift it away from the chassis.

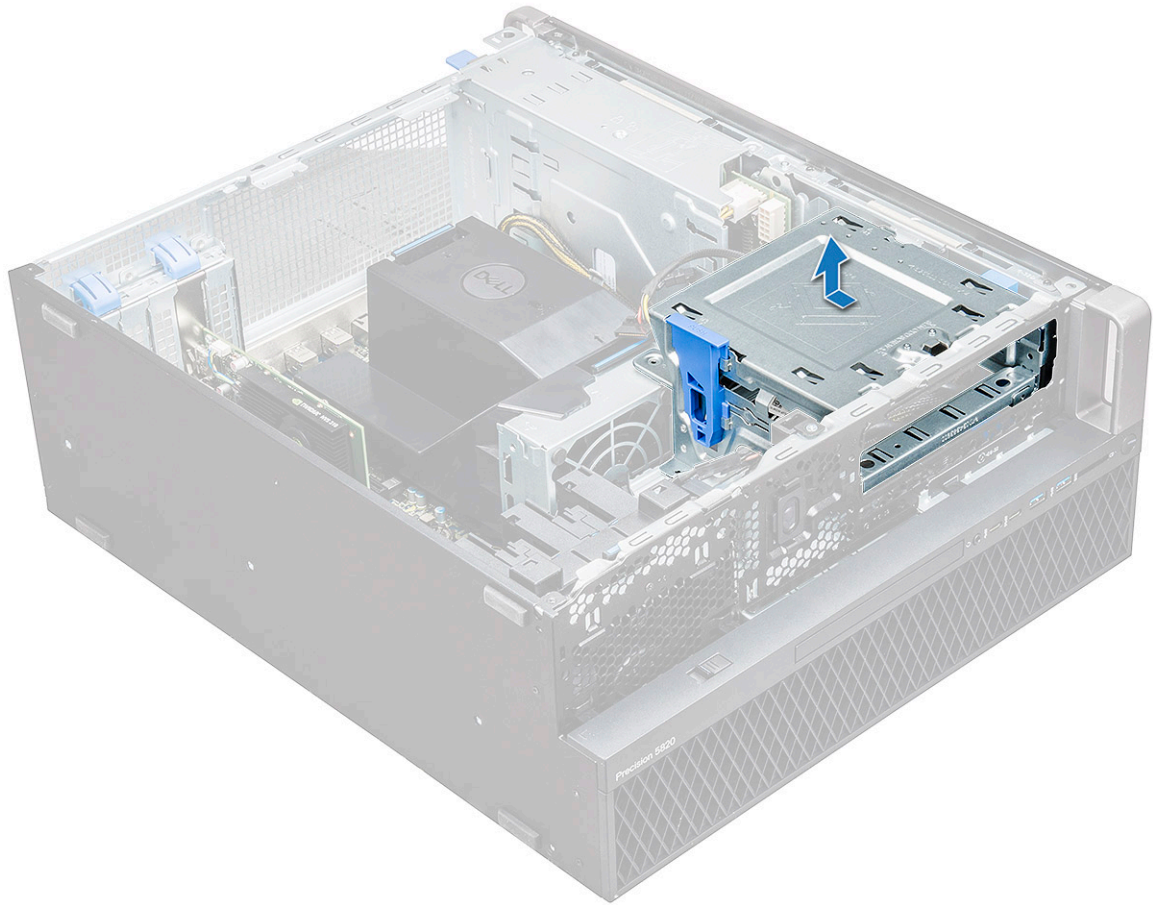

Installing the 5.25 ODD bay

- 1 Place the ODD bracket into the system slot.
- 2 Replace the (6-32 X 6.0mm) screws.
- 3 Install the:
 - a ODD
 - b front bezel
 - c side cover
- 4 Follow the procedure in [After working inside your computer](#)

Front input and output panel

Removing front input and output panel

- 1 Follow the procedure in [Before working inside your computer](#).
- 2 Remove the:
 - a side cover
 - b front bezel
 - c front input and output bezel
 - d 5.25 inch ODD bracket
- 3 To remove the front input and output(I/O) panel:
 - a Disconnect the intruder switch cable [1], USB 3.1 cable [2], front I/O power cable [3], USB 3.1 cable [4], Speaker cable [5], Audio cable [6]

NOTE: Do not pull the connector by the cable wires. Instead, disconnect the cable by pulling the connector end. Pulling the cable wires may loosen them from the connector.

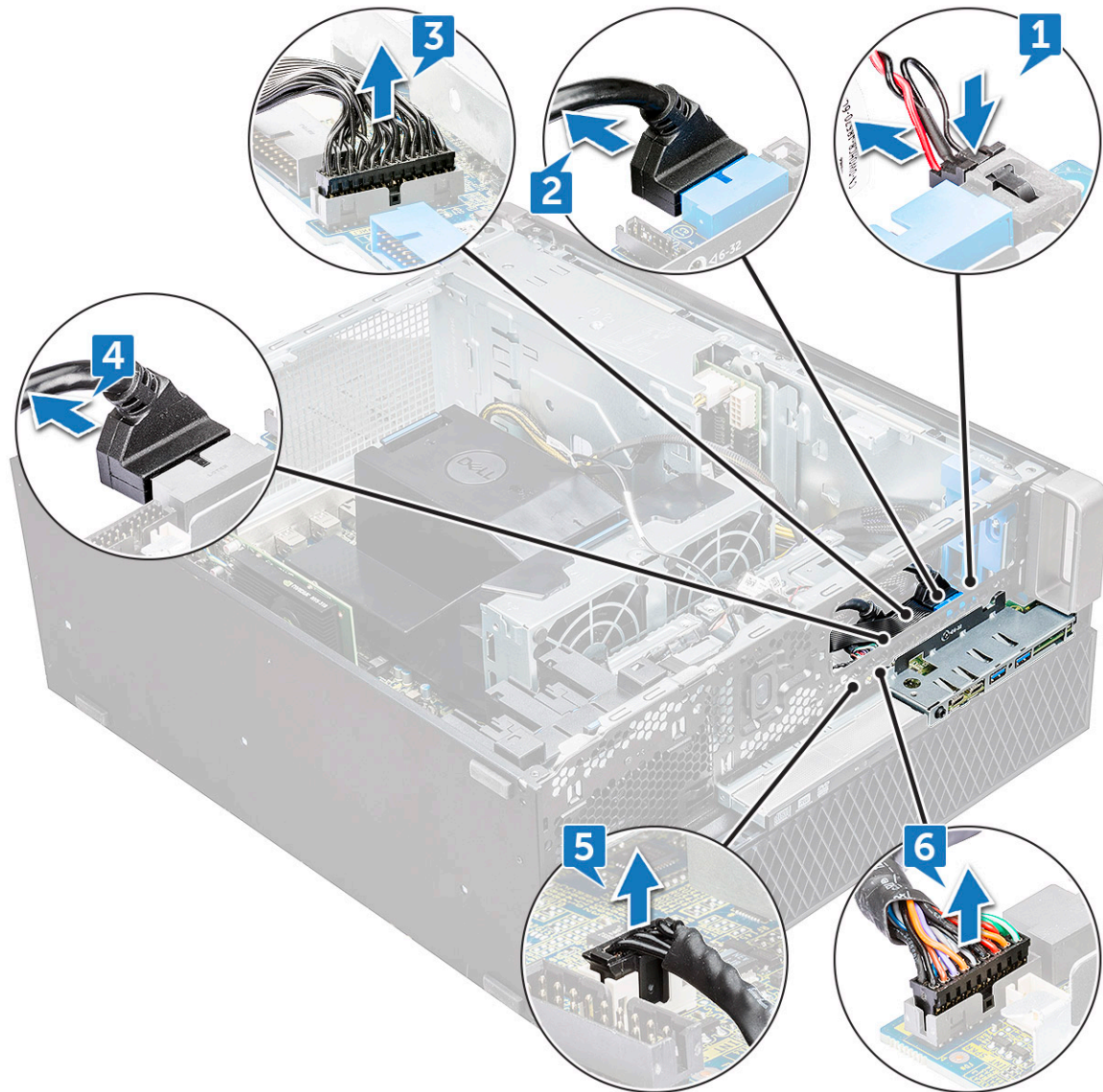

b Remove the screw[1] that secures the front I/O panel to the chassis and slide the I/O panel out of the chassis[2].

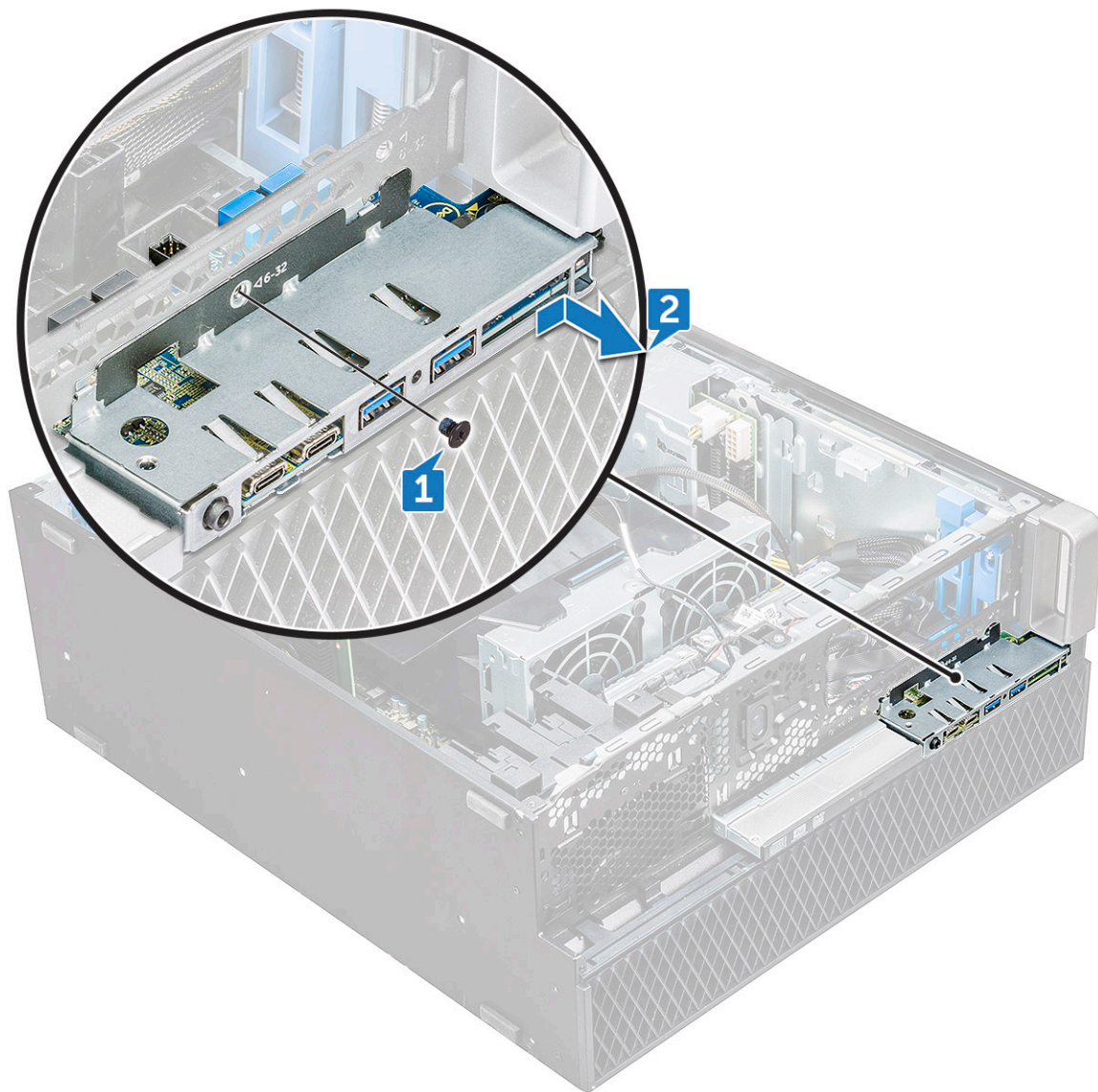

Installing front input and output panel

- 1 Insert the input and output(I/O) panel onto its slot in the system.
- 2 Slide the panel to secure the hooks into the chassis hole.
- 3 Tighten the screw to secure the front I/O panel to the chassis.
- 4 Connect the following cables:
 - intruder switch cable
 - USB 3.1 cable
 - front I/O power cable
 - front I/O power cable
 - USB 3.1 cable
 - speaker cable
 - audio cable
- 5 Install the:
 - a [front input and output bezel](#)
 - b [5.25 inch ODD bracket](#)

- c front bezel
- d side cover

6 Follow the procedure in [After working inside your computer](#).

Input and output panel bracket

Removing input and output panel bracket

- 1 Follow the procedure in [Before working inside your computer](#).
- 2 Remove the:
 - a side cover
 - b front bezel
 - c front input and output bezel
 - d 5.25 inch ODD bracket
 - e front input and output panel
- 3 To remove the input and output(I/O) panel bracket:
 - a Remove the two screws.

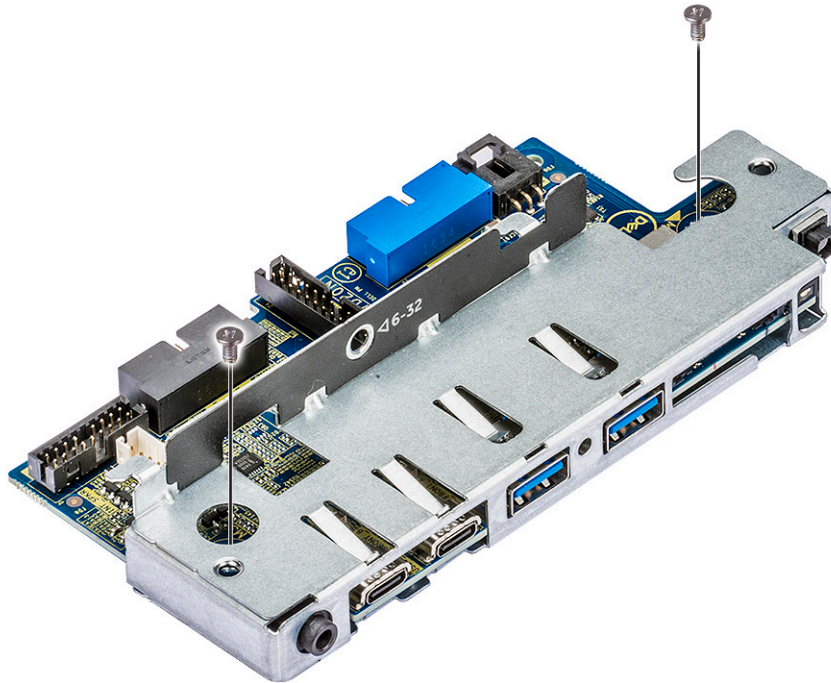

- b Slide the I/O module out of the bracket.

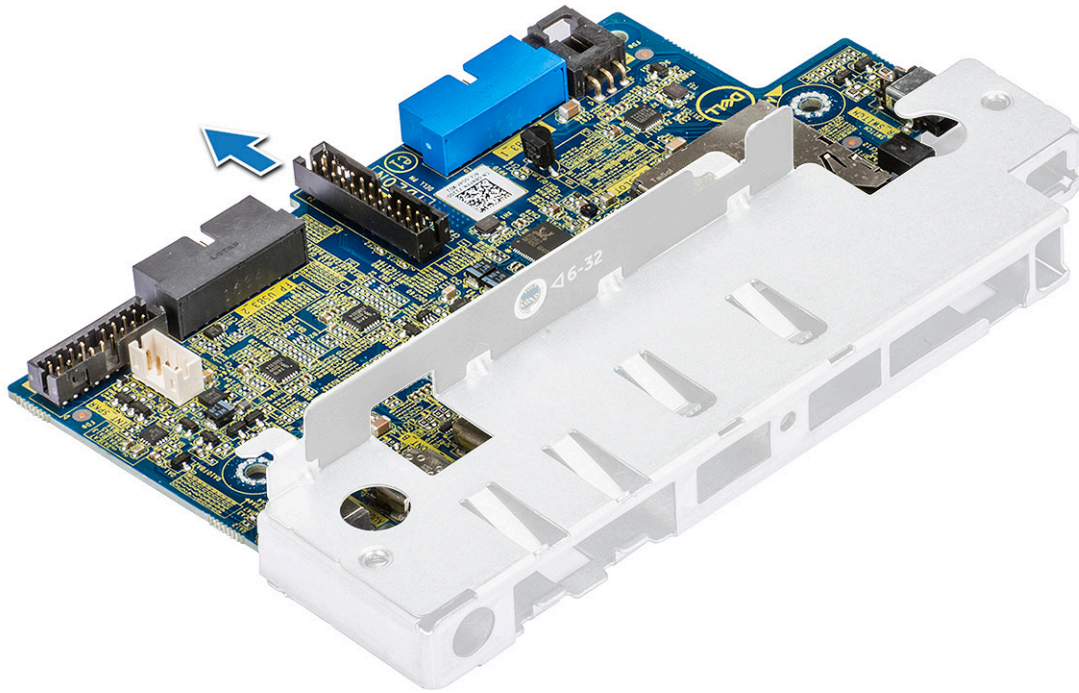

Installing input and output panel bracket

- 1 Insert the input and output(I/O) panel into the metal bracket.
- 2 Replace the screws to secure the I/O panel bracket to the I/O panel.
- 3 Install the:
 - a front input and output panel
 - b front input and output bezel
 - c 5.25 inch ODD bracket
 - d front bezel
 - e side cover
- 4 Follow the procedure in [After working inside your computer](#).

Intruder switch

Removing the Intruder switch

- 1 Follow the procedure in [Before working inside your computer](#).
- 2 Remove the:
 - a side cover
 - b front bezel
 - c 5.25 inch ODD bracket
- 3 To remove the intruder switch:
 - a Disconnect the intruder cable [1] from the I/O module.
 - b Remove the screw [2] that secures the intruder switch to the chassis.
 - c Lift the intruder switch and remove it from the chassis.

NOTE: The system will not power on without the Intruder switch installed.

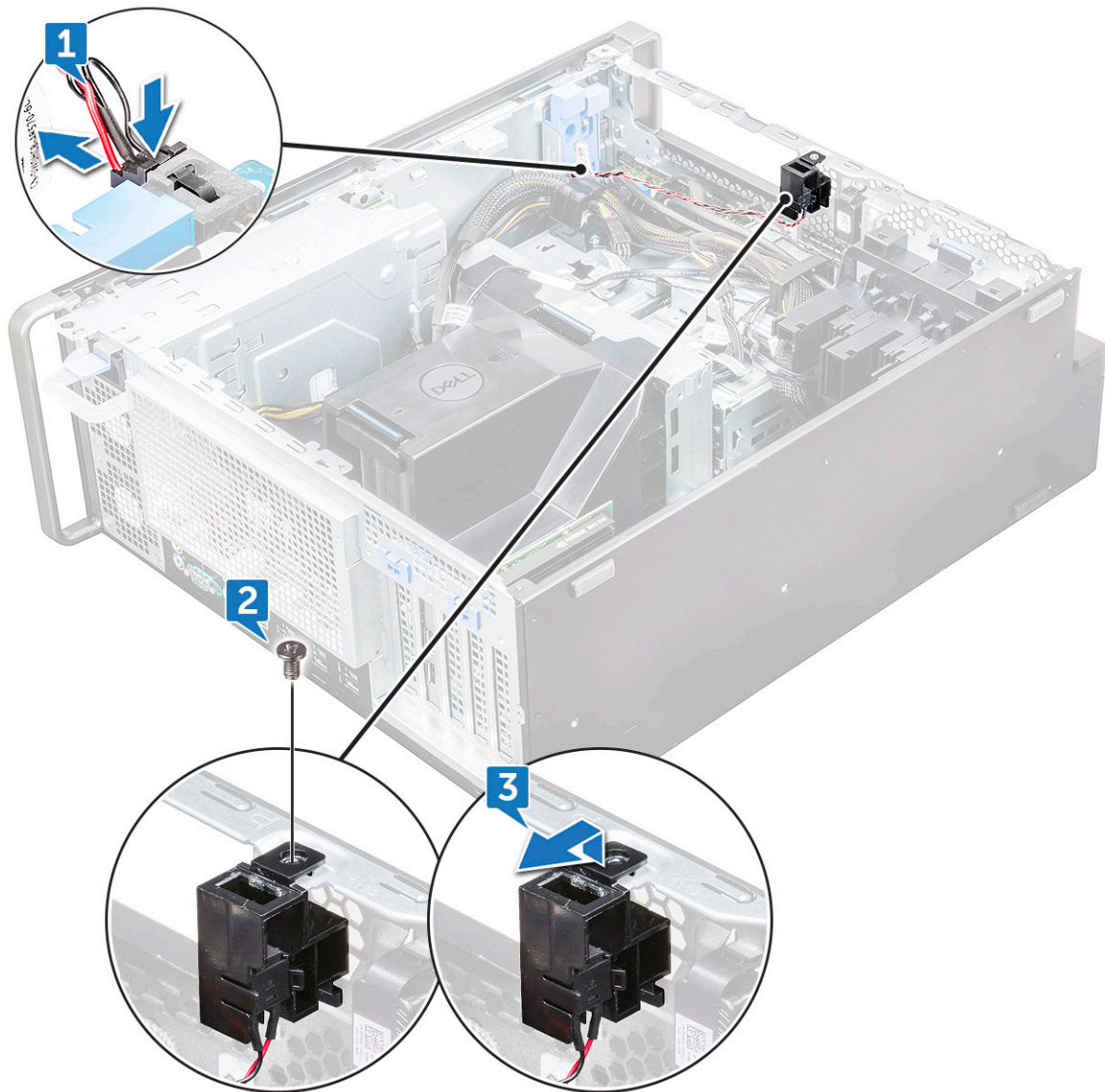

Installing the intruder switch

- 1 Place the intruder switch into the slot in the system chassis.
- 2 Replace the screw and secure the switch to the chassis.
- 3 Connect the cable to the system board.
- 4 Install the:
 - a 5.25 inch ODD bracket
 - b front bezel
 - c side cover
- 5 Follow the procedure in [After working inside your computer](#).

Internal chassis speaker



Removing the internal chassis speaker

- 1 Follow the procedure in [Before working inside your computer](#).
- 2 Remove the:
 - a [side cover](#)
 - b [front bezel](#)
 - c [5.25 inch ODD bracket](#)
- 3 To remove the internal chassis speaker:
 - a Disconnect the speaker cable [1] from the front I/O module.
 - b Press the speaker securing tabs [2], then pull to release it from the system.
 - c Gently push the speaker [3] with its cable out of the system.

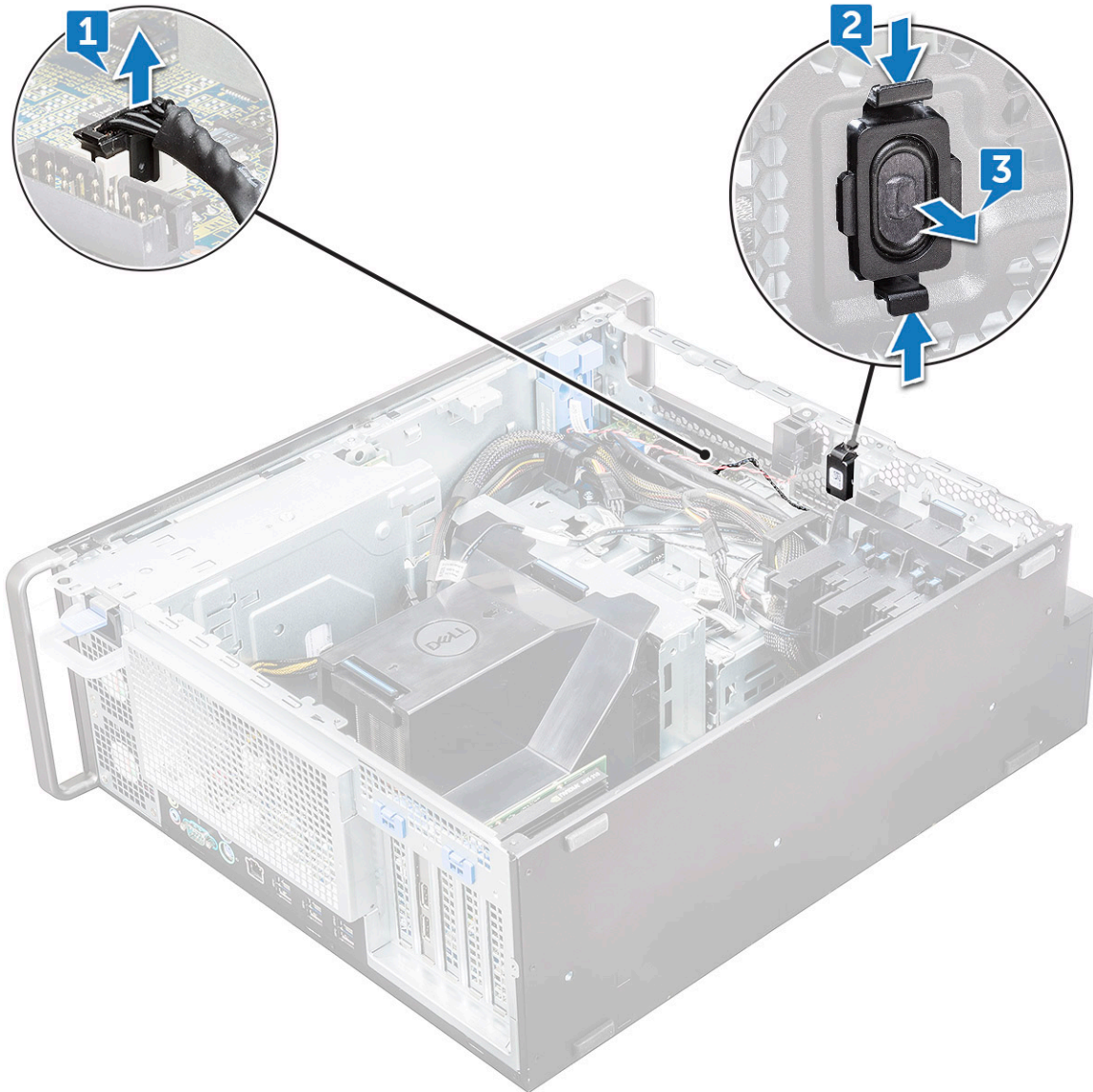

Installing the internal chassis speaker

- 1 Press and hold the tabs on either side of the intrusion speaker, and slide the speaker module into the slot to secure it to the system.
- 2 Connect the internal chassis speaker cable to the connector on the system chassis.
- 3 Install the:
 - a [5.25 inch ODD bracket](#)
 - b [front bezel](#)
 - c [side cover](#)
- 4 Follow the procedure in [After working inside your computer](#)

Air shroud

Removing the air shroud

- 1 Follow the procedure in [Before working inside your computer](#).
- 2 Remove the [side cover](#)
- 3 To remove the air shroud:
 - a Press in the securing tabs by holding the air shroud from both the ends, and then lift the air shroud from the system.



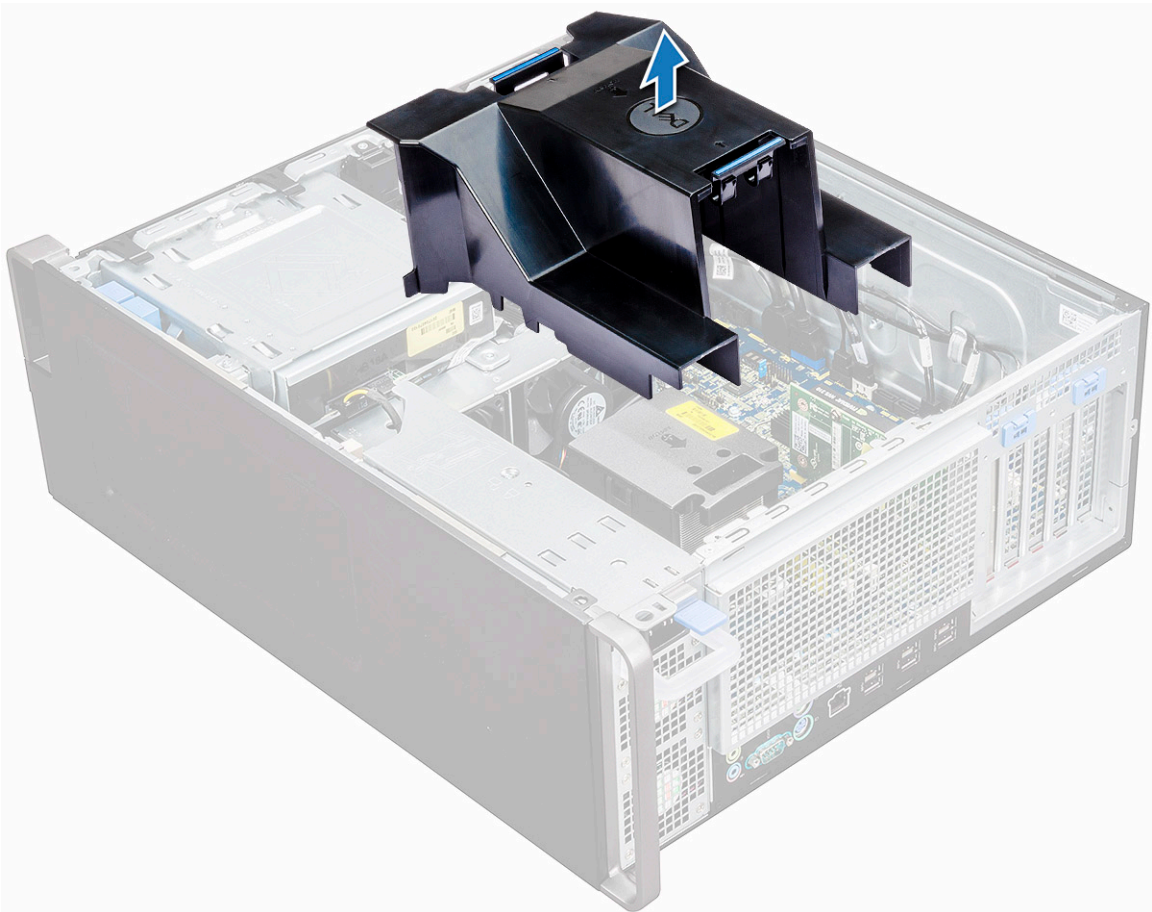

Installing the air shroud

- 1 Arrange CPU power cables before installing.
- 2 Place the shroud into its position.
- 3 Make sure that the two securing holes of the air shroud is completely inserted into the two holes on the middle fan bracket and the other latch is fixed on the cooler.
- 4 Press down the shroud to lock it with a click.
- 5 Install the [side cover](#).
- 6 Follow the procedure in [After working inside your computer](#).

Memory

Removing the memory module

- 1 Follow the procedure in [Before working inside your computer](#).
- 2 Remove the following:
 - a [side cover](#)
 - b [air shroud](#)
- 3 Press the memory module retention tabs on each side of the memory module.
- 4 Lift the memory module out of the memory slot on the system board.

⚠ WARNING: Rotating the memory module out of the slot will cause damage to the memory module. Ensure to pull it straight out of the memory module slot.

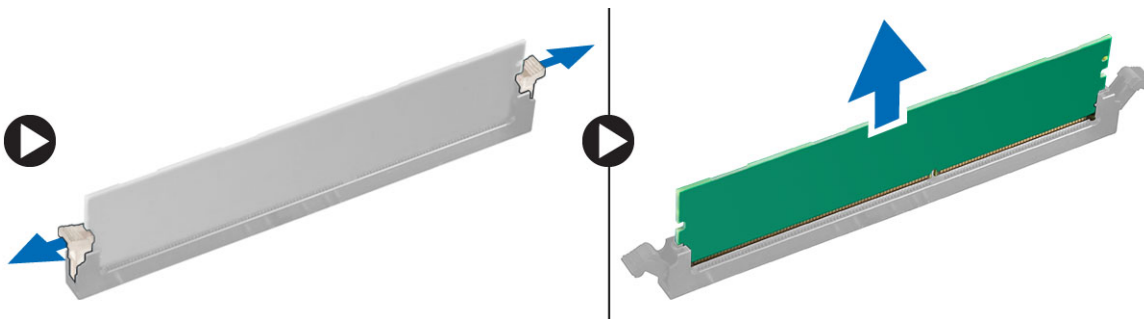

Installing the memory module

- 1 Align the notch on the memory module with the tab on the memory module connector.
- 2 Insert the memory module into the memory module slot.
- 3 Press the memory module firmly until the retention tabs click into place.

ⓘ NOTE: Do not pull the retention levers up. Always press down firmly on the module until the levers lock into place unassisted.

- 4 Install the:
 - a [air shroud](#)
 - b [side cover](#)
- 5 Follow the procedure in [After working inside your computer](#)

Expansion card

Removing the expansion card

- 1 Follow the procedure in [Before working inside your computer](#).
- 2 Remove the [side cover](#).
- 3 To remove the expansion card:

NOTE: For expansion card with VGA power, disconnect the data or power cable connected to the expansion card.

- a Press [1] and rotate the expansion card locking latch backward [2], to unlock the filler bracket.
- b Lift the expansion card [3] from the PCIe slot on the system board.



Installing the expansion card

- 1 Align and place the expansion card to the PCIe slot on the system board.
- 2 Press it down so that it is securely seated on the slot.

NOTE: For expansion card with VGA power, connect the data or power cable to the expansion card.

- 3 Rotate both the expansion card locking latch forward, on the filler bracket, to secure the expansion card to the system board.
- 4 Install the [side cover](#).

- 5 Follow the procedure in [After working inside your computer](#).

Coin cell battery

Removing the coin cell battery

- 1 Follow the procedure in [Before working inside your computer](#).
- 2 Remove the:
 - a [side cover](#)
- 3 To remove the coin cell battery:
 - a Press the release latch [1] away from the battery to allow the battery to pop-up from the socket [2].

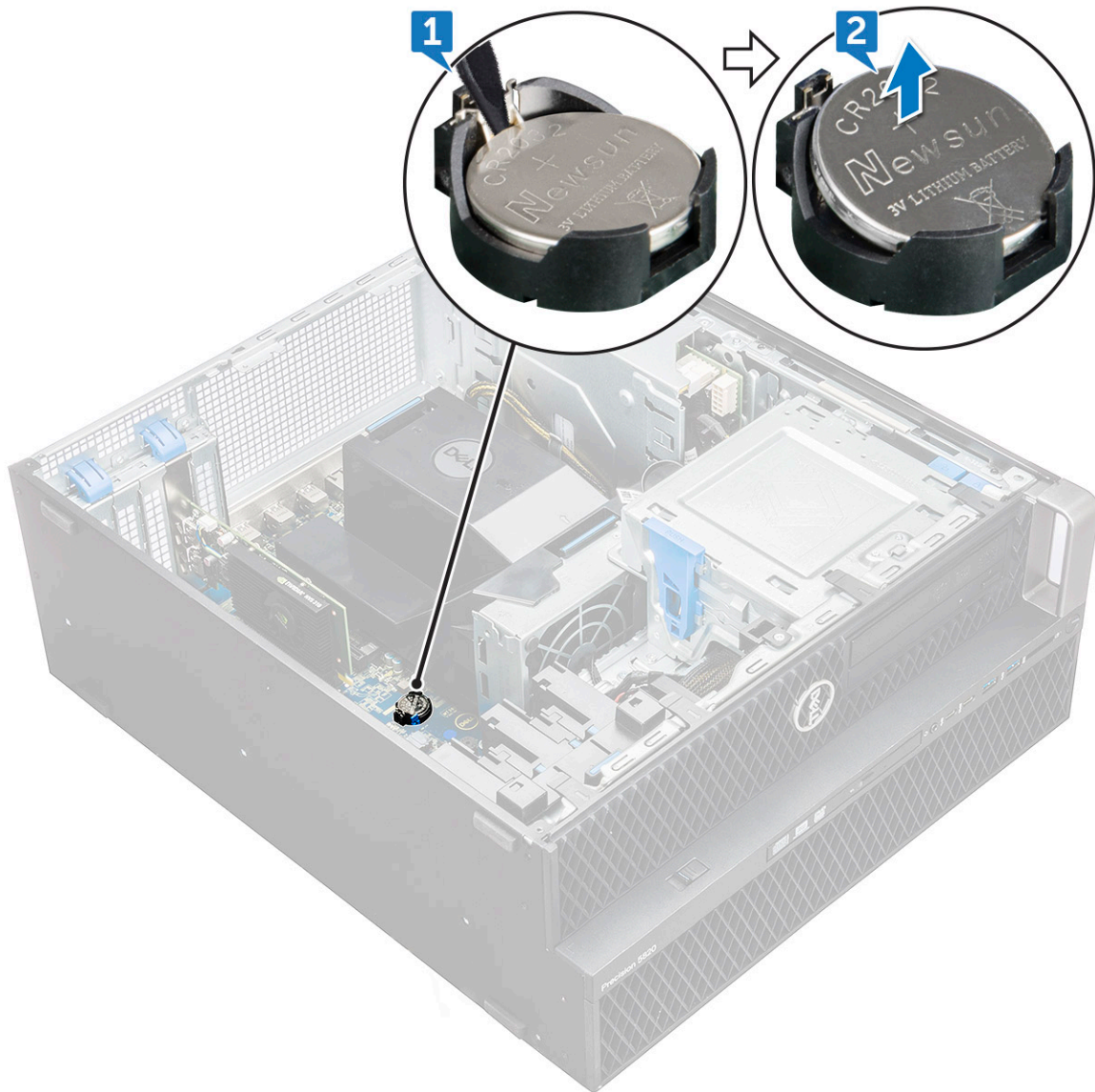

- b Lift the coin-cell battery out of the system board.

Installing the coin cell battery

- 1 Place the coin-cell battery into its slot on the system board.
- 2 Press the coin-cell battery with positive (+) side facing up until the release latch springs back into place and secures it to the system board.
- 3 To install:
 - a [side cover](#)
- 4 Follow the procedure in [After working inside your computer](#).

System fan

Removing the System fan

- 1 Follow the procedure in [Before working inside your computer](#) .
- 2 Remove the:
 - a [side cover](#)
 - b [air shroud](#)
 - c [front bezel](#)
 - d [ODD](#)
 - e [5.25 inch ODD bracket](#)
- 3 To remove the system fan:
 - a Press the connector tab and disconnect the two fan cables from the system board.

NOTE: Do not pull the connector by the cable wires. Instead, disconnect the cable by pulling on the connector end. Pulling on the cable wires may loosen them from the connector.

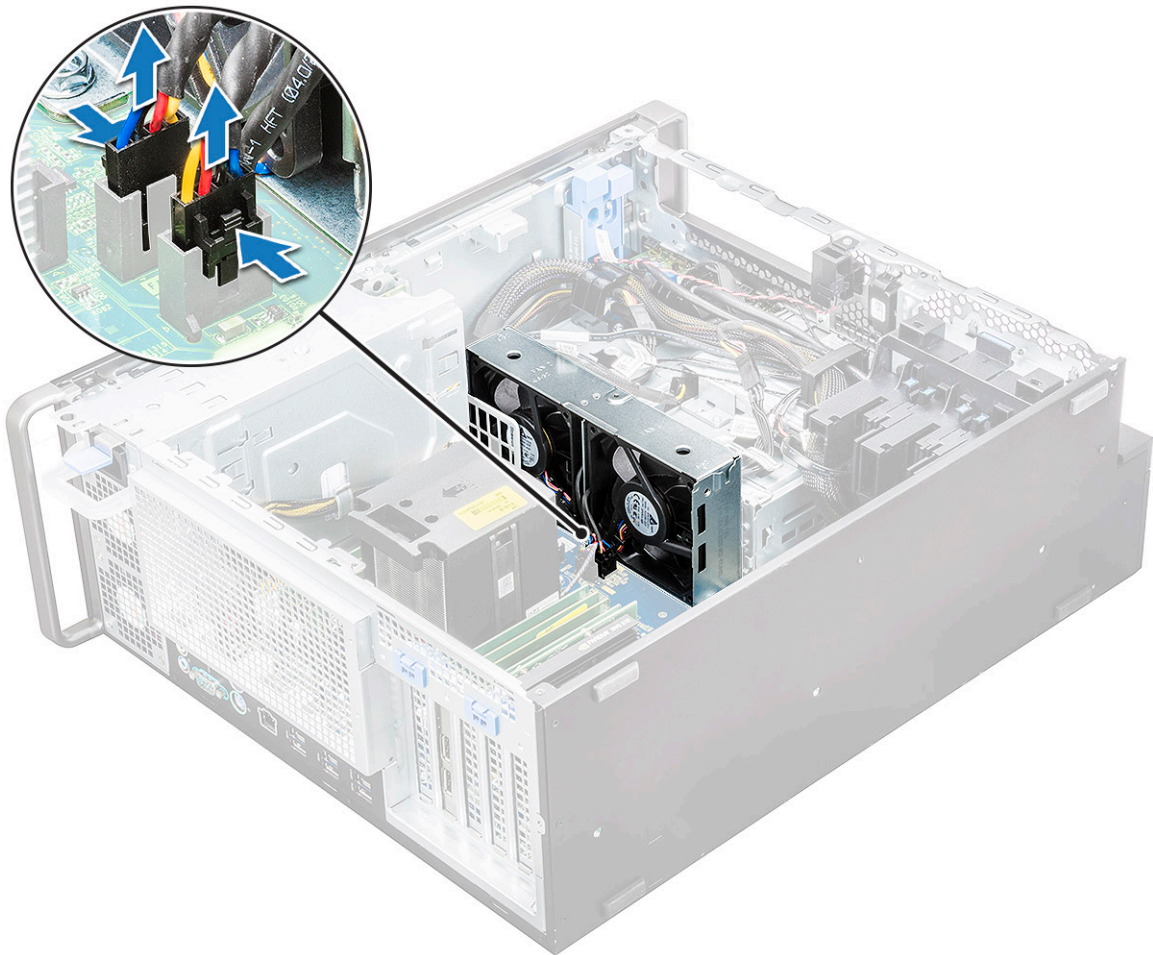

- b Remove the screws [1] securing the system fan to the system board and lift the system fan up [2] .

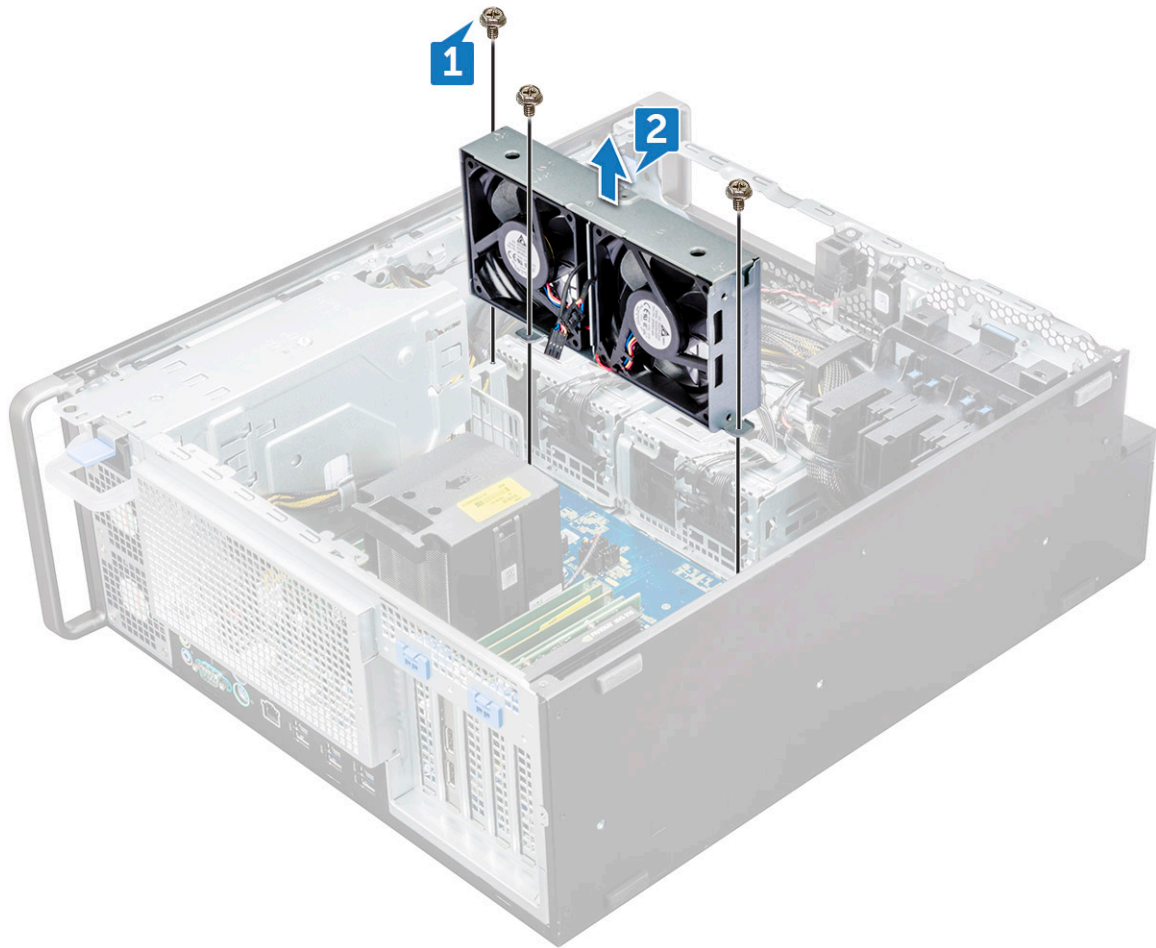

Installing the system fan

- 1 Align the system fan to its slot on the system board and secure it with the 3 screws.
- 2 Connect the fan cables to the slot on the system board.
- 3 Install the:
 - a [5.25 ODD bracket](#)
 - b [ODD](#)
 - c [front bezel](#)
 - d [air shroud](#)
 - e [side cover](#)
- 4 Follow the procedure in [After working inside your computer](#).

Fan bracket

Removing the fan from the fan bracket

- 1 Follow the procedure in [Before working inside your computer](#).
- 2 Remove the:
 - a [side cover](#)
 - b [system fan](#)

- 4 Follow the procedure in [After working inside your computer](#)

PCIe holder

Removing PCIe holder

- 1 Follow the procedure in [Before working inside your computer](#).
- 2 Remove the:
 - a [side cover](#)
 - b [expansion card](#)
- 3 To remove the PCIe holder:
 - a Press the PCIe holder securing clip [1] and slide the holder [2] out of the chassis.

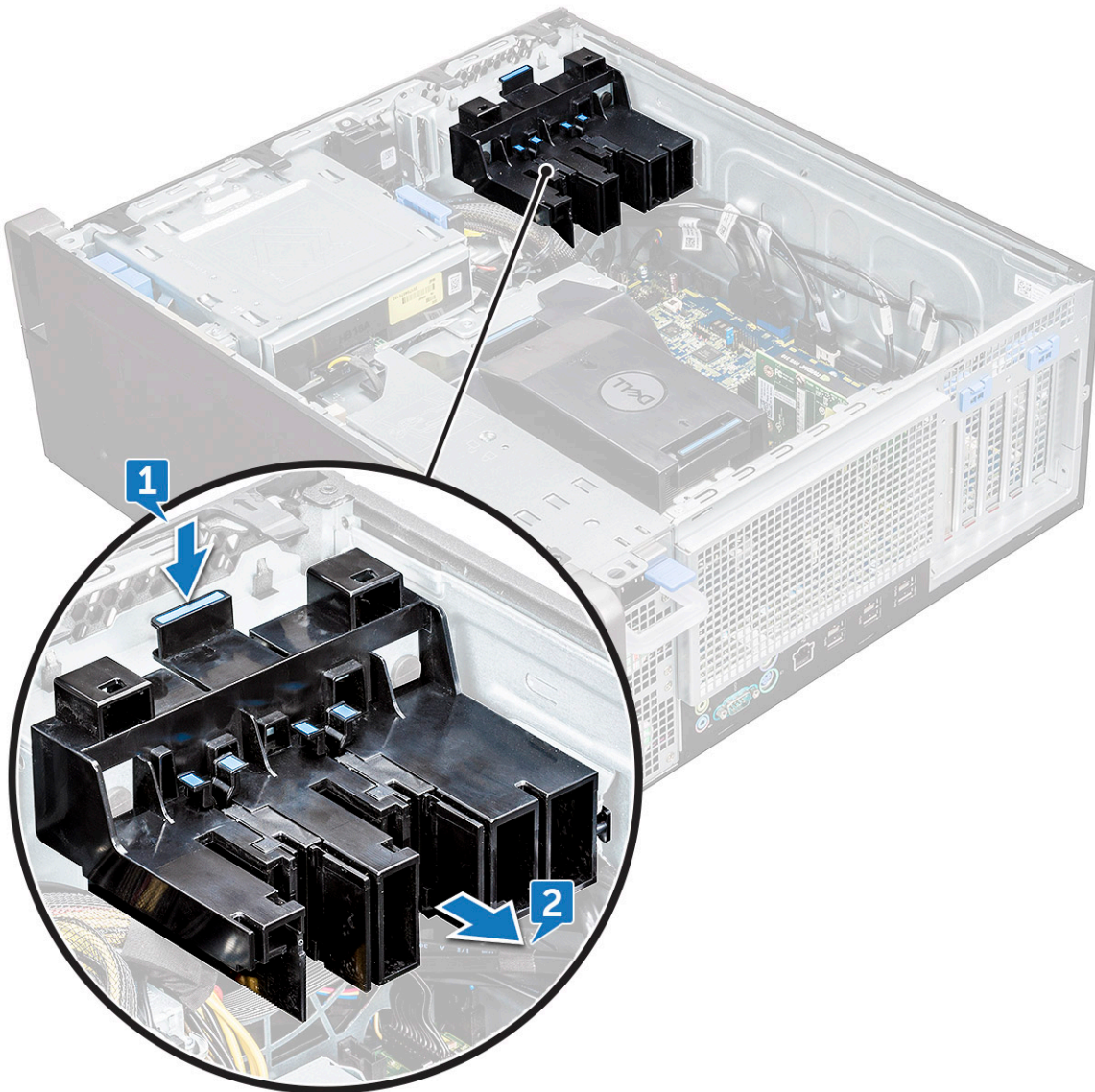

Installing the PCIe holder

- 1 Align and place the PCIe holder to the system chassis.
- 2 Press the holder back until it clicks to the system.
- 3 Install the:
 - a [side cover](#)
- 4 Follow the procedure in [After working inside your computer](#).

Heat sink and CPU fan assembly

Removing the heat sink and CPU fan assembly

- 1 Follow the procedure in [Before working inside your computer](#).
- 2 Remove the:
 - a [side cover](#)
 - b [air shroud](#)
- 3 To remove the heat sink and CPU fan assembly:
 - a Disconnect the CPU fan cable [1] from the system board.
 - b Loosen the four heat sink captive screws [2], in the diagonal order (4, 3, 2, 1).
 - c Gently lift the heat sink and CPU fan assembly [3] from the system.

 **NOTE:** Lay the assembly with the thermal grease facing up.

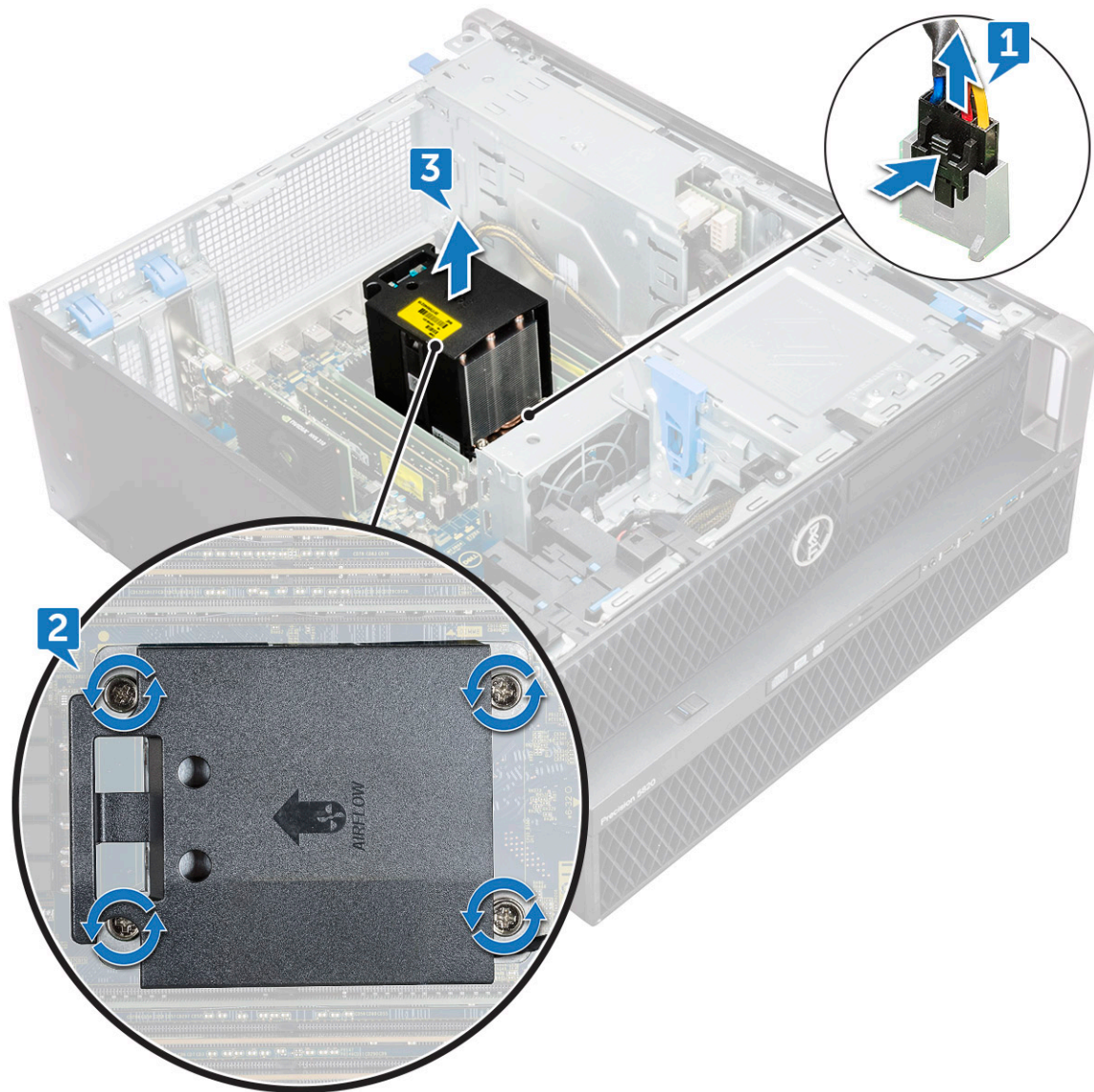

Installing heat sink and CPU fan assembly

- 1 Place the heat sink and CPU fan assembly on the CPU slot.
- 2 Replace the four screws in the diagonal order (1,2,3,4), to secure the heat sink and CPU fan assembly to the system board.

NOTE: When installing the heat sink and CPU fan assembly into the system ensure that the airflow arrow is pointed towards the rear of the system.

- 3 Connect the CPU fan cable to the system board.
- 4 Install the:
 - a air shroud
 - b side cover
- 5 Follow the procedure in [After working inside your computer](#).

Removing the CPU fan

- 1 Follow the procedure in [Before working inside your computer](#).
- 2 Remove the:
 - a [side cover](#)
 - b [air shroud](#)
 - c [heat sink and CPU fan assembly](#)
- 3 To remove the CPU fan:
 - a Unroute the CPU fan cable from the cable holder in the bracket.

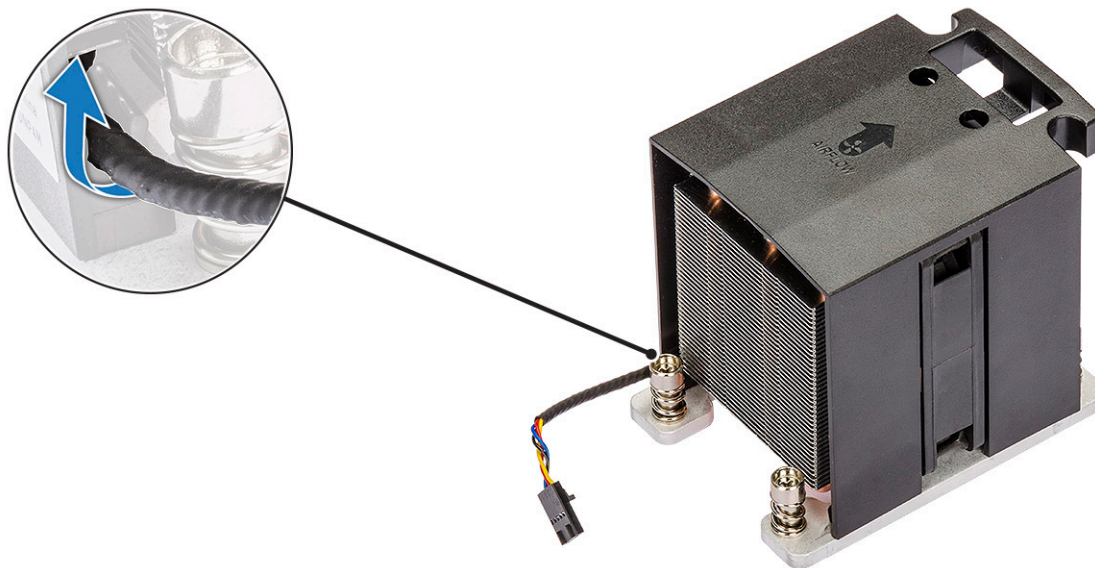

- b Lay the assembly with the thermal grease facing up.
- c Remove the four screws [1] securing the heat sink and the CPU fan assembly.
- d Gently lift the heat sink [2] away from the CPU fan.

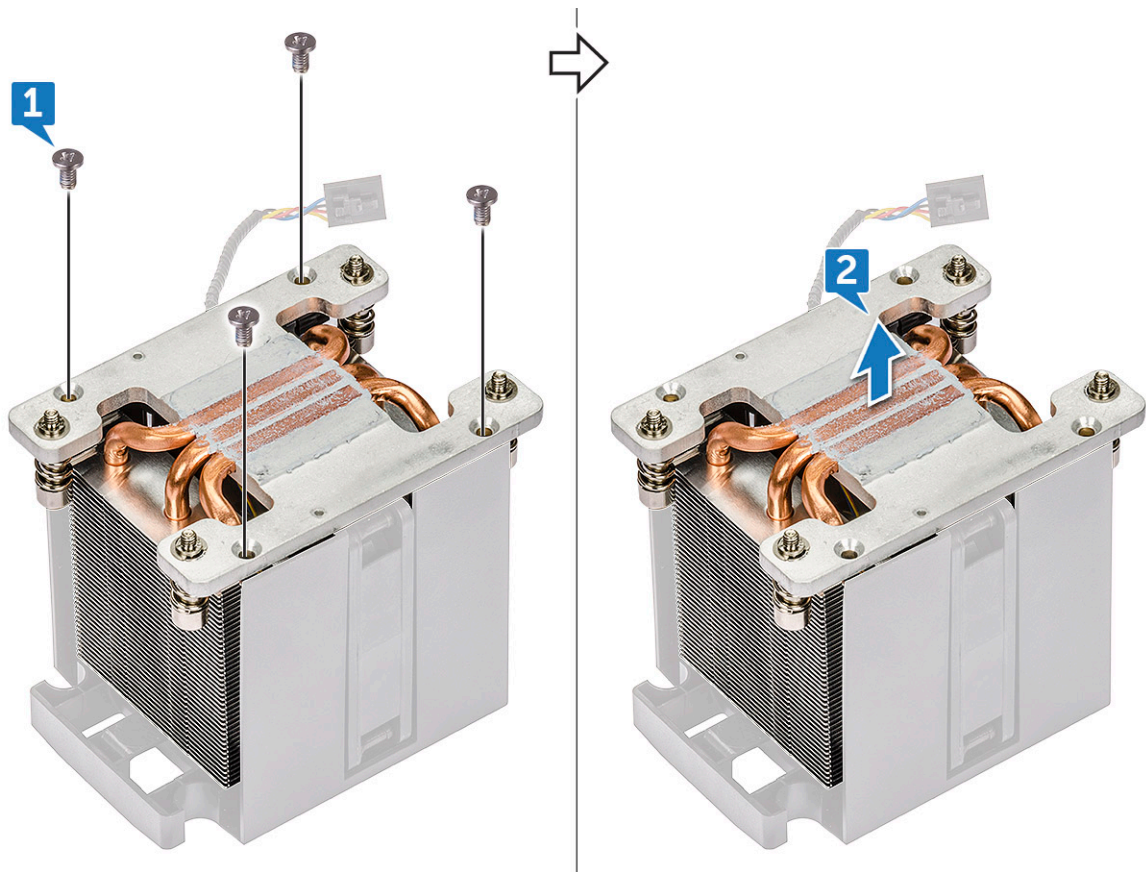

e Detach the 4 rubber grommets [1] from the CPU fan bracket and lift the fan [2] away from the bracket.

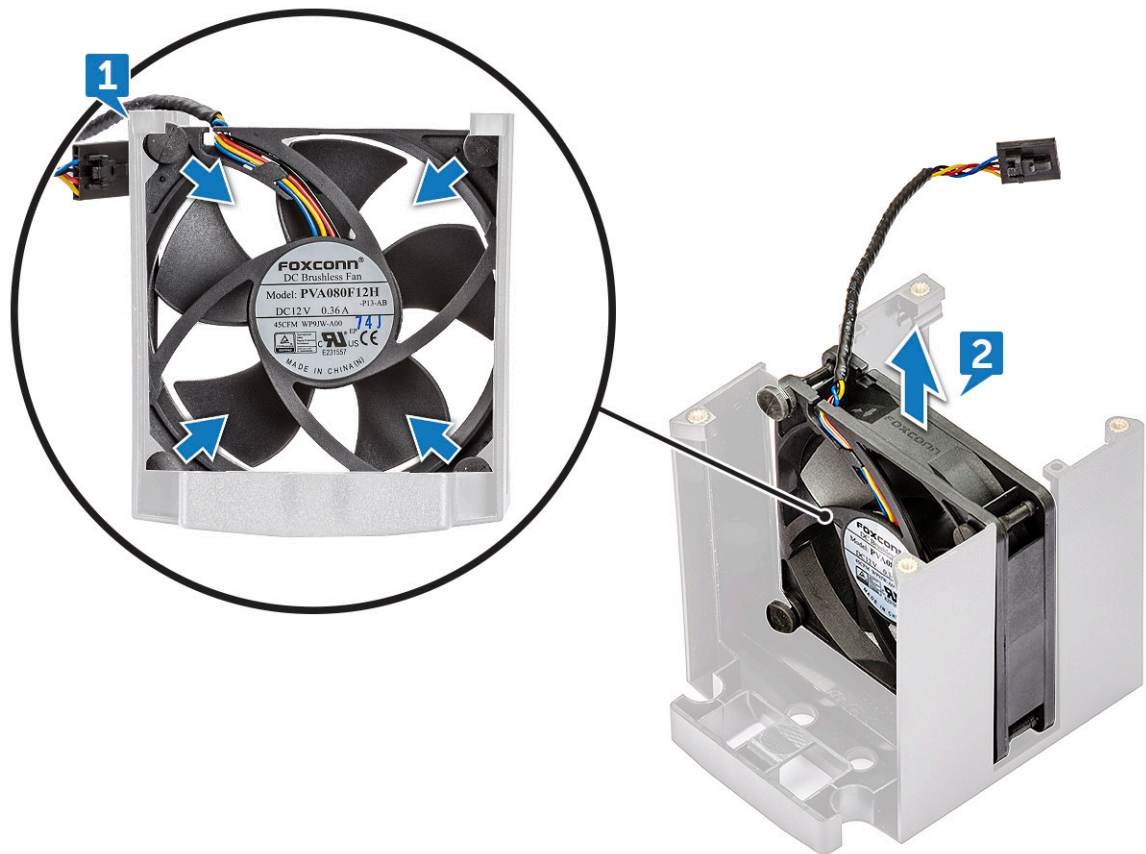



Installing the CPU fan

- 1 Attach the four rubber grommets of the CPU fan to the fan bracket.
- 2 Place the CPU fan to its position on the heat sink.
- 3 Route the fan cable to its holder in the fan bracket.
- 4 Replace the 4 screws securing the heat sink and the CPU fan.
- 5 Install the:
 - a [heat sink and CPU fan assembly](#)
 - b [air shroud](#)
 - c [side cover](#)
- 6 Follow the procedure in [After working inside your computer](#).

Processor

Removing the processor

- 1 Follow the procedure in [Before working inside your computer](#).
- 2 Remove the:
 - a [side cover](#)
 - b [air shroud](#)
 - c [heat sink and CPU fan assembly](#)
- 3 To remove the processor:
 - a Press the left side release lever [1] down, then move it inward to release it from the retention hook.
 - b Press the right side release lever [2] down, then move it inward to release it from the retention hook.
 - c Open the release lever [3, 4] to unlock the processor cover.
 - d Raise the processor cover [5].
 - e Lift the processor [6] to remove it from the socket and place it into anti-static packaging.

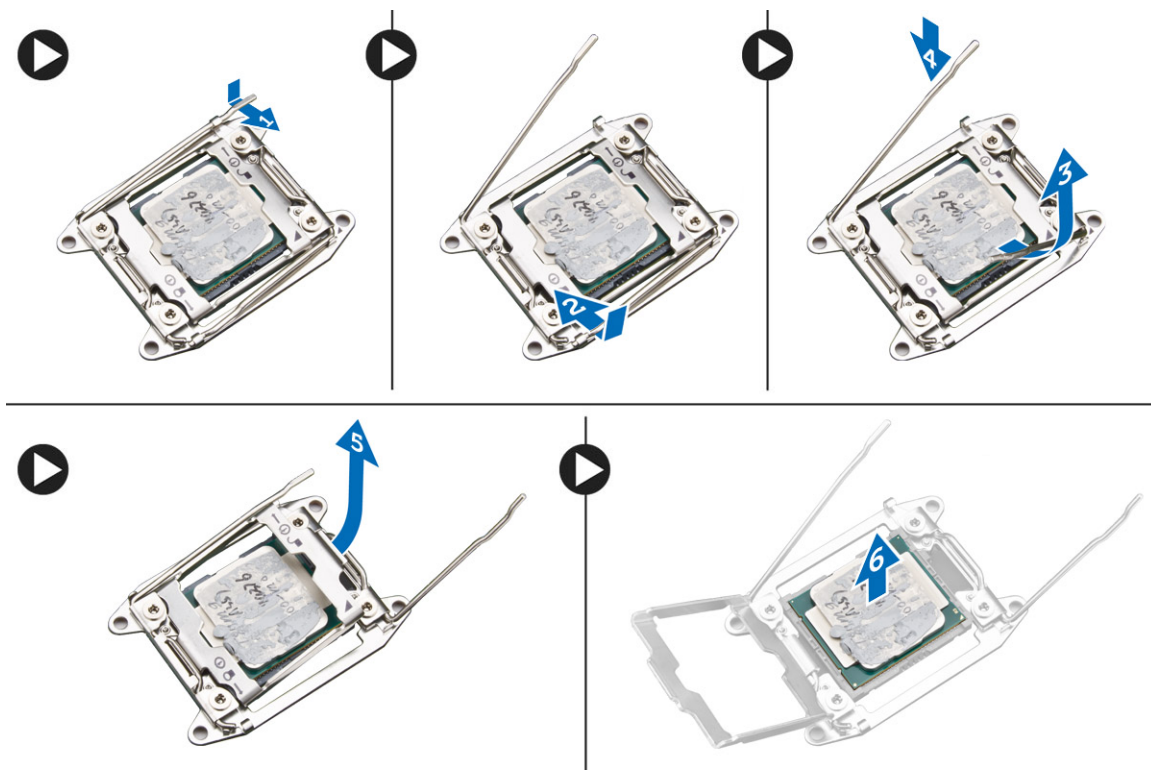

Installing the processor

- 1 Insert the processor into the processor socket. Make sure the processor is properly seated.
- 2 Gently lower the processor cover.
- 3 Press the two release levers down and then move it in to secure it with the retention hook.
- 4 Install the:
 - a [heat sink and CPU fan assembly](#)
 - b [air shroud](#)
 - c [side cover](#)
- 5 Follow the procedure in [After working inside your computer](#).

Front system fan

Removing the front system fan

- 1 Follow the procedure in [Before working inside your computer](#).
- 2 Remove the:
 - a [side cover](#)
 - b [front bezel](#)
 - c [PCIe holder](#)
- 3 To remove the front system fan:
 - a Unroute the following cables from the card holder [3]:
 - SATA 0,1, 2, 3, 4, 5 cable and ODD 0, 1 cable [1]
 - USB 3.1 cable [2]

NOTE: Do not pull the connector by the cable wires. Instead, disconnect the cable by pulling the connector end. Pulling the cable wires may loosen them from the connector.

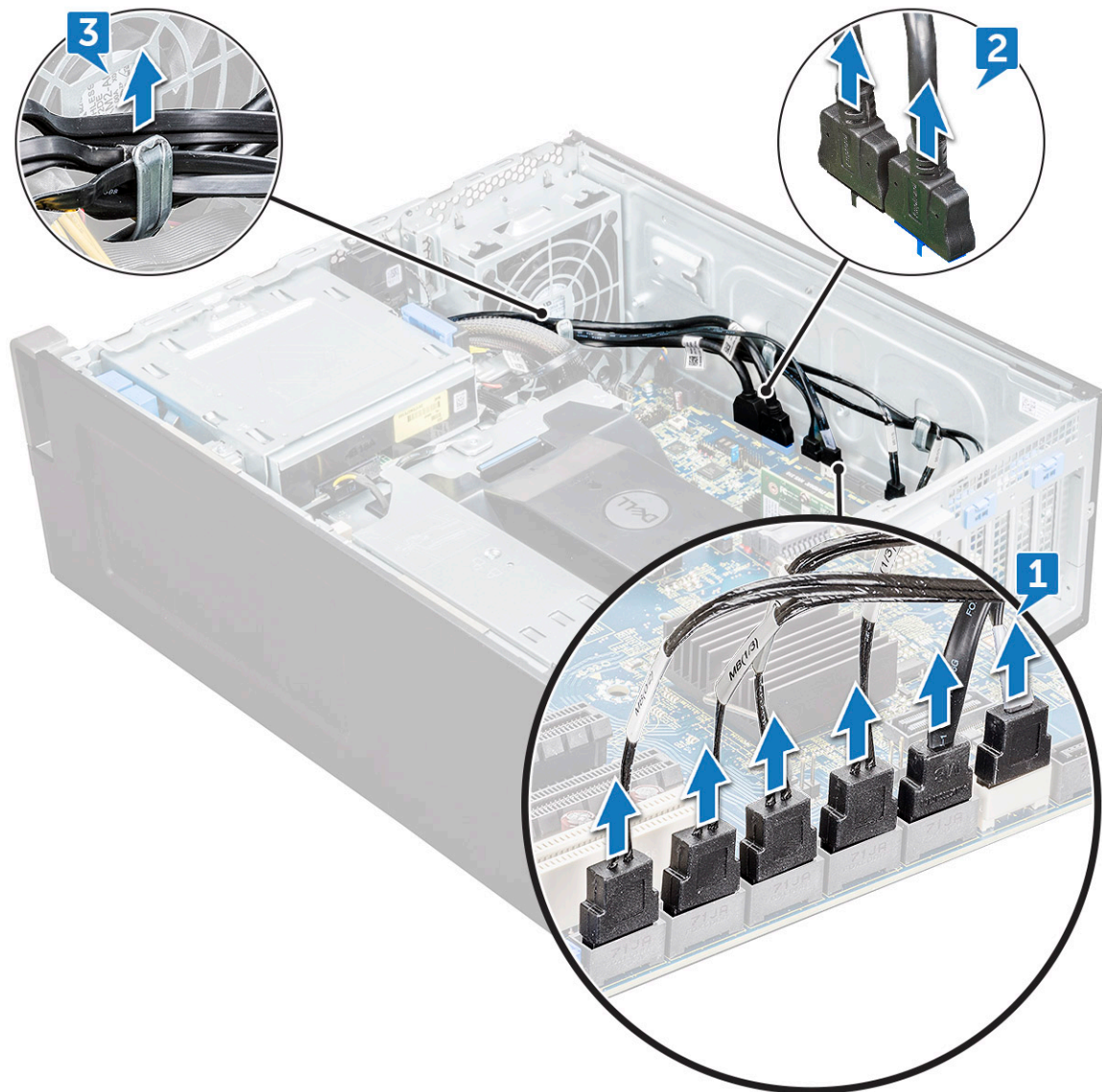

- b Unroute the fan cable [1] from the system board.
- c Remove the screw [2] that secure the rear system fan to the chassis.
- d Lift the fan to release it from the retention slot in the system chassis [3].

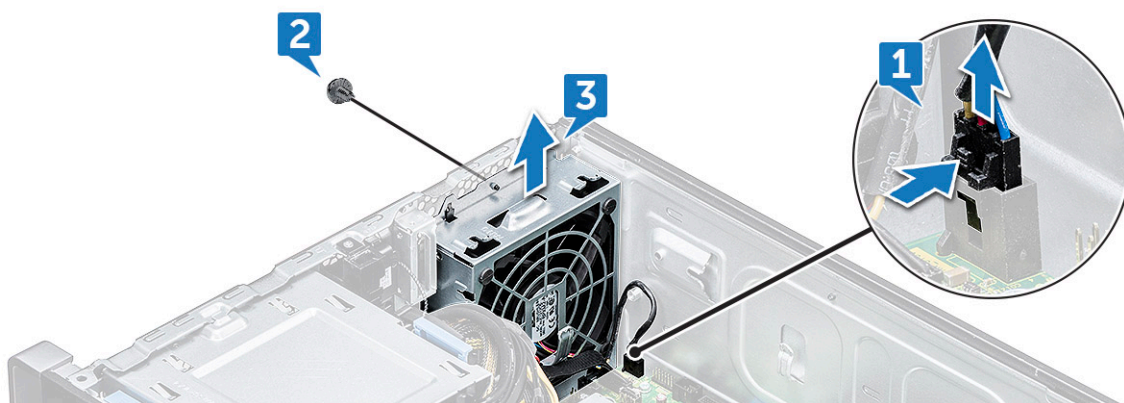

Installing the front system fan

- 1 Align the front system fan to its retention slot in the system chassis.
- 2 Replace the screw that secures the front system fan to the chassis.
- 3 Connect the fan cable to the system board.
- 4 Route the following cables through the cable holder and connect to the system board:
 - SATA and ODD cables
 - USB 3.1 cable
- 5 Install the:
 - a [PCIe holder](#)
 - b [front bezel](#)
 - c [side cover](#)
- 6 Follow the procedure in [After working inside your computer](#).

System board

Removing system board

- 1 Follow the procedure in [Before working inside your computer](#).
- 2 Remove the:
 - a [side cover](#)
 - b [air shroud](#)
 - c [expansion card](#)
 - d [memory module](#)
 - e [heat sink and CPU fan assembly](#)
 - f [front bezel](#)
 - g [ODD](#)
 - h [5.25 ODD bracket](#)
 - i [system fan](#)
 - j [PCIe card holder](#)
- 3 To remove the system board:
 - a To remove the system fan fixed bracket, remove the screw [1] that secure the fixed bracket to the system board.
 - b Lift the system fan fixed bracket from the system board [2].



c Disconnect the following cables from the system board connectors:

- audio cable [1]
- power cable [2]
- cable holder [3]
- power control cable [4]
- 24 Pin power cable [5]
- front I/O panel [6]

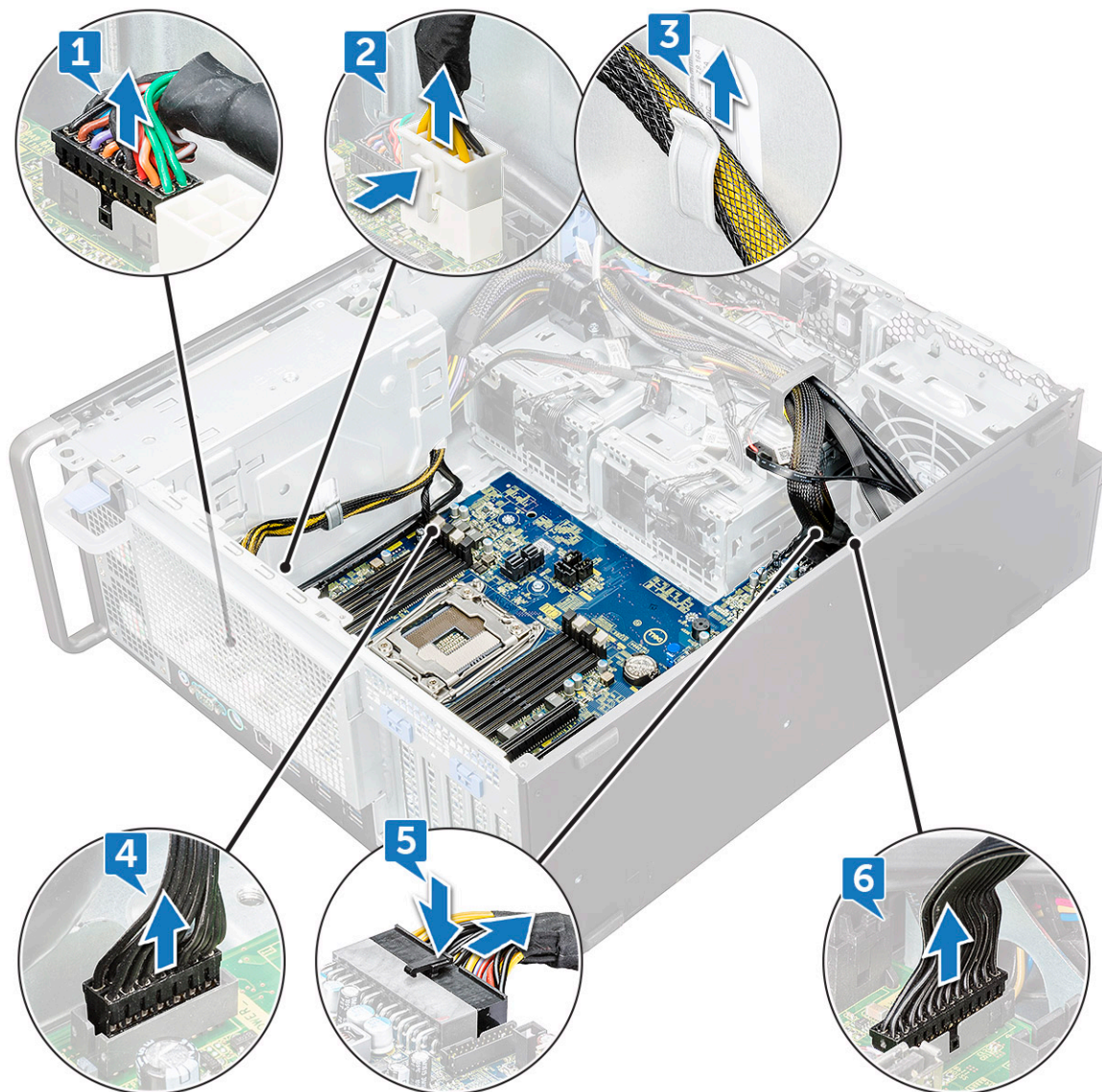

- d Disconnect the following cables:
- SATA cables and ODD cables [1]
 - USB 3.1 cable [2]
 - Front system fan cable
 - Flex0 and Flex1 hard drive data cable

NOTE: Do not pull the connector by the cable wires . Instead, disconnect the cable by pulling on the connector end. Pulling on the cable wires may loosen them from the connector.

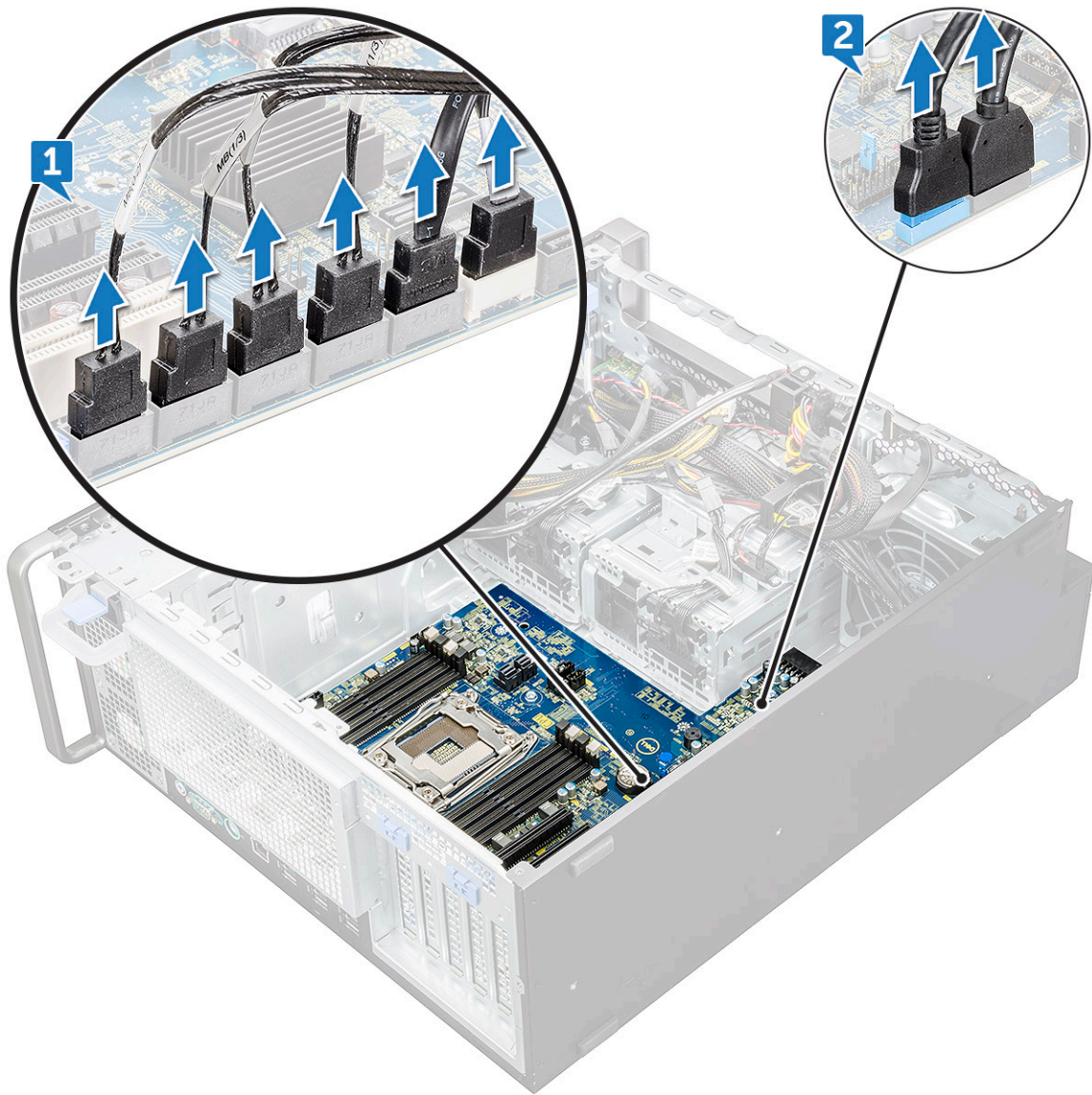

- e Remove the screws that secure the system board to the chassis.

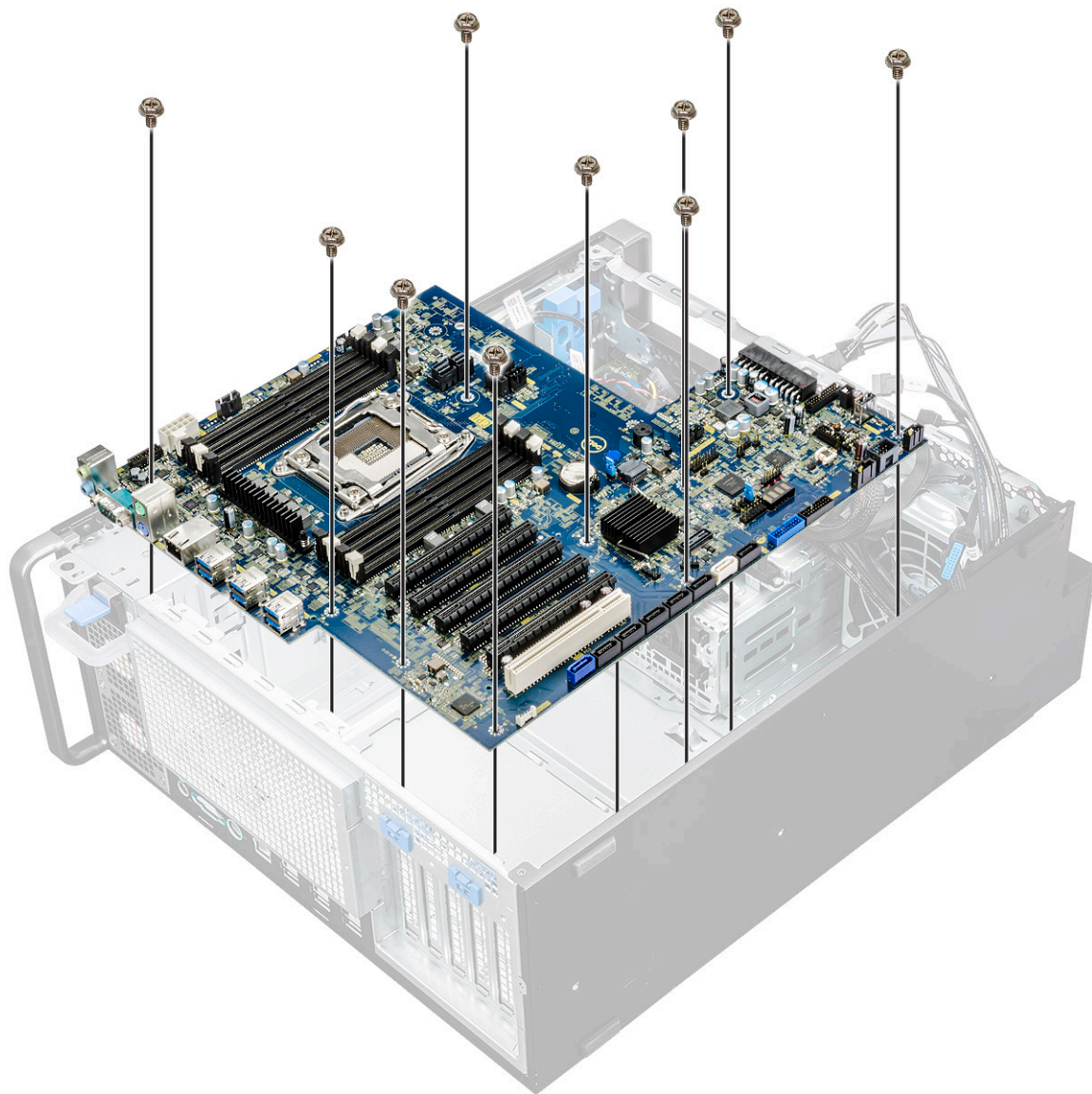

f Slide the system board towards HDD bracket module to detach it from the system.

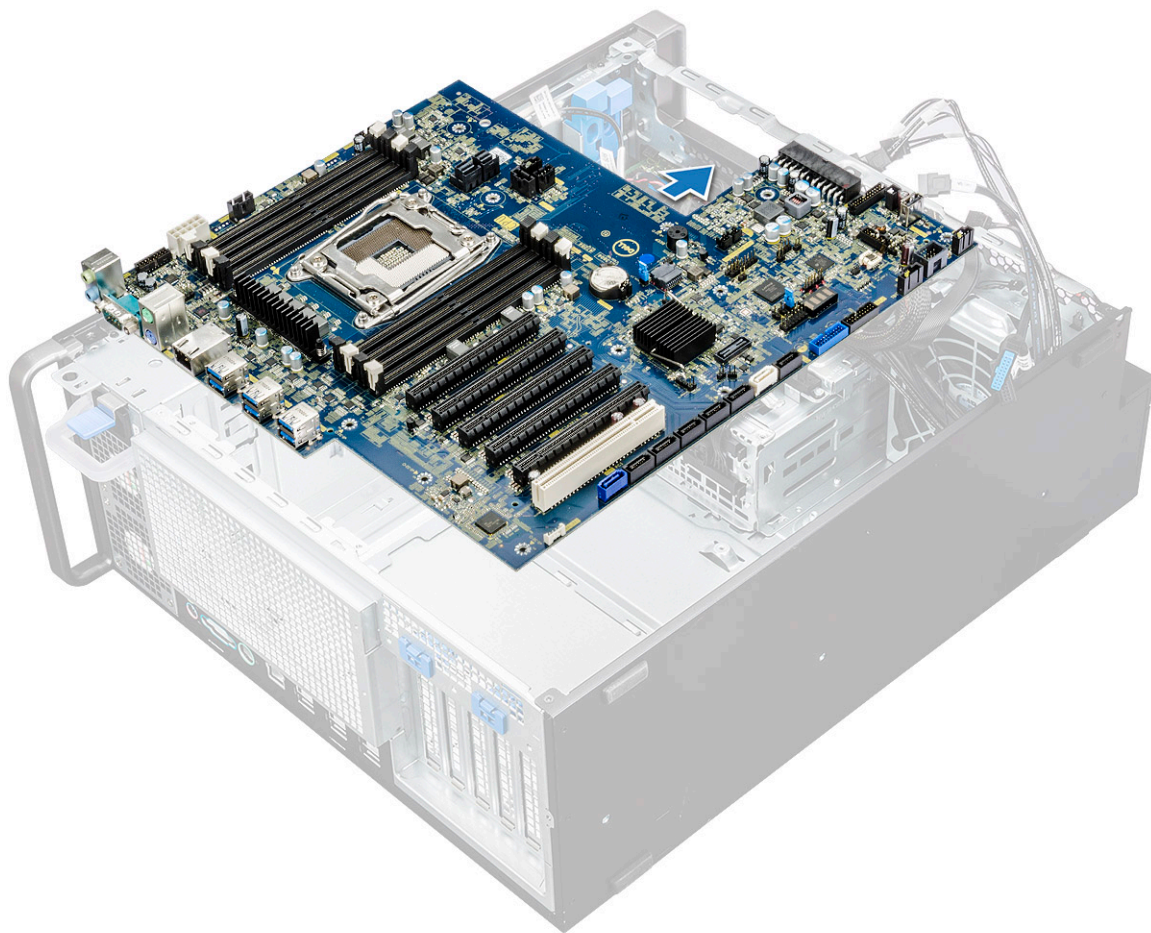

g Lift the system board up to remove it from the chassis.



Installing the system board

- 1 Align and place the system board into the chassis.
- 2 Slide the system board to its position.
- 3 Replace the screws to secure the system board to the chassis.
- 4 Place the system fan fixed bracket and replace the single screw on the system board.
- 5 Connect the following cables:
 - audio cable
 - power cable
 - power control cable
 - 24Pin power cable
 - front I/O panel
 - SATA cables
 - ODD cables
 - USB 3.1 cables
 - Front system fan cable
 - Flex0 and Flex1 hard drive data cable
- 6 Install the:
 - a [PCIe holder](#)
 - b [expansion card](#)
 - c [memory module](#)

- d heat sink and CPU fan assembly
- e system fan
- f air shroud
- g 5.25 ODD bracket
- h ODD
- i front bezel
- j side cover

7 Follow the procedure in [After working inside your computer.](#)

System board components

The following image displays the system board components.

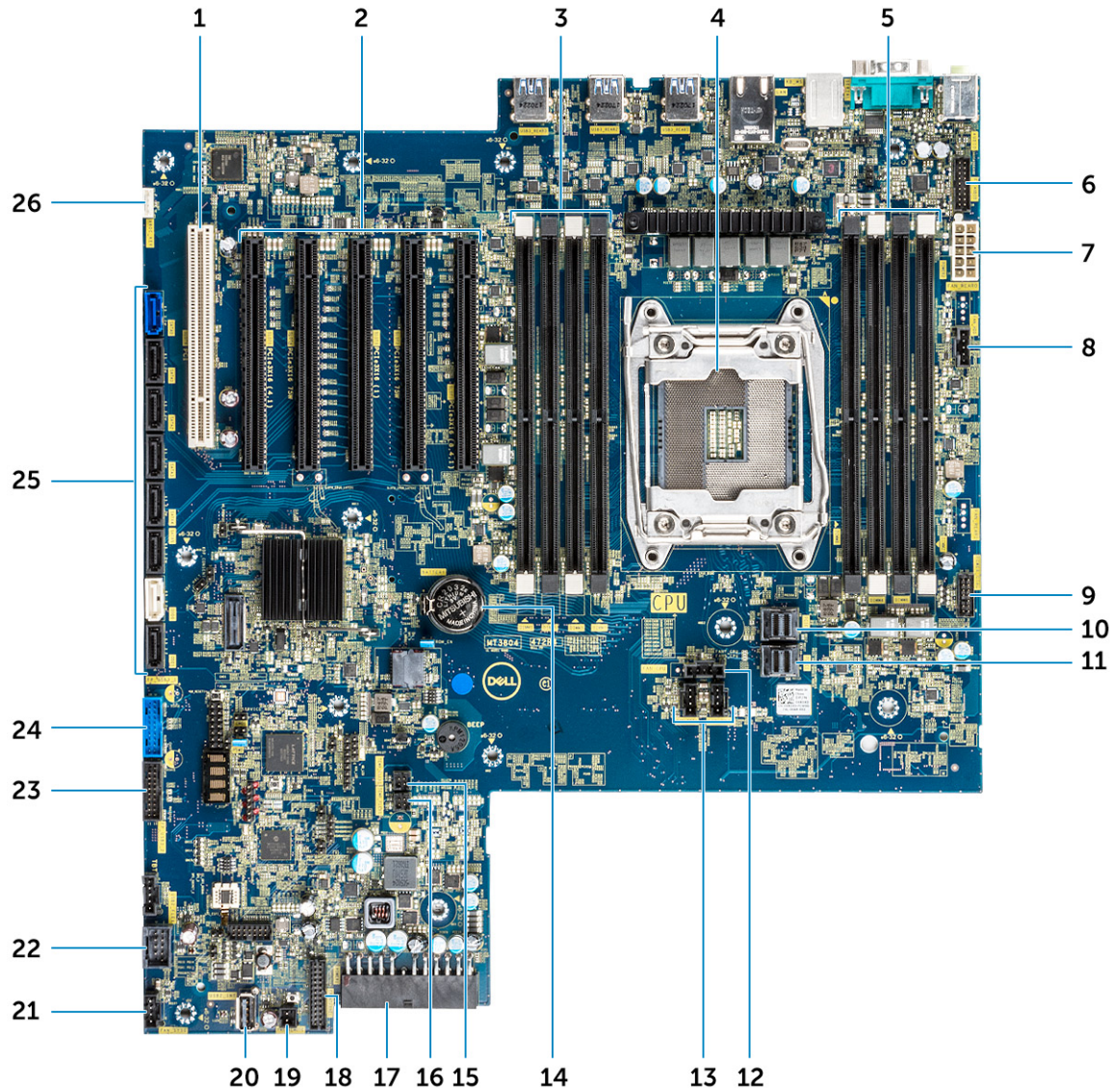

- | | |
|------------------|--------------------------|
| 1 Slot 6 PCI | 2 Slot PCI 3x16 |
| 3 Memory slots | 4 CPU0 |
| 5 Memory slots | 6 Front panel audio port |
| 7 Power CPU port | 8 System fan port |



9	Power control port	10	PCIE0
11	PCIE1	12	CPU fan port
13	System fan port	14	Coin cell battery
15	FLEX0 thermal sensor	16	FLEX1 thermal sensor
17	24 pin power cable	18	Front panel port
19	Power remote	20	USB 2_INT
21	System fan 0	22	USB 2_flex
23	Front panel USB3.2 port	24	Front panel USB3.1 port
25	SATA 0, 1, 2, 3, 4, 5 and ODD 0, 1 ports	26	VROC_key



Technology and components

This chapter details the technology and components available in the system.

Topics:

- [Memory configuration](#)
- [Technologies list](#)
- [Teradici PCoIP](#)
- [MegaRAID 9440-8i and 9460-16i controller](#)
- [Expansion card installation guidelines](#)

Memory configuration

This section provides information about the memory configuration for the Dell Precision Tower 5820 systems.

The following table illustrates the memory configuration and population rules for the Dell Precision Tower 5820:

Main Memory 1LM (Main memory only)				CPU0							
				iMC1				iMC0			
Config	Total (GB)	DPC	Frequency	Ch3		Ch2		Ch0		Ch1	
				0	1	0	1	1	0	1	0
				DIMM2	DIMM6	DIMM4	DIMM8	DIMM7	DIMM3	DIMM5	DIMM1
S8R	8	1DPC	2667								8
S16R	16	1DPC	2667	8							8
S32R	32	1DPC	2667	8		8			8		8
S64R	64	1DPC	2667	8	8	8	8	8	8	8	8
S32Rb	32	1DPC	2667	16							16
S64R	64	1DPC	2667	16		16			16		16
S128R	128	1DPC	2667	16	16	16	16	16	16	16	16
S128R	128	1DPC	2667	32		32			32		32
S192R	192	1DPC	2667	32	32	32			32	32	32
S192R	192	1DPC	2667	32	16	32	16	16	32	16	32
S256R	256	1DPC	2667	32	32	32	32	32	32	32	32

Technologies list

This section provides information about the technologies that comes with the Dell Precision 5820 Tower.

The following table lists the basic of technologies that are available on the Dell Precision5820 Tower systems for Dell internal users only.

Table 2. Technologies list

No.	Category	Technology	Browser Path
1	Chipset	Intel C422 (Kaby Lake-W)	
2	Processor	<ul style="list-style-type: none"> • Intel Xeon Processor W family • Up to 140 W, Single CPU 	
3	Memory	DDR4	
4	Audio	Integrated Realtek ALC3234 High Definition Audio Codec (2 Channel)	
5	Network	NIC Integrated RJ45	



No.	Category	Technology	Browser Path
6	Graphics	Radeon Pro WX	<ul style="list-style-type: none"> 9100 7100 5100 4100 3100 2100
		NVIDIA	<ul style="list-style-type: none"> Quadro GP100 Quadro P6000 Quadro P5000 Quadro P4000 Quadro P2000 Quadro P1000 Quadro P600 Quadro P400 NVS 310 NVS 315
7	Storage	SATA	
		SAS	
		Dell UltraSpeed Quad (PCIe M.2 Interposer)	
		Dell UltraSpeed Duo (PCIe M.2 Interposer)	
9	Remote Solutions	1-1 Teradici PCoIP	<ul style="list-style-type: none"> CLIENT: Dell or other Branded Zero Client (TERA Gen 2) (Dell-Wyse P25) DUAL Monitor Support HOST: PCIe x1 PCoIP Dual Host Card (TERA Gen 2) CLIENT: Dell or other Branded Zero Client (TERA Gen 2) (Dell-Wyse P45) QUAD Monitor Support HOST: PCIe x1 PCoIP Quad Host Card (TERA Gen 2) Support Dual Terra Card configurations

NOTE: For further information about the Teradici PCoIP Card host driver installation, see [Teradici PCoIP](#).

Teradici PCoIP

This section provides an overview of the host driver installation process.

Installing the Teradici PCoIP Card Host Dual/Quad

Install the PCoIP host driver software from dell.com/support.

NOTE: You cannot upgrade the PCoIP host driver software while a VMware View-brokered PCoIP session is active between a host workstation or host PC and VMware View client. Doing this will result in losing access to your mouse and keyboard when the driver software is removed.

To upgrade the PCoIP host driver software in this type of deployment, do one of the following:

- Connect to the host from a zero client.
- Upgrade the software while connecting to the host through another desktop-remoting protocol such as RDP or VNC.

Installing the PCoIP Host Driver Software on a Host PC:

- 1 Download the PCoIP host driver software from the Teradici Support site (click Current PCoIP Product and Releases).
- 2 Log in to the administrative web interface for the host card.
- 3 From the **Configuration > Host Driver Function** menu, enable the Host Driver Function.
- 4 Restart the host PC.
- 5 Install the PCoIP host software package appropriate for the operating system installed on the host PC. You can start the install process by double-clicking the installer:
 - a 64 bit: PCoipHostSoftware_x64-v4.3.0.msi (or later)
- 6 When the Welcome screen appears, click **Next**.
- 7 Accept the terms, and then click **Next**.
- 8 Ensure that the installation location is correct, and click **Next**.
- 9 Click **Install**.

NOTE:

For Windows 7, when the driver is installed, a Windows Security dialog may appear. Click **Install** to continue with the installation. To keep this dialog box from appearing in the future, select **Always trust software from Teradici Corporation**.

- 10 If prompted, restart the operating system; otherwise, skip this step. When restarted, the host driver software installation process continues when the OS boots up. Click **Install** to continue.
- 11 Click **Finish** to complete the installation.

MegaRAID 9440-8i and 9460-16i controller

Small and medium businesses (SMBs) deploying entry-level server platforms and workstations need affordable, reliable storage solutions. The MegaRAID Tri-Mode Storage Adapter is a 12Gb/s SAS/SATA/PCIe (NVMe) controller card that addresses these needs by delivering proven performance and RAID data protection for a range of non-business critical applications. The MegaRAID Tri-Mode storage adapters bring NVMe performance benefits to the storage tier by providing connectivity and data protection for SAS/SATA interfaces. Based on the dual-core SAS3516 or SAS3508 RAID on Chip (ROC) and 72-bit DDR4-2133 SDRAM, these controllers provide bandwidth and IOPS performance increases and are ideal for high-end servers utilizing internal storage or connecting to large-scale external storage enclosures.

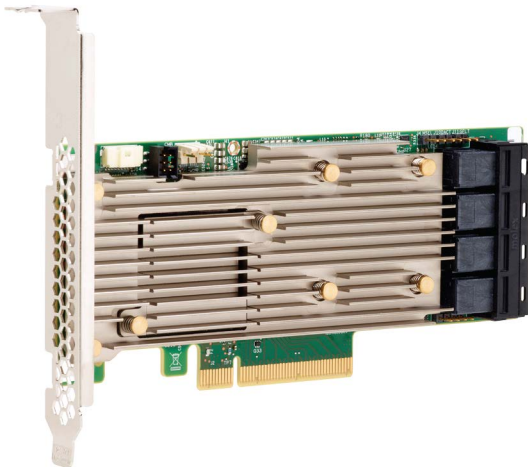

Tri-Mode SerDes Technology enables operation of NVMe, SAS, or SATA storage devices in a single drive bay. All the 3 modes concurrently serving NVMe, SAS, and SATA drives can be operated by a single controller. The controller negotiates between the speeds and protocols to seamlessly work with any of the three types of storage devices. Tri-Mode support provides a non-disruptive way to evolve existing data center infrastructure. By upgrading to a tri-mode controller, users can expand beyond SAS/SATA and use NVMe without major changes to other system configurations. The MegaRAID Tri-Mode storage adapters support both REFCLK and SRIS based NVMe x1, x2, and x4 devices.



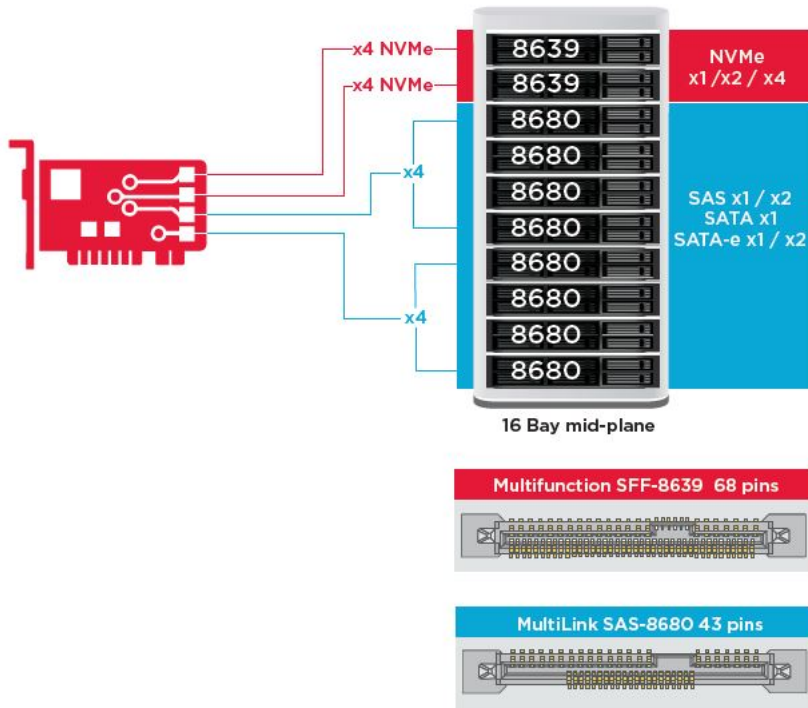

Key Features:

- Tri-Mode SerDes Technology enables the operation of NVMe, SAS or SATA devices in a single drive bay, allowing for endless design flexibility
- Supports 12, 6, and 3 Gb/s SAS and 6, 3 Gb/s SATA data transfer rates
- Up to 8 PCIe links. Each link supporting x4, x2, or x1 link widths, supporting 8.0 GT/s (PCIe Gen3) per lane
- SFF-9402 Compliant, Connector Pin-out
- SFF-8485 Compliant, SGPIO
- Fits into rack-mounted servers with low-profile form factor and side-mounted SAS connectors
- Support critical, high-bandwidth applications with PCIe 3.1 connectivity
- CacheVault flash back-up at power fail. Supports bad block management
- Balance protection and performance for critical applications with RAID levels 0, 1, 5, 6, 10, 50, and 60

Table 3. Features of MegaRAID 9440-8i and 9460-16i controller

	9440-8i	9460-16i
Ports	8 internal	16 internal
Connectors	2 x SFF8643	4 x SFF8643 x4
Storage Interface Support	SATA: Eight x1 SAS: One x8, Two x4, Four x2, Eight x1 NVMe: Two x4, Four x2, Four x1	SATA: Sixteen x1 SAS: Two x8, Four x4, Eight x2, Sixteen x1 NVMe: Four x4, Eight x2, Eight x1
Max Devices Per Controller	SAS/SATA: 64 NVMe: 4	SAS/SATA: 240 NVMe: 24
Cache Memory	N/A	4 GB 2133 MHz DDR4 SDRAM

	9440-8i	9460-16i
I/O Processor / SAS Controller	SAS3408	SAS3516
Host Bus Type	PCIe 3.1 x8	PCIe 3.1 x8
Cache Protection	N/A	CacheVault CVPM05
Physical Dimensions	6.127" x 2.712" (155.65 mm x 68.90 mm)	6.127" x 2.712" (155.65 mm x 68.90 mm)
Maximum Operating Conditions	Operating: 10°C to 55°C 20 to 80% non-condensing Airflow: 300 LFM Storage: -45°C to 105°C 5 to 90% non-condensing	Operating: 10°C to 55°C 20 to 80% non-condensing Airflow: 300 LFM Storage: -45°C to 105°C 5 to 90% non-condensing
MTBF (Calculated)	>3,000,000 hours at 40C	>3,000,000 hours at 40C
Operating Voltage	+12V +/-8%; 3.3V +/-9%	+12V +/-8%; 3.3V +/-9%
Hardware Warranty	3 years; with advanced replacement option	3 years; with advanced replacement option
MegaRAID Management Suite	LSI Storage Authority (LSA) StorCLI (command-line interface), CTRL-R (BIOS configuration utility), HII (UEFI Human Interface Infrastructure)	LSI Storage Authority (LSA) StorCLI (command-line interface), CTRL-R (BIOS configuration utility), HII (UEFI Human Interface Infrastructure)
Regulatory Certifications	USA (FCC 47 CFR part 15 Subpart B, class B); Canada (ICES -003, Class B); Taiwan (CNS 13438); Japan (VCCI V-3); Australia/New Zealand (AS/NZS CISPR 22); Korea (RRA no 2013-24 & 25); Europe (EN55022/EN55024); Safety: EN/IEC/UL 60950; RoHS; WEEE	USA (FCC 47 CFR part 15 Subpart B, class B); Canada (ICES -003, Class B); Taiwan (CNS 13438); Japan (VCCI V-3); Australia/New Zealand (AS/NZS CISPR 22); Korea (RRA no 2013-24 & 25); Europe (EN55022/EN55024); Safety: EN/IEC/UL 60950; RoHS; WEEE
OS Support	Microsoft Windows, VMware vSphere/ESXi, Red Hat Linux, SuSe Linux, Ubuntu Linux, Oracle Linux, CentOS Linux, Debian Linux, Fedora, and FreeBSD. Contact Oracle support for Oracle Solaris driver or software support.	Microsoft Windows, VMware vSphere/ESXi, Red Hat Linux, SuSe Linux, Ubuntu Linux, Oracle Linux, CentOS Linux, Debian Linux, Fedora, and FreeBSD. Contact Oracle support for Oracle Solaris driver or software support.

Expansion card installation guidelines

Depending on your system configuration, the following PCI Express(PCIe)generation 3 expansion cards are supported:



Table 4. Expansion card riser specifications

Expansion card riser	PCIe slots on the riser	Processor connection	Height	Length	Link	Slot width
Riser 1C	Slot 1	Processor 1	Full Height	Full Height	x16	x16
Riser 1C	Slot 2	Processor 1	Full Height	Full Height	x8	x16
Riser 1C	Slot 3	Processor 1	Full Height	Full Height	x8	x16
Riser 2A	Slot 4	Processor 2	Full Height	Full Height	x16	x16
Riser 2A	Slot 5	Processor 2	Full Height	Full Height	x8	x16
Riser 2A	Slot 6	Processor 1	Low Profile	Half Length	x8	x16
Riser 3A	Slot 7	Processor 2	Full Height	Full Height	x8	x16
Riser 3A	Slot 8	Processor 2	Full Height	Full Height	x16	x16

NOTE: The expansion card slots are not hot-swappable. The following table provides guidelines for installing cards to ensure proper and mechanical fit. The expansion cards with the highest priority should be installed first using the slot priority indicated. All the other expansion cards should be installed in the card priority and slot priority order.

Table 5. No riser configurations

Card type	Slot priority	Maximum number of cards
NDC	NDC Slot	1
PERC	3,1,2	1
GFX/GPU Compute(DW)	1,4,8	3
GFX(FH/SW)	1,4,8,2,5,7	Up to 6
GFX(LP)	6	1
PCIe SSD(LP)-Zoom 2	6	1
PCIe SSD(FH)-Zoom 2	1,2,3,4,5,7,8	1
PCIe SSD (FH)-Zoom 4	1,4,8	2(*see Note 7)
Teradici(P25) (LP)	6	1
Teradici(P25 or P45) (FH)	1,2,4,5,7,8	2
Serial (FH)	1,2,4,5,7,8	1
Serial (LP)	6	1
Audio (FH)	1,2,4,5,7,8	1
Audio (LP)	6	1



System specifications

Topics:

- System specifications
- Memory specifications
- Video specifications
- Audio specifications
- Network specifications
- Card slots
- Storage specifications
- External connectors
- Power specifications
- Physical specifications
- Environmental specifications

System specifications

Feature	Specification
Processor type	<ul style="list-style-type: none"> · Family W-2100 Processors
Total cache	Upto 24.75 MB

Memory specifications

Features	Specifications
Type	DDR4 ECC
Speed	2666 MHz
Connectors	8 DIMM Slots
Capacity	4 channel memory up to 256GB 2666 MHz DDR4 ECC memory with single CPUs
Maximum memory	256 GB

NOTE: The memory speed depends on the CPU in the system

Video specifications

Features	Specifications
Graphic card	<ul style="list-style-type: none"> · Radeon Pro WX 9100 · NVIDIA Quadro GP100

Features

Specifications

- NVIDIA Quadro P6000
- NVIDIA Quadro P5000
- Radeon Pro WX 7100
- Radeon Pro WX 5100
- Radeon Pro WX 4100
- NVIDIA Quadro P4000
- NVIDIA Quadro P2000
- Radeon Pro WX 3100
- Radeon Pro WX 2100
- NVIDIA Quadro P1000
- NVIDIA Quadro P600
- NVIDIA Quadro P400
- NVIDIA NVS 310
- NVIDIA NVS 315

Audio specifications

Features

Specifications

Type	High Definition Audio Codec (2 Channel)
Controller	Integrated Realtek ALC3234
Internal Speaker Power Rating	2W
Internal microphone support	no

Network specifications

Features

Specifications

Integrated	Intel i219 Gigabit Ethernet controllers with Intel Remote Wake UP, PXE and Jumbo frames support
Optional	<ul style="list-style-type: none">· Intel i210 10/100/1000 single port PCIe (Gen 3 x 1) gigabit network card.· Intel X550-T2 10GbE dual port PCIe (Gen 3 x 4) network card· Aquantia AQN-108 2.5Gbit/5Gbe single port PCIe (Gen 3 x 4) network card.

Card slots

Features

Specifications

Type	PCIe Gen 3
Slots	<ul style="list-style-type: none">· 2 PCIe x 16· 1 PCIe x 16 wired as x8· 1 PCIe x 16 wired as x4· 1 PCIe x 16 wired as x1



Features	Specifications
	<ul style="list-style-type: none"> 1 PCI 32/33

Storage specifications

Features	Specifications
Externally Accessible	DVD-ROM; DVD+/-RW 5.25" Bay Options: BD, DVD+/-RW
Internally Accessible	<ul style="list-style-type: none"> M.2 NVMe PCIe SSDs — Up to 4 x 1TB drives on 1 Dell Precision Ultra-Speed Drive Quad x16 cards Front FlexBay M.2 NVMe PCIe SSDs —Up to 2 x 1TB drives Up to 6 x 2.5" SATA drives Up to 5 x 3.5" SATA drives Slim ODD SAS available with optional controller

External connectors

Features	Specifications
Audio	<ul style="list-style-type: none"> Rear—1 x Audio Line in/Microphone Rear—1 x Audio Line out Front—1 x Universal Audio Jack
Network	Rear—1 x RJ45 Network
USB	<ul style="list-style-type: none"> Front—4 x USB 3.1 Gen1 Rear—6 x USB 3.1 Gen1
Serial port	Rear—1 x Serial port
PS2	<ul style="list-style-type: none"> Rear—1 x Keyboard Rear—1 x Mouse

Power specifications

Features	Specifications
Wattage	425W or 950 W
Voltage	input voltage 100 VAC-240 AC

Physical specifications

Features	Specifications
Height	417.9 mm
Width	176.5 mm

Features	Specifications
Depth	· 518.3 mm
Optional	19" rackmount rail kit

Environmental specifications

Temperature	Specifications
Operating	5 °C to 35 °C (41 F to 95 °F)
	NOTE: * Starting at 5000 ft, the maximum operating ambient temperature is derated by 1 C (1.8 F) per 1000 ft up to 10,000 ft.
Storage	-40 °C to 65 °C(-40 F to 149 F)
Relative humidity (maximum)	Specifications
Operating	8% to 85% (non-condensing)
Storage	5% to 95% (non-condensing)
Maximum vibration	Specifications
Operating	0.52 Grms, 5 to 350 Hz
Storage	2.0 Grms, 5 to 500 Hz
Maximum Shock	Specifications
Operating	40 G half-sine 2.5 ms pulse
Storage	105 G half-sine 2.5 ms pulse



System Setup

Topics:

- General options
- System configuration
- Video
- Security
- Secure boot
- Performance
- Power management
- Post behaviour
- Manageability
- Virtualization support
- Maintenance
- System logs
- Advanced configurations
- SupportAssist system resolution
- Updating the BIOS in Windows
- System and setup password

General options

Table 6. General

Option	Description
System Information	<p>This section lists the primary hardware features of your computer.</p> <p>The options are:</p> <ul style="list-style-type: none"> • System Information • Memory Configuration • Processor Information • PCI Information • Device Information
Boot Sequence	<p>Allows you to change the order in which the computer attempts to find an operating system.</p> <p>The options are:</p> <ul style="list-style-type: none"> • Diskette Drive • USB Storage Device • CD/DVD/CD-RW Drive • Onboard NIC • Internal HDD

Option	Description
	<p>Boot List Option</p> <p>Allows you to change the boot list options.</p> <p>Click one of the following options:</p> <ul style="list-style-type: none"> • Legacy • UEFI—Default
Advanced Boot Options	<p>Allows you to Enable Legacy Option ROMs.</p> <p>The options are:</p> <ul style="list-style-type: none"> • Enable Legacy Option ROMs—Default • Enable Attempt Legacy Boot
UEFI Boot Path Security	<p>Allows you to control whether the system prompts the user to enter the Admin password when booting to a UEFI boot path.</p> <p>Click one of the following options:</p> <ul style="list-style-type: none"> • Always, Except Internal HDD—Default • Always • Never
Date/Time	<p>Allows you to set the date and time. The change to the system date and time takes effect immediately.</p>

System configuration

Table 7. System Configuration

Option	Description
Integrated NIC	<p>Allows you to configure the integrated network controller.</p> <p>Click one of the following options:</p> <ul style="list-style-type: none"> • Disabled • Enabled • Enabled w/PXE—Default
UEFI Network Stack	<p>Allows pre-OS and early OS networking features to use any enabled NICs.</p> <ul style="list-style-type: none"> • Enabled UEFI Network Stack <p>This option is set by default.</p>
Serial Port	<p>Identifies and defines the serial port settings. You can set the serial port to:</p> <ul style="list-style-type: none"> • Disabled • COM1—Default • COM2 • COM3 • COM4 <p>NOTE: The operating system may allocate resources even if the setting is disabled.</p>



Option	Description
SATA Operation	<p data-bbox="804 191 1484 243">Allows you to configure the operating mode of the integrated SATA hard-drive controller.</p> <p data-bbox="804 270 1145 296">Click one of the following options:</p> <ul data-bbox="804 321 1034 415" style="list-style-type: none"> • Disabled • AHCI • RAID On—Default <p data-bbox="804 438 1318 499">NOTE: SATA is configured to support RAID mode.</p>
Drives	<p data-bbox="804 569 1358 594">Allows you to enable or disable various drives on board.</p> <p data-bbox="804 619 967 644">The options are:</p> <ul data-bbox="804 669 1066 1003" style="list-style-type: none"> • MiniSAS PCIe SSD-0 • SATA-0 • SATA-2 • SATA-4 • ODD-0 • MiniSAS PCIe SSD-1 • SATA-1 • SATA-3 • SATA-5 • ODD-1 <p data-bbox="804 1031 1134 1056">All the options are set by default.</p>
SMART Reporting	<p data-bbox="804 1094 1465 1194">This field controls if the hard drive errors for the integrated drives are reported during system startup. This technology is part of the SMART (Self-Monitoring Analysis and Reporting Technology) specification.</p> <ul data-bbox="804 1222 1114 1247" style="list-style-type: none"> • Enable SMART Reporting <p data-bbox="804 1272 1126 1297">This option is not set by default.</p>
USB Configuration	<p data-bbox="804 1335 1430 1360">Allows you to enable or disable the internal USB configuration.</p> <p data-bbox="804 1386 967 1411">The options are:</p> <ul data-bbox="804 1436 1118 1602" style="list-style-type: none"> • Enable USB Boot Support • Enable Front USB Ports • Enable Internal USB Ports • Enable USB 3.0 Controller • Enable Rear USB Ports <p data-bbox="804 1627 1134 1652">All the options are set by default.</p>
Front USB Configuration	<p data-bbox="804 1686 1265 1711">Allows you to enable/disable Front USB ports.</p> <p data-bbox="804 1736 967 1761">The options are:</p> <ul data-bbox="804 1787 1142 1883" style="list-style-type: none"> • USB3 Type A * • USB Type C port 2 (Right) * • USB Type C port 1 (Right) *



Option	Description
Rear USB Configuration	<p>All the options are set by default.</p> <p>Allows you to enable/disable Rear USB ports.</p> <p>The options are:</p> <ul style="list-style-type: none"> • RearPort3 Top * • RearPort1 Top * • RearPort2 Top * • RearPort3 Bottom * • RearPort1 Bottom * • RearPort2 Bottom *
Internal USB Configuration	<p>Allows you to enable/disable Internal USB ports.</p> <ul style="list-style-type: none"> • Internal Port 2 <p>This option is set by default.</p>
Dell Type-C Dock Configuration	<p>Allows you to connect to Dell WD and TB family of docks.</p> <p>Always Allows Dell Docks</p> <p>This option is set by default.</p>
Thunderbolt Adapter Configuration	<p>Allows you to enable or disable the Thunderbolt device support capability.</p> <p>The options are:</p> <ul style="list-style-type: none"> • Enabled Thunderbolt Technology Support • Enabled Thunderbolt Adapter Pre-boot Modules • Enabled Thunderbolt Adapter Boot Support—Default <p>NOTE: The security level configures the Thunderbolt adapter security settings within the operating system.</p>
USB PowerShare	<p>Allows you to configure the USB PowerShare feature behavior.</p> <ul style="list-style-type: none"> • Enable USB PowerShare <p>This option is not set by default.</p>
Audio	<p>Allows you to enable or disable the integrated audio controller.</p> <ul style="list-style-type: none"> • Enable Audio <p>This option is set by default.</p>
Memory Map IO above 4GB	<p>Allows you to enable or disable 64-bit capable PCI devices to be decoded in above 4 GB address space(only if the system supports 64-bit PCI decoding).</p> <ul style="list-style-type: none"> • Memory Map IO above 4GB <p>This option is not set by default.</p>
HDD Fans	<p>Allows you to control the HDD fans.</p>



Option	Description
	<p>The options are:</p> <ul style="list-style-type: none"> • HDD1 Fan Enable • HDD2 Fan Enable • HDD3 Fan Enable <p>All the options are not set by default.</p>
Miscellaneous devices	<p>Allows you to enable or disable various on board devices.</p> <p>The options are:</p> <ul style="list-style-type: none"> • Enable PCI Slot—Default • Secure Digital (SD) Card Boot • Enable Secure Digital (SD) Card—Default • Secure Digital (SD) Card Read-Only Mode

Video



Table 8. Video

Option	Description
Primary Video Slot	<p>Allows you to configure primary boot video device.</p> <p>Click any one of the following options:</p> <ul style="list-style-type: none"> • Auto—Default • SLOT 1 • SLOT 2: VGA Compatible • SLOT 2 • SLOT 3 • SLOT 5 • SLOT 6 • SLOT7_CPU1

Security

Table 9. Security

Option	Description
Admin Password	<p>Allows you to set, change, or delete the administrator(admin) password.</p> <p>The entries to set password are:</p> <ul style="list-style-type: none"> • Enter the old password: • Enter the new password: • Confirm new password: <p>Click OK once you set the password.</p>

Option	Description
	<p> NOTE: For the first time login, "Enter the old password:" field is marked to "Not set". Hence, password has to be set for the first time you login and then you can change or delete the password.</p>
System Password	<p>Allows you to set, change, or delete the System password.</p> <p>The entries to set password are:</p> <ul style="list-style-type: none"> • Enter the old password: • Enter the new password: • Confirm new password: <p>Click OK once you set the password.</p> <p> NOTE: For the first time login, "Enter the old password:" field is marked to "Not set". Hence, password has to be set for the first time you login and then you can change or delete the password.</p>
Internal HDD-0 Password	<p>Allows you to set, change, or delete the password on the system's internal hard disk drive (HDD).</p> <p>The entries to set password are:</p> <ul style="list-style-type: none"> • Enter the old password: • Enter the new password: • Confirm new password: <p>Click OK once you set the password.</p> <p> NOTE: For the first time login, "Enter the old password:" field is marked to "Not set". Hence, password has to be set for the first time you login and then you can change or delete the password.</p>
Strong Password	<p>Allows you to enforce the option to always set strong password.</p> <ul style="list-style-type: none"> • Enable Strong Password <p>This option is not set by default.</p>
Password Configuration	<p>You can define the length of your password. Min = 4, Max = 32</p>
Password Bypass	<p>Allows you to bypass the System password and the Internal HDD password, when it is set, during a system restart.</p> <p>Click one of the options:</p> <ul style="list-style-type: none"> • Disabled—Default • Reboot bypass
Password Change	<p>Allows you to change the System password when the administrator password is set.</p> <ul style="list-style-type: none"> • Allow Non-Admin Password Changes <p>This option is set by default.</p>
UEFI Capsule Firmware Updates	<p>Allows you to update the system BIOS via UEFI capsule update packages.</p> <ul style="list-style-type: none"> • Enable UEFI Capsule Firmware Updates <p>This option is set by default.</p>
TPM 1.2 Security	<p>Allows you to enable or disable the Trusted Platform Module (TPM) during POST.</p>

Option	Description
	<p>The options are:</p> <ul style="list-style-type: none"> • TPM On(Default) • Clear • PPI Bypass for Enable Commands • PPI Bypass for Disable Commands <p>Click any one of the following:</p> <ul style="list-style-type: none"> • Enabled—Default • Disabled
Computrace (R)	<p>Allows you to activate or disable the optional Computrace software.</p> <p>The options are:</p> <ul style="list-style-type: none"> • Deactivate—Default • Disable • Activate
Chassis Intrusion	<p>Allows you to control the chassis intrusion feature.</p> <p>Click one of the following options:</p> <ul style="list-style-type: none"> • Disabled—Default • Enabled • On-Silent
CPU XD Support	<p>Allows you to enable the Execute Disable mode of the processor.</p> <ul style="list-style-type: none"> • Enable CPU XD Support <p>This option is set by default.</p>
OROM Keyboard Access	<p>Allows you to determine whether users are able to enter the Option ROM Configuration screens via hotkeys during boot. The options are:</p> <p>Click one of the following options:</p> <ul style="list-style-type: none"> • Enabled—Default • One Time Enable • Disabled
Admin Setup Lockout	<p>Allows you to prevent users from entering Setup when an administrator password is set.</p> <ul style="list-style-type: none"> • Enable Admin Setup Lockout <p>This option is not set by default.</p>
Master Password Lockout	<p>Allows you to disable master password support.</p> <ul style="list-style-type: none"> • Enable Master Password Lockout <p>This option is not set by default.</p> <p> NOTE: Hard Disk password should be cleared before the settings can be changed.</p>

Secure boot

Table 10. Secure Boot

Option	Description
Secure Boot Enable	<p>Allows you to enable or disable the Secure Boot Feature.</p> <p>Click one of the following options:</p> <ul style="list-style-type: none"> • Disabled—Default • Enabled
Expert Key Management	<p>Allows you to enable or disable Expert Key Management.</p> <ul style="list-style-type: none"> • Enable Custom Mode <p>This option is not set by default.</p> <p>The Custom Mode Key Management options are:</p> <ul style="list-style-type: none"> • PK(Default) • KEK • db • dbx

Performance

Table 11. Performance

Option	Description
Multi Core Support	<p>This field specifies whether the processor has one or all cores enabled. The performance of some applications improves with the additional cores.</p> <ul style="list-style-type: none"> • Active Processor Cores <p>Choose any number from 01–08:</p> <p>NOTE: To enable Trusted Execution mode, all the cores must be enabled.</p>
Intel SpeedStep	<p>Allows you to enable or disable the Intel SpeedStep mode of processor.</p> <ul style="list-style-type: none"> • Enable Intel SpeedStep <p>This option is set by default.</p>
C-States Control	<p>Allows you to enable or disable the additional processor sleep states.</p> <ul style="list-style-type: none"> • C states <p>This option is set by default.</p>



Option	Description
Limit CPUID Value	<p>This field limits the maximum value the processor Standard CPUID Function supports.</p> <ul style="list-style-type: none"> • Enable CPUID Limit <p>This option is not set by default.</p>
Cache Prefetch	<p>Allows you to turn on the MLC streamer prefetcher and MLC spatial prefetcher.</p> <p>The options are:</p> <ul style="list-style-type: none"> • Hardware Prefetcher • Adjacent Cache Prefetch <p>All the options are set by default.</p>
Intel TurboBoost	<p>Allows you to enable or disable the Intel TurboBoost mode of the processor.</p> <ul style="list-style-type: none"> • Enable Intel TurboBoost <p>This option is set by default.</p>
Hyper-Thread Control	<p>Allows you to enable or disable the HyperThreading in the processor.</p> <ul style="list-style-type: none"> • Disabled • Enabled—Default
Dell Reliable Memory Technology (RMT)	<p>Allows you to identify and isolate memory errors in system RAM.</p> <ul style="list-style-type: none"> • Enable Dell RMT—Default • Clear Dell RMT
System Isochronous Mode	<p>Allows you to enable or disable this mode to reduce latency of memory transactions at the expense of bandwidth. :</p> <p>Click one of the options:</p> <ul style="list-style-type: none"> • Disabled(Default) • Enabled
RAS Support	<p>Allows you to report or log errors caused by memory failures, the PCIe failures, CPU failures. The options are:</p> <ul style="list-style-type: none"> • Enable on Memory modules • Enable on PCIe modules • Enable on CPU modules <p>The options are not set by default.</p>

Power management

Table 12. Power Management

Option	Description
AC Recovery	Specifies how the computer will respond when AC power is applied after an AC power loss.

Option	Description
Auto On Time	<p>You can set the AC Recovery to:</p> <ul style="list-style-type: none"> • Power Off—Default • Power On • Last Power State
Deep Sleep Control	<p>Allows you to set the time at which the computer must turn on automatically.</p> <p>Click one of the following options:</p> <ul style="list-style-type: none"> • Disabled—Default • Every Day • Weekdays • Select Days <p>Allows you to define the controls when Deep Sleep is enabled.</p> <p>Click one of the options:</p> <ul style="list-style-type: none"> • Disabled—Default • Enabled in S5 only • Enabled in S4 and S5
Fan Speed Control	<p>Allows you to control the speed of the system fan.</p> <p>Click one of the options:</p> <ul style="list-style-type: none"> • Low • Auto—Default <p> NOTE: Low = Fans run low and quite. System performance may decrease. Auto = Fans run at optimal speed based on environmental data. System performance is maximized.</p>
USB Wake Support	<p>Allows you to enable USB devices to wake the system from standby.</p> <ul style="list-style-type: none"> • Enable USB Wake Support <p>This option is set by default.</p>
Wake on LAN	<p>This option allows the computer to power up from the off state when triggered by a special LAN signal. Wake-up from the Standby state is unaffected by this setting and must be enabled in the operating system. This feature only works when the computer is connected to AC power supply.</p> <ul style="list-style-type: none"> • Disabled - Does not allow the system to power on by special LAN signals when it receives a wake-up signal from the LAN or wireless LAN. • LAN Only - Allows the system to be powered on by special LAN signals. • LAN with PXE Boot - Allows the system to power on and immediately boot to PXE when it receives a wake-up packet sent to the system in either the S4 or S5 state. <p>All the options are not set by default.</p>
Block Sleep	<p>Allows you to block entering to sleep(S3 state) in OS Environment.</p> <p>This option is not set by default.</p>



Post behaviour

Table 13. POST Behavior

Option	Description
Numlock LED	Specifies if the NumLock function can be enabled when the system boots. This option is set by default.
Keyboard Errors	Specifies whether keyboard related errors are reported when it boots. This option is set by default.
Extend BIOS POST Time	Allows you to create additional pre-boot delay and see POST status messages. Click one of the following options: <ul style="list-style-type: none"> • 0 seconds(Default) • 5 seconds • 10 seconds
Security Audit Display Disable	Allows you to disable the display of the Security Audit results during POST. <ul style="list-style-type: none"> • Disable Display Of Security Audit Display This option is not set by default.
Full Screen Logo	Allows you to display full screen logo, if your image matches screen resolution. <ul style="list-style-type: none"> • Enable Full Screen Logo This option is not set by default.
Warnings and Errors	Allows you to select different options to either stop, prompt and wait for user input, continue when warnings are detected but pause on errors, or continue when either warnings or errors are detected during the POST process. Click one of the following options: <ul style="list-style-type: none"> • Prompt on Warnings and Errors—Default • Continue on Warnings • Continue on Warnings and Errors

Manageability

Table 14. Manageability

Option	Description
USB Provision	Allows you to provision Intel AMT using the local provisioning file via a USB storage device. <ul style="list-style-type: none"> • Enable USB Provision <p>i NOTE: When disabled, provisioning Intel AMT from a USB storage device is blocked.</p> This option is not set by default.
MEBx Hotkey	Allows you to specify if the MEBx Hotkey function should be enabled when the system boots

Option	Description
	This option is set by default.

Virtualization support

Table 15. Virtualization Support

Option	Description
Virtualization	<p>This option specifies whether a Virtual Machine Monitor (VMM) can utilize the additional hardware capabilities provided by the Intel Virtualization technology.</p> <ul style="list-style-type: none"> • Enable Intel Virtualization Technology <p>This option is set by default.</p>
VT for Direct I/O	<p>Enables or disables the Virtual Machine Monitor (VMM) from utilizing the additional hardware capabilities provided by the Intel Virtualization technology for direct I/O.</p> <ul style="list-style-type: none"> • Enable VT for Direct I/O <p>This option is set by default.</p>
Trusted Execution	<p>Allows you to specify whether a Measured Virtual Machine Monitor (MVMM) can utilize the additional hardware capabilities provided by the Intel Trusted Execution Program.</p> <ul style="list-style-type: none"> • Trusted Execution <p>This option is not set by default.</p>

Maintenance

Table 16. Maintenance

Option	Description
Service Tag	Displays the service tag of your computer.
Asset Tag	<p>Allows you to create a system asset tag if an asset tag is not already set.</p> <p>This option is not set by default.</p>
SERR Messages	<p>Controls the SERR message mechanism. Some graphics cards require that the SERR message mechanism be disabled.</p> <p>This option is not set by default.</p>
BIOS Downgrade	<p>Allows you to flash previous revisions of the system firmware.</p> <ul style="list-style-type: none"> • Allow BIOS Downgrade <p>This option is set by default.</p>
Data Wipe	<p>Allows you to securely erase data from all internal storage devices.</p> <ul style="list-style-type: none"> • Wipe on Next Boot <p>This option is not set by default.</p>



Option	Description
Bios Recovery	<p>BIOS Recovery from Hard Drive—This option is set by default. Allows you to recover the corrupted BIOS from a recovery file on the HDD or an external USB key.</p> <p>BIOS Auto-Recovery— Allows you to recover the BIOS automatically.</p> <p> NOTE: BIOS Recovery from Hard Drive field should be enabled.</p> <p>Always Perform Integrity Check—Performs integrity check on every boot.</p>

System logs

Table 17. System Logs

Option	Description
BIOS events	<p>Displays the system event log and allows you to clear the log.</p> <ul style="list-style-type: none"> • Clear Log <p>This option is not set by default.</p>

Advanced configurations

Table 18. Advanced configurations

Option	Description
Pcie LinkSpeed	<p>Allows you to choose the Pcie linkspeed.</p> <p>Click one of the following options:</p> <ul style="list-style-type: none"> • Auto—Default • Gen1 • Gen2

SupportAssist system resolution

Table 19. SupportAssist System Resolution

Option	Description
Auto OS Recovery Threshold	<p>The Auto OS Recovery Threshold setup option controls the automatic boot flow for Support Assist System Resolution Console and Dell OS Recovery tool.</p> <p>Click one of the following options:</p> <ul style="list-style-type: none"> • OFF • 1 • 2—Default • 3

Updating the BIOS in Windows

It is recommended to update your BIOS (System Setup), when you replace the system board or if an update is available. For laptops, ensure that your computer battery is fully charged and connected to a power outlet

NOTE: If BitLocker is enabled, it must be suspended prior to updating the system BIOS, and then re-enabled after the BIOS update is completed.

- 1 Restart the computer.
- 2 Go to **Dell.com/support**.
 - Enter the **Service Tag** or **Express Service Code** and click **Submit**.
 - Click **Detect Product** and follow the instructions on screen.
- 3 If you are unable to detect or find the Service Tag, click **Choose from all products**.
- 4 Choose the **Products** category from the list.

NOTE: Choose the appropriate category to reach the product page

- 5 Select your computer model and the **Product Support** page of your computer appears.
- 6 Click **Get drivers** and click **Drivers and Downloads**.
The Drivers and Downloads section opens.
- 7 Click **Find it myself**.
- 8 Click **BIOS** to view the BIOS versions.
- 9 Identify the latest BIOS file and click **Download**.
- 10 Select your preferred download method in the **Please select your download method below** window, click **Download File**.
The **File Download** window appears.
- 11 Click **Save** to save the file on your computer.
- 12 Click **Run** to install the updated BIOS settings on your computer.
Follow the instructions on the screen.

NOTE: It is recommended not to update the BIOS version for more than three revisions. For example: If you want to update the BIOS from 1.0 to 7.0, then install version 4.0 first and then install version 7.0.

Updating BIOS on systems with bitlocker enabled

CAUTION: If BitLocker is not suspended before updating the BIOS, the next time you reboot the system it will not recognize the BitLocker key. You will then be prompted to enter the recovery key to progress and the system will ask for this on each reboot. If the recovery key is not known this can result in data loss or an unnecessary operating system re-install. For more information on this subject, see Knowledge Article: <http://www.dell.com/support/article/us/en/19/SLN153694/updating-bios-on-systems-with-bitlocker-enabled>

Updating your system BIOS using a USB flash drive

If the system cannot load into Windows but there is still a need to update the BIOS, download the BIOS file using another system and save it to a bootable USB Flash Drive.

NOTE: You will need to use a bootable USB Flash drive. Please refer to the following article for further details: <http://www.dell.com/support/article/us/en/19/SLN143196/how-to-create-a-bootable-usb-flash-drive-using-dell-diagnostic-deployment-package--ddd->

- 1 Download the BIOS update .EXE file to another system.
- 2 Copy the file e.g. O9010A12.EXE onto the bootable USB Flash drive.
- 3 Insert the USB Flash drive into the system that requires the BIOS update.
- 4 Restart the system and press F12 when the Dell Splash logo appears to display the One Time Boot Menu.
- 5 Using arrow keys, select **USB Storage Device** and click Return.
- 6 The system will boot to a Diag C:\> prompt.
- 7 Run the file by typing the full filename e.g. O9010A12.exe and press Return.
- 8 The BIOS Update Utility will load, follow the instructions on screen.





Figure 1. DOS BIOS Update Screen

Updating the Dell BIOS in Linux and Ubuntu environments

If you want to update the system BIOS in a Linux environment such as Ubuntu, see <http://www.dell.com/support/article/us/en/19/SLN171755/updating-the-dell-bios-in-linux-and-ubuntu-environments>.

System and setup password

Table 20. System and setup password

Password type	Description
System password	Password that you must enter to log on to your system.
Setup password	Password that you must enter to access and make changes to the BIOS settings of your computer.

You can create a system password and a setup password to secure your computer.

CAUTION: The password features provide a basic level of security for the data on your computer.

CAUTION: Anyone can access the data stored on your computer if it is not locked and left unattended.

NOTE: System and setup password feature is disabled.

Assigning a system password and setup password

You can assign a new **System Password** only when the status is in **Not Set**.

To enter the system setup, press F2 immediately after a power-on or re-boot.

- 1 In the **System BIOS** or **System Setup** screen, select **Security** and press Enter.
The **Security** screen is displayed.
- 2 Select **System Password** and create a password in the **Enter the new password** field.

Use the following guidelines to assign the system password:

- A password can have up to 32 characters.
 - The password can contain the numbers 0 through 9.
 - Only lower case letters are valid, upper case letters are not allowed.
 - Only the following special characters are allowed: space, ("), (+), (,), (-), (.), (/), (:), ([), (\), (]), (`).
- 3 Type the system password that you entered earlier in the **Confirm new password** field and click **OK**.
 - 4 Press Esc and a message prompts you to save the changes.
 - 5 Press Y to save the changes.
The computer reboots.

Deleting or changing an existing system setup password

Ensure that the **Password Status** is Unlocked (in the System Setup) before attempting to delete or change the existing System and/or Setup password. You cannot delete or change an existing System or Setup password, if the **Password Status** is Locked. To enter the System Setup, press F2 immediately after a power-on or reboot.

- 1 In the **System BIOS** or **System Setup** screen, select **System Security** and press Enter.
The **System Security** screen is displayed.
- 2 In the **System Security** screen, verify that **Password Status** is **Unlocked**.
- 3 Select **System Password**, alter or delete the existing system password and press Enter or Tab.
- 4 Select **Setup Password**, alter or delete the existing setup password and press Enter or Tab.

 **NOTE: If you change the System and/or Setup password, re-enter the new password when prompted. If you delete the System and/or Setup password, confirm the deletion when prompted.**

- 5 Press Esc and a message prompts you to save the changes.
- 6 Press Y to save the changes and exit from System Setup.
The computer reboots.

Software

This chapter details the supported operating systems along with instructions on how to install the drivers.

Topics:

- Supported operating systems
- Downloading drivers
- Chipset drivers
- Graphics controller driver
- Ports
- USB drivers
- Network driver
- Audio drivers
- Storage controller drivers
- Other drivers

Supported operating systems

Table 21. Operating systems

Windows 10	<ul style="list-style-type: none"> • Factory installed Windows 10 Pro— 64-bit • Factory installed Win 10 Enterprise—64-bit
Windows 7	Windows 7 Pro— 64-bit
Linux	<ul style="list-style-type: none"> • RHEL 7.3 • Ubuntu 16.04 • NeoKylin v6.0

Downloading drivers

































- 1 Turn on the computer.
- 2 Go to **Dell.com/support**.
- 3 Click **Product Support**, enter the Service Tag of your system, and then click **Submit**.

NOTE: If you do not have the Service Tag, use the auto detect feature or manually browse for your system model.

- 4 Click **Drivers and Downloads**.
- 5 Select the operating system installed on your system.
- 6 Scroll down the page and select the driver to install.
- 7 Click **Download File** to download the driver for your system.
- 8 After the download is complete, navigate to the folder where you saved the driver file.
- 9 Double-click the driver file icon and follow the instructions on the screen.



Chipset drivers

Verify if the Intel chipset and Intel Management Engine Interface drivers are already installed in the computer.

- ▼  System devices
 -  ACPI Fixed Feature Button
 -  ACPI Module Device
 -  Advanced programmable interrupt controller
 -  Composite Bus Enumerator
 -  Direct memory access controller
 -  High Definition Audio Controller
 -  High Definition Audio Controller
 -  Intel(R) C620 series chipset CSME: IDE Redirection - A1BC
 -  Intel(R) C620 series chipset LPC Controller - A1C1
 -  Intel(R) C620 series chipset MROM 0 - A1EC
 -  Intel(R) C620 series chipset MROM 1 - A1ED
 -  Intel(R) C620 series chipset PCI Express Root Port #1 - A190
 -  Intel(R) C620 series chipset PCI Express Root Port #8 - A197
 -  Intel(R) C620 series chipset PMC - A1A1
 -  Intel(R) C620 series chipset SMBus - A1A3
 -  Intel(R) C620 series chipset SPI Controller - A1A4
 -  Intel(R) C620 series chipset Thermal Subsystem - A1B1
 -  Intel(R) Management Engine Interface
 -  Intel(R) Xeon(R) processor P family/Core i7 CBDMA Registers - 2021
 -  Intel(R) Xeon(R) processor P family/Core i7 CBDMA Registers - 2021
 -  Intel(R) Xeon(R) processor P family/Core i7 CBDMA Registers - 2021
 -  Intel(R) Xeon(R) processor P family/Core i7 CBDMA Registers - 2021
 -  Intel(R) Xeon(R) processor P family/Core i7 CBDMA Registers - 2021
 -  Intel(R) Xeon(R) processor P family/Core i7 CBDMA Registers - 2021
 -  Intel(R) Xeon(R) processor P family/Core i7 CBDMA Registers - 2021
 -  Intel(R) Xeon(R) processor P family/Core i7 CBDMA Registers - 2021
 -  Intel(R) Xeon(R) processor P family/Core i7 CHA Registers - 2057
 -  Intel(R) Xeon(R) processor P family/Core i7 CHA Registers - 2054
 -  Intel(R) Xeon(R) processor P family/Core i7 CHA Registers - 2056
 -  Intel(R) Xeon(R) processor P family/Core i7 CHA Registers - 2055
 -  Intel(R) Xeon(R) processor P family/Core i7 CHA Registers - 208E

Graphics controller driver

Verify if the graphics controller driver is already installed in the computer.

- ▼  Display adapters
 -  NVIDIA NVS 310

Ports

Verify if the drivers for the ports are already installed in the computer.



- Ports (COM & LPT)
 - Communications Port (COM1)
 - Intel(R) Active Management Technology - SOL (COM3)

USB drivers

Verify if the USB drivers are already installed in the computer.

- Universal Serial Bus controllers
 - Generic SuperSpeed USB Hub
 - Generic USB Hub
 - Intel(R) USB 3.0 eXtensible Host Controller - 1.0 (Microsoft)
 - USB Composite Device
 - USB Mass Storage Device
 - USB Root Hub (xHCI)

Network driver

The driver is labeled as Intel I219-LM Ethernet Driver.

- Network adapters
 - Intel(R) Ethernet Connection (3) I219-LM

Audio drivers

Verify if the audio drivers are already installed in the computer.

- Sound, video and game controllers
 - NVIDIA High Definition Audio
 - Realtek Audio
- Audio inputs and outputs
 - Speakers / Headphones (Realtek Audio)

Storage controller drivers

Verify if the storage controller drivers are already installed in the computer.



- Storage controllers
 - Intel(R) C600+/C220+ series chipset SATA RAID Controller
 - Microsoft Storage Spaces Controller

Other drivers

This section lists different driver details for all the other components in the Device Manager.



Security device drivers

Verify if the security device drivers are already installed in the computer.

- ▼  Security devices
 -  Trusted Platform Module 1.2



Software device drivers

Verify if the software device drivers are already installed in the computer.

- ▼  Software devices
 -  Microsoft Device Association Root Enumerator
 -  Microsoft GS Wavetable Synth



Human Interface Device drivers

Verify if the human interface device drivers are already installed in the computer.

- ▼  Human Interface Devices
 -  USB Input Device

Firmware

Verify if the Firmware drivers are already installed in the computer.

- ▼  Firmware
 -  System Firmware

Troubleshooting

The following section describes common troubleshooting steps that can be performed to resolve certain problems on your computer.

Topics:

- [Dell Enhanced Pre-Boot System Assessment — ePSA diagnostic 3.0](#)
- [Preboot blinking power button codes](#)
- [PCIe slots](#)

Dell Enhanced Pre-Boot System Assessment — ePSA diagnostic 3.0

You can invoke the ePSA diagnostics by performing either of the following steps:

- Press the F12 key when the system boots and choosing **Diagnostics** option.
- Press Fn+PWR when the system boots.

For more details, see [Dell EPSA Diagnostic 3.0](#).

Running the ePSA diagnostics

- 1 Power-on the computer.
- 2 As the computer boots, press the F12 key as the Dell logo appears.
- 3 On the boot menu screen, select the **Diagnostics** option.
- 4 Click the arrow key at the bottom left corner.
Diagnostics front page is displayed.
- 5 Press the arrow in the lower-right corner to go to the page listing.
The items detected are listed.
- 6 To run a diagnostic test on a specific device, press Esc and click **Yes** to stop the diagnostic test.
- 7 Select the device from the left pane and click **Run Tests**.
- 8 If there are any issues, error codes are displayed.
Note the error code and validation number and contact Dell.

Preboot blinking power button codes

Table 22. Power button LED state

Power Button LED State	Description
Off	Power is Off. LED is blank.
Blinking Amber	Initial State of LED at power up. See the table below for Blinking Amber pattern diagnostic suggestions and possible failures.

Power Button LED State	Description
Blinking White	System is in a low power state, either S1 or S3. This does not indicate a fault condition.
Solid Amber	The second state of the LED at power up, indicates that the POWER_GOOD signal is active and it is probable that the power supply is fine.
Solid White	System is in S0 state. This is the normal power states of a functioning machine. The BIOS will turn the LED to this states to indicate it has started fetching op-codes.

Table 23. Diagnostic Indicator table

Power Light: Amber-White Blinking	Amber/White Blinking Pattern	Problem Description	Suggested Resolution
1-1	1 amber blink followed by a short pause, 1 white blink, long pause, then repeats	Faulty System board	To troubleshoot the issue with system board, contact Tech support.
1-2	1 amber blink followed by a short pause, 2 white blinks, long pause, then repeats	Bad system board, Power Supply or Power Supply cabling	<ul style="list-style-type: none"> If you can assist to troubleshoot, narrow down the issue with PSU BIST Test, reseal cable. If nothing works, contact Tech Support
1-3	1 amber blink followed by a short pause, 3 white blinks, long pause, then repeats	Bad system board, Memory or Processor	<ul style="list-style-type: none"> If you can assist to troubleshoot, narrow down the issue by reseating memory and swapping a known good memory if available. If nothing works, contact Tech Support
2-1	2 amber blinks followed by a short pause, 1 white blink, long pause, then repeats	Bad Processor	<ul style="list-style-type: none"> CPU configuration activity is in progress or a CPU failure was detected. Contact Tech Support
2-2	2 amber blinks followed by a short pause, 2 white blinks, long pause, then repeats	Motherboard: BIOS ROM failure	<ul style="list-style-type: none"> System is in Recovery Mode. Flash latest BIOS version. If problem persists, contact Tech Support
2-3	2 amber blinks followed by a short pause, 3 white blinks, long pause, then repeats	No Memory	<ul style="list-style-type: none"> If customer can assist to troubleshoot, narrow down the issue by removing the memory module one by one to determine which one failed and swapping to a known good memory if available to confirm. Contact Tech Support
2-4	2 amber blinks followed by a short pause, 4 white blinks, long pause, then repeats	Memory/RAM failure	<ul style="list-style-type: none"> If customer can assist to troubleshoot, narrow down the issue by removing the

Power Light: Amber-White Blinking	Amber/White Blinking Pattern	Problem Description	Suggested Resolution
			<ul style="list-style-type: none"> memory module one by one to determine which one failed and swapping to a known good memory if available to confirm. Contact Tech Support
2-5	2 amber blinks followed by a short pause, 5 white blinks, long pause, then repeats	Invalid memory installed	<ul style="list-style-type: none"> Memory subsystem configuration activity is in progress. Memory modules have been detected but appear to be incompatible or in an invalid configuration. If customer can assist to troubleshoot, narrow down the issue by removing one by one the memory on motherboard to determine which one failed. Contact Tech Support.
2-6	2 amber blinks followed by a short pause, 6 white blinks, long pause, then repeats	Motherboard: Chipset	<ul style="list-style-type: none"> Fatal system board failure detected. If customer can assist to troubleshoot, narrow down the issue by removing one by one the component on motherboard to determine which one failed. If you identified any of the components failed, replace the Component. Contact Tech Support.
3-2	3 amber blinks followed by a short pause, 2 white blinks, long pause, then repeats	PCI Device or Video	<ul style="list-style-type: none"> PCI device configuration activity is in progress or PCI device failure was detected. If you can assist to troubleshoot, narrow down the issue by reseating PCI card and removing one by one to determine which card failed. Contact Tech Support.
3-3	3 amber blinks followed by a short pause, 3 white blinks, long pause, then repeats	BIOS Recovery 1	<ul style="list-style-type: none"> System is in Recovery Mode. Flash latest BIOS version. If problem persists, contact Tech Support
3-4	3 amber blinks followed by a short pause, 4 white blinks, long pause, then repeats	BIOS Recovery 2	<ul style="list-style-type: none"> System is in Recovery Mode. Flash latest BIOS version. If problem persists, contact Tech Support
4-6	4 amber blinks followed by a short pause, 6 white blinks, long pause, then repeats	RAID Volume degraded	<ul style="list-style-type: none"> RAID volume is degraded. If you can assist to troubleshoot, us F12 menu to enter Device Configuration

Power Light: Amber-White Blinking	Amber/White Blinking Pattern	Problem Description	Suggested Resolution
			<ul style="list-style-type: none"> tab. Rebuild the RAID volume if possible Contact Tech Support.
4-7	4 amber blinks followed by a short pause, 7 white blinks, long pause, then repeats	System Side cover is missing	<ul style="list-style-type: none"> System side cover (either left or right) is missing. Unplug power, Install back all side covers back to the chassis and plug in power. Contact Tech Support.

PCIe slots

The PCIe slots on Precision 5820 have a different functionality depending on the processor installed. Core i7-78xx has a limit of 28 lanes.

This results in a reduced PCIe lane count to the slots 1 and 4 as shown in the following table:

- Slot 1 is closest to CPU/memory complex.

Table 24. PCIe slots

	Core i9-79xx/Xeon	Core i7-78xx
Slot 1	PCIe x850W	Nonfunctional
Slot 2	PCIex16 300 W*	PCIex16 300 W
Slot 3	PCIex125W-PCH	PCIex1 25W-PCH
Slot 4	PCIex16 300 W*	PCIex8 150 W
Slot 5	PCIex4 25W-PCH	PCIex4 25W-PCH
Slot 6	PCI 32 bit 25 W	PCI 32 bit 25 W

NOTE: All slots are Gen3(8GTs) from processor root hub unless otherwise indicated xX indicates the number of lanes that are connected to the slot. FH=Full Height, FL=Full Length, DW=Double Wide as defined by PCIe CEM spec *Slots are 300 W capable. Limited to 250 W per slot when more than one MEGA is installed.

Contacting Dell

NOTE: If you do not have an active Internet connection, you can find contact information on your purchase invoice, packing slip, bill, or Dell product catalog.

Dell provides several online and telephone-based support and service options. Availability varies by country and product, and some services may not be available in your area. To contact Dell for sales, technical support, or customer service issues:

- 1 Go to **Dell.com/support**.
- 2 Select your support category.
- 3 Verify your country or region in the **Choose a Country/Region** drop-down list at the bottom of the page.
- 4 Select the appropriate service or support link based on your need.