

OptiPlex 7060 Micro

Service Manual



Notes, cautions, and warnings

 | **NOTE:** A NOTE indicates important information that helps you make better use of your product.

 | **CAUTION:** A CAUTION indicates either potential damage to hardware or loss of data and tells you how to avoid the problem.

 | **WARNING:** A WARNING indicates a potential for property damage, personal injury, or death.

© 2018 Dell Inc. or its subsidiaries. All rights reserved. Dell, EMC, and other trademarks are trademarks of Dell Inc. or its subsidiaries. Other trademarks may be trademarks of their respective owners.

Working on your computer

Safety instructions

Use the following safety guidelines to protect your computer from potential damage and to ensure your personal safety. Unless otherwise noted, each procedure included in this document assumes that the following conditions exist:

- You have read the safety information that shipped with your computer.
- A component can be replaced or, if purchased separately, installed by performing the removal procedure in reverse order.

⚠ WARNING: Disconnect all power sources before opening the computer cover or panels. After you finish working inside the computer, replace all covers, panels, and screws before connecting to the power source.

⚠ WARNING: Before working inside your computer, read the safety information that shipped with your computer. For additional safety best practices information, see the Regulatory Compliance Homepage at www.Dell.com/regulatory_compliance

⚠ CAUTION: Many repairs may only be done by a certified service technician. You should only perform troubleshooting and simple repairs as authorized in your product documentation, or as directed by the online or telephone service and support team. Damage due to servicing that is not authorized by Dell is not covered by your warranty. Read and follow the safety instructions that came with the product.

⚠ CAUTION: To avoid electrostatic discharge, ground yourself by using a wrist grounding strap or by periodically touching an unpainted metal surface at the same time as touching a connector on the back of the computer.

⚠ CAUTION: Handle components and cards with care. Do not touch the components or contacts on a card. Hold a card by its edges or by its metal mounting bracket. Hold a component such as a processor by its edges, not by its pins.

⚠ CAUTION: When you disconnect a cable, pull on its connector or on its pull-tab, not on the cable itself. Some cables have connectors with locking tabs; if you are disconnecting this type of cable, press in on the locking tabs before you disconnect the cable. As you pull connectors apart, keep them evenly aligned to avoid bending any connector pins. Also, before you connect a cable, ensure that both connectors are correctly oriented and aligned.

ⓘ NOTE: The color of your computer and certain components may appear differently than shown in this document.

Turning off your computer — Windows 10

⚠ CAUTION: To avoid losing data, save and close all open files and exit all open programs before you turn off your computer or remove the side cover.

- 1 Click or tap .
- 2 Click or tap  and then click or tap **Shut down**.

ⓘ NOTE: Ensure that the computer and all attached devices are turned off. If your computer and attached devices did not automatically turn off when you shut down your operating system, press and hold the power button for about 6 seconds to turn them off.

Before working inside your computer

To avoid damaging your computer, perform the following steps before you begin working inside the computer.

- 1 Ensure that you follow the [Safety Instruction](#).
- 2 Ensure that your work surface is flat and clean to prevent the computer cover from being scratched.

- 3 Turn off your computer.
- 4 Disconnect all network cables from the computer.

CAUTION: To disconnect a network cable, first unplug the cable from your computer and then unplug the cable from the network device.

- 5 Disconnect your computer and all attached devices from their electrical outlets.
- 6 Press and hold the power button while the computer is unplugged to ground the system board.

NOTE: To avoid electrostatic discharge, ground yourself by using a wrist grounding strap or by periodically touching an unpainted metal surface at the same time as touching a connector on the back of the computer.

After working inside your computer

After you complete any replacement procedure, ensure that you connect any external devices, cards, and cables before turning on your computer.

- 1 Connect any telephone or network cables to your computer.

CAUTION: To connect a network cable, first plug the cable into the network device and then plug it into the computer.

- 2 Connect your computer and all attached devices to their electrical outlets.
- 3 Turn on your computer.
- 4 If required, verify that the computer works correctly by running **ePSA diagnostics**.

Technology and components

This chapter details the technology and components available in the system.

Topics:

- [DDR4](#)
- [USB features](#)
- [USB Type-C](#)
- [Advantages of Displayport over USB Type-C](#)
- [HDMI 2.0](#)

DDR4

DDR4 (double data rate fourth generation) memory is a higher-speed successor to the DDR2 and DDR3 technologies and allows up to 512 GB in capacity, compared to the DDR3's maximum of 128 GB per DIMM. DDR4 synchronous dynamic random-access memory is keyed differently from both SDRAM and DDR to prevent the user from installing the wrong type of memory into the system.

DDR4 needs 20 percent less or just 1.2 volts, compared to DDR3 which requires 1.5 volts of electrical power to operate. DDR4 also supports a new, deep power-down mode that allows the host device to go into standby without needing to refresh its memory. Deep power-down mode is expected to reduce standby power consumption by 40 to 50 percent.

DDR4 Details

There are subtle differences between DDR3 and DDR4 memory modules, as listed below.

Key notch difference

The key notch on a DDR4 module is in a different location from the key notch on a DDR3 module. Both notches are on the insertion edge but the notch location on the DDR4 is slightly different, to prevent the module from being installed into an incompatible board or platform.

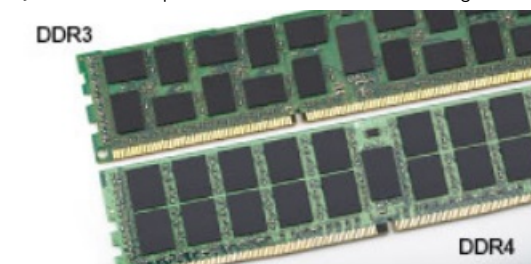

Figure 1. Notch difference

Increased thickness

DDR4 modules are slightly thicker than DDR3, to accommodate more signal layers.

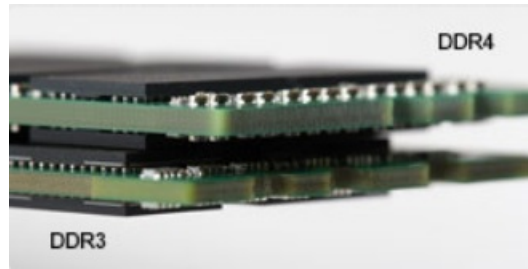

Figure 2. Thickness difference

Curved edge

DDR4 modules feature a curved edge to help with insertion and alleviate stress on the PCB during memory installation.



Figure 3. Curved edge

Memory Errors

Memory errors on the system display the new ON-FLASH-FLASH or ON-FLASH-ON failure code. If all memory fails, the LCD does not turn on. Troubleshoot for possible memory failure by trying known good memory modules in the memory connectors on the bottom of the system or under the keyboard, as in some portable systems.

USB features

Universal Serial Bus, or USB, was introduced in 1996. It dramatically simplified the connection between host computers and peripheral devices like mice, keyboards, external drivers, and printers.

Let's take a quick look on the USB evolution referencing to the table below.

Table 1. USB evolution

Type	Data Transfer Rate	Category	Introduction Year
USB 3.0/USB 3.1 Gen 1	5 Gbps	Super Speed	2010
USB 2.0	480 Mbps	High Speed	2000
USB 3.1 Gen 2	10 Gbps	Super Speed	2013

USB 3.0/USB 3.1 Gen 1 (SuperSpeed USB)

For years, the USB 2.0 has been firmly entrenched as the de facto interface standard in the PC world with about 6 billion devices sold, and yet the need for more speed grows by ever faster computing hardware and ever greater bandwidth demands. The USB 3.0/USB 3.1 Gen 1

finally has the answer to the consumers' demands with a theoretically 10 times faster than its predecessor. In a nutshell, USB 3.1 Gen 1 features are as follows:

- Higher transfer rates (up to 5 Gbps)
- Increased maximum bus power and increased device current draw to better accommodate power-hungry devices
- New power management features
- Full-duplex data transfers and support for new transfer types
- Backward USB 2.0 compatibility
- New connectors and cable

The topics below cover some of the most commonly asked questions regarding USB 3.0/USB 3.1 Gen 1.



Speed

Currently, there are 3 speed modes defined by the latest USB 3.0/USB 3.1 Gen 1 specification. They are Super-Speed, Hi-Speed and Full-Speed. The new SuperSpeed mode has a transfer rate of 4.8Gbps. While the specification retains Hi-Speed, and Full-Speed USB mode, commonly known as USB 2.0 and 1.1 respectively, the slower modes still operate at 480Mbps and 12Mbps respectively and are kept to maintain backward compatibility.

USB 3.0/USB 3.1 Gen 1 achieves the much higher performance by the technical changes below:

- An additional physical bus that is added in parallel with the existing USB 2.0 bus (refer to the picture below).
- USB 2.0 previously had four wires (power, ground, and a pair for differential data); USB 3.0/USB 3.1 Gen 1 adds four more for two pairs of differential signals (receive and transmit) for a combined total of eight connections in the connectors and cabling.
- USB 3.0/USB 3.1 Gen 1 utilizes the bidirectional data interface, rather than USB 2.0's half-duplex arrangement. This gives a 10-fold increase in theoretical bandwidth.

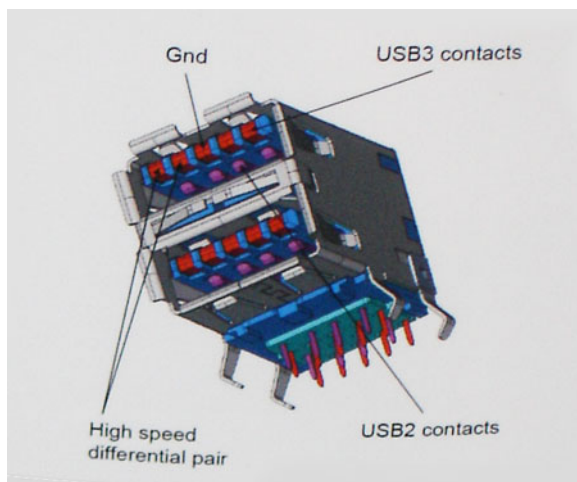

With today's ever increasing demands placed on data transfers with high-definition video content, terabyte storage devices, high megapixel count digital cameras etc., USB 2.0 may not be fast enough. Furthermore, no USB 2.0 connection could ever come close to the 480Mbps theoretical maximum throughput, making data transfer at around 320Mbps (40MB/s) — the actual real-world maximum. Similarly, USB 3.0/USB 3.1 Gen 1 connections will never achieve 4.8Gbps. We will likely see a real-world maximum rate of 400MB/s with overheads. At this speed, USB 3.0/USB 3.1 Gen 1 is a 10x improvement over USB 2.0.

Applications

USB 3.0/USB 3.1 Gen 1 opens up the laneways and provides more headroom for devices to deliver a better overall experience. Where USB video was barely tolerable previously (both from a maximum resolution, latency, and video compression perspective), it's easy to imagine that with 5-10 times the bandwidth available, USB video solutions should work that much better. Single-link DVI requires almost 2Gbps throughput. Where 480Mbps was limiting, 5Gbps is more than promising. With its promised 4.8Gbps speed, the standard will find its way into some products that previously weren't USB territory, like external RAID storage systems.

Listed below are some of the available SuperSpeed USB 3.0/USB 3.1 Gen 1 products:

- External Desktop USB 3.0/USB 3.1 Gen 1 Hard Drives
- Portable USB 3.0/USB 3.1 Gen 1 Hard Drives
- USB 3.0/USB 3.1 Gen 1 Drive Docks & Adapters
- USB 3.0/USB 3.1 Gen 1 Flash Drives & Readers
- USB 3.0/USB 3.1 Gen 1 Solid-state Drives
- USB 3.0/USB 3.1 Gen 1 RAIDs
- Optical Media Drives
- Multimedia Devices
- Networking
- USB 3.0/USB 3.1 Gen 1 Adapter Cards & Hubs

Compatibility

The good news is that USB 3.0/USB 3.1 Gen 1 has been carefully planned from the start to peacefully co-exist with USB 2.0. First of all, while USB 3.0/USB 3.1 Gen 1 specifies new physical connections and thus new cables to take advantage of the higher speed capability of the new protocol, the connector itself remains the same rectangular shape with the four USB 2.0 contacts in the exact same location as before. Five new connections to carry receive and transmitted data independently are present on USB 3.0/USB 3.1 Gen 1 cables and only come into contact when connected to a proper SuperSpeed USB connection.

Windows 8/10 will be bringing native support for USB 3.1 Gen 1 controllers. This is in contrast to previous versions of Windows, which continue to require separate drivers for USB 3.0/USB 3.1 Gen 1 controllers.

Microsoft announced that Windows 7 would have USB 3.1 Gen 1 support, perhaps not on its immediate release, but in a subsequent Service Pack or update. It is not out of the question to think that following a successful release of USB 3.0/USB 3.1 Gen 1 support in Windows 7, SuperSpeed support would trickle down to Vista. Microsoft has confirmed this by stating that most of their partners share the opinion that Vista should also support USB 3.0/USB 3.1 Gen 1.

USB Type-C

USB Type-C is a new, tiny physical connector. The connector itself can support various exciting new USB standards like USB 3.1 and USB power delivery (USB PD).

Alternate Mode

USB Type-C is a new connector standard that is very small. It is about a third the size of an old USB Type-A plug. This is a single connector standard that every device should be able to use. USB Type-C ports can support a variety of different protocols using "alternate modes," which allows you to have adapters that can output HDMI, VGA, DisplayPort, or other types of connections from that single USB port

USB Power Delivery

The USB PD specification is also closely intertwined with USB Type-C. Currently, smartphones, tablets, and other mobile devices often use a USB connection to charge. A USB 2.0 connection provides up to 2.5 watts of power — that'll charge your phone, but that's about it. A laptop might require up to 60 watts, for example. The USB Power Delivery specification ups this power delivery to 100 watts. It's bi-directional, so a device can either send or receive power. And this power can be transferred at the same time the device is transmitting data across the connection.

This could spell the end of all those proprietary laptop charging cables, with everything charging via a standard USB connection. You could charge your laptop from one of those portable battery packs you charge your smartphones and other portable devices from today. You could plug your laptop into an external display connected to a power cable, and that external display would charge your laptop as you used it as an external display — all via the one little USB Type-C connection. To use this, the device and the cable have to support USB Power Delivery. Just having a USB Type-C connection doesn't necessarily mean they do.

USB Type-C and USB 3.1

USB 3.1 is a new USB standard. USB 3's theoretical bandwidth is 5 Gbps same as of USB 3.1 Gen 1, while USB 3.1 Gen 2's bandwidth is 10 Gbps. That's double the bandwidth, as fast as a first-generation Thunderbolt connector. USB Type-C isn't the same thing as USB 3.1. USB Type-C is just a connector shape, and the underlying technology could just be USB 2 or USB 3.0. In fact, Nokia's N1 Android tablet uses a USB Type-C connector, but underneath it's all USB 2.0 — not even USB 3.0. However, these technologies are closely related.

Advantages of Displayport over USB Type-C

- Full DisplayPort audio/video (A/V) performance (up to 4K at 60Hz)
- Reversible plug orientation and cable direction
- Backwards compatibility to VGA, DVI with adaptors
- SuperSpeed USB (USB 3.1) data
- Supports HDMI 2.0a and is backwards compatible with previous versions

HDMI 2.0

This topic explains the HDMI 2.0 and its features along with the advantages.

HDMI (High-Definition Multimedia Interface) is an industry-supported, uncompressed, all-digital audio/video interface. HDMI provides an interface between any compatible digital audio/video source, such as a DVD player, or A/V receiver and a compatible digital audio and/or video monitor, such as a digital TV (DTV). The intended applications for HDMI TVs, and DVD players. The primary advantage is cable reduction and content protection provisions. HDMI supports standard, enhanced, or high-definition video, plus multichannel digital audio on a single cable.

HDMI 2.0 Features

- **HDMI Ethernet Channel** - Adds high-speed networking to an HDMI link, allowing users to take full advantage of their IP-enabled devices without a separate Ethernet cable
- **Audio Return Channel** - Allows an HDMI-connected TV with a built-in tuner to send audio data "upstream" to a surround audio system, eliminating the need for a separate audio cable
- **3D** - Defines input/output protocols for major 3D video formats, paving the way for true 3D gaming and 3D home theater applications
- **Content Type** - Real-time signaling of content types between display and source devices, enabling a TV to optimize picture settings based on content type
- **Additional Color Spaces** - Adds support for additional color models used in digital photography and computer graphics
- **4K Support** - Enables video resolutions far beyond 1080p, supporting next-generation displays that will rival the Digital Cinema systems used in many commercial movie theaters

- **HDMI Micro Connector** - A new, smaller connector for phones and other portable devices, supporting video resolutions up to 1080p
- **Automotive Connection System** - New cables and connectors for automotive video systems, designed to meet the unique demands of the motoring environment while delivering true HD quality

Advantages of HDMI

- Quality HDMI transfers uncompressed digital audio and video for the highest, crispest image quality.
- Low -cost HDMI provides the quality and functionality of a digital interface while also supporting uncompressed video formats in a simple, cost-effective manner
- Audio HDMI supports multiple audio formats from standard stereo to multichannel surround sound
- HDMI combines video and multichannel audio into a single cable, eliminating the cost, complexity, and confusion of multiple cables currently used in A/V systems
- HDMI supports communication between the video source (such as a DVD player) and the DTV, enabling new functionality

Disassembly and reassembly

Side cover

Removing side cover

- 1 Follow the procedure in [Before working inside your computer](#).
- 2 To remove the side cover:
 - a Remove the thumbscrew that secures the side cover to the system.



- b Slide the side cover towards the front of the system and lift the cover to remove from the system.

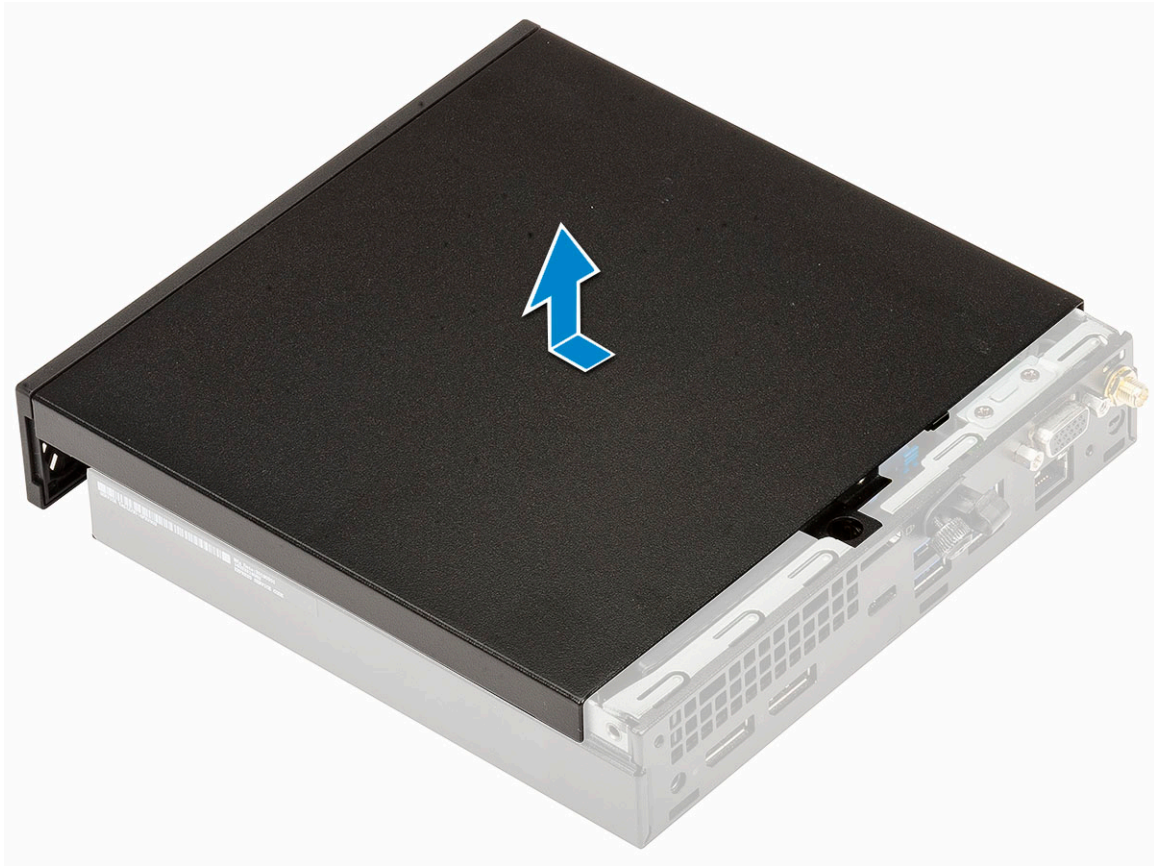

Installing side cover

- 1 To install the side cover:
 - a Place the side cover on the system.
 - b Slide the cover towards the back of the system to install it.

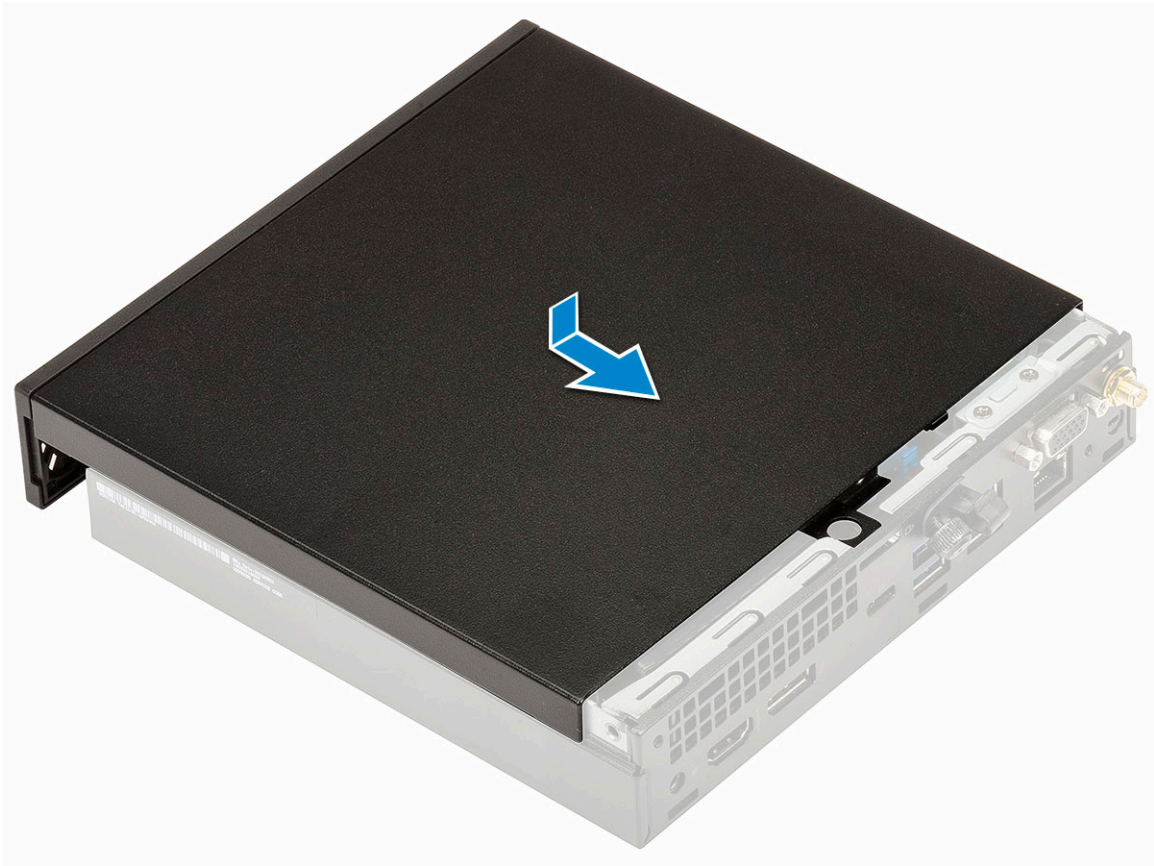

- c Replace the thumbscrew to secure the cover to the system.



- 2 Follow the procedure in [After working inside your computer](#).

2.5-inch hard drive assembly

Removing 2.5–inch hard drive assembly

- 1 Follow the procedure in [Before working inside your computer](#).
- 2 Remove the [Side cover](#).
- 3 To remove the drive assembly:
 - a Press the blue tabs on both sides of the hard drive assembly [1].
 - b Push the hard drive assembly to release it from the system and remove the hard drive assembly from the system [2].

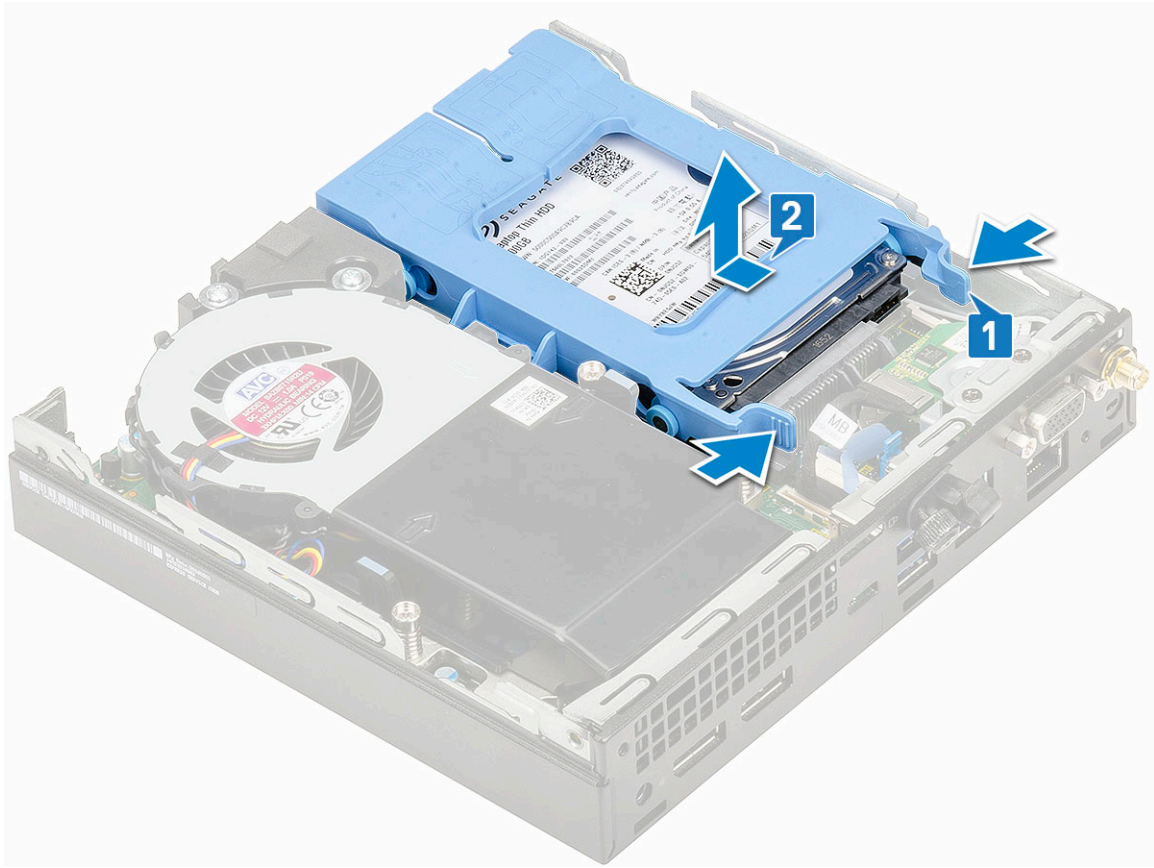

Installing 2.5-inch drive assembly

- 1 To install the hard drive assembly:
 - a Insert the hard drive assembly into the slot on the system.
 - b Slide the hard drive assembly towards the connector in the system board until it clicks into place.

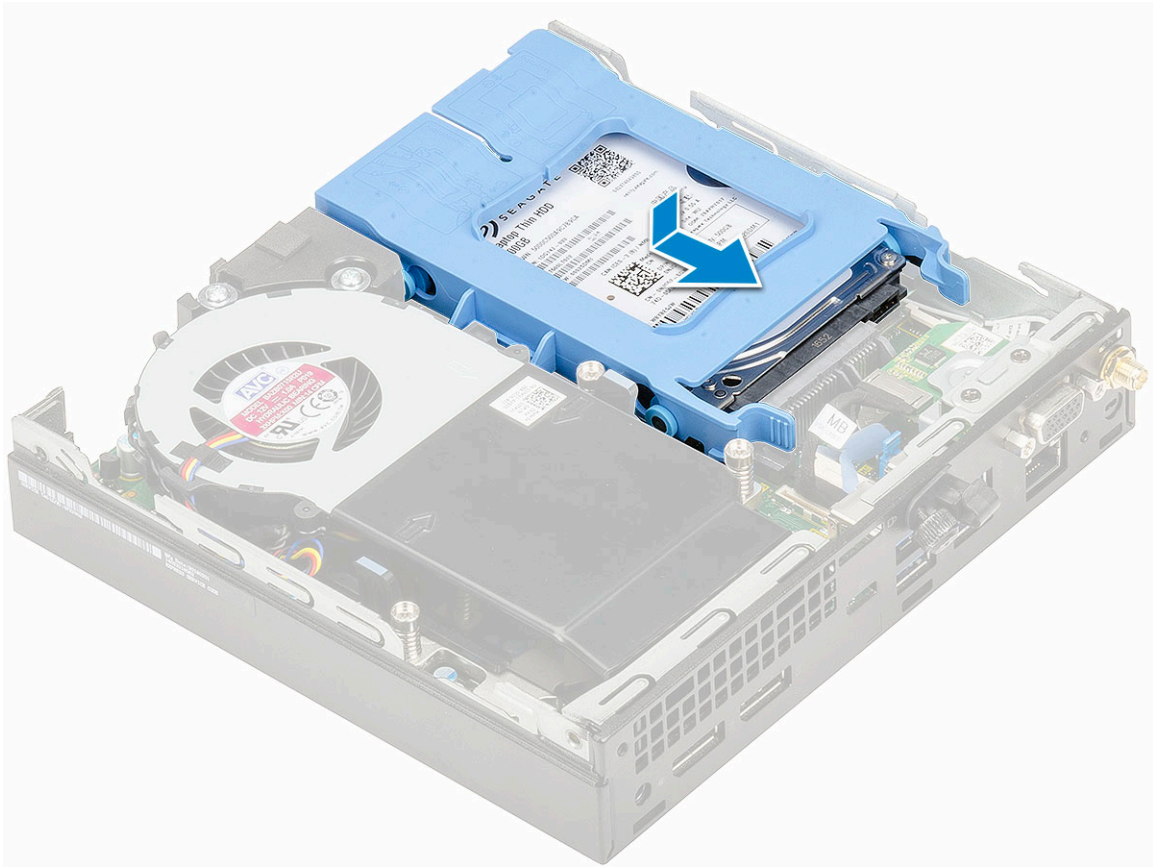

- 2 Install the [Side cover](#).
- 3 Follow the procedure in [After working inside your computer](#).

Hard drive

Removing the 2.5–inch drive from the drive bracket

- 1 Follow the procedure in [Before Working Inside Your Computer](#).
- 2 Remove the:
 - a [Side cover](#)
 - b [2.5 inch hard drive assembly](#)
- 3 To remove the drive bracket:
 - a Pull one side of the drive bracket to disengage the pins on the bracket from the slots on the drive [1] and lift the drive [2].

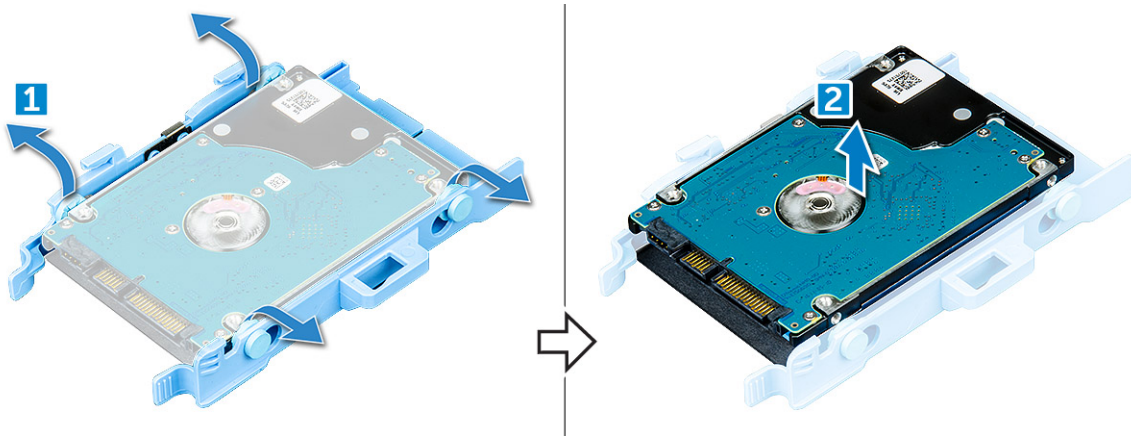

Installing the 2.5 inch hard drive into the drive bracket

- 1 Align and insert the pins on the drive bracket with the slots on one side of the drive.
- 2 Flex the other side of the drive bracket, and align and insert the pins on the bracket into the drive.
- 3 Install the:
 - a 2.5 inch hard drive assembly
 - b Side cover
- 4 Follow the procedure in [After working inside your computer](#).

System fan

Removing system fan

- 1 Follow the procedure in [Before working inside your computer](#).
- 2 Remove the [Side cover](#).
- 3 To remove the system fan:
 - a Press the blue tabs on both sides of the system fan [1].
 - b Slide and lift the system fan to release it from the system.
 - c Turn the system fan over to remove it from the system [2].



- 4 Disconnect the speaker cable and system fan cable from the connectors on the system board.

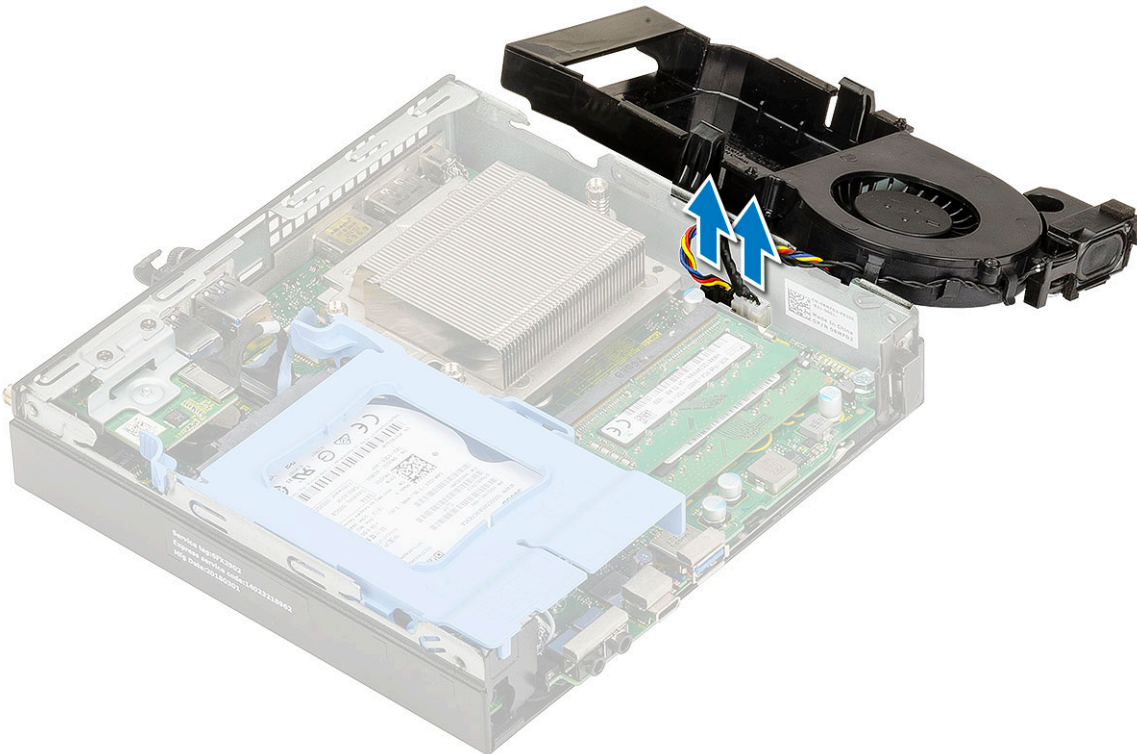

Installing system fan

- 1 To install the system fan:
 - a Connect the speaker cable and system fan cable to the connectors on the system board.

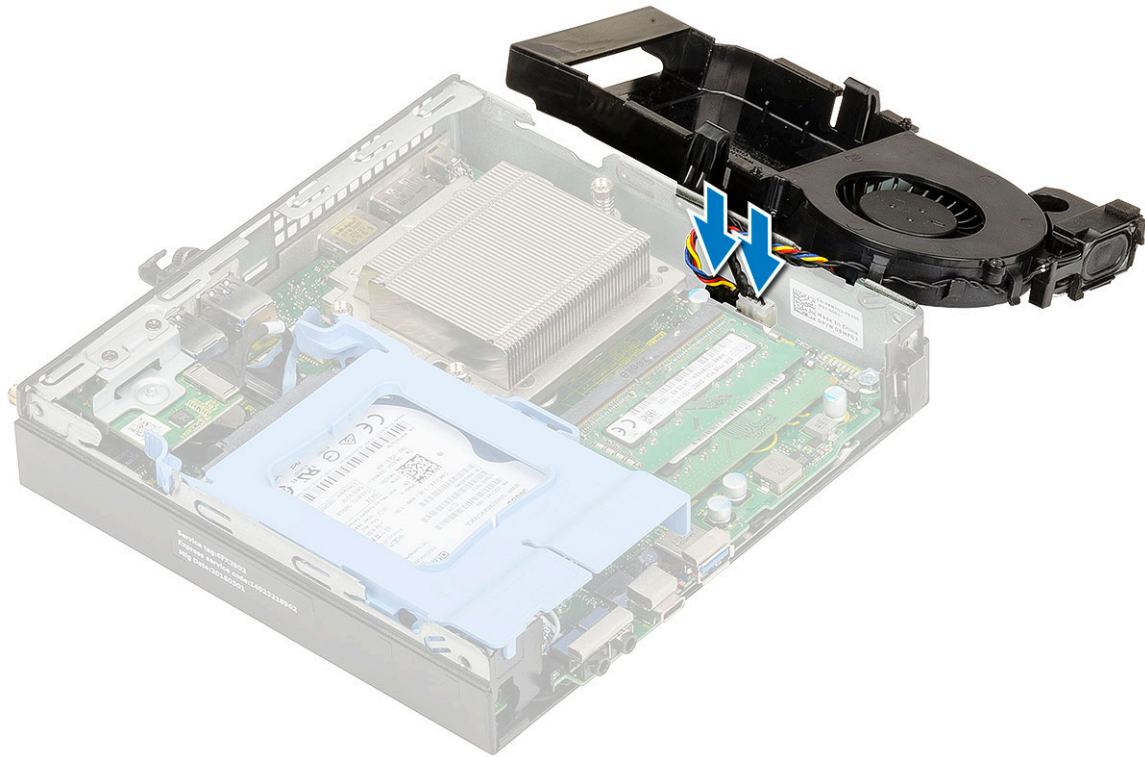

- b Place the system fan on the system and slide the system fan until it clicks into place.



- 2 Install the [Side cover](#).
- 3 Follow the procedure in [After working inside your computer](#).

Speaker

Removing speaker

- 1 Follow the procedure in [Before working inside your computer](#).
- 2 Remove the:
 - a [Side cover](#)
 - b [System fan](#)
- 3 To remove the speaker:
 - a Release the speaker cable from the retention hooks on the system fan [1].
 - b Remove the two (M2.5x4) screws that secure the speaker to the system fan [2].
 - c Remove the speaker from the system fan [3].

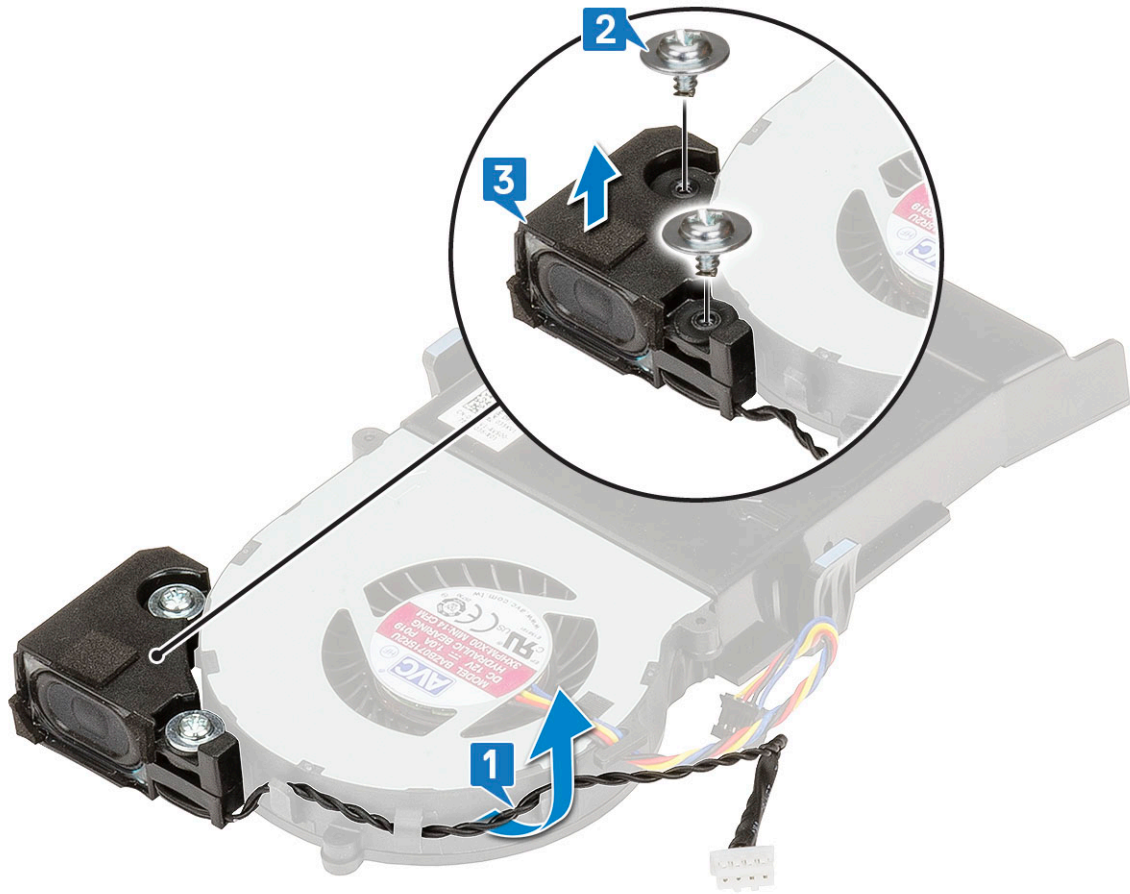

Installing speaker

- 1 To install the speaker:
 - a Align the slots on the speaker with the slots on the system fan [1].
 - b Replace the two (M2.5X4) screws to secure the speaker to the system fan [2].
 - c Route the speaker cable through the retention hooks on the system fan [3].

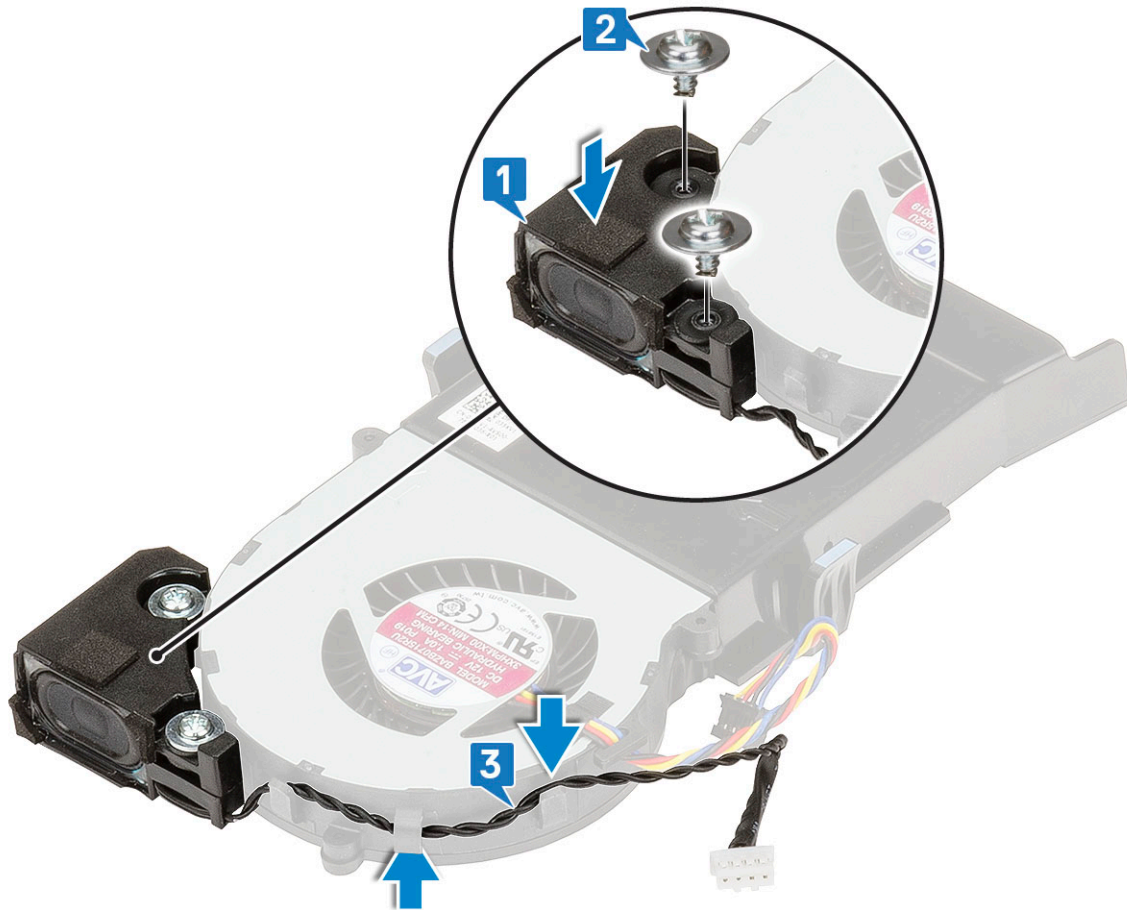

- 2 Install the:
 - a System fan
 - b Side cover
- 3 Follow the procedure in [After working inside your computer](#).

Memory modules

Removing memory module

- 1 Follow the procedure in [Before working inside your computer](#).
- 2 Remove the:
 - a Side cover
 - b System fan
- 3 To remove the memory module:
 - a Pull the securing clips from the memory module until the memory module pops up [1].
 - b Remove the memory module from the socket on the system board [2].

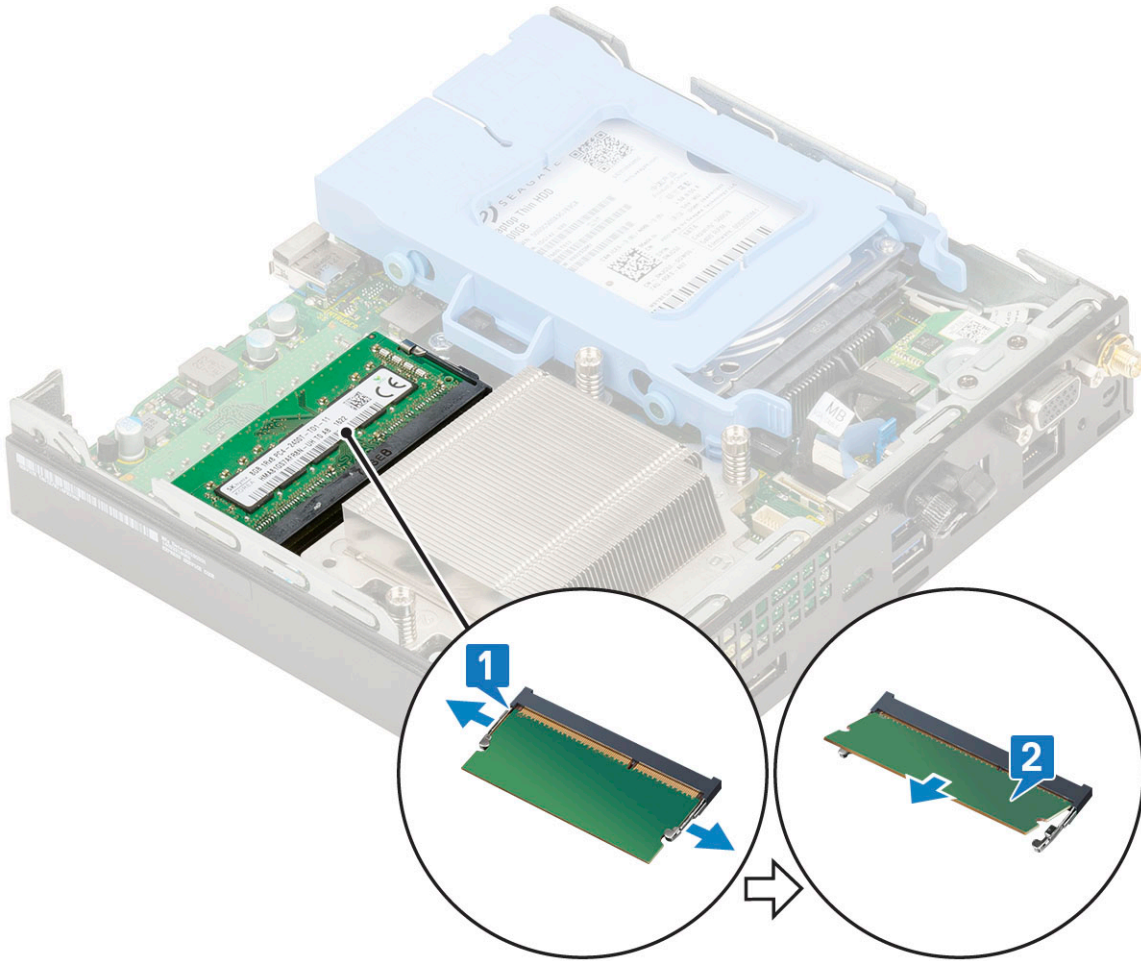

Installing memory module

- 1 To install the memory module:
 - a Align the notch on the memory module with the tab on the memory module connector.
 - b Insert the memory module into the memory module socket [1] and press it until it clicks into place [2].

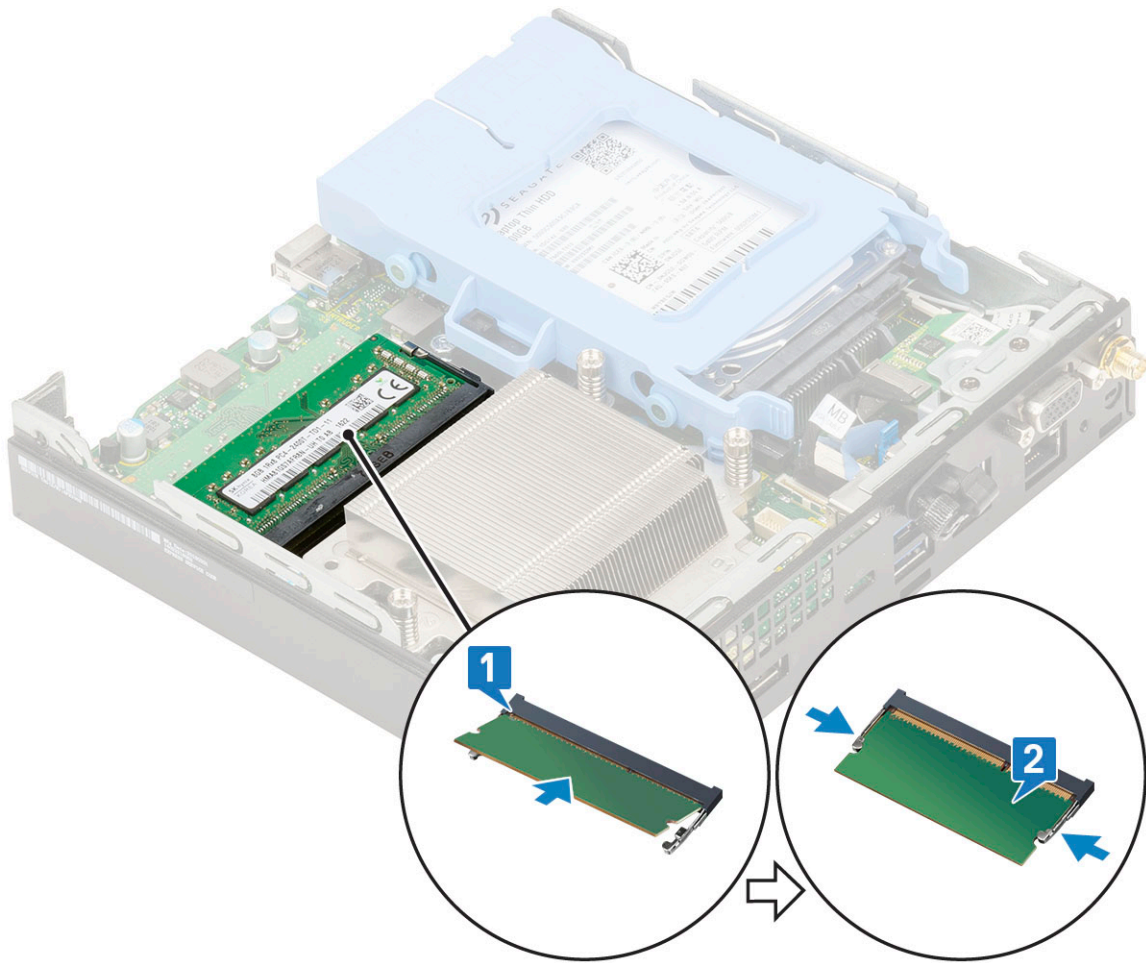

- 2 Install the:
 - a [System fan](#)
 - b [Side cover](#)
- 3 Follow the procedure in [After working inside your computer](#).

Heat sink

Removing heat sink

- 1 Follow the procedure in [Before working inside your computer](#).
- 2 Remove the:
 - a [Side cover](#)
 - b [2.5 inch hard drive assembly](#)
 - c [System fan](#)
- 3 To remove the heat sink:
 - a Loosen the three(M3) captive screws that secure the heat sink to the system [1].

NOTE: The heatsink is secured to the system board with four screws and three screws for 35 W and 65 W CPU respectively.
 - b Lift the heat sink away from the system [2].

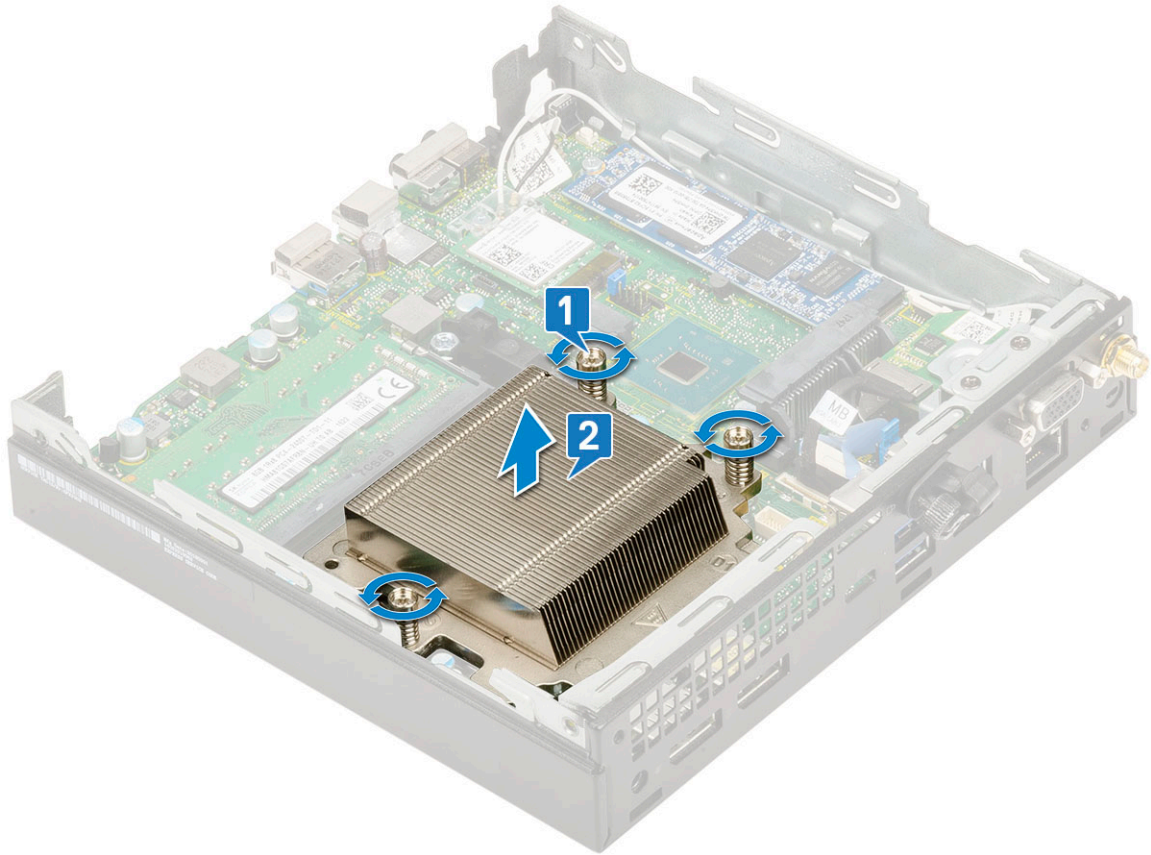

Installing heat sink

- 1 To install the heat sink:
 - a Place the heat sink on the processor [1].
 - b Tighten the three (M3) captive screws to secure the heat sink to the system board [2].

NOTE: The heatsink assembly is secured to the system board with four screws and three screws for 35 W and 65 W CPU respectively.

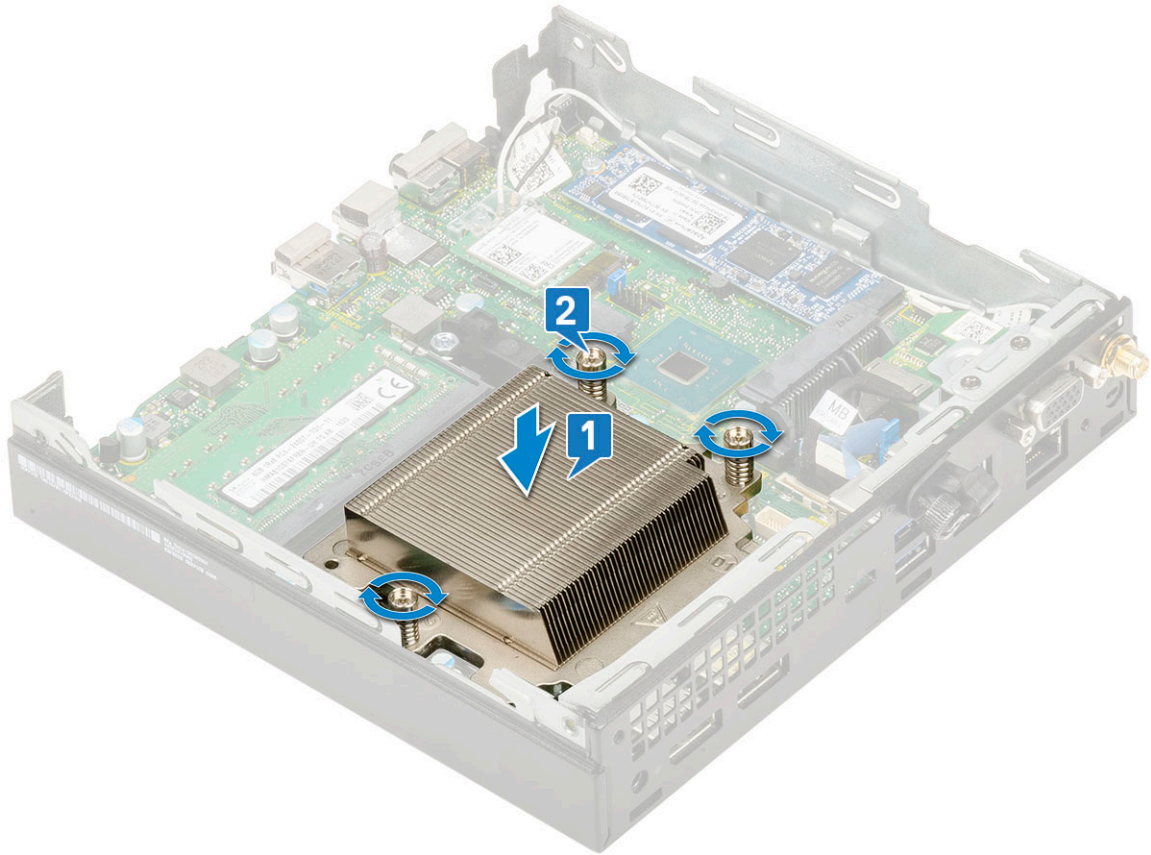

- 2 Install the:
 - a System fan
 - b 2.5-inch hard drive assembly
 - c Side cover
- 3 Follow the procedure in [After working inside your computer](#).

Processor

Removing processor

- 1 Follow the procedure in [Before Working Inside Your Computer](#).
- 2 Remove the:
 - a Side cover
 - b 2.5 inch hard drive assembly
 - c System fan
 - d Heat sink
- 3 To remove the processor:
 - a Release the socket lever by pushing the lever down and out from under the tab on the processor shield [1].
 - b Lift the lever upward and lift the processor shield [2].

CAUTION: The processor socket pins are fragile and can be permanently damaged. Be careful not to bend the pins in the processor socket when removing the processor out of the socket.

- c Lift the processor out of the socket [3].

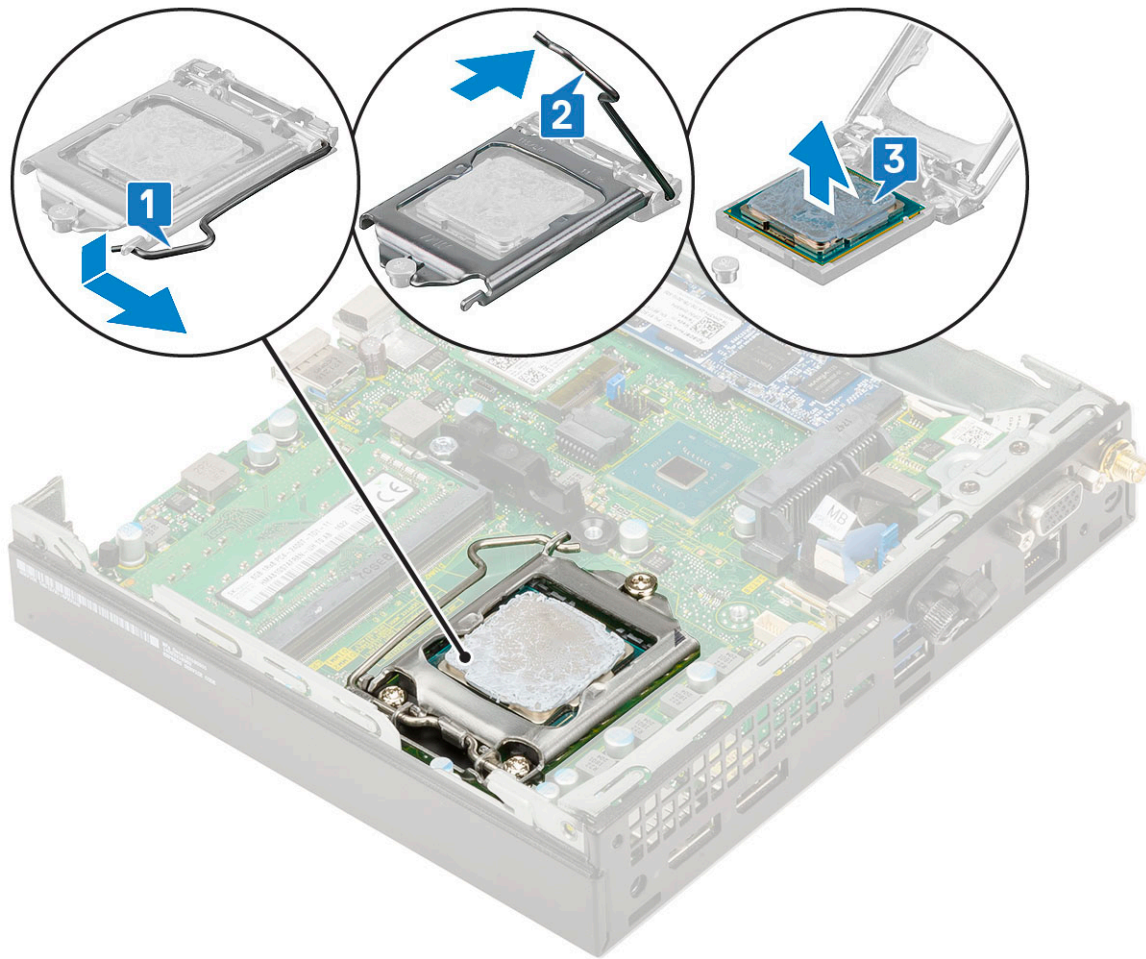

NOTE: After removing the processor, place it in an antistatic container for reuse, return, or temporary storage. Do not touch the bottom of the processor to avoid damage to the processor contacts. Touch only the side edges of the processor.

Installing processor

1 To install the processor:

- a Place the processor on the socket such that the slots on the processor align with the socket keys [1].

CAUTION: Do not use force to seat the processor. When the processor is positioned correctly, it engages easily into the socket.

- b Close the processor shield by sliding it under the retention screw [2].
- c Lower the socket lever and push it under the tab to lock it [3].

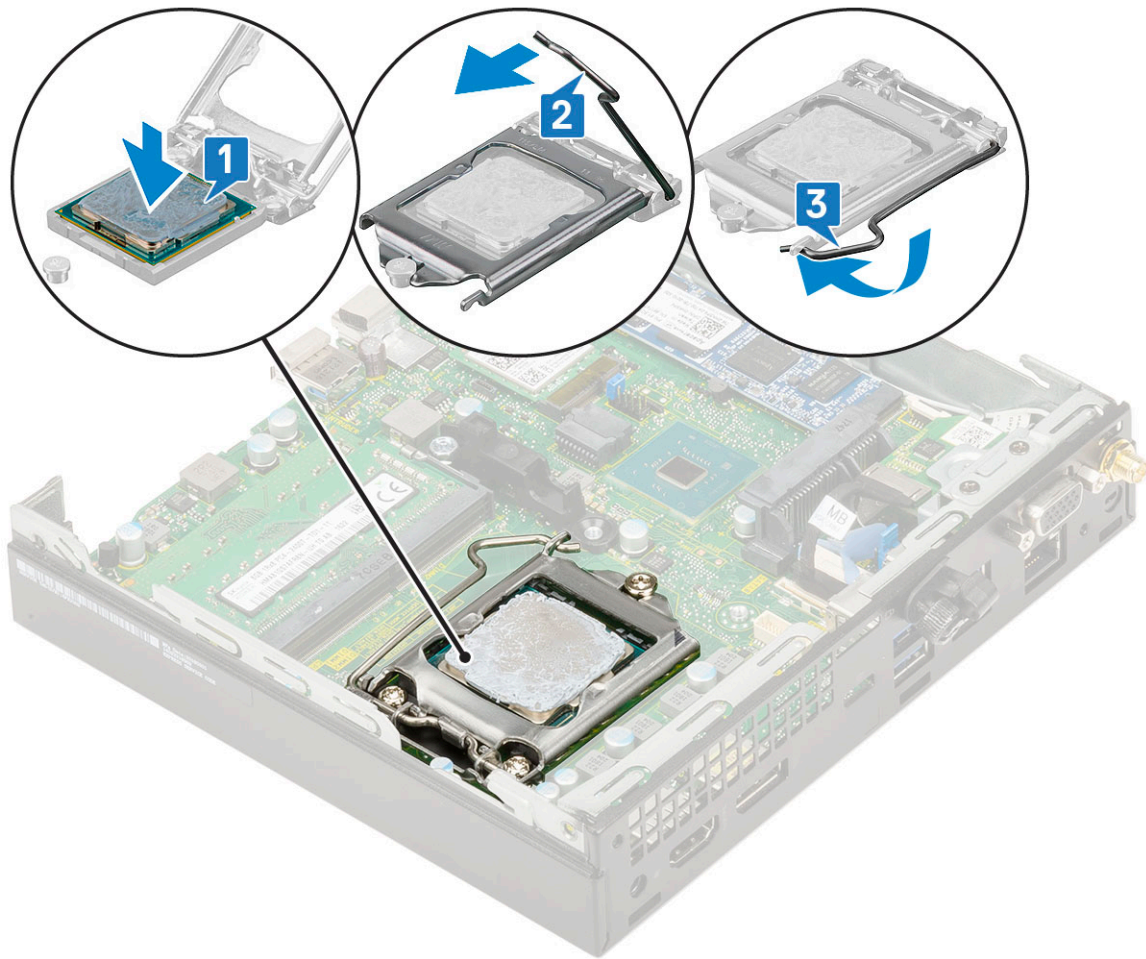

- 2 Install the:
 - a Heat sink
 - b System fan
 - c 2.5-inch hard drive assembly
 - d Side cover
- 3 Follow the procedure in [After working inside your computer](#).

WLAN card

Removing the WLAN card

- 1 Follow the procedure in [Before working inside your computer](#).
- 2 Remove the:
 - a Side cover
 - b 2.5 inch hard drive assembly
- 3 To remove the WLAN card:
 - a Remove the single (M2X3.5) screw that secures the plastic tab to the WLAN card [1].
 - b Remove the plastic tab to access the WLAN antenna cables [2].
 - c Disconnect the WLAN antenna cables from the connectors on the WLAN card [3].
 - d Lift the WLAN card from the connector on the system board [4].

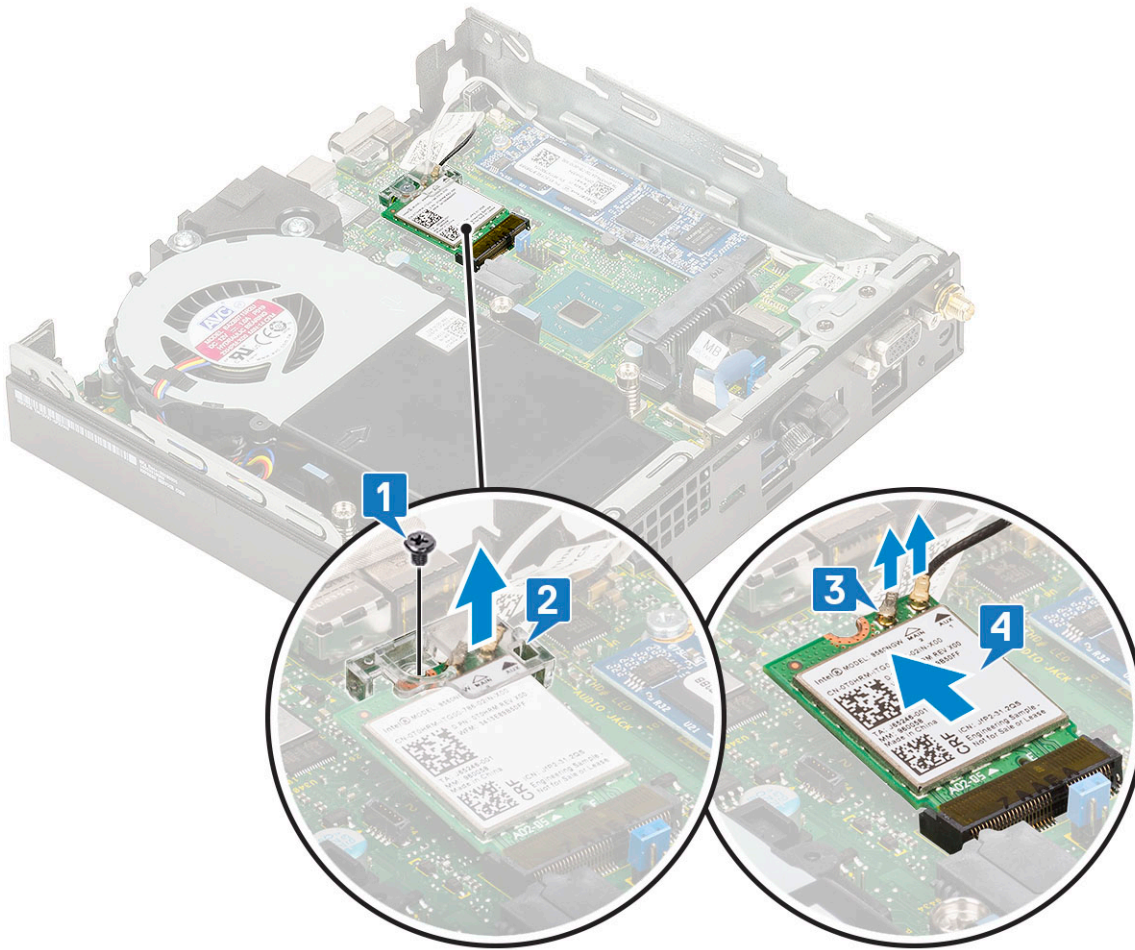

Installing the WLAN card

- 1 To install the WLAN card:
 - a Insert the WLAN card into the connector on the system board [1].
 - b Connect the WLAN antenna cables to the connectors on the WLAN card [2].
 - c Place the plastic tab to secure the WLAN cables [3].
 - d Replace the single (M2X3.5) screw to secure the plastic tab to the WLAN card [4].

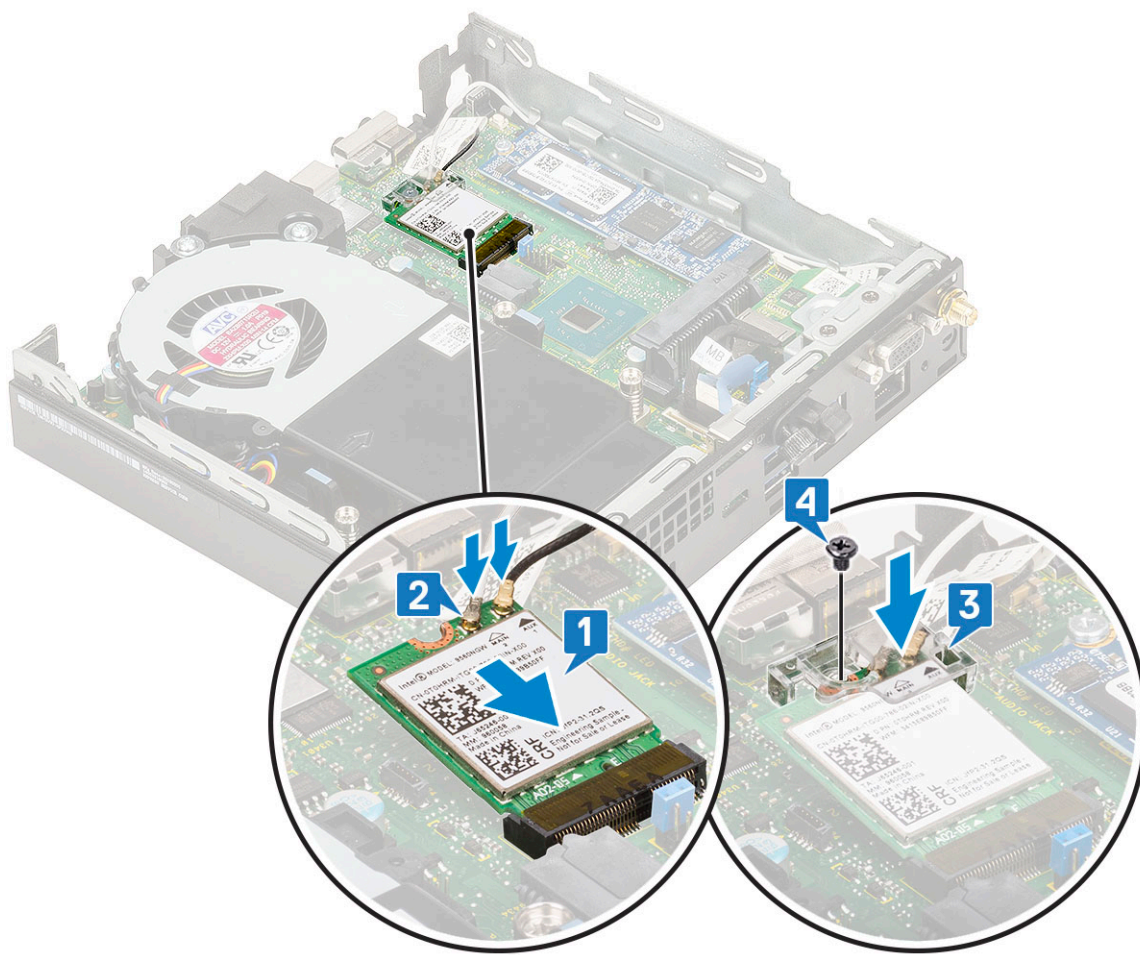

- 2 Install the:
 - a 2.5 inch hard drive assembly
 - b Side cover
- 3 Follow the procedure in [After working inside your computer](#).

M.2 PCIe SSD

Removing the M.2 PCIe SSD

NOTE: The instructions are applicable to M.2 SATA SSD also.

- 1 Follow the procedure in [Before working inside your computer](#).
- 2 Remove the:
 - a Side cover
 - b 2.5 inch hard drive assembly
- 3 To remove the M.2 PCIe SSD:
 - a Remove the single (M2X3.5) screw that secures the M.2 PCIe SSD to the system board [1].
 - b Lift and pull out the PCIe SSD from its connector on the system board [2].

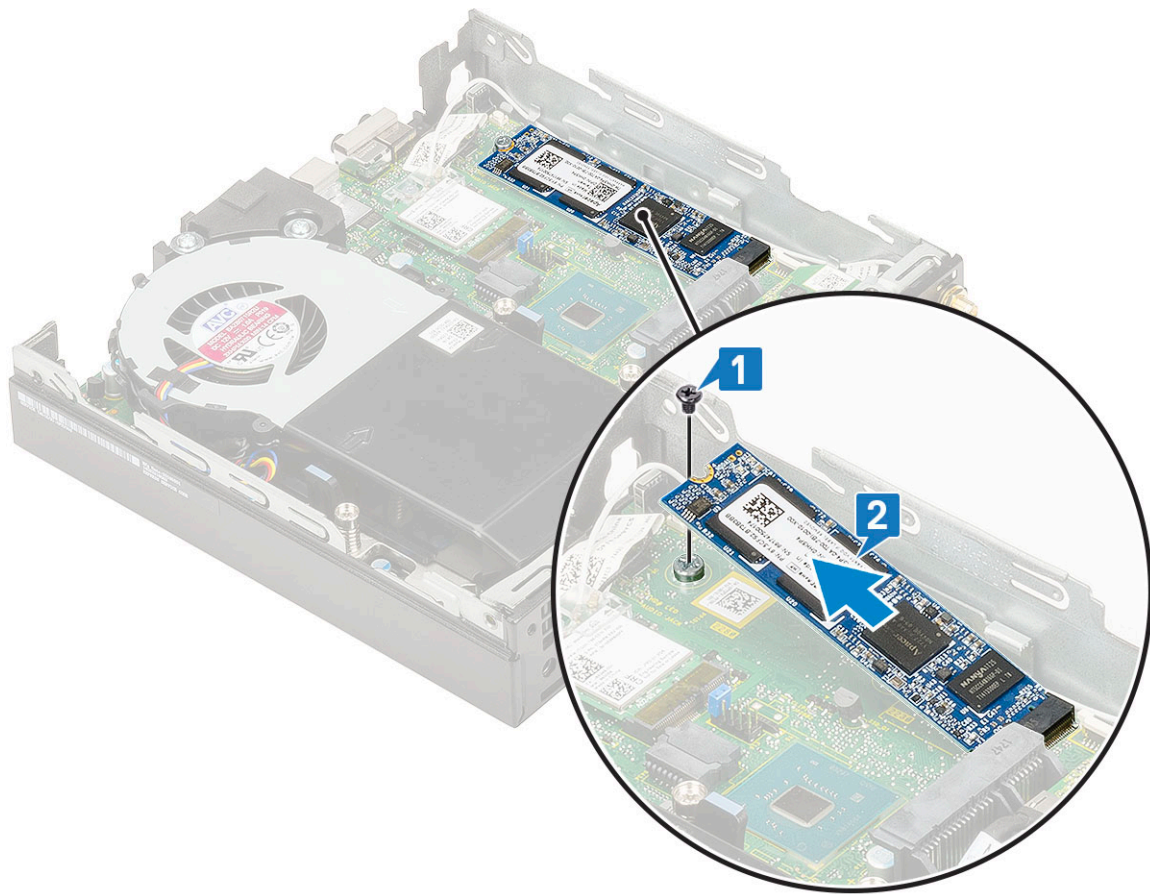

Installing the M.2 PCIe SSD

① | **NOTE:** The instructions are applicable to M.2 SATA SSD also.

- 1 To install M.2 PCIe SSD:
 - a Insert the M.2 PCIe SSD to the connector in the system board [1].
 - b Replace the single (M2X3.5) screw that secures the M.2 PCIe SSD to the system board [2].

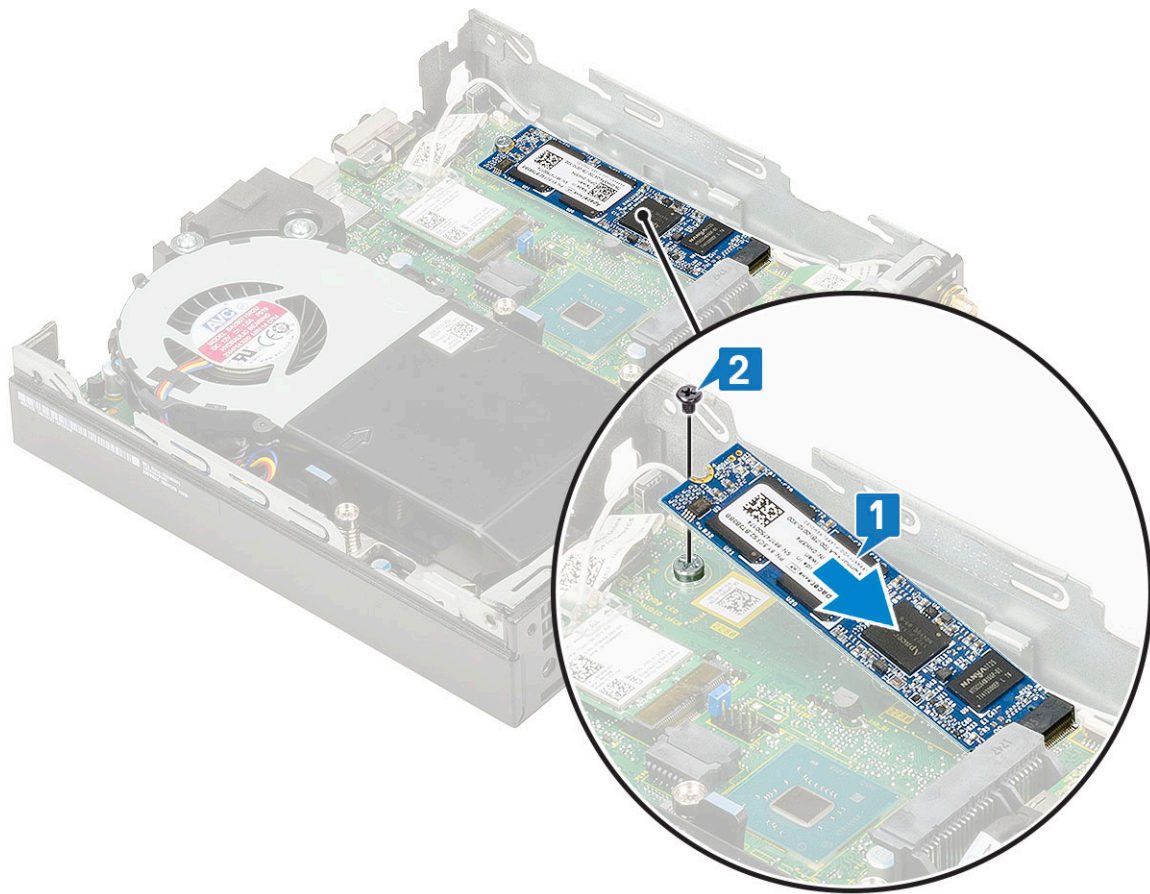

- 2 Install the:
 - a [2.5 inch hard drive assembly](#)
 - b [Side cover](#)
- 3 Follow the procedure in [After working inside your computer](#).

Coin-cell battery

Removing coin cell battery

- 1 Follow the procedure in [Before working inside your computer](#).
- 2 Remove the:
 - a [Side cover](#)
 - b [Optional module](#)
- 3 To remove the coin cell battery:
 - a Press the release latch until the coin cell battery pops out [1].
 - b Remove the coin cell battery from the system board [2].



Installing coin cell battery

- 1 To install the coin cell battery:
 - a Hold the coin cell battery with the "+" sign facing up and slide it under the securing tabs at the positive side of the connector on the system board [1].
 - b Press the battery into the connector until it locks into place [2].

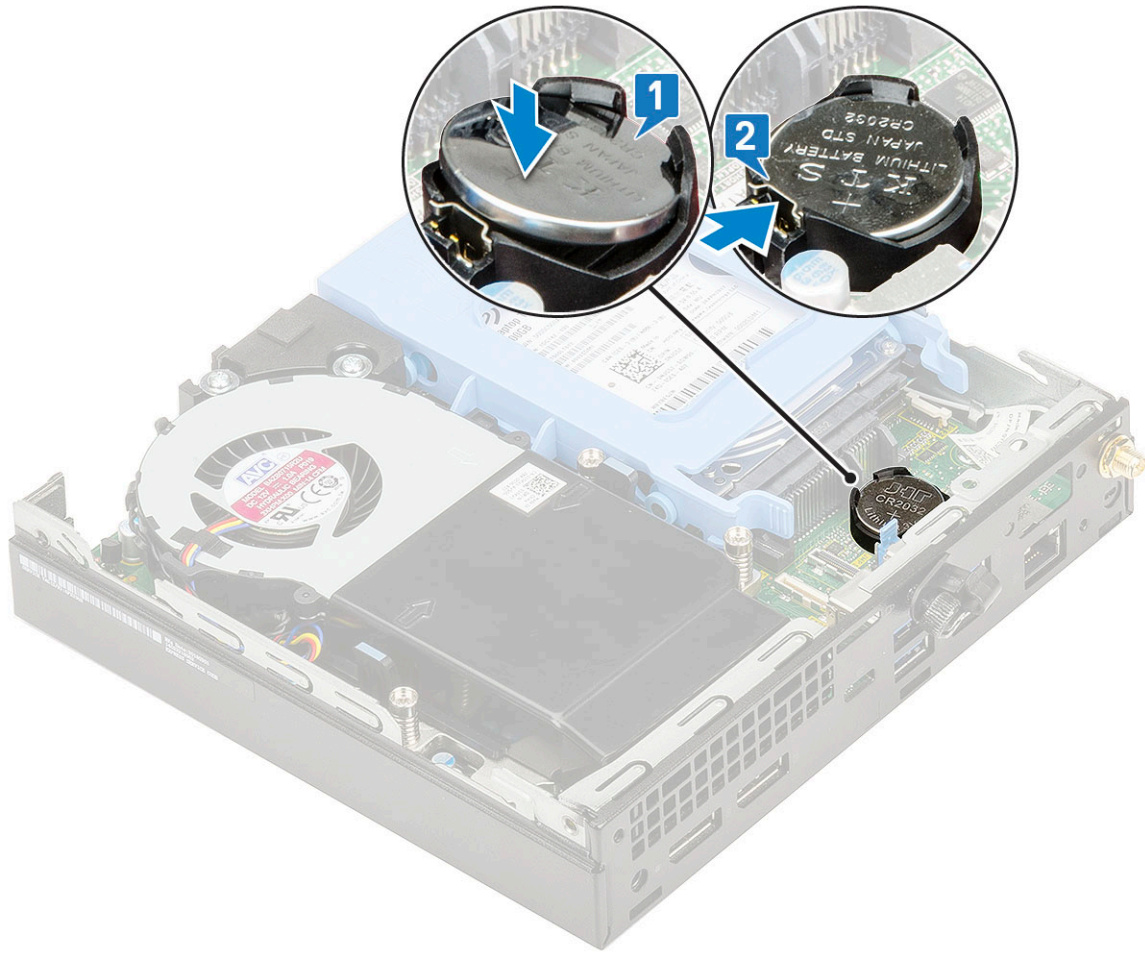

- 2 Install the
 - a [Side cover](#)
 - b [Optional module](#)
- 3 Follow the procedure in [After working inside your computer](#).

Optional module

Removing optional module

- 1 Follow the procedure in [Before working inside your computer](#).
- 2 Remove the :
 - a [Side cover](#)
 - b [2.5 inch hard drive assembly](#)
- 3 To remove the optional card:
 - a Disconnect the optional-card cable from the connector on the system board [1].
 - b Remove the four screws that secure the optional card to the system chassis [2, 3].

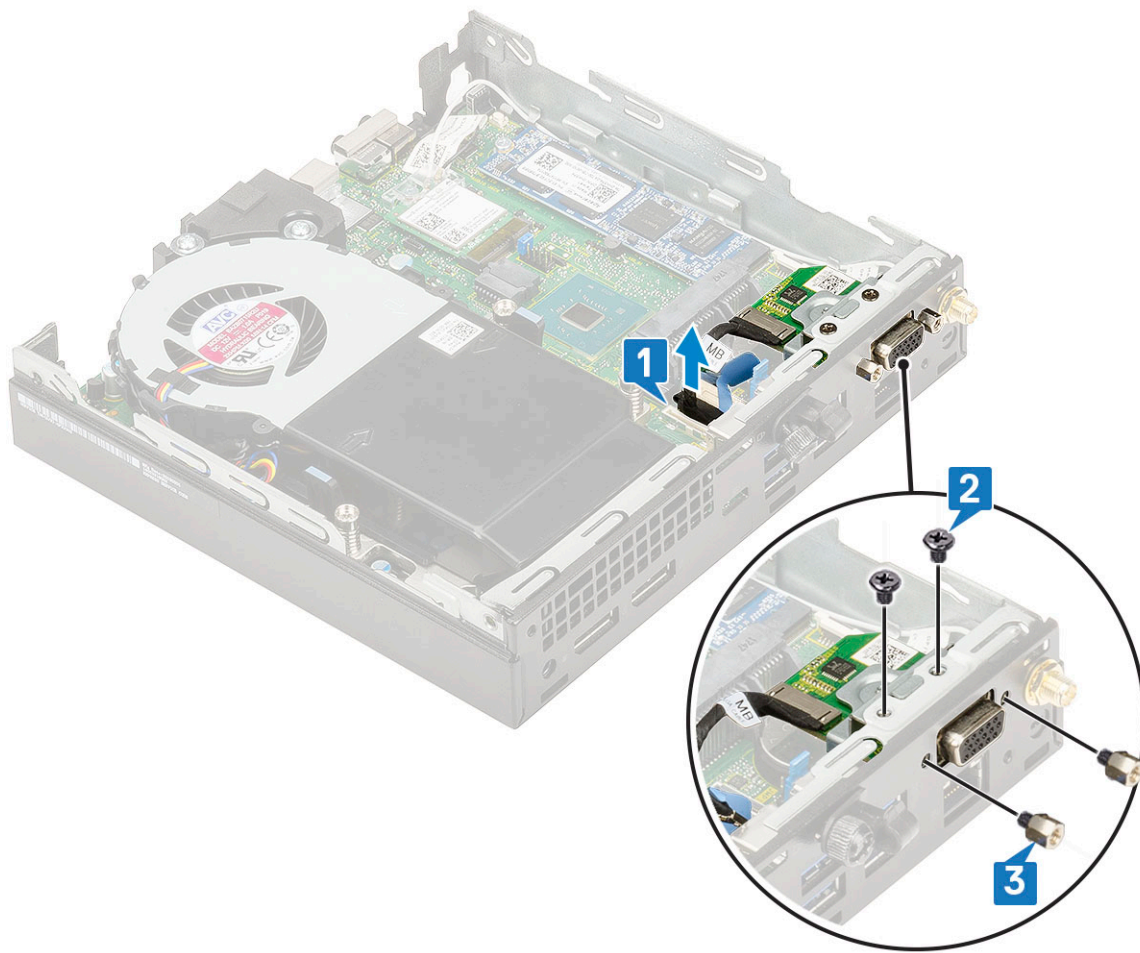

c Pull and lift the optional card away from the system.

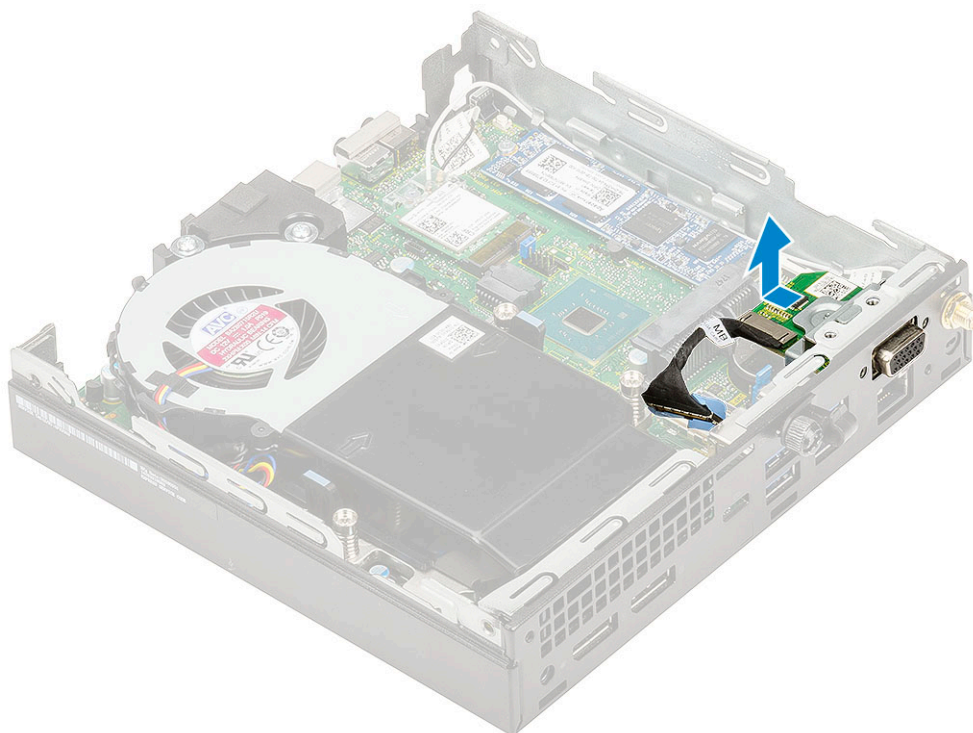

Installing optional module

- 1 To install the optional card:
 - a Place and align the optional card to its place in the system.

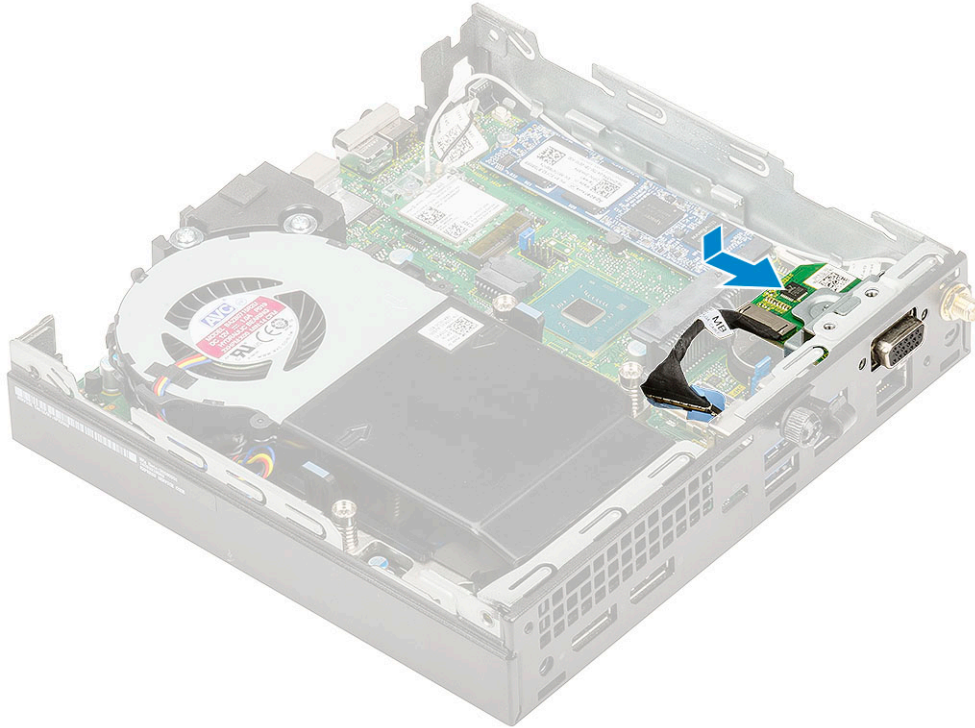

- b Replace the four screws to secure the optional card to the system chassis [1,2]
 - c Connect the optional card cable to the connector in the system board [3].

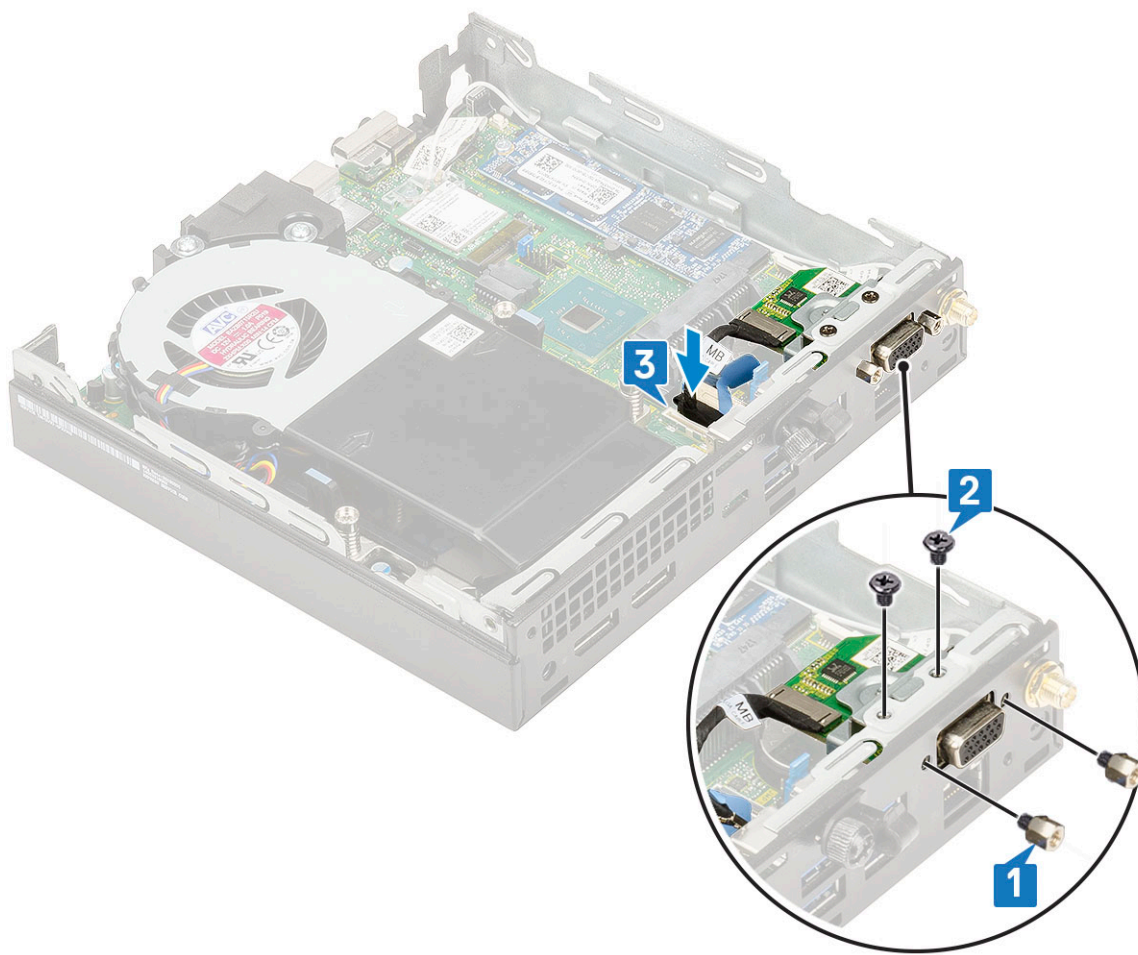

- 2 Install the:
 - a Side cover
 - b 2.5 inch hard drive assembly
- 3 Follow the procedure in [After working inside your computer](#).

System board

Removing system board

- 1 Follow the procedure in [Before working inside your computer](#).
- 2 Remove the:
 - a Side cover
 - b 2.5 hard drive assembly
 - c System fan
 - d WLAN
 - e M.2 PCIe SSD
 - f Memory module
 - g Optional module
 - h Heat sink
 - i Processor
- 3 To remove the HDD caddy support:
 - a Remove the screw that secures the HDD caddy support to the system board [1].
 - b Lift the HDD caddy support away from the system board [2].

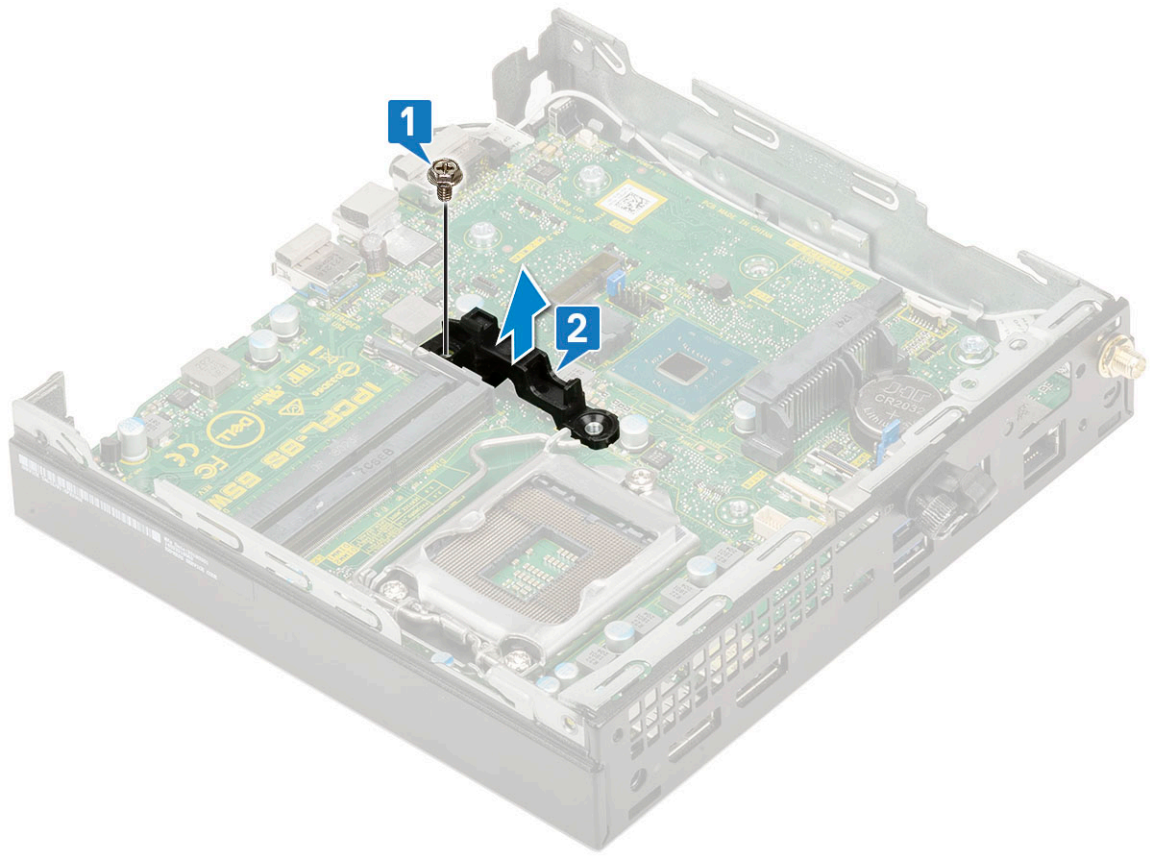

- 4 To remove the system board:
 - a Remove the two (M3x4) screws [1] and three (6-32x5.4) screws [2] that secure the system board to the system.

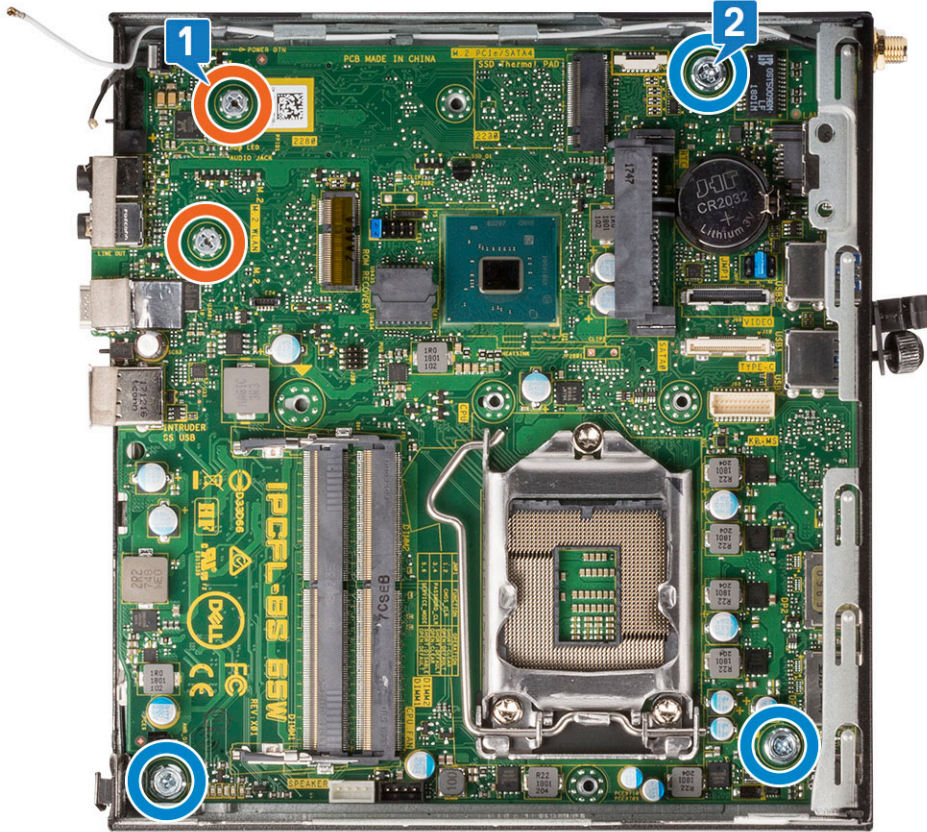

- b Lift the system board to disengage the connectors from the back of the computer [1].
- c Slide the system board away from the computer [2].

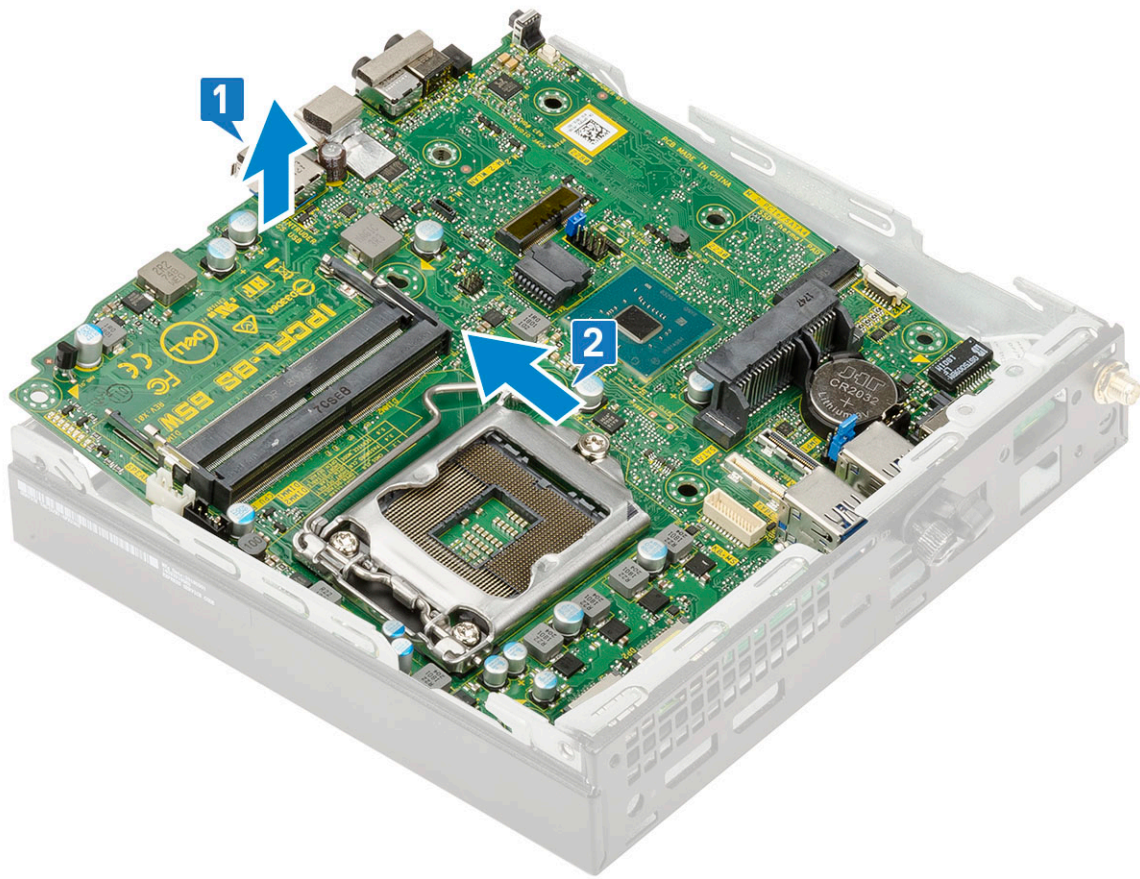

Installing system board

- 1 To install the system board:
 - a Hold the system board by its edges and angle it towards the back of the system.
 - b Lower the system board into the system until the connectors at the back of the system board align with the slots on the chassis, and the screw holes on the system board align with the standoffs on the system [1,2].

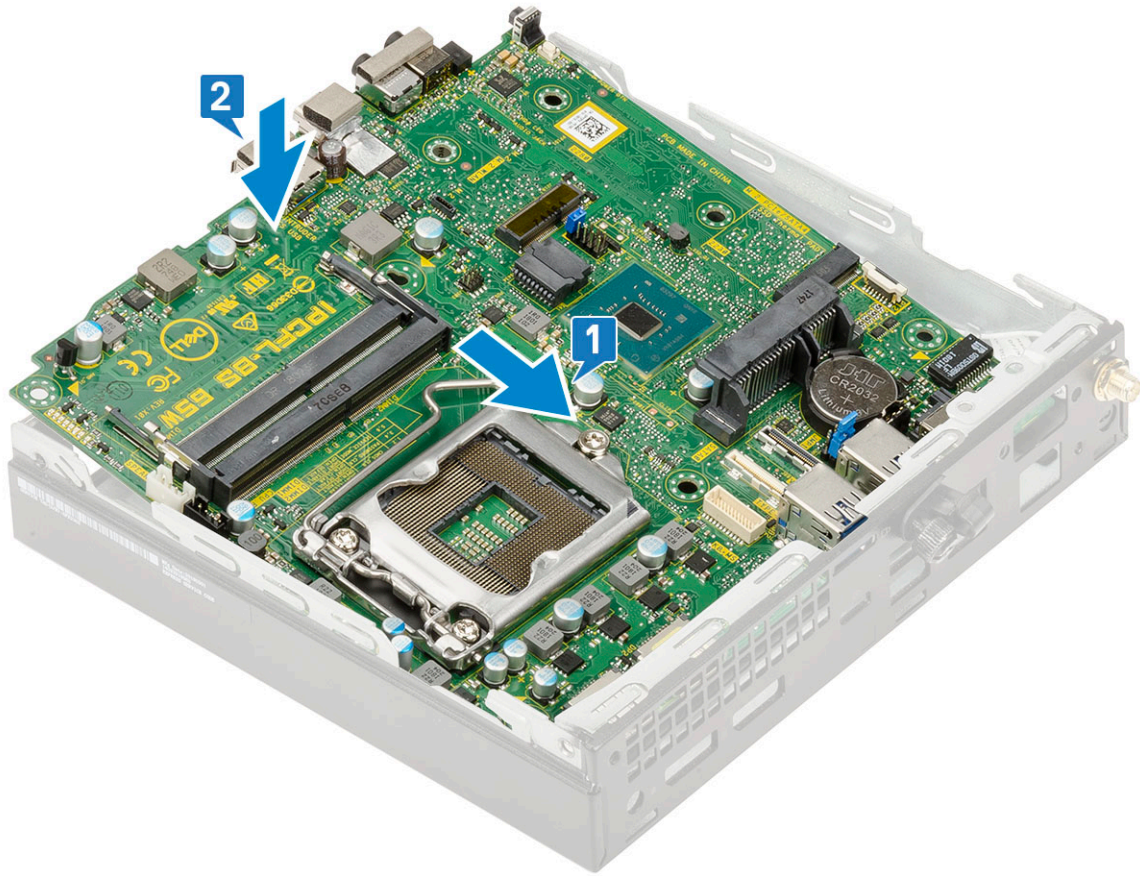

- c Replace the two (M3x4) screws [1] and three (6-32x5.4) screws [2] to secure the system board to the system.

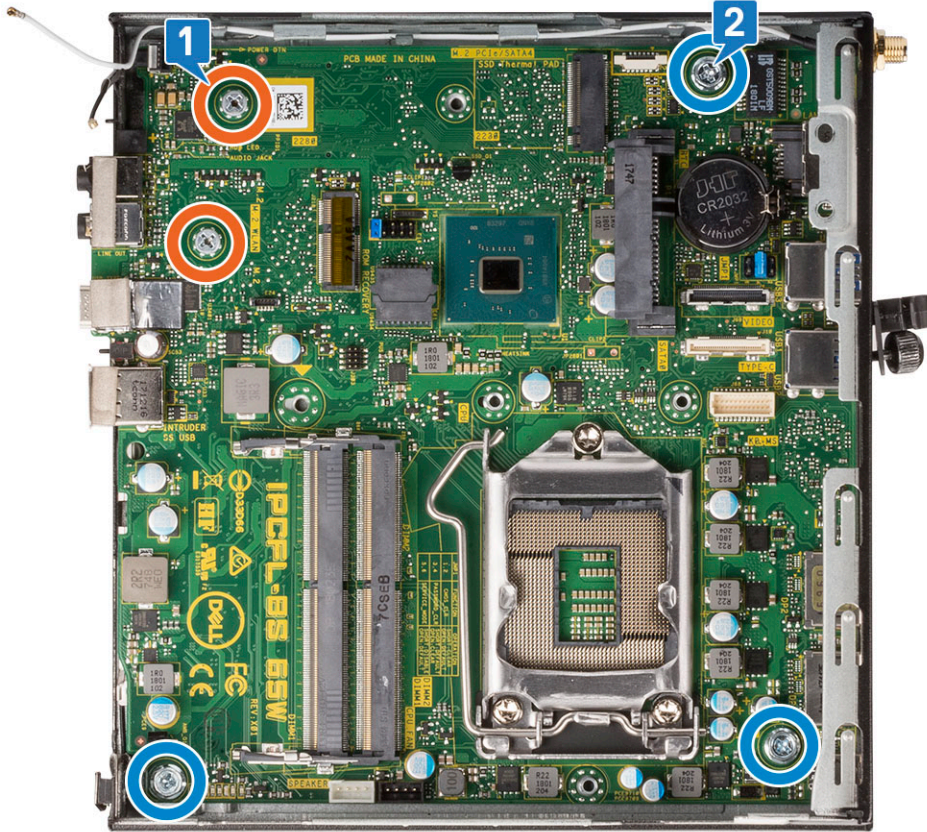

- d Place the HDD caddy support on the system board [1].
- e Replace the screw that secures the HDD caddy support to the system board [2].

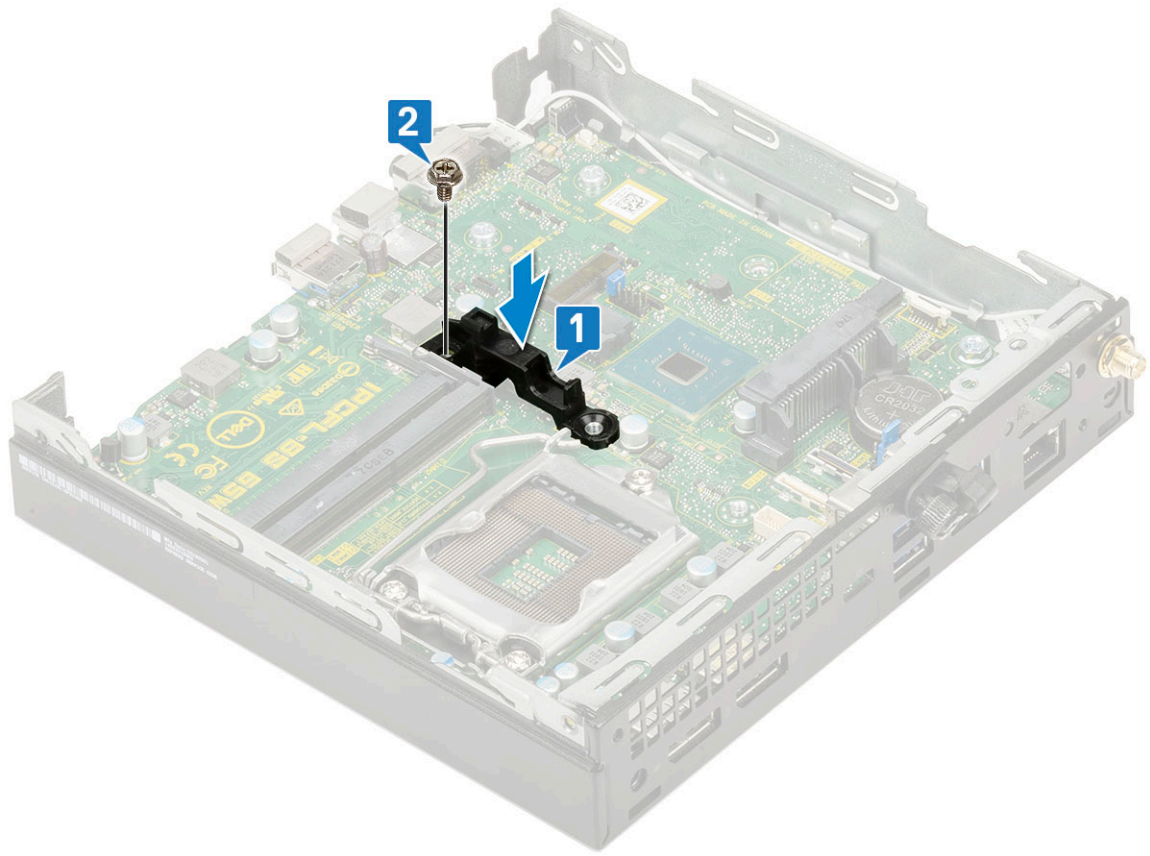

- 2 Install the:
 - a Processor
 - b Heat sink
 - c Memory module
 - d Optional module
 - e M.2 PCIe SSD
 - f WLAN
 - g System fan
 - h 2.5 inch hard drive assembly
 - i Side cover
- 3 Follow the procedure in [After working inside your computer](#).

Troubleshooting

Enhanced Pre-Boot System Assessment — ePSA diagnostics

The ePSA diagnostics (also known as system diagnostics) performs a complete check of your hardware. The ePSA is embedded with the BIOS and is launched by the BIOS internally. The embedded system diagnostics provides a set of options for particular devices or device groups allowing you to:

- Run tests automatically or in an interactive mode
- Repeat tests
- Display or save test results
- Run thorough tests to introduce additional test options to provide extra information about the failed device(s)
- View status messages that inform you if tests are completed successfully
- View error messages that inform you of problems encountered during testing

⚠ CAUTION: Use the system diagnostics to test only your computer. Using this program with other computers may cause invalid results or error messages.

ⓘ NOTE: Some tests for specific devices require user interaction. Always ensure that you are present at the computer terminal when the diagnostic tests are performed.

Running the ePSA Diagnostics

- 1 Invoke diagnostics boot by either of the methods suggested above
- 2 Once on one time boot menu use up/down arrow key to navigate to ePSA or diagnostics and press <return> key to launch
Fn+PWR will flash diagnostics boot selected on screen and launch ePSA/diagnostics directly.
- 3 On the boot menu screen, select the **Diagnostics** option.
- 4 Press the arrow in the lower-right corner to go to the page listing.
The items detected are listed and will be tested
- 5 If there are any issues, error codes are displayed.
Note the error code and validation number and contact Dell.

To run a diagnostic test on a specific device

- 1 Press Esc and click **Yes** to stop the diagnostic test.
- 2 Select the device from the left pane and click **Run Tests**.
- 3 If there are any issues, error codes are displayed.
Note the error code and validation number and contact Dell.

Diagnostics

The computer POST (Power On Self Test) ensures that it meets the basic computer requirements and the hardware is working appropriately before the boot process begins. If the computer passes the POST, the computer continues to start in a normal mode.

However, if the computer fails the POST, the computer emits a series of LED codes during the start-up. The system LED is integrated on the Power button.

The following table shows different light patterns and what they indicate.

Table 2. Power LED summary

Amber LED state	White LED state	System state	Notes
Off	Off	S5	
Off	Blinking	S3, no PWRGD_PS	
Previous State	Previous State	S3, no PWRGD_PS	This entry provides for the possibility of a delay from SLP_S3# active to PWRGD_PS inactive.
Blinking	Off	S0, no PWRGD_PS	
Steady	Off	S0, no PWRGD_PS, Code fetch = 0	
Off	Steady	S0, no PWRGD_PS, Code fetch = 1	This indicates that the host BIOS has started to execute and the LED register is now writable.

Table 3. Amber LED blinking failures

Amber LED state	White LED state	System state	Notes
2,1		Bad MBD	Bad MBD - Rows A, G, H, and J from table 12.4 of SIO Spec - Pre-Post indicators [40]
2,2		Bad MB, PSU or cabling	Bad MBD, PSU or PSU cabling - Rows B, C and D of table 12.4 SIO spec [40]
2,3		Bad MBD, DIMMS, or CPU	Bad MBD, DIMMS or CPU - Rows F and K from table 12.4 of SIO spec [40]
2,4		Bad coin cell	Bad coin cell - Row M of table 12.4 in SIO spec [40]

Table 4. States Under Host BIOS Control

Amber LED state	White LED state	System state	Notes
2,5		BIOS state 1	BIOS Post code (Old LED pattern 0001) Corrupt BIOS.
2,6		BIOS state 2	BIOS Post code (Old LED pattern 0010) CPU config or CPU failure.
2,7		BIOS state 3	BIOS Post code (Old LED pattern 0011) MEM config in process. Appropriate mem modules detected but failure has occurred.
3,1		BIOS state 4	BIOS Post code (Old LED pattern 0100) Combine PCI device config or failure with

Amber LED state	White LED state	System state	Notes
			video sub sytem config or failure. BIOS to eliminate 0101 video code.
3,2		BIOS state 5	BIOS Post code (Old LED pattern 0110) Combine storage and USB config or failure. BIOS to eliminate 0111 USB code.
3,3		BIOS state 6	BIOS Post code (Old LED pattern 1000) MEM config, no memory detected.
3,4		BIOS state 7	BIOS Post code (Old LED pattern 1001) Fatal Motherboard error.
3,5		BIOS state 8	BIOS Post code (Old LED pattern 1010) Mem config, modules incompatible or invalid config.
3,6		BIOS state 9	BIOS Post code (Old LED pattern 1011) combine "Other pre-video activity and resource configuration codes. BIOS to eliminate 1100 code.
3,7		BIOS state 10	BIOS Post code (Old LED pattern 1110) Other pre-post activity, routine subsequent to video init.

Diagnostic error messages

Table 5. Diagnostic error messages

Error messages	Description
AUXILIARY DEVICE FAILURE	The touchpad or external mouse may be faulty. For an external mouse, check the cable connection. Enable the Pointing Device option in the System Setup program.
BAD COMMAND OR FILE NAME	Ensure that you have spelled the command correctly, put spaces in the proper place, and used the correct path name.
CACHE DISABLED DUE TO FAILURE	The primary cache internal to the microprocessor has failed. Contact Dell
CD DRIVE CONTROLLER FAILURE	The optical drive does not respond to commands from the computer.
DATA ERROR	The hard drive cannot read the data.
DECREASING AVAILABLE MEMORY	One or more memory modules may be faulty or improperly seated. Reinstall the memory modules or, if necessary, replace them.
DISK C: FAILED INITIALIZATION	The hard drive failed initialization. Run the hard drive tests in Dell Diagnostics .
DRIVE NOT READY	The operation requires a hard drive in the bay before it can continue. Install a hard drive in the hard drive bay.

Error messages

Description

ERROR READING PCMCIA CARD	The computer cannot identify the ExpressCard. Reinsert the card or try another card.
EXTENDED MEMORY SIZE HAS CHANGED	The amount of memory recorded in non-volatile memory (NVRAM) does not match the memory module installed in the computer. Restart the computer. If the error appears again, Contact Dell
THE FILE BEING COPIED IS TOO LARGE FOR THE DESTINATION DRIVE	The file that you are trying to copy is too large to fit on the disk, or the disk is full. Try copying the file to a different disk or use a larger capacity disk.
A FILENAME CANNOT CONTAIN ANY OF THE FOLLOWING CHARACTERS: \ / : * ? " < > -	Do not use these characters in filenames.
GATE A20 FAILURE	A memory module may be loose. Reinstall the memory module or, if necessary, replace it.
GENERAL FAILURE	The operating system is unable to carry out the command. The message is usually followed by specific information. For example, <i>Printer out of paper</i> . Take the appropriate action.
HARD-DISK DRIVE CONFIGURATION ERROR	The computer cannot identify the drive type. Shut down the computer, remove the hard drive, and boot the computer from an optical drive. Then, shut down the computer, reinstall the hard drive, and restart the computer. Run the Hard Disk Drive tests in Dell Diagnostics .
HARD-DISK DRIVE CONTROLLER FAILURE 0	The hard drive does not respond to commands from the computer. Shut down the computer, remove the hard drive, and boot the computer from an optical drive. Then, shut down the computer, reinstall the hard drive, and restart the computer. If the problem persists, try another drive. Run the Hard Disk Drive tests in Dell Diagnostics .
HARD-DISK DRIVE FAILURE	The hard drive does not respond to commands from the computer. Shut down the computer, remove the hard drive, and boot the computer from an optical drive. Then, shut down the computer, reinstall the hard drive, and restart the computer. If the problem persists, try another drive. Run the Hard Disk Drive tests in Dell Diagnostics .
HARD-DISK DRIVE READ FAILURE	The hard drive may be defective. Shut down the computer, remove the hard drive, and boot the computer from an optical. Then, shut down the computer, reinstall the hard drive, and restart the computer. If the problem persists, try another drive. Run the Hard Disk Drive tests in Dell Diagnostics .
INSERT BOOTABLE MEDIA	The operating system is trying to boot to non-bootable media, such as an optical drive. Insert bootable media.
INVALID CONFIGURATION INFORMATION-PLEASE RUN SYSTEM SETUP PROGRAM	The system configuration information does not match the hardware configuration. The message is most likely to occur after a memory module is installed. Correct the appropriate options in the system setup program.
KEYBOARD CLOCK LINE FAILURE	For external keyboards, check the cable connection. Run the Keyboard Controller test in Dell Diagnostics .

Error messages

Error messages	Description
KEYBOARD CONTROLLER FAILURE	For external keyboards, check the cable connection. Restart the computer, and avoid touching the keyboard or the mouse during the boot routine. Run the Keyboard Controller test in Dell Diagnostics .
KEYBOARD DATA LINE FAILURE	For external keyboards, check the cable connection. Run the Keyboard Controller test in Dell Diagnostics .
KEYBOARD STUCK KEY FAILURE	For external keyboards or keypads, check the cable connection. Restart the computer, and avoid touching the keyboard or keys during the boot routine. Run the Stuck Key test in Dell Diagnostics .
LICENSED CONTENT IS NOT ACCESSIBLE IN MEDIADIRECT	Dell MediaDirect cannot verify the Digital Rights Management (DRM) restrictions on the file, so the file cannot be played.
MEMORY ADDRESS LINE FAILURE AT ADDRESS, READ VALUE EXPECTING VALUE	A memory module may be faulty or improperly seated. Reinstall the memory module or, if necessary, replace it.
MEMORY ALLOCATION ERROR	The software you are attempting to run is conflicting with the operating system, another program, or a utility. Shut down the computer, wait for 30 seconds, and then restart it. Run the program again. If the error message still appears, see the software documentation.
MEMORY DOUBLE WORD LOGIC FAILURE AT ADDRESS, READ VALUE EXPECTING VALUE	A memory module may be faulty or improperly seated. Reinstall the memory module or, if necessary, replace it.
MEMORY ODD/EVEN LOGIC FAILURE AT ADDRESS, READ VALUE EXPECTING VALUE	A memory module may be faulty or improperly seated. Reinstall the memory module or, if necessary, replace it.
MEMORY WRITE/READ FAILURE AT ADDRESS, READ VALUE EXPECTING VALUE	A memory module may be faulty or improperly seated. Reinstall the memory module or, if necessary, replace it.
NO BOOT DEVICE AVAILABLE	The computer cannot find the hard drive. If the hard drive is your boot device, ensure that the drive is installed, properly seated, and partitioned as a boot device.
NO BOOT SECTOR ON HARD DRIVE	The operating system may be corrupted, Contact Dell .
NO TIMER TICK INTERRUPT	A chip on the system board may be malfunctioning. Run the System Set tests in Dell Diagnostics .
NOT ENOUGH MEMORY OR RESOURCES. EXIT SOME PROGRAMS AND TRY AGAIN	You have too many programs open. Close all windows and open the program that you want to use.
OPERATING SYSTEM NOT FOUND	Reinstall the operating system. If the problem persists, Contact Dell .
OPTIONAL ROM BAD CHECKSUM SECTOR NOT FOUND	The optional ROM has failed. Contact Dell . The operating system cannot locate a sector on the hard drive. You may have a defective sector or corrupted File Allocation Table (FAT) on the hard drive. Run the Windows error-checking utility to check the file structure on the hard drive. See Windows Help and Support for instructions (click Start > Help and Support). If a large number of sectors are defective, back up the data (if possible), and then format the hard drive.
SEEK ERROR	The operating system cannot find a specific track on the hard drive.
SHUTDOWN FAILURE	A chip on the system board may be malfunctioning. Run the System Set tests in Dell Diagnostics . If the message reappears, Contact Dell .

Error messages	Description
TIME-OF-DAY CLOCK LOST POWER	System configuration settings are corrupted. Connect your computer to an electrical outlet to charge the battery. If the problem persists, try to restore the data by entering the System Setup program, then immediately exit the program. If the message reappears, Contact Dell .
TIME-OF-DAY CLOCK STOPPED	The reserve battery that supports the system configuration settings may require recharging. Connect your computer to an electrical outlet to charge the battery. If the problem persists, Contact Dell .
TIME-OF-DAY NOT SET-PLEASE RUN THE SYSTEM SETUP PROGRAM	The time or date stored in the system setup program does not match the system clock. Correct the settings for the Date and Time options.
TIMER CHIP COUNTER 2 FAILED	A chip on the system board may be malfunctioning. Run the System Set tests in Dell Diagnostics .
UNEXPECTED INTERRUPT IN PROTECTED MODE	The keyboard controller may be malfunctioning, or a memory module may be loose. Run the System Memory tests and the Keyboard Controller test in Dell Diagnostics or Contact Dell .
X:\ IS NOT ACCESSIBLE. THE DEVICE IS NOT READY	Insert a disk into the drive and try again.

System error messages

Table 6. System error messages

System message	Description
Alert! Previous attempts at booting this system have failed at checkpoint [nnnn]. For help in resolving this problem, please note this checkpoint and contact Dell Technical Support	The computer failed to complete the boot routine three consecutive times for the same error.
CMOS checksum error	RTC is reset, BIOS Setup default has been loaded.
CPU fan failure	CPU fan has failed.
System fan failure	System fan has failed.
Hard-disk drive failure	Possible hard disk drive failure during POST.
Keyboard failure	Keyboard failure or loose cable. If reseating the cable does not solve the problem, replace the keyboard.
No boot device available	No bootable partition on hard disk drive, the hard disk drive cable is loose, or no bootable device exists. <ul style="list-style-type: none"> If the hard drive is your boot device, ensure that the cables are connected and that the drive is installed properly and partitioned as a boot device. Enter system setup and ensure that the boot sequence information is correct.
No timer tick interrupt	A chip on the system board might be malfunctioning or motherboard failure.
NOTICE - Hard Drive SELF MONITORING SYSTEM has reported that a parameter has exceeded its normal operating range. Dell recommends that you back up your data regularly. A parameter	S.M.A.R.T error, possible hard disk drive failure.

System message**Description**

out of range may or may not indicate a
potential hard drive problem

Getting help

Contacting Dell

NOTE: If you do not have an active Internet connection, you can find contact information on your purchase invoice, packing slip, bill, or Dell product catalog.

Dell provides several online and telephone-based support and service options. Availability varies by country and product, and some services may not be available in your area. To contact Dell for sales, technical support, or customer service issues:

- 1 Go to **Dell.com/support**.
- 2 Select your support category.
- 3 Verify your country or region in the **Choose a Country/Region** drop-down list at the bottom of the page.
- 4 Select the appropriate service or support link based on your need.