

MACHINE DISPOSAL

- The packing materials can be recycled.
- Appliance: Unplug the appliance and cut the power cord.
- Deliver the appliance and power cord to a service center or public waste disposal facility.

This product complies with eu directive 2002/96/ec.



The symbol  on the product or on its packaging indicates that this product may not be treated as household waste. Instead it shall be handed over to the applicable collection point for the recycling of electrical and electronic equipment.

By ensuring this product is disposed of correctly, you will help prevent potential negative consequences for the environment and human health, which could otherwise be caused by inappropriate waste handling of this product. For more detailed information about recycling of this product, please contact your local city office, your household waste disposal service or the shop where you purchased the product.

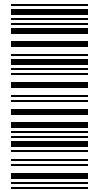

15002363

Rev.04 del 30-06-12

02

EN

The manufacturer reserves the right to make changes without prior notice.



www.philips.com/saeco

Register your product and get support at
www.philips.com/welcome

02

English

SYNTIA

Type HD8838
SUP 037DRJ

OPERATING INSTRUCTIONS



READ THESE INSTRUCTIONS CAREFULLY BEFORE USING THE MACHINE.

EN

02

CE

PHILIPS
Saeco

IMPORTANT SAFEGUARDS

When using electrical appliances, basic safety precautions should always be followed, including the following:

1. Read all instructions.
2. Do not touch hot surfaces. Use handles or knobs.
3. To protect against fire, electric shock and injury to persons do not immerse cord, plugs, or appliance in water or other liquid.
4. Close supervision is necessary when the appliance is used by or near children.
5. Unplug from outlet when not in use and before cleaning. Allow to cool before putting on or taking off parts, and before cleaning the appliance.
6. Do not operate any appliance with a damaged cord or plug or after the appliance malfunctions, or has been damaged in any manner. Return appliance to the nearest authorized service facility for examination, repair or adjustment.
7. The use of accessory attachments not recommended by the appliance manufacturer may result in fire, electric shock or injury to persons.
8. Do not use outdoors.
9. Do not let cord hang over edge of table or counter, or touch hot surfaces.
10. Do not place on or near a hot gas or electric burner, or in a heated oven.
11. Always attach plug to appliance first, then plug cord into wall outlet. To disconnect, turn any control to "off", then remove plug from wall outlet.
12. Do not use appliance for other than intended use.
13. Save these instructions.

SAVE THESE INSTRUCTIONS

CAUTION

This appliance is for household use only. Any servicing, other than cleaning and user maintenance, should be performed by an authorized service center. Do not immerse machine in water. To reduce the risk of fire or electric shock, do not disassemble the machine. There are no parts inside the machine serviceable by the user. Repair should be done by authorized service personnel only.

1. Check voltage to be sure that the voltage indicated on the nameplate corresponds with your voltage.
2. Never use warm or hot water to fill the water tank. Use cold water only.
3. Keep your hands and the cord away from hot parts of the appliance during operation.
4. Never clean with scrubbing powders or harsh cleaners. Simply use a soft cloth dampened with water.
5. For optimal taste of your coffee, use purified or bottled water. Periodic descaling is still recommended every 2-3 months.
6. Do not use caramelized or flavored coffee beans.

INSTRUCTIONS FOR THE POWER SUPPLY CORD

- A. A short power-supply cord (or detachable power-supply cord) is to be provided to reduce risks resulting from becoming entangled in or tripping over a longer cord.
- B. Longer detachable power-supply cords or extension cords are available and may be used if care is exercised in their use.
- C. If a long detachable power-supply cord or extension cord is used,
 1. The marked electrical rating of the detachable power-supply cord or extension cord should be at least as great as the electrical rating of the appliance
 2. If the appliance is of the grounded type, the extension cord should be a grounding-type 3-wire cord, and
 3. The longer cord should be arranged so that it will not drape over the counter top or table top where it can be pulled on by children or tripped over.

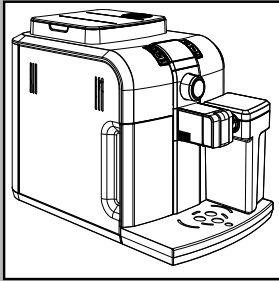

GENERAL INFORMATION

The coffee machine is suitable for preparing espresso coffees using coffee beans; it is equipped with a device to dispense steam and hot water. The structure of the machine with its elegant housing has been designed for domestic use only and is not suitable for continuous professional-type operation.

Keep these operating instructions in a safe place and make them available to anyone who may use the coffee machine.

For further information or in case of problems that are not included or not completely explained in these instructions, please contact the authorised service centres.



Warning. No liability is held for damage caused by:

- **Incorrect use not in accordance with the intended purposes;**
- **Repairs not carried out by authorised service centres;**
- **Tampering with the power cord;**
- **Tampering with any parts of the machine;**
- **Storage or use of the machine at a temperature outside the operating temperature range (+15°C / +45°C);**
- **The use of non-original spare parts and accessories.**

In these cases, the warranty is not valid.

SAFETY REGULATIONS



Never allow water to come into contact with any of the electrical parts of the machine: Danger of short circuit! Steam and hot water may cause scalding! Do not direct the steam or hot water jet towards body parts. Carefully handle the steam/hot water spout by its grip: Danger of scalding!

Intended use

The coffee machine is intended for domestic use only. Do not make any technical changes or use the machine for unauthorised purposes since this would create serious hazards! The appliance is not to be used by persons (including children) with reduced physical, mental or sensory abilities or with scarce experience and/or expertise, unless they are supervised by a person responsible for their safety, or they are instructed by this person on how to properly use the machine.

Power Supply - Power Cord

Only connect the coffee machine to a suitable socket.

The voltage must correspond to that indicated on the machine label located on the inside of the service door.

Never use the coffee machine if the power cord is defective or damaged.

If damaged, the power cord must be replaced by the manufacturer or an authorised service centre. Do not pass the power cord around corners, over sharp edges or over hot objects and keep it away from oil. Do not use the power cord to carry or pull the coffee machine.

Do not pull out the plug by the power cord or touch it with wet hands. Do not let the power cord hang freely from tables or shelves.

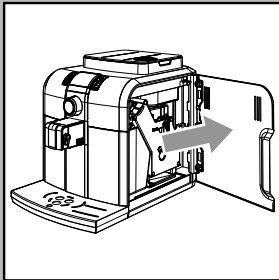

For the safety of others

Prevent children from playing with the machine.

Children are not aware of the risks related to electric household appliances.

Do not leave the machine packaging materials within the reach of children.

Danger of burns

Never direct the jet of hot steam and/or hot water towards yourself or others: **Danger of scalding!** Always use the handles or knobs provided.

Milk Container

At first use or after a long period of inactivity wash all components of the milk container to guarantee good operation and to avoid proliferation of bacteria, harmful to health.

The milk in the carafe may be stored inside the carafe using the instructions and precautions on the original package. Do not use milk after its expiration date indicated on the package.

If milk is left in the carafe, make sure it is still suitable for food consumption before using it.

At least once a week the carafe must be removed for thorough cleaning.

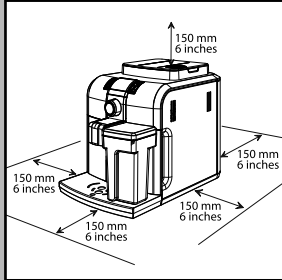

Machine Location - Suitable Location for Operation and Maintenance

For best use, it is recommended to:

- Choose a safe, level surface, where there will be no danger of overturning it or being injured.
- Choose a location that is sufficiently well-lit, clean and near an easily reachable socket;
- Provide for a minimum distance from the sides of the machine as shown in the illustration;
- During machine turning on/off, it is recommended to place an empty glass under the dispensing spout.

Do not keep the machine at temperatures below 0°C. Frost may damage the machine.

Do not use the coffee machine outdoors.

In order to prevent its housing from melting or being damaged, do not place the machine on very hot surfaces and close to open flames.

Storing the Machine - Cleaning

Before cleaning the machine, turn it off by pressing the ON/OFF button, and then by switching the power button to "0". Finally, remove the plug from the socket. Wait for the machine to cool down.

Never immerse the machine in water!

It is strictly forbidden to tamper with the internal parts of the machine.

Water left in the tank for several days should not be consumed. Wash the tank and fill it with fresh drinking water.

If the machine is not to be used for a long time, dispense water from the dispensing spout, then turn off the machine and unplug it from the socket.

Store it in a dry place, out of the reach of children.

Keep it protected from dust and dirt.

Repairs / Maintenance

In case of failure, problems or a suspected fault resulting from the falling of the machine, immediately remove the plug from the socket. Never attempt to operate a faulty machine.

Service and repairs may only be carried out by authorised service centres.

All liability for damages resulting from work not carried out by professionals is declined.

Fire Safety Precautions

In case of fire, use carbon dioxide (CO₂) extinguishers. Do not use water or dry powder extinguishers.

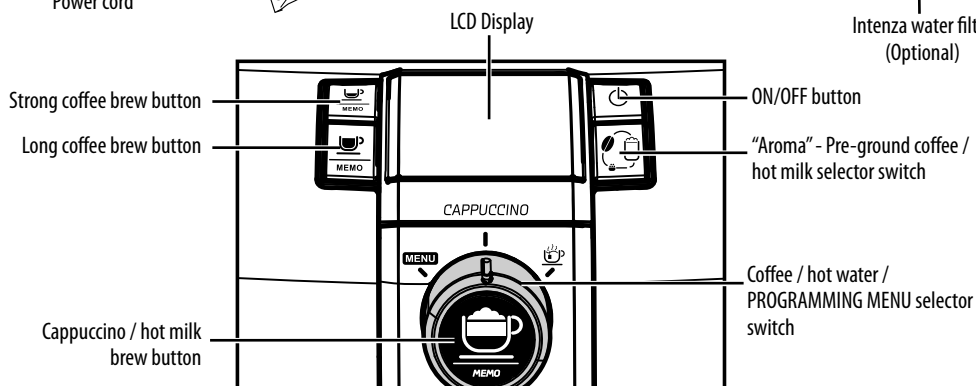
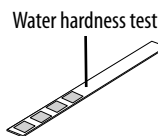
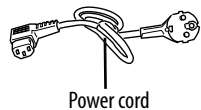
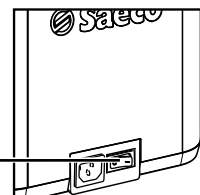
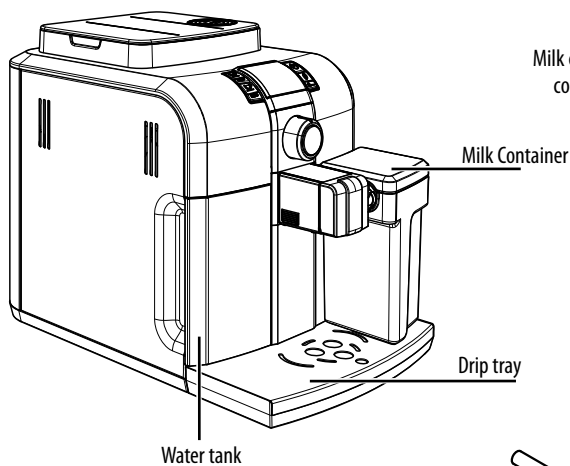
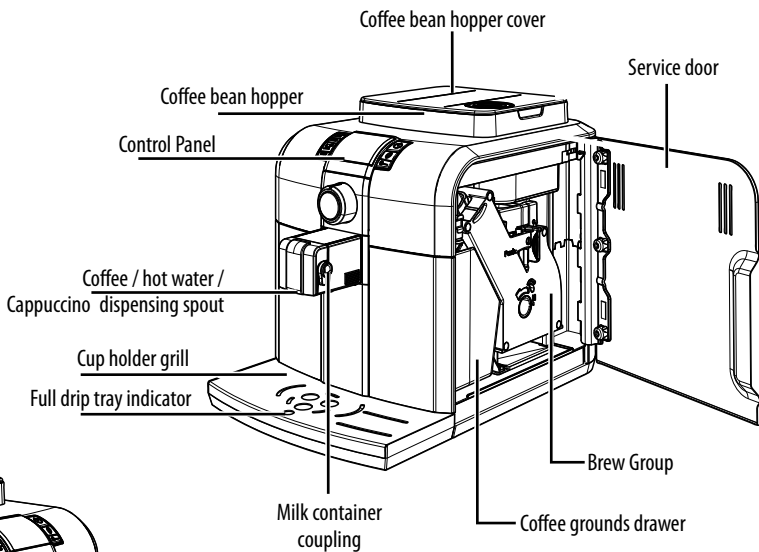
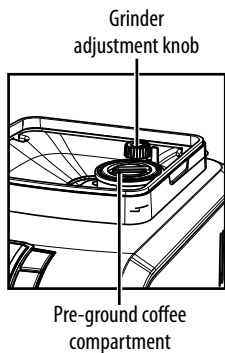

TABLE OF CONTENTS

• GENERAL INFORMATION.....	2
• SAFETY REGULATIONS	2
• INSTALLATION.....	5
Machine Packaging.....	5
Preliminary Operations.....	5
• RINSE/SELF-CLEANING CYCLE.....	6
• USING THE MACHINE FOR THE FIRST TIME OR AFTER A LONG PERIOD OF INACTIVITY.....	7
• "INTENZA" WATER FILTER.....	8
• WATER HARDNESS MEASUREMENT.....	9
• MILK CONTAINER	9
• COFFEE BREWING.....	10
Dispensing Spout Adjustment.....	10
'Aroma' Adjustment	10
Using Coffee Beans.....	10
Using Pre-ground Coffee.....	11
• CAPPUCCINO	12
• HOT MILK BREWING.....	12
• CLEANING OF THE MILK BREWING SYSTEM	14
Automatic cleaning functions	14
Fast cleaning.....	14
Periodic cleaning.....	15
• HOT WATER DISPENSING	18
• ADJUSTMENTS	19
Saeco Adapting System.....	19
Coffee Grinder Adjustment.....	19
Adjusting the Coffee Length.....	19
Cappuccino Adjustment	20
Adjusting the amount of frothed milk.....	21
Stand-by	21
• PROGRAMMING	22
Enter the "menu".....	22
Programming controls	22
Exit Programming Mode	22
Functions	22
Programming Example	23
• CLEANING AND MAINTENANCE	24
General Cleaning.....	24
Brew Group	24
• DESCALING	26
• CONTROL PANEL DISPLAY	28
Ready Signals.....	28
Alarm Signals.....	29
Warning Signals.....	30
• TECHNICAL SPECIFICATIONS.....	30
• TROUBLESHOOTING	31

INSTALLATION

For your safety and the safety of others, carefully follow the instructions provided in the "Safety Regulations" section.

Machine Packaging

The original packaging has been designed and constructed to protect the machine during transport. We recommend keeping the packaging material for possible future transport.

Preliminary Operations

- Remove the coffee bean hopper cover, the drip tray with grill and the milk container from the packaging.
- Remove the coffee machine from the packaging and position it in a place that meets the requirements described in the safety regulations.
- Place the drip tray with grill into its appropriate seat on the machine. Make sure it is fully inserted to its limit stop.
- Insert the coffee bean hopper cover.

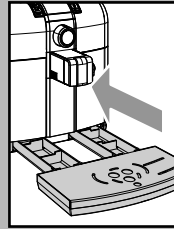

i **Note:** Insert the plug into the socket only when indicated and check that the general switch is in "0" position.

i **Important note:** Carefully read the explanations of all the warnings the machine displays to the user on the control panel LCD display (section "LCD Display Warnings").

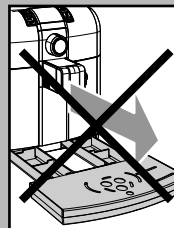

! **NEVER** remove the drip tray when the machine is turned on. Wait a couple of minutes after turning on/off, as the machine will be carrying out a rinse/self-cleaning cycle (see section "Rinse/Self-cleaning Cycle").

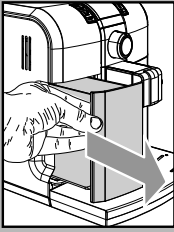

- Remove the water tank from its place.
- Rinse and fill it with fresh water making sure that it is not filled exceeding the (MAX) level indicated in the tank. Put the tank back in its place.

! Fill the tank only with fresh, non-sparkling water. Hot water or any other liquid may damage the tank and/or the machine. Do not operate the machine if water is not present: Make sure there is enough water in the tank.

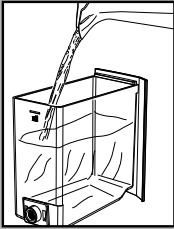

- Remove the coffee bean hopper cover.

i Note: The hopper may be provided with different safety features according to the regulations of the country of use of the machine.

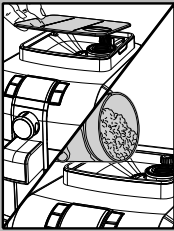

- Slowly pour the coffee beans into the hopper.

! Only coffee beans must be put into the coffee bean hopper. Ground coffee, instant coffee or any other object may damage the machine.

- Replace the coffee bean hopper cover.
- Insert the plug into the socket on the back of the machine.
- Insert the plug of the other end of the cable into a wall socket with suitable power voltage.

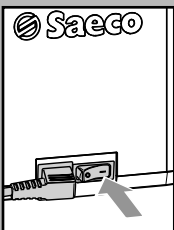
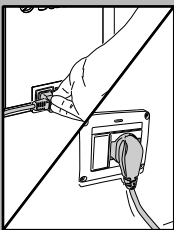

- Switch the power button to "I" to turn the machine on.

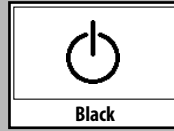

- The display shows the ON/OFF icon.



- Make sure the selector switch is on "I" position; if necessary, turn it to the indicated position.
- To turn the machine on simply press the ON/OFF button.

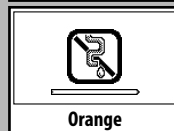

- The display indicates that the machine is priming the circuit.

i Note: In some cases you may be requested to manually prime the circuit. For this operation see section "Control Panel Display".

RINSE/Self-CLEANING CYCLE

This cycle allows rinsing the coffee circuits with fresh water.

The cycle is carried out:

- At machine start (with cold boiler)
- After priming the circuit (with cold boiler)
- During the Stand-by preparation phase (if a coffee product has been brewed)
- During the turning off phase after pressing the ON/OFF button (if a coffee product has been brewed).

A small amount of water will be dispensed to rinse and heat all the machine components; in this phase this icon is displayed.

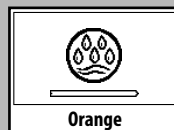

Wait for the cycle to finish automatically. **You can stop dispensing by pressing either the coffee button and/or the ON/OFF button.**

USING THE MACHINE FOR THE FIRST TIME OR AFTER A LONG PERIOD OF INACTIVITY

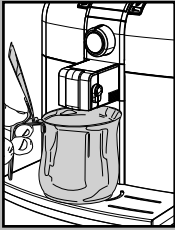

These simple operations will make it possible to always brew excellent coffee.

- 1 Place a large container under the dispensing spout.

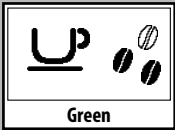

- 2 Before starting the procedure, check that the following icon is displayed.



- 3 Select the pre-ground coffee brewing function by pressing the "U" button one or more times.

i Do not add pre-ground coffee to the compartment.

The icon will appear on the display.

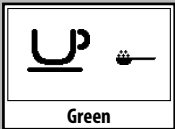

- 4 Press the button to brew a long coffee.

- 5 Wait until brewing is completed and empty the water container.

- 6 Repeat the operations from step 1 to step 5 for 3 times; then continue with step 7.

- 7 Empty the container and replace it under the dispensing spout.

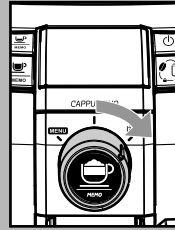

- 8 Turn the selector switch clockwise and set it to the "U" position.



The following icon will be displayed.

Press button "U" to start dispensing hot water.



- 9 Dispense water until the no water signal appears, then rotate the selector switch counter-clockwise until it is back into the "U" position.

- 10 At the end, fill the water tank again. Then the products can be brewed as described in the following sections.

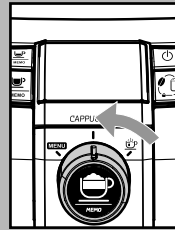

"INTENZA" WATER FILTER

To improve the quality of the used water, it is advisable to install the water filter.

Remove the water filter from its packaging, immerse it vertically (with the opening positioned upwards) in cold water and delicately press the sides so as to let the air bubbles out.

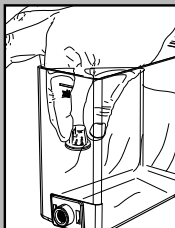

Remove the small white filter from the tank and store it in a dry place sheltered from dust.

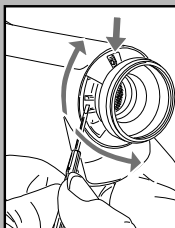

Set the Intenza Aroma System as specified on the box.

A = Soft water

B = Hard water (standard)

C = Very hard water

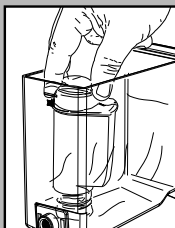

Insert the filter into the empty tank. Press it until its limit stop.

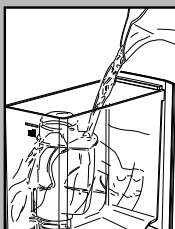

Fill the tank with fresh drinking water and reinsert it into the machine.

Dispense the water in the tank by using the hot water function (see section "Hot water dispensing").

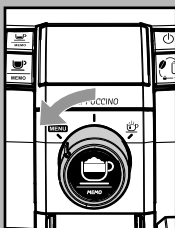

Fill the water tank again.

Turn the selector switch counter-clockwise and set it to the "MENU" position. Condition for first use of the machine.

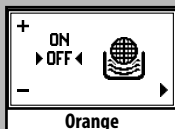

Press the "☺" button until the following page is displayed.

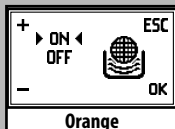

Press the "☺" button to select "ON" and press the "☺" button to confirm.

In this way, the machine has been programmed to inform the user of the need to replace the filter.

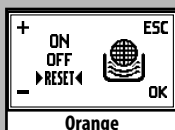

i **Note:** When an "Intenza" filter must be replaced with a new one, the function must be reset. Replace the filter as previously shown. After that, enter the programming menu until the indicated window is displayed and select the "RESET" option. Then press the "☺" button. This way, the machine is programmed to manage a new filter.

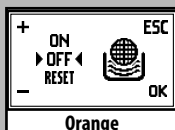

i **Note:** If the filter is already installed and you want to remove - but not replace - it, select the "OFF" option and then press the "☺" button.



To exit, turn the selector switch clockwise and set it to the "☺" position.

i **Note:** If there is no Intenza water filter, insert the previously-removed small white filter into the water tank.

WATER HARDNESS MEASUREMENT

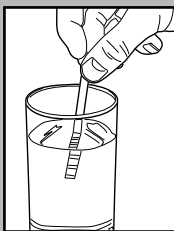

The water hardness measurement is very important in order to correctly manage the "Intenza" filter and the frequency with which the machine must be descaled.

Immerse the water hardness test strip provided with the machine in water for 1 second.

i **Note: The test strip is only valid for one measurement.**

Check how many squares change colour and refer to the table.

The letters correspond to the references that are located in the base of the Intenza filter. The filter must be adjusted based on this measurement.

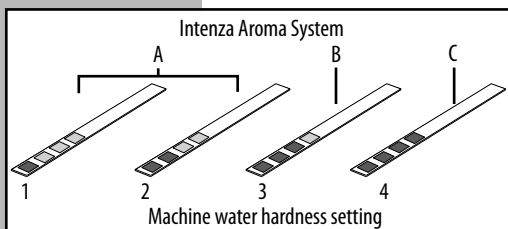

The numbers correspond to the settings that are found for the water hardness adjustment that is shown in the programming section.

More precisely:

- 1 = ▲ (very soft water)
- 2 = ▲▲ (soft water)
- 3 = ▲▲▲ (hard water)
- 4 = ▲▲▲▲ (very hard water)

Once this value is known, set the water hardness value as specified in the programming section.

MILK CONTAINER

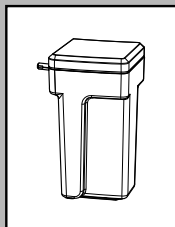

This section explains how to use a milk container for the preparation of cappuccino or hot milk.

i **Note: Before using the milk container, clean it thoroughly as described in section "Cleaning and Maintenance".**

i **Note: The milk must be stored in the refrigerator and poured into the container only when preparing a cappuccino. After use, put the container back in the refrigerator.**

DO NOT store milk out of the refrigerator for longer than 15 minutes.

i **Note: In order to fill the milk container, remove it from the machine.**

The milk container must be filled with whole milk at refrigerator temperature.

⚠ Warning! It is forbidden to use the container for any other liquids other than drinking water.

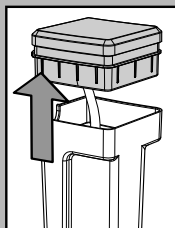

To properly use the container, proceed as follows:

1 Remove the top cover paying attention to the suction pipe.

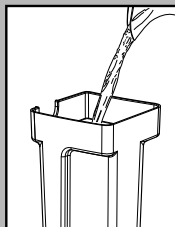

2 Fill the container with milk: Do not exceed the MAX level indicated on the container.

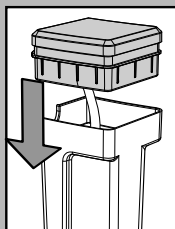



3 Replace the suction pipe inside the container and close the cover by pressing it to the end.

After that, the container may be used to brew the desired beverages.

COFFEE BREWING

 **Note:** Should the machine not brew coffee, make sure that the water tank contains water.

 Before brewing coffee check the lights on the display and make sure the water tank and coffee bean hopper are full.

 Leave the selector switch on the coffee position "☕" during the brewing phase.

 Before brewing the coffee, adjust the height of the dispensing spout according to your needs and select the aroma or pre-ground coffee.

Dispensing Spout Adjustment

Most cups on the market can be used with this coffee machine. The height of the dispensing spout may be adjusted to better fit the dimensions of the cups that you wish to use.

Manually move the dispensing spout up or down to adjust its height by placing your fingers as shown in the figure. The recommended positions are:
For the use of small cups;

For the use of large cups.

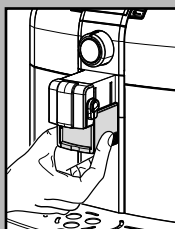
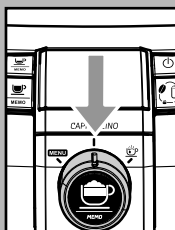
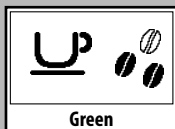



• Two cups/mugs can be placed under the dispensing spout for brewing two coffees at the same time.

'Aroma' Adjustment

The machine is set-up for adjusting the amount of coffee to be ground.

Four choices are possible by pressing and releasing the "☕" button: mild, medium or strong aroma, and ground coffee.

Selection can be made when the beans appear on the display. Each time the "☕" button is pressed and released, the aroma changes by one degree:

-  = Mild aroma
-  = Medium aroma
-  = Strong aroma

Selection must be made prior to selecting the coffee. The system sets the aroma according to the personal taste of the user.

After selecting "Strong aroma", the function for brewing coffee with pre-ground coffee is displayed.

This selection is displayed by the icon on the side.

Refer to the relevant section to use this function.

 **Note:** A subsequent pressure allows access to the page on the side. This function allows brewing hot milk.

Refer to the relevant section to use this function.

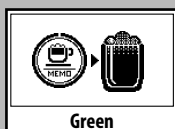
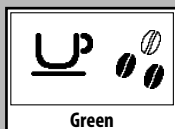
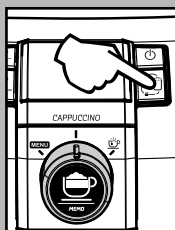

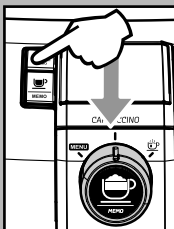

Using Coffee Beans

- To brew coffee, press and release: the “☕” button to select the desired Aroma.
- the “MEMO” button for an espresso coffee;
- the “MEMO” button for a long coffee.
- Then, the brewing cycle starts.

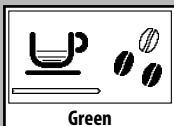

- i** To brew 2 cups of coffee, press the desired button twice. The machine manages the brewing cycle automatically.

- Coffee brewing stops automatically when the pre-programmed level is reached; however, it is possible to interrupt coffee brewing by pressing the button initially pressed.

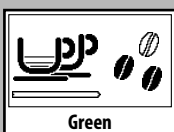

Using Pre-ground Coffee

- i** This function allows using pre-ground and decaffeinated coffee.

- i** Note:

- If no pre-ground coffee is poured into the compartment, only water will be dispensed;
- If the dose is excessive and 2 or more measuring scoops of coffee are used, the machine will not brew the product. Also in this case, the machine will run an empty cycle and discharge any ground coffee into the coffee grounds drawer.

To brew coffee:

- Press and release the “☕” button to select the pre-ground coffee function.
- Lift the pre-ground coffee compartment cover.

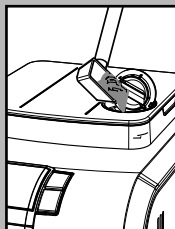

- Add only 1 scoop of pre-ground coffee to the compartment. Use the measuring scoop supplied with the machine to perform this operation. Then, close the cover.

- !** **Warning: Only add pre-ground coffee to the compartment. Only use ground coffee for espresso machines and never coffee beans or instant coffee. Other substances and objects may cause severe damages to the machine. Such damages will not be covered by warranty.**

Press and release:

- the “MEMO” button for an espresso coffee;
- the “MEMO” button for a long coffee.
- Then, the brewing cycle starts.

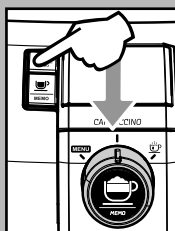

- Coffee brewing stops automatically when the pre-programmed level is reached; however, it is possible to interrupt coffee brewing by pressing the button initially pressed.
- After brewing the product, the coffee beans configuration of the machine is restored.

- i** Repeat the steps described above to brew other coffees.

CAPPUCCINO

 **Danger of scalding! Brewing may be preceded by small jets of hot water.**

 **Important note: Immediately after using the machine to brew a cappuccino, clean all components as described in the "Cleaning of the Milk Brewing System" section.**

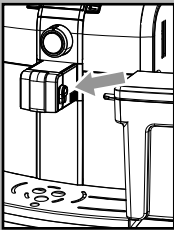

After filling the milk container, place it in the machine. Insert the container pin in its seat.



Make sure the container is inserted up to its limit.



Place the cup you use every day to enjoy your cappuccino.



 Before brewing coffee check the lights on the display and make sure the water tank and coffee bean hopper are full.

 It is possible to prepare a cappuccino with pre-ground coffee. Select the function with the  button and pour the coffee in the compartment as described in the proper section.

HOT MILK BREWING

 **Danger of scalding! Brewing may be preceded by small jets of hot water.**

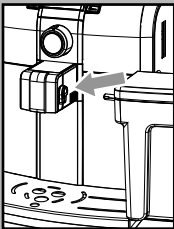

After filling the milk container, place it in the machine. Insert the container pin in its seat.

Make sure the container is inserted up to its limit.

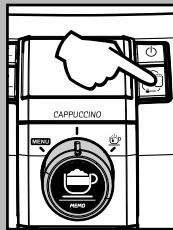

Press the  button until the following page is displayed.

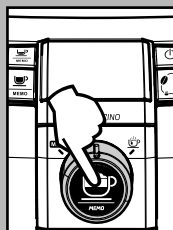

Press the  button to start brewing hot milk.

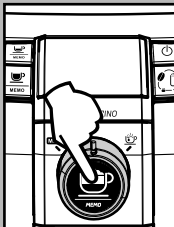

Press the “☕” button.

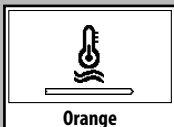

Orange

- The following icon is displayed during the preheating time required by the machine:

i In this phase the machine starts grinding coffee and/or gets ready to brew coffee.

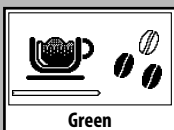

Green

- When the following icon is displayed, the machine brews frothed milk directly in the cup.



Green

i Each brewing phase is programmed, but can be interrupted in advance by pressing the “☕” button.

- Once milk has been brewed, the machine brews the coffee.

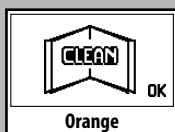

Orange

i Important note: Immediately after using the machine to brew a cappuccino, clean all components as described in the "Cleaning of the Milk Brewing System" section.

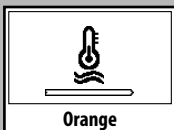

Orange

The icon on the side is displayed during the short warm-up phase required by the machine.



Green

Once the ideal temperature is reached, the machine begins brewing the programmed amount of hot milk.

Brewing will stop automatically. If you wish to interrupt hot milk brewing, press the “☕” button.

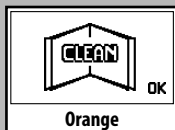

Orange

i Important note: Immediately after using the machine to brew a hot milk, clean all components as described in the "Cleaning of the Milk Brewing System" section.



Milk, even UHT milk, goes bad easily at room temperature; therefore, it is recommended to DO NOT keep it at room temperature for long periods. Furthermore, the milk carafe has always to be put back in the fridge when it is not needed.

It is also advisable to keep the parts in contact with the milk cleaned following the directions and recommendations described in these instructions.

AUTOMATIC CLEANING FUNCTIONS

Before entering the Stand-by mode, the machine automatically performs a short cleaning cycle in the milk brewing area. Moreover, after brewing any kind of milk-based beverage, the machine reminds the user to clean the parts that have been in contact with the milk.

This warning does not block any function of the machine and can be deleted by pressing the right lower button every time it appears.

However, it is advisable to regularly clean the parts of the machine in contact with the milk following the instructions described in the "CLEANING OF THE MILK BREWING SYSTEM" section of the manual.

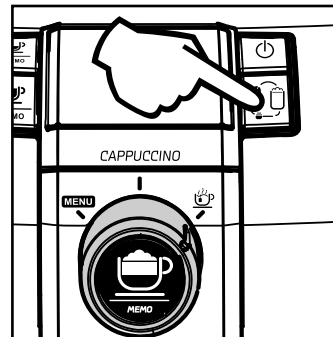
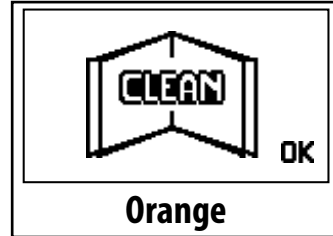

FAST CLEANING

(It is recommended to perform it after each milk brewing)

Before performing this operation remove the milk carafe from the machine.

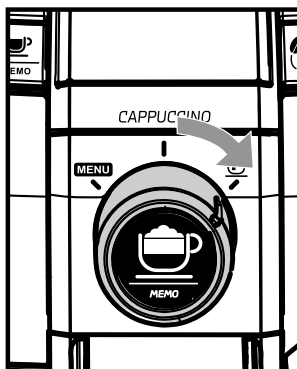

After having brewed milk for some times, turn the main knob to the right as for hot water dispensing: the image "CLEAN+" will appear. Place a container under the dispensing spout and push the upper link button to start the cleaning operation. Then, bring the knob back to the central position to allow other brewing programmes.

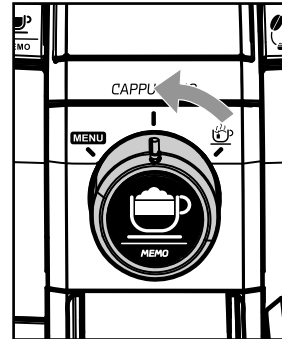
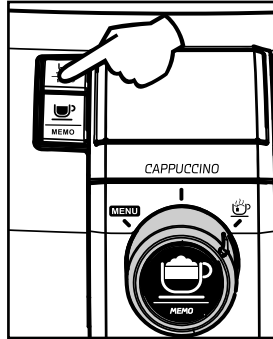
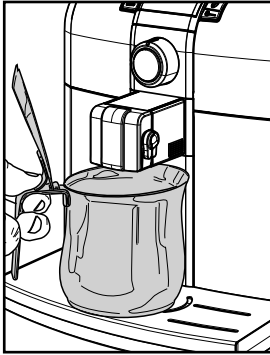

PERIODIC CLEANING

(It is recommended to perform this cleaning every time the milk carafe is removed, when the milk system does not work properly or has milk deposits on it).

It is recommended to regularly clean the parts for brewing and frothing milk by dismantling both the parts installed on the machine and those installed on the carafe.

Dismount the parts installed on the machine according to the instructions showed in the following figures:

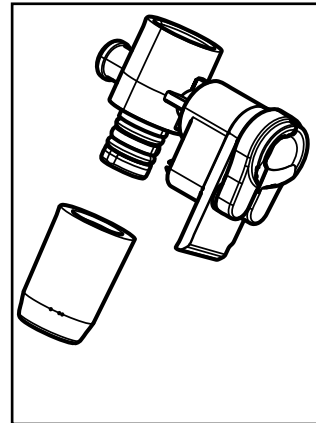
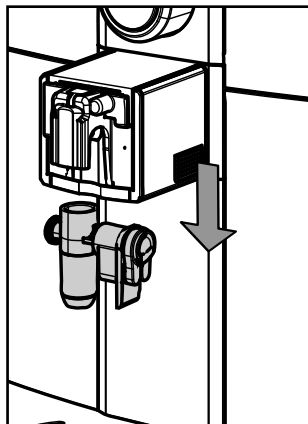
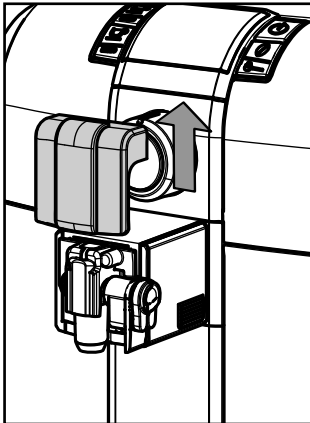

PERIODIC CLEANING

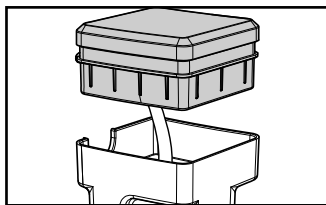

Proceed as follows for the parts installed on the carafe.

- Remove the carafe from the machine.
- Lift the cover and pay attention that the wand does not splash the remaining milk.

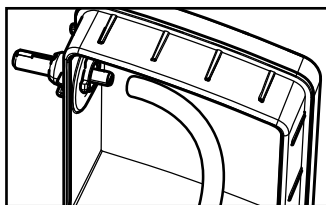

- Remove the wand from the cover.

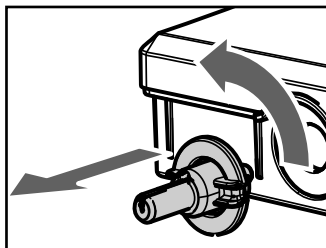

- Remove the pin:
 - Rotate it counter-clockwise.
 - Take off the pin from the cover.

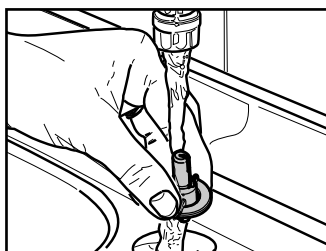

- Wash the cover and the carafe with lukewarm water.
- Wash the wand and the pin of the machine by running lukewarm water inside the duct.

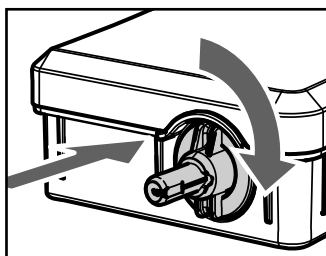

- After rinsing and drying all components, assemble the pin on the cover:
 - Place the pin into the cover.
 - Turn it clockwise until it is locked.

Insert the wand in the cover FROM THE STRAIGHT-CUT END and place the cover over the milk container.

These parts can also be washed in the dishwasher placing them in the cutlery basket so that they do not get lost.

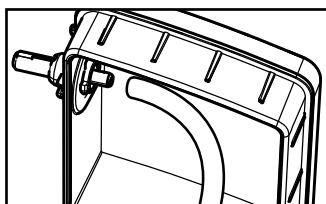

Otherwise, the best way to clean the above-mentioned components is to leave the dismantled parts for 30 min in a basinful of lukewarm water with the specific detergent Saeco Cleaning Powder. (Rinse the parts with running water before reassembling them on the machine).

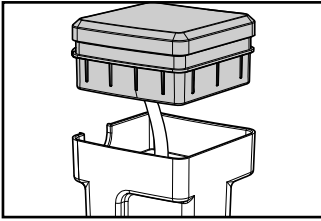

Proceed as follows to complete the cleaning process:

- 1 Remove the top cover paying attention to the suction pipe.

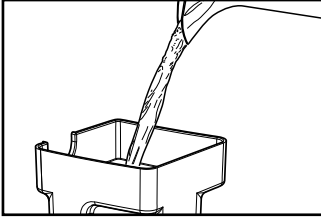

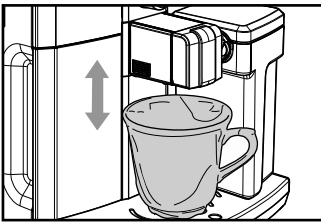
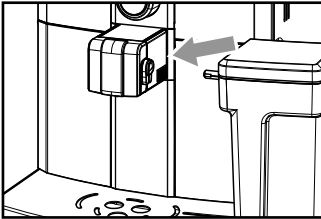

- 2 Fill the container with lukewarm water: Do not exceed the MAX level indicated on the container.

- 3 Replace the suction pipe inside the container and close the cover by pressing it to the end.

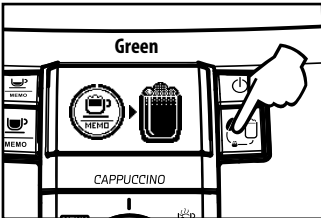

Place the cup you use every day to enjoy your hot milk.



Press the  button until the following page is displayed.

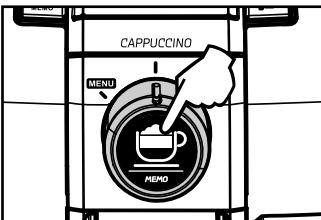

Press the  button to start dispensing water.

Dispensing will stop automatically.

If you wish to interrupt water dispensing, press the  button.

HOT WATER DISPENSING

Warning: At the beginning, short spurts of hot water may come out. Danger of scalding.

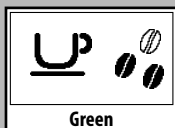

- Before dispensing hot water, check that the following icon is displayed:

When the machine is ready, proceed as follows:

- Place a container under the dispensing spout.

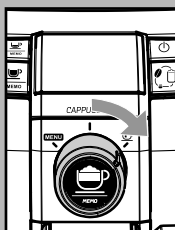
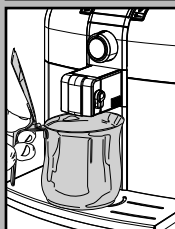

- Turn the selector switch clockwise and set it to the "☕" position.



- The following icon will be displayed.

Press the "MEMO" button to start dispensing hot water.



- Pour the desired amount of hot water. To stop the hot water dispensing press the "MEMO" button.

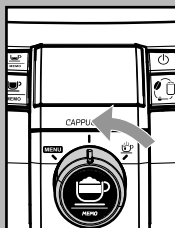

To reset the machine to normal operation turn the selector switch counter-clockwise until it is set to the "☕" position.

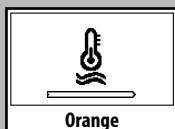

i It may happen that, even though the selector switch has been turned, hot water does not come out and the following icon is displayed. Wait for the warm-up phase to end in order to obtain a flow of hot water from the dispensing spout.



i If the following icon is displayed, clean the dispensing spout. After placing an empty container press the "MEMO" button and wait until the dispensing is finished. Then, hot water may be dispensed.

ADJUSTMENTS

The machine that you have bought allows for certain adjustments that will permit you to use it to its full potential.

Saeco Adapting System

Coffee is a natural product and its characteristics may change according to its origin, blend and roast. The Saeco coffee machine is equipped with a self-adjusting system that allows the use of all types of coffee beans available on the market (non caramelised).

- The machine automatically adjusts itself in order to optimise the extraction of the coffee, ensuring perfect compression of the tablet to obtain a creamy espresso coffee that will release all the aromas, regardless of the type of coffee used.
- The optimisation process is a learning process that requires the brewing of a certain number of coffees to allow the machine to adjust the compactness of the ground coffee.
- Attention should be given to special blends, which require grinder adjustments in order to optimise the extraction of the coffee - (see section Coffee Grinder Adjustment).

Coffee Grinder Adjustment

 **Warning! The grinder adjustment knob, inside the coffee bean hopper, must be turned only when the grinder is working. Do not pour ground and/or instant coffee into the coffee bean hopper.**

 **Do not insert any material other than coffee beans into the hopper. The grinder contains moving parts that may be dangerous. Therefore, do not insert fingers and/or other objects. The grind setting may only be adjusted using the knob. Turn off the machine and unplug it from the socket before carrying out**

any type of operation inside the coffee bean hopper. Do not pour coffee beans when the coffee grinder is working.

The machine allows slight adjustments to the coffee grinder to adapt it to the kind of coffee used.

To make any adjustment, press and turn the knob inside the coffee bean hopper.

Press and turn the knob by one notch at a time and brew 2-3 cups of coffee; this is the only way to notice differences in grind.

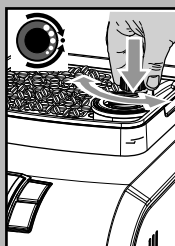

The reference marks inside the coffee bean hopper indicate the grind setting. There are 5 different grind settings to choose from with the following references:

Large Mark - Coarse Grind
Small Mark - Fine Grind.



Adjusting the Coffee Length

The machine allows you to adjust the amount of brewed coffee according to your taste and/or the size of your cups.

Each time the “” or “” button is pressed and released, the machine brews a pre-set amount of coffee. This amount may be reprogrammed to your taste. Each button may be individually programmed for a specific brew setting.

As an example, the following procedure describes the programming of the “” button, which is normally associated with espresso coffee.

- Place a cup under the dispensing spout.

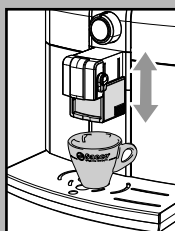

ADJUSTMENTS

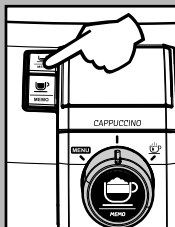

- Press and hold the “MEMO” button until the (MEMO) icon is displayed. At this point, the machine is programming it.
- The machine begins the brewing phase. The “←” icon will be displayed to show which button is being programmed.
- From now on, press the button with the “←” icon each time the desired amount of coffee is reached in the cup.

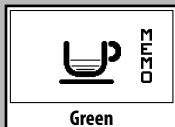

Green

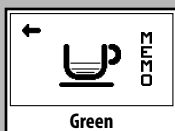

Green

At this point, the “MEMO” button is programmed; each time it is pressed and released, the machine will brew the same amount of coffee that has just been programmed.

Cappuccino Adjustment

The machine allows you to adjust the amount of dispensed milk and coffee, in order to obtain a cappuccino according to your taste and/or the size of your cups.

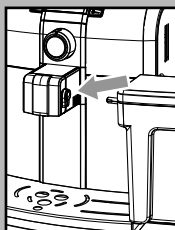

Each time the “MEMO” button is pressed and released, it is possible to brew a programmed cappuccino according to several pre-set parameters. The amount of milk and coffee may be reprogrammed to your taste.

After filling the milk container, place it in the machine. Insert the container pin in its seat.

Make sure the container is inserted up to its limit.

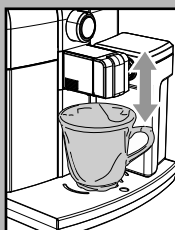

Place the cup you use every day to enjoy your cappuccino.

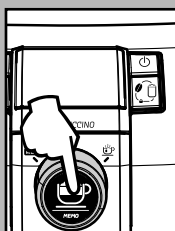

Press and hold the “MEMO” button.

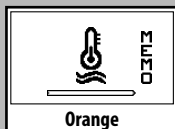

Orange

When the icon on the side appears, release the “MEMO” button. The machine is warming up for the preparation of milk.

In this phase the machine grinds the desired amount of coffee.



Green

Once the machine is warmed up, the brewing of hot milk starts.

The “MEMO” icon will appear on the display.

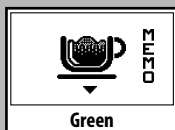

Green

From now on, press the “MEMO” button each time the desired amount of milk is reached in the cup.



Green

Once milk has been prepared, the machine starts brewing the coffee.

The “MEMO” icon will appear on the display.



Green

From now on, press the “MEMO” button each time the desired amount of coffee is reached in the cup.

At this point, the “MEMO” button is programmed; each time it is pressed and released, the machine will brew the same amount of cappuccino that has just been programmed.

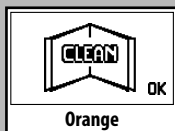

Orange

i Note: After programming, the following page appears. See the “Cleaning of the Milk Brewing System” section.

Adjusting the amount of frothed milk

The machine allows you to adjust the amount of dispensed milk according to your taste and/or the size of your cups.

Whenever you wish, it is possible to brew a programmed amount of frothed milk in your favourite cup. This amount may be reprogrammed to your taste.

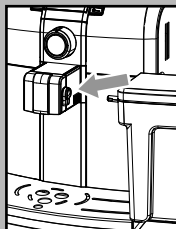

After filling the milk container, place it in the machine. Insert the container pin in its seat. Make sure the container is inserted up to its limit.



Place the cup you use every day to enjoy your hot milk.

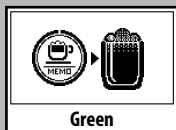

Press the "☕" button until the following page is displayed.

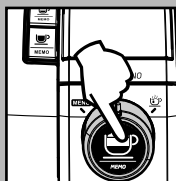

Press and hold the "☕" button.

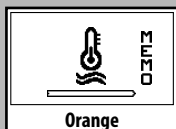

When the icon on the side appears, release the "☕" button. The machine is warming up for the preparation of milk.



Once the machine is warmed up, the brewing of hot milk starts.

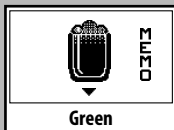

The "☕" icon will appear on the display.

From now on, press the "☕" button each time the desired amount of milk is reached in the cup.

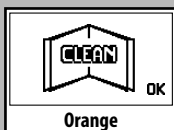

At this point, the "☕" button is programmed; each time it is pressed and released, the machine will brew the same amount of hot milk that has just been programmed.

i Note: After programming, the following page appears. See the "Cleaning of the Milk Brewing System" section.

Stand-by

The machine is designed for energy saving.

The machine automatically turns off after 60 minutes of inactivity.

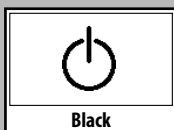

i Note: During the turning off phase, the machine performs a rinse cycle, if a coffee product has been brewed.

To turn the machine on again, simply press the ON/OFF button (if the power button is set to "I"). In this case the machine will go through the rinse cycle only if the boiler is cold.

PROGRAMMING

The user can change some of the machine operating parameters to suit his/her needs.

Enter the "menu"

The programming menu can be accessed at any time when the machine is turned on and ready to be used.

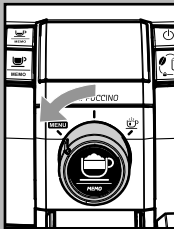

To access the programming menu, turn the selector switch counter-clockwise and set it to the "MENU" position.

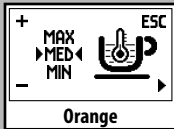

The first page that is displayed is shown here.

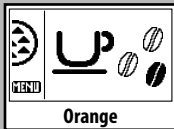
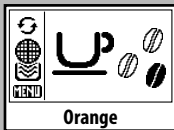

i Important note. When the machine displays the following pages and the selector switch is turned counter-clockwise to be set to the "MENU" position, the machine immediately displays the main menu to complete the requested procedure. This operation facilitates maintenance.

All menu items can still be viewed and edited with the appropriate controls.

Programming controls

Changes can be made on each page:

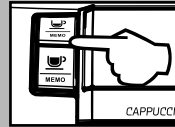
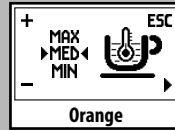

- The "MEMO" and "MEMO" buttons allow changing the value of the function, among those present on the page.

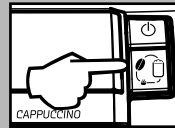

- The "OK" button allows you to scroll the functions and store the performed changes.

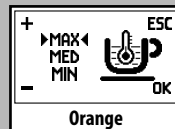

i Note: Changes can be stored only after the displayed value is changed; when the displayed value is changed, the "OK" message appears.

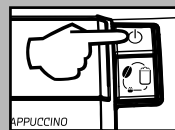

- The "ON/OFF" button allows you to exit the change mode.

Exit Programming Mode

To exit the programming mode, turn the selector switch back to the "OFF" position.

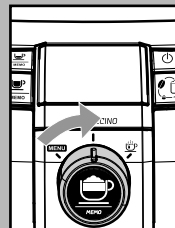

i Note: changes that were not stored with the "OK" button will be ignored.

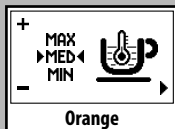

Functions

COFFEE TEMPERATURE

This function allows you to adjust the coffee brewing temperature.

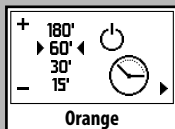

TIMER (STAND-BY)

This function allows you to adjust the time the machine will go into stand-by mode after the last brewing.

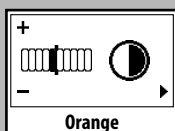

CONTRAST

This function allows you to adjust the contrast of the display to better view the messages.

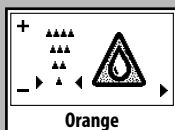

WATER HARDNESS

This function allows you to adjust the water hardness in order to better manage machine maintenance:

▲ = very soft water

▲▲ = soft water

▲▲▲ = hard water

▲▲▲▲ = very hard water

 For details, see the "Water Hardness Measurement" section.

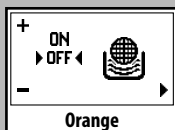

"INTENZA" WATER FILTER

This function allows you to manage the "Intenza" water filter.

For more details, see the section related to filter handling.

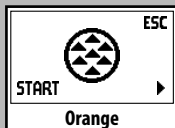

DESCALING

This function allows you to manage the machine's descaling cycle.

For more details, see the section related to descaling.

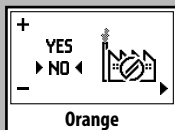

FACTORY SETTINGS

This function allows you to reset all factory values.

Programming Example

In this example, we want to explain how to programme the display contrast. Proceed in a similar manner to change the other functions.



With the machine turned on, access the programming menu, turn the selector switch counter-clockwise and set it to the "MENU" position.

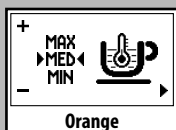

The first page is displayed.

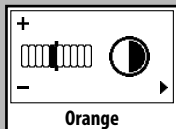

Press the "MEMO" button until the "CONTRAST" function is displayed.

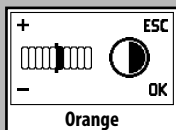

Press the "MEMO" button once to increase the contrast.

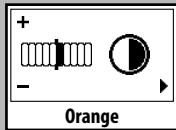

Press the "MEMO" button to confirm.

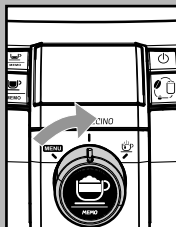

To exit the programming mode, turn the selector switch back to the "MENU" position.

At this point, the function is programmed and will be active immediately.

CLEANING AND MAINTENANCE

General Cleaning

- Empty and clean the coffee grounds drawer daily, with the machine turned on.
- Maintenance and cleaning operations can only be carried out when the machine is cold and disconnected from the power supply.
- Do not immerse the machine in water.
- Do not wash any of its parts in the dishwasher.
- Do not use sharp objects or harsh chemical products (solvents) for cleaning.
- Use a soft, dampened cloth to clean the machine.
- Do not dry the machine and/or its components using a microwave and/or standard oven.
- It is recommended to clean the water tank daily:
 - Remove the small white filter in the water tank and wash it under running drinking water.
 - Reposition the small white filter in its housing by gently pressing and turning it at the same time.
 - Fill the tank with fresh drinking water.
- Empty and clean the drip tray daily. Perform this operation also when the float is raised.
- Also clean the seat of the tray every week through the openings on the bottom of the machine.

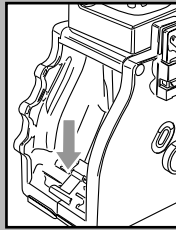
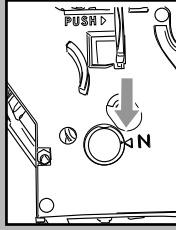
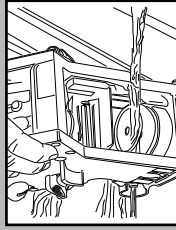
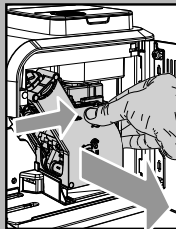
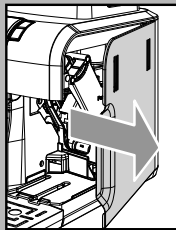
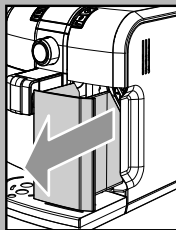
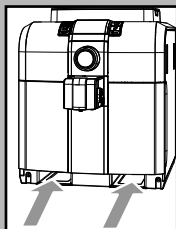
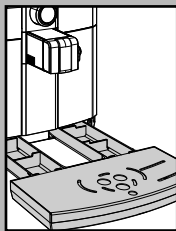
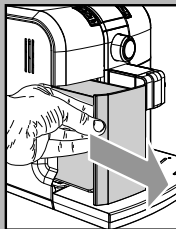
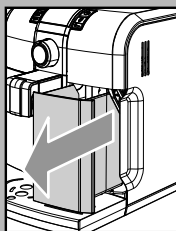

Brew Group

- The Brew Group should be cleaned every time the coffee bean hopper is filled or at least once a week.
- Turn off the machine by pressing the ON/OFF button and remove the plug from the socket.
- Remove the coffee grounds drawer. Open the service door.
- To remove the Brew Group, pull it by the handle and press the «PUSH» button. The Brew Group must be washed only with lukewarm water with no detergent/soap.
- Wash the Brew Group with lukewarm water and carefully clean the upper filter.
- Thoroughly wash and dry all the parts of the Brew Group.
- Thoroughly clean the inside of the machine.
- Make sure that the two reference signs match up.
- Make sure that the lever is in contact with the Brew Group. Press the "PUSH" button to make sure that the Brew Group is in the correct position.

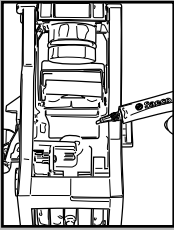

i Lubricate the Brew Group every 30 days or after approximately 500 brewing cycles. The grease to lubricate the Brew Group can be purchased at authorised service centres.

- Lubricate the brew group guides using the supplied grease only.
- Apply the grease evenly on both side guides.

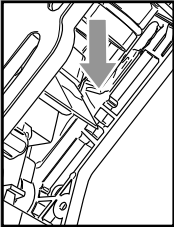
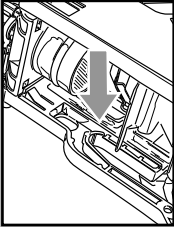

- Insert the Brew Group in its seat until it locks into place WITHOUT pressing the "PUSH" button.
- Insert the coffee grounds drawer. Close the service door.

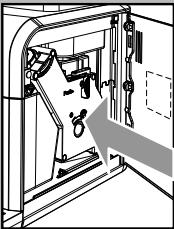

DESCALING

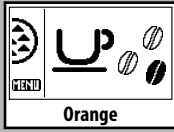

Limescale normally builds up with the use of the appliance.

The display informs you when descaling is necessary:

i In case of conflict, priority must be given to what is indicated in the operation and maintenance manual over the instructions provided on separately sold accessories and materials.

i Empty the drip tray before performing the descaling cycle.

i Use the Saeco descaling product only. Its formula has been designed to ensure better machine performance and operation for its whole operating life. If correctly used, it also avoids alterations in the brewed product.

! **Warning! Never drink the descaling solution or any products dispensed until the cycle has been carried out to the end. Never use vinegar as a descaling solution.**

- Turn the machine on by pressing the ON/OFF button. Wait for the machine to finish its rinse and warm-up process.

! **Warning! Remove the "Intenza" filter before adding the descaling solution.**

i Remove the milk group before performing the descaling cycle.

- Turn the selector switch counter-clockwise and set it to the "MENU" position.

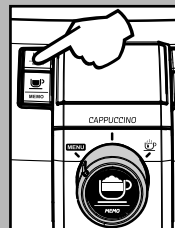
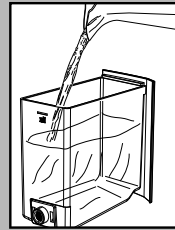
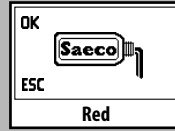
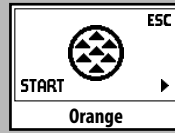

- Then, the page appears on the display to start descaling.

- Press the "MEMO" button to enter the descaling menu.

i If you press the "MEMO" button by mistake, use the same button to quit.

i If you press the "MEMO" button, it is necessary to complete the descaling cycle.

- Pour the entire content of the Saeco concentrated descaling solution into the water tank, and then fill the tank with fresh drinking water up to the MAX level. Place the tank back into the machine.

- Place a container under the dispensing spout.

i Use a container of at least 1 litre capacity. If you do not have a container of this capacity, pause the cycle by pressing the espresso coffee button, empty the container, place it under the dispensing spout and restart the cycle by pressing the same button again.

- Only after adding the descaling solution in the tank, press the "MEMO" button to start the descaling cycle.

- At this point the machine will start dispensing, at regular intervals, the descaling solution (the bar shows the cycle progress).



i Note: The descaling cycle may be paused by pressing the “” button. To resume the cycle, press the button again. This allows you to empty the container or to go away for a short period of time.

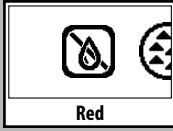

- When the solution in the tank is finished, the icon on the side is displayed.
- The icon indicates that the tank must be rinsed and filled.

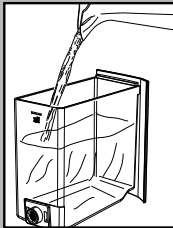

Rinse the water tank thoroughly and refill it with fresh drinking water.

- Empty the container used to collect the liquid dispensed by the machine and place it under the dispensing spout.



- When inserting the tank filled with water the icon on the side is displayed. The rinse cycle of the machine starts.

i Note: The rinse cycle may be paused by pressing the “” button. To resume the cycle, press the button again. This allows you to empty the container or to go away for a short period of time.



- When the water in the tank is finished, the icon on the side is displayed to indicate that the tank must be rinsed and filled with fresh drinking water to finish the cycle.

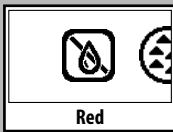

- Empty the container used to collect the liquid dispensed by the machine and place it under the dispensing spout.



- When inserting the tank filled with water the icon on the side is displayed. The rinse cycle of the machine continues.

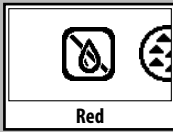

- At the end, fill the tank again with fresh drinking water, and empty the container placed under the dispensing spout.

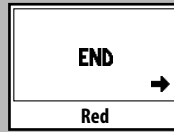

- When inserting the water tank again into the machine, the icon on the side is displayed. Press the “” button to quit the descaling cycle.

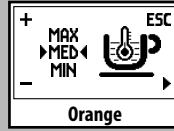

- The machine now carries out the warm-up and rinse cycle to prepare for product brewing.

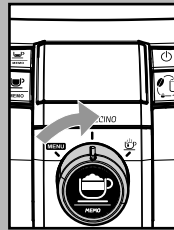

- The main page of the programming menu is displayed.

- Then, turn the selector switch back to the “0” position.

- The descaling cycle is complete.

i The descaling solution must be disposed of according to the manufacturer's instructions and/or regulations in force in the country of use.

i After completing the descaling cycle, wash the brew group as described in the “Brew Group” section in the “Cleaning and Maintenance” section.

i When the descaling cycle is complete, we recommend emptying the drip tray.

CONTROL PANEL DISPLAY

Ready Signals

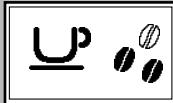

- The machine is ready for brewing coffee and cappuccino with coffee beans.

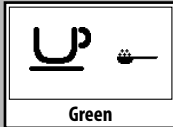

- The machine is ready for brewing coffee and cappuccino with pre-ground coffee.

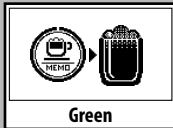

- The machine is ready for hot milk brewing.



- The machine is ready for hot water dispensing.

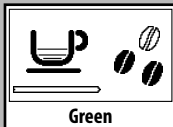

- The machine is brewing 1 cup of espresso coffee.

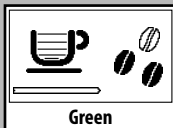

- The machine is brewing 1 cup of long coffee.

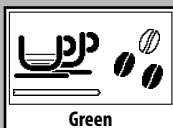

- The machine is brewing 2 cups of espresso coffee.

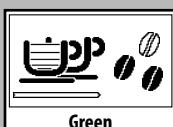

- The machine is brewing 2 cups of long coffee.

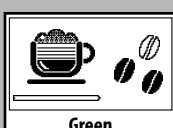

- The machine is brewing a cappuccino with coffee beans.

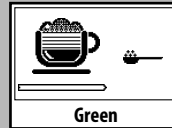

- The machine is brewing a cappuccino with ground coffee.

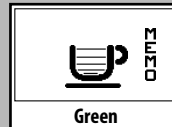

- The machine is programming the amount of coffee to be brewed.



- The machine is programming the amount of hot milk to be brewed.



- The machine is programming the amount of cappuccino to be brewed.

Alarm Signals



Red

- Close the service door.



Red

- No coffee beans in the coffee bean hopper. After refilling the hopper, the cycle can be restarted.

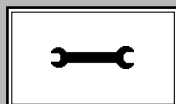

Red

- Turn the machine off. After 30 seconds, turn it back on. Try this 2 or 3 times. If the machine does NOT start, contact an authorised service centre.

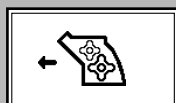

Red

- The Brew Group must be inserted into the machine.

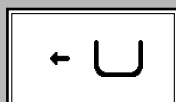

Red

- Insert the coffee grounds drawer.



Red

- Empty the coffee grounds drawer and the liquid recovery tray.

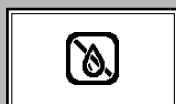

Red

- Fill the water tank.



Red

- Insert the drip tray



Red

- Start screen for descaling cycle activation. Press "ESC" to quit.



Red

- Descaling cycle in progress.



Red

- Descaling cycle PAUSED.

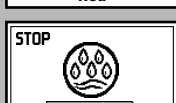

Red

- Rinse cycle of descaling cycle in progress.



Red

- Rinse cycle of descaling cycle PAUSED.

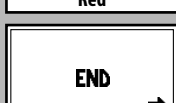

Red

- Descaling cycle ended. Press the "OK" button to quit the descaling cycle.

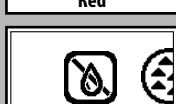

Red

- Fill the water tank.

CONTROL PANEL DISPLAY

Warning Signals



Orange

- The machine is warming up to brew coffee and dispense hot water and steam.



Orange

- The machine is performing the rinse cycle. Wait until the machine stops the operation.

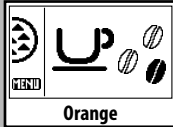

Orange

- The machine needs a descaling cycle.

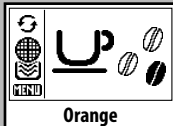

Orange

- The Intenza filter must be replaced with a new one.

i This message will only be displayed if the function is activated in the programming mode.



Orange

The alarm is deactivated only if it is "RESET" in the programming mode.

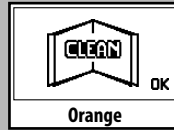

Orange

- The machine needs the milk system to be cleaned. Refer to section "CLEANING OF THE MILK BREWING SYSTEM".

After washing the milk group, press the "MEMO" button to cancel the warning.

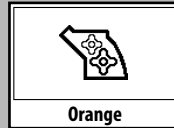

Orange

- The Brew Group is being reset due to machine reset.

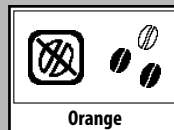

Orange

- Refill the coffee bean hopper with coffee beans and restart the coffee brewing cycle.

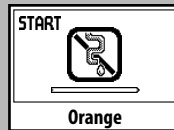

Orange

- Problems with the water circuit. Press the "MEMO" button to start the manual priming cycle of the water circuit.

TECHNICAL SPECIFICATIONS

The manufacturer reserves the right to make changes to the technical specifications of the product.

Nominal Voltage - Power Rating - Power Supply	See label on the inside of the service door
Housing material	Thermoplastic Material/Metal
Size (w x h x d) (mm)	256 x 315 x 415
Weight	.9 kg
Power Cord Length	1.2 m
Control Panel	Front side
Water tank	1.2 litres – Removable
Coffee Bean Hopper Capacity (g)	260
Coffee Grounds Drawer Capacity	8
Pump pressure	15 bar
Boiler	Stainless steel type
Safety Devices	Thermal fuse

TROUBLESHOOTING

Machine Actions	Causes	Solutions
The machine does not turn on.	The machine is not connected to the electric network.	Connect the machine to the electric network.
The coffee is not hot enough	The cups are cold.	Preheat the cups with hot water.
No hot water or cappuccino comes out.	The milk group is clogged.	Clean the milk group. Make sure that the machine is turned off and has cooled before performing this operation.
The coffee has not enough crema. (See note)	The coffee blend is unsuitable, the coffee is not freshly roasted or the grind is too coarse.	Change coffee blend or adjust the grind as explained in section "Coffee Grinder Adjustment".
The machine takes a long time to warm up or the amount of water dispensed from the wand is too little.	The machine circuit is clogged by limescale.	Descalcify the machine.
The brew group cannot be removed.	The brew group is out of place.	Turn on the machine. Close the service door. The brew group automatically returns to the correct position.
	The coffee grounds drawer is inserted.	Remove the coffee grounds drawer before removing the brew group.
The machine grinds the coffee beans but no coffee comes out. (See note)	There is no water.	Fill the water tank and prime the circuit (section "Using the Machine for the First Time").
	The brew group is dirty.	Clean the brew group (section "Brew Group").
	The circuit is not primed.	Prime the circuit (section "Using the Machine for the First Time").
	Rare event that occurs when the machine is automatically adjusting the dose.	Brew a few coffees as described in section "Saeco Adapting System".
	The dispensing spout is dirty.	Clean the dispensing spout.
The coffee is too weak. (See note)	Rare event that occurs when the machine is automatically adjusting the dose.	Brew a few coffees as described in section "Saeco Adapting System".
Coffee is brewed slowly. (See note)	The coffee grind is too fine.	Change coffee blend or adjust the grind as explained in section "Coffee Grinder Adjustment".
	The circuit is not primed.	Prime the circuit (section "Using the Machine for the First Time").
	The brew group is dirty.	Clean the brew group ("Brew Group" section).
Coffee leaks out of the dispensing spout.	The dispensing spout is clogged.	Clean the dispensing spout and its holes.

Note: These problems can be considered normal if the coffee blend has been changed or the machine is being installed for the first time. In this case wait until the machine performs a self-adjusting operation as described in section "Saeco Adapting System".

Please contact customer service for any problems not covered in the above table or when the suggested solutions do not solve the problem.

