

DAILY REFERENCE GUIDE



THANK YOU FOR BUYING A WHIRLPOOL PRODUCT.
For even more complete user support, register your appliance at www.whirlpool.eu/register



Download the **User Manual** from the website <http://docs.whirlpool.eu>
Follow the procedure described on the last page.

Please read the content of the **Health & Safety and Installation Guides** thoroughly before you use this appliance.



The transit bolts must be removed before the appliance is used.

See the **Health & Safety and Installation Guides** for detailed instructions on how to remove the transit bolts

PRODUCT DESCRIPTION APPLIANCE

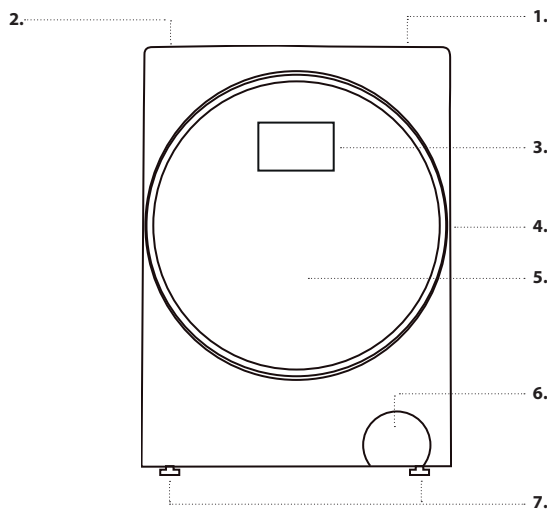

1. Worktop
2. Detergent dispenser
3. Operating panel
4. Door handle
5. Door
6. Pump filter
7. Adjustable feet (4)

CONTROL PANEL

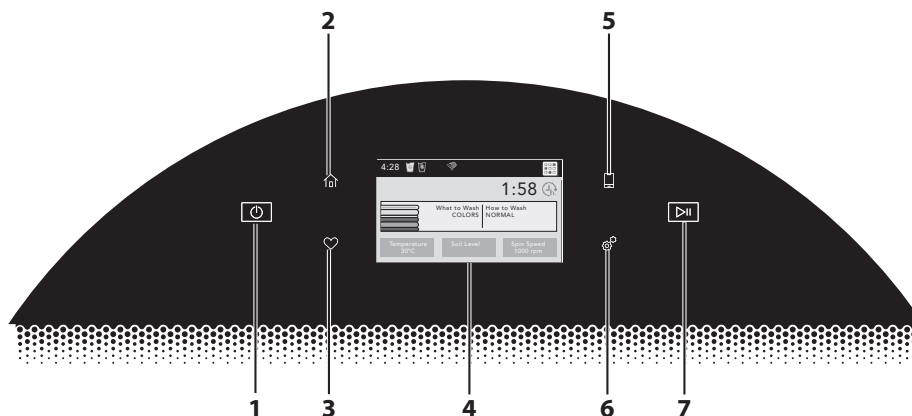

1. POWER BUTTON

Touch to power up the washing machine.

2. HOME BUTTON

Touch this button and the LCD screen will show the home screen, where you can select your cycle, settings, and options.

3. FAVORITES BUTTON

Stores and accesses your favorite cycles.

4. LCD SCREEN

Use this screen to select cycle, settings, options, etc.

5. REMOTE CONTROL BUTTON

Touch this button to set a remote control.

6. TOOLS BUTTON

Touch this button to access the tools screen. For more information, see **SETTINGS**.

7. START/PAUSE BUTTON

Touch to start, or touch to pause a cycle. When you start a cycle, the door will lock, the washing machine will sense the load size, and the wash cycle will begin.

6th SENSE PRECISION DOSE

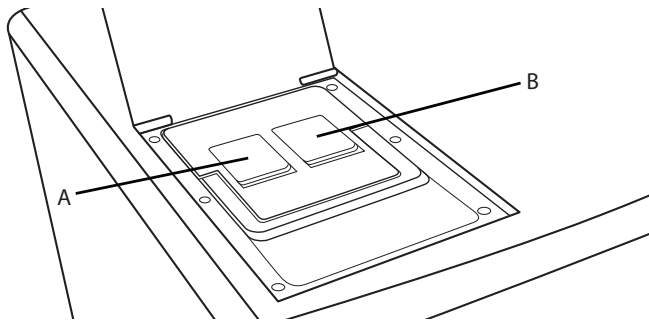

MANUAL DOSING:

In case you do not want to use the dispenser, you can also dose the detergent directly into the drum.

1. Turn Off AUTO DOSING as explained in the SETTINGS - 6th Sense Precision Dose
2. Apply a powder, gel, tabs or liquid detergent directly in drum.
3. Insert the detergent near the beginning of the drum
4. Do not select the prewash option when using manual dosing.

To remove:

1. Lift the bulk dispenser lid on the top of the washing machine.
2. Lift up on the bulk dispenser handle and pull straight up and out of the washing machine.

AUTOMATIC DOSING:

IMPORTANT: Do not use chlorine bleach in this washing machine and do not use powdered detergent in the 6th Sense Precision Dose.

A. Dispenser 1

- Liquid generic detergent OR
- Liquid specific detergent (e.g. for colours, wool, sports garments etc.)

Maximum filling quantity: 1000 ml

IMPORTANT: Never fill Fabric Softener in Tank 1.

B. Dispenser 2

- Fabric softener OR
- Liquid detergent (generic or specific detergent such as colour, wool or sport detergent)

Maximum filling quantity: 500 ml.

Choose your preferred configuration among those mentioned in section HOW TO USE APPLIANCE-SETTINGS.

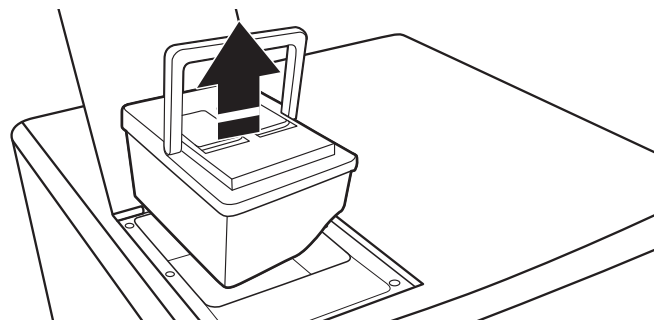

To replace:

1. Place the bulk dispenser back into the bulk dispenser cavity on the top of the washing machine and make sure that it is seated correctly.
2. Close the bulk dispenser lid.

HOW TO USE THE APPLIANCE

FIRST TIME USE

See the section on **DAILY USE** for information on how to select and start a programme.

FIRST CYCLE

If you plug in the washing machine, it will switch on automatically. You will be asked to set the desired display language.

Scroll UP or DOWN key to select the desired language, afterwards confirm by pressing the OK key. Afterwards determine if you want to use softener or detergent for Tank 2 of the detergent dispenser (6th Sense Precision Dose). To remove any residues from the manufacturing process:

- Select the "Cotton + Sanitize" programme at a temperature of 90°C
- Add a small amount of heavy duty detergent to the manual dosing compartment of the detergent dispenser (maximum 1/3 of the quantity recommended by the detergent manufacturer for lightly soiled laundry) and press the Auto dosing buttons - the light of these buttons must be off
- Start the programme **without adding any laundry**.

DAILY USE

HOW TO USE THE WASHING MACHINE

1. LOAD LAUNDRY

- Prepare your laundry according to the recommendations in section "HINTS AND TIPS".
- Make sure that fasteners are closed and ribbons tied together.
- Open the door and load the laundry. Observe the maximum load sizes given in the programme chart

2. CLOSE DOOR

- Make sure that no laundry gets stuck between door glass and rubber seal.
- Close the door so that you can hear it click shut.



3. OPEN THE WATER TAP

- Make sure that the washing machine is connected to the mains.
- Open the water tap



4. SWITCH ON WASHING MACHINE

- Press the On/Off button. An animation appears, and there is a sound. The programme which was used last shows up. Afterwards the washing machine is ready to be operated.



5. SET THE DESIRED WHAT TO WASH

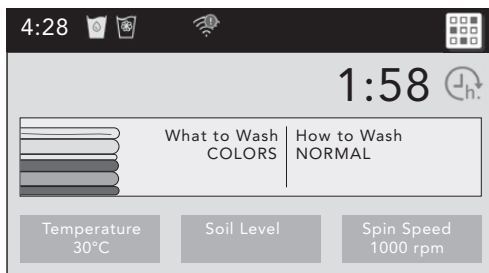

From the home screen, touch the "What to Wash" area of the screen to select the program that best matches the items you want to wash. You may need to scroll down with your finger to see all of the selections. Touch the desired program to return to the home screen.

AUTO DOSING FUNCTION

The detergent dispenser of the washing machine is equipped with a two tanks system for the automatic dispensing of liquid detergent and softener.

Before using this function, follow the instructions in the SETTINGS to:

Set tank 2 content. By default, Tank 1 is set for a detergent (your main detergent), and Tank 2 is set for fabric softener. If you do not use fabric softener, set Tank 2 for detergent too.

Touch the "How to Wash" area of the screen to select the program that best matches the method that you would like to wash those items. You may need to scroll down with your finger to see all of the selections. Touch the desired program to return to the home screen.

6. SELECT TEMPERATURE, SOIL LEVEL AND SPIN SPEED



From the home screen, touch the "Temperature" area of the screen to show the Temperature settings available for the cycle/program chosen in Step 5. Touch the desired setting and touch OKAY to confirm that setting.

Touch the "Spin Speed" area of the screen to show the Spin Speed settings available for the cycle/program chosen in Step 5. Touch the desired setting and touch OKAY to confirm that setting.

7. SELECT OPTION

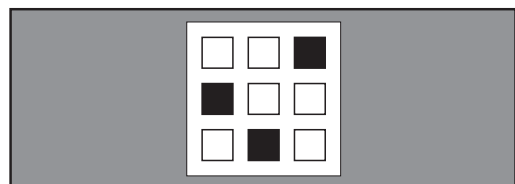

From the home screen, touch the Options icon (at upper right of screen) and the Options screen will show Prewash, Fresh Care, Mutirinse and Easy Iron selections. Previously selected "What to Wash" and "How to Wash" options will be shown on the screen. Touch the screen for each option to change its setting. Not all options and settings are available with all programs/cycles. See "PROGRAMME CHART" for available options and settings. Refer to section OPTIONS for more information.

8. ADD DETERGENT

- If you want to add the detergent **manually**, open the door and add detergent in to the drum as indicated in section 6th Sense Precision Dose.
- If you want the washing machine to dose the detergent **automatically**, simply make sure the Auto Dosing function is activated (refer to section USER MANUAL / OPTIONS, FUNCTIONS AND INDICATORS / Using the 6th Sense Precision Dose). The detergent is added by the auto dosing system after programme start.

9. START PROGRAMME

- Press "Start/Pause" button, the programme starts.



10. CHANGE A RUNNING PROGRAMME, IF NEEDED

You can still change the settings while a programme is running. The changes will be applied, provided the respective programme phase has not finished yet.

- Press the relevant button (for example the "Spin speed" button to change the spin speed). The display indicates that the value can be set.
- Pick the correct value by moving the pointer to the RIGHT or LEFT on the screen. To change the settings of a running programme, you can also
- Press "Start/Pause" to pause the running programme
- Change your settings

SETTINGS

The Tools button gives access to many other settings, utility cycles, preferences, and information. Touch the TOOLS button to access the Tools screen, which contains the following (you will need to scroll down with your finger to access all of the selections).

6th Sense Precision Dose Dispenser 1

Press this icon to access:

6th Sense Precision Dose Status Dispenser 1 and choose between:

- Active
- Disabled (1 Cycle)
- Off (Permanently)

Detergent Concentration Dispenser 1 and choose between:

- 10 ml
- 15 ml
- 20-35 ml
- 40-70 ml
- 70-170 ml

6th Sense Precision Dose Dispenser 2

Press this icon to access:

6th Sense Precision Dose Status Dispenser 2 and choose between:

- Active
- Disabled (1 Cycle)
- Off (Permanently)

6th Sense Precision Dose Content Dispenser 2 and choose between:

- Softener
- Detergent

Once set at Detergent:

Set Concentration Dispenser 2 and choose between:

- 10 ml
- 15 ml
- 20-35 ml
- 40-70 ml
- 70-170 ml

- Press "Start/Pause" again to continue the programme.

11. PAUSE A RUNNING PROGRAMME AND OPEN THE DOOR, IF NEEDED (ADD GARMENT)

- During the initial minutes of the cycle the ADD GARMENT button appears. Pressing it the machine is paused and the door is unlocked to allow the addition of items. Follow the instructions on the display.



12. RESET A RUNNING PROGRAMME, IF NEEDED

- Press on the display the icon near the name of the cycle until it asks to confirm "Proceed or back" to cancelled the programme.

The water drains, the programme ends and the door unlocks.

13. SWITCH OFF THE WASHING MACHINE AFTER PROGRAMME END

- The display indicates that the cycle has ended, you can take out your laundry

- Press "On/Off" to switch off the washing machine. If you do not switch it off the washing machine will switch off automatically after about five minutes after programme end, to save energy.



- Leave the door ajar, so that the inside of the washing machine can dry.

Control Lock

Press this icon to lock the controls. Swipe up to unlock.

Mute

Press this icon to mute or unmute sounds.

Utility Cycles

Press this icon to access the following utility cycles: Spin, Drain, Rinse & Spin. Touch the utility cycle you wish to use and follow the screen prompts.

Preferences

Press to access Times and Dates, Sound Volume, Display Settings, and Regional. Follow the screen prompts.

WiFi

Press to access Connect to Network, SAID Codes, Mac Address, and WiFi. Follow the screen prompts.

Info

Press to access Service & Support, Store Demo Mode, Restore Factory, WiFi Terms and Conditions, and Software Terms and Conditions. Follow the screen prompts.

WARNING: Do not activate store DEMO MODE. If you see a warning that refers to DEMO MODE go into TOOLS, INFO and make sure that STORE DEMO MODE is OFF.

HINTS AND TIPS

SORT YOUR LAUNDRY ACCORDING TO





- Type of fabric / care label (cotton, mixed fi synthetics, wool, handwash items)
- Colour (separate coloured and white items, wash new coloured articles separately)
- Size (wash items of different sizes in the same wash load to improve washing efficiency and distribution in the drum)
- Delicates (wash small items – like nylon stockings – and items with hooks – like bras – in a cloth bag or pillow case with zip).

EMPTY ALL POCKETS

- Objects like coins or safety pins can damage your laundry as well as the drum.

WASH CARE LABELS

The temperature in the washtub symbol indicates the maximum possible temperature for washing the item.

-  Normal mechanical action
-  Reduced mechanical action
-  Much reduced mechanical action
-  Hand wash only
-  Do not wash























CLEAN THE PUMP FILTER REGULARLY

- Helps to avoid that it can get clogged and that the drain water cannot be pumped out anymore. Refer to section USER MANUAL / CLEANING AND MAINTENANCE / “Cleaning the pump filter”.

SAVINGS AND ENVIRONMENT

- Achieve the best use of energy, water, detergent and time by using the recommended maximum load size for the programmes, as indicated in the programme chart.
- Do not exceed the detergent dosages indicated in the detergent manufacturer’s instructions. Use the Auto dosing function.
- Use the Remote Control mode to programme and start the washing machine while the energy costs are lower.

PROGRAMME CHART

Programme	How to wash	Care labels (default programme)	Temperature °C Range	Max load (Kg)	Selectable using the option					Selectable directly		Spin Max. spin speed (rpm)	Detergent and additives	
					Prewash	Fresh Care	Soil Level	Extra Rinse	Easy Iron	Auto dosing 	Finish in		Detergent	Softener 
ECO COTTON	N		Cold/60°C	12.0	-	✓	-	✓	-	✓	✓	1400	●	○
COTTON	N-R-I-G-S		Cold/90°C	12.0	✓	✓	✓	✓	✓	✓	✓	1400	●	○
MIXED	N-R		Cold/60°C	7.0	-	✓	✓	✓	✓	✓	✓	1400	●	○
SYNTHETICS	N-R-G		Cold/60°C	5.0	✓	✓	✓	✓	✓	✓	✓	1200	●	○
DELICATES	N-R-G		Cold/40°C	3.0	-	✓	✓	✓	✓	✓	✓	600	●	○
WOOL	N		Cold/40°C	2.0	-	-	✓	✓	-	✓	✓	400	●	○
SHIRTS/BUSINESS	N-R-G		Cold/30°C	3.0	✓	✓	✓	✓	✓	✓	✓	400	●	○
WHITES	N-I-G-S		Cold/60°C	12.0	✓	✓	✓	✓	✓	✓	✓	1400	●	○
COLORS	N-R-G		Cold/30°C	7.0	✓	✓	✓	✓	✓	✓	✓	1000	●	○
JEANS	N-R-I-G		Cold/60°C	6.0	-	✓	✓	✓	✓	✓	✓	1000	●	○
SPORT	N-R		Cold/60°C	4.0	-	✓	✓	✓	✓	✓	✓	1400	●	○
BABY ITEMS	N-R-I-G		Cold/60°C	6.0	✓	✓	✓	✓	✓	✓	✓	1000	●	○
BED LINEN	N-R-I-G-S		Cold/90°C	3.5	✓	✓	✓	✓	✓	✓	✓	1400	●	○
DUVET	N-R-G		Cold/40°C	3.5	-	✓	✓	✓	✓	✓	✓	600	●	○
BATH/KITCHEN CARPETS	N-R-G		Cold/40°C	3.0	-	✓	✓	✓	✓	✓	✓	600	●	○
CURTAINS	N-R-G		Cold/40°C	3.0	-	✓	✓	✓	✓	✓	✓	600	●	○
TOWEL/BATH ROBES	N-R-I-G-S		Cold/90°C	10.0	✓	✓	✓	✓	✓	✓	✓	1400	●	○
PETS STUFF	N-R-G		Cold/40°C	3.0	-	✓	✓	✓	✓	✓	✓	600	●	○
GARDENING CLOTHES / OUTDOOR	N-R-I-G		Cold/60°C	6.0	✓	✓	✓	✓	✓	✓	✓	1000	●	○
BATHING SUITE	N		Cold/40°C	2.0	-	-	✓	✓	-	✓	✓	400	●	○
SPIN	-		-	12.0	-	✓	-	-	-	-	✓	1400	-	-
RINSE & SPIN	-		-	12.0	-	✓	-	✓	-	✓	✓	1400	-	○
DRAIN	-		-	12.0	-	-	-	-	-	-	✓	1400	-	-

N Normal (Default)

R Rapid

G Gentle

✓ Selectable/optional

● Needed

I Intensive

S Sanitize

- Not selectable/applicable

○ Optional

Values measured in normal conditions in accordance with IEC/EN 60456. The above test result are based on using the powder detergent with manual dosing as indicated in section 6th Sense Precision Dose. Water, energy and remaining moisture content values refer to the default setting of the programmes, without options. max = maximum load capacity of the washing machine Acoustic values on declaration label refer to appliance after complete installation.

Eco Cotton is the standard programme for washing normally soiled cottons, and it is the most efficient programme in terms of combined water and energy consumption. For reasons of energy saving, the real water temperature may deviate from the specified cycle temperature.

Power consumption in off-mode is 0.4 W, in left-on mode 3 W, network stand-by 1 W.

PROGRAMMES

Observe the recommendations on the care labels of your laundry.

ECO COTTON

Normally soiled cotton laundry. At 40 °C and 60 °C standard cotton programme and most favourable programme in terms of combined water and energy consumption for washing cotton laundry. The values on the Energy label are based on this programme.



COTTON

Normally to heavily soiled and robust cotton and linen laundry, such as towels, underwear, table linen etc.

MIXED

Lightly to normally soiled robust laundry made of cotton, linen, artificial fibres and their blends. 1-hour programme.

SYNTHETICS

Normally soiled laundry made of artificial fibres (like polyester, polyacryle, viscose etc.) or their blends with cotton.

DELICATES

Fine laundry made of delicate fabrics, which needs gentle treatment.

WOOL

Woolens, labeled with the Woolmark and identified as machine washable, as well as textiles made of silk, linen, wool and viscose marked as handwashable.

SHIRTS/BUSINESS

Shirts, blouses and fine business clothes made of cotton, synthetics or their blends.

WHITES

For washing normally to heavily soiled towels, underwear, table and bed linen, etc in resilient cotton and linen.

Only when the temperature is selected at 90°C the cycle is provided with a prewash phase before main washing phase. In this case it is recommended to add detergent both, in the prewash and main wash section.

COLORS

Lightly to normally soiled laundry made of cotton, synthetics or their blends; also delicates. Helps preserving colours.

JEANS

Normally soiled cotton jeans-wear and garments made of robust jeans-like material, such as trousers and jackets.

OPTIONS

Refer to the Programme Chart to check if options are available for the selected programme

OPTIONS which are selectable by pressing the Options button

Prewash

Helps to clean heavily soiled laundry by adding a prewash phase to the wash programme selected. Extends the programme by about 20 minutes. For adding detergent to the prewash phase make sure to be use the 6th Sense Precision Dose.

Fresh Care

Helps to keep your laundry fresh if you cannot unload it soon after programme end. The washing machine finishes with a short spin of the same speed selected by user and after that will start to tumble the laundry periodically a short time after programme end. This tumbling will last up to approximately 6 hours after the end of your washing programme. You can stop it at any time by pressing on the screen button; the door unlocks and you can take out your laundry.

SPORT

Normally soiled and sweaty sportswear made of cotton jersey or microfibers Includes a prewash cycle – you can add detergent also to the prewash chamber. Do not use softener.

BABY ITEMS

Normally soiled baby clothes made of cotton and/or linen. The suds are rinsed out even more thoroughly, which helps to protect sensitive baby skin.

BED LINEN

White or coloured bed linen made of cotton and synthetic fibers or blends of both.

DUVET

Big items such as sleeping bags, washable blankets, bathmats, pillows and duvets fi with feathers or synthetic material.

BATH/KITCHEN CARPETS

Cycle designed for washing carpets, ensuring perfect dirt removal.

CURTAINS

Use this cycle to wash curtains. We recommend the use of special detergent which has been designed to wash delicate clothes.

TOWEL/BATH ROBES

Normally to heavily soiled and robust cotton and linen laundry, such as towel, bath robes.

PET STUFF

Perfect to remove animal hair from pet stuff.

GARDENING CLOTHES / OUTDOOR

Program developed for an accurate wash of particularly dirty clothing (e.g. ground or grass stains).

BATHING SUIT

Bathing Suit identified as machine washable marked or handwashable.

SPIN

Separate intensive spin programme. For robust laundry.

RINSE & SPIN

Separate rinse and intensive spin programme. For robust laundry.

DRAIN

Separate programme to drain the water, without spinning.

Soil Level

Helps to clean heavily soiled, stained laundry by optimising the efficiency of additives for stain removal.

Extra Rinse

Helps to avoid detergent residues in the laundry by extending the rinse phase. Particularly suitable for washing baby laundry, for people suffering from allergies and for areas with soft water.

Easy iron

Help to reduce the formation of creases. The wash and the cycles will be modified.

MAINTENANCE AND TROUBLESHOOTING GUIDE

See the **User Manual** for instructions on maintenance procedures and troubleshooting problems.

TECHNICAL DOSSIER

The technical dossier containing energy consumption figures may be downloaded from the Whirlpool website <http://docs.whirlpool.eu>



CONTACTING THE AFTER-SALES SERVICE

When contacting the After-Sales Service, you will need to be able to provide the codes indicated on the adhesive label on the inner side of the door. The telephone number is indicated in the warranty booklet.

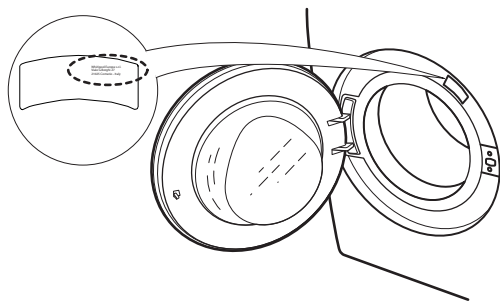

HOW TO RECEIVE THE INSTRUCTIONS FOR USE

- > Phone the After-Sales Service
- > Use this QR Code



- > Download the guide from the Whirlpool website

<http://docs.whirlpool.eu>

To do this, you need to enter the correct commercial code of the product indicated on the adhesive label.

