

# Dell Wyse 5070 and 5070 Extended Thin Client

## Accessories Setup Guide



## Notes, cautions, and warnings

 | **NOTE:** A NOTE indicates important information that helps you make better use of your product.

 | **CAUTION:** A CAUTION indicates either potential damage to hardware or loss of data and tells you how to avoid the problem.

 | **WARNING:** A WARNING indicates a potential for property damage, personal injury, or death.

© 2018 Dell Inc. or its subsidiaries. All rights reserved. Dell, EMC, and other trademarks are trademarks of Dell Inc. or its subsidiaries. Other trademarks may be trademarks of their respective owners.

# Contents

<b>1 Supported displays .....</b>	<b>4</b>
<b>2 Mounting the thin client on the vertical stand.....</b>	<b>5</b>
<b>3 Installing the thin client on the E-series VESA mount.....</b>	<b>6</b>
<b>4 Installing the thin client on the VESA wall mount .....</b>	<b>10</b>
<b>5 Installing the thin client on the P and U series VESA mount.....</b>	<b>12</b>
P and U series mount with display in vertical and horizontal orientation.....	14
<b>6 Installing the thin client on the Dual VESA mount.....</b>	<b>16</b>
Dual VESA mount display in vertical and horizontal orientation.....	18

# Supported displays

The following Dell displays are supported by Dell Wyse 5070 thin client:

- MR2416
- U2518D
- U2718Q
- U2419H/HC
- U2415
- U2719D/DC
- P2415Q
- P2417H
- P2317H
- P2217H
- P2016
- P2419H/HC
- P2719H/HC
- P4317Q
- E2417H
- E2318H
- E2218HN
- E2016H
- E1916H
- P3418HW
- P2219HC/P2219H
- P2319H

For more information about these displays, see [Dell Support](#).

## Mounting the thin client on the vertical stand

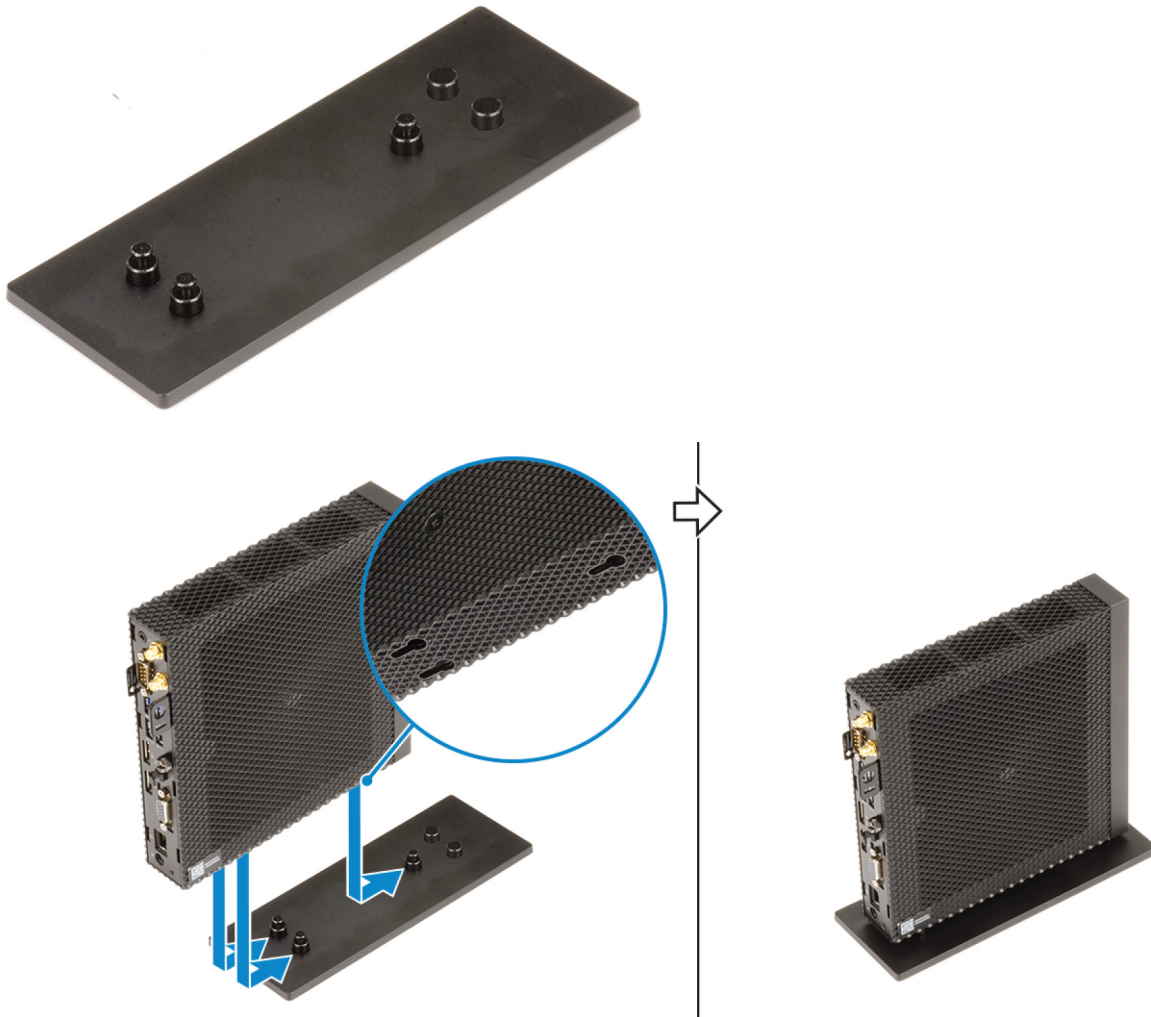

Figure 1. Attaching the vertical stand

## Installing the thin client on the E-series VESA mount



1

Figure 2. Removing the back cover plates

2

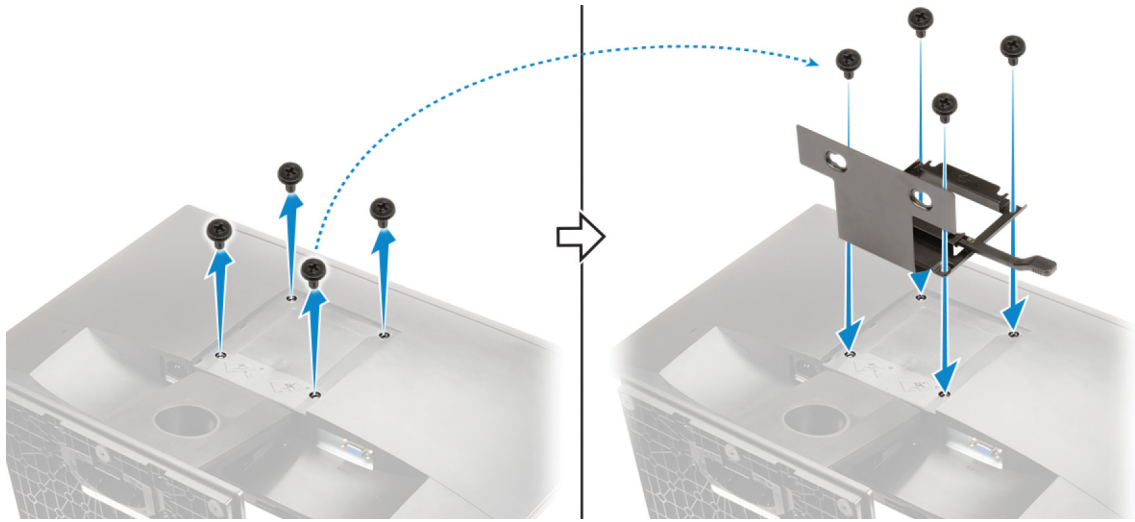

Figure 3. Fixing the E-series mount

3

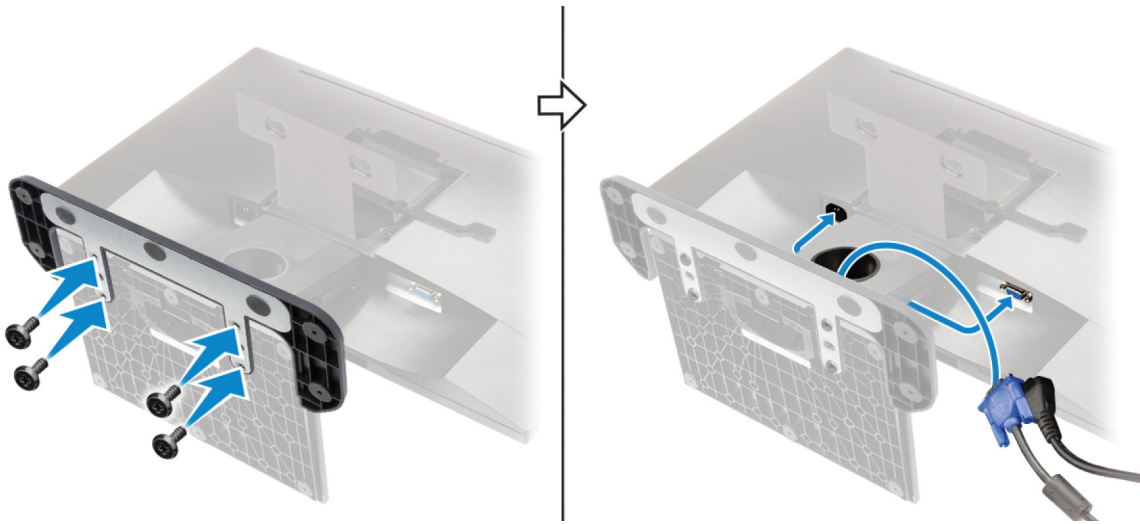

Figure 4. Routing the cables

4

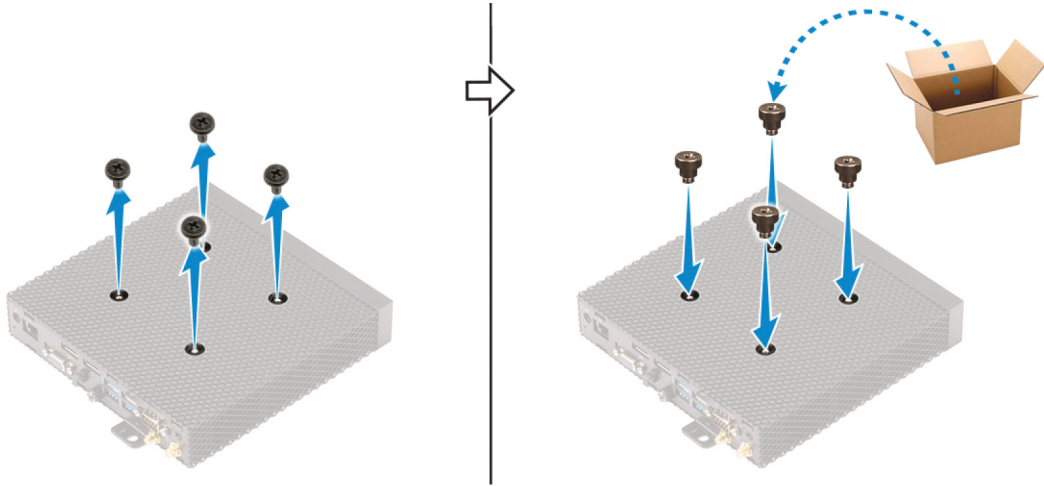

Figure 5. Tightening the shoulder screws

5

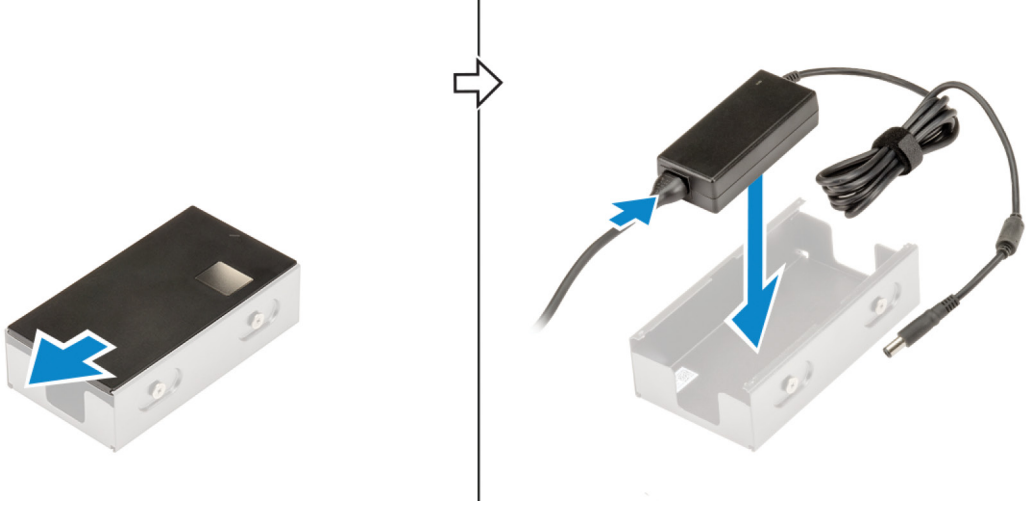

Figure 6. Inserting the cables into the adapter box

6

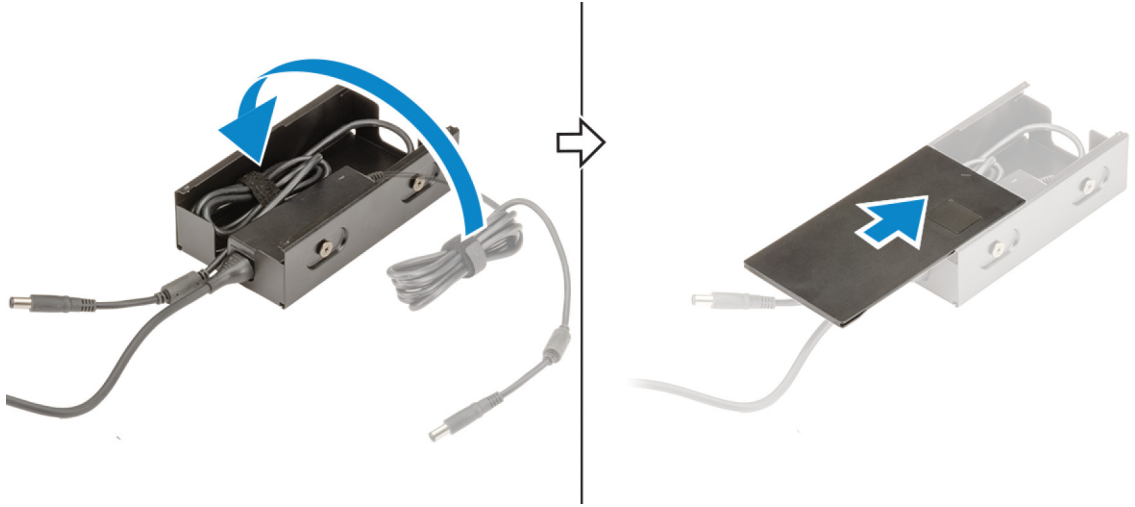

Figure 7. Locking the adapter box



7

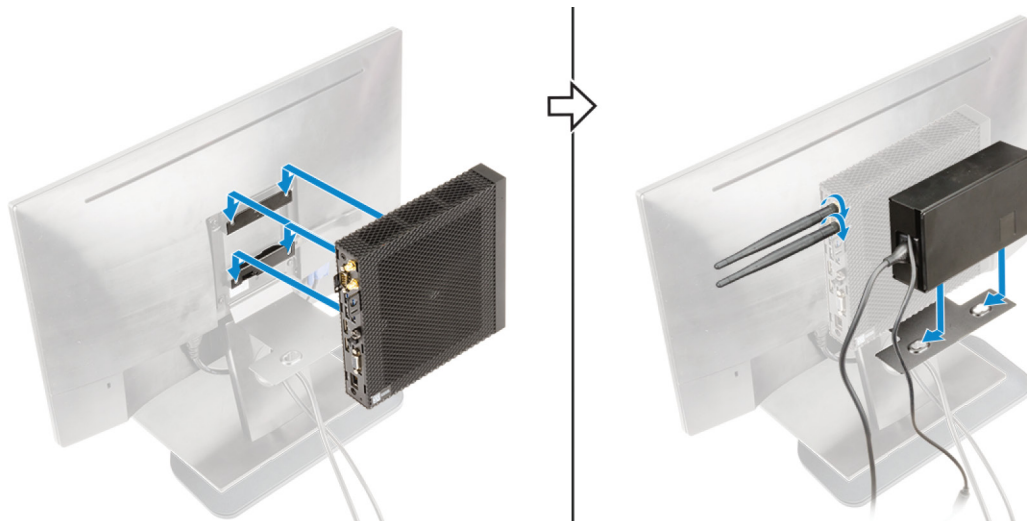

Figure 8. Attaching the thin client and adapter box

8

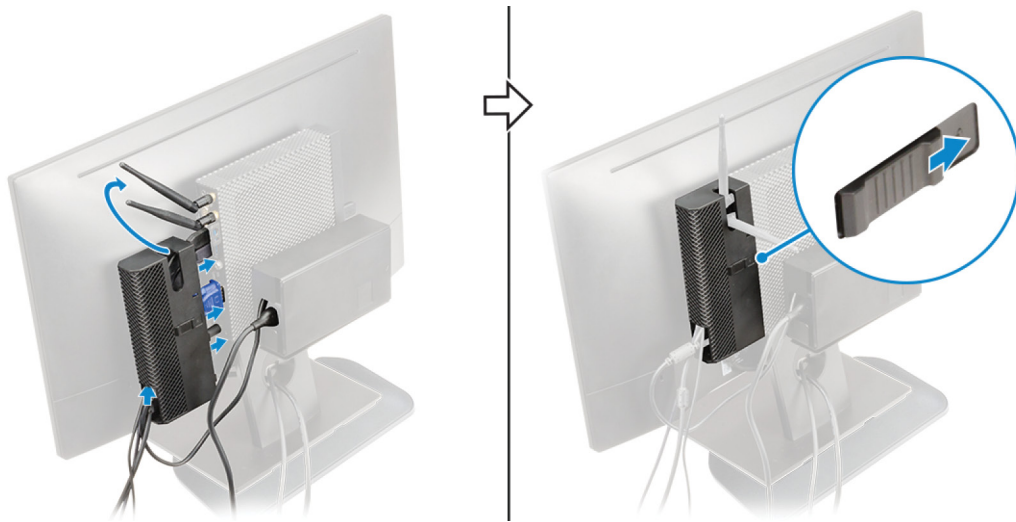

Figure 9. Attaching the cable cover

## Installing the thin client on the VESA wall mount

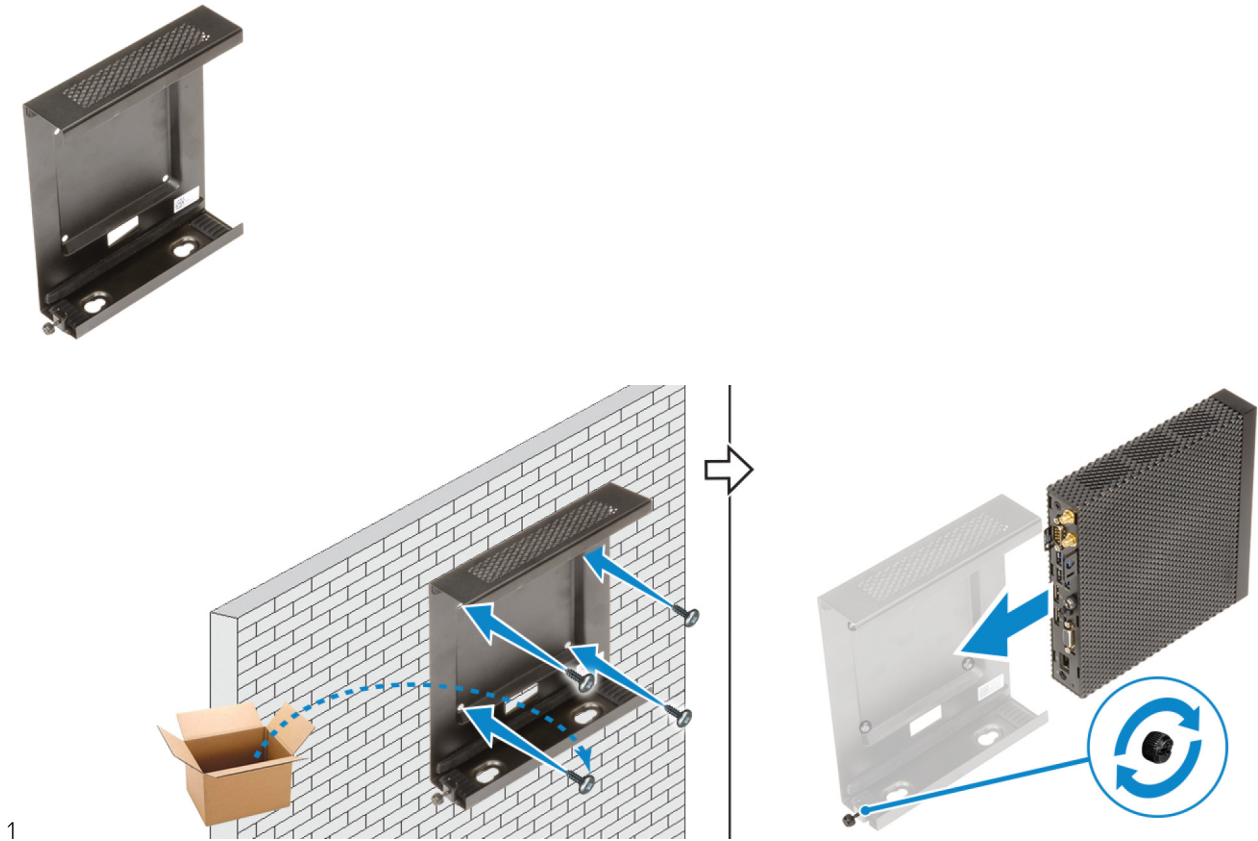

Figure 10. Insert the thin client into the metal bracket

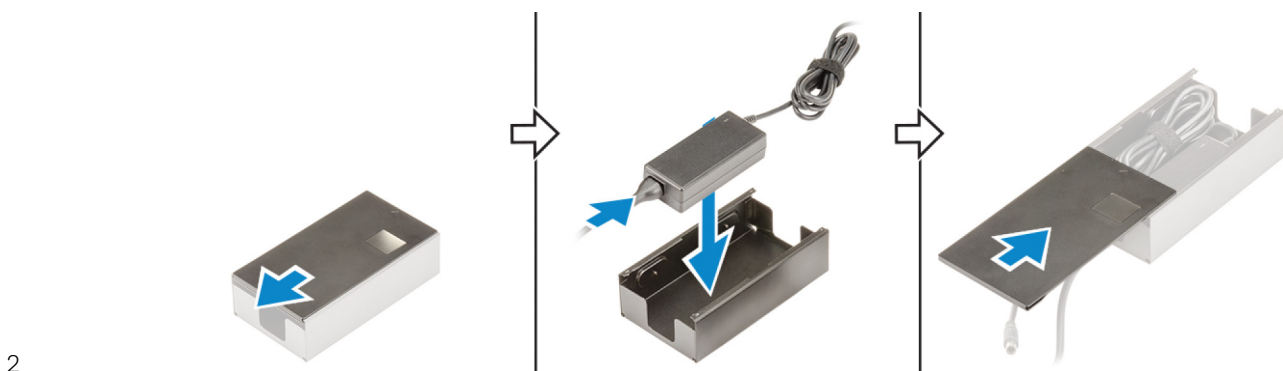

Figure 11. Inserting the cables into the adapter box

3

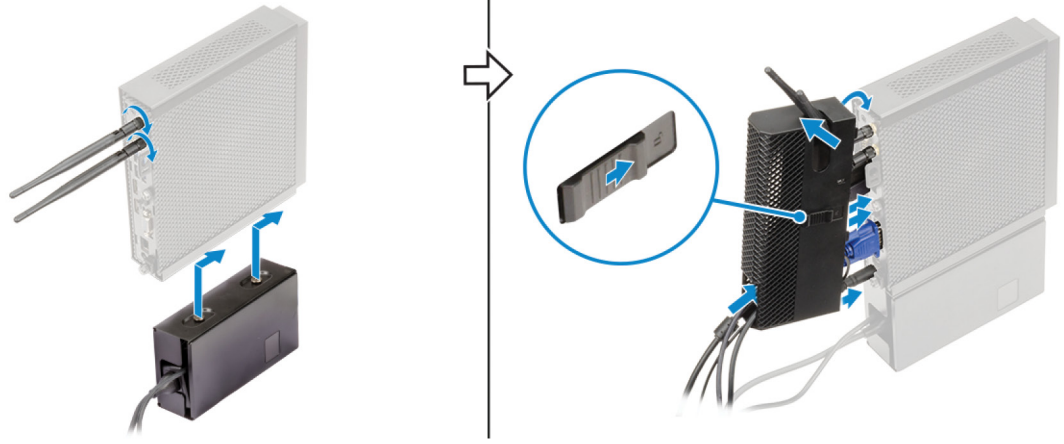

Figure 12. Attaching the cable cover

## Installing the thin client on the P and U series VESA mount

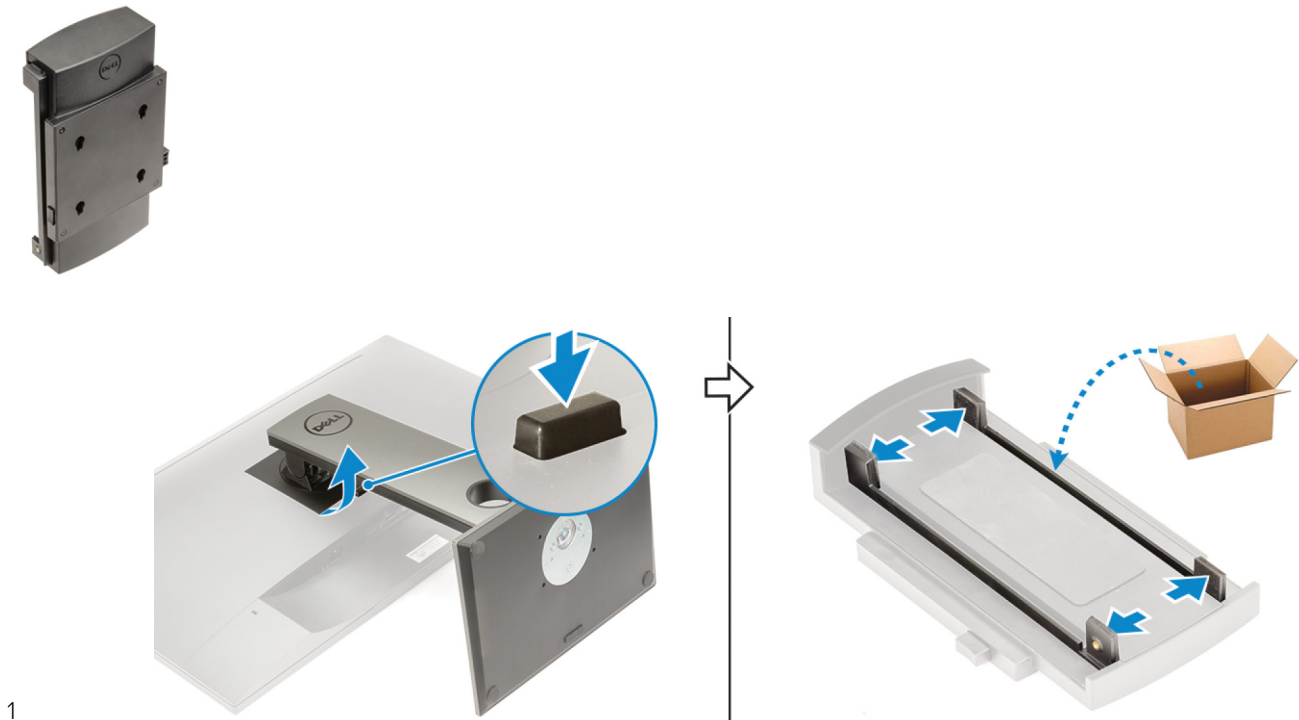

Figure 13. Assembling the P/U mount holder

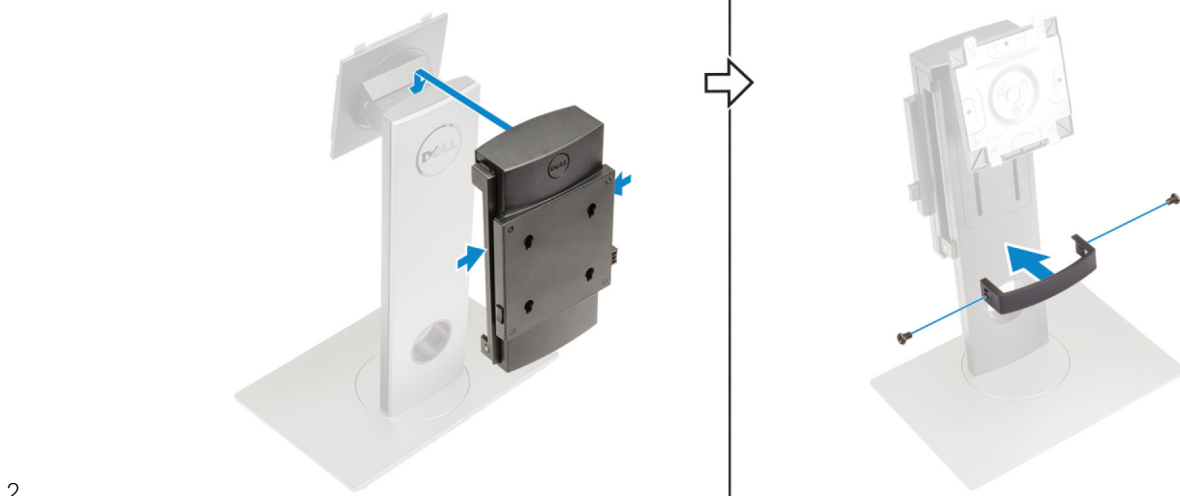

Figure 14. Engaging the P/U mount into the stand with the pocket clip

3

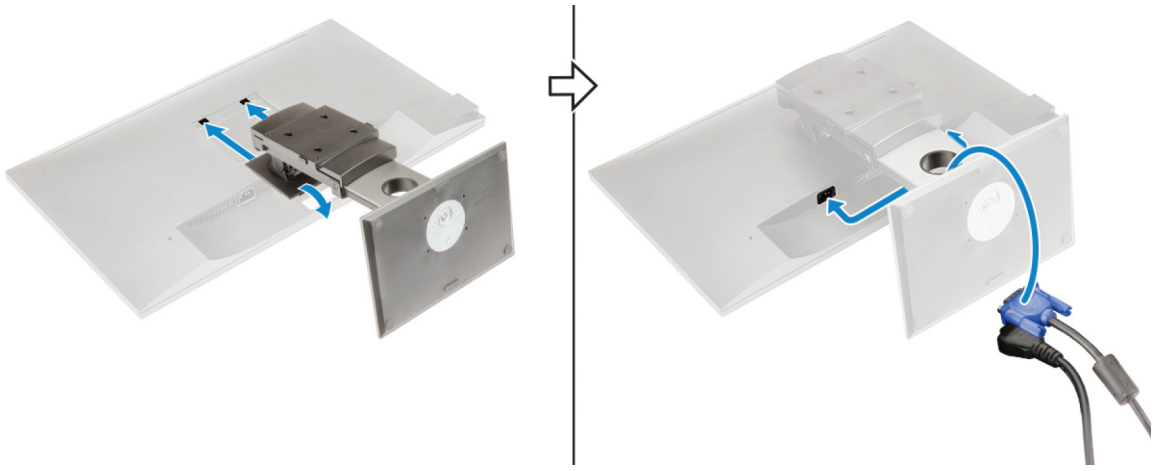

Figure 15. Assembling the stand with the P/U mount to the display

4

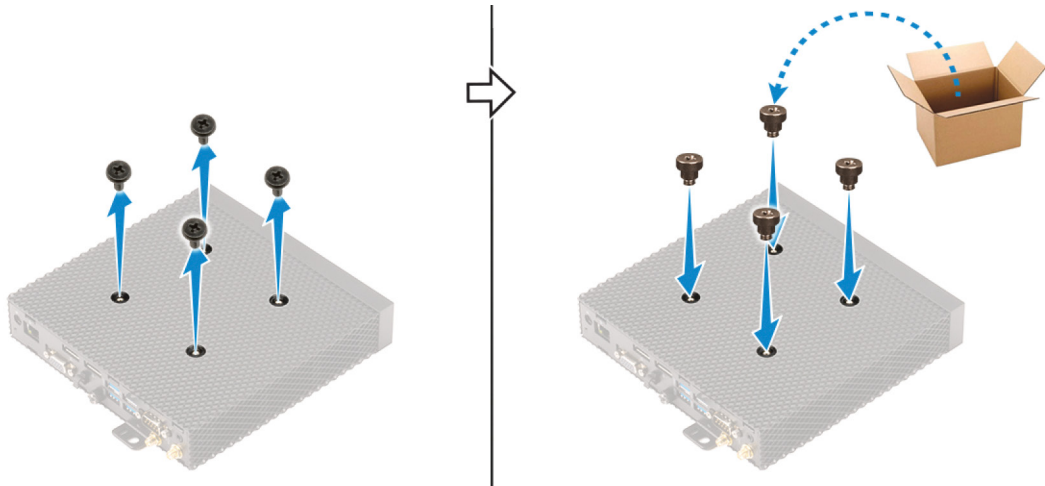

Figure 16. Tightening the shoulder screws

5

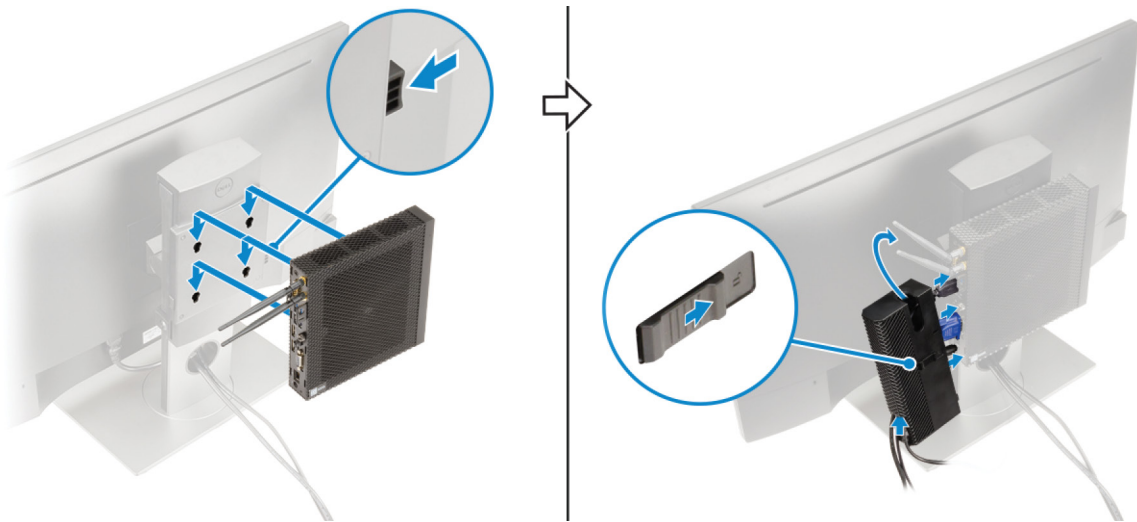

Figure 17. Attaching the cable cover

## P and U series mount with display in vertical and horizontal orientation

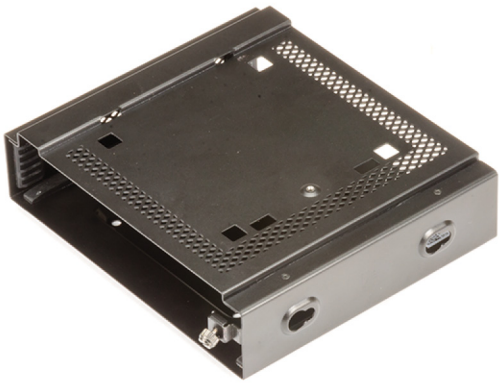

Figure 18. Display in vertical orientation

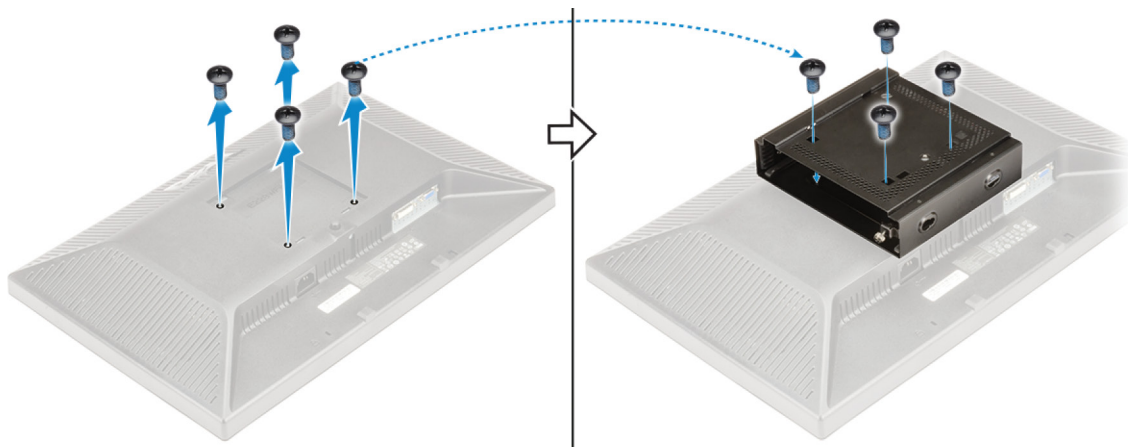

**Figure 19. Display in horizontal orientation**

## Installing the thin client on the Dual VESA mount



**NOTE:** Always mount the Wyse 5070 thin client in a vertical position as shown in the images. Do not mount the thin client in any other orientation. However, you can rotate the display to either a horizontal or vertical orientation before mounting the thin client.



1

Figure 20. Attaching the dual VESA metal bracket to the display



2

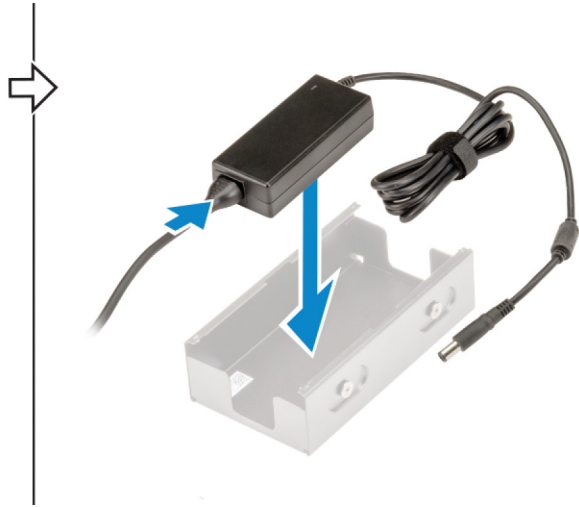

Figure 21. Inserting the cables into the adapter box

3

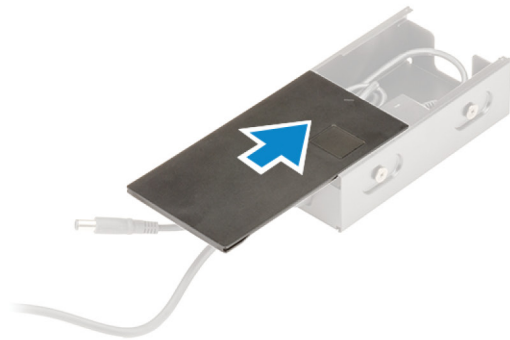
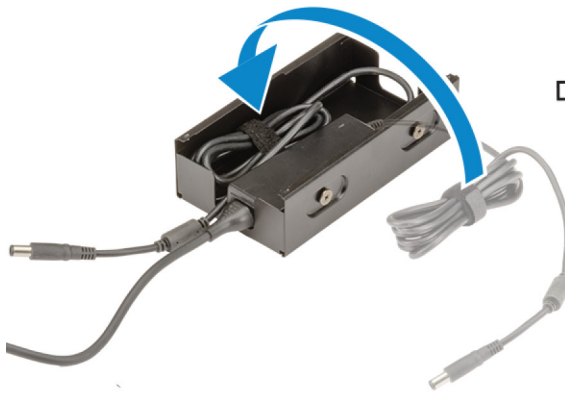

Figure 22. Locking the adapter box

4

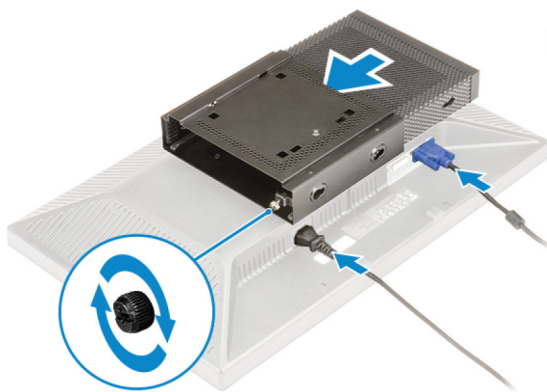

Figure 23. Mounting the thin client and adapter box

5

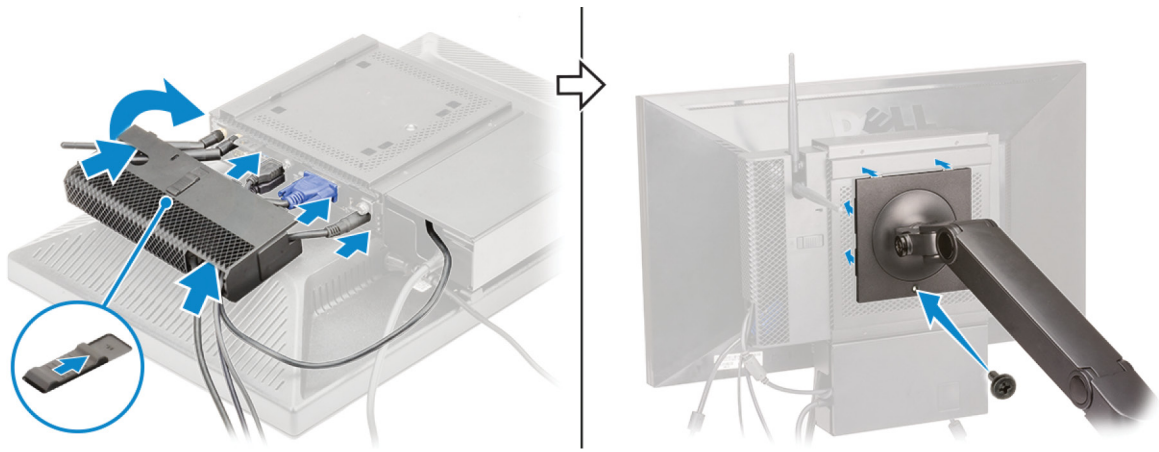

Figure 24. Attaching the cable cover and display stand

## Dual VESA mount display in vertical and horizontal orientation

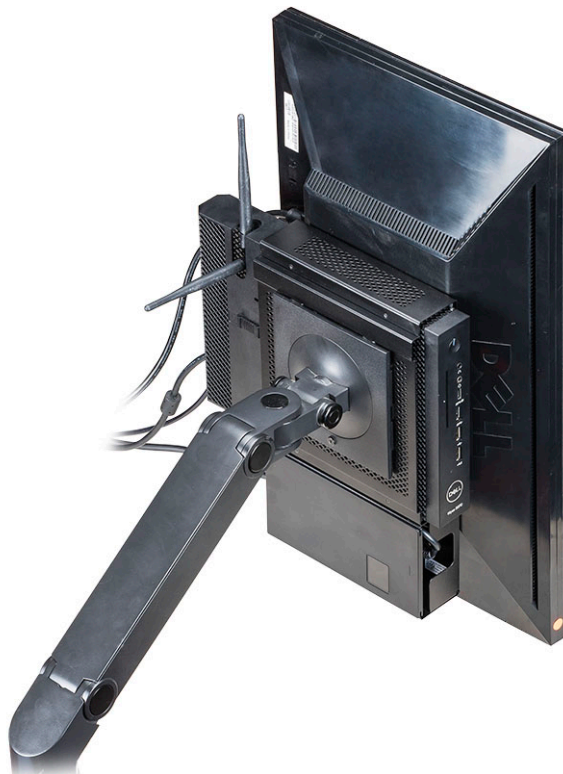
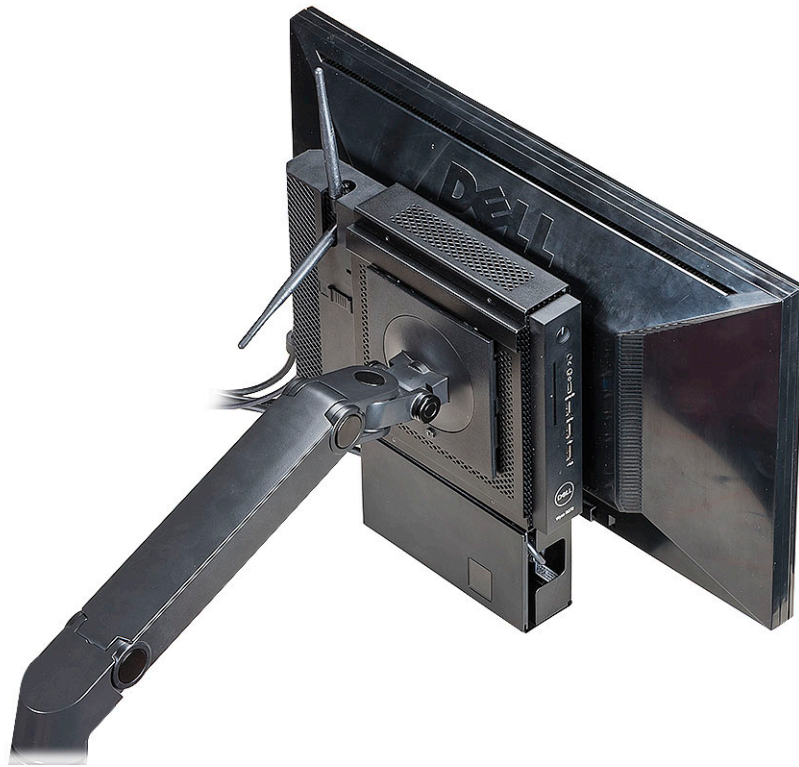

Figure 25. Display in vertical orientation



**Figure 26. Display in horizontal orientation**