

# Dell EMC PowerEdge R740xd

## Installation and Service Manual

## Notes, cautions, and warnings

 **NOTE:** A NOTE indicates important information that helps you make better use of your product.

 **CAUTION:** A CAUTION indicates either potential damage to hardware or loss of data and tells you how to avoid the problem.

 **WARNING:** A WARNING indicates a potential for property damage, personal injury, or death.

<b>Chapter 1: PowerEdge R740xd system overview</b>	<b>8</b>
Supported configurations	8
Front view of the system	10
Left control panel view	11
Right control panel view	14
Back view of the system	15
NIC indicator codes	17
Power supply unit indicator codes	17
Drive indicator codes	20
LCD panel	20
Viewing Home screen	21
Setup menu	21
View menu	22
Locating the Service Tag of your system	22
System information label	23
<b>Chapter 2: Documentation resources</b>	<b>26</b>
<b>Chapter 3: Initial system setup and configuration</b>	<b>28</b>
Setting up your system	28
iDRAC configuration	28
Options to set up iDRAC IP address	28
Log in to iDRAC	29
Options to install the operating system	29
Methods to download firmware and drivers	29
Downloading drivers and firmware	30
<b>Chapter 4: Installing and removing system components</b>	<b>31</b>
Safety instructions	31
Before working inside your system	32
After working inside your system	32
Recommended tools	32
Optional front bezel	33
Front bezel details	33
Removing the front bezel	33
Installing the front bezel	34
System cover	34
Removing the system cover	34
Installing the system cover	35
Backplane cover	36
Removing the backplane cover	36
Installing the backplane cover	37
Inside the system	38
Air shroud	41

Removing the air shroud.....	41
Installing the air shroud.....	41
Cooling fan assembly.....	42
Removing the cooling fan assembly.....	42
Installing the cooling fan assembly.....	43
Cooling fans.....	44
Cooling fan details.....	44
Removing a cooling fan.....	45
Installing a cooling fan.....	45
Intrusion switch.....	46
Removing an intrusion switch.....	46
Installing an intrusion switch.....	47
NVDIMM-N battery.....	48
NVDIMM-N battery details.....	48
Removing the NVDIMM-N battery from the air shroud.....	48
Installing NVDIMM-N battery into air shroud.....	49
Removing NVDIMM-N battery from mid drive tray.....	50
Installing NVDIMM-N battery into mid drive tray.....	51
Removing NVDIMM-N battery from the bracket.....	52
Installing NVDIMM-N battery into the bracket.....	53
Mid drive tray.....	54
Mid drive tray details.....	54
Removing mid drive tray.....	54
Installing the mid drive tray.....	55
Removing drive blank from drive carrier.....	56
Installing drive blank into the drive carrier.....	57
Removing drive carrier from the mid drive tray.....	58
Installing drive carrier into mid drive tray.....	59
Removing 3.5 inch drive from the drive carrier.....	60
Installing 3.5 inch drive into the drive carrier.....	61
Removing a 2.5 inch drive from the 3.5 inch mid drive carrier.....	62
Installing a 2.5 inch drive into the 3.5 inch mid drive carrier.....	63
Drives.....	64
Drive guidelines.....	64
Removing a drive blank.....	64
Installing a drive blank.....	65
Removing a drive carrier.....	66
Installing a drive carrier.....	66
Removing a 2.5 inch drive from the 3.5 inch drive adapter.....	67
Installing a 2.5 inch drive into the 3.5 inch drive adapter.....	68
Removing a 3.5 inch adapter from a 3.5 inch drive carrier.....	69
Installing a 3.5 inch adapter into a 3.5 inch drive carrier.....	70
Removing the drive from the drive carrier.....	71
Installing a drive into the drive carrier.....	72
Rear drive cage.....	73
Rear drive cage details.....	73
Removing rear drive cage.....	73
Installing rear drive cage.....	75
System memory.....	76
System memory guidelines.....	76

General memory module installation guidelines.....	77
NVDIMM-N memory module installation guidelines .....	78
PMem installation guidelines .....	81
Mode-specific guidelines.....	84
Removing a memory module.....	86
Installing a memory module.....	87
Processors and heat sinks.....	88
Removing a processor and heat sink module.....	88
Removing the processor from the processor and heat sink module.....	89
Installing the processor into a processor and heat sink module.....	90
Installing a processor and heat sink module.....	93
Expansion cards and expansion card risers.....	95
Expansion card installation guidelines.....	95
Opening and closing the PCIe card holder latch.....	101
Removing expansion card from the expansion card riser.....	103
Installing expansion card into the expansion card riser.....	105
Removing riser 2 and 3 blank.....	107
Installing riser 2 and 3 blank.....	108
Removing riser 3 blank.....	109
Installing riser 3 blank.....	110
Removing expansion card riser 1.....	111
Installing expansion card riser 1.....	112
Removing expansion card riser 2.....	113
Installing expansion card riser 2.....	114
Removing expansion card riser 3.....	116
Installing expansion card riser 3.....	116
GPU or ACLR card installation guidelines.....	117
Removing a GPU.....	118
Installing a GPU.....	120
M.2 SSD module.....	125
Removing the M.2 SSD module.....	125
Installing the M.2 SSD module.....	126
Optional MicroSD or vFlash card.....	127
Removing the MicroSD and vFlash card.....	127
Installing the MicroSD and vFlash card.....	128
Optional IDSDM or vFlash module.....	129
Removing the optional IDSDM or vFlash module.....	129
Installing optional IDSDM or vFlash module.....	130
Network daughter card.....	131
Removing the network daughter card.....	131
Installing the network daughter card.....	132
Integrated storage controller card.....	133
Removing integrated storage controller card.....	133
Installing integrated storage controller card.....	134
Backplane.....	135
Backplane details.....	135
Removing the backplane .....	138
Installing the backplane.....	139
Removing mid drive tray backplane.....	140
Installing mid drive tray backplane.....	141

Removing the 3.5 inch drive rear backplane.....	142
Installing the 3.5 inch drive rear backplane.....	142
Removing the 2.5 inch drive rear backplane.....	143
Installing the 2.5 inch drive rear backplane.....	144
Cable routing.....	145
System battery.....	160
Replacing the system battery.....	160
Optional internal USB memory key.....	161
Optional internal USB memory key details.....	161
Replacing the optional internal USB memory key.....	162
Power supply units.....	162
Power supply unit details.....	162
Hot spare feature.....	162
Removing a power supply unit blank.....	163
Installing a power supply unit blank.....	163
Removing a power supply unit.....	164
Installing a power supply unit.....	165
Wiring instructions for a DC power supply unit.....	165
System board.....	169
Removing system board.....	169
Installing system board.....	170
Trusted Platform Module.....	173
Upgrading the Trusted Platform Module.....	173
Initializing TPM for BitLocker users.....	174
Initializing the TPM 1.2 for TXT users.....	174
Initializing the TPM 2.0 for TXT users.....	174
Control panel.....	175
Control panel details.....	175
Removing the left control panel.....	175
Installing the left control panel.....	176
Removing the right control panel.....	177
Installing the right control panel.....	178
<b>Chapter 5: System diagnostics.....</b>	<b>180</b>
Dell Embedded System Diagnostics.....	180
Running the Embedded System Diagnostics from Boot Manager.....	180
Running the Embedded System Diagnostics from the Dell Lifecycle Controller.....	180
System diagnostic controls.....	180
<b>Chapter 6: Jumpers and connectors .....</b>	<b>182</b>
System board jumpers and connectors.....	182
System board jumper settings.....	184
Disabling forgotten password.....	184
<b>Chapter 7: Getting help.....</b>	<b>185</b>
Contacting Dell EMC.....	185
Documentation feedback.....	185
Accessing system information by using QRL.....	185
Quick Resource Locator for PowerEdge R740 and R740xd systems.....	186

Receiving automated support with SupportAssist .....	186
Recycling or End-of-Life service information.....	186

# PowerEdge R740xd system overview

The PowerEdge R740xd is a 2U rack server that supports up to:

- Two Intel Xeon Scalable Processors
- 24 DIMM slots
- Two AC or DC power supply units
- 32 SAS, SATA, Nearline SAS hard drives or SSDs, and up to 24 NVMe drives. For more information about supported drives, see the [www.dell.com/poweredgemanuals](http://www.dell.com/poweredgemanuals) section.

**NOTE:** All instances of SAS, SATA hard drives, NVMe and SSDs are referred to as drives in this document, unless specified otherwise.

**NOTE:** For more information, see the Dell EMC PowerEdge R740xd Technical Specifications on the product documentation page.

## Topics:

- [Supported configurations](#)
- [Front view of the system](#)
- [Back view of the system](#)
- [Drive indicator codes](#)
- [LCD panel](#)
- [Locating the Service Tag of your system](#)
- [System information label](#)

## Supported configurations

The PowerEdge R740xd system supports the following configurations:



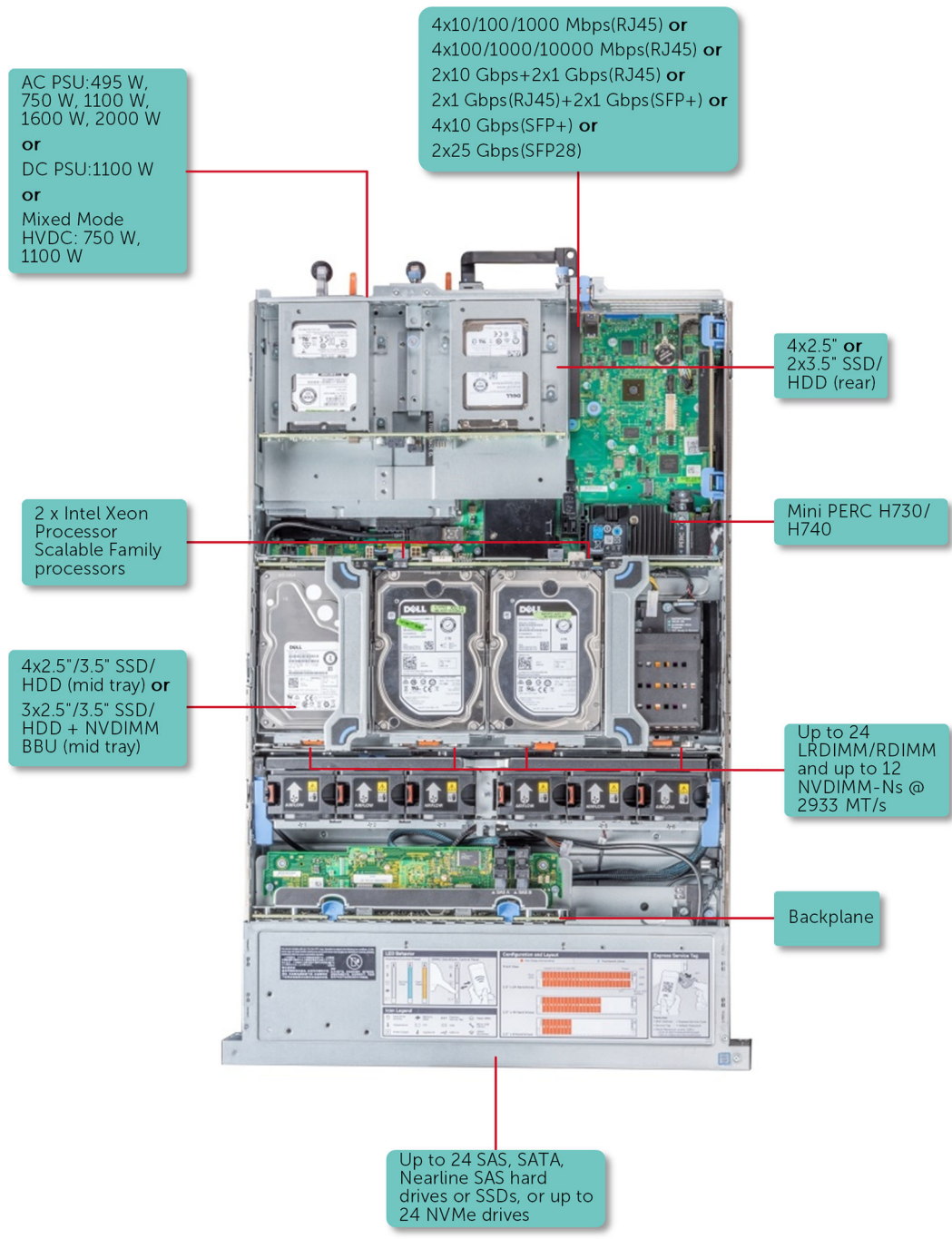


Figure 1. Supported configurations

# Front view of the system

The front view displays the features available on the front of the system.



Figure 2. Front view of 24 x 2.5 inch drive system

Table 1. Features available on the front of the 24 x 2.5 inch drive system

Item	Panels and slots	Icon	Description
1	Left control panel	N/A	Contains system health and system ID, status LED or optional iDRAC Quick Sync 2 (wireless).
2	Drive slots	N/A	Enable you to install drives that are supported on your system. For more information about drives, see the <a href="http://www.dell.com/poweredgemanuals">www.dell.com/poweredgemanuals</a> section.
3	Right control panel	N/A	Contains the power button, VGA port, iDRAC Direct micro USB port and two USB 2.0 ports.
4	Information tag	N/A	The Information tag is a slide-out label panel that contains system information such as Service Tag, NIC, MAC address, and so on. If you have opted for the secure default access to iDRAC, the Information tag also contains the iDRAC secure default password.



Figure 3. Front view of 12 x 3.5 inch drive system

Table 2. Features available on the front of the 12 x 3.5 inch drive system

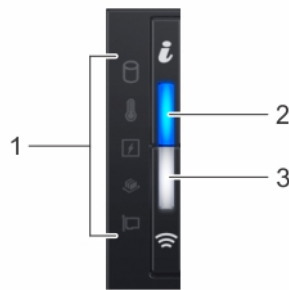
Item	Panels and slots	Icon	Description
1	Left control panel	N/A	Contains system health and system ID, status LED or optional iDRAC Quick Sync 2 (wireless).

**Table 2. Features available on the front of the 12 x 3.5 inch drive system (continued)**

Item	Panels and slots	Icon	Description
2	Drive slots	N/A	Enable you to install drives that are supported on your system. For more information about drives, see the <a href="http://www.dell.com/poweredgemanuals">www.dell.com/poweredgemanuals</a> section.
3	Right control panel	N/A	Contains the power button, VGA port, iDRAC Direct micro USB port and two USB 2.0 ports.
4	Information tag	N/A	The Information tag is a slide-out label panel that contains system information such as Service Tag, NIC, MAC address, and so on. If you have opted for the secure default access to iDRAC, the Information tag also contains the iDRAC secure default password.

**NOTE:** For more information, see the Dell EMC PowerEdge R740xd Technical Specifications on the product documentation page.

## Left control panel view



**Figure 4. Left control panel with optional iDRAC Quick Sync 2.0 indicator**






**Table 3. Left control panel**

Item	Indicator, button, or connector	Icon	Description
1	Status LED indicators	N/A	Indicate the status of the system. For more information, see the <a href="#">Status LED indicators</a> section.
2	System health and system ID indicator		Indicates the system health. For more information, see the <a href="#">System health and system ID indicator codes</a> section.
3	iDRAC Quick Sync 2 wireless indicator (optional)		Indicates if the iDRAC Quick Sync 2 wireless option is activated. The Quick Sync 2 feature allows management of the system using mobile devices. This feature aggregates hardware/firmware inventory and various system level diagnostic/error information that can be used in troubleshooting the system. You can access system inventory, Dell Lifecycle Controller logs or system logs, system health status, and also configure iDRAC, BIOS, and networking parameters. You can also launch the virtual Keyboard, Video, and Mouse (KVM) viewer and virtual Kernel based Virtual Machine (KVM), on a supported mobile device. For more information, see the Integrated Dell Remote Access Controller User's Guide at <a href="http://www.dell.com/poweredgemanuals">www.dell.com/poweredgemanuals</a> .

## Status LED indicators

**NOTE:** The indicators display solid amber if any error occurs.

**Table 4. Status LED indicators and descriptions**

Icon	Description	Condition	Corrective action
	Drive indicator	The indicator turns solid amber if there is a drive error.	<ul style="list-style-type: none"> <li>Check the System Event Log to determine if the drive has an error.</li> <li>Run the appropriate Online Diagnostics test. Restart the system and run embedded diagnostics (ePSA).</li> <li>If the drives are configured in a RAID array, restart the system, and enter the host adapter configuration utility program.</li> </ul>
	Temperature indicator	The indicator turns solid amber if the system experiences a thermal error (for example, the ambient temperature is out of range or there is a fan failure).	<p>Ensure that none of the following conditions exist:</p> <ul style="list-style-type: none"> <li>A cooling fan has been removed or has failed.</li> <li>System cover, air shroud, memory module blank, or back filler bracket is removed.</li> <li>Ambient temperature is too high.</li> <li>External airflow is obstructed.</li> </ul> <p>If the problem persists, see <a href="#">Getting help</a>.</p>
	Electrical indicator	The indicator turns solid amber if the system experiences an electrical error (for example, voltage out of range, or a failed power supply unit (PSU) or voltage regulator).	<p>Check the System Event Log or system messages for the specific issue. If it is due to a problem with the PSU, check the LED on the PSU. Reseat the PSU.</p> <p>If the problem persists, see <a href="#">Getting help</a>.</p>
	Memory indicator	The indicator turns solid amber if a memory error occurs.	<p>Check the System Event Log or system messages for the location of the failed memory. Reseat the memory module.</p> <p>If the problem persists, see <a href="#">Getting help</a>.</p>
	PCIe indicator	The indicator turns solid amber if a PCIe card experiences an error.	<p>Restart the system. Update any required drivers for the PCIe card. Reinstall the card.</p> <p>If the problem persists, see <a href="#">Getting help</a>.</p> <p><b>i</b> <b>NOTE:</b> For more information about the supported PCIe cards, see <a href="#">Expansion card installation guidelines</a>.</p>

## System health and system ID indicator codes

The system health and system ID indicator is located on the left control panel of your system.



**Figure 5. System health and system ID indicators**

**Table 5. System health and system ID indicator codes**

System health and system ID indicator code	Condition
Solid blue	Indicates that the system is turned on, system is healthy, and system ID mode is not active. Press the system health and system ID button to switch to system ID mode.
Blinking blue	Indicates that the system ID mode is active. Press the system health and system ID button to switch to system health mode.
Solid amber	Indicates that the system is in fail-safe mode. If the problem persists, see the <a href="#">Getting help</a> section.

**Table 5. System health and system ID indicator codes (continued)**

<b>System health and system ID indicator code</b>	<b>Condition</b>
Blinking amber	Indicates that the system is experiencing a fault. Check the System Event Log or the LCD panel, if available on the bezel, for specific error messages.  For more information about error messages, see the <i>Event and Error Message Reference Guide for 14th Generation Dell EMC PowerEdge Servers</i> at <a href="http://www.dell.com/qrl">www.dell.com/qrl</a> .

## iDRAC Quick Sync 2 indicator codes

iDRAC Quick Sync 2 module (optional) is located on the left control panel of your system.



**Figure 6. iDRAC Quick Sync 2 indicators**

**Table 6. iDRAC Quick Sync 2 indicators and descriptions**

<b>iDRAC Quick Sync 2 indicator code</b>	<b>Condition</b>	<b>Corrective action</b>
Off (default state)	Indicates that the iDRAC Quick Sync 2 feature is turned off. Press the iDRAC Quick Sync 2 button to turn on the iDRAC Quick Sync 2 feature.	If the LED fails to turn on, reseal the left control panel flex cable and check. If the problem persists, see <a href="#">Getting help</a> .
Solid white	Indicates that iDRAC Quick Sync 2 is ready to communicate. Press the iDRAC Quick Sync 2 button to turn off.	If the LED fails to turn off, restart the system. If the problem persists, see <a href="#">Getting help</a> .
Blinks white rapidly	Indicates data transfer activity.	If the indicator continues to blink indefinitely, see <a href="#">Getting help</a> .
Blinks white slowly	Indicates that firmware update is in progress.	If the indicator continues to blink indefinitely, see <a href="#">Getting help</a> .
Blinks white five times rapidly and then turns off	Indicates that the iDRAC Quick Sync 2 feature is disabled.	Check if iDRAC Quick Sync 2 feature is configured to be disabled by iDRAC. If the problem persists, see the <a href="#">Getting help</a> section. For more information, see <i>Integrated Dell Remote Access Controller User's Guide</i> at <a href="http://www.dell.com/poweredgemanuals">www.dell.com/poweredgemanuals</a> or <i>Dell OpenManage Server Administrator User's Guide</i> at <a href="http://www.dell.com/openmanagemanuals">www.dell.com/openmanagemanuals</a> > OpenManage Server Administrator.
Solid amber	Indicates that the system is in fail-safe mode.	Restart the system. If the problem persists, see <a href="#">Getting help</a> .
Blinking amber	Indicates that the iDRAC Quick Sync 2 hardware is not responding properly.	Restart the system. If the problem persists, see <a href="#">Getting help</a> .

## Right control panel view

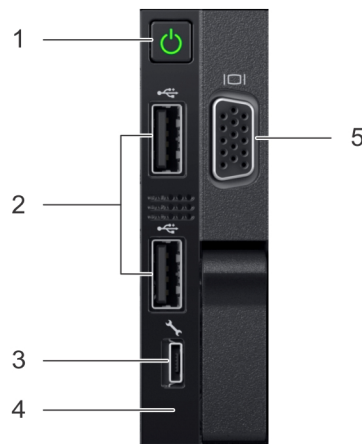






Figure 7. Right control panel view

Table 7. Right control panel features

Item	Indicator, button, or connector	Icon	Description
1	Power button		Indicates if the system is turned on or off. Press the power button to manually turn on or off the system. <b>NOTE:</b> Press the power button to gracefully shut down an ACPI-compliant operating system.
2	USB port (2)		The USB ports are 4-pin, 2.0-compliant. These ports enable you to connect USB devices to the system.
3	iDRAC Direct port		The iDRAC Direct port is micro USB 2.0-compliant. This port enables you to access the iDRAC Direct features. For more information, see the iDRAC User's Guide at <a href="http://www.dell.com/poweredgemanuals">www.dell.com/poweredgemanuals</a> .
4	iDRAC Direct LED	N/A	The iDRAC Direct LED indicator lights up to indicate that the iDRAC Direct port is connected. For more information, see <a href="#">the iDRAC Direct LED indicator codes</a> section.
5	VGA port		Enables you to connect a display device to the system. For more information, see the <a href="http://www.dell.com/poweredgemanuals">www.dell.com/poweredgemanuals</a> section.

## iDRAC Direct LED indicator codes

The iDRAC Direct LED indicator lights up to indicate that the port is connected and is being used as a part of the iDRAC subsystem.

iDRAC Direct LED indicator is located below the iDRAC Direct port on the right control panel.

You can configure iDRAC Direct by using a USB to micro USB (type AB) cable, which you can connect to your laptop or tablet. The following table describes iDRAC Direct activity when the iDRAC Direct port is active:

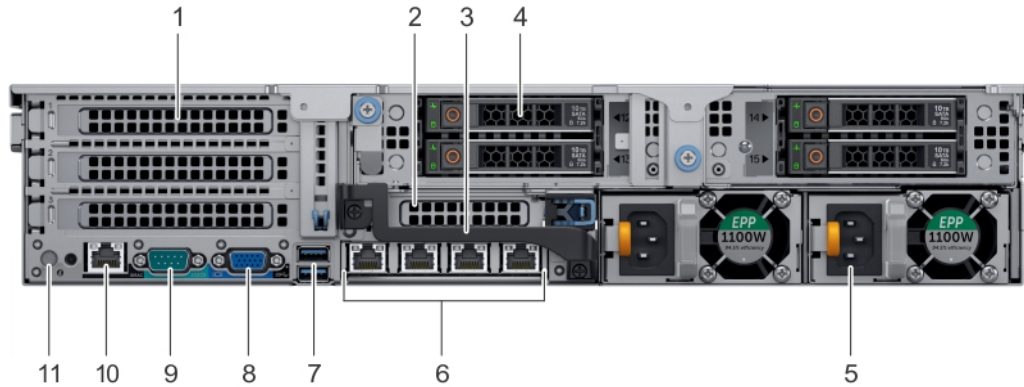
Table 8. iDRAC Direct LED indicator codes

iDRAC Direct LED indicator code	Condition
Solid green for two seconds	Indicates that the laptop or tablet is connected.
Flashing green (on for two seconds and off for two seconds)	Indicates that the laptop or tablet connected is recognized.

**Table 8. iDRAC Direct LED indicator codes (continued)**







iDRAC Direct LED indicator code	Condition
Turns off	Indicates that the laptop or tablet is unplugged.

## Back view of the system



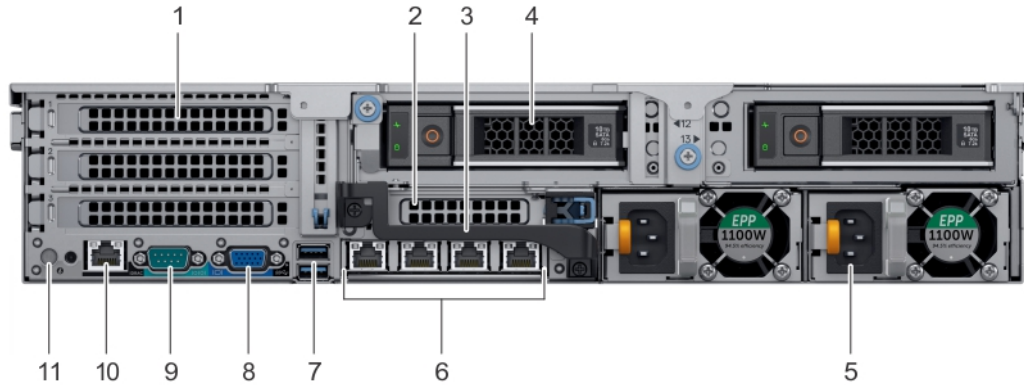
**Figure 8. Back view of 4 x 2.5 inch drive system**

**Table 9. Features available on the back view of 4 x 2.5 inch drive system**

Item	Panels, ports and slots	Icon	Description
1	Full-height PCIe expansion card slot (3)	N/A	The PCIe expansion card slot (riser 1) connects up to three full-height PCIe expansion cards to the system. For more information, see the <a href="#">Expansion card installation guidelines</a> section.
2	Half-height PCIe expansion card slot	N/A	The PCIe expansion card slot (riser 2) connects one half-height PCIe expansion cards to the system. For more information, see the <a href="#">Expansion card installation guidelines</a> section.
3	Rear handle	N/A	The rear handle can be removed to enable any external cabling of PCIe cards that are installed in the PCIe expansion card slot 6.
4	Drive slots	N/A	Enable you to install drives that are supported on your system. For more information about drives, see the <a href="http://www.dell.com/poweredgemanuals">www.dell.com/poweredgemanuals</a> section.
5	Power supply unit (2)	N/A	For more information, see the <a href="http://www.dell.com/poweredgemanuals">www.dell.com/poweredgemanuals</a> section.
6	NIC ports		The NIC ports that are integrated on the network daughter card (NDC) provide network connectivity. For more information about the supported configurations, see the <a href="http://www.dell.com/poweredgemanuals">www.dell.com/poweredgemanuals</a> section.
7	USB port (2)		The USB ports are 9-pin and 3.0-compliant. These ports enable you to connect USB devices to the system.
8	VGA port		Enables you to connect a display device to the system. For more information, see the <a href="http://www.dell.com/poweredgemanuals">www.dell.com/poweredgemanuals</a> section.
9	Serial port		Enables you to connect a serial device to the system. For more information, see the <a href="http://www.dell.com/poweredgemanuals">www.dell.com/poweredgemanuals</a> section.
10	iDRAC9 dedicated port		Enables you to remotely access iDRAC. For more information, see the iDRAC User's Guide at <a href="http://www.dell.com/poweredgemanuals">www.dell.com/poweredgemanuals</a> .
11	System identification button		The System Identification (ID) button is available on the front and back of the systems. Press the button to identify a system in a rack.







**Table 9. Features available on the back view of 4 x 2.5 inch drive system (continued)**

Item	Panels, ports and slots	Icon	Description
			by turning on the system ID button. You can also use the system ID button to reset iDRAC and to access BIOS using the step through mode.



**Figure 9. Back view of 2 x 3.5 inch drive system**

**Table 10. Features available on the back view of 2 x 3.5 inch drive system**

Item	Panels, ports and slots	Icon	Description
1	Full-height PCIe expansion card slot (3)	N/A	The PCIe expansion card slot (riser 1) connects up to three full-height PCIe expansion cards to the system. For more information, see the <a href="#">Expansion card installation guidelines</a> section.
2	Half-height PCIe expansion card slot	N/A	The PCIe expansion card slot (riser 2) connects one half-height PCIe expansion cards to the system. For more information, see the <a href="#">Expansion card installation guidelines</a> section.
3	Rear handle	N/A	The rear handle can be removed to enable any external cabling of PCIe cards that are installed in the PCIe expansion card slot 6.
4	Drive slots	N/A	Enable you to install drives that are supported on your system. For more information about drives, see the <a href="http://www.dell.com/poweredgemanuals">www.dell.com/poweredgemanuals</a> section.
5	Power supply unit (2)	N/A	For more information, see the <a href="http://www.dell.com/poweredgemanuals">www.dell.com/poweredgemanuals</a> section.
6	NIC ports		The NIC ports that are integrated on the network daughter card (NDC) provide network connectivity. For more information about the supported configurations, see the <a href="http://www.dell.com/poweredgemanuals">www.dell.com/poweredgemanuals</a> section.
7	USB port (2)		The USB ports are 9-pin and 3.0-compliant. These ports enable you to connect USB devices to the system.
8	VGA port		Enables you to connect a display device to the system. For more information, see the <a href="http://www.dell.com/poweredgemanuals">www.dell.com/poweredgemanuals</a> section.
9	Serial port		Enables you to connect a serial device to the system. For more information, see the <a href="http://www.dell.com/poweredgemanuals">www.dell.com/poweredgemanuals</a> section.
10	iDRAC9 dedicated port		Enables you to remotely access iDRAC. For more information, see the iDRAC User's Guide at <a href="http://www.dell.com/poweredgemanuals">www.dell.com/poweredgemanuals</a> .
11	System identification button		The System Identification (ID) button is available on the front and back of the systems. Press the button to identify a system in a rack by turning on the system ID button. You can also use the system ID



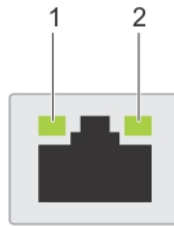
**Table 10. Features available on the back view of 2 x 3.5 inch drive system (continued)**

Item	Panels, ports and slots	Icon	Description
			button to reset iDRAC and to access BIOS using the step through mode.

**NOTE:** For more information, see the Dell EMC PowerEdge R740xd Technical Specifications on the product documentation page.

## NIC indicator codes

Each NIC on the back of the system has indicators that provide information about the activity and link status. The activity LED indicator indicates if data is flowing through the NIC, and the link LED indicator indicates the speed of the connected network.



**Figure 10. NIC indicator codes**

1. link LED indicator
2. activity LED indicator

**Table 11. NIC indicator codes**

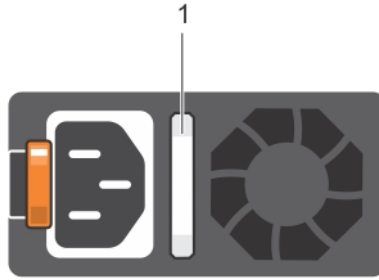
Status	Condition
Link and activity indicators are off	The NIC is not connected to the network.
Link indicator is green and activity indicator is blinking green	The NIC is connected to a valid network at its maximum port speed and data is being sent or received.
Link indicator is amber and activity indicator is blinking green	The NIC is connected to a valid network at less than its maximum port speed and data is being sent or received.
Link indicator is green and activity indicator is off	The NIC is connected to a valid network at its maximum port speed and data is not being sent or received.
Link indicator is amber and activity indicator is off	The NIC is connected to a valid network at less than its maximum port speed and data is not being sent or received.
Link indicator is blinking green and activity is off	NIC identify is enabled through the NIC configuration utility.

## Power supply unit indicator codes

AC power supply units (PSUs) have an illuminated translucent handle that serves as an indicator.

The DC PSUs have an LED that serves as an indicator.

The indicator shows whether power is present or if a power fault has occurred.

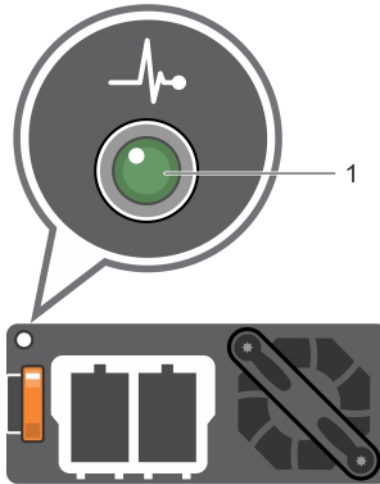


**Figure 11. AC PSU status indicator**

1. AC PSU status indicator/handle

**Table 12. AC PSU status indicator codes**

Power indicator codes	Condition
Green	A valid power source is connected to the PSU and the PSU is operational.
Blinking amber	Indicates a problem with the PSU.
Not illuminated	Power is not connected to the PSU.
Blinking green	When the firmware of the PSU is being updated, the PSU handle blinks green. <b>⚠ CAUTION: Do not disconnect the power cord or unplug the PSU when updating firmware. If firmware update is interrupted, the PSUs do not function.</b>
Blinking green and turns off	When hot-plugging a PSU, the PSU handle blinks green five times at a rate of 4 Hz and turns off. This indicates a PSU mismatch with respect to efficiency, feature set, health status, or supported voltage. <b>⚠ CAUTION: If two PSUs are installed, both the PSUs must have the same type of label; for example, Extended Power Performance (EPP) label. Mixing PSUs from previous generations of PowerEdge servers is not supported, even if the PSUs have the same power rating. This results in a PSU mismatch condition or failure to turn the system on.</b> <b>⚠ CAUTION: When correcting a PSU mismatch, replace only the PSU with the blinking indicator. Swapping the PSU to make a matched pair can result in an error condition and unexpected system shutdown. To change from a high output configuration to a low output configuration or vice versa, you must turn off the system.</b> <b>⚠ CAUTION: AC PSUs support both 240 V and 120 V input voltages with the exception of Titanium PSUs, which support only 240 V. When two identical PSUs receive different input voltages, they can output different wattages, and trigger a mismatch.</b> <b>⚠ CAUTION: If two PSUs are used, they must be of the same type and have the same maximum output power.</b> <b>⚠ CAUTION: Combining AC and DC PSUs is not supported and triggers a mismatch.</b>



**Figure 12. DC PSU status indicator**

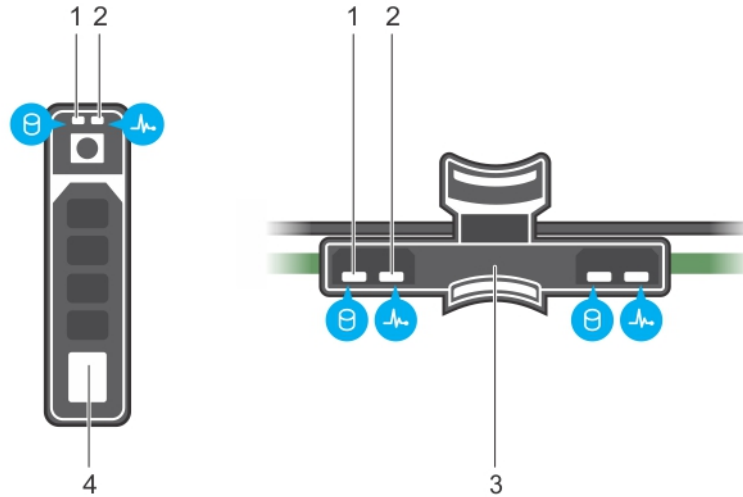
1. DC PSU status indicator

**Table 13. DC PSU status indicator codes**

<b>Power indicator codes</b>	<b>Condition</b>
Green	A valid power source is connected to the PSU and the PSU is operational.
Blinking amber	Indicates a problem with the PSU.
Not illuminated	Power is not connected to the PSU.
Blinking green	<p>When hot-plugging a PSU, the PSU indicator blinks green. This indicates that there is a PSU mismatch with respect to efficiency, feature set, health status, or supported voltage.</p> <p><b>⚠ CAUTION: If two PSUs are installed, both the PSUs must have the same type of label; for example, Extended Power Performance (EPP) label. Mixing PSUs from previous generations of PowerEdge servers is not supported, even if the PSUs have the same power rating. This results in a PSU mismatch condition or failure to turn the system on.</b></p> <p><b>⚠ CAUTION: When correcting a PSU mismatch, replace only the PSU with the blinking indicator. Swapping the PSU to make a matched pair can result in an error condition and unexpected system shutdown. To change from a High Output configuration to a Low Output configuration or vice versa, you must turn off the system.</b></p> <p><b>⚠ CAUTION: If two PSUs are used, they must be of the same type and have the same maximum output power.</b></p> <p><b>⚠ CAUTION: Combining AC and DC PSUs is not supported and triggers a mismatch.</b></p>

# Drive indicator codes

Each drive carrier has an activity LED indicator and a status LED indicator. The indicators provide information about the current status of the drive. The activity LED indicator indicates whether the drive is currently in use or not. The status LED indicator indicates the power condition of the drive.



**Figure 13. Drive indicators on the drive and the mid drive tray backplane**

- 1. drive activity LED indicator
- 2. drive status LED indicator
- 3. drive backplane on mid drive tray
- 4. drive

**NOTE:** If the drive is in the Advanced Host Controller Interface (AHCI) mode, the status LED indicator does not turn on.

**Table 14. Drive indicator codes**

Drive status indicator code	Condition
Flashes green twice per second	Identifying drive or preparing for removal.
Off	Drive ready for removal. <b>NOTE:</b> The drive status indicator remains off until all drives are initialized after the system is turned on. Drives are not ready for removal during this time.
Flashes green, amber, and then turns off	Predicted drive failure.
Flashes amber four times per second	Drive failed.
Flashes green slowly	Drive rebuilding.
Solid green	Drive online.
Flashes green for three seconds, amber for three seconds, and then turns off after six seconds	Rebuild stopped.

## LCD panel

The LCD panel provides system information, status, and error messages to indicate if the system is functioning correctly or requires attention. The LCD panel can also be used to configure or view the system's iDRAC IP address. For information about the event and error messages generated by the system firmware and agents that monitor system components, go to [qrl.dell.com](http://qrl.dell.com) > **Look Up** > **Error Code**, type the error code, and then click **Look it up**.

The LCD panel is available only on the optional front bezel. The optional front bezel is hot pluggable.

The statuses and conditions of the LCD panel are outlined here:

- The LCD backlight is white during normal operating conditions.
- When the system needs attention, the LCD backlight turns amber, and displays an error code followed by descriptive text.
- **NOTE:** If the system is connected to a power source and an error is detected, the LCD turns amber regardless of whether the system is turned on or off.
- When the system turns off and there are no errors, LCD enters the standby mode after five minutes of inactivity. Press any button on the LCD to turn it on.
- If the LCD panel stops responding, remove the bezel and reinstall it. If the problem persists, see the PowerEdge T640 Technical Specs at [www.dell.com/poweredgemanuals](http://www.dell.com/poweredgemanuals)
- The LCD backlight remains off if LCD messaging is turned off using the iDRAC utility, the LCD panel, or other tools.

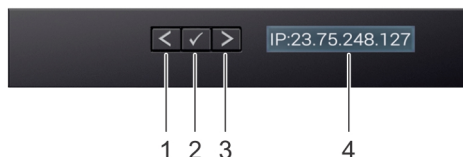


Figure 14. LCD panel features




Table 15. LCD panel features

Item	Button or display	Description
1	Left	Moves the cursor back in one-step increments.
2	Select	Selects the menu item highlighted by the cursor.
3	Right	Moves the cursor forward in one-step increments.  During message scrolling: <ul style="list-style-type: none"> <li>• Press and hold the right button to increase scrolling speed.</li> <li>• Release the button to stop.</li> </ul> <b>NOTE:</b> The display stops scrolling when the button is released. After 45 seconds of inactivity, the display starts scrolling.
4	LCD display	Displays system information, status, and error messages or iDRAC IP address.

## Viewing Home screen

The **Home** screen displays user-configurable information about the system. This screen is displayed during normal system operation when there are no status messages or errors. When the system turns off and there are no errors, LCD enters the standby mode after five minutes of inactivity. Press any button on the LCD to turn it on.

### Steps

1. To view the **Home** screen, press one of the three navigation buttons (Select, Left, or Right).
2. To navigate to the **Home** screen from another menu, complete the following steps:
  - a. Press and hold the navigation button till the up arrow  is displayed.
  - b. Navigate to the **Home** icon  using the up arrow .
  - c. Select the **Home** icon.
  - d. On the **Home** screen, press the **Select** button to enter the main menu.

## Setup menu

- **NOTE:** When you select an option in the Setup menu, you must confirm the option before proceeding to the next action.

Option	Description
<b>iDRAC</b>	Select <b>DHCP</b> or <b>Static IP</b> to configure the network mode. If <b>Static IP</b> is selected, the available fields are <b>IP</b> , <b>Subnet (Sub)</b> , and <b>Gateway (Gtw)</b> . Select <b>Setup DNS</b> to enable DNS and to view domain addresses. Two separate DNS entries are available.
<b>Set error</b>	Select <b>SEL</b> to view LCD error messages in a format that matches the IPMI description in the SEL. This enables you to match an LCD message with an SEL entry.  Select <b>Simple</b> to view LCD error messages in a simplified user-friendly description.  For more information about error messages, see the <i>Event and Error Message Reference Guide for 14th Generation Dell EMC PowerEdge Servers</i> at <a href="http://www.dell.com/qrl">www.dell.com/qrl</a> .
<b>Set home</b>	Select the default information to be displayed on the <b>Home</b> screen. See View menu section for the options and option items that can be set as the default on the <b>Home</b> screen.

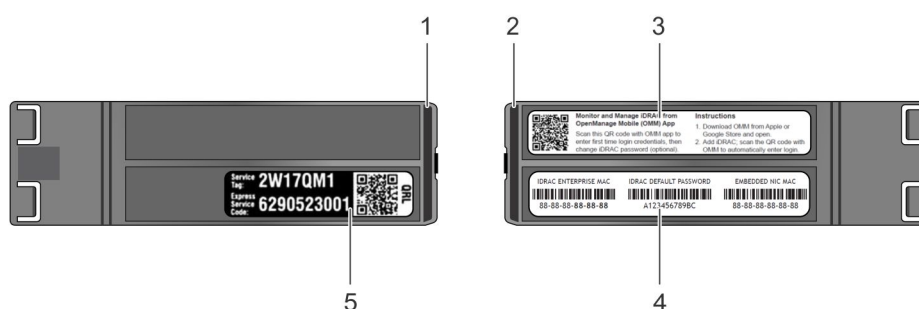
## View menu

**i** | **NOTE:** When you select an option in the View menu, you must confirm the option before proceeding to the next action.

Option	Description
<b>iDRAC IP</b>	Displays the <b>IPv4</b> or <b>IPv6</b> addresses for iDRAC9. Addresses include <b>DNS (Primary and Secondary)</b> , <b>Gateway</b> , <b>IP</b> , and <b>Subnet</b> (IPv6 does not have Subnet).
<b>MAC</b>	Displays the MAC addresses for <b>iDRAC</b> , <b>iSCSI</b> , or <b>Network</b> devices.
<b>Name</b>	Displays the name of the <b>Host</b> , <b>Model</b> , or <b>User String</b> for the system.
<b>Number</b>	Displays the <b>Asset tag</b> or the <b>Service tag</b> for the system.
<b>Power</b>	Displays the power output of the system in BTU/hr or Watts. The display format can be configured in the <b>Set home</b> submenu of the <b>Setup</b> menu.
<b>Temperature</b>	Displays the temperature of the system in Celsius or Fahrenheit. The display format can be configured in the <b>Set home</b> submenu of the <b>Setup</b> menu.

## Locating the Service Tag of your system

You can identify your system using the unique Express Service Code and Service Tag. Pull out the information tag in front of the system to view the Express Service Code and Service Tag. Alternatively, the information may be on a sticker on the chassis of the system. The mini Enterprise Service Tag (EST) is found on the back of the system. This information is used by Dell to route support calls to the appropriate personnel.



**Figure 15. Locating Service Tag of your system**

1. information tag (top view)
2. information tag (back view)
3. OpenManage Mobile (OMM) label
4. iDRAC MAC address and iDRAC secure password label
5. Service Tag

# System information label

## PowerEdge R740xd – Front system information label

LED behavior, express service tag, hard drives configuration and layout

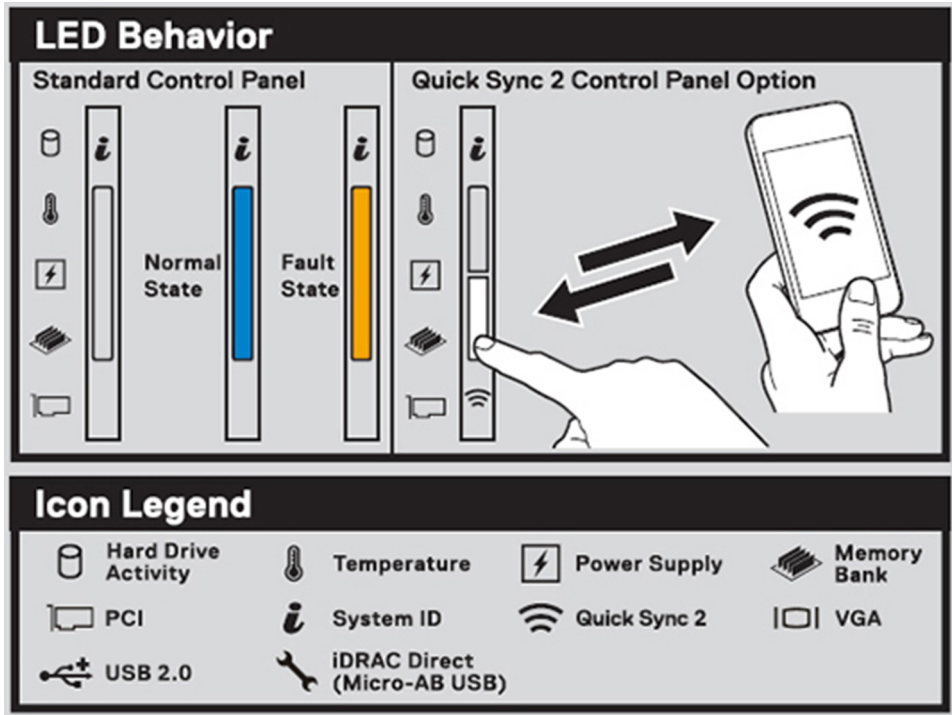


Figure 16. LED behavior

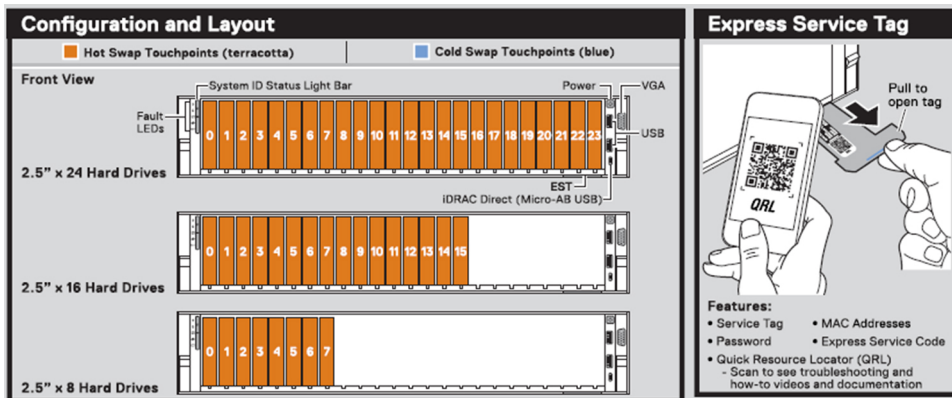


Figure 17. 2.5 inch hard drives configuration and layout



Figure 18. 3.5 inch hard drives configuration and layout

## PowerEdge R740xd – Service information

System touchpoint, electrical overview, mechanical overview and rear view configurations

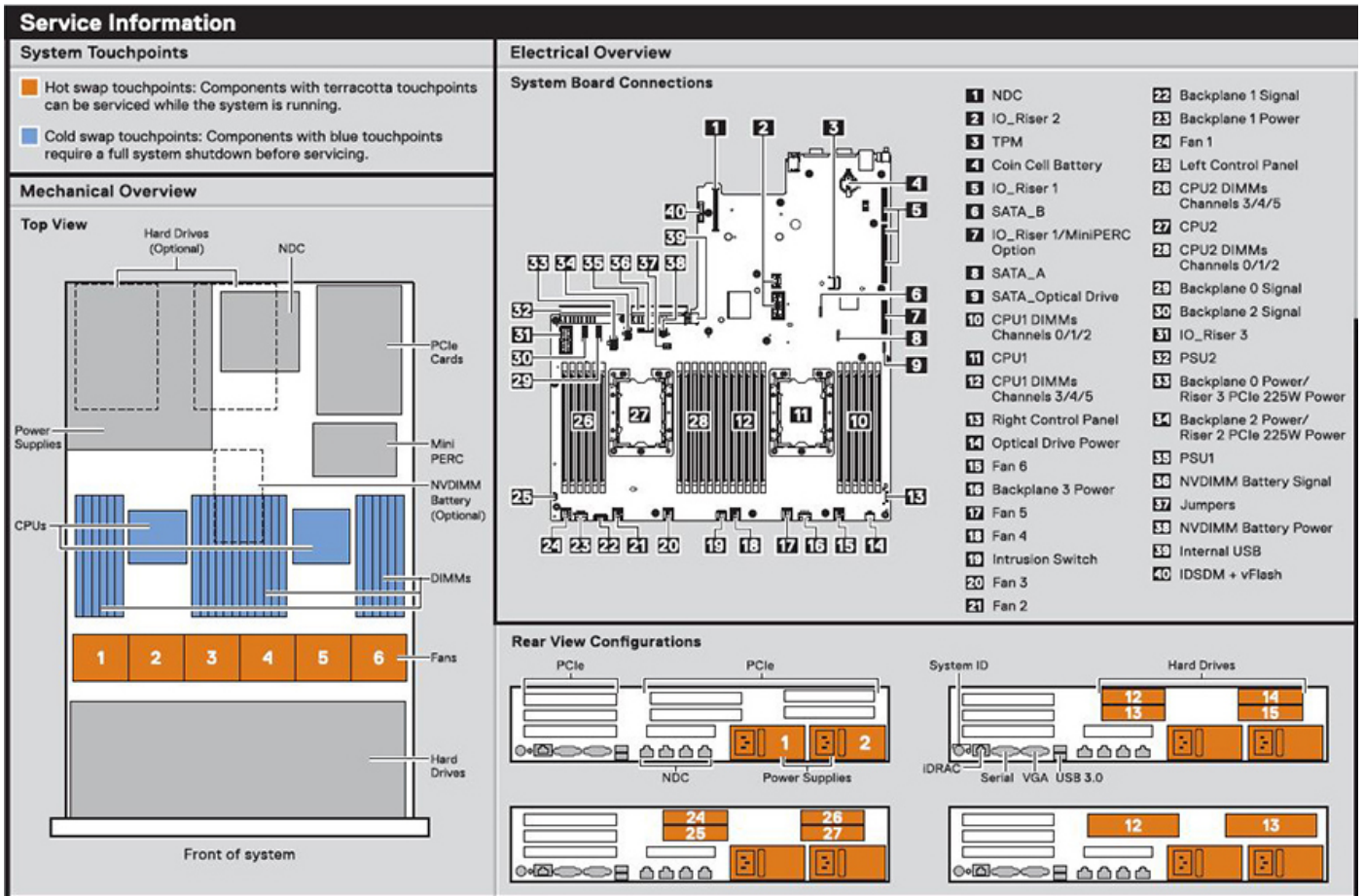


Figure 19. Service Information

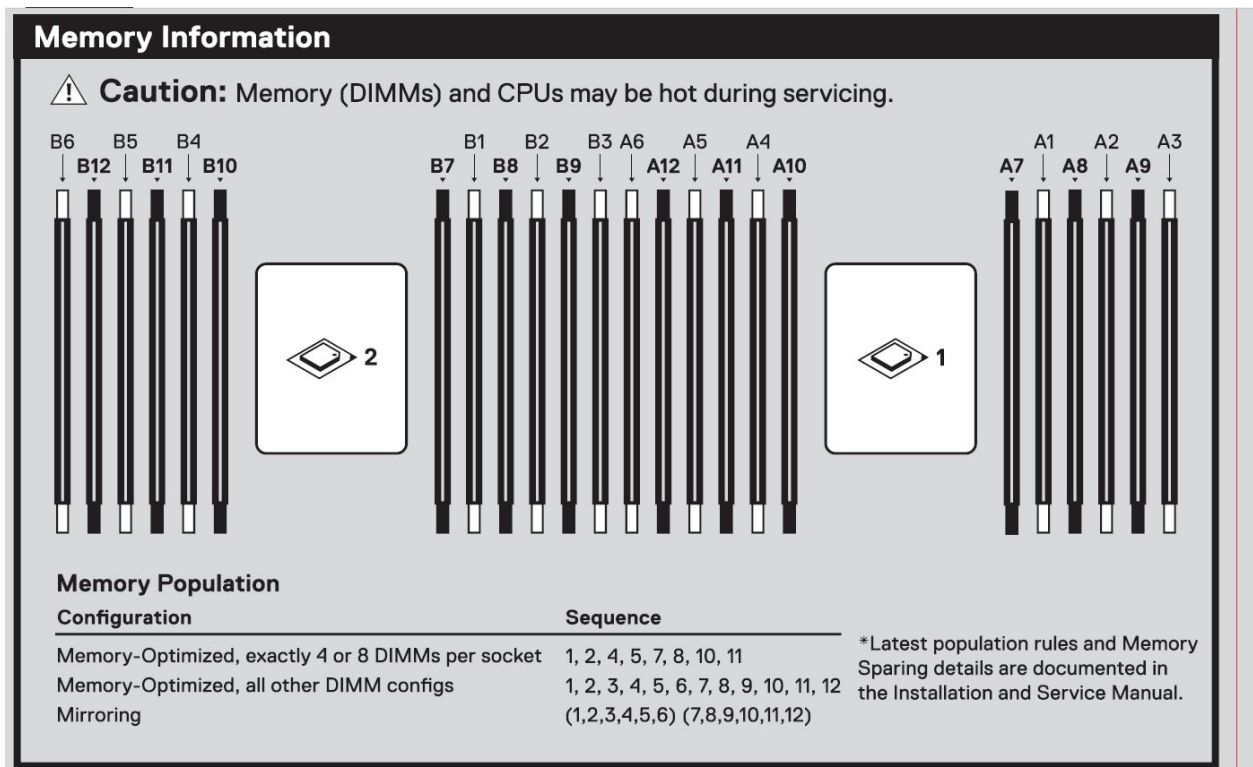


Figure 20. Jumper setting and memory information



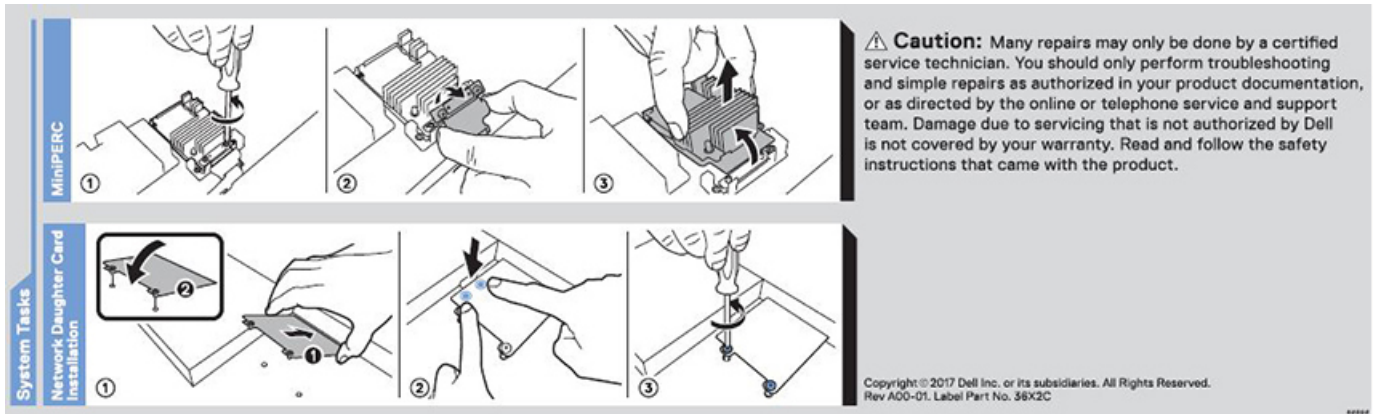


Figure 21. system task

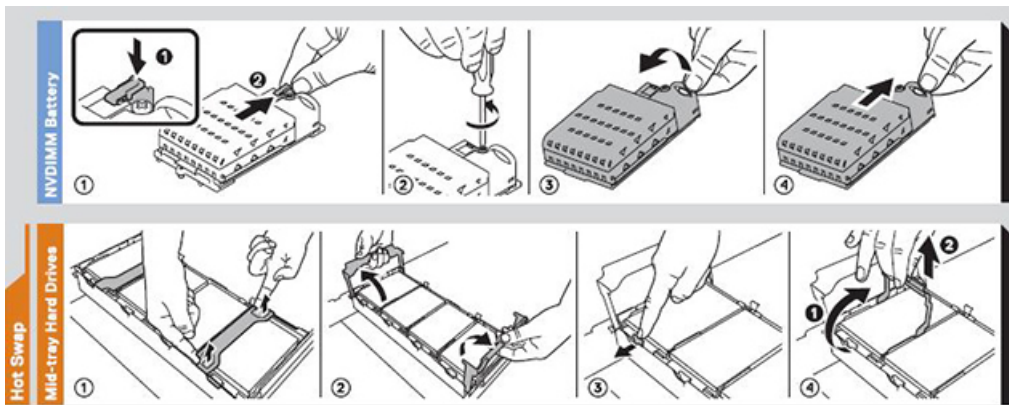



Figure 22. NVDIMM battery and mid-tray hard drives

## Documentation resources

This section provides information about the documentation resources for your system.

To view the document that is listed in the documentation resources table:

- From the Dell EMC support site:
  1. Click the documentation link that is provided in the Location column in the table.
  2. Click the required product or product version.
-  **NOTE:** To locate the product name and model, see the front of your system.
- 3. On the Product Support page, click **Manuals & documents**.
- Using search engines:
  - Type the name and version of the document in the search box.

**Table 16. Documentation resources**

Task	Document	Location
Setting up your system	<p>For more information about installing and securing the system into a rack, see the Rail Installation Guide included with your rack solution.</p> <p>For information about setting up your system, see the <i>Getting Started Guide</i> document that is shipped with your system.</p>	<a href="https://www.dell.com/poweredgemanuals">https://www.dell.com/poweredgemanuals</a>
Configuring your system	<p>For information about the iDRAC features, configuring and logging in to iDRAC, and managing your system remotely, see the Integrated Dell Remote Access Controller User's Guide.</p> <p>For information about understanding Remote Access Controller Admin (RACADM) subcommands and supported RACADM interfaces, see the RACADM CLI Guide for iDRAC.</p> <p>For information about Redfish and its protocol, supported schema, and Redfish Eventing implemented in iDRAC, see the Redfish API Guide.</p> <p>For information about iDRAC property database group and object descriptions, see the Attribute Registry Guide.</p> <p>For information about Intel QuickAssist Technology, see the Integrated Dell Remote Access Controller User's Guide.</p>	<a href="https://www.dell.com/poweredgemanuals">https://www.dell.com/poweredgemanuals</a>
	<p>For information about earlier versions of the iDRAC documents.</p> <p>To identify the version of iDRAC available on your system, on the iDRAC web interface, click <b>? &gt; About</b>.</p>	<a href="https://www.dell.com/idracmanuals">https://www.dell.com/idracmanuals</a>
	For information about installing the operating system, see the operating system documentation.	<a href="https://www.dell.com/operatingsystemmanuals">https://www.dell.com/operatingsystemmanuals</a>

**Table 16. Documentation resources (continued)**

Task	Document	Location
	For information about updating drivers and firmware, see the Methods to download firmware and drivers section in this document.	<a href="http://www.dell.com/support/drivers">www.dell.com/support/drivers</a>
Managing your system	For information about system management software offered by Dell, see the Dell OpenManage Systems Management Overview Guide.	<a href="https://www.dell.com/poweredgemanuals">https://www.dell.com/poweredgemanuals</a>
	For information about setting up, using, and troubleshooting OpenManage, see the Dell OpenManage Server Administrator User's Guide.	<a href="http://www.dell.com/openmanagemanuals">www.dell.com/openmanagemanuals</a> > OpenManage Server Administrator
	For information about installing, using, and troubleshooting Dell OpenManage Enterprise, see the Dell OpenManage Enterprise User's Guide.	<a href="https://www.dell.com/openmanagemanuals">https://www.dell.com/openmanagemanuals</a>
	For information about installing and using Dell SupportAssist, see the Dell EMC SupportAssist Enterprise User's Guide.	<a href="https://www.dell.com/serviceabilitytools">https://www.dell.com/serviceabilitytools</a>
	For information about partner programs enterprise systems management, see the OpenManage Connections Enterprise Systems Management documents.	<a href="https://www.dell.com/openmanagemanuals">https://www.dell.com/openmanagemanuals</a>
Working with the Dell PowerEdge RAID controllers	For information about understanding the features of the Dell PowerEdge RAID controllers (PERC), Software RAID controllers, or BOSS card and deploying the cards, see the Storage controller documentation.	<a href="http://www.dell.com/storagecontrollermanuals">www.dell.com/storagecontrollermanuals</a>
Understanding event and error messages	For information about the event and error messages generated by the system firmware and agents that monitor system components, go to <a href="http://qrl.dell.com">qrl.dell.com</a> > <b>Look Up</b> > <b>Error Code</b> , type the error code, and then click <b>Look it up</b> .	<a href="http://www.dell.com/qrl">www.dell.com/qrl</a>
Troubleshooting your system	For information about identifying and troubleshooting the PowerEdge server issues, see the Server Troubleshooting Guide.	<a href="https://www.dell.com/poweredgemanuals">https://www.dell.com/poweredgemanuals</a>

# Initial system setup and configuration

## Topics:

- [Setting up your system](#)
- [iDRAC configuration](#)
- [Options to install the operating system](#)

## Setting up your system

Perform the following steps to set up your system:

### Steps

1. Unpack the system.
2. Install the system into the rack. For more information about installing the system into the rack, see the *Rail Installation Guide* at [www.dell.com/poweredgemanuals](http://www.dell.com/poweredgemanuals).
3. Connect the peripherals to the system.
4. Connect the system to its electrical outlet.
5. Power on the system by pressing the power button or by using iDRAC.
6. Power on the attached peripherals.

For more information about setting up your system, see the *Getting Started Guide* that shipped with your system.


For information on how to manage basic settings and features of the system, see the Dell EMC PowerEdge R740xd BIOS and UEFI Reference Guide on the product documentation page.

## iDRAC configuration

The Integrated Dell Remote Access Controller (iDRAC) is designed to make system administrators more productive and improve the overall availability of Dell systems. iDRAC alerts administrators about system issues and enables them to perform remote system management. This reduces the need for physical access to the system.

## Options to set up iDRAC IP address

To enable communication between your system and iDRAC, you must first configure the network settings based on your network infrastructure.

 **NOTE:** For static IP configuration, you must request for it at the time of purchase.

This option is set to **DHCP** by Default. You can set up the IP address by using one of the following interfaces:

Interfaces	Document/Section
<b>iDRAC Settings utility</b>	<i>Dell Integrated Dell Remote Access Controller User's Guide</i> at <a href="http://www.dell.com/poweredgemanuals">www.dell.com/poweredgemanuals</a>
<b>Dell Deployment Toolkit</b>	<i>Dell Deployment Toolkit User's Guide</i> at <a href="http://www.dell.com/openmanagemanuals">www.dell.com/openmanagemanuals</a> > OpenManage Deployment Toolkit
<b>Dell Lifecycle Controller</b>	<i>Dell Lifecycle Controller User's Guide</i> at <a href="http://www.dell.com/poweredgemanuals">www.dell.com/poweredgemanuals</a>
<b>Server LCD panel</b>	<a href="#">LCD panel</a> section

## Interfaces Document/Section

**iDRAC Direct and Quick Sync 2 (optional)** See *Dell Integrated Dell Remote Access Controller User's Guide* at [www.dell.com/poweredge manuals](http://www.dell.com/poweredge manuals)

**NOTE:** To access iDRAC, ensure that you connect the ethernet cable to the iDRAC9 dedicated network port. You can also access iDRAC through the shared LOM mode, if you have opted for a system that has the shared LOM mode enabled.

## Log in to iDRAC

You can log in to iDRAC as:

- iDRAC user
- Microsoft Active Directory user
- Lightweight Directory Access Protocol (LDAP) user

If you have opted for secure default access to iDRAC, you must use the iDRAC secure default password available on the system Information tag. If you have not opted for secure default access to iDRAC, then use the default user name and password `-root` and `calvin`. You can also log in by using your Single Sign-On or Smart Card.

**NOTE:** You must have the iDRAC credentials to log in to iDRAC.

**NOTE:** Ensure that you change the default username and password after setting up the iDRAC IP address.

For more information about logging in to the iDRAC and iDRAC licenses, see the latest *Integrated Dell Remote Access Controller User's Guide* at [www.dell.com/poweredge manuals](http://www.dell.com/poweredge manuals).

You can also access iDRAC by using RACADM. For more information, see the *RACADM Command Line Interface Reference Guide* at [www.dell.com/poweredge manuals](http://www.dell.com/poweredge manuals).

## Options to install the operating system

If the system is shipped without an operating system, install a supported operating system by using one of the following resources:

**Table 17. Resources to install the operating system**

Resources	Location
iDRAC	<a href="http://www.dell.com/idrac manuals">www.dell.com/idrac manuals</a>
Lifecycle Controller	<a href="http://www.dell.com/idrac manuals">www.dell.com/idrac manuals</a> > Lifecycle Controller
OpenManage Deployment Toolkit	<a href="http://www.dell.com/openmanage manuals">www.dell.com/openmanage manuals</a> > OpenManage Deployment Toolkit
Dell certified VMware ESXi	<a href="http://www.dell.com/virtualizationsolutions">www.dell.com/virtualizationsolutions</a>
Installation and How-to videos for supported operating systems on PowerEdge systems	<a href="#">Supported Operating Systems for Dell EMC PowerEdge systems</a>

## Methods to download firmware and drivers

You can download the firmware and drivers by using any of the following methods:

**Table 18. Firmware and drivers**

Methods	Location
From the Dell EMC support site	<a href="http://www.dell.com/support/home">www.dell.com/support/home</a>
Using Dell Remote Access Controller Lifecycle Controller (iDRAC with LC)	<a href="http://www.dell.com/idrac manuals">www.dell.com/idrac manuals</a>

**Table 18. Firmware and drivers (continued)**

<b>Methods</b>	<b>Location</b>
Using Dell Repository Manager (DRM)	<a href="http://www.dell.com/openmanagemanuals">www.dell.com/openmanagemanuals</a> > Repository Manager
Using Dell OpenManage Essentials	<a href="http://www.dell.com/openmanagemanuals">www.dell.com/openmanagemanuals</a> > OpenManage Essentials
Using Dell OpenManage Enterprise	<a href="http://www.dell.com/openmanagemanuals">www.dell.com/openmanagemanuals</a> > OpenManage Enterprise
Using Dell Server Update Utility (SUU)	<a href="http://www.dell.com/openmanagemanuals">www.dell.com/openmanagemanuals</a> > Server Update Utility
Using Dell OpenManage Deployment Toolkit (DTK)	<a href="http://www.dell.com/openmanagemanuals">www.dell.com/openmanagemanuals</a> > OpenManage Deployment Toolkit
Using iDRAC virtual media	<a href="http://www.dell.com/idracmanuals">www.dell.com/idracmanuals</a>


## Downloading drivers and firmware

Dell EMC recommends that you download and install the latest BIOS, drivers, and systems management firmware on your system.

### Prerequisites

Ensure that you clear the web browser cache before downloading the drivers and firmware.

### Steps


1. Go to [www.dell.com/support/home](http://www.dell.com/support/home).
2. In the **Drivers & Downloads** section, type the Service Tag of your system in the **Enter a Service Tag or product ID** box, and then click **Submit**.  
 **NOTE:** If you do not have the Service Tag, select **Detect Product** to allow the system to automatically detect the Service Tag, or click **View products**, and navigate to your product.
3. Click **Drivers & Downloads**.  
The drivers that are applicable to your system are displayed.
4. Download the drivers to a USB drive, CD, or DVD.

# Installing and removing system components

## Topics:


- Safety instructions
- Before working inside your system
- After working inside your system
- Recommended tools
- Optional front bezel
- System cover
- Backplane cover
- Inside the system
- Air shroud
- Cooling fan assembly
- Cooling fans
- Intrusion switch
- NVDIMM-N battery
- Mid drive tray
- Drives
- Rear drive cage
- System memory
- Processors and heat sinks
- Expansion cards and expansion card risers
- M.2 SSD module
- Optional MicroSD or vFlash card
- Optional IDSDM or vFlash module
- Network daughter card
- Integrated storage controller card
- Backplane
- Cable routing
- System battery
- Optional internal USB memory key
- Power supply units
- System board
- Trusted Platform Module
- Control panel

## Safety instructions

 **NOTE:** Whenever you need to lift the system, get others to assist you. To avoid injury, do not attempt to lift the system by yourself.

 **WARNING:** Opening or removing the system cover while the system is powered on may expose you to a risk of electric shock.

 **CAUTION:** Do not operate the system without the cover for a duration exceeding five minutes. Operating the system without the system cover can result in component damage.

 **CAUTION:** Many repairs may only be done by a certified service technician. You should only perform troubleshooting and simple repairs as authorized in your product documentation, or as directed by the online or

telephone service and support team. Damage due to servicing that is not authorized by Dell is not covered by your warranty. Read and follow the safety instructions that are shipped with your product.

**i** **NOTE:** It is recommended that you always use an antistatic mat and antistatic strap while working on components inside the system.

**△** **CAUTION:** To ensure proper operation and cooling, all bays in the system and system fans must be always populated with a component or a blank.

## Before working inside your system

### Prerequisites

Follow the safety guidelines listed in [Safety instructions](#).

### Steps

1. Turn off the system, including all attached peripherals.
2. Disconnect the system from the electrical outlet and disconnect the peripherals.
3. If applicable, remove the system from the rack.  
For more information, see the *Rack Installation Guide* at [www.dell.com/poweredgemanuals](http://www.dell.com/poweredgemanuals).
4. [Remove the system cover](#).

## After working inside your system

### Prerequisites

Follow the safety guidelines listed in [Safety instructions](#).

### Steps

1. [Install the system cover](#).
2. If applicable, install the system into the rack.  
For more information, see the *Rack Installation Guide* at <https://www.dell.com/poweredgemanuals>.
3. Reconnect the peripherals and connect the system to the electrical outlet.
4. Turn on the attached peripherals and then turn on the system.

## Recommended tools

You need the following tools to perform the removal and installation procedures:

- Key to the bezel lock  
The key is required only if your system includes a bezel.
- Phillips #1 screwdriver
- Phillips #2 screwdriver
- Torx #T30 screwdriver
- 1/4 inch flat blade screwdriver
- Wrist-grounding strap connected to the ground
- ESD Mat

You need the following tools to assemble the cables for a DC power supply unit:

- AMP 90871-1 hand-crimping tool or equivalent
- Tyco Electronics 58433-3 or equivalent
- Wire-stripper pliers to remove insulation from size 10 AWG solid or stranded, insulated copper wire

**i** **NOTE:** Use alpha wire part number 3080 or equivalent (65/30 stranding).



# Optional front bezel

## Front bezel details

An optional metal bezel is mounted on the front of the system to display system branding. A lock on the bezel is used to protect unauthorized access to the drives. There are two versions of bezel available:

- With LCD panel
- Without LCD panel

For bezels with LCD panel, the system status can be viewed on the LCD panel. For more information, see the [LCD panel](#) section.

The LCD bezel is hot pluggable and can be used in any server of the same branding even if that system was originally not ordered with that LCD bezel.

## Removing the front bezel

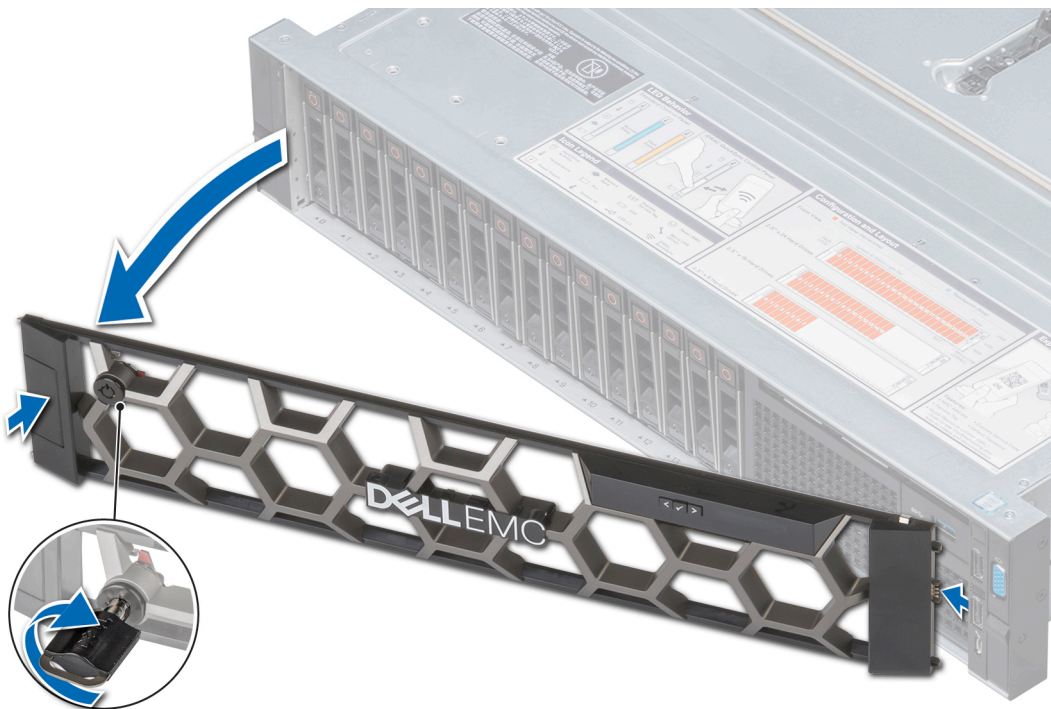
The procedure to remove the front bezel with and without the LCD panel is the same.

### Prerequisites

Follow the safety guidelines listed in [Safety instructions](#).

### Steps

1. Unlock the bezel by using the bezel key.
2. Press the release button, and pull the left end of the bezel.
3. Unhook the right end, and remove the bezel.



**Figure 23. Removing the optional front bezel with the LCD panel**

### Next steps

[Install the front bezel.](#)

## Installing the front bezel

The procedure to install the front bezel with and without the LCD panel is the same.

### Prerequisites

Follow the safety guidelines listed in [Safety instructions](#).

### Steps

1. Locate and remove the bezel key.

**NOTE:** The bezel key is part of the LCD bezel package.

2. Align and insert the right end of the bezel onto the system.
3. Press the bezel until the button clicks in place and fit the left end of the bezel onto the system.
4. Lock the bezel by using the key.

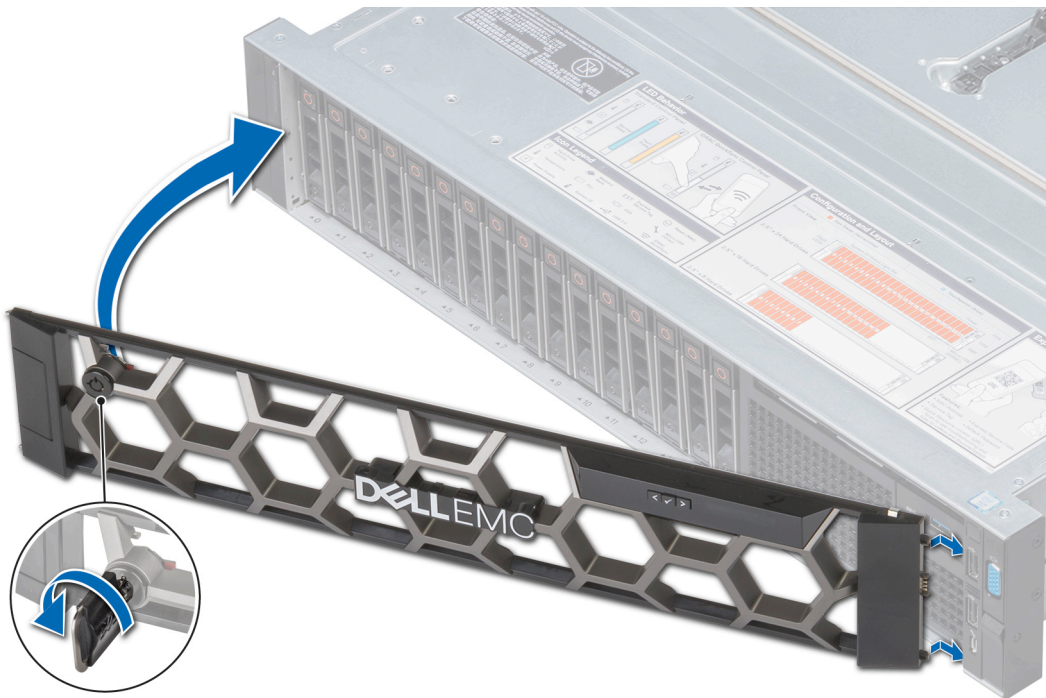


Figure 24. Installing the optional front bezel with the LCD panel

## System cover

### Removing the system cover

#### Prerequisites

1. Follow the safety guidelines listed in [Safety instructions](#).
2. Turn off the system, including any attached peripherals.
3. Disconnect the system from the electrical outlet and disconnect the peripherals.

#### Steps

1. Using a 1/4 inch flat head or a Phillips #2 screwdriver, rotate the latch release lock counter clockwise to the unlocked position.

2. Lift the latch till the system cover slides back and the tabs on the system cover disengage from the guide slots on the system.
3. Hold the cover on both sides, and lift the cover away from the system.



**Figure 25. Removing the system cover**

### Next steps

[Install the system cover.](#)

## Installing the system cover

### Prerequisites

1. Follow the safety guidelines listed in [Safety instructions](#).
2. Ensure that all internal cables are routed correctly and connected, and no tools or extra parts are left inside the system.

### Steps

1. Align the tabs on the system cover with the guide slots on the system.
2. Push the system cover latch down.  
The system cover slides forward, the tabs on the system cover engage with the guide slots on the system and the system cover latch locks into place.
3. Using a 1/4 inch flat head or Phillips #2 screwdriver, rotate the latch release lock clockwise to the locked position.



**Figure 26. Installing system cover**

#### **Next steps**

1. Reconnect the peripherals and connect the system to the electrical outlet.
2. Turn on the system, including any attached peripherals.

## **Backplane cover**

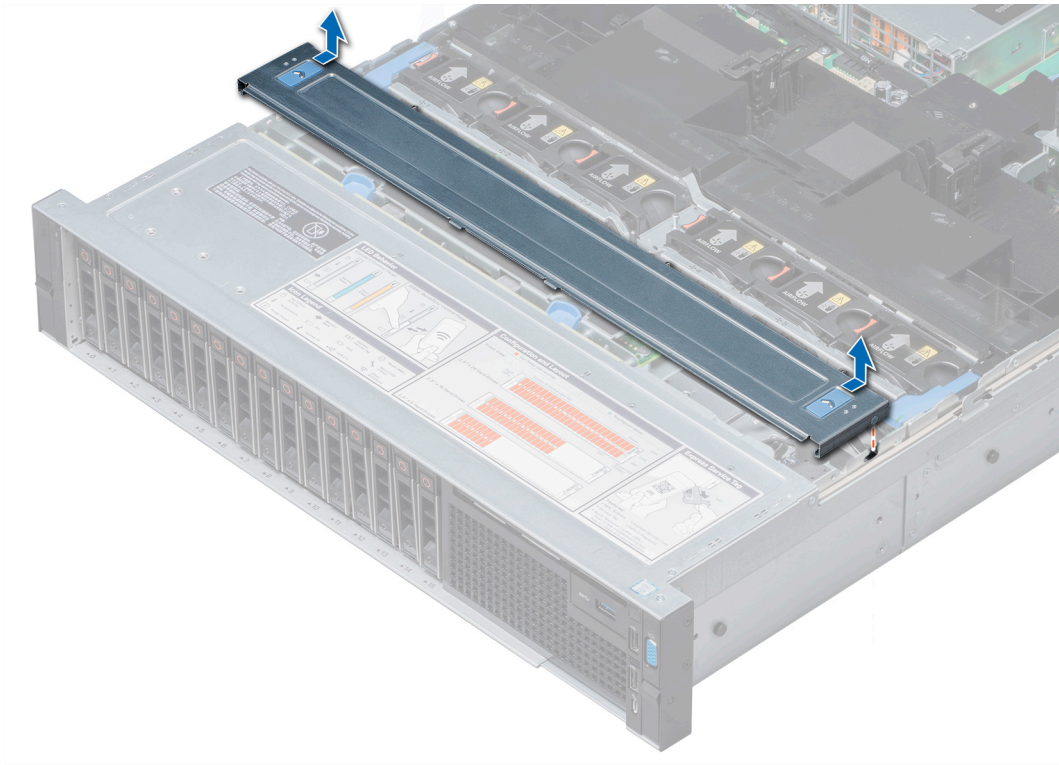
### **Removing the backplane cover**

#### **Prerequisites**

1. Follow the safety guidelines listed in [Safety instructions](#).
2. Follow the procedure listed in [Before working inside your system](#).

#### **Steps**

1. Slide the backplane cover in the direction of the arrows marked on the backplane cover.
2. Lift the backplane cover away from the system.



**Figure 27. Removing backplane cover**

#### **Next steps**

Install the backplane cover.

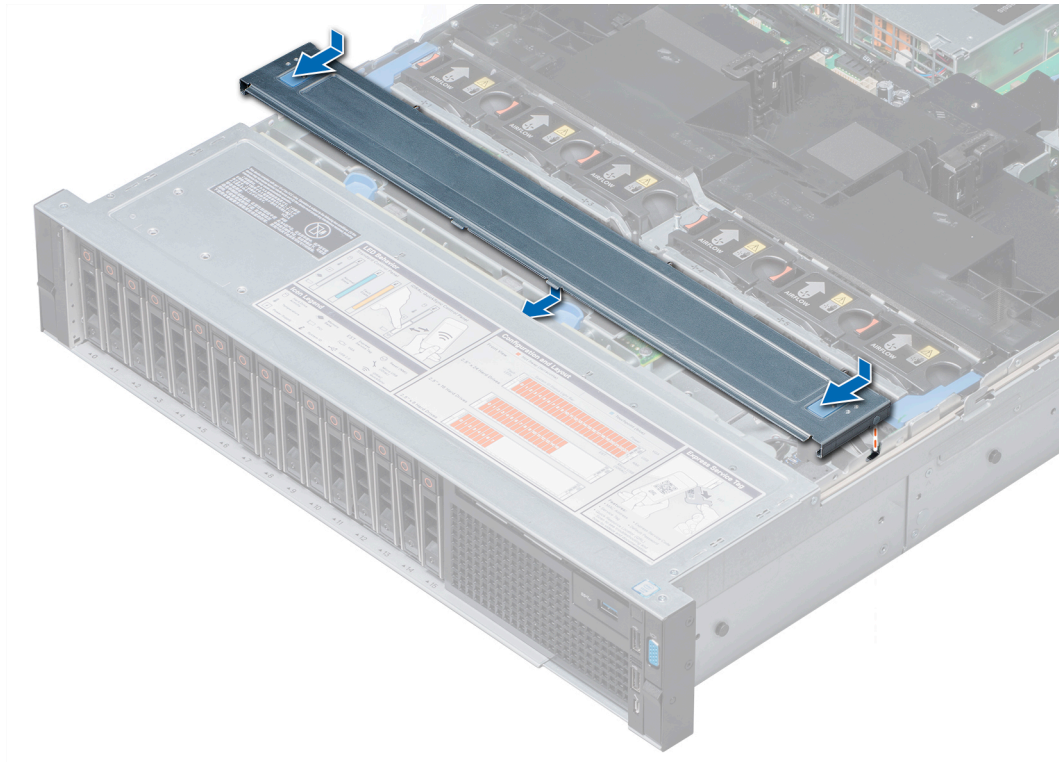
## **Installing the backplane cover**

#### **Prerequisites**

Follow the safety guidelines listed in [Safety instructions](#).

#### **Steps**

1. Align the tabs on the backplane cover with the guide slots on the system.
2. Slide the backplane cover toward the front of the system until the cover locks into place.



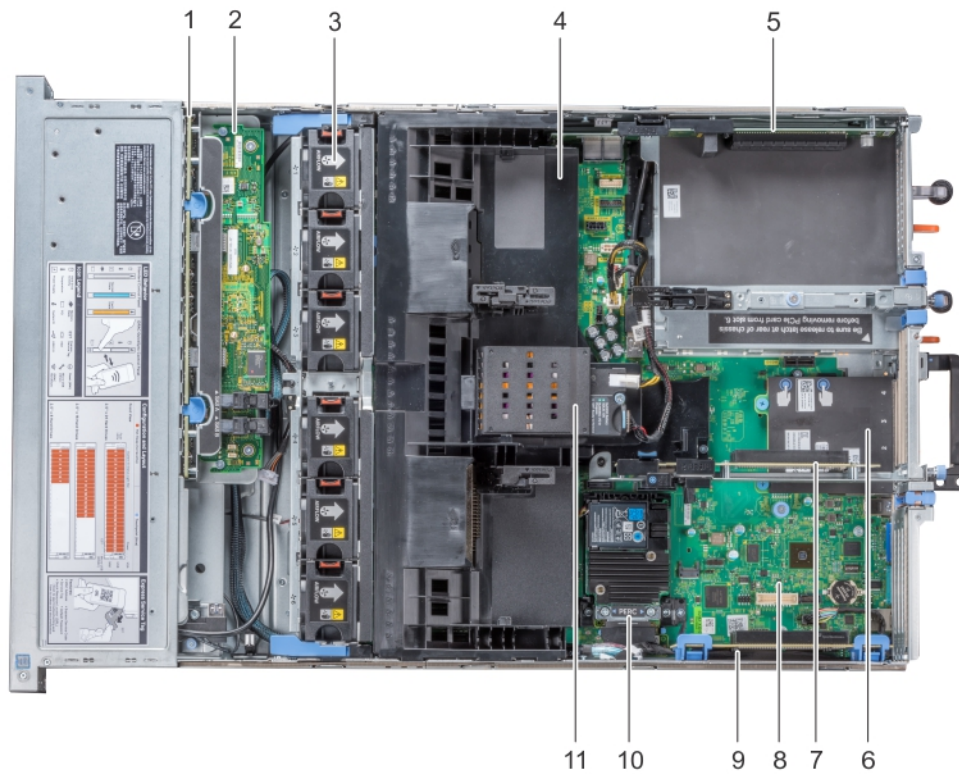
**Figure 28. Installing the backplane cover**

#### **Next steps**

Follow the procedure listed in [After working inside your system](#).

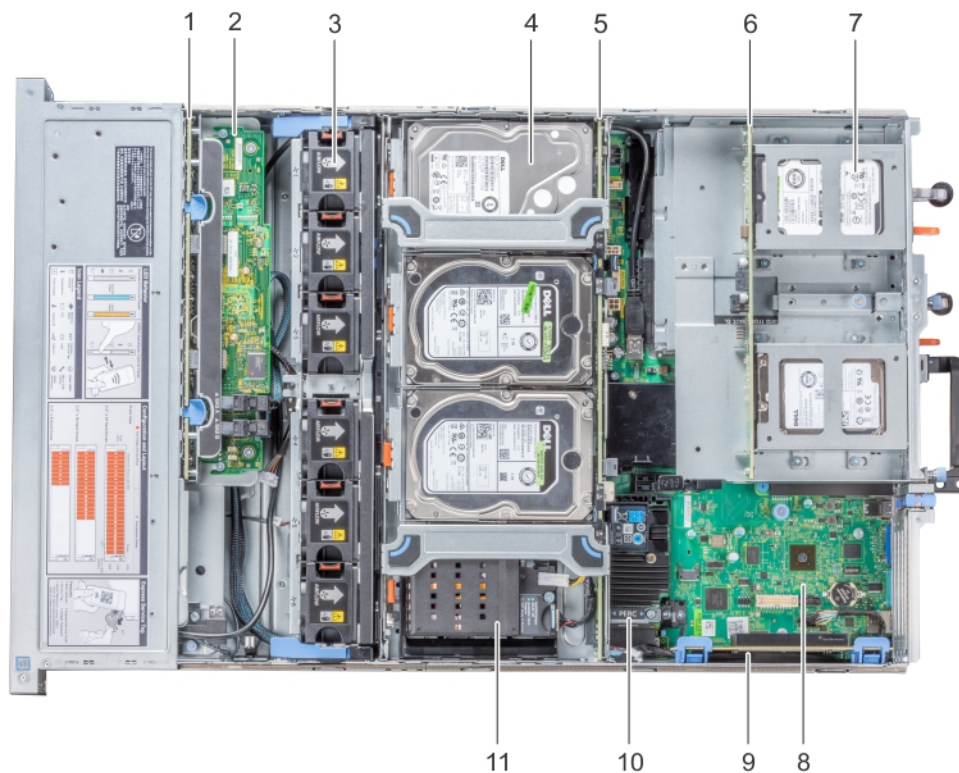
## **Inside the system**

**CAUTION:** Many repairs may only be done by a certified service technician. You should only perform troubleshooting and simple repairs as authorized in your product documentation, or as directed by the online or telephone service and support team. Damage due to servicing that is not authorized by Dell is not covered by your warranty. Read and follow the safety instructions that are shipped with your product.



**Figure 29. Inside the system – NVDIMM-N battery**

- |  |  |
|--|--|
| 1. drive backplane                             | 2. backplane expander card             |
| 3. cooling fan (6) in the cooling fan assembly | 4. air shroud                          |
| 5. expansion card riser 3                      | 6. network daughter card               |
| 7. expansion card riser 2                      | 8. system board                        |
| 9. expansion card riser 1                      | 10. integrated storage controller card |
| 11. NVDIMM-N battery                           |  |



**Figure 30. Inside the system – mid drive tray and rear drive cage**

- |  |  |
|--|--|
| 1. drive backplane                             | 2. backplane expander card             |
| 3. cooling fan (6) in the cooling fan assembly | 4. drive (4) in the mid drive tray     |
| 5. mid drive backplane                         | 6. rear drive backplane                |
| 7. drive (2 or 4) in the rear drive cage       | 8. system board                        |
| 9. expansion card riser 1                      | 10. integrated storage controller card |
| 11. NVDIMM-N battery                           |  |



# Air shroud

## Removing the air shroud

### Prerequisites

**CAUTION:** Never operate your system with the air shroud removed. The system may get overheated quickly, resulting in shutdown of the system and loss of data.

1. Follow the safety guidelines listed in [Safety instructions](#).
2. Follow the procedure listed in [Before working inside your system](#).
3. If installed, remove the full length PCIe cards.
4. If applicable, [remove the GPU cards](#).
5. If NVDIMM-N battery is installed, disconnect the cables from the NVDIMM-N battery.

**CAUTION:** NVDIMM-N battery is not hot swappable. To prevent data loss and potential damage to your system, ensure that your system, LEDs on system, LEDs on NVDIMM-N and LEDs on NVDIMM-N battery are turned off before disconnecting the NVDIMM-N battery cables.

### Steps

Hold the air shroud at both ends and lift it away from the system.

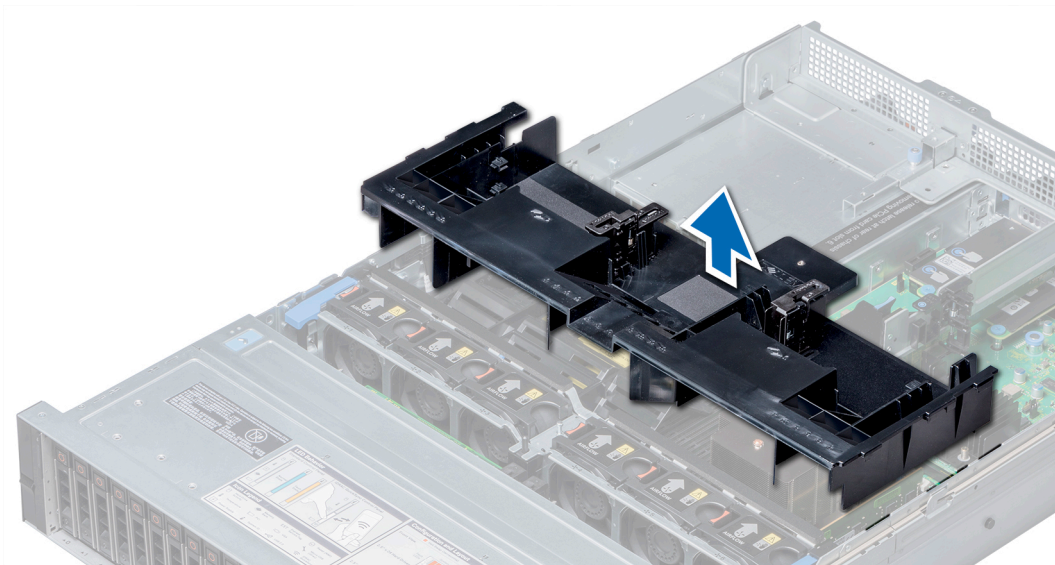


Figure 31. Removing air shroud

### Next steps

If applicable, [install the air shroud](#).

## Installing the air shroud

### Prerequisites

1. Follow the safety guidelines listed in [Safety instructions](#).
2. If applicable, route the cables inside the system along the system wall and secure the cables by using the cable latch.

### Steps

1. Align the tabs on the air shroud with the slots on the system.

2. Lower the air shroud into the system until it is firmly seated.  
When firmly seated, the memory socket numbers marked on the air shroud align with the respective memory sockets.

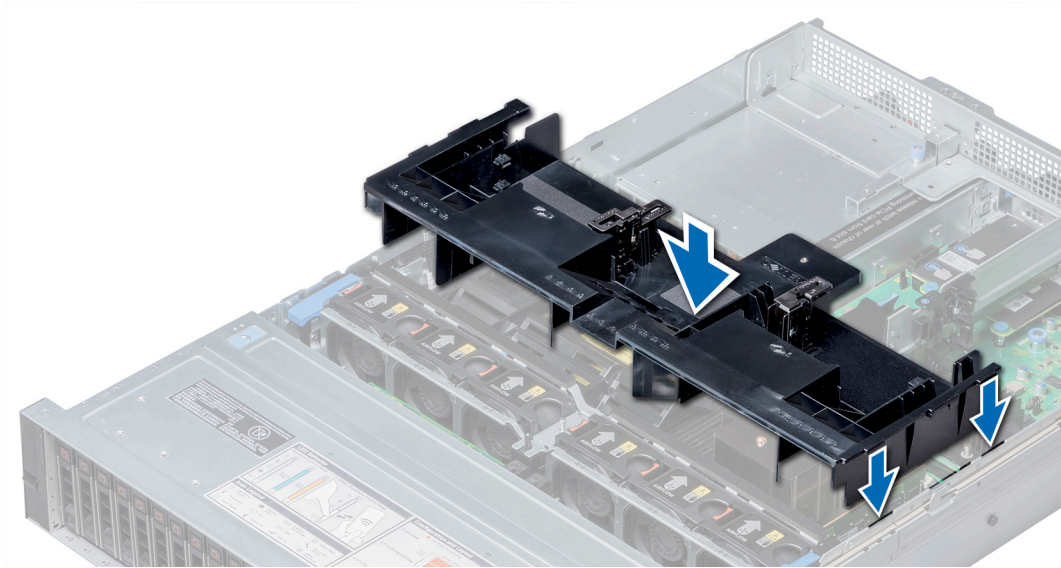


Figure 32. Installing air shroud

#### Next steps

1. If removed, install the full length PCIe cards.
2. If applicable, [install the GPU cards](#).
3. If applicable, connect the cables to the NVDIMM-N battery.  
**CAUTION: NVDIMM-N battery is not hot swappable. To prevent data loss and potential damage to your system, ensure that your system, LEDs on system, LEDs on NVDIMM-N and LEDs on NVDIMM-N battery are turned off before connecting the NVDIMM-N battery cables.**
4. Follow the procedure listed in [After working inside your system](#).

## Cooling fan assembly

### Removing the cooling fan assembly

#### Prerequisites

1. Follow the safety guidelines listed in [Safety instructions](#).
2. Follow the procedure listed in [Before working inside your system](#).

#### Steps

1. Lift the release levers to unlock the cooling fan assembly from the system.
2. Hold the release levers, and lift the cooling fan assembly away from the system.

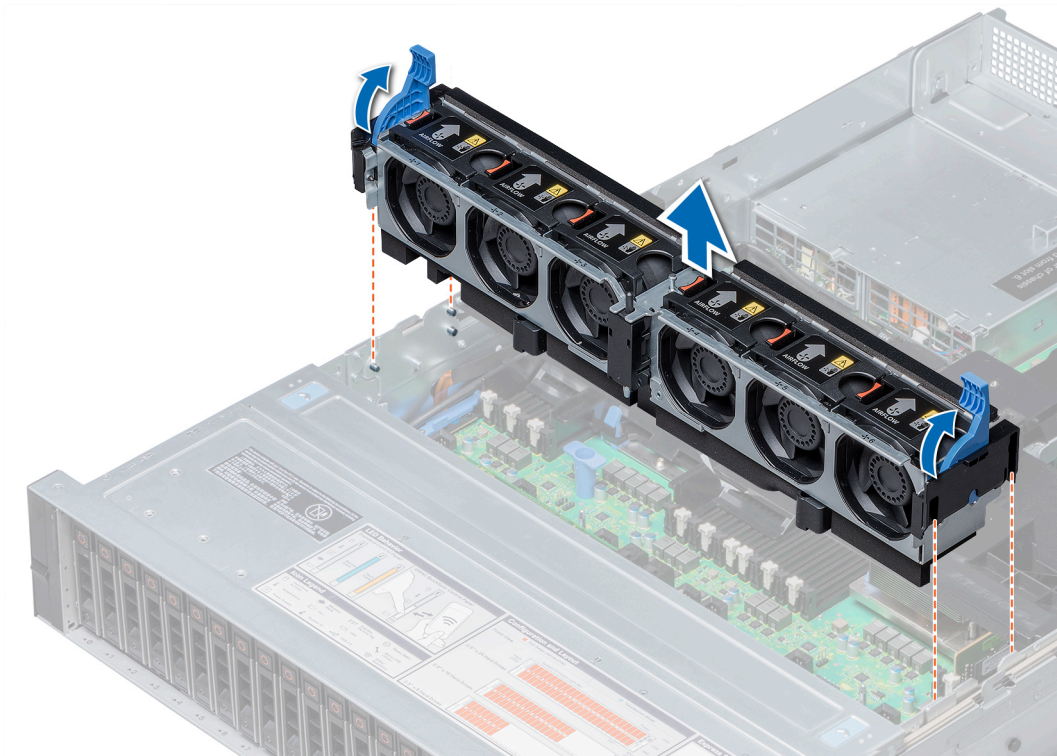


Figure 33. Removing the cooling fan assembly

#### Next steps

Install the cooling fan assembly.

## Installing the cooling fan assembly

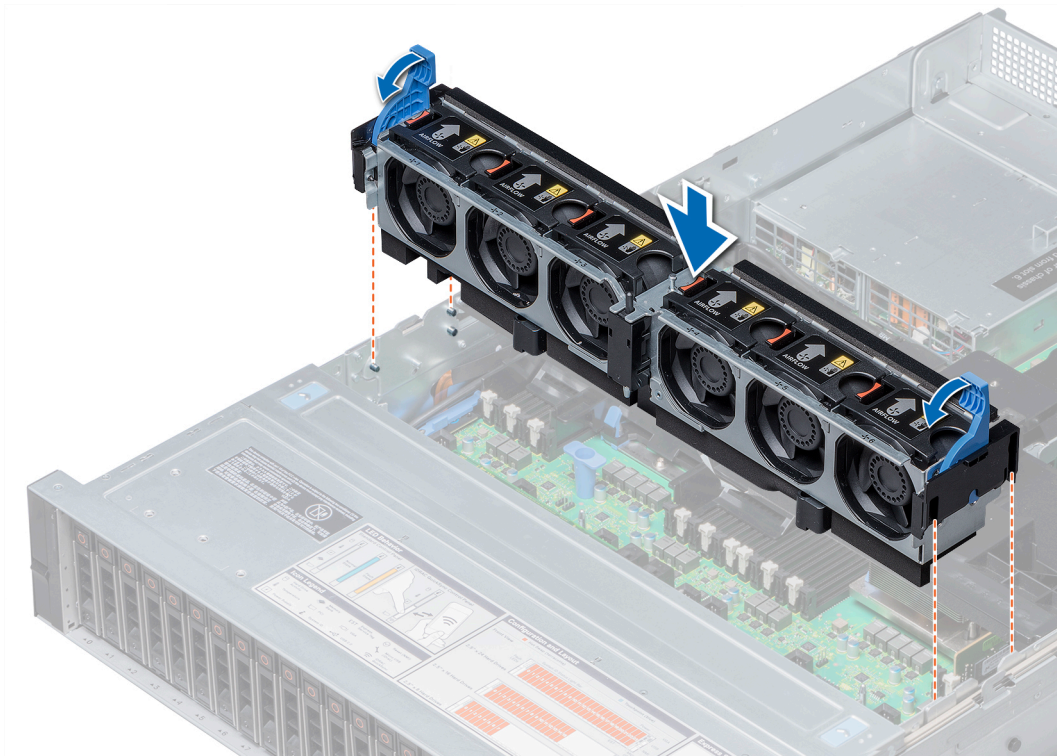
#### Prerequisites

Follow the safety guidelines listed in [Safety instructions](#).

**CAUTION:** Ensure that the cables inside the system are correctly installed and retained by the cable retention bracket before installing the cooling fan assembly. Incorrectly installed cables may get damaged.

#### Steps

1. Align the guide rails on the cooling fan assembly with the standoffs on the system.
2. Lower the cooling fan assembly into the system until the cooling fan connectors engage with the connectors on the system board.
3. Press the release levers to lock the cooling fan assembly into the system.



**Figure 34. Installing the cooling fan assembly**

### Next steps

Follow the procedure listed in [After working inside your system](#).

## Cooling fans

### Cooling fan details

The cooling fans are integrated into the system to dissipate the heat generated by the functioning of the system. These fans provide cooling for the processors, expansion cards, and memory modules.

Your system supports up to six standard or high performance hot swappable cooling fans.

For single processor systems without a mid drive tray, only four cooling fans are required. Fan bays 1 and 2 are covered by a fan blank.

**CAUTION:** Mixing of standard and high performance cooling fans is not supported.

**NOTE:** Each fan is listed in the systems management software, referenced by the respective fan number. If there is a problem with a particular fan, you can easily identify and replace the proper fan by noting the fan numbers on the cooling fan assembly.

**NOTE:** Cooling fans are hot swappable.

## Removing a cooling fan

The procedure for removing standard and high performance fans is identical.

### Prerequisites

**NOTE:** Opening or removing the system cover when the system is on may expose you to a risk of electric shock. Exercise utmost care while removing or installing cooling fans.

**CAUTION:** The cooling fans are hot swappable. To maintain proper cooling while the system is on, replace only one fan at a time.

1. Follow the safety guidelines listed in [Safety instructions](#).
2. Follow the procedure listed in [Before working inside your system](#).

### Steps

Press the release tab and lift the cooling fan out of the cooling fan assembly.

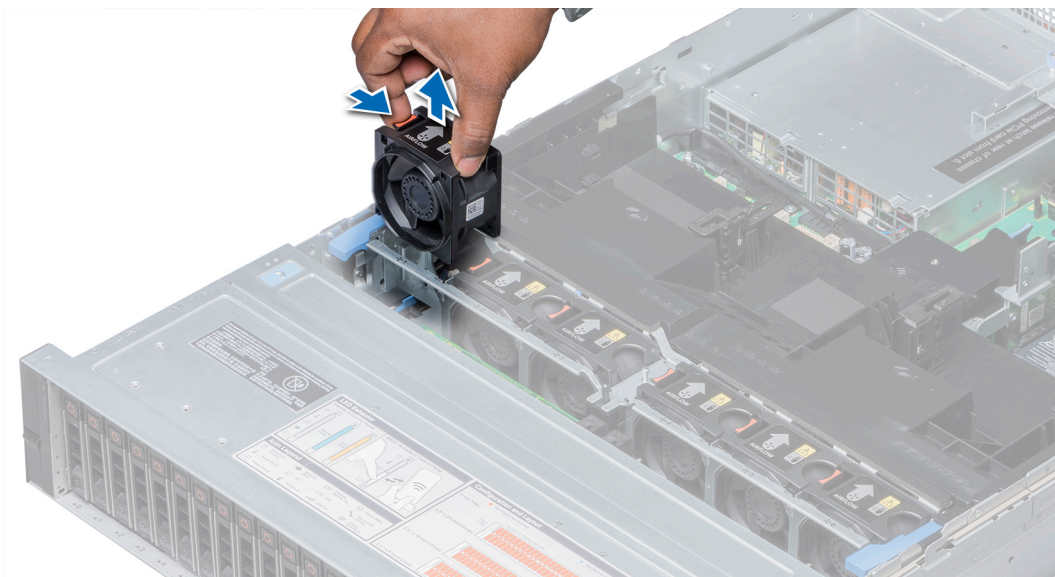


Figure 35. Removing cooling fan

### Next steps

If applicable, [install the cooling fan](#).

## Installing a cooling fan

The procedure for installing standard and high performance fans is identical.

### Prerequisites

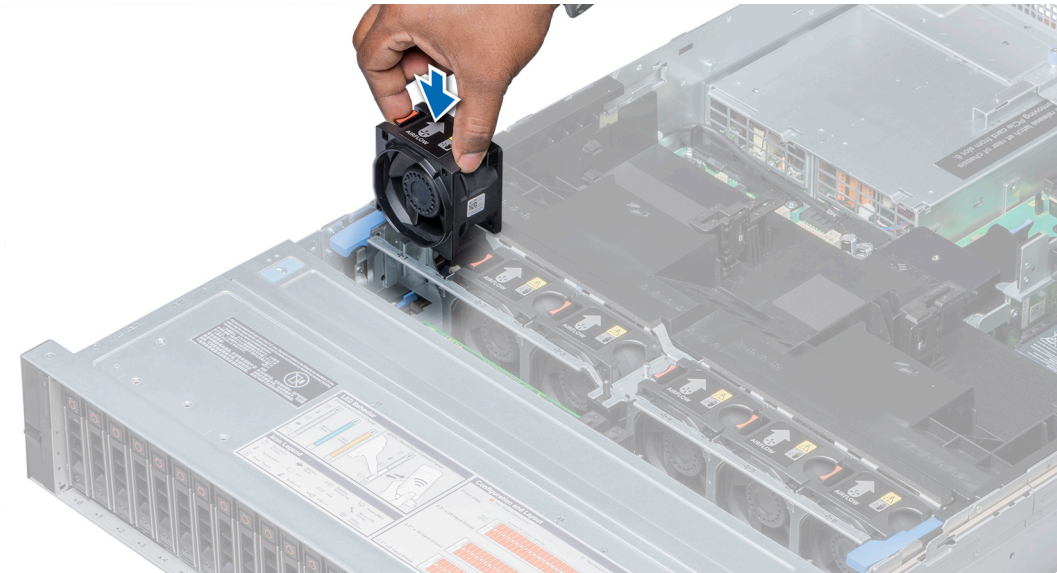
**NOTE:** Opening or removing the system cover when the system is on may expose you to a risk of electric shock. Exercise utmost care while removing or installing cooling fans.

**CAUTION:** The cooling fans are hot swappable. To maintain proper cooling while the system is on, replace only one fan at a time.

Follow the safety guidelines listed in [Safety instructions](#).

### Steps

1. Holding the release tab, align the connector at the base of the cooling fan with the connector on the system board.



**Figure 36. Installing cooling fan**

2. Slide the cooling fan into the cooling fan assembly until the release tab locks into place.

#### **Next steps**

Follow the procedure listed in [After working inside your system](#).

## **Intrusion switch**

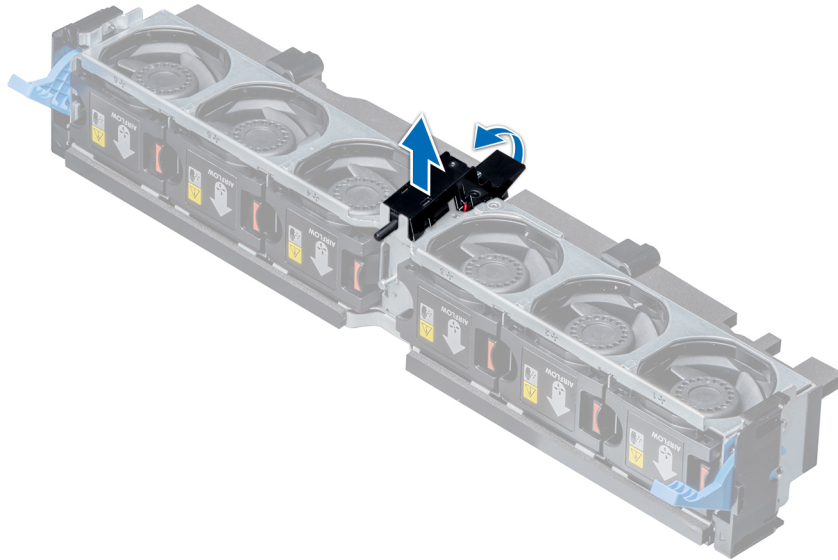
### **Removing an intrusion switch**

#### **Prerequisites**

1. Follow the safety guidelines listed in [Safety instructions](#).
2. Follow the procedure listed in [Before working inside your system](#).
3. [Remove the cooling fan assembly](#).

#### **Steps**

Press the intrusion switch and slide it out of the intrusion switch slot.



**Figure 37. Removing an intrusion switch**

**Next steps**

Install an intrusion switch.

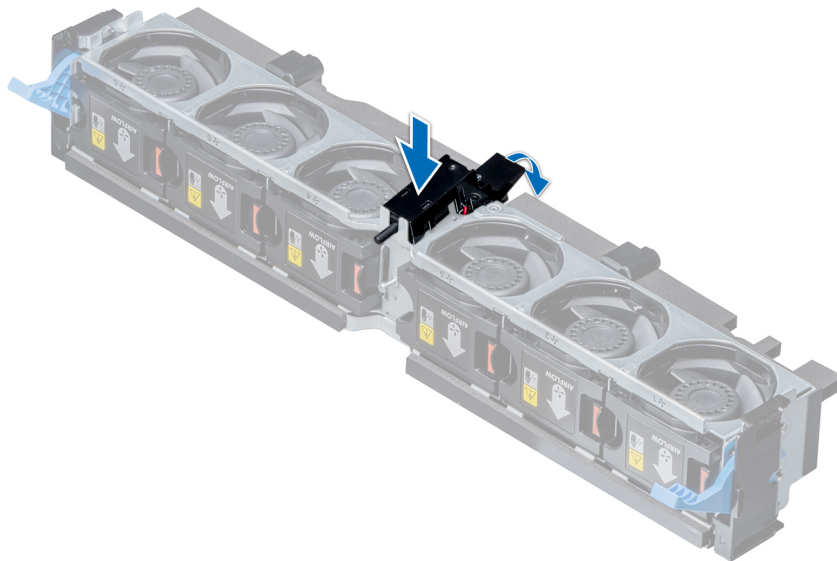
## Installing an intrusion switch

**Prerequisites**

Follow the safety guidelines listed in [Safety instructions](#).

**Steps**

1. Align the tabs on the intrusion switch with the slots on the cooling fan assembly.
2. Push the intrusion switch until it locks in place.



**Figure 38. Installing an intrusion switch**


### Next steps

1. [Install the cooling fan assembly.](#)
2. Follow the procedure listed in [After working inside your system.](#)

## NVDIMM-N battery

### NVDIMM-N battery details


NVDIMM-N battery can be installed on air shroud and 3.5-inch mid hard drive tray.


 **NOTE:** NVDIMM-N battery is not supported on 2.5 inch NVMe mid hard drive tray.

## Removing the NVDIMM-N battery from the air shroud

### Prerequisites

1. Follow the safety guidelines listed in [Safety instructions.](#)
2. Follow the procedure listed in [Before working inside your system.](#)

 **CAUTION:** NVDIMM-N battery is not hot swappable. To prevent data loss and potential damage to your system, ensure that your system, LEDs on system, LEDs on NVDIMM-N and LEDs on NVDIMM-N battery are turned off before removing the NVDIMM-N battery.

 **CAUTION:** To avoid damage to the battery connector, you must firmly support the connector while installing or removing a battery.

### Steps

1. Disconnect the cables from the NVDIMM-N battery.
2. Using Phillips #2 screwdriver, remove the screw securing the NVDIMM-N battery.
3. Holding the edges, lift the NVDIMM-N battery at an angle to disengage it from the slot on the air shroud.
4. Lift the NVDIMM-N battery away from the system.



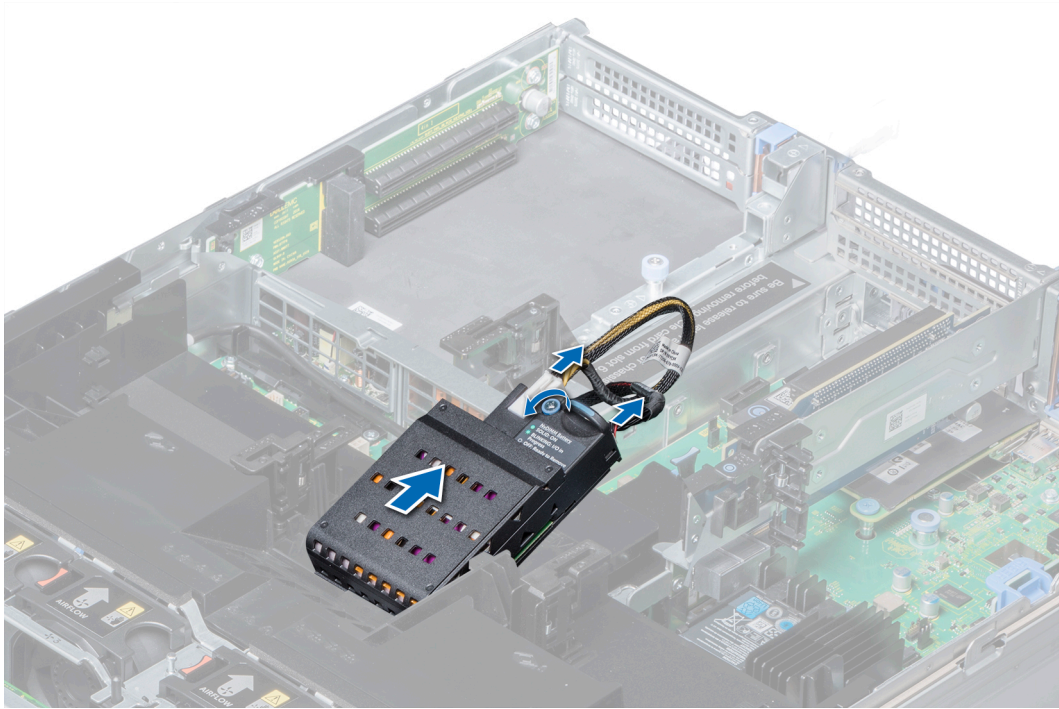


Figure 39. Removing the NVDIMM-N battery from the air shroud

### Next steps

Install the NVDIMM-N battery into the air shroud.

## Installing NVDIMM-N battery into air shroud

### Prerequisites

Follow the safety guidelines listed in [Safety instructions](#).

**CAUTION:** NVDIMM-N battery is not hot swappable. To prevent data loss and potential damage to your system, ensure that your system, LEDs on system, LEDs on NVDIMM-N and LEDs on NVDIMM-N battery are turned off before installing the NVDIMM-N battery.

**CAUTION:** To avoid damage to the battery connector, you must firmly support the connector while installing or removing a battery.

### Steps

1. Incline the NVDIMM-N battery at an angle and place the battery on the air shroud slot.
2. Using Phillips #2 screwdriver, tighten the screw to secure the NVDIMM-N battery.
3. Connect the cables to the NVDIMM-N battery.

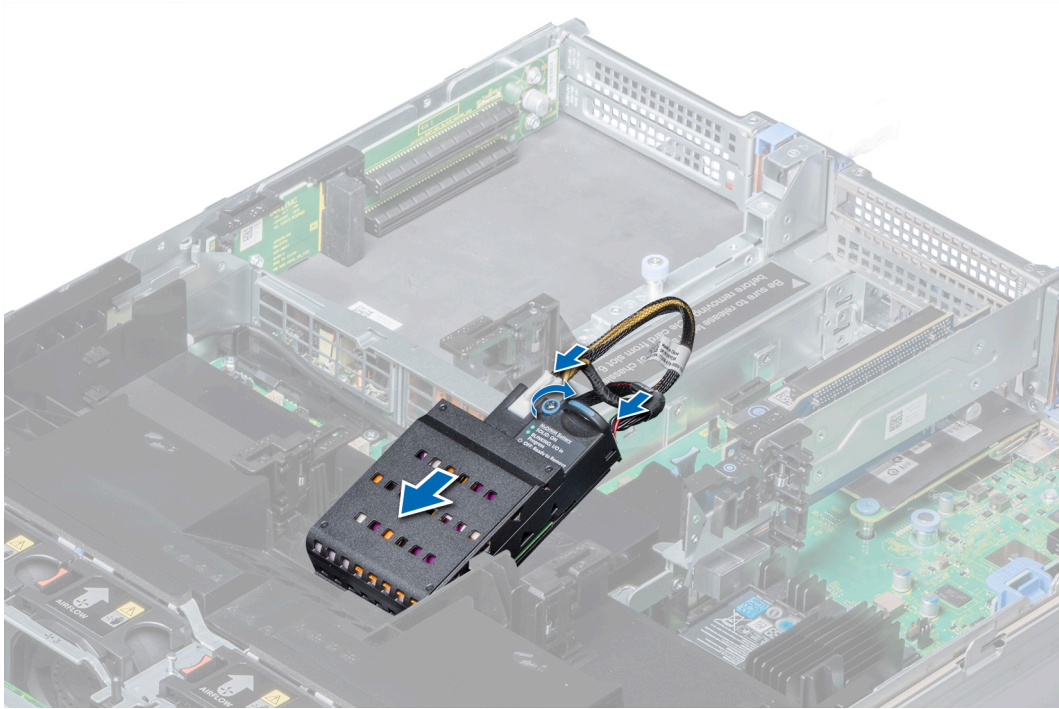


Figure 40. Installing NVDIMM-N battery into air shroud

### Next steps

Follow the procedure listed in [After working inside your system](#).

## Removing NVDIMM-N battery from mid drive tray

### Prerequisites

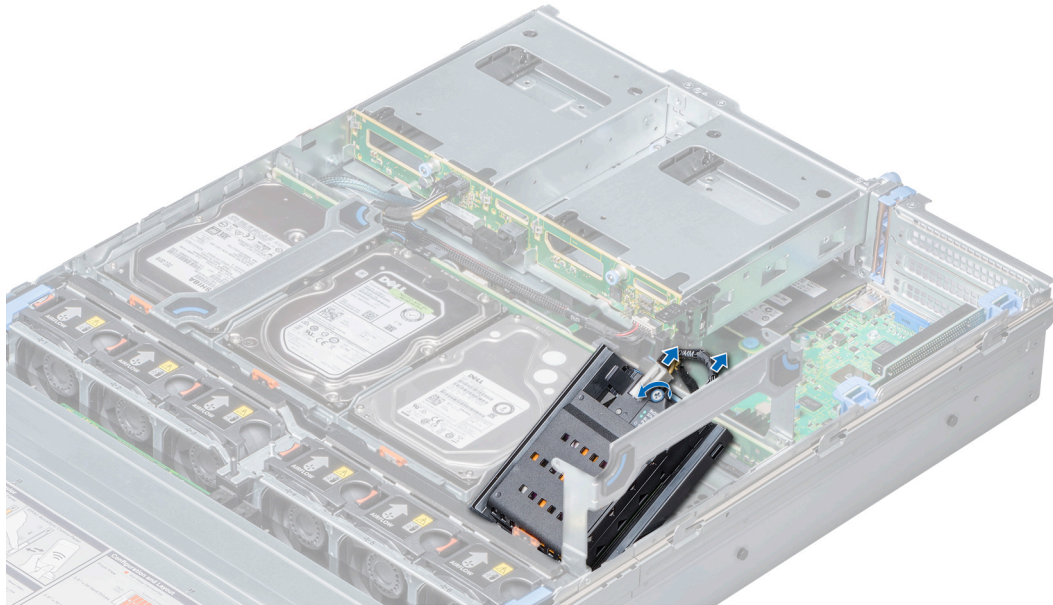
1. Follow the safety guidelines listed in [Safety instructions](#).
2. Follow the procedure listed in [Before working inside your system](#).

**CAUTION:** NVDIMM-N battery is not hot swappable. To prevent data loss and potential damage to your system, ensure that your system, LEDs on system, LEDs on NVDIMM-N and LEDs on NVDIMM-N battery are turned off before removing the NVDIMM-N battery.

**CAUTION:** To avoid damage to the battery connector, you must firmly support the connector while installing or removing a battery.

### Steps

1. Lift the drive tray handles 90 degrees upward.
2. Using Phillips #2 screwdriver, remove the screw securing the NVDIMM-N battery.
3. Slide the NVDIMM-N battery to disengage it from the drive tray.
4. Disconnect the cables from the NVDIMM-N battery.
5. Holding the edges, lift the NVDIMM-N battery away from the system.



**Figure 41. Removing NVDIMM-N battery from mid drive tray**

### Next steps

Install NVDIMM-N battery into mid drive tray.

## Installing NVDIMM-N battery into mid drive tray

### Prerequisites

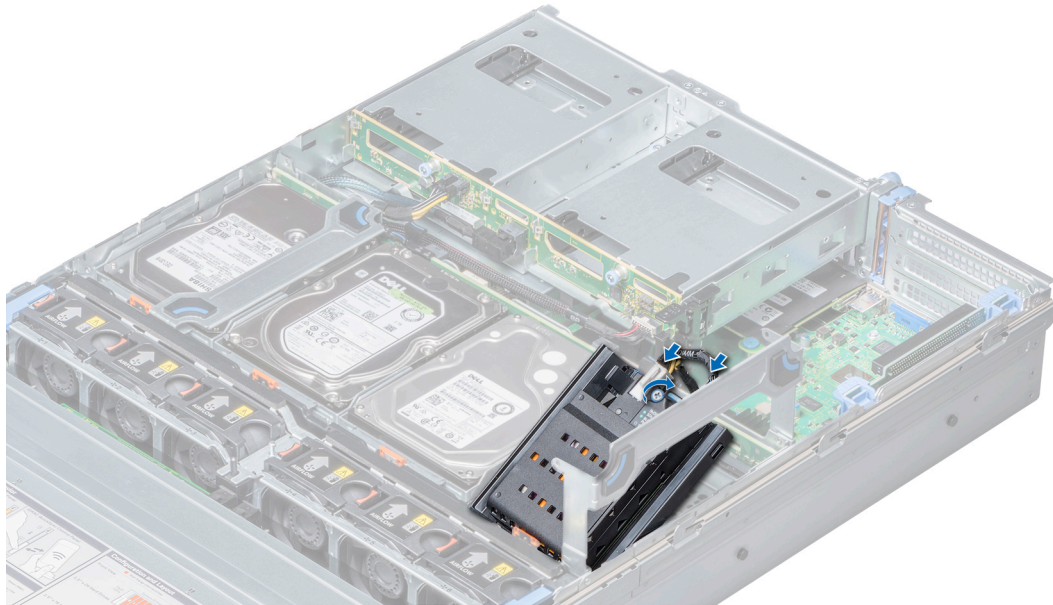
Follow the safety guidelines listed in [Safety instructions](#).

**CAUTION:** NVDIMM-N battery is not hot swappable. To prevent data loss and potential damage to your system, ensure that your system, LEDs on system, LEDs on NVDIMM-N and LEDs on NVDIMM-N battery are turned off before installing the NVDIMM-N battery.

**CAUTION:** To avoid damage to the battery connector, you must firmly support the connector while installing or removing a battery.

### Steps

1. Connect the cables to the NVDIMM-N battery.
2. Slide the NVDIMM-N battery to engage the battery with the drive tray.
3. Using Phillips #2 screwdriver, tighten the screw to secure the NVDIMM-N battery.
4. Lower the drive tray handle.



**Figure 42. Installing NVDIMM-N battery into mid drive tray**

### Next steps

Follow the procedure listed in [After working inside your system](#).

## Removing NVDIMM-N battery from the bracket

### Prerequisites

1. Follow the safety guidelines listed in [Safety instructions](#).
2. Follow the procedure listed in [Before working inside your system](#).

**CAUTION:** NVDIMM-N battery is not hot swappable. To prevent data loss and potential damage to your system, ensure that your system, LEDs on system, LEDs on NVDIMM-N and LEDs on NVDIMM-N battery are turned off before removing the NVDIMM-N battery.

**CAUTION:** To avoid damage to the battery connector, you must firmly support the connector while installing or removing a battery.

### Steps

Press the release tab and slide out the NVDIMM-N battery to disengage the tab on the battery from the slot on the bracket.



Figure 43. Removing NVDIMM-N battery from the bracket

### Next steps

Install NVDIMM-N battery into the bracket..

## Installing NVDIMM-N battery into the bracket

### Prerequisites

Follow the safety guidelines listed in [Safety instructions](#).

**CAUTION:** NVDIMM-N battery is not hot swappable. To prevent data loss and potential damage to your system, ensure that your system, LEDs on system, LEDs on NVDIMM-N and LEDs on NVDIMM-N battery are turned off before installing the NVDIMM-N battery.

**CAUTION:** To avoid damage to the battery connector, you must firmly support the connector while installing or removing a battery.

### Steps

1. Align the tab on the NVDIMM-N battery with the slot on the bracket.
2. Insert the battery into the bracket until it is firmly seated.



Figure 44. Installing NVDIMM-N battery into the bracket

### Next steps

Follow the procedure listed in [After working inside your system](#).

## Mid drive tray

### Mid drive tray details

The mid drive tray is located behind the cooling fan assembly. It supports up to four 2.5 inch or four 3.

**NOTE:** Systems that support the internal mid drive tray require low-profile heat sinks and do not require or support an air shroud.

## Removing mid drive tray

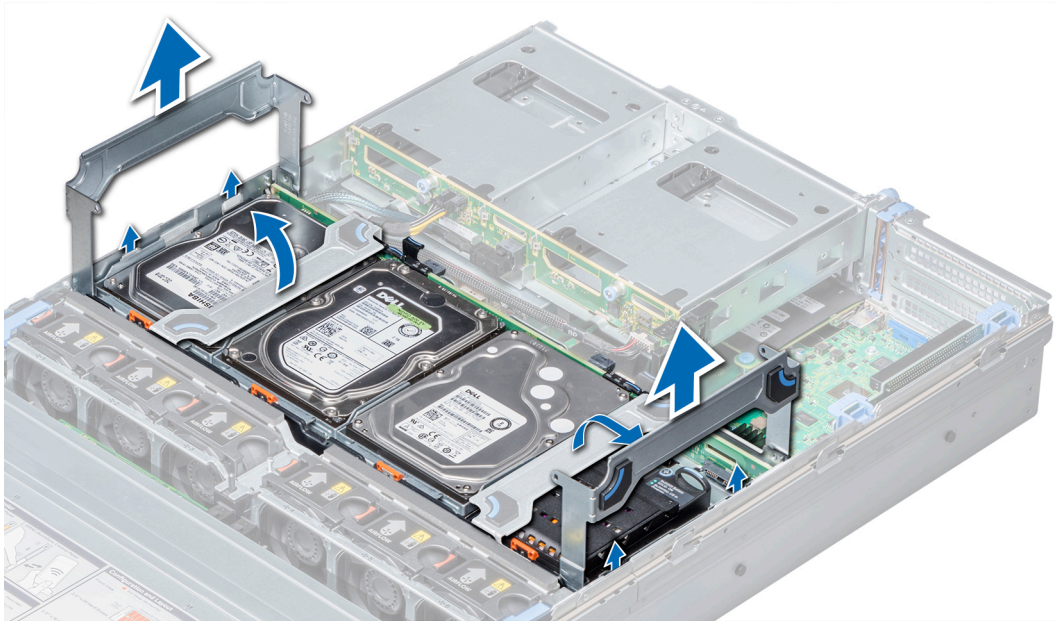
### Prerequisites

1. Follow the safety guidelines listed in [Safety instructions](#).
2. Follow the procedure listed in [Before working inside your system](#).
3. Disconnect all the cables from the drive backplane.

**CAUTION:** The drive tray is hot to touch for some time after the system has been powered down. Allow time for the drive tray to cool before handling it.

### Steps

1. Lift the drive tray handles 90 degrees upward.
2. Hold the drive tray handles, and lift the drive tray out of the system.



**Figure 45. Removing mid drive tray**

### Next steps

Install the mid drive tray.

## Installing the mid drive tray

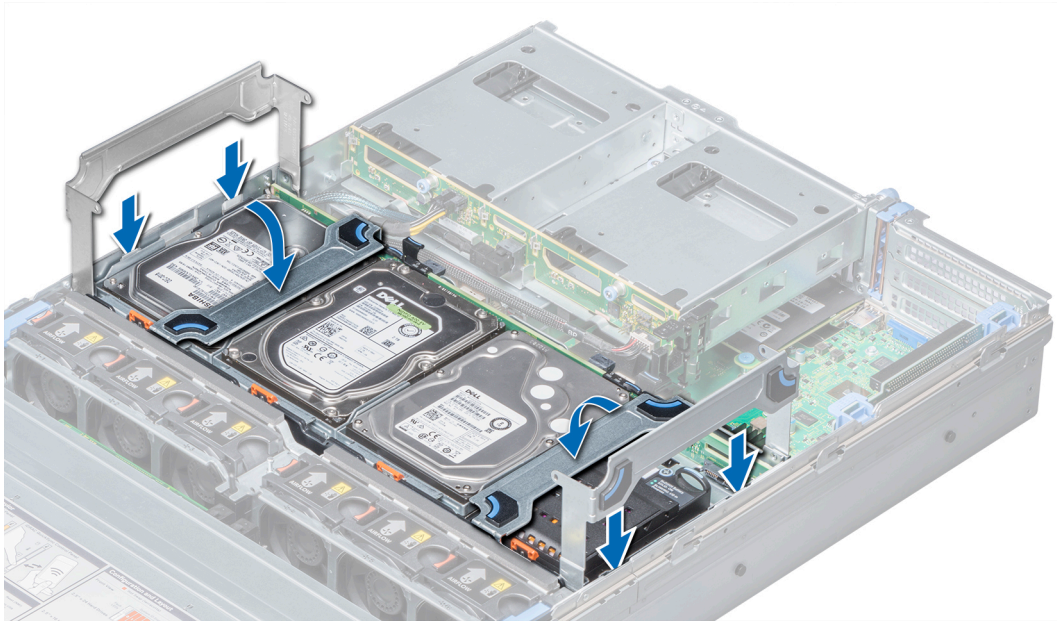
### Prerequisites

Follow the safety guidelines listed in [Safety instructions](#).

**NOTE:** Systems that support the internal drive tray support low-profile heat sinks and do not support an air shroud.

### Steps

1. Lift the drive tray handles to 90 degrees upward.
2. Hold the drive tray handles, and align the slots on the drive tray with the guide pins on the system.
3. Lower the drive tray into the system.
4. Lower the drive tray handles to lock the drive tray in place.



**Figure 46. Installing the mid drive tray**

#### Next steps

1. Connect all the cables to the backplane.
2. Follow the procedure listed in [After working inside your system](#).

## Removing drive blank from drive carrier

The procedure to remove drive blank from drive carrier is identical to removal of drive from drive carrier. The procedure for removing 2.5 inch and 3.5 inch blanks from drive carriers is identical.

#### Prerequisites

1. Follow the safety guidelines listed in [Safety instructions](#).
2. Follow the procedure listed in [Before working inside your system](#).

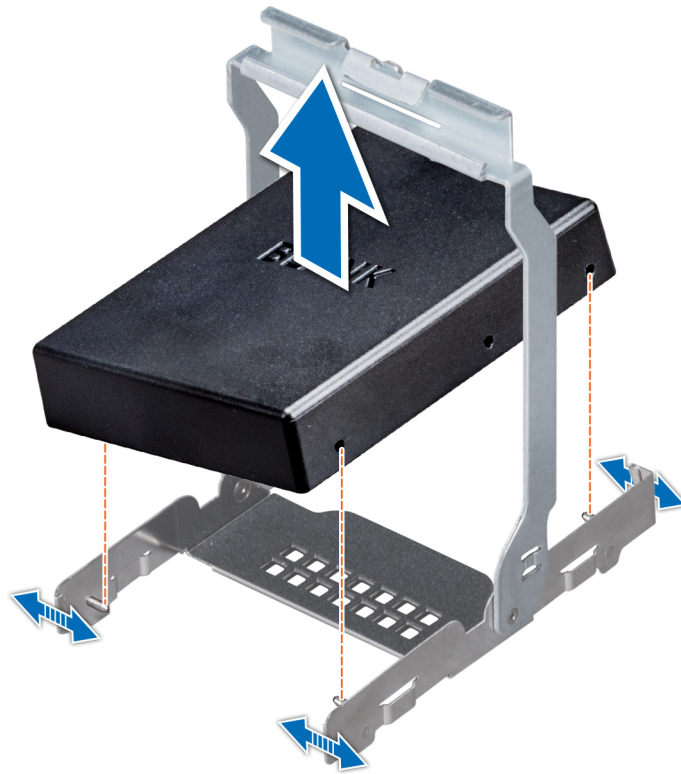
**⚠ CAUTION: To maintain proper system cooling, all empty drive slots must have drive blanks installed.**

**⚠ CAUTION: Mixing drive blanks from previous generations of PowerEdge servers is not supported.**

#### Steps

1. Push out at the edges of the drive carrier to disengage the tabs on the drive carrier from the slots on the drive blank.
2. Lift the drive carrier away from the drive blank.





**Figure 47. Removing drive blank from the mid drive carrier**

#### Next steps

Install drive blank into drive carrier.

## Installing drive blank into the drive carrier

The procedure to install drive blank from drive carrier is identical to installation of drive into drive carrier. The procedure for installing 2.5 inch and 3.5 inch blanks into drive carriers is identical.

#### Prerequisites

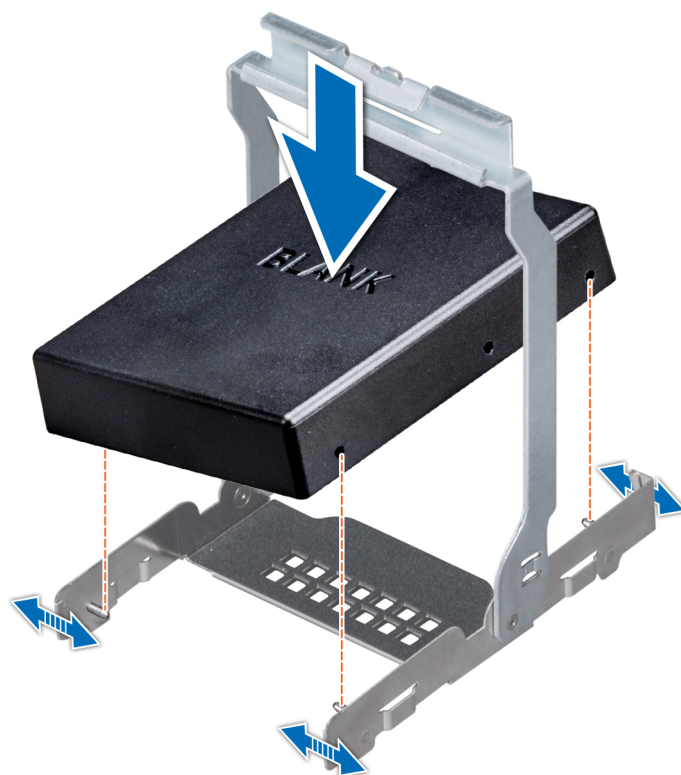
Follow the safety guidelines listed in [Safety instructions](#).

**⚠ CAUTION: To maintain proper system cooling, all empty drive slots must have drive blanks installed.**

**⚠ CAUTION: Mixing drive blanks from previous generations of PowerEdge servers is not supported.**

#### Steps

1. Align the tabs on the drive carrier with the slots on the drive blank.
2. Pull the edges of the carrier to fit over the drive blank.
3. Lower the drive carrier onto the drive blank to secure it.



**Figure 48. Installing drive blank into the mid drive carrier**

### Next steps

Follow the procedure listed in [After working inside your system](#).

## Removing drive carrier from the mid drive tray

### Prerequisites

1. Follow the safety guidelines listed in [Safety instructions](#).
2. Follow the procedure listed in [Before working inside your system](#).
3. From the management software, prepare the drive for removal. Wait until the indicators on the drive carrier signal that the drive can be removed safely. For more information, see the documentation for the *storage controller* at [www.dell.com/storagecontrollermanuals](http://www.dell.com/storagecontrollermanuals).

If the drive is online, the green activity/fault indicator flashes as the drive is turned off. When the drive indicators are off, the drive is ready for removal.

**CAUTION:** To prevent data loss, ensure that your operating system supports hot-swap drive installation. See the documentation supplied with your operating system.

**CAUTION:** When a replacement hot swappable drive is installed and the system is powered on, the drive automatically begins to rebuild. Ensure that the replacement drive is blank or contains data that you wish to overwrite. Any data on the replacement drive is immediately lost after the drive is installed.

**CAUTION:** Mixing drive carriers from previous generations of PowerEdge servers is not supported.

### Steps

1. Lift the drive carrier handle upward.
2. Press the release tab on the drive tray and lift the drive carrier handle upward to disengage the drive from the backplane.
3. Hold the drive carrier handle and lift the drive carrier out of the drive tray.

**CAUTION:** To maintain proper system cooling, all empty drive slots must have drive blanks installed.

4. If you are not replacing the drive immediately, insert a drive blank in the empty drive slot.

**NOTE:** Install the drive blanks in the drive carrier before installing the drive carrier into the drive tray.

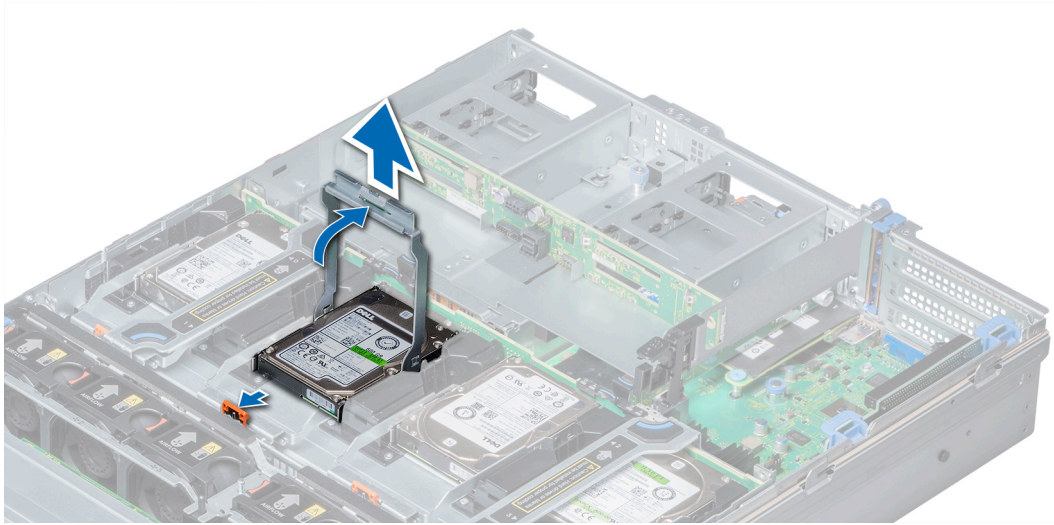


Figure 49. Removing drive carrier from the mid drive tray

#### Next steps

Install drive carrier into mid drive tray.

## Installing drive carrier into mid drive tray

#### Prerequisites

Follow the safety guidelines listed in [Safety instructions](#).

**CAUTION:** Use only drives that have been tested and approved for use with the drive backplane.

**CAUTION:** When installing a drive, ensure that the adjacent drives are fully installed. Inserting a drive carrier and attempting to lock its handle next to a partially installed carrier can damage the partially installed carrier's shield spring and make it unusable.

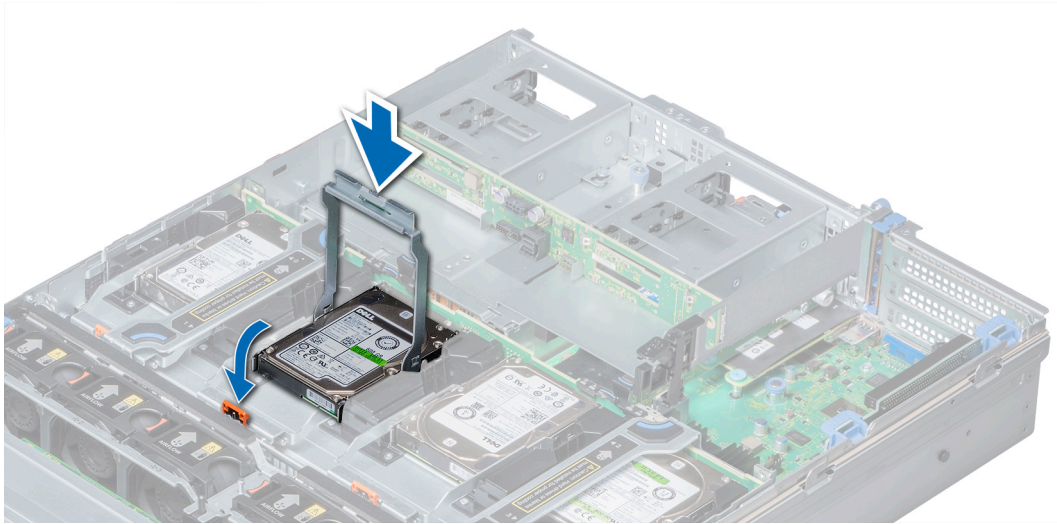
**CAUTION:** To prevent data loss, ensure that your operating system supports hot-swap drive installation. See the documentation supplied with your operating system.

**CAUTION:** Mixing drive carriers from previous generations of PowerEdge servers is not supported.

**CAUTION:** When a replacement hot swappable drive is installed and the system is powered on, the drive automatically begins to rebuild. Ensure that the replacement drive is blank or contains data that you wish to overwrite. Any data on the replacement drive is immediately lost after the drive is installed.

#### Steps

1. Lift the carrier handle.
2. If a drive blank is installed in the drive slot, remove it.
3. Insert the drive carrier into the drive tray.
4. Lower the drive carrier handle to engage the drive to the connector on the backplane and lock the drive in place.



**Figure 50. Installing drive carrier into mid drive tray**

### Next steps

Follow the procedure listed in [After working inside your system](#).

## Removing 3.5 inch drive from the drive carrier

### Prerequisites

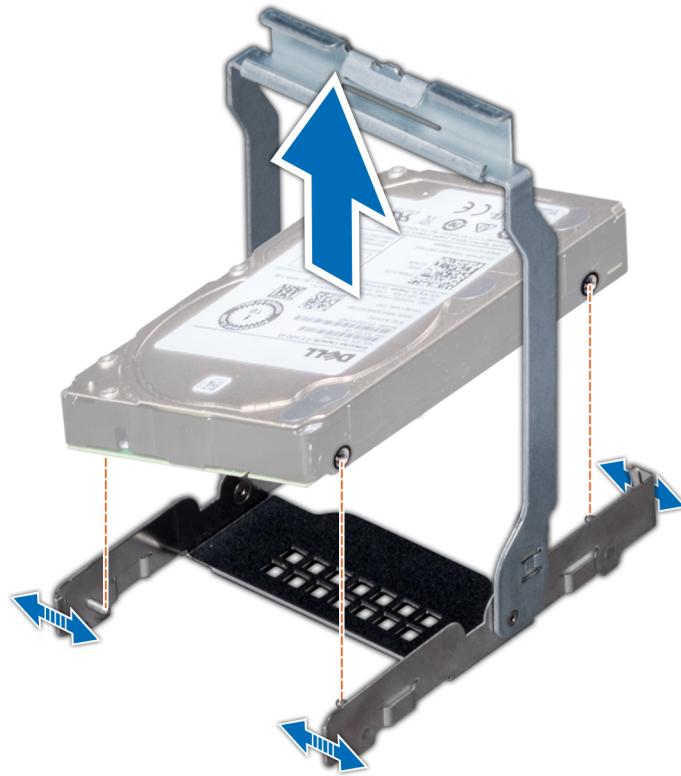
1. Follow the safety guidelines listed in [Safety instructions](#).
2. Follow the procedure listed in [Before working inside your system](#).

**⚠ CAUTION: Mixing drives from previous generations of PowerEdge servers is not supported.**

**⚠ CAUTION: To maintain proper system cooling, all empty drive slots must have drive blanks installed.**

### Steps

1. Push out at the edges of the carrier to disengage the tabs on the drive carrier from the slots on the drive.
2. Lift the drive carrier away from the drive.



**Figure 51. Removing 3.5 inch drive from the drive carrier**

#### **Next steps**

Install 3.5 inch drive into the drive carrier.

## **Installing 3.5 inch drive into the drive carrier**

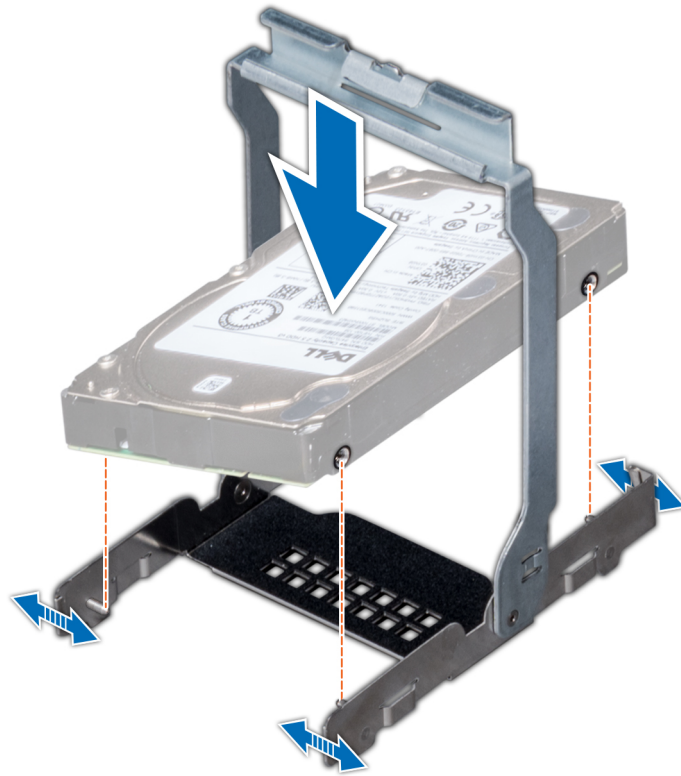
#### **Prerequisites**

Follow the safety guidelines listed in [Safety instructions](#).

**CAUTION:** Mixing drives from previous generations of PowerEdge servers is not supported.

#### **Steps**

1. Align the tabs on the drive carrier with the slots on the drive.
2. Pull the edges of the carrier to fit over the drive.
3. Lower the drive carrier onto the drive to secure it.



**Figure 52. Installing 3.5 inch drive into the drive carrier**

#### **Next steps**

Follow the procedure listed in [After working inside your system](#).

## **Removing a 2.5 inch drive from the 3.5 inch mid drive carrier**

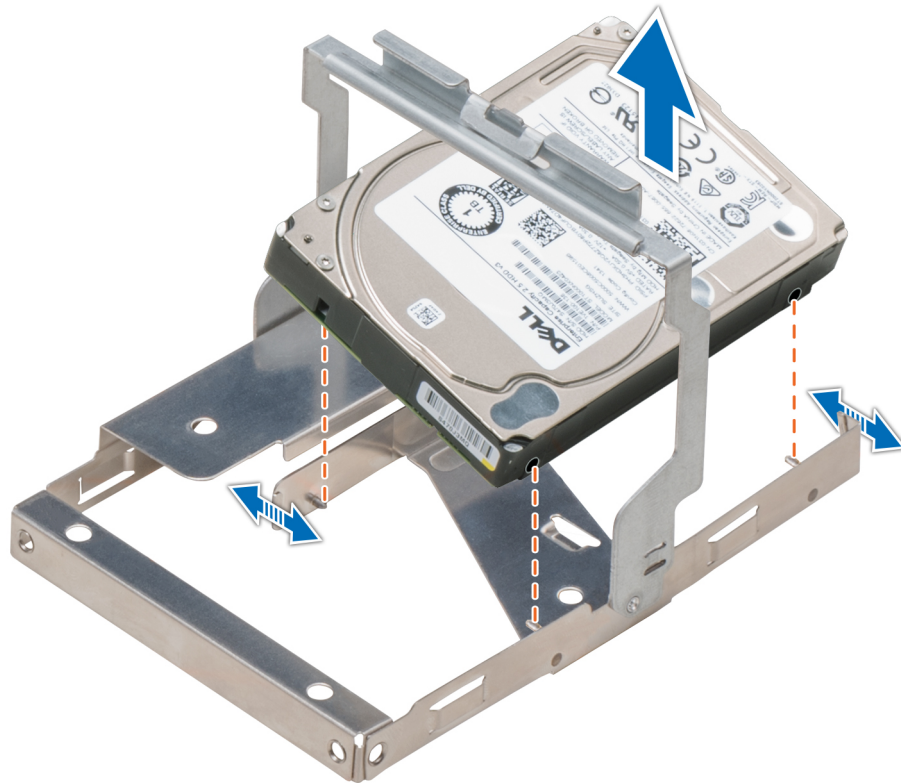
#### **Prerequisites**

1. Follow the safety guidelines listed in [Safety instructions](#).
2. Follow the procedure listed in [Before working inside your system](#).

**⚠ CAUTION: To maintain proper system cooling, all empty drive slots must have drive blanks installed.**

#### **Steps**

1. Push out at the edges of the carrier to disengage the tabs on the drive carrier from the slots on the drive.
2. Lift the drive carrier away from the drive.



**Figure 53. Removing a 2.5 inch drive from the 3.5 inch mid drive carrier**

#### **Next steps**

Install a 2.5 inch drive into the 3.5 inch mid drive carrier.

## **Installing a 2.5 inch drive into the 3.5 inch mid drive carrier**

#### **Prerequisites**

Follow the safety guidelines listed in [Safety instructions](#).

#### **Steps**

1. Align the tabs on the drive carrier with the slots on the drive.
2. Pull the edges of the carrier to fit over the drive.
3. Lower the drive carrier onto the drive to secure it.

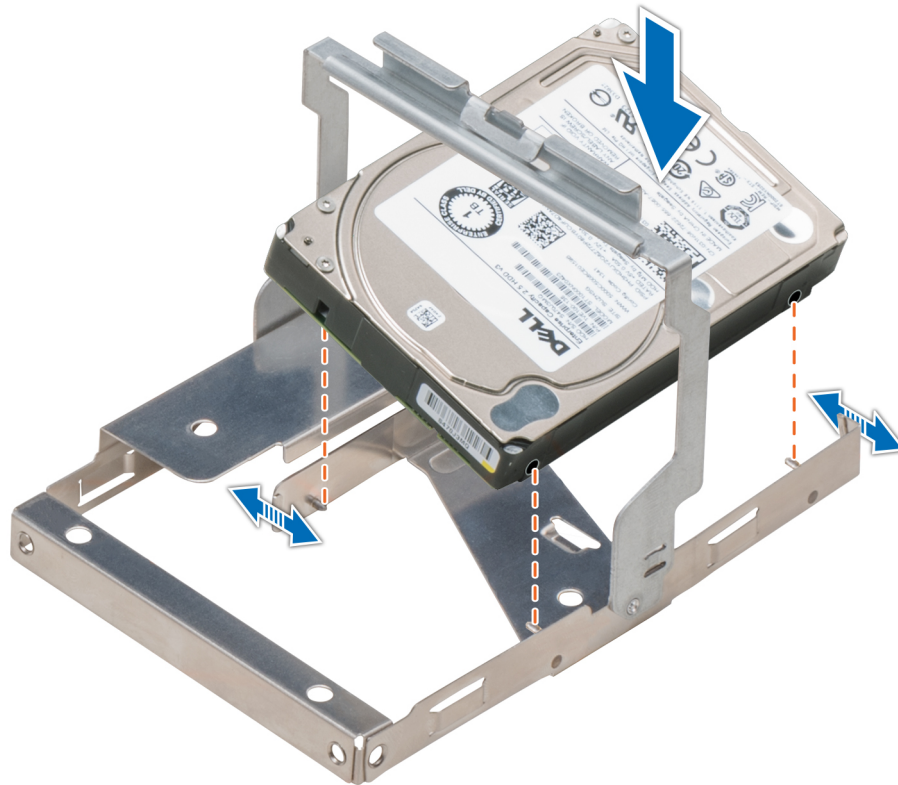


Figure 54. Installing a 2.5 inch drive into the 3.5 inch mid drive carrier

#### Next steps

Follow the procedure listed in [After working inside your system](#).

## Drives

### Drive guidelines

Drives are supplied in hot swappable drive carriers that fit in the drive slots.

**CAUTION:** Before attempting to remove or install a drive while the system is running, see the documentation for the storage controller card to ensure that the host adapter is configured correctly.

**CAUTION:** Do not turn off or restart your system while a drive is being formatted. Doing so can cause a drive failure.

When you format a drive, allow enough time for the formatting to complete. Be aware that high-capacity drives can take a long time to format.

### Removing a drive blank

The procedure for removing 2.5 inch and 3.5 inch drive blanks is identical.

#### Prerequisites

1. Follow the safety guidelines listed in [Safety instructions](#).
2. If installed, [remove the front bezel](#).



**CAUTION:** To maintain proper system cooling, drive blanks must be installed in all empty drive slots.

**CAUTION:** Mixing drive blanks from previous generations of PowerEdge servers is not supported.

### Steps

Press the release button, and slide the drive blank out of the drive slot.

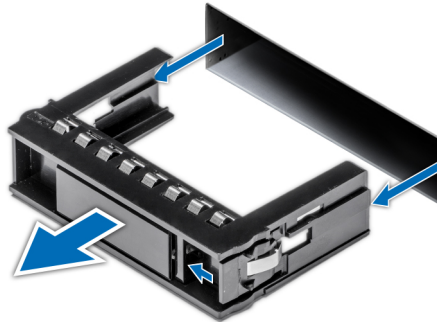


Figure 55. Removing a drive blank

### Next steps

1. [Install a drive](#) or a [drive blank](#)

## Installing a drive blank

The procedure for installing 2.5 inch and 3.5 inch drive blanks is identical.

### Prerequisites

Follow the safety guidelines listed in [Safety instructions](#).

**CAUTION:** Mixing drive blanks from previous generations of PowerEdge servers is not supported.

### Steps

Insert the drive blank into the drive slot, and push the blank until the release button clicks into place.

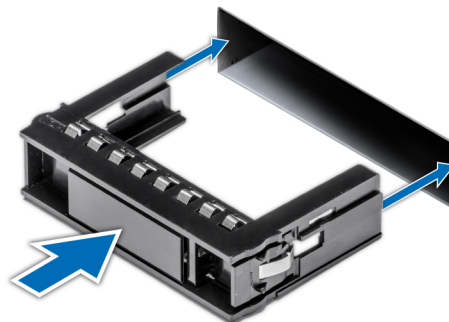


Figure 56. Installing a drive blank

### Next steps

If removed, [install the front bezel](#).

## Removing a drive carrier

### Prerequisites

1. Follow the safety guidelines listed in [Safety instructions](#).
2. If applicable, [remove the front bezel](#).
3. Using the management software, prepare the drive for removal. If the drive is online, the green activity or fault indicator flashes while the drive is turning off. When the drive indicators are off, the drive is ready for removal. For more information, see the documentation for the storage controller.

**CAUTION:** Before attempting to remove or install a drive while the system is running, see the documentation for the storage controller card to ensure that the host adapter is configured correctly to support drive removal and insertion.

**CAUTION:** Mixing drives from previous generations of PowerEdge servers is not supported.

**CAUTION:** To prevent data loss, ensure that your operating system supports drive installation. See the documentation supplied with your operating system.

### Steps

1. Press the release button to open the drive carrier release handle.
2. Holding the handle, slide the drive carrier out of the drive slot.



Figure 57. Removing a drive carrier

### Next steps

1. [Install a drive carrier](#).
2. If you are not replacing the drive immediately, [insert a drive blank](#) in the empty drive slot to maintain proper system cooling.

## Installing a drive carrier

### Prerequisites

**CAUTION:** Before attempting to remove or install a drive while the system is running, see the documentation for the storage controller card to ensure that the host adapter is configured correctly to support drive removal and insertion.

**CAUTION:** Mixing drives from previous generations of PowerEdge servers is not supported.

- CAUTION:** Combining SAS and SATA drives in the same RAID volume is not supported.
- CAUTION:** When installing a drive, ensure that the adjacent drives are fully installed. Inserting a drive carrier and attempting to lock its handle next to a partially installed carrier can damage the partially installed carrier's shield spring and make it unusable.
- CAUTION:** To prevent data loss, ensure that your operating system supports hot-swap drive installation. See the documentation supplied with your operating system.
- CAUTION:** When a replacement hot swappable drive is installed and the system is powered on, the drive automatically begins to rebuild. Ensure that the replacement drive is blank or contains data that you wish to overwrite. Any data on the replacement drive is immediately lost after the drive is installed.

1. Follow the safety guidelines listed in [Safety instructions](#).
2. If applicable, [remove the drive blank](#).

### Steps

1. Press the release button on the front of the drive carrier to open the release handle.
2. Insert the drive carrier into the drive slot and slide until the drive connects with the backplane.
3. Close the drive carrier release handle to lock the drive in place.



**Figure 58. Installing a drive carrier**

### Next steps

If removed, [install the front bezel](#).

## Removing a 2.5 inch drive from the 3.5 inch drive adapter

### Prerequisites

1. Follow the safety guidelines listed in [Safety instructions](#).
2. Follow the procedure listed in [Before working inside your system](#).
3. [Remove 3.5 inch drive adapter from the 3.5 inch drive carrier](#).

**NOTE:** A 2.5 inch hot swappable drive is installed in a 3.5 inch drive adapter, which is then installed in the 3.5 inch hot swappable drive carrier.

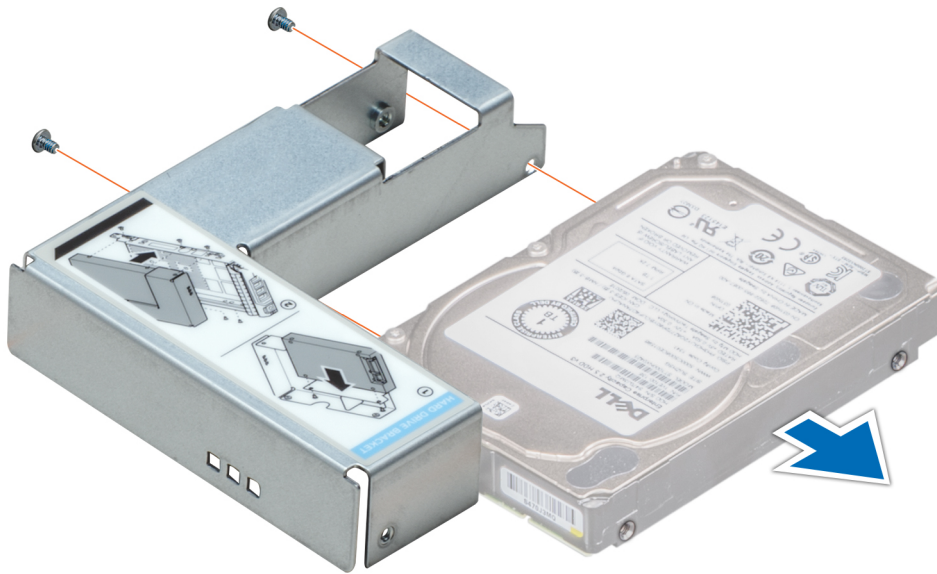
## Steps

1. Using a Phillips #2 screwdriver, remove the screws from the side of the 3.5 inch drive adapter.

**NOTE:** If the 2.5-inch drive has Torx screw, use Torx 6 screwdriver to remove the drive from a 3.5-inch drive adapter.



2. Remove the drive from the 3.5 inch drive adapter.



**Figure 59. Removing a 2.5 inch drive from the 3.5 inch drive adapter**

## Next steps

Install a 2.5 inch drive into the 3.5 inch drive adapter.

## Installing a 2.5 inch drive into the 3.5 inch drive adapter

### Prerequisites

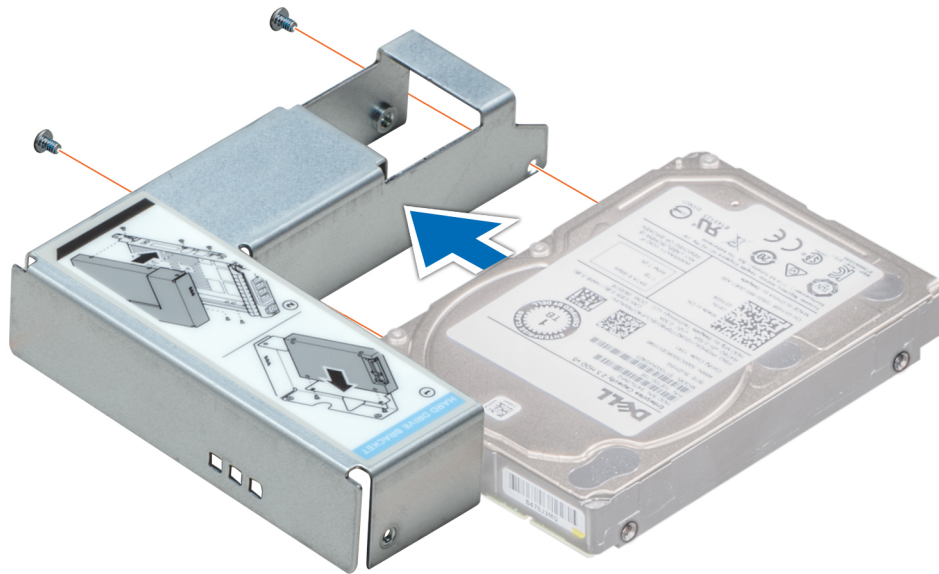
Follow the safety guidelines listed in [Safety instructions](#).

## Steps

1. Align the screw holes on the 2.5 inch drive with the screw holes on the 3.5 inch drive adapter.

2. Using a Phillips #2 screwdriver, install the screws to secure the drive to the 3.5 inch drive adapter.

**NOTE:** If the 2.5-inch drive has Torx screw, use Torx 6 screwdriver to install the drive to a 3.5-inch drive adapter.



**Figure 60. Installing a 2.5 inch drive into the 3.5 inch drive adapter**

#### Next steps

1. Install a 3.5 inch adapter into the 3.5 inch drive carrier.
2. Follow the procedure listed in [After working inside your system](#).

## Removing a 3.5 inch adapter from a 3.5 inch drive carrier

#### Prerequisites

1. Follow the safety guidelines listed in [Safety instructions](#).
2. Follow the procedure listed in [Before working inside your system](#).
3. Remove the 3.5 inch drive carrier from the system.

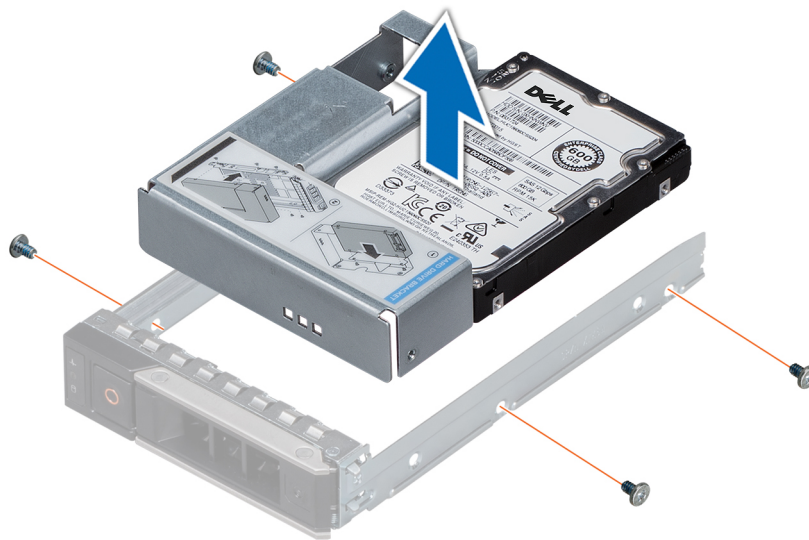
#### Steps

1. Remove the screws from the rails on the drive carrier.

**NOTE:** If the 3.5-inch drive has Torx screw, use Torx 6 screwdriver to remove the drive from a 3.5-inch drive adapter.



2. Lift the 3.5 inch drive adapter out of the drive carrier.



**Figure 61. Removing a 3.5 inch adapter from a 3.5 inch drive carrier**

### Next steps

Install a 3.5 inch adapter into a 3.5 inch drive carrier.

## Installing a 3.5 inch adapter into a 3.5 inch drive carrier

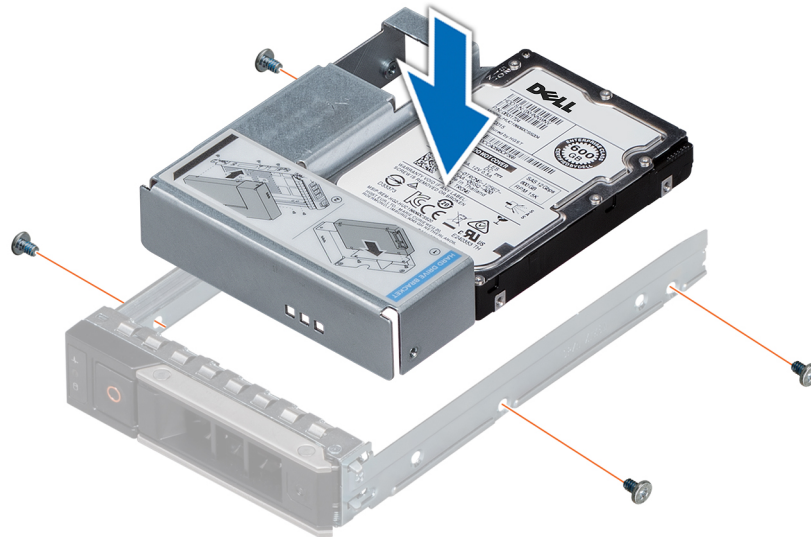
### Prerequisites

Follow the safety guidelines listed in [Safety instructions](#).

### Steps

1. Insert the 3.5 inch drive adapter into the drive carrier with the connector end of the drive toward the back of the drive carrier.
2. Align the screw holes on the drive with the holes on the drive carrier.
3. Install the screws to secure the drive to the drive carrier.

**i** **NOTE:** If the 3.5-inch drive has Torx screw, use Torx 6 screwdriver to install the drive to a 3.5-inch drive adapter.



**Figure 62. Installing a 3.5 inch adapter into a 3.5 inch drive carrier**

### Next steps

1. Install a 3.5 inch drive carrier into the system.
2. Follow the procedure listed in [After working inside your system](#).

## Removing the drive from the drive carrier

### Prerequisites

1. Follow the safety guidelines listed in [Safety instructions](#).
2. Follow the safety guidelines listed in [Before working inside your system](#).

**CAUTION:** Mixing drives from previous generations of PowerEdge servers is not supported.

### Steps

1. Using a Phillips #1 screwdriver, remove the screws from the slide rails on the drive carrier.

**NOTE:** If the hard drive or SSD carrier has Torx screw, use Torx 6 (for 2.5-inch drive) or Torx 8 (for 3.5-inch drive) screw driver to remove the drive.



2. Lift the drive out of the drive carrier.

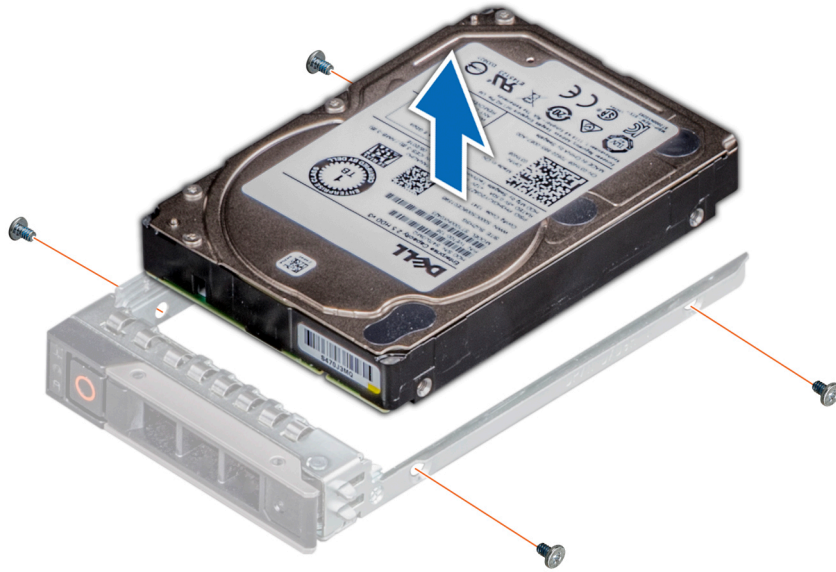


Figure 63. Removing the drive from the drive carrier

### Next steps

If applicable, [install the drive into the drive carrier](#).

## Installing a drive into the drive carrier

### Prerequisites

Follow the safety guidelines listed in [Safety instructions](#).

**CAUTION:** Mixing drive carriers from other generations of PowerEdge servers is not supported.

**NOTE:** When installing a drive into the drive carrier, ensure that the screws are torqued to 4 in-lbs.

### Steps

1. Insert the drive into the drive carrier with the connector end of the drive towards the back of the carrier.
2. Align the screw holes on the drive with the screws holes on the drive carrier.  
When aligned correctly, the back of the drive is flush with the back of the drive carrier.
3. Using a Phillips #1 screwdriver, secure the drive to the drive carrier with screws.  
**NOTE:** If the hard drive or SSD carrier has Torx screw, use Torx 6 (for 2.5-inch drive) or Torx 8 (for 3.5-inch drive) screwdriver to install the drive.





**Figure 64. Installing a drive into the drive carrier**

## Rear drive cage

### Rear drive cage details

The drive cage supports up to four 2.5 inch or two 3.5 inch drives.

### Removing rear drive cage

The procedure for removing 2.5 inch and 3.5 inch drive cages is identical.

#### Prerequisites

1. Follow the safety guidelines listed in [Safety instructions](#).
2. Follow the procedure listed in [Before working inside your system](#).
3. [Remove all drives](#).
4. Disconnect all the cables from the rear drive backplane.

#### Steps

1. Using Phillips #2 screwdriver, loosen the screws that secure the drive cage to the system.
2. Hold the drive cage by its sides, and lift it away from the system.

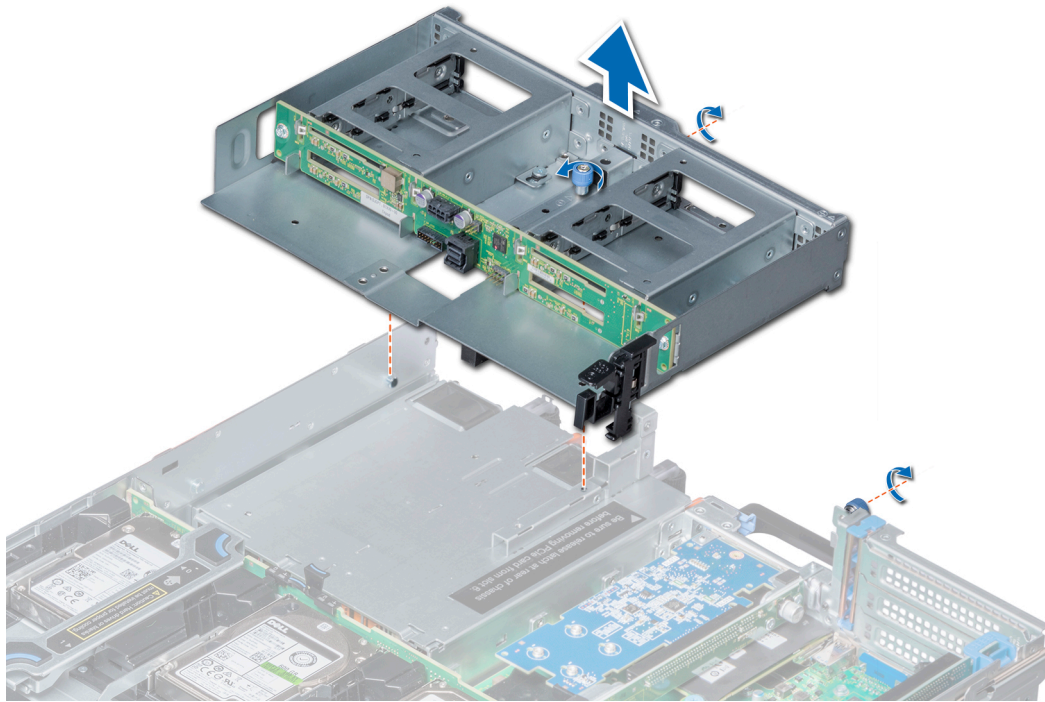


Figure 65. Removing 4 x 2.5 inch rear drive cage

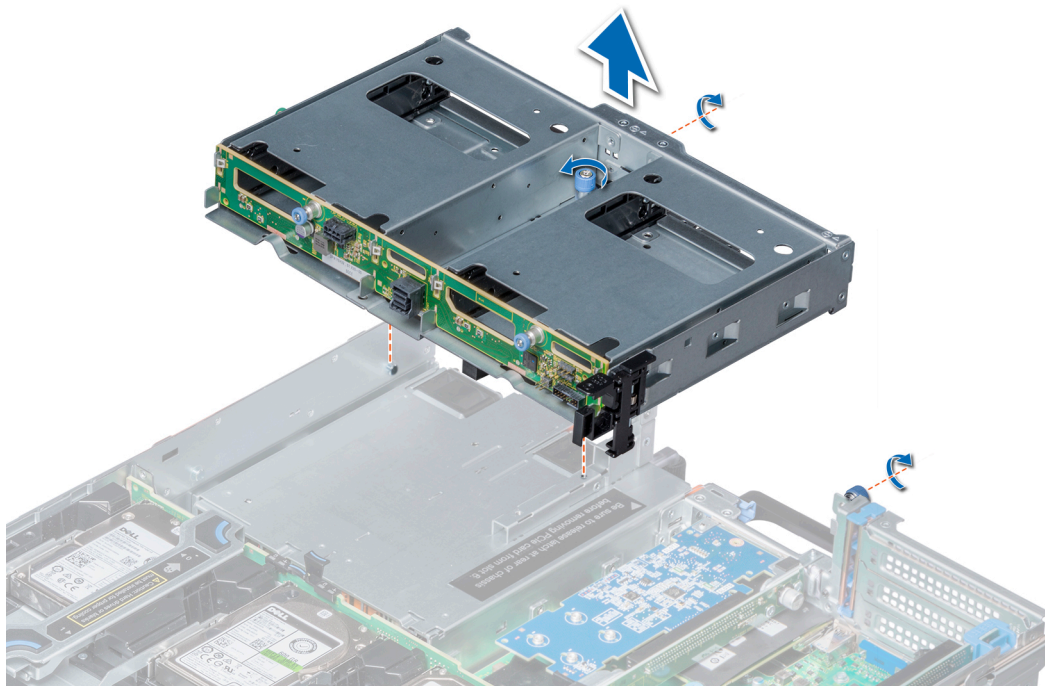


Figure 66. Removing 2 x 3.5 inch drive rear cage

### Next steps

Install the rear drive cage.

## Installing rear drive cage

The procedure for installing 2.5 inch and 3.5 inch rear drive cages is identical.

### Prerequisites

Follow the safety guidelines listed in [Safety instructions](#).

### Steps

1. Align the screws on the drive cage with the screw holes on the system.
2. Lower the drive cage into the system until it is firmly seated.
3. Using Phillips #2 screwdriver, tighten the screws to secure the drive cage to the system.

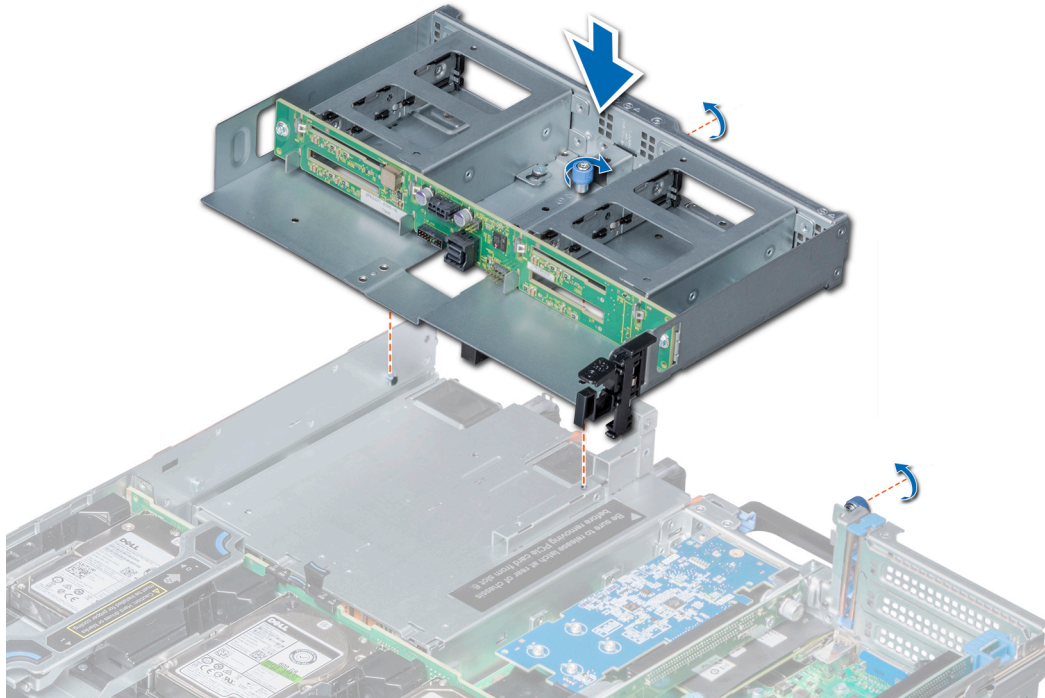
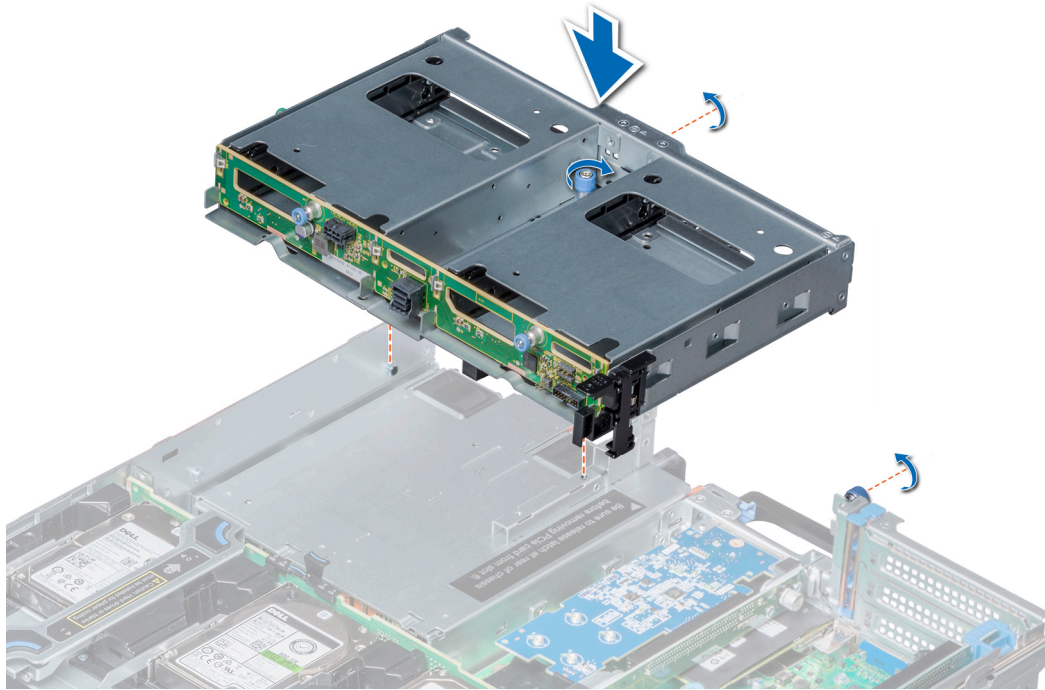


Figure 67. Installing 4 x 2.5 inch rear drive cage



**Figure 68. Installing 2 x 3.5 inch rear drive cage**

#### **Next steps**

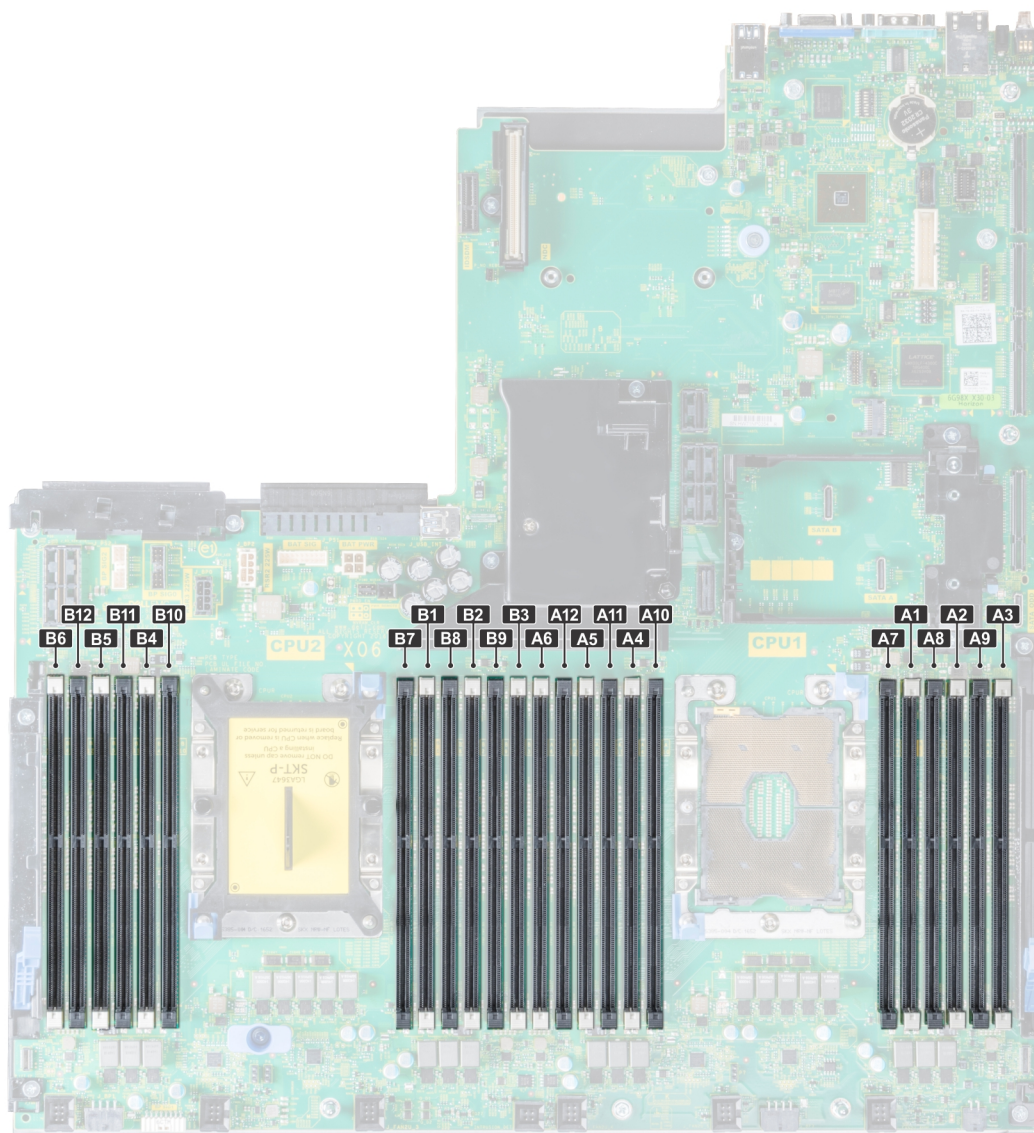
1. Connect all the cables to the rear drive backplane.
2. [Install all the drives.](#)
3. Follow the procedure listed in [After working inside your system.](#)

## **System memory**

### **System memory guidelines**

The PowerEdge systems support DDR4 Registered DIMMs (RDIMMs), Load Reduced DIMMs (LRDIMMs), Non-Volatile DIMMs (NVDIMM-Ns), and DCPMM. System memory holds the instructions that are executed by the processor.

Your system contains 24 memory sockets split into two sets of 12 sockets, one set per processor. Each 12-socket set is organized into six channels. Six memory channels are allocated to each processor. In each channel, the release tabs of the first socket are marked white, and the second socket black.



**Figure 69. Memory socket locations**

Memory channels are organized as follows:

**Table 19. Memory channels**

Processor	Channel 0	Channel 1	Channel 2	Channel 3	Channel 4	Channel 5
Processor 1	Slots A1 and A7	Slots A2 and A8	Slots A3 and A9	Slots A4 and A10	Slots A5 and A11	Slots A6 and A12
Processor 2	Slots B1 and B7	Slots B2 and B8	Slots B3 and B9	Slots B4 and B10	Slots B5 and B11	Slots B6 and B12

## General memory module installation guidelines

To ensure optimal performance of your system, observe the following general guidelines when configuring your system memory. If your system's memory configurations fail to observe these guidelines, your system might not boot, stop responding during memory configuration, or operate with reduced memory.

The memory bus may operate at frequencies 2933 MT/s, 2666 MT/s, 2400 MT/s, or 2133 MT/s depending on the following factors:

- System profile selected (for example, Performance Optimized, or Custom [can be run at high speed or lower])

- Maximum supported DIMM speed of the processors. For memory frequency of 2933 MT/s, one DIMM per channel is supported.
- Maximum supported DIMM speed of the processors.
- Maximum supported speed of the DIMMs

**i** **NOTE:** MT/s indicates DIMM speed in MegaTransfers per second.

The system supports Flexible Memory Configuration, enabling the system to be configured and run in any valid chipset architectural configuration. The following are the recommended guidelines for installing memory modules:

- All DIMMs must be DDR4.
- RDIMMs and LRDIMMs must not be mixed.
- NVDIMMs and LRDIMMs must not be mixed.
- NVDIMMs and RDIMMs can be mixed.
- 64 GB LRDIMMs that are DDP (Dual Die Package) LRDIMMs must not be mixed with 128 GB LRDIMMs that are TSV (Through Silicon Via/3DS) LRDIMMs.
- x4 and x8 DRAM based memory modules can be mixed.
- Up to two RDIMMs can be populated per channel regardless of rank count.
- Up to two LRDIMMs can be populated per channel regardless of rank count.
- A maximum of two different ranked DIMMs can be populated in a channel regardless of rank count.
- If memory modules with different speeds are installed, they will operate at the speed of the slowest installed memory module(s).
- Populate memory module sockets only if a processor is installed.
  - For single-processor systems, sockets A1 to A12 are available.
  - For dual-processor systems, sockets A1 to A12 and sockets B1 to B12 are available.
- Populate all the sockets with white release tabs first, followed by the black release tabs.
- When mixing memory modules with different capacities, populate the sockets with memory modules with the highest capacity first.

**i** **NOTE:** For example, if you want to mix 8 GB and 16 GB memory modules, populate 16 GB memory modules in the sockets with white release tabs and 8 GB memory modules in the sockets with black release tabs.

- Memory modules of different capacities can be mixed provided other memory population rules are followed.

**i** **NOTE:** For example, 8 GB and 16 GB memory modules can be mixed.

- In a dual-processor configuration, the memory configuration for each processor must be identical.

**i** **NOTE:** For example, if you populate socket A1 for processor 1, then populate socket B1 for processor 2, and so on.

- Mixing of more than two memory module capacities in one system is not supported.
- Unbalanced memory configurations will result in a performance loss so always populate memory channels identically with identical DIMMs for best performance.
- Populate six identical memory modules per processor (one DIMM per channel) at a time to maximize performance.

DIMM population update for Performance Optimized mode with quantity of 4 and 8 DIMMs per processor.

- When the DIMM quantity is 4 per processor, the population is slot 1, 2, 4, 5.
- When the DIMM quantity is 8 per processor, the population is slot 1, 2, 4, 5, 7, 8, 10, 11.

## NVDIMM-N memory module installation guidelines

The following are the recommended guidelines for installing NVDIMM-N memory modules:

- Each system supports memory configurations with 1, 2, 4, 6, or 12 NVDIMM-Ns.
- Supported configurations have dual processors and a minimum of 12x RDIMMs.
- Maximum of 12 NVDIMM-Ns can be installed in a system.
- NVDIMM-Ns or RDIMMs must not be mixed with LRDIMMs.
- DDR4 NVDIMM-Ns must be populated only on the black release tabs on processor 1 and 2.
- For systems with four processors, RDIMMs populated on processor 3 and 4 must be identical to the number of RDIMMs populated on processor 1 and 2.
- All slots on configurations 3, 6, 9, and 12 can be used, but a maximum of 12 NVDIMM-Ns can be installed in a system.

**i** **NOTE:** NVDIMM-N memory slots are not hot-pluggable.

For more information about the supported NVDIMM-N configurations, see the *NVDIMM-N User Guide* at [www.dell.com/poweredgemanuals](http://www.dell.com/poweredgemanuals).

**Table 20. Supported NVDIMM-N for dual processor configurations**

Configuration	Description	Memory population rules	
		RDIMMs	NVDIMM-N
Configuration 1	12x 16 GB RDIMMs, 1x NVDIMM-N	Processor1 {A1, 2, 3, 4, 5, 6} Processor2 {B1, 2, 3, 4, 5, 6}	Processor1 {A7}
Configuration 2	12x 32 GB RDIMMs, 1x NVDIMM-N	Same for all 12x RDIMM configurations. See Configuration 1.	Processor1 {A7}
Configuration 3	23x 32 GB RDIMMs, 1x NVDIMM-N	Processor1 {A1, 2, 3, 4, 5, 6, 7, 8, 9, 10, 11, 12} Processor2 {B1, 2, 3, 4, 5, 6, 7, 8, 9, 10, 11}	Processor2 {B12}
Configuration 4	12x 16 GB RDIMMs, 2x NVDIMM-Ns	Same for all 12x RDIMM configurations. See Configuration 1.	Processor1 {A7} Processor2 {B7}
Configuration 5	12x 32 GB RDIMMs, 2x NVDIMM-Ns	Same for all 12x RDIMM configurations. See Configuration 1.	Processor1 {A7} Processor2 {B7}
Configuration 6	22x 32 GB RDIMMs, 2x NVDIMM-Ns	Processor1 {A1, 2, 3, 4, 5, 6, 7, 8, 9, 10, 11} Processor2 {B1, 2, 3, 4, 5, 6, 7, 8, 9, 10, 11}	Processor1 {A12} Processor2 {B12}
Configuration 7	12x 16 GB RDIMMs, 4x NVDIMM-Ns	Same for all 12x RDIMM configurations. See Configuration 1.	Processor1 {A7, A8} Processor2 {B7, B8}
Configuration 8	22x 32 GB RDIMMs, 4x NVDIMM-Ns	Same for all 12x RDIMM configurations. See Configuration 1.	Processor1 {A7, A8} Processor2 {B7, B8}
Configuration 9	20x 32 GB RDIMMs, 4x NVDIMM-Ns	Processor1 {A1, 2, 3, 4, 5, 6, 7, 8, 9, 10} Processor2 {B1, 2, 3, 4, 5, 6, 7, 8, 9, 10}	Processor1 {A11, 12} Processor2 {B11, 12}
Configuration 10	12x 16 GB RDIMMs, 6x NVDIMM-Ns	Same for all 12x RDIMM configurations. See Configuration 1.	Processor1 {A7, 8, 9} Processor2 {B7, 8, 9}
Configuration 11	12x 32 GB RDIMMs, 6x NVDIMM-Ns	Same for all 12x RDIMM configurations. See Configuration 1.	Processor1 {A7, 8, 9} Processor2 {B7, 8, 9}
Configuration 12	18x 32 GB RDIMMs, 6x NVDIMM-Ns	Processor1 {1, 2, 3, 4, 5, 6, 7, 8, 9} Processor2 {1, 2, 3, 4, 5, 6, 7, 8, 9}	Processor1 {A10, 11, 12} Processor2 {B10, 11, 12}
Configuration 13	12x 16 GB RDIMMs, 12x NVDIMM-Ns	Same for all 12x RDIMM configurations. See Configuration 1.	Processor1 {A7, 8, 9, 10, 11, 12} Processor2 {B7, 8, 9, 10, 11, 12}

**Table 20. Supported NVDIMM-N for dual processor configurations (continued)**

Configuration	Description	Memory population rules	
		RDIMMs	NVDIMM-N
Configuration 14	12x 32 GB RDIMMs, 12x NVDIMM-Ns	Same for all 12x RDIMM configurations. See Configuration 1.	Processor1 {A7, 8, 9, 10, 11, 12} Processor2 {B7, 8, 9, 10, 11, 12}

**Table 21. Supported NVDIMM-N for quad processor configurations**

Configuration	Description	Memory population rules	
		RDIMMs	NVDIMM-N
Configuration 1	24x 16 GB RDIMMs, 1x NVDIMM-N	Processor1 {A1, 2, 3, 4, 5, 6}, Processor2 {B1, 2, 3, 4, 5, 6}, Processor3 {C1, 2, 3, 4, 5, 6} Processor4 {D1, 2, 3, 4, 5, 6}	Processor1 {A7}
Configuration 2	24x 32 GB RDIMMs, 1x NVDIMM-N	Same for all 24x RDIMM configurations. See Configuration 1.	Processor1 {A7}
Configuration 3	47x 32 GB RDIMMs, 1x NVDIMM-N	Processor1 {A1, 2, 3, 4, 5, 6, 7, 8, 9, 10, 11, 12} , Processor2 {B1, 2, 3, 4, 5, 6, 7, 8, 9, 10, 11} , Processor3 {C1, 2, 3, 4, 5, 6, 7, 8, 9, 10, 11, 12} Processor 4 {D1, 2, 3, 4, 5, 6, 7, 8, 9, 10, 11, 12}	Processor2 {B12}
Configuration 4	24x 16 GB RDIMMs, 2x NVDIMM-Ns	Processor1 {A1, 2, 3, 4, 5, 6}, Processor2 {B1, 2, 3, 4, 5, 6} Processor3 {C1, 2, 3, 4, 5, 6} Processor4 {D1, 2, 3, 4, 5, 6}	Processor1 {A7}, Processor2 {B7}
Configuration 5	24x 32 GB RDIMMs, 2x NVDIMM-Ns	Processor1 {A1, 2, 3, 4, 5, 6}, Processor2 {B1, 2, 3, 4, 5, 6}, Processor3 {C1, 2, 3, 4, 5, 6} Processor4 {D1, 2, 3, 4, 5, 6}	Processor1 {A7}, Processor2 {B7}
Configuration 6	46x 32 GB RDIMMs, 2x NVDIMM-Ns	Processor1 {A1, 2, 3, 4, 5, 6, 7, 8, 9, 10, 11}, Processor2 {B1, 2, 3, 4, 5, 6, 7, 8, 9, 10, 11} , Processor3 {C1, 2, 3, 4, 5, 6, 7, 8, 9, 10, 11, 12} Processor 4 {D1, 2, 3, 4, 5, 6, 7, 8, 9, 10, 11, 12}	Processor1 {A12}, Processor2 {B12}
Configuration 7	24x 16 GB RDIMMs, 4x NVDIMM-Ns	Processor1 {A1, 2, 3, 4, 5, 6}, Processor2 {B1, 2, 3, 4, 5, 6}, Processor3 {C1, 2, 3, 4, 5, 6} Processor4 {D1, 2, 3, 4, 5, 6}	Processor1 {A7,8}, Processor2 {B7,8}
Configuration 8	24x 32 GB RDIMMs, 4x NVDIMMs	Processor1 {A1, 2, 3, 4, 5, 6}, Processor2 {B1, 2, 3, 4, 5, 6},	Processor1 {A7,8}, Processor2 {B7,8}



**Table 21. Supported NVDIMM-N for quad processor configurations (continued)**

Configuration	Description	Memory population rules	
		RDIMMs	NVDIMM-N
		Processor3 {C1, 2, 3, 4, 5, 6} Processor4 {D1, 2, 3, 4, 5, 6}	
Configuration 9	44x 32 GB RDIMMs, 4x NVDIMM-Ns	Processor1 {A1, 2, 3, 4, 5, 6, 7, 8, 9, 10}, Processor2 {B1, 2, 3, 4, 5, 6, 7, 8, 9, 10}, Processor3 {C1, 2, 3, 4, 5, 6, 7, 8, 9, 10, 11, 12} Processor4 {D1, 2, 3, 4, 5, 6, 7, 8, 9, 10, 11, 12}	Processor1 {A11, 12}, Processor2 {B11, 12}
Configuration 10	24x 16 GB RDIMMs, 6x NVDIMM-Ns	Processor1 {A1, 2, 3, 4, 5, 6}, Processor2 {B1, 2, 3, 4, 5, 6} Processor3 {C1, 2, 3, 4, 5, 6} Processor4 {D1, 2, 3, 4, 5, 6}	Processor1 {A7, 8, 9} Processor2 {B7, 8, 9}
Configuration 11	24x 32 GB RDIMMs, 6x NVDIMM-Ns	Processor1 {A1, 2, 3, 4, 5, 6}, Processor2 {B1, 2, 3, 4, 5, 6}, Processor3 {C1, 2, 3, 4, 5, 6} Processor4 {D1, 2, 3, 4, 5, 6}	Processor1 {A7, 8, 9} Processor2 {B7, 8, 9}
Configuration 12	42x 32 GB RDIMMs, 6x NVDIMM-Ns	Processor1 {A1, 2, 3, 4, 5, 6, 7, 8, 9}, Processor2 {B1, 2, 3, 4, 5, 6, 7, 8, 9} Processor3 {C1, 2, 3, 4, 5, 6, 7, 8, 9, 10, 11, 12} Processor4 {D1, 2, 3, 4, 5, 6, 7, 8, 9, 10, 11, 12}	Processor1 {A10,11,12} Processor2 {B10, 11, 12}
Configuration 13	24x 16 GB RDIMMs, 12x NVDIMM-Ns	Processor1 {A1, 2, 3, 4, 5, 6}, Processor2 {B1, 2, 3, 4, 5, 6}, Processor3 {C1, 2, 3, 4, 5, 6} Processor4 {D1, 2, 3, 4, 5, 6}	Processor1 {A7, 8, 9, 10, 11, 12}, Processor2 {B7, 8, 9, 10, 11, 12}
Configuration 14	24x 32 GB RDIMMs, 12x NVDIMM-Ns	Processor1 {A1, 2, 3, 4, 5, 6}, Processor2 {B1, 2, 3, 4, 5, 6}, Processor3 {C1, 2, 3, 4, 5, 6} Processor4 {D1, 2, 3, 4, 5, 6}	Processor1 {A7, 8, 9, 10, 11, 12}, Processor2 {B7, 8, 9, 10, 11, 12}
Configuration 15	36x 32 GB RDIMMs, 12x NVDIMM-Ns	Processor1 {A1, 2, 3, 4, 5, 6}, Processor2 {B1, 2, 3, 4, 5, 6}, Processor3 {C1, 2, 3, 4, 5, 6, 7, 8, 9, 10, 11, 12} Processor 4 {D1, 2, 3, 4, 5, 6, 7, 8, 9, 10, 11, 12}	Processor1 {A7, 8, 9, 10, 11, 12}, Processor2 {B7, 8, 9, 10, 11, 12}

## PMem installation guidelines

The following are the recommended guidelines for installing data center persistent memory module (PMem) memory modules:

- Each system supports maximum of one PMem memory module per channel.

**NOTE:** If two different PMem capacities are mixed, an F1/F2 warning is displayed as the configuration is not supported.

- PMem can be mixed with RDIMM, LRDIMM, and 3DS LRDIMM.
- Mixing of DDR4 DIMM types (RDIMM, LRDIMM, and 3DS LRDIMM), within channels, for Integrated Memory Controller (iMC), or across sockets are not supported.
- Mixing of PMem operating modes (App Direct, Memory Mode) is not supported.
- If only one DIMM is populated on a channel, it should always go to the first slot in that channel (white slot).
- If a PMem and a DDR4 DIMM are populated on the same channel, always plug PMem on second slot (black slot).
- If the PMem is configured in Memory Mode, the recommended DDR4 to PMem capacity ratio is 1:4 to 1:16 per iMC.
- PMems' cannot be mixed with other PMems capacities or NVDIMMs.
- Mixing different capacities of RDIMMs and LRDIMMs are not allowed when PMem is installed.
- PMems of different capacities are not allowed.

For more information about the supported PMem configurations, see the *Dell EMC PMem User 's Guide* at [https://www.dell.com/support/home/products/server\\_int/server\\_int\\_poweredge](https://www.dell.com/support/home/products/server_int/server_int_poweredge).

**Table 22. 2 socket PMem configurations**

No. of CPUs in the Server	PMem Population	DRAM Population	DRAM Capacity (GB)	PMem Capacity (GB)	Operating system Memory in Memory Mode (GB)	Total Memory (GB)	Total Memory per CPU (GB)	Ratio DRAM to Optane Memory	Requires an M or L CPU	Supported in App Direct Mode	Supported in Memory Mode
2	128 GB x 1	16 GB x 12	192	128	N/A	320	160	1 : 0.7	No	Yes	No
2	128 GB x 2	16 GB x 12	192	256	N/A	448	224	1 : 1.3	No	Yes	No
2	128 GB x 4	16 GB x 8	128	512	512	640	320	1 : 4	No	Yes	Yes
2	128 GB x 4	16 GB x 12	192	512	N/A	704	352	1 : 2.7	No	Yes	No
2	128 GB x 8	16 GB x 12	192	1,024	1,024	1,216	608	1 : 5.3	No	Yes	Yes
2	128 GB x 12	16 GB x 12	192	1,536	1,536	1,728	864	1 : 8	No	Yes	Yes
2	128 GB x 1	32 GB x 12	384	128	N/A	512	256	1 : 0.3	No	Yes	No
2	128 GB x 2	32 GB x 12	384	256	N/A	640	320	1 : 0.7	No	Yes	No
2	128 GB x 4	32 GB x 12	384	512	N/A	896	448	1 : 1.3	No	Yes	No
2	128 GB x 8	32 GB x 12	384	1,024	N/A	1,408	704	1 : 2.7	No	Yes	No
2	128 GB x 12	32 GB x 12	384	1,536	1,536	1,920	960	1 : 4	No	Yes	Yes
2	128 GB x 4	64 GB x 12	768	512	N/A	1,280	640	1 : 0.7	No	Yes	No
2	128 GB x 8	64 GB x 12	768	1,024	N/A	1,792	896	1 : 1.3	No	Yes	No
2	128 GB x 12	64 GB x 12	768	1,536	N/A	2,304	1,152	1 : 2	L SKU	Yes	No
2	128 GB x 12	128 GB x 12	1,536	1,536	N/A	3,072	1,536	1 : 1	L SKU	Yes	No
2	512 GB x 8	32 GB x 12	384	4,096	4,096	4,480	2,240	1 : 10.7	L SKU	Yes	Yes

**Table 22. 2 socket PMem configurations (continued)**

No. of CPUs in the Server	PMem Population	DRAM Population	DRAM Capacity (GB)	PMem Capacity (GB)	Operating system Memory in Memory Mode (GB)	Total Memory (GB)	Total Memory per CPU (GB)	Ratio DRAM to Optane Memory	Requires an M or L CPU	Supported in App Direct Mode	Supported in Memory Mode
2	512 GB x 12	32 GB x 12	384	6,144	6,144	6,528	3,264	1 : 16	L SKU	Yes	Yes
2	512 GB x 8	64 GB x 12	768	4,096	4,096	4,864	2,432	1 : 5.3	L SKU	Yes	Yes
2	512 GB x 12	64 GB x 12	768	6,144	6,144	6,912	3,456	1 : 8	L SKU	Yes	Yes
2	512 GB x 12	128 GB x 12	1,536	6,144	6,144	7,680	3,840	1 : 4	L SKU	Yes	Yes
2	256 GB x 8	16 GB x 12	192	2,048	2,048	2,240	1,120	1 : 10.7	L SKU	Yes	Yes
2	256 GB x 8	32 GB x 12	384	2,048	2,048	2,432	1,216	1 : 5.3	L SKU	Yes	Yes
2	256 GB x 12	32 GB x 12	384	3,072	3,072	3,456	1,728	1 : 8	L SKU	Yes	Yes
2	256 GB x 8	64 GB x 12	768	2,048	N/A	2,816	1,408	1 : 2.7	L SKU	Yes	No
2	256 GB x 12	64 GB x 12	768	3,072	3,072	3,840	1,920	1 : 4	L SKU	Yes	Yes
2	256 GB x 12	128 GB x 12	1,536	3,072	N/A	4,608	2,304	1 : 2	L SKU	Yes	No

**Table 23. 4 socket PMem configurations**

No. of CPUs in the Server	PMem Population	DRAM Population	DRAM Capacity (GB)	PMem Capacity (GB)	Operating system Memory in Memory Mode (GB)	Total Memory (GB)	Total Memory per CPU (GB)	Ratio DRAM to Optane Memory	Requires an M or L CPU	Supported in App Direct Mode	Supported in Memory Mode
4	128 GB x 16	16 GB x 24	384	2,048	2,048	2,432	608	1 : 5.3	No	Yes	Yes
4	128 GB x 24	16 GB x 24	384	3,072	3,072	3,456	864	1 : 8	No	Yes	Yes
4	128 GB x 16	32 GB x 24	768	2,048	N/A	2,816	704	1 : 2.7	No	Yes	No
4	128 GB x 24	32 GB x 24	768	3,072	3,072	3,840	960	1 : 4	No	Yes	Yes
4	128 GB x 24	64 GB x 24	1,536	3,072	N/A	4,608	1,152	1 : 2	L SKU	Yes	No
4	128 GB x 24	128 GB x 24	3,072	3,072	N/A	6,144	1,536	1 : 1	L SKU	Yes	No
4	512 GB x 16	32 GB x 24	768	8,192	8,192	8,960	2,240	1 : 10.7	L SKU	Yes	Yes

**Table 23. 4 socket PMem configurations (continued)**

No. of CPUs in the Server	PMem Population	DRAM Population	DRAM Capacity (GB)	PMem Capacity (GB)	Operating system Memory in Memory Mode (GB)	Total Memory (GB)	Total Memory per CPU (GB)	Ratio DRAM to Optane Memory	Requires an M or L CPU	Supported in App Direct Mode	Supported in Memory Mode
4	512 GB x 24	32 GB x 24	768	12,288	12,288	13,056	3,264	1 : 16	L SKU	Yes	Yes
4	512 GB x 16	64 GB x 24	1,536	8,192	8,192	9,728	2,432	1 : 5.3	L SKU	Yes	Yes
4	512 GB x 24	64 GB x 24	1,536	12,288	12,288	13,824	3,456	1 : 8	L SKU	Yes	Yes
4	512 GB x 24	128 GB x 24	3,072	12,288	12,288	15,360	3,840	1 : 4	L SKU	Yes	Yes
4	256 GB x 16	16 GB x 24	384	4,096	4,096	4,480	1,120	1 : 10.7	L SKU	Yes	Yes
4	256 GB x 24	16 GB x 24	384	6,144	6,144	6,528	1,632	1 : 16	L SKU	Yes	Yes
4	256 GB x 16	32 GB x 24	768	4,096	4,096	4,864	1,216	1 : 5.3	L SKU	Yes	Yes
4	256 GB x 24	32 GB x 24	768	6,144	6,144	6,912	1,728	1 : 8	L SKU	Yes	Yes
4	256 GB x 16	64 GB x 24	1,536	4,096	N/A	5,632	1,408	1 : 2.7	L SKU	Yes	No
4	256 GB x 24	64 GB x 24	1,536	6,144	6,144	7,680	1,920	1 : 4	L SKU	Yes	Yes
4	256 GB x 24	128 GB x 24	3,072	6,144	N/A	9,216	2,304	1 : 2	L SKU	Yes	No

**NOTE:** There are limited configurations available for Dual Socket Servers with only one CPU populated.

**NOTE:** PMem is supported on systems with 1600W and 2400W PSU configuration.

- NOTE:**
- High Performance Fan is required with PMem.
  - GPU and FGPA cards are not supported.
  - Mid or rear storage is not supported.
  - Front 12 x 3.5-inch drives are not supported.





## Mode-specific guidelines

The configurations allowed depend on the memory mode selected in the System BIOS.

**Table 24. Memory operating modes**



Memory Operating Mode	Description
<b>Optimizer Mode</b>	The <b>Optimizer Mode</b> if enabled, the DRAM controllers operate independently in the 64-bit mode and provide optimized memory performance. <b>NOTE:</b> PMem supports only Optimizer mode.

**Table 24. Memory operating modes (continued)**

Memory Operating Mode	Description
<b>Mirror Mode</b>	<p>The <b>Mirror Mode</b> if enabled, the system maintains two identical copies of data in memory, and the total available system memory is one half of the total installed physical memory. Half of the installed memory is used to mirror the active memory modules. This feature provides maximum reliability and enables the system to continue running even during a catastrophic memory failure by switching over to the mirrored copy. The installation guidelines to enable Mirror Mode require that the memory modules be identical in size, speed, and technology, and they must be populated in sets of 6 per processor.</p>
<b>Single Rank Spare Mode</b>	<p><b>Single Rank Spare Mode</b> allocates one rank per channel as a spare. If excessive correctable errors occur in a rank or channel, while the operating system is running, they are moved to the spare area to prevent errors from causing an uncorrectable failure. Requires two or more ranks to be populated in each channel.</p>
<b>Multi Rank Spare Mode</b>	<p><b>Multi Rank Spare Mode</b> allocates two ranks per channel as a spare. If excessive correctable errors occur in a rank or channel, while the operating system is running, they are moved to the spare area to prevent errors from causing an uncorrectable failure. Requires three or more ranks to be populated in each channel.</p> <p>With single rank memory sparing enabled, the system memory available to the operating system is reduced by one rank per channel.</p> <p>For example, in a dual-processor configuration with 24x 16 GB dual-rank memory modules, the available system memory is: <math>3/4</math> (ranks/channel) <math>\times</math> 24 (memory modules) <math>\times</math> 16 GB = 288 GB, and not 24 (memory modules) <math>\times</math> 16 GB = 384 GB. For multi rank sparing, the multiplier changes to <math>1/2</math> (ranks/channel).</p> <p> <b>NOTE:</b> To use memory sparing, this feature must be enabled in the BIOS menu of System Setup.</p> <p> <b>NOTE:</b> Memory sparing does not offer protection against a multi-bit uncorrectable error.</p>
<b>Dell Fault Resilient Mode</b>	<p>The <b>Dell Fault Resilient Mode</b> if enabled, the BIOS creates an area of memory that is fault resilient. This mode can be used by an OS that supports the feature to load critical applications or enables the OS kernel to maximize system availability.</p> <p> <b>NOTE:</b> This feature is only supported in Gold and Platinum Intel processors.</p> <p> <b>NOTE:</b> Memory configuration has to be of same size DIMM, speed, and rank.</p>

## Optimizer Mode

This mode supports Single Device Data Correction (SDDC) only for memory modules that use x4 device width. It does not impose any specific slot population requirements.

- Dual processor: Populate the slots in round robin sequence starting with processor 1.
  -  **NOTE:** Processor 1 and processor 2 population should match.
- Quad processor: Populate the slots in round robin sequence starting with processor 1.
  -  **NOTE:** Processor 1, processor 2, processor 3, and processor 4 population should match.

# Removing a memory module

The procedure for removing a DIMM module and an NVDIMM-N module is identical.

## Prerequisites

1. Follow the safety guidelines listed in [Safety instructions](#).
2. Follow the procedure listed in [Before working inside your system](#).
3. If applicable, [remove the air shroud](#)
4. If applicable, [remove the mid drive tray](#).

**⚠ WARNING:** Allow the memory modules to cool after you power off the system. Handle the memory modules by the card edges and avoid touching the components or metallic contacts on the memory module.

**⚠ CAUTION:** To ensure proper system cooling in configurations with mid drive tray, memory module blanks must be installed in any memory socket that is not occupied. Remove memory module blanks only if you intend to install memory modules in those sockets.

**ⓘ NOTE:** You must follow the thermal restriction while using DIMM blank. For information about thermal restriction, see the Thermal restrictions section.

## Steps

1. Locate the appropriate memory module socket.

**⚠ CAUTION:** Handle each memory module only by the card edges, ensuring not to touch the middle of the memory module or metallic contacts.

2. Push the ejectors outward on both ends of the memory module socket to release the memory module from the socket.
3. Lift and remove the memory module from the system.

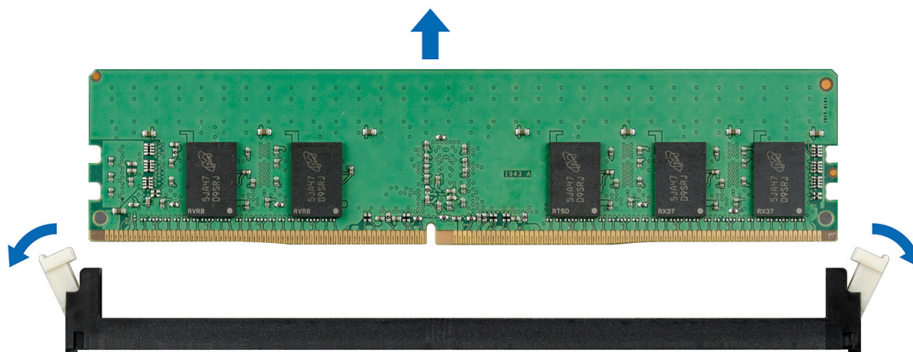


Figure 70. Removing a memory module

## Next steps

1. [Install the memory module](#).
2. For configurations with mid drive tray, if you are removing the memory module permanently, install a memory module blank. The procedure to install a memory module blank is similar to that of the memory module.

**ⓘ NOTE:** For single processor systems, install processor/DIMM blank on CPU2 socket.

**ⓘ NOTE:** To ensure proper cooling, DIMM blank must be installed for systems with mid drive tray configuration.


# Installing a memory module


The procedure for installing a DIMM module and an NVDIMM-N module is identical.

## Prerequisites

Follow the safety guidelines listed in [Safety instructions](#).

 **CAUTION:** Ensure that you install the NVDIMM-N battery if you are using NVDIMM-N.


 **CAUTION:** To prevent data loss and potential damage to your system, ensure that your system, LEDs on system, LEDs on NVDIMM-N and LEDs on NVDIMM-N battery are turned off before installing the NVDIMM-N battery.


 **CAUTION:** To ensure proper system cooling in configurations with mid drive tray, memory module blanks must be installed in any memory socket that is not occupied. Remove memory module blanks only if you intend to install memory modules in those sockets.

 **NOTE:** You must follow the thermal restriction while using DIMM blank. For information about thermal restriction, see [www.dell.com/poweredgemanuals](http://www.dell.com/poweredgemanuals).

## Steps


1. Locate the appropriate memory module socket.


 **CAUTION:** Handle each memory module only by the card edges, ensuring not to touch the middle of the memory module or metallic contacts.

 **CAUTION:** To prevent damage to the memory module or the memory module socket during installation, do not bend or flex the memory module. You must insert both ends of the memory module simultaneously.

2. Open the ejectors on the memory module socket outward to allow the memory module to be inserted into the socket.

3. Align the edge connector of the memory module with the alignment key of the memory module socket, and insert the memory module in the socket.

 **CAUTION:** Do not apply pressure at the center of the memory module; apply pressure at both ends of the memory module evenly.

 **NOTE:** The memory module socket has an alignment key that enables you to install the memory module in the socket in only one orientation.

4. Press the memory module with your thumbs until the socket levers firmly click into place.

## Next steps

1. [Install the air shroud](#)

2. If applicable, [install the mid drive tray](#).

3. Follow the procedure listed in [After working inside your system](#).

4. To verify if the memory module has been installed properly, press F2 and navigate to **System Setup Main Menu > System BIOS > Memory Settings**. In the **Memory Settings** screen, the System Memory Size must reflect the updated capacity of the installed memory.

5. If the value is incorrect, one or more of the memory modules may not be installed properly. Ensure that the memory module is firmly seated in the memory module socket.

6. Run the system memory test in system diagnostics.

# Processors and heat sinks

## Removing a processor and heat sink module

### Prerequisites

**⚠ WARNING:** The heat sink may be hot to touch for some time after the system is powered down. Allow the heat sink to cool before removing it.

1. Follow the safety guidelines listed in [Safety instructions](#).
2. Follow the procedure listed in [Before working inside your system](#).
3. If applicable, [remove the air shroud](#)
4. If applicable, [remove the mid drive tray](#).
5. If applicable, close the PCIe card holder latch on the air shroud to release the full length card.

### Steps

1. Using a Torx #T30 screwdriver, loosen the screws on the heat sink in the order below:
  - a. Loosen the first screw three turns.
  - b. Loosen the second screw completely.
  - c. Return to the first screw and loosen it completely.

**i NOTE:** It is normal for the heat sink to slip off the blue retention clips when the screws are partially loosened, continue to loosen the screw(s).

2. Pushing both blue retention clips simultaneously, lift the processor and heat sink module (PHM) out of the system.
3. Set the PHM aside with the processor side facing up.

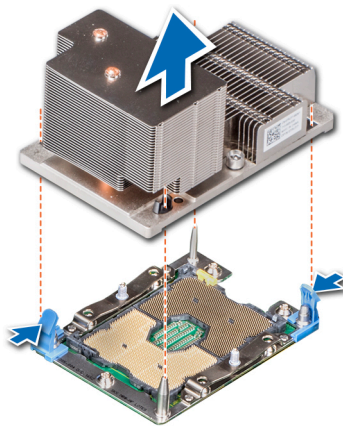
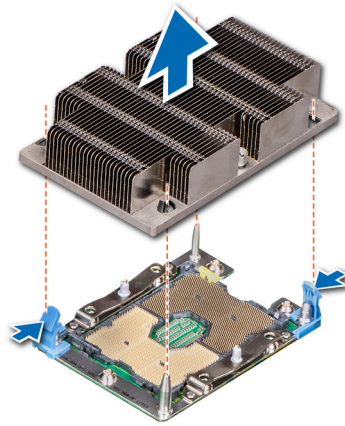


Figure 71. Removing a processor and heat sink module (2U)





**Figure 72. Removing a processor and heat sink module (1U)**

### Next steps

Install the processor and heat sink module.

## Removing the processor from the processor and heat sink module

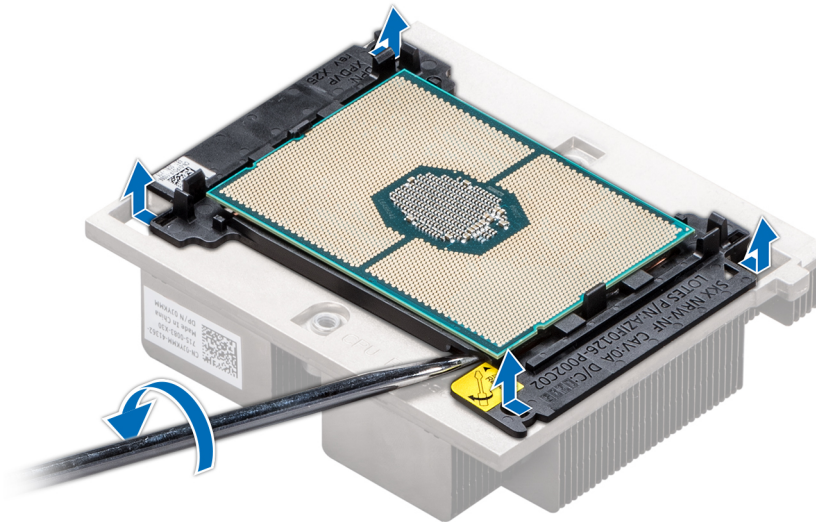
### Prerequisites

**i** **NOTE:** Only remove the processor from the processor and heat sink module if you are replacing the processor or heat sink. This procedure is not required when replacing a system board.

1. Follow the safety guidelines listed in [Safety instructions](#).
2. Follow the procedure listed in [Before working inside your system](#).
3. [Remove the processor and heat sink module](#).

### Steps

1. Place the heat sink with the processor side facing up.
2. Insert a flat blade screwdriver into the release slot marked with a yellow label. Twist (do not pry) the screwdriver to break the thermal paste seal.
3. Push the retaining clips on the processor bracket to unlock the bracket from the heat sink.



**Figure 73. Loosening the processor bracket**

4. Lift the bracket and the processor away from the heat sink, and place the processor connector side down on the processor tray.
5. Flex the outer edges of the bracket to release the bracket from the processor.

**NOTE:** Ensure that the processor and the bracket are placed in the tray after you remove the heat sink.



**Figure 74. Removing the processor bracket**

### Next steps

Install the processor into a processor and heat sink module.

## Installing the processor into a processor and heat sink module

### Prerequisites

Follow the safety guidelines listed in [Safety instructions](#).

## Steps

1. Place the processor in the processor tray.

**i** **NOTE:** Ensure that the pin 1 indicator on the processor tray is aligned with the pin 1 indicator on the processor.

2. Flex the outer edges of the bracket around the processor ensuring that the processor is locked into the clips on the bracket.

**i** **NOTE:** Ensure that the pin 1 indicator on the bracket is aligned with the pin 1 indicator on the processor before placing the bracket on the processor.

**i** **NOTE:** Ensure that the processor and the bracket are placed in the tray before you install the heat sink.

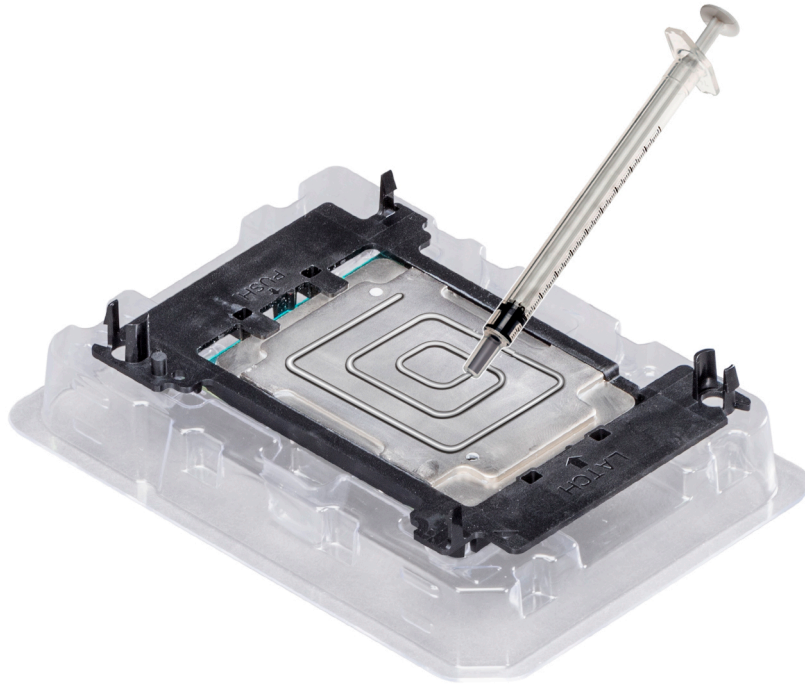


**Figure 75. Installing the processor bracket**

3. If you are using an existing heat sink, remove the thermal grease from the heat sink by using a clean lint-free cloth.
4. Use the thermal grease syringe included with your processor kit to apply the grease in a quadrilateral design on the top of the processor.

**⚠ CAUTION:** Applying too much thermal grease can result in excess grease coming in contact with and contaminating the processor socket.

**i** **NOTE:** The thermal grease syringe is intended for single use only. Dispose the syringe after you use it.



**Figure 76. Applying thermal grease on top of the processor**

5. Place the heat sink on the processor and push down on the base of the heat sink until the bracket locks onto the heat sink.

**i NOTE:**

- Ensure that the two guide pin holes on the bracket match the guide holes on the heat sink.
- Do not press on the heat sink fins.
- Ensure that the pin 1 indicator on the heat sink is aligned with the pin 1 indicator on the bracket before placing the heat sink onto the processor and bracket.

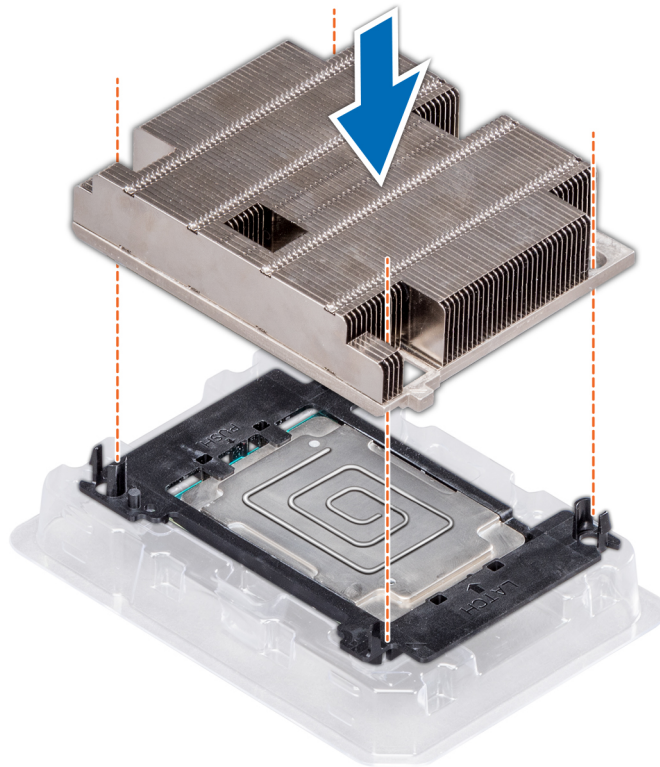


Figure 77. Installing the heat sink onto the processor

### Next steps

Install the processor and heat sink module.

## Installing a processor and heat sink module

### Prerequisites

**CAUTION:** Never remove the heat sink from a processor unless you intend to replace the processor. The heat sink is necessary to maintain proper thermal conditions.

**WARNING:** The heat sink may be hot to touch for some time after the system has been powered down. Allow the heat sink to cool before removing it.

1. Follow the safety guidelines listed in [Safety instructions](#).
2. If installed, remove the processor blank and CPU dust cover.

The procedure to remove the processor/DIMM blank is similar to that of the memory module.

### Steps

1. Align the pin 1 indicator of the heat sink to the system board and then place the processor and heat sink module (PHM) on the processor socket.

**CAUTION:** To avoid damaging the fins on the heat sink, do not press down on the heat sink fins.

**NOTE:** Ensure that the PHM is held parallel to the system board to prevent damaging the components.

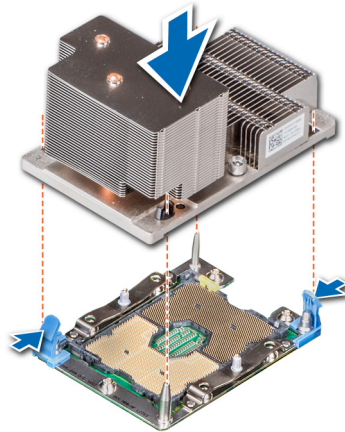
2. Push the blue retention clips inward to allow the heat sink to drop into place.
3. Using the Torx #T30 screwdriver, tighten the screws on the heat sink in the order below:
  - a. Partially tighten the first screw (approximately 3 turns).
  - b. Tighten the second screw completely.

c. Return to the first screw and tighten it completely.

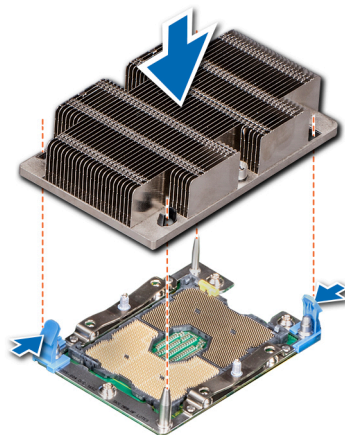
If the PHM slips off the blue retention clips when the screws are partially tightened, follow these steps to secure the PHM:

- a. Loosen both the heat sink screws completely.
- b. Lower the PHM on to the blue retention clips, following the procedure described in step 2.
- c. Secure the PHM to the system board, following the replacement instructions listed in this step above. 4.

**i** **NOTE:** The processor and heat sink module retention screws should not be tightened to more than 0.13 kgf-m (1.35 N.m or 12 in-lbf).



**Figure 78. Installing the processor and heat sink module (2U)**



**Figure 79. Installing a processor and heat sink module (1U)**

#### Next steps

1. If applicable, [install the mid drive tray](#).
2. If applicable, [install the air shroud](#).
- i** **NOTE:** If applicable, open the PCIe card holder latch on the air shroud to install the full length card.
3. Follow the procedure listed in [After working inside your system](#).

# Expansion cards and expansion card risers

## Expansion card installation guidelines

**NOTE:** A System Event Log (SEL) event is logged if an expansion card riser is not supported or missing. It does not prevent your system from turning on. However, if a F1/F2 pause occurs and an error message is displayed.

The PowerEdge R740xd system supports up to eight PCI express (PCIe) generation 3 expansion cards, that can be installed on the system board using expansion card risers. The following table provides detailed information about the expansion card riser specifications:

**Table 25. Expansion card riser specifications**

Riser configuration and supported risers	Slot description	PCIe slots on riser 1 (Height and length)	Processor connection	PCIe slots on riser 2 (Height and length)	Processor connection	PCIe slots on riser 3 (Height and length)	Processor connection
Riser configuration 0 with or without rear storage (No riser)	No PCIe slots (only rear storage)	N/A	N/A	N/A	N/A	N/A	N/A
Riser configuration 1 with or without rear storage (1B+2 B)	Four x8 slots and rear storage	Slot 1: x8 full-height, full length	Processor 1	Slot 4: x8 low profile, half length	Processor 1	N/A	N/A
		Slot 2: x8 full-height, full length	Processor 1				
		Slot 3: x8 full-height, half length	Processor 1				
Riser configuration 2 with or without rear storage (1B+2C)	Three x8 and one x16 slots and rear storage	Slot 1: x8 full-height, full length	Processor 1	Slot 4: x16 low profile, half length	Processor 2	N/A	N/A
		Slot 2: x8 full-height, full length	Processor 1				
		Slot 3: x8 full-height, half length	Processor 1				
Riser configuration 3 (1A+2A)	Two x8 and three x16 slots	Slot 1: x16 full-height, full length	Processor 1	Slot 4: x16 full-height, full length	Processor 2	N/A	N/A
		N/A	N/A	Slot 5: x8 full-height, full length	Processor 2		
		Slot 3: x16 full-height, half length	Processor 1	Slot 6: x8 low profile, half length	Processor 1		
Riser configuration 4 (1A+2A+3A)	Three x8 and four x16 slots	Slot 1: x16 full-height, full length	Processor 1	Slot 4: x16 full-height, full length	Processor 2	Slot 7: x8 full-height, full length	Processor 2

**Table 25. Expansion card riser specifications (continued)**

Riser configuration and supported risers	Slot description	PCIe slots on riser 1 (Height and length)	Processor connection	PCIe slots on riser 2 (Height and length)	Processor connection	PCIe slots on riser 3 (Height and length)	Processor connection
		N/A	N/A	Slot 5: x8 full-height, full length	Processor 2	Slot 8: x16 full-height, full length	Processor 2
		Slot 3: x16 full-height, half length	Processor 1	Slot 6: x8 low profile, half length	Processor 1		
Riser configuration 15 (1A+2E+3B)	Three x8 and four x16 slots	Slot 1: x16 full-height, full length	Processor 1	Slot 4: x16 full-height, full length	Processor 2	Slot 7: x8 full-height, full length	Processor 2
		N/A	N/A	Slot 5: x8 full-height, full length	Processor 2	Slot 8: x16 full-height, full length	Processor 2
		Slot 3: x16 full-height, half length	Processor 1	Slot 6: x8 low profile, half length	Processor 1		
Riser configuration 5 (1B+2A+3A)	Six x8 and two x16 slots	Slot 1: x8 full-height, full length	Processor 1	Slot 4: x16 full-height, full length	Processor 2	Slot 7: x8 full-height, full length	Processor 2
		Slot 2: x8 full-height, full length	Processor 1	Slot 5: x8 full-height, full length	Processor 2	Slot 8: x16 full-height, full length	Processor 2
		Slot 3: x8 full-height, half length	Processor 1	Slot 6: x8 low profile, half length	Processor 1		
Riser configuration 6 (1D+2A+3A)	Five x8 and three x16 slots	Slot 1: x16 full-height, full length	Processor 1	Slot 4: x16 full-height, full length	Processor 2	Slot 7: x8 full-height, full length	Processor 2
		Slot 2: x8 full-height, full length	Processor 1	Slot 5: x8 full-height, full length	Processor 2	Slot 8: x16 full-height, full length	Processor 2
		Slot 3: x8 full-height, half length	Processor 1	Slot 6: x8 low profile, half length	Processor 1		
Riser configuration 16 (1D+2E+3B)	Five x8 and three x16 slots	Slot 1: x16 full-height, full length	Processor 1	Slot 4: x16 full-height, full length	Processor 2	Slot 7: x8 full-height, full length	Processor 2
		Slot 2: x8 full-height, full length	Processor 1	Slot 5: x8 full-height, full length	Processor 2	Slot 8: x16 full-height, full length	Processor 2
		Slot 3: x8 full-height, half length	Processor 1	Slot 6: x8 low profile, half length	Processor 1		
Riser configuration 9 (1A+2D+3A) or Riser configuration 17 (1A+2F+3B)	Three x8 and four x16 slots	Slot 1: x16 full-height, full length	Processor 1	Slot 4: x16 full-height, full length	Processor 2	Slot 7: x8 full-height, full length	Processor 2
		N/A	N/A	Slot 5: x8 full-height, full length	Processor 2	Slot 8: x16 full-height, full length	Processor 2



**Table 25. Expansion card riser specifications (continued)**

Riser configuration and supported risers	Slot description	PCIe slots on riser 1 (Height and length)	Processor connection	PCIe slots on riser 2 (Height and length)	Processor connection	PCIe slots on riser 3 (Height and length)	Processor connection
		Slot 3: x16 full-height, half length	Processor 1	Slot 6: x8 low profile, half length	Processor 1		

**Table 26. Riser configurations with 4 PCIe slots [Riser configuration 1 with or without rear storage (1B+2B) and Riser configuration 2 with or without rear storage (1B+2C)], and Riser configuration 3 with or without rear storage(1A+2A)**

Card Type	Slot priority	Maximum number of cards
GPU (double width)	N/A	N/A
GPU (single width)	N/A	N/A
PCIe Bridge	4 (config 2) or N/A (config 1 or 3)	1 or 0
Internal storage adapter	6,5 (config 3) or 4, 3 (Config 1 or 2)	1 or 2
HCA EDR	1,4,3 (config 3) or N/A (config 1 or 2)	3 or 0
100 GB NIC	1,4,3 (config 3) or N/A (config 1 or 2)	3 or 0
100 G OPA	1,4,3 (config 3) or N/A (config 1 or 2)	3 or 0
HCA FDR	4 (config 1 or 2) or 6 (config 3)	1
40 GB NIC	1, 2, 3 (c1/c2) or 5, 1, 4, 3 (config 3)	3
40 GB NIC	4 (config 1 or 2) or 6 (config 3)	1
HBA FC32	1, 2, 3 (c1/c2) or 5, 1, 4, 3 (config 3)	3
HBA FC32	4 (config 1 or 2) or 6 (config 3)	1
25 GB NIC	1, 2, 3 (c1/c2) or 5, 1, 4, 3 (config 3)	3
25 GB NIC	4 (config 1 or 2) or 6 (config 3)	1
HBA FC16	1, 2, 3 (c1/c2) or 5, 1, 4, 3 (config 3)	3
HBA FC16	4 (config 1 or 2) or 6 (config 3)	1
10 GB NIC	1, 2, 3 (c1/c2) or 5, 1, 4, 3 (config 3)	3
10 GB NIC	4 (config 1 or 2) or 6 (config 3)	1
HBA FC8	1, 2, 3 (c1/c2) or 5, 1, 4, 3 (config 3)	3
HBA FC8	4 (config 1 or 2) or 6 (config 3)	1
1 GB NIC	1, 2, 3 (c1/c2) or 5, 1, 4, 3 (config 3)	3
1 GB NIC	4 (config 1 or 2) or 6 (config 3)	1
External storage adapter	1, 2, 3 (c1/c2) or 5, 1, 4, 3 (config 3)	3
External storage adapter	4 (config 1 or 2) or 6 (config 3)	1
BOSS	1, 2, 3 (c1/c2) or 5, 1, 4, 3 (config 3)	1
BOSS	4 (config 1 or 2) or 6 (config 3)	1
ACL (Full Height DW)	NA	0

**Table 27. Riser configurations with greater than 4 PCIe slots [Riser configuration 3 (1A+2A), 4 (1A+2A+3A), Riser configuration 5 (1B+2A+3A), Riser configuration 6 (1D+2A+3A) and Riser configuration 9 (1A+2D+3A), Riser configuration 15 (1A+2E+3B), Riser Configuration 16 (1D+2A+3A), and Riser configuration 17 (1A+2F+3B)]**

Card Type	Slot priority	Configuration	Maximum number of cards
GPU (double width)	1, 8, 4	1A+2A+3A	3 <b>i</b> <b>NOTE:</b> Does not support double width Nvidia A-Series GPUs.
	1,8	1A+2D+3A	2 <b>i</b> <b>NOTE:</b> Does not support double width Nvidia A-Series GPUs.
GPU (single width)	1, 8, 4	1D+2A+3A	3 <b>i</b> <b>NOTE:</b> Factory install maximum of 3 x GPU cards in slots 1, 8, 4 with x16 max PCIe width. Customers can order 3 additional Custom Kits and install in the order of slots 7, 2, 5, however slots are limited to x8 max PCIe width. This does not apply to the NVIDIA A10 due to reduced performance in x8 slots.
	1, 8	1A+2D+3A	2
Nvidia A2	1,8,4,7,2,5	1D+2E+3B	6
	1,8	1A+2F+3B	2
Nvidia A10	1, 8, 4	1D+2E+3B	3
	1, 8	1A+2F+3B	2
Nvidia A16, A30, A40, A100, A800	1, 8, 4	1A+2E+3B	3
	1, 8	1A+2F+3B	2
ACLR	1, 8, 4	1A+2A+3A	3
	1, 8, 4	1D+2A+3A	3
	1, 8	1A+2D+3A	2
PCIe Bridge	1, 4, 8	1D+2A+3A	3
	3, 4	1A+2D+3A	2
Internal storage adapter	6, 5	all	1
200 G NIC	1	1A+2A+3A	1
	1	1D+2A+3A	1
	1	1A+2D+3A	1
HCA EDR	1, 8, 4, 3	1A+2A+3A	4
	8, 4	1B+2A+3A	2
	1, 8	1D+2A+3A	2
	1, 8	1A+2D+3A	2
100 G NIC	1, 8, 4, 3	1A+2A+3A	4
	8, 4	1B+2A+3A	2

**Table 27. Riser configurations with greater than 4 PCIe slots [Riser configuration 3 (1A+2A), 4 (1A+2A+3A), Riser configuration 5 (1B+2A+3A), Riser configuration 6 (1D+2A+3A) and Riser configuration 9 (1A+2D+3A), Riser configuration 15 (1A+2E+3B), Riser Configuration 16 (1D+2A+3A), and Riser configuration 17 (1A+2F+3B)] (continued)**

Card Type	Slot priority	Configuration	Maximum number of cards
	1, 8, 4	1D+2A+3A	3
	1, 8	1A+2D+3A	2
100 G OPA	1, 8, 4, 3	1A+2A+3A	4
	8, 4	1B+2A+3A	2
	1,8	1D+2A+3A	2
	1,8	1A+2D+3A	2
HCA FDR	6	All	1
40 G NIC	7, 5, 1, 8, 4, 3 for other supplier	1A+2A+3A	6
	1, 8, 4, 3, 7, 5 for Mellanox	1A+2A+3A	6
	1, 7, 2, 3, 5, 8, 4 for other supplier	1B+2A+3A	7
	8, 4, 1, 7, 2, 3, 5 for Mellanox	1B+2A+3A	7
	7, 2, 3, 5, 1, 8, 4 for other supplier	1D+2A+3A	7
	1, 8, 4, 7, 2, 3, 5 for Mellanox	1D+2A+3A	7
	7, 5, 1, 8 for other supplier	1A+2D+3A	4
	1, 8, 7, 5 for Mellanox	1A+2D+3A	4
40 G NIC LP	6	All	1
HBA FC32	7, 5, 1, 8, 4, 3	1A+2A+3A	6
	1, 7, 2, 3, 5, 8, 4	1B+2A+3A	7
	7, 2, 3, 5, 1, 8, 4	1D+2A+3A	7
	7, 5, 1, 8, 6	1A+2D+3A	4
HBA FC32 LP	6	All	1
25 G NIC	7, 5, 1, 8, 4, 3 for other supplier	1A+2A+3A	6
	1, 8, 4, 3, 7, 5 for Mellanox	1A+2A+3A	6
	1, 7, 2, 3, 5, 8, 4 for other supplier	1B+2A+3A	7
	8, 4, 1, 7, 2, 3, 5 for Mellanox	1B+2A+3A	7
	7, 2, 3, 5, 1, 8, 4 for other supplier	1D+2A+3A	7
	1, 8, 4, 7, 2, 3, 5 for Mellanox	1D+2A+3A	7
	7, 5, 1, 8 for other supplier	1A+2D+3A	4
	1, 8, 7, 5 for Mellanox	1A+2D+3A	4
25 G NIC LP	6	All	1
HBA FC16	7, 5, 1, 8, 4, 3	1A+2A+3A	6
	1, 7, 2, 3, 5, 8, 4	1B+2A+3A	7

**Table 27. Riser configurations with greater than 4 PCIe slots [Riser configuration 3 (1A+2A), 4 (1A+2A+3A), Riser configuration 5 (1B+2A+3A), Riser configuration 6 (1D+2A+3A) and Riser configuration 9 (1A+2D+3A), Riser configuration 15 (1A+2E+3B), Riser Configuration 16 (1D+2A+3A), and Riser configuration 17 (1A+2F+3B)] (continued)**

Card Type	Slot priority	Configuration	Maximum number of cards
	7, 2, 3, 5, 1, 8, 4	1D+2A+3A	7
	7, 5, 1, 8	1A+2D+3A	4
HBA FC16 LP	6	All	1
10 G NIC	7, 5, 1, 8, 4, 3 for other supplier	1A+2A+3A	6
	1, 8, 4, 3, 7, 5 for Mellanox	1A+2A+3A	6
	1, 7, 2, 3, 5, 8, 4 for other supplier	1B+2A+3A	7
	8, 4, 1, 7, 2, 3, 5 for Mellanox	1B+2A+3A	7
	7, 2, 3, 5, 1, 8, 4 for other supplier	1D+2A+3A	7
	1, 8, 4, 7, 2, 3, 5 for Mellanox	1D+2A+3A	7
	7, 5, 1, 8 for other supplier	1A+2D+3A	4
	1, 8, 7, 5	1A+2D+3A	4
10 G NIC LP	6	All	1
HBA FC8	7, 5, 1, 8, 4, 3	1A+2A+3A	6
	1, 7, 2, 3, 5, 8, 4	1B+2A+3A	7
	7, 2, 3, 5, 1, 8, 4	1D+2A+3A	7
	7, 5, 1, 8	1A+2D+3A	4
HBA FC8 LP	6	All	1
1 G NIC	7, 5, 1, 8, 4, 3	1A+2A+3A	6
	1, 7, 2, 3, 5, 8, 4	1B+2A+3A	7
	7, 2, 3, 5, 1, 8, 4	1D+2A+3A	7
	7, 5, 1, 8	1A+2D+3A	4
1 G NIC LP	6	All	1
External storage adapter	1, 8, 4, 3, 7, 5	1A+2A+3A	2
	1, 2, 3, 8, 4, 7, 5	1B+2A+3A	2
	2, 3, 1, 8, 4, 7, 5	1D+2A+3A	2
	1, 8, 7, 5	1A+2D+3A	2
External storage adapter LP	6	All	1
Express Flash NVMe PCIe SSD adapter	7, 5, 1, 8, 4, 3, 6	1A+2A+3A	6
	1, 6 for P4800X	1A+2A+3A	2
	1, 7, 2, 3, 5, 8, 4, 6	1B+2A+3A	6
	1, 2, 6 for P4800X	1B+2A+3A	3
	7, 2, 3, 5, 1, 8, 4, 6	1D+2A+3A	6
	1, 6 for P4800X	1D+2A+3A	2

**Table 27. Riser configurations with greater than 4 PCIe slots [Riser configuration 3 (1A+2A), 4 (1A+2A+3A), Riser configuration 5 (1B+2A+3A), Riser configuration 6 (1D+2A+3A) and Riser configuration 9 (1A+2D+3A), Riser configuration 15 (1A+2E+3B), Riser Configuration 16 (1D+2A+3A), and Riser configuration 17 (1A+2F+3B)] (continued)**

Card Type	Slot priority	Configuration	Maximum number of cards
	7, 5, 1, 8, 6	1A+2D+3A	5
BOSS	7, 5, 1, 8, 4, 3	1A+2A+3A	1
	1, 7, 2, 3, 5, 8, 4	1B+2A+3A	1
	7, 2, 3, 5, 1, 8, 4	1D+2A+3A	1
	7, 5, 1, 8	1A+2D+3A	1
BOSS LP	6	All	1

- NOTE:** H750 and HBA350i cards cannot be mixed with H730P, H740P, HBA330 or 12G SAS cards.
- NOTE:** For information about slot form factor, see the Expansion card riser configurations table.
- NOTE:** The expansion card slots are not hot-swappable.
- NOTE:** Riser configuration 9 supports both double width GPUs and single width GPUs. Double width GPUs are supported only on riser configuration 4, and single width GPUs are supported only on riser configuration 6.
- NOTE:** Ensure that x16 cards are installed only in x16 slots. Depending on the riser configuration slots 2, 7, or 8 may not be available.
- NOTE:** Only half length PCIe cards are supported on riser 2 when NVDIMM-Ns with NVDIMM-N battery are installed on the air shroud.
- NOTE:** For 24x2.5 inch 24 NVMe drive configuration, the PCIe bridge cards must be installed in slots 3 and 4.

## Opening and closing the PCIe card holder latch

Before installing or removing a full length PCIe card, the PCIe card holder latch must be closed. When the full length PCIe card is installed, open the PCIe card holder latch.

### Prerequisites

- Follow the safety guidelines listed in [Safety instructions](#).
- Follow the procedure listed in [Before working inside your system](#).

### Steps

- To open the PCIe card holder latch, press the release tab.



**Figure 80. Opening the PCIe card holder latch**

2. To close the PCIe card holder latch, push the latch until it locks.



**Figure 81. Closing the PCIe card holder latch**

### Next steps

Follow the procedure listed in [After working inside your system](#).

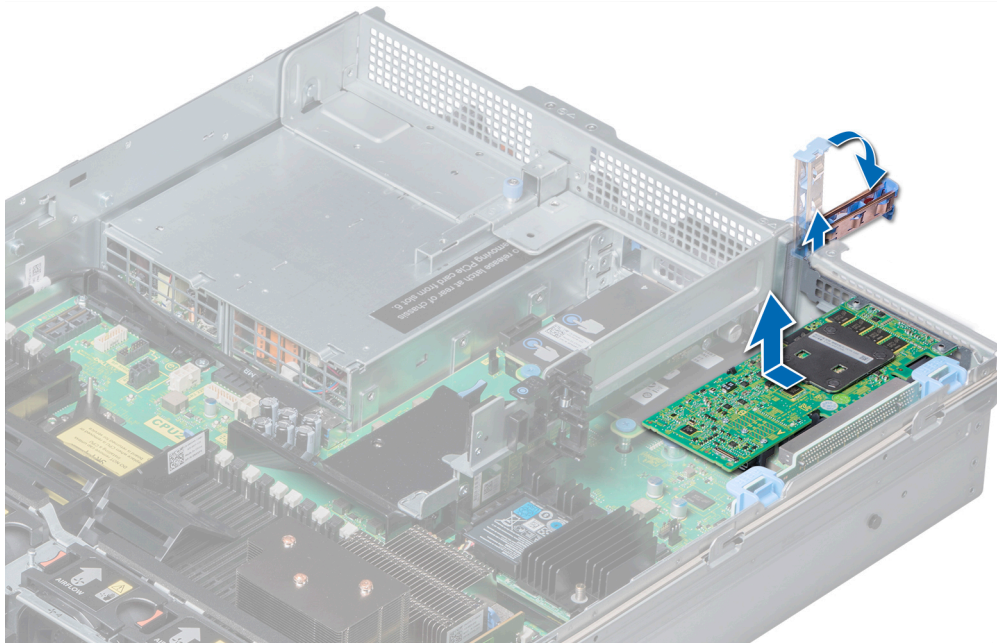
## Removing expansion card from the expansion card riser

### Prerequisites

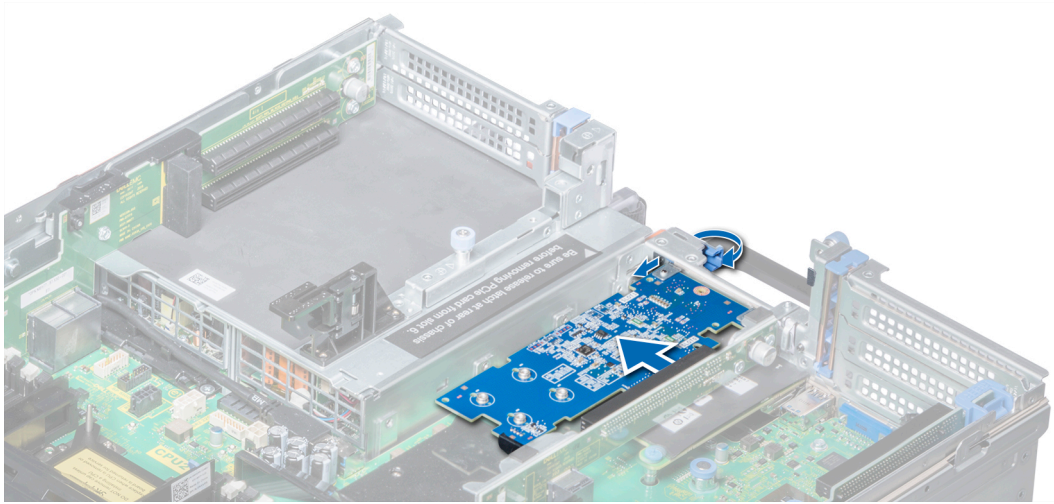
1. Follow the safety guidelines listed in [Safety instructions](#).
2. Follow the procedure listed in [Before working inside your system](#).
3. If applicable, [remove the air shroud](#).
4. If applicable, disconnect the cables from the expansion card.
5. When removing a card from riser 2 or 3, ensure that the PCIe card holder latch is closed.

### Steps

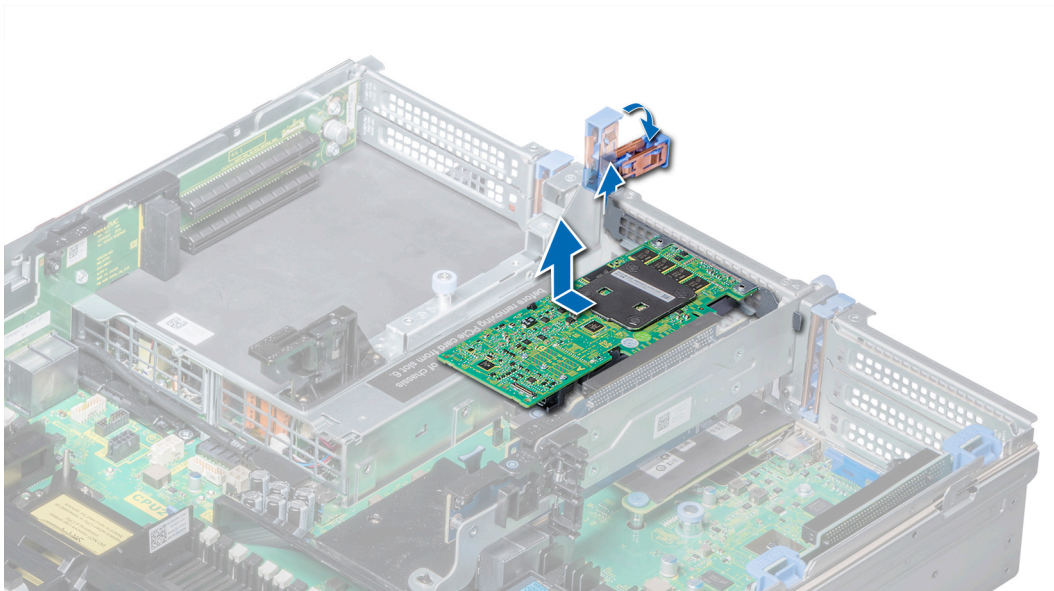
1. Pull the expansion card latch out of the slot.
2. Hold the expansion card by its edges, and pull the card until the card edge connector disengages from the expansion card connector on the riser.



**Figure 82. Removing the expansion card from expansion card riser 1**

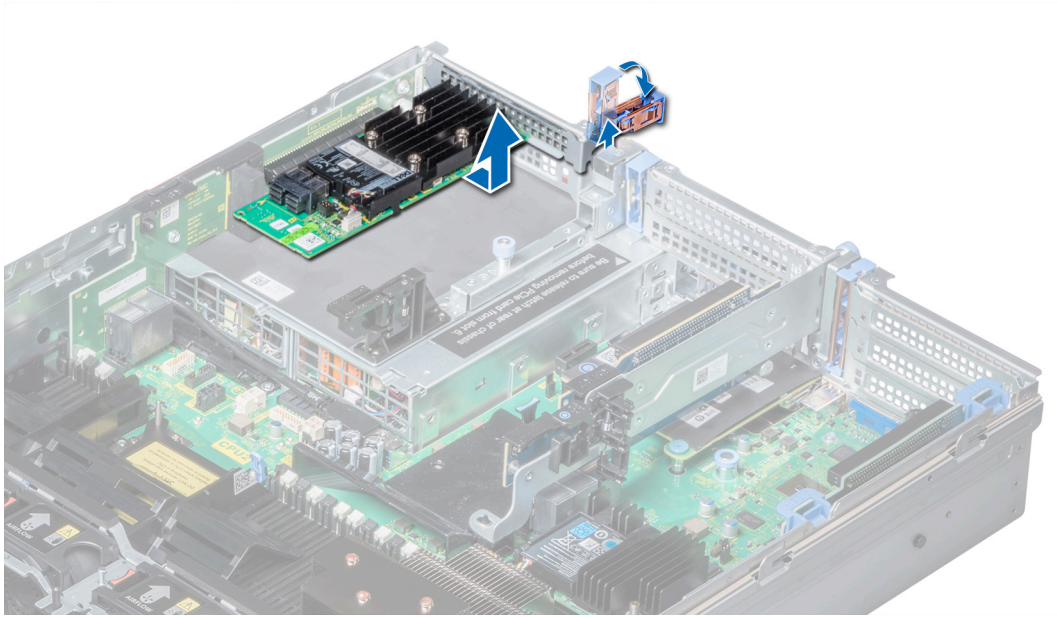


**Figure 83. Removing the expansion card from expansion card riser 2B**



**Figure 84. Removing the expansion card from expansion card riser 2**





**Figure 85. Removing the expansion card from expansion card riser 3**

### Next steps

1. Install the expansion card into the expansion card riser.
2. If you are removing the card permanently, install a metal filler bracket over the empty expansion slot opening and push the expansion card latch.
  - NOTE:** You must install a filler bracket over an empty expansion card slot to maintain Federal Communications Commission (FCC) certification of the system. The brackets also keep dust and dirt out of the system and aid in proper cooling and airflow inside the system.

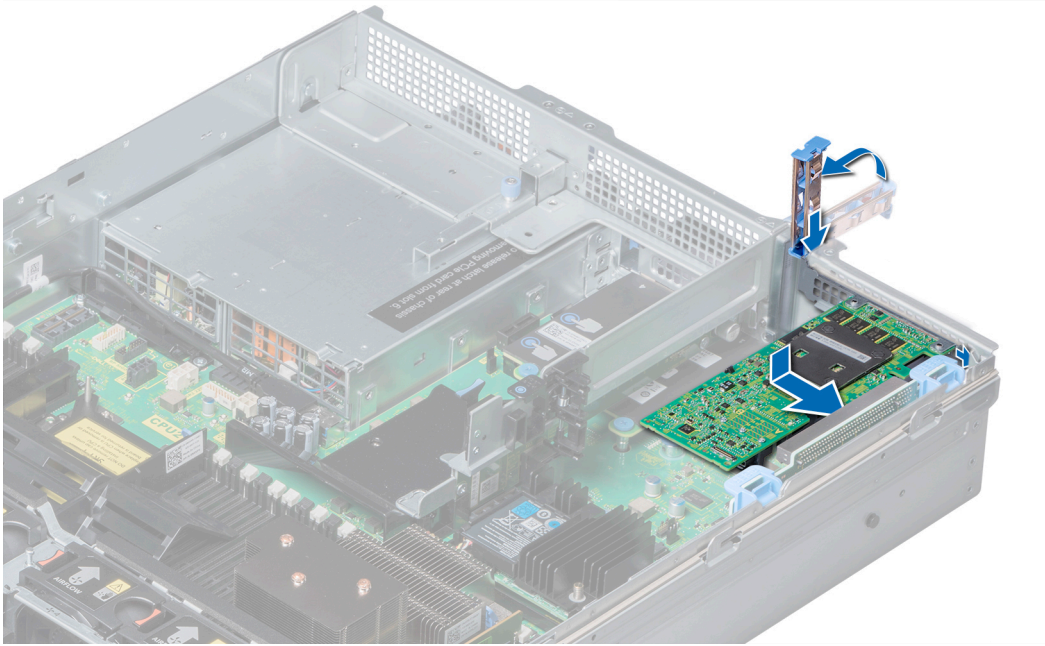
## Installing expansion card into the expansion card riser

### Prerequisites

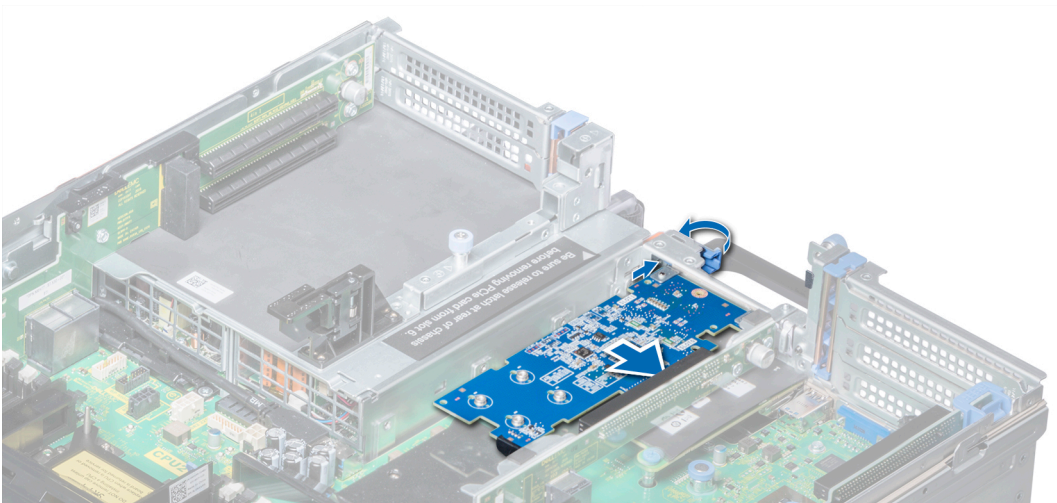
1. Follow the safety guidelines listed in [Safety instructions](#).
2. If installing a new expansion card, unpack it and prepare the card for installation.
  - NOTE:** For instructions, see the documentation accompanying the card.
3. When installing a card into riser 2 or 3, open the PCIe card holder latch.

### Steps

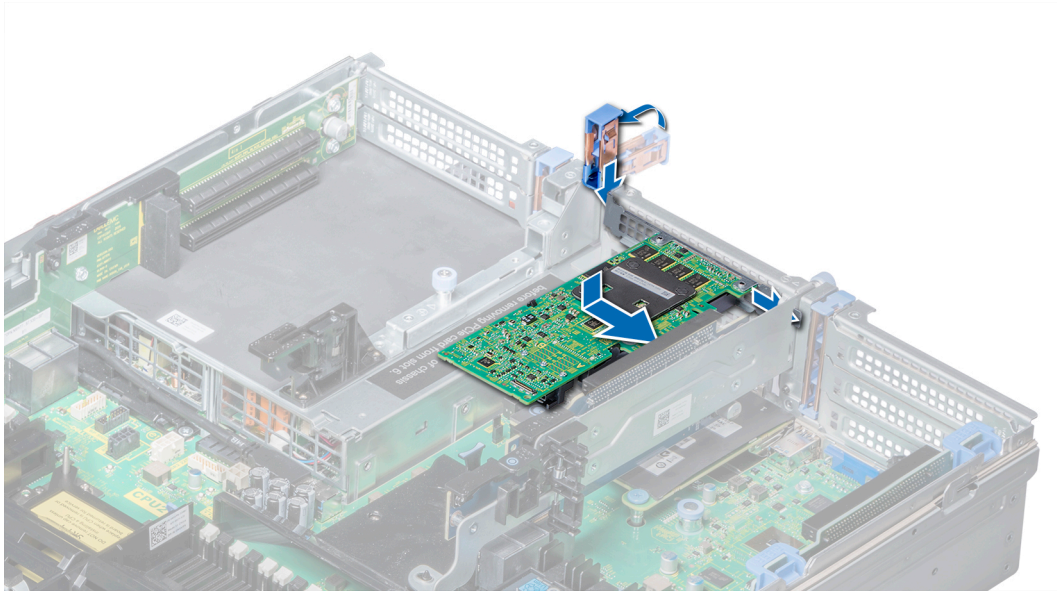
1. Pull the expansion card latch.
2. If installed, remove the filler bracket.
  - NOTE:** Store the filler bracket for future use. Filler brackets must be installed in empty expansion card slots to maintain Federal Communications Commission (FCC) certification of the system. The brackets also keep dust and dirt out of the system and aid in proper cooling and airflow inside the system.
3. Hold the card by its edges, and align the card edge connector with the expansion card connector on the riser.
4. Insert the card edge connector firmly into the expansion card connector until the card is fully seated.
5. Push the expansion card latch.



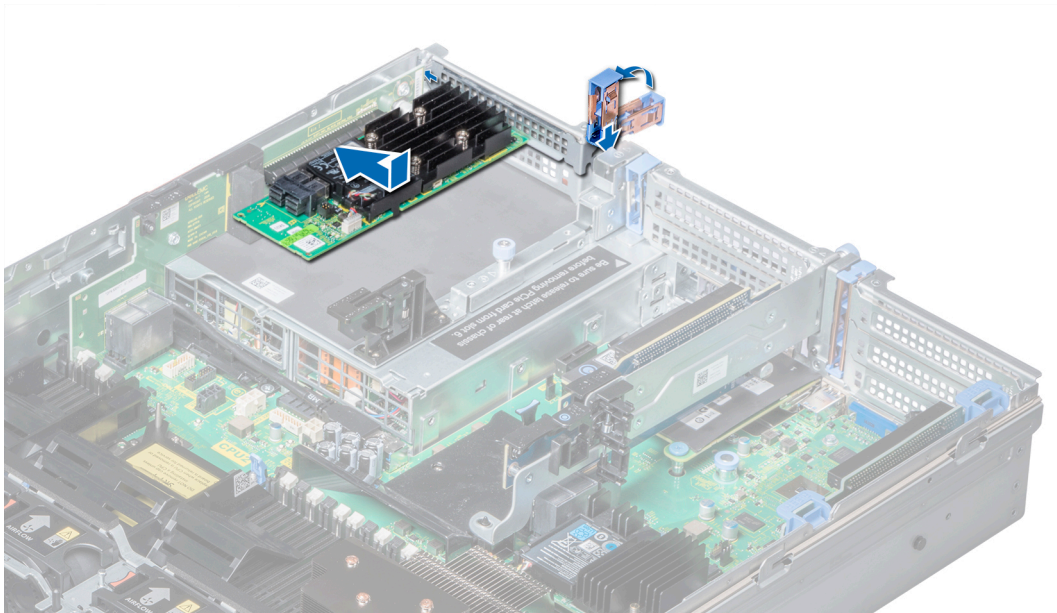
**Figure 86. Installing expansion card into expansion card riser 1**



**Figure 87. Installing expansion card into expansion card riser 2B**



**Figure 88. Installing expansion card into expansion card riser 2**



**Figure 89. Installing expansion card into expansion card riser 3**

### Next steps

1. If applicable, connect the cables to the expansion card.
2. If applicable, [install the air shroud](#).
3. Follow the procedure listed in [After working inside your system](#).
4. Install any device drivers required for the card as described in the documentation for the card.

## Removing riser 2 and 3 blank

### Prerequisites

1. Follow the safety guidelines listed in [Safety instructions](#).
2. Follow the procedure listed in [Before working inside your system](#).

3. Remove the air shroud.

### Steps

1. Using Phillips #2 screwdriver, loosen the screws (3) that secure the blank to the system.
2. Press the release tab, and holding the blank by its edges, lift the blank away from the system.

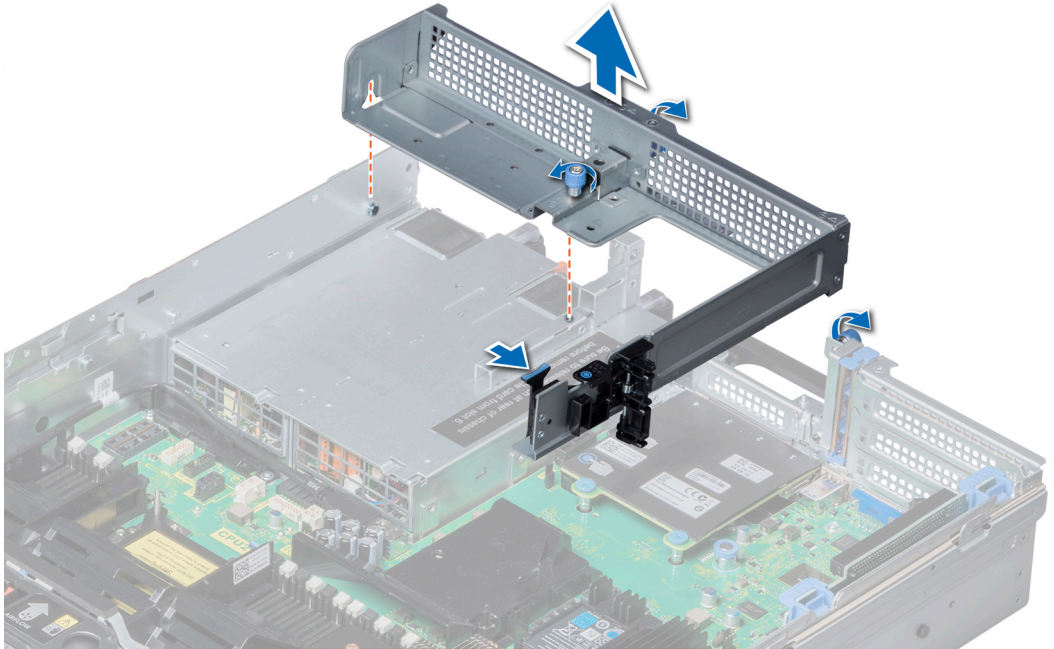


Figure 90. Removing riser 2 and 3 blank

### Next steps

Install the riser 2 and 3 blank.

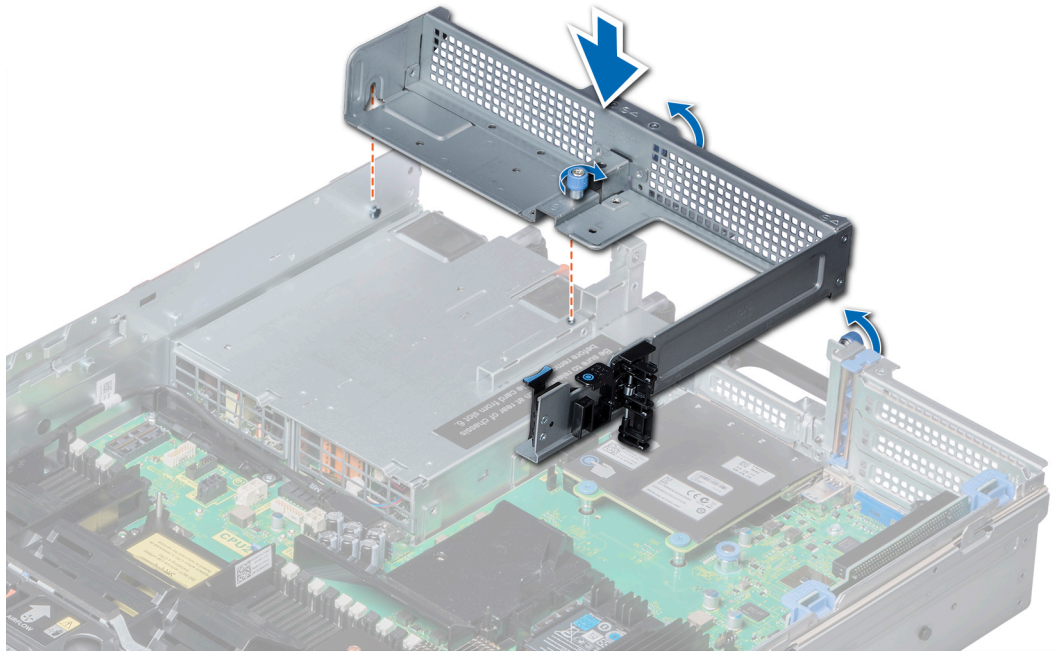
## Installing riser 2 and 3 blank

### Prerequisites

Follow the safety guidelines listed in [Safety instructions](#).

### Steps

1. Align the screw and guide rail on the riser blank with the screw hole and standoff on the system.
2. Lower the blank into the system until the release tab clicks into place.
3. Tighten the screws to secure the riser blank to the system.



**Figure 91. Installing riser 2 and 3 blank**

#### **Next steps**

1. [Install the air shroud.](#)
2. Follow the procedure listed in [After working inside your system.](#)

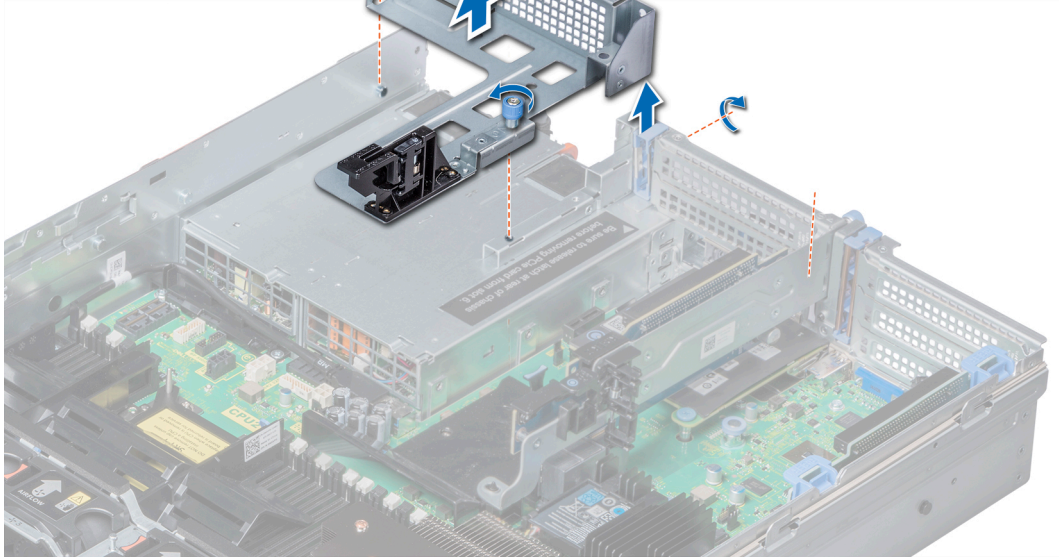
## **Removing riser 3 blank**

#### **Prerequisites**

1. Follow the safety guidelines listed in [Safety instructions.](#)
2. Follow the procedure listed in [Before working inside your system.](#)

#### **Steps**

1. Using Phillips #2 screwdriver, loosen the screw that secures the blank to the system.
2. Lift the blank away from the system.



**Figure 92. Removing riser 3 blank**

#### **Next steps**

Install the riser 3 blank.

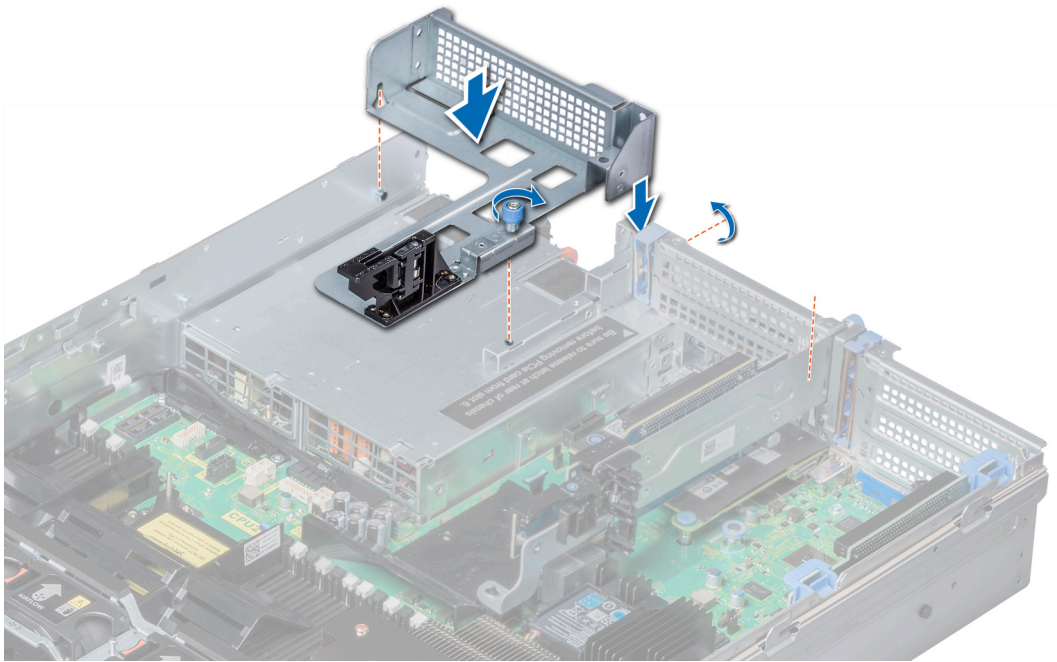
## **Installing riser 3 blank**

#### **Prerequisites**

Follow the safety guidelines listed in [Safety instructions](#).

#### **Steps**

1. Align the screw on the riser with the screw hole on the system.
2. Using Phillips #2 screwdriver, tighten the screw to secure the blank to the system.



**Figure 93. Installing riser 3 blank**

#### **Next steps**

Follow the procedure listed in [After working inside your system](#).

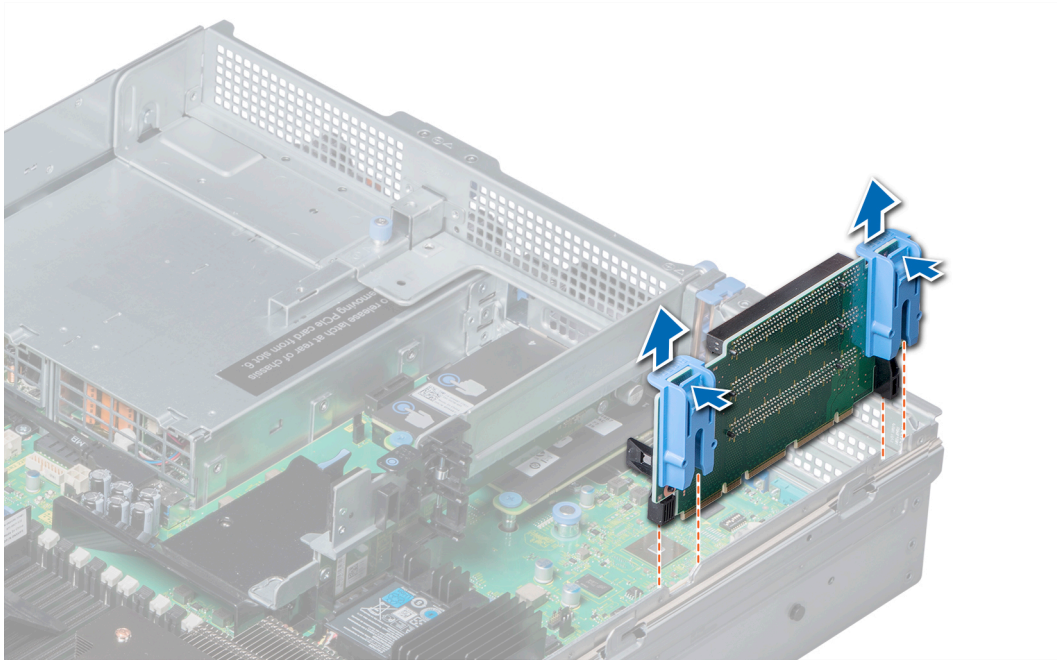
## **Removing expansion card riser 1**

#### **Prerequisites**

1. Follow the safety guidelines listed in [Safety instructions](#).
2. Follow the procedure listed in [Before working inside your system](#).
3. If installed, [remove the expansion cards from the riser](#).
4. Disconnect any cables connected to the riser.

#### **Steps**

Press the release latches, and lift the riser from the riser connector on the system board.



**Figure 94. Removing expansion card riser 1**

#### **Next steps**

Install the expansion card riser 1.

## **Installing expansion card riser 1**

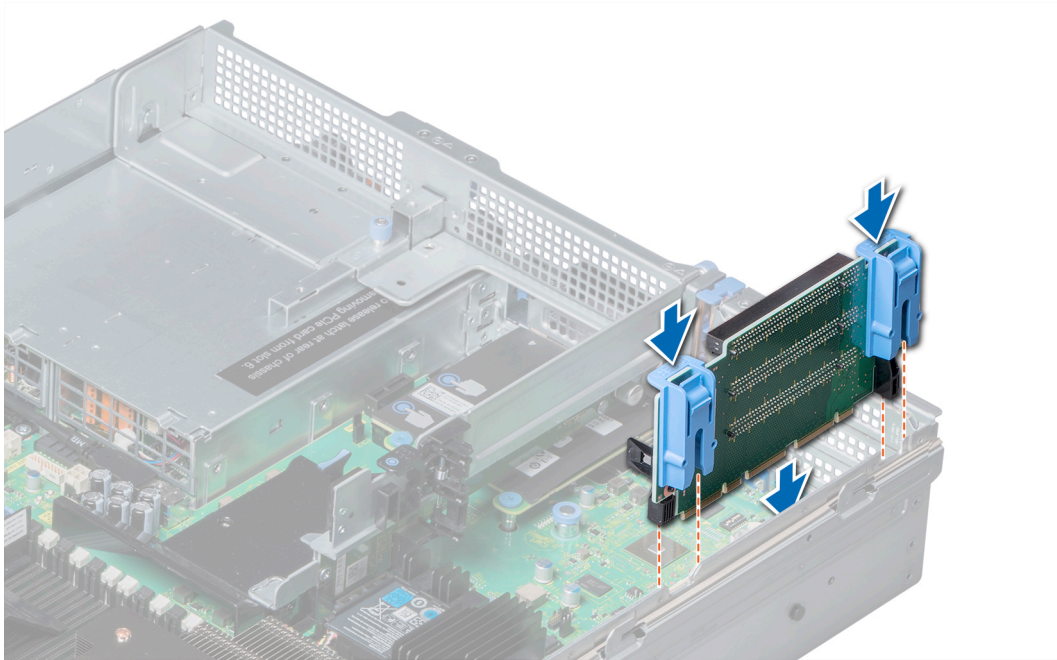
#### **Prerequisites**

Follow the safety guidelines listed in [Safety instructions](#).

#### **Steps**

1. Align the guide rails on the riser with the standoffs on the side of the system.
2. Lower the riser into the system until the riser connector engages with the connector on the system board.





**Figure 95. Installing expansion card riser 1**

#### Next steps

1. If removed, [install expansion cards into the riser](#).
2. Follow the procedure listed in [After working inside your system](#).
3. Install any device drivers required for the card as described in the documentation for the card.

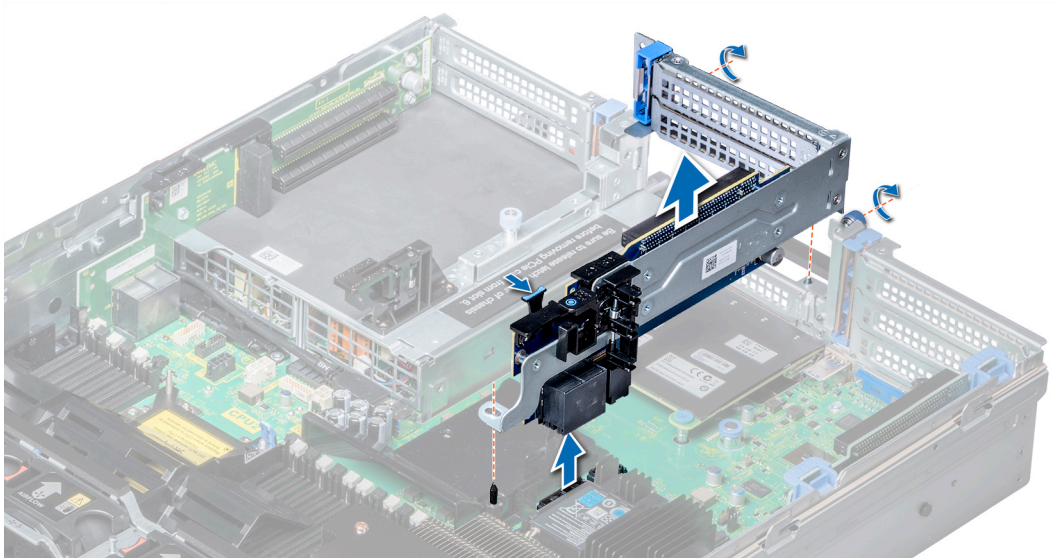
## Removing expansion card riser 2

#### Prerequisites

1. Follow the safety guidelines listed in [Safety instructions](#).
2. Follow the procedure listed in [Before working inside your system](#).
3. If applicable, close the PCIe card holder latch on the air shroud to release the full length card.
4. If installed, [remove expansion cards installed on the riser](#).
5. [Remove the air shroud](#).
6. Disconnect any cables connected to the riser.

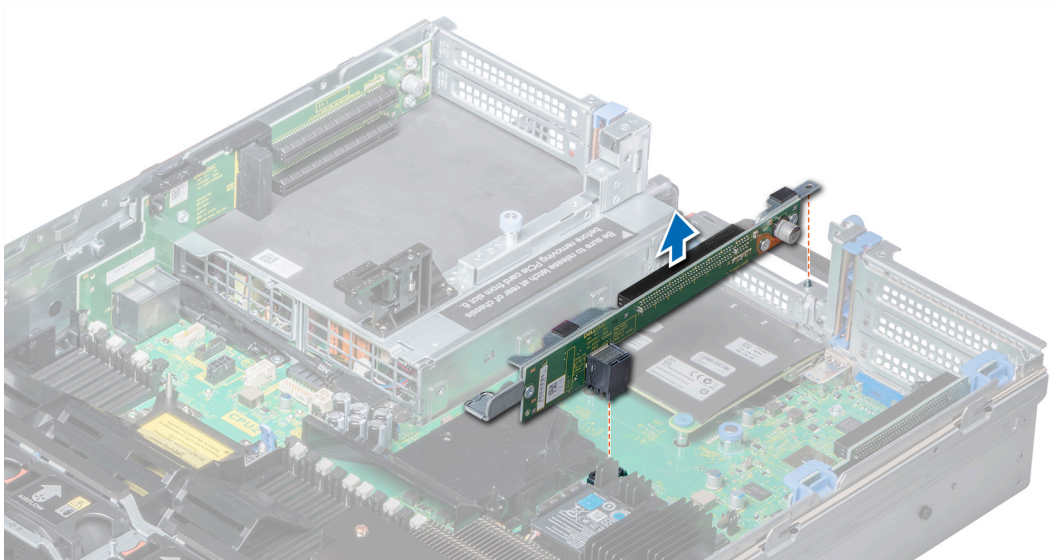
#### Steps

1. To remove expansion card riser 2A:
  - a. Using Phillips #2 screwdriver, loosen the screws that secure the riser to the system.
  - b. Press the release tab, and holding the riser by its edges, lift the riser from the riser connector on the system board.



**Figure 96. Removing expansion card riser 2A**

2. To remove expansion card riser 2B or 2C, hold the riser by its edges and lift the riser from the riser connector on the system board.



**Figure 97. Removing expansion card riser 2**

### Next steps

Install the expansion card riser 2.

## Installing expansion card riser 2

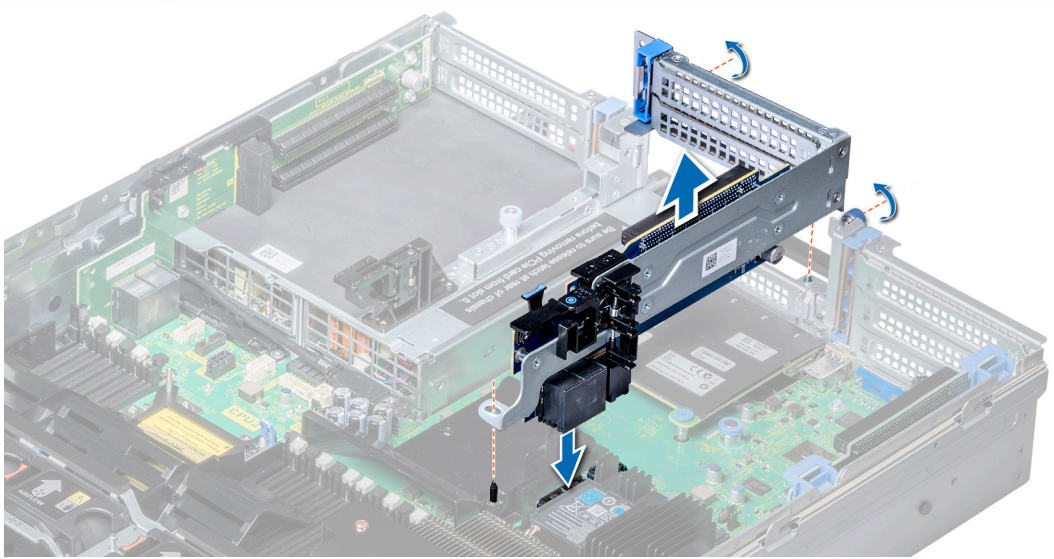
### Prerequisites

Follow the safety guidelines listed in [Safety instructions](#).

### Steps

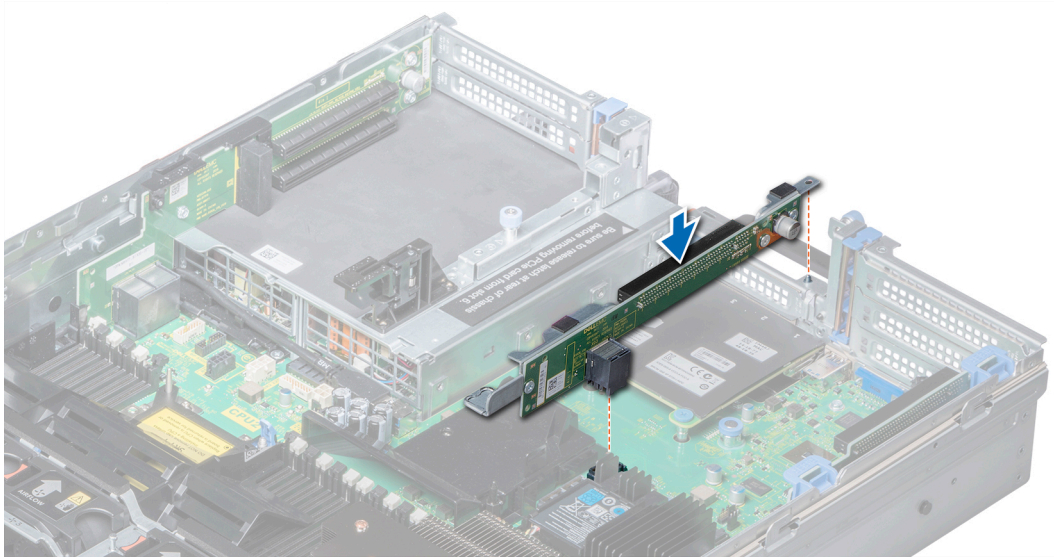
1. To install expansion card riser 2A:
  - a. Align the screw and tab on the riser with the screw hole and slot on the system.

- b. Lower the riser into the system until the riser connector engages with the connector on the system board.
- c. Using Phillips #2 screwdriver, tighten the screws to secure the riser to the system.



**Figure 98. Installing expansion card riser 2A**

2. To install expansion card riser 2B or 2C:
  - a. Align the slot on the riser with the standoff on the system.
  - b. Lower the riser into the system until the riser card connector engages with the connector on the system board.



**Figure 99. Installing expansion card riser 2**

### Next steps

1. [Install the air shroud.](#)
2. If removed, [install expansion cards into the riser.](#)
3. If applicable, open the PCIe card holder latch on the air shroud to install the full length card.
4. Follow the procedure listed in [After working inside your system.](#)
5. Install any device drivers required for the card as described in the documentation for the card.

## Removing expansion card riser 3

### Prerequisites

1. Follow the safety guidelines listed in [Safety instructions](#).
2. Follow the procedure listed in [Before working inside your system](#).
3. [Remove the air shroud](#).  
**NOTE:** If applicable, close the PCIe card holder latch on the air shroud to release the full length card.
4. If installed, remove expansion cards installed on the riser.
5. Disconnect any cables connected to the riser card.

### Steps

1. Using Phillips #2 screwdriver, loosen the screw that secures the riser to the system.
2. Press the release tab, and holding the riser by its edges, lift the riser from the riser connector on the system board.

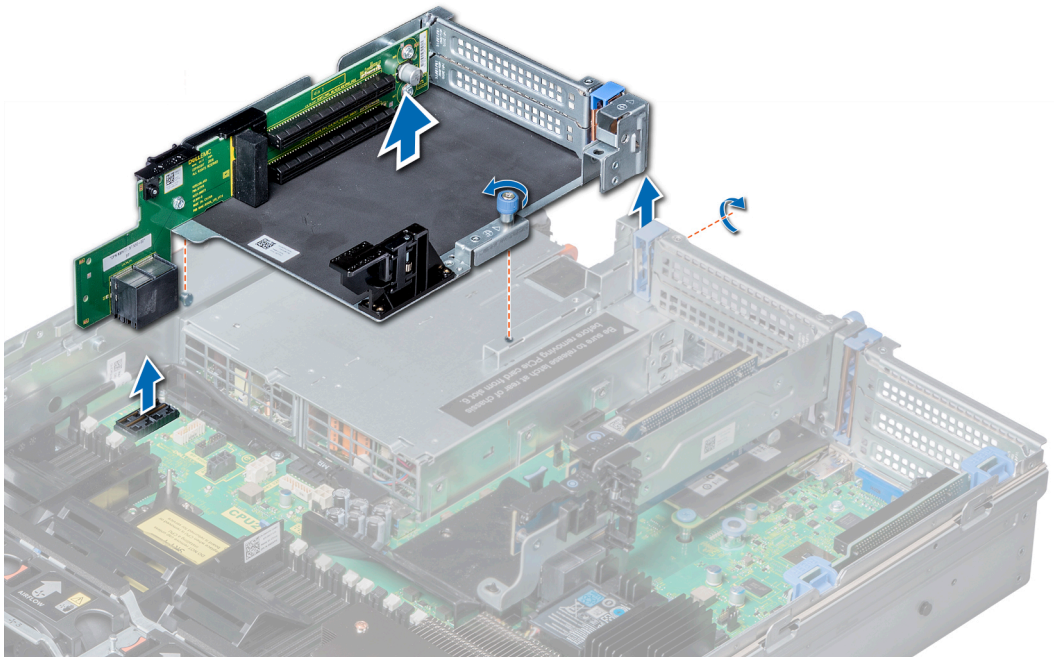


Figure 100. Removing expansion card riser 3

### Next steps

[Install expansion card riser 3.](#)

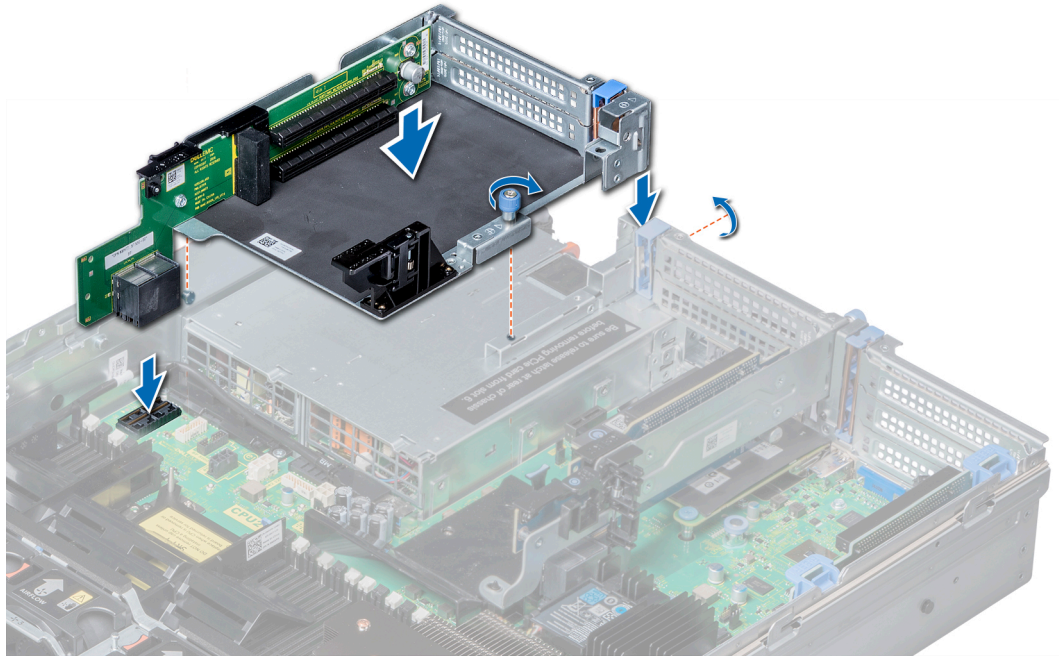
## Installing expansion card riser 3

### Prerequisites

Follow the safety guidelines listed in [Safety instructions](#).

### Steps

1. Align the tab on the riser with the slot on the system, and guide rails on the riser with the standoffs on the side of the system.
2. Lower the riser into the system until the riser edge connector engages with the connector on the system board. The riser card edge engages with the riser guide on the system.
3. Using Phillips #2 screwdriver, tighten the screw to secure the riser to the system.



**Figure 101. Installing expansion card riser 3**

#### Next steps

1. If removed, [install expansion cards into the riser](#).
2. [Install the air shroud](#).
  - i** **NOTE:** If applicable, open the PCIe card holder latch on the air shroud to install the full length card.
3. Follow the procedure listed in [After working inside your system](#).
4. Install any device drivers required for the card as described in the documentation for the card.

## GPU or ACLR card installation guidelines

- Ensure that both the processors are installed.
- The processor must use a GPU kit low-profile heat sink module.
- To ensure adequate cooling when one or more GPUs are installed, the ambient inlet temperature is restricted to 30°C for CPU 150 W/8 C, 165 W/12 C, 200 W, 205 W. For more information, see the [www.dell.com/poweredgemanuals](http://www.dell.com/poweredgemanuals) section.
- Ensure that the GPU enablement kit is available.

The GPU enablement kit includes:

- GPU air shroud
- Mylar
- Riser 3A or 3B
- GPU cable for riser 3A or 3B
- GPU cable for riser 2A or 2E or 2D or 2F
- Riser 2A or 2E or 2D or 2F
- Riser 1A or 1D
- GPU cable for riser 1A or 1D
- Two 1U processor and heat sink modules and two CPU clips
- Six high performance cooling fans
- All GPUs must be of the same type and model.
- You can install up to three double-wide or six single-wide GPUs.
- The filler bracket on the GPU air shroud must be removed before installing the GPU.
- Ensure that high-performance fans, and GPU air shroud are installed.

**NOTE:** When using systems with GPU, ensure that you install PSUs with 1100 W or higher, and set the PSU configuration to non-redundant mode.

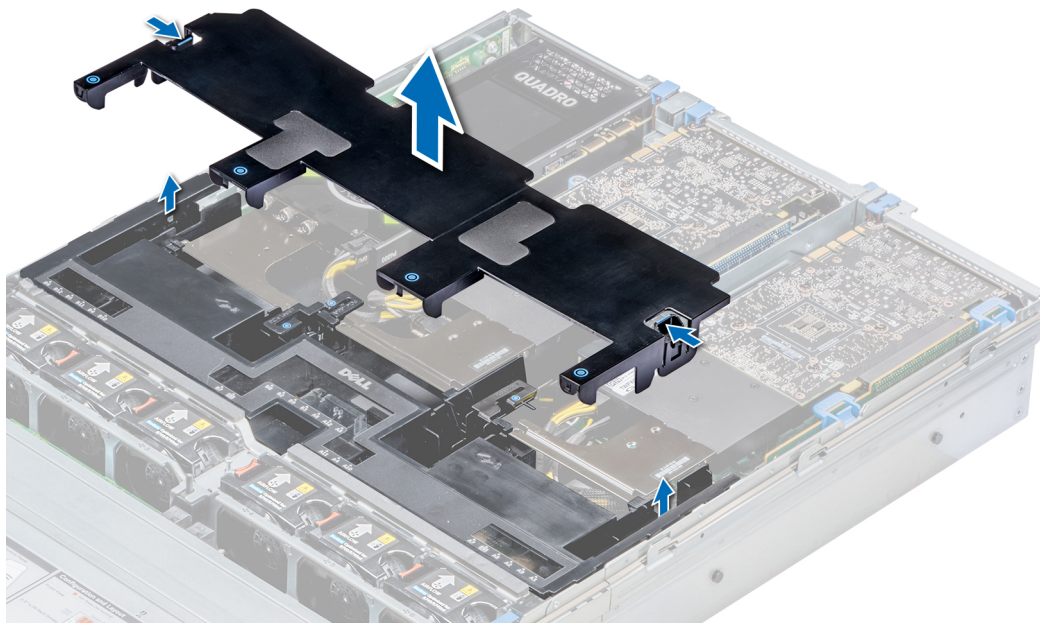
**NOTE:** Generally, any GPU that is greater than 75 W requires a power cable. GPUs with 75 W or less does not require a power cable.

## Removing a GPU

### Prerequisites

**NOTE:** Removal instructions for the FPGA are similar to the GPU card procedure.

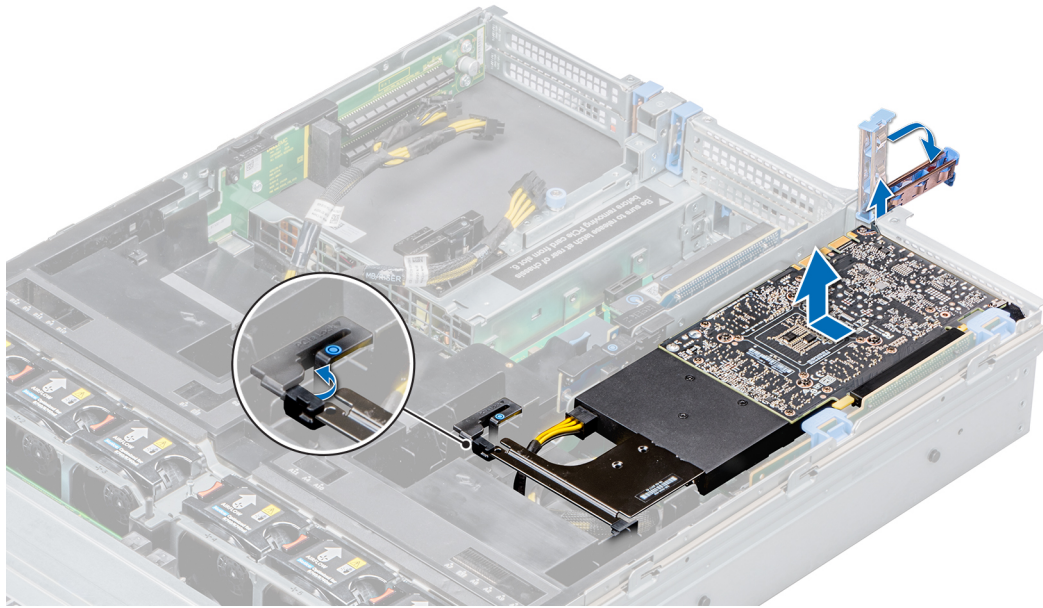
1. Follow the safety guidelines listed in [Safety instructions](#).
2. Follow the procedure listed in [Before working inside your system](#).
3. Press the blue tabs on either sides of the shroud and remove the top cover of the GPU air shroud.



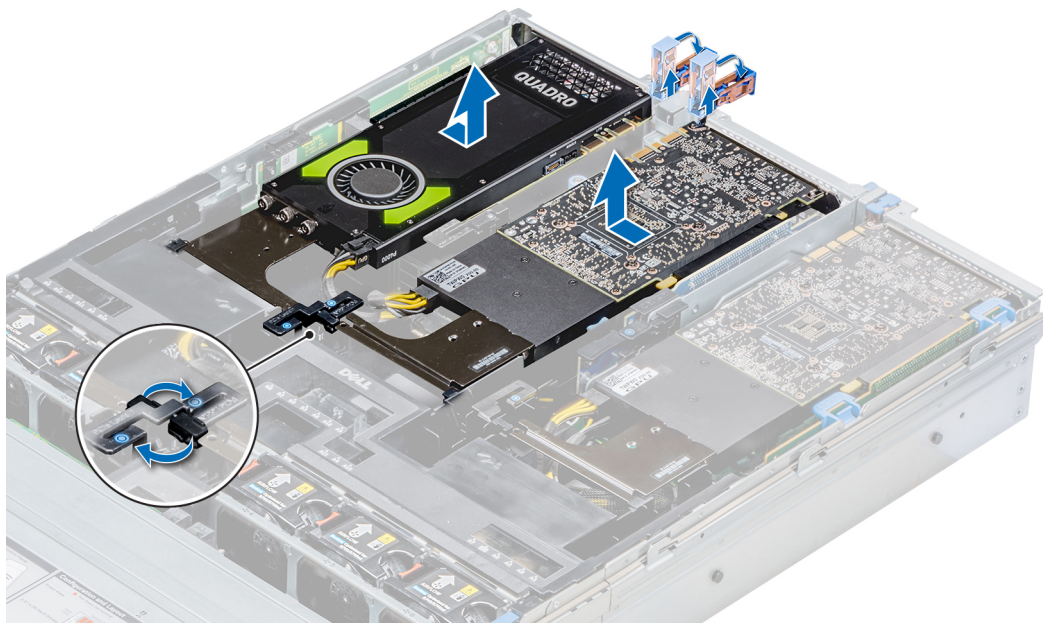
**Figure 102. Removing the top cover of GPU air shroud**

### Steps

1. Lift the expansion card latch.
2. Close the PCIe card holder latch on the GPU air shroud.
3. Hold the GPU by its edges and slide out the GPU at an angle to release it from the connector on the riser.



**Figure 103. Removing GPU 1**



**Figure 104. Removing GPU 2 and 3**

4. Disconnect the GPU/FPGA power cable from the GPU and system board.
5. If you are removing the GPU permanently, install a filler bracket over the empty slot opening, and close the expansion card latch.

**NOTE:** You must install a filler bracket over an empty expansion card slot to maintain Federal Communications Commission (FCC) certification of the system. The brackets also keep dust and dirt out of the system and aid in proper cooling and airflow inside the system. The filler bracket is necessary to maintain proper thermal conditions.

**Next steps**

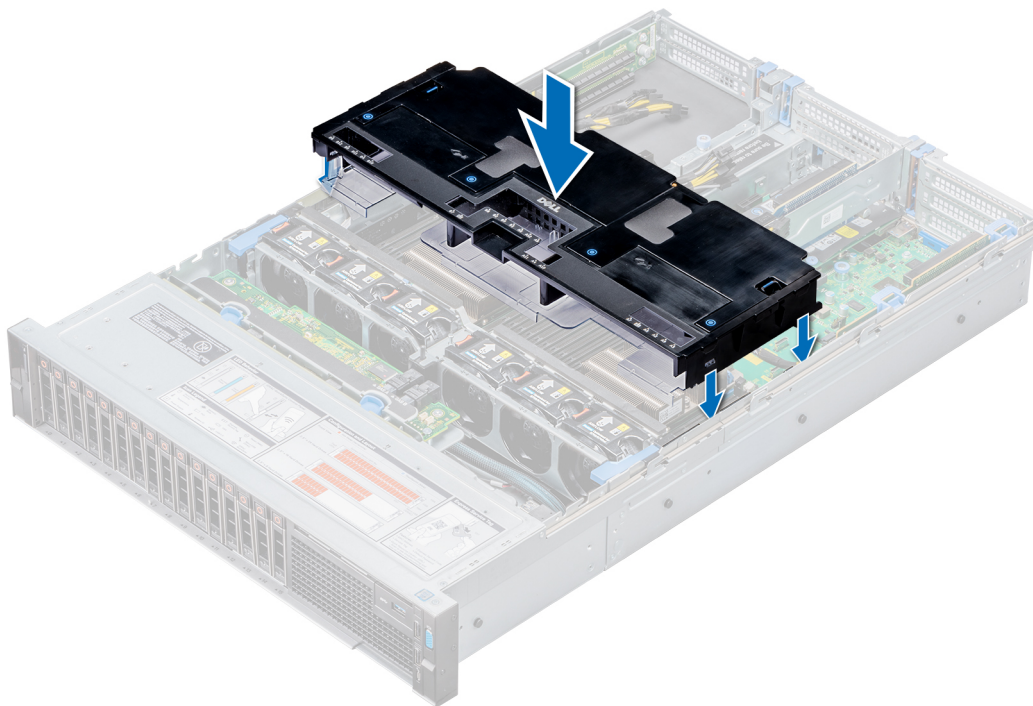
Install the GPU card.

# Installing a GPU

## Prerequisites

**i** **NOTE:** Installation instructions for the FPGA are similar to the GPU card procedure.

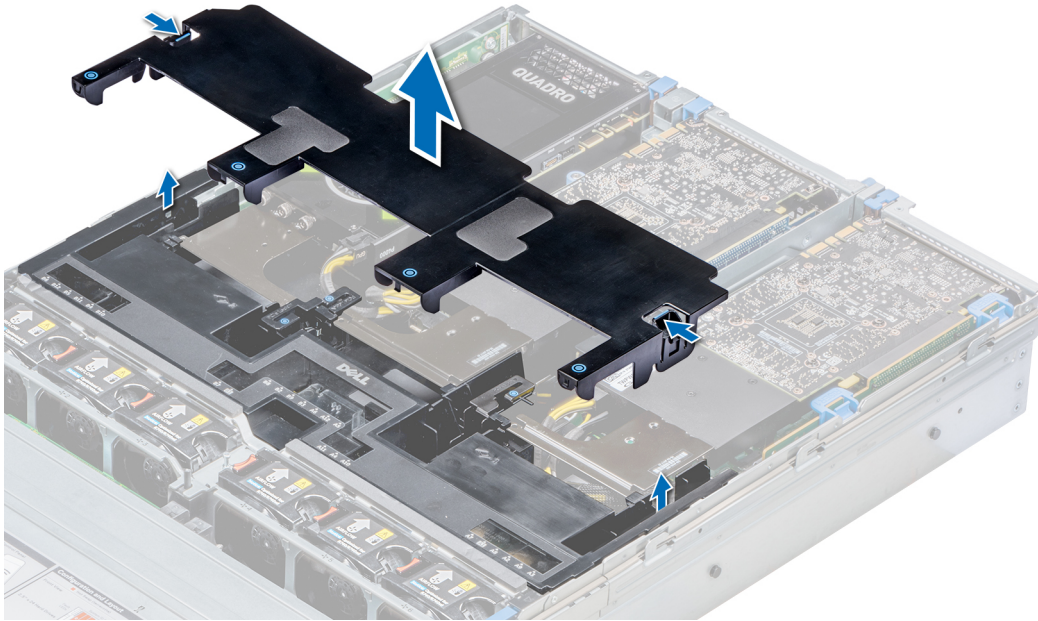
1. Follow the safety guidelines listed in [Safety instructions](#).
2. [Remove the air shroud](#).
3. [Remove the heat sink](#).
4. [Remove the cooling fans](#) and replace them with [Install the cooling fans](#).
5. Unpack the GPU cards and the GPU kit.
6. [Install the heat sink](#) from the kit.
7. [Install the risers](#).
8. Install the GPU air shroud on the system.



**Figure 105. Installing GPU air shroud**

9. Press the blue tabs on either sides of the shroud and remove the top cover of the shroud.

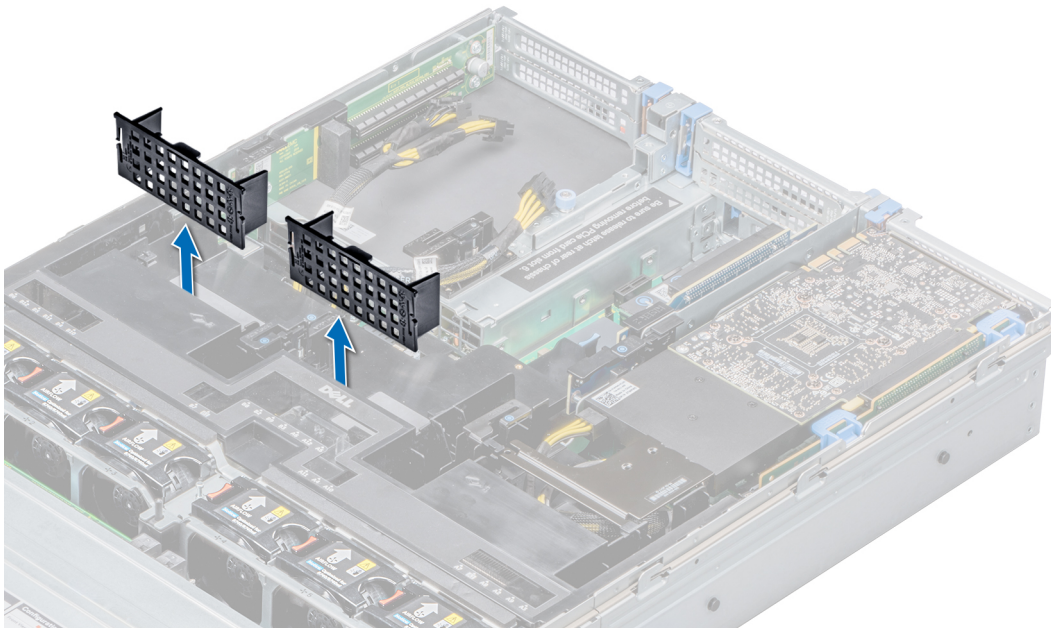




**Figure 106. Removing the top cover of the shroud**

10. If applicable, remove the shroud filler from the GPU air shroud slots.

**NOTE:** Shroud fillers are available in the GPU air shroud for GPUs installed on riser 2 and 3.



**Figure 107. Removing the shroud filler from GPU air shroud slots**

**NOTE:** Shroud fillers are available in the GPU air shroud for GPUs installed only on risers 2 and 3.

**NOTE:** Ensure that the PCIe card holder latches on GPU air shroud and risers are closed before installing the GPU. Full-length GPU do not require the PCIe card holder latch on the risers to secure the GPU in place.

**NOTE:** Ensure that you install the first GPU on riser 1.

**NOTE:** While installing a GPU on riser 3, place the GPU on the system with the GPU label side facing up.

## Steps

1. Connect the GPU/FPGA power cable to the connector on the system board.
  - i** **NOTE:** While installing a GPU on riser 1, connect the GPU/FPGA power cable to the connector on riser 1 and route the cable through the slot on the GPU air shroud.
  - i** **NOTE:** While installing a GPU on risers 2 or riser 3, connect the GPU/FPGA power cable to the connector on the system board.
2. Connect the other end of the GPU/FPGA power cable to the GPU.
3. Lift the expansion card latch and remove the filler bracket.
  - i** **NOTE:** You must install a filler bracket over an empty expansion card slot to maintain Federal Communications Commission (FCC) certification of the system. The brackets also keep dust and dirt out of the system and aid in proper cooling and airflow inside the system.
  - i** **NOTE:** The filler bracket is necessary to maintain proper thermal conditions.
4. Align the connector on the GPU with the connector on the riser.
5. Insert the GPU into the riser until it is fully seated.
6. Press the PCIe lock on the GPU air shroud and riser to release the PCIe card holder latch.
  - i** **NOTE:** Ensure that the GPU edges are seated properly in the GPU air shroud slot and PCIe card holder latch to secure the GPU in place.
7. Close the expansion card latch.

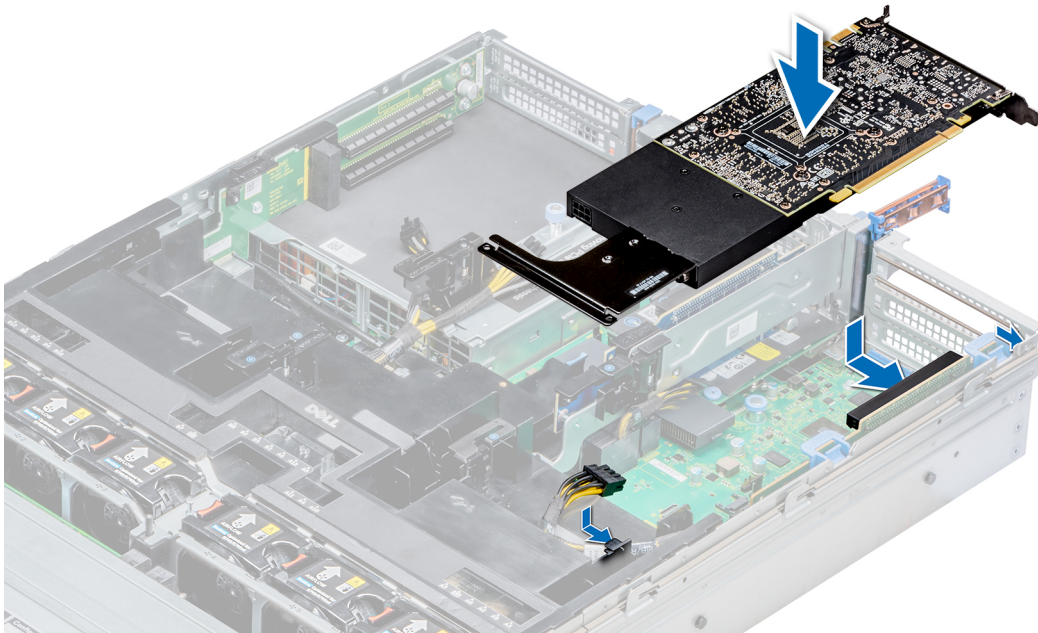


Figure 108. Installing GPU 1

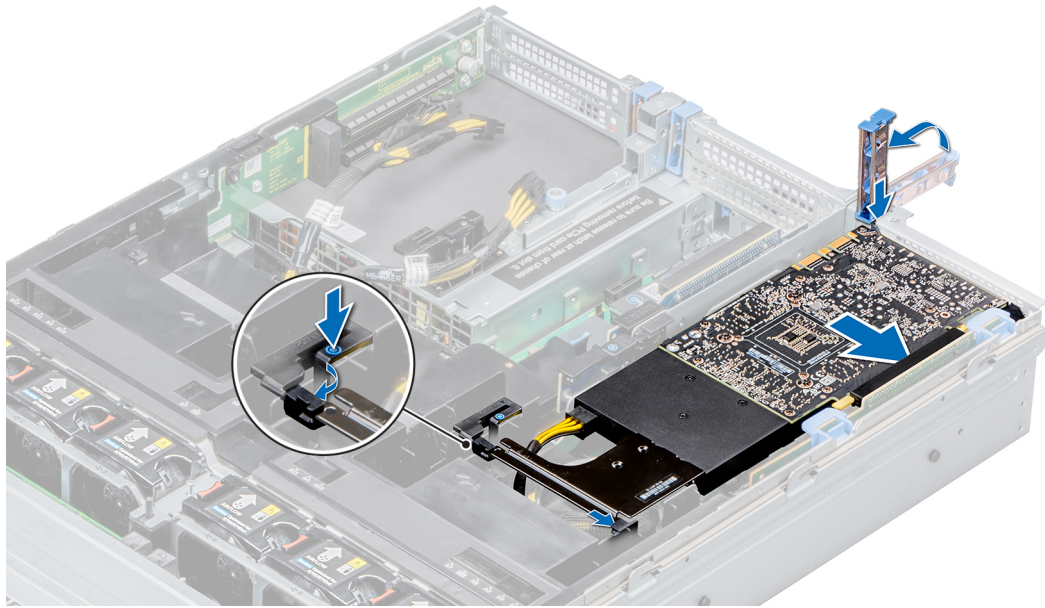


Figure 109. Securing GPU 1

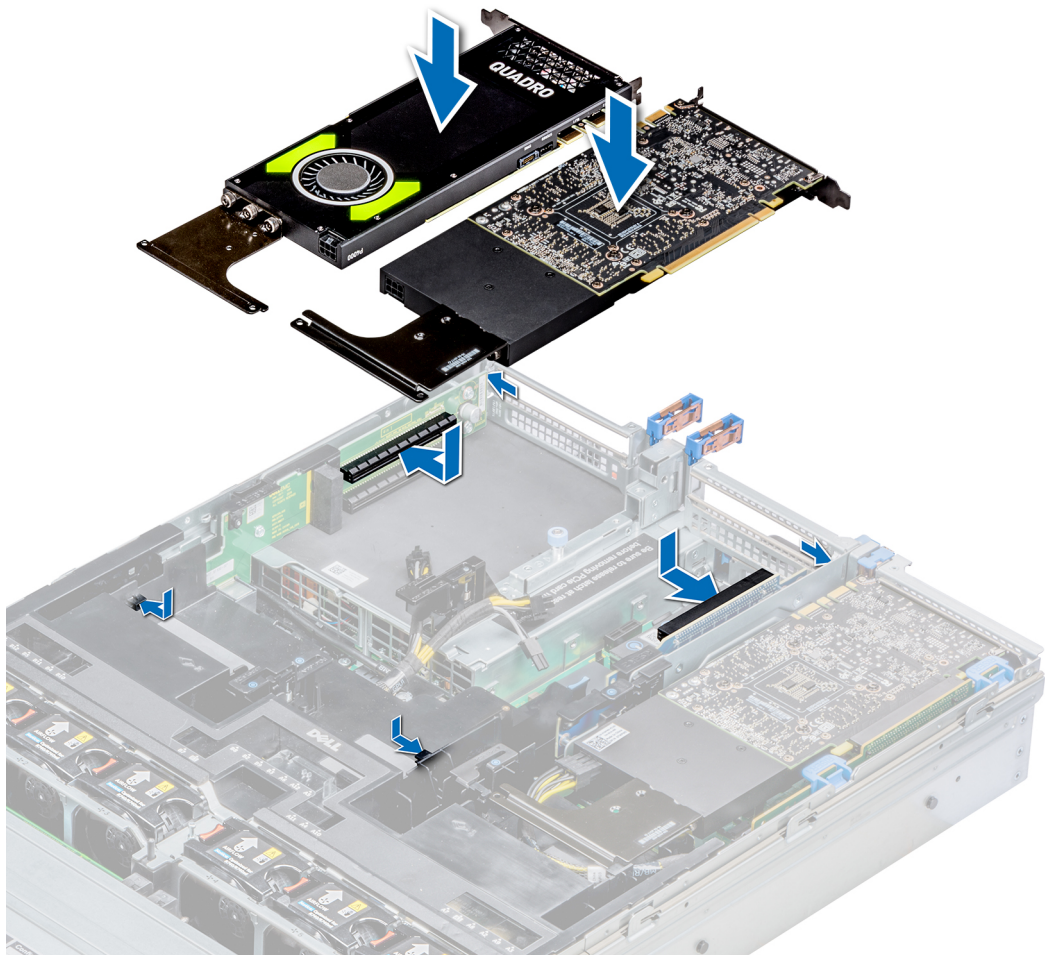
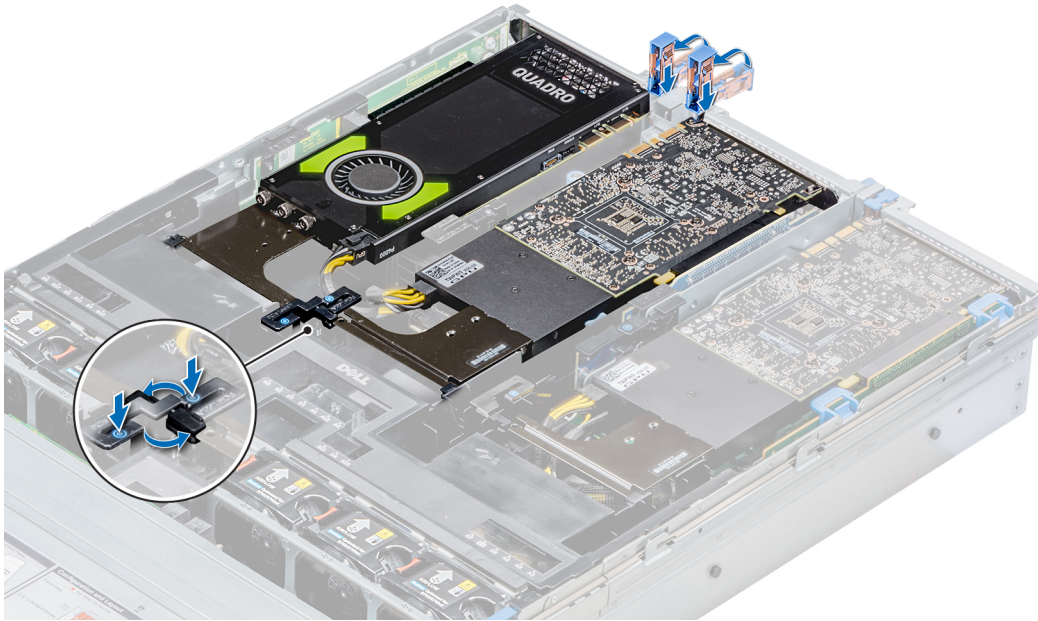


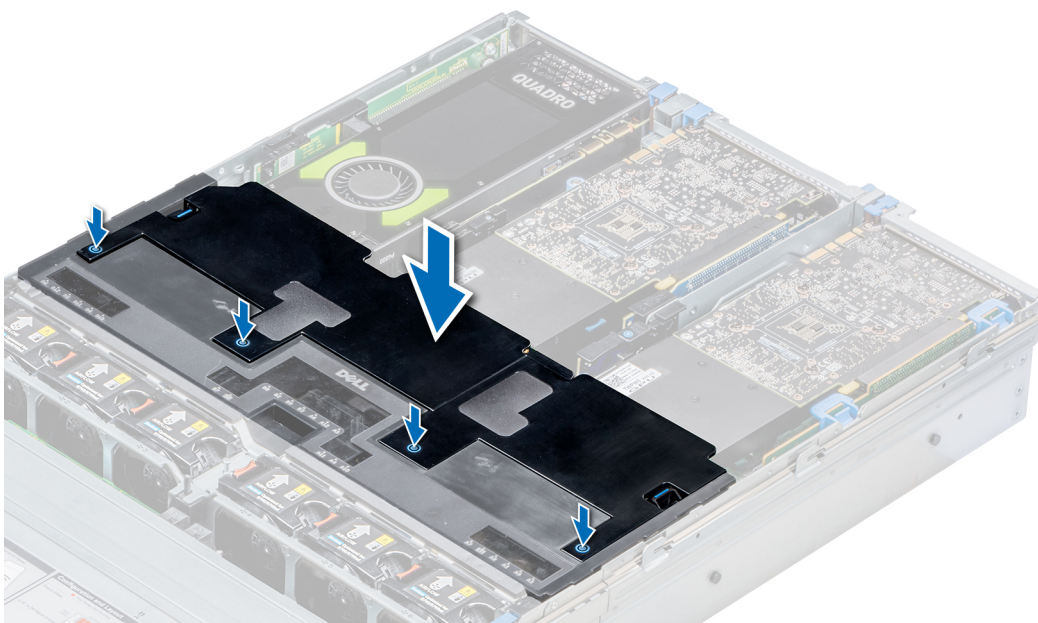
Figure 110. Installing GPU 2 and 3



**Figure 111. Securing GPU 2 and 3**

**Next steps**

1. Install the top cover of the GPU air shroud. If available, remove the plastic cover fixed on the memory socket numbers marked on the air shroud.



**Figure 112. Installing the top cover of GPU air shroud**

2. To install mylar foam on the system cover:
  - a. Place the system cover with the Service Information Label (SIL) side facing up.
  - b. For easier handling, peel off a small section of the adhesive cover and align the mylar foam with the system cover.
  - c. Remove rest of the adhesive cover and install mylar foam on the system cover.
  - d. Press along the length of the mylar foam to ensure that it is firmly affixed to the system cover.



**Figure 113. Installing mylar foam on the system cover**

3. Follow the procedure listed in [After working inside your system](#).

## M.2 SSD module

### Removing the M.2 SSD module

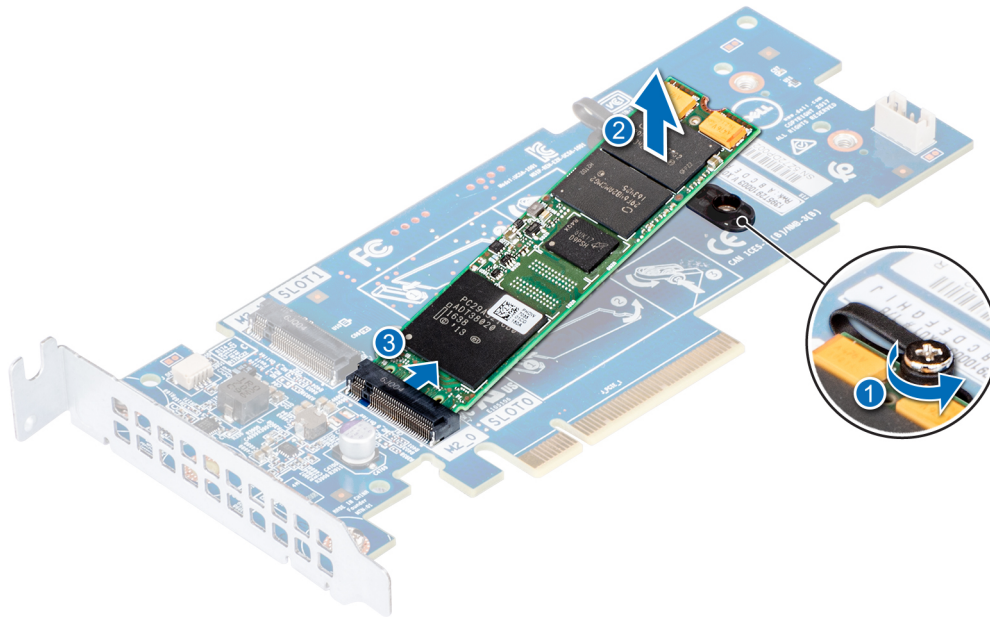
#### Prerequisites

1. Follow the safety guidelines listed in [Safety instructions](#).
2. Follow the procedure listed in [Before working inside your system](#).
3. [Remove the air shroud](#).
4. Remove the BOSS card.

**NOTE:** Removing the BOSS card is similar to the procedure for removing an expansion card riser.

#### Steps

1. Loosen the screws and lift the retention straps that secure the M.2 SSD module on the BOSS card.
2. Pull the M.2 SSD module away from the BOSS card.



**Figure 114. Removing the M.2 SSD module**

### Next steps

Install the M.2 SSD module.

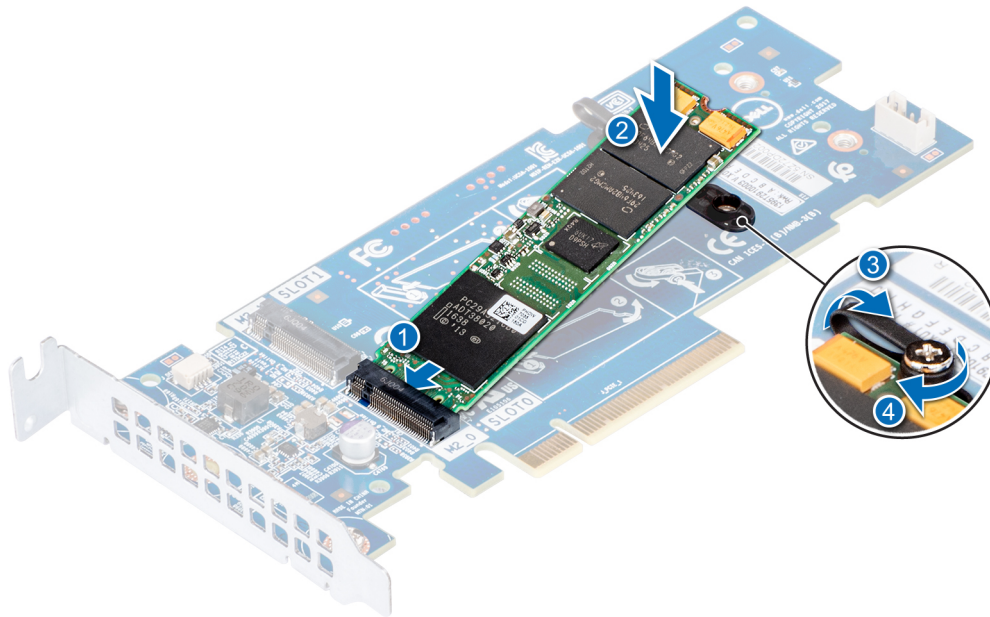
## Installing the M.2 SSD module

### Prerequisites

1. Follow the safety guidelines listed in [Safety instructions](#).

### Steps

1. Align the M.2 SSD module connectors with the connectors on the BOSS card.
2. Push the M.2 SSD module until the module is seated firmly on the BOSS card.
3. Secure the M.2 SSD module on the BOSS card with the retention straps and screws.



**Figure 115. Installing the M.2 SSD module**

### Next steps

1. Install the BOSS card.
  - i** **NOTE:** Installing the BOSS card is similar to installing the expansion card riser.
2. [Install the air shroud](#) .
3. Follow the procedure listed in [After working inside your system](#).

## Optional MicroSD or vFlash card

### Removing the MicroSD and vFlash card

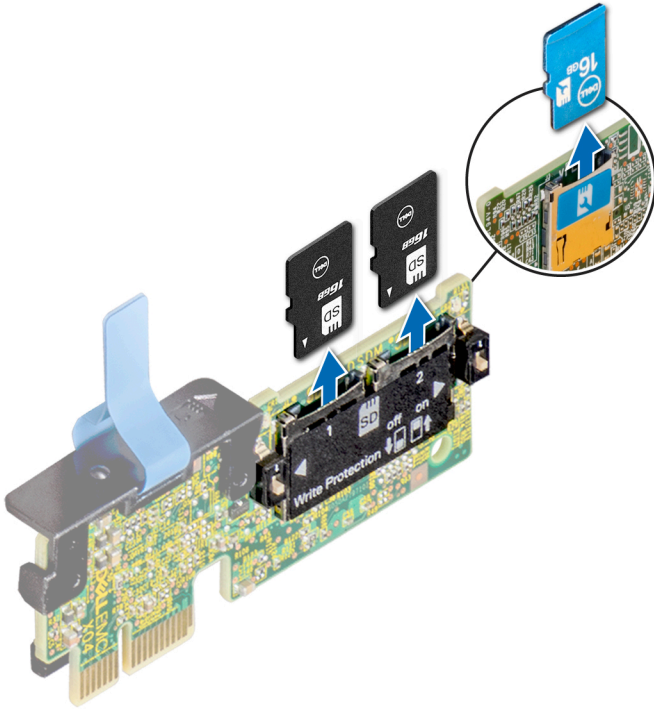
#### Prerequisites

1. Follow the safety guidelines listed in [Safety instructions](#).
2. Follow the procedure listed in [Before working inside your system](#).

#### Steps

1. Locate the MicroSD card slot on the vFlash/IDSDM module, and press the card to partially release it from the slot. To locate IDSDM/vFlash module, see the [System board jumpers and connectors](#) section.
2. Hold the MicroSD card and remove it from the slot.

**i** **NOTE:** Temporarily label each MicroSD card with its corresponding slot number after removal.



### Next steps

Install the MicroSD card.

## Installing the MicroSD and vFlash card

### Prerequisites

Follow the safety guidelines listed in [Safety instructions](#).

**NOTE:** To use an MicroSD card with your system, ensure that the **Internal SD Card Port** is enabled in System Setup.

**NOTE:** If reinstalling, ensure that you install the MicroSD cards into the same slots based on the labels you had marked on the cards during removal.

### Steps

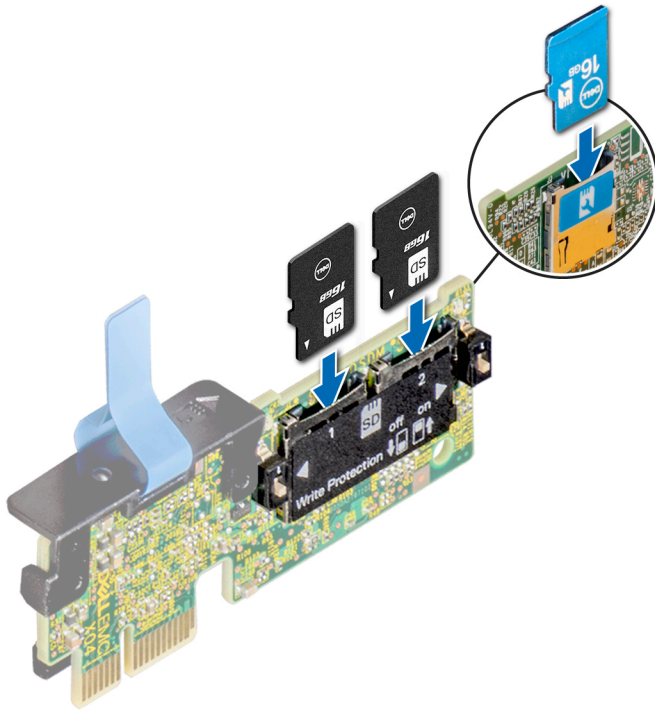
1. Locate the MicroSD card connector on the IDSDM/vFlash module. Orient the MicroSD card appropriately and insert the contact-pin end of the card into the slot.

To locate IDSDM/vFlash, see the [System board jumpers and connectors](#) section.

**NOTE:** The slot is keyed to ensure correct insertion of the card.

2. Press the card into the card slot to lock it into place.





### Next steps

Follow the procedure listed in [After working inside your system](#).

## Optional IDSDM or vFlash module

### Removing the optional IDSDM or vFlash module

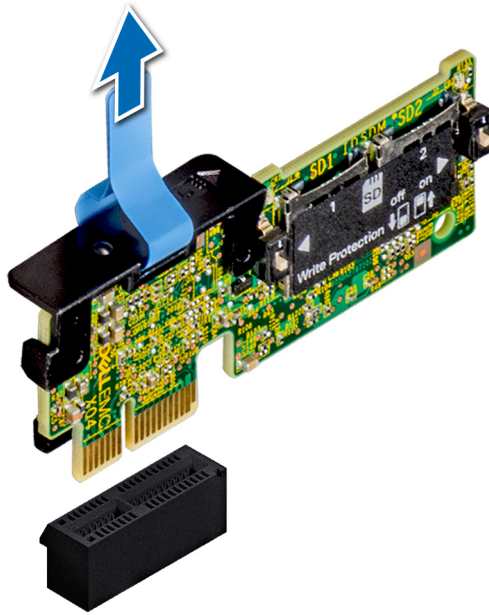
#### Prerequisites

1. Follow the safety guidelines listed in [Safety instructions](#).
2. Follow the procedure listed in [Before working inside your system](#).
3. If applicable, [remove rear drive cage](#).
4. If applicable, remove the full-height PCIe cards.
5. If you are replacing the IDSDM/vFlash card, remove the MicroSD cards.

**NOTE:** Temporarily label each MicroSD card with its corresponding slot number after removal.

#### Steps

1. Locate the IDSDM/vFlash connector on the system board.  
To locate IDSDM/vFlash connector, see the [System board jumpers and connectors](#) section.
2. Holding the pull tab, lift the IDSDM/vFlash card out of the system.



**Figure 116. Removing the optional IDSDM/vFlash module**

**NOTE:** There are two dip switches on the IDSDM/vFlash card for write-protection.

#### Next steps

Install the optional IDSDM/vFlash module.

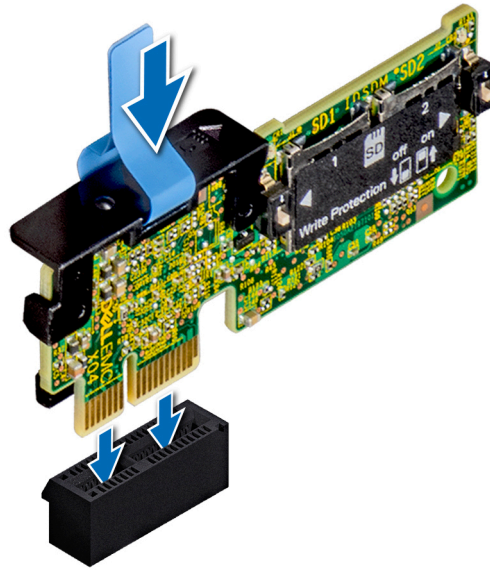
## Installing optional IDSDM or vFlash module

#### Prerequisites

Follow the safety guidelines listed in [Safety instructions](#).

#### Steps

1. Locate the IDSDM/vFlash connector on the system board.  
To locate IDSDM/vFlash connector, see the [System board jumpers and connectors](#) section.
2. Align the IDSDM/vFlash card with the connector on the system board.
3. Push the IDSDM/vFlash card until it is firmly seated on the system board.



**Figure 117. Installing optional IDSDM/vFlash card**

### Next steps

1. [Install the MicroSD cards.](#)

**NOTE:** Reinstall the MicroSD cards into the same slots based on the labels you had marked on the cards during removal.

2. If applicable, [install the rear drive cage.](#)
3. If applicable, install the full height PCIe card.
4. Follow the procedure listed in [After working inside your system.](#)

## Network daughter card

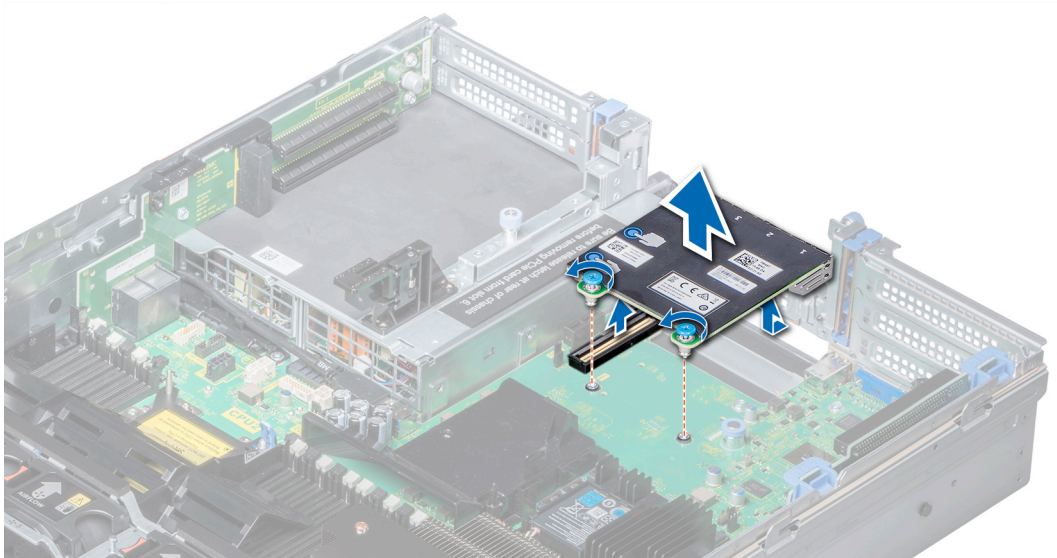
### Removing the network daughter card

#### Prerequisites

1. Follow the safety guidelines listed in [Safety instructions.](#)
2. Follow the procedure listed in [Before working inside your system.](#)
3. If applicable, [remove the expansion card riser 2.](#)
4. If applicable, [remove the rear drive cage.](#)

#### Steps

1. Using a Phillips #2 screwdriver, loosen the captive screws that secure the network daughter card (NDC) to the system board.
2. Hold the NDC by the edges on either side of the touch points, and lift to remove it from the connector on the system board.
3. Slide the NDC towards the front of the system until the Ethernet connectors are clear of the slot in the back panel.



**Figure 118. Removing network daughter card**

### Next steps

Install the Network Daughter Card.

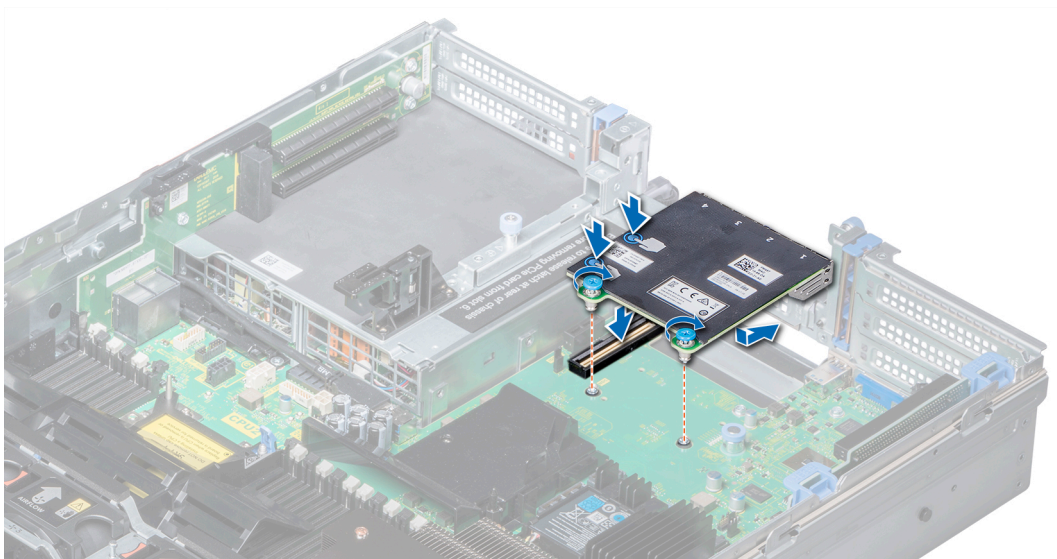
## Installing the network daughter card

### Prerequisites

Follow the safety guidelines listed in [Safety instructions](#).

### Steps

1. Orient the NDC so that the Ethernet connectors fit through the slot in the chassis.
2. Align the captive screws at the back-end of the card with the screw holes on the system board.
3. Press the touch points on the card until the card connector is firmly seated on the system board connector.
4. Using a Phillips #2 screwdriver, tighten the captive screws to secure the NDC to the system board.



**Figure 119. Installing the network daughter card**

### Next steps

1. If applicable, [install the expansion card riser 2](#).
2. If applicable, install the [rear drive cage](#).
3. Follow the procedure listed in [After working inside your system](#).

## Integrated storage controller card

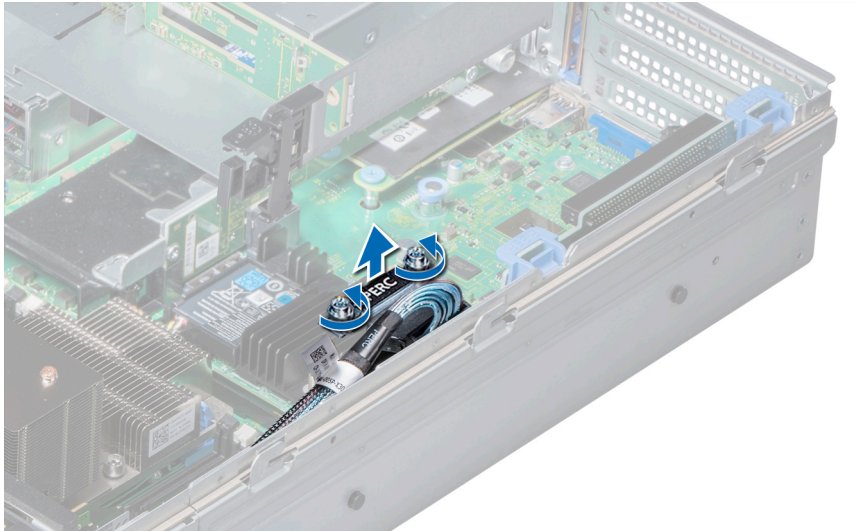
### Removing integrated storage controller card

#### Prerequisites

1. Follow the safety guidelines listed in [Safety instructions](#).
2. Follow the procedure listed in [Before working inside your system](#).
3. [Remove the air shroud](#).
4. [Remove the expansion card riser 1](#).

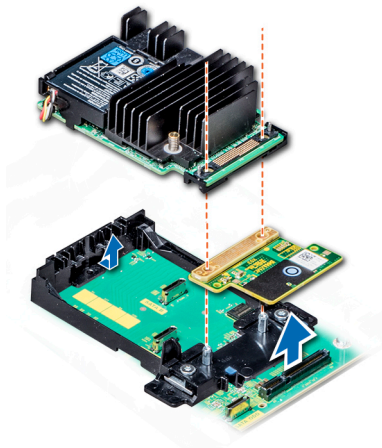
#### Steps

1. Using Phillips #2 screwdriver, loosen the screws that secure the integrated storage controller cable to the system board.
2. Lift the integrated storage controller cable away from the integrated storage controller.



**Figure 120. Removing integrated storage controller cable**

3. Lift one end of the card and angle it to disengage the card from the integrated storage controller card holder on the system board.
4. Lift the card out of the system.
5. Hold the interposer board by its edges, and pull the board until the connector on the board disengages from the connector on the system board.



**Figure 121. Removing integrated storage controller card**

### Next steps

Install the integrated storage controller card.

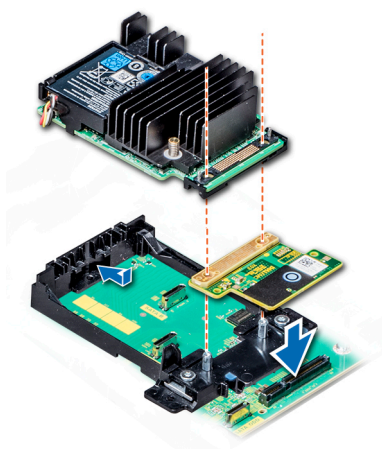
## Installing integrated storage controller card

### Prerequisites

Follow the safety guidelines listed in [Safety instructions](#).

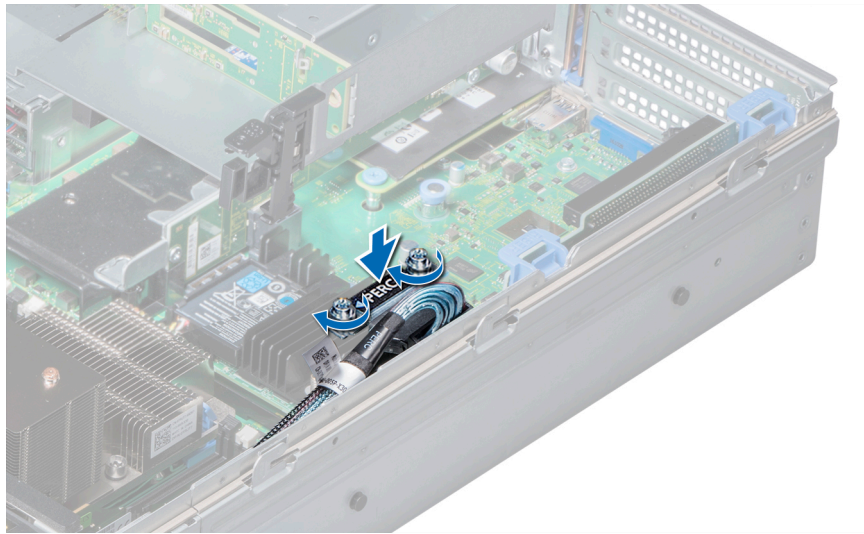
### Steps

1. Hold the interposer board by its edges, and align the interposer board connector with the connector on the system board.
2. Press the touch point on the interposer board until the interposer board connector is firmly seated on the system board connector.
3. Angle the card to engage the card with the integrated storage controller card holder on the system board.
4. Lower the card into place until the card is fully seated in the integrated storage controller card holder.



**Figure 122. Installing integrated storage controller card**

5. Align the screws on the integrated storage controller card cable with the screw holes on the system board.
6. Using Phillips #2 screwdriver, tighten the screws to secure the integrated storage controller card cable to the system board.



**Figure 123. Installing integrated storage controller card cable**

**Next steps**

1. Install the expansion card riser 1.
2. Install the air shroud.
3. Follow the procedure listed in [After working inside your system.](#)

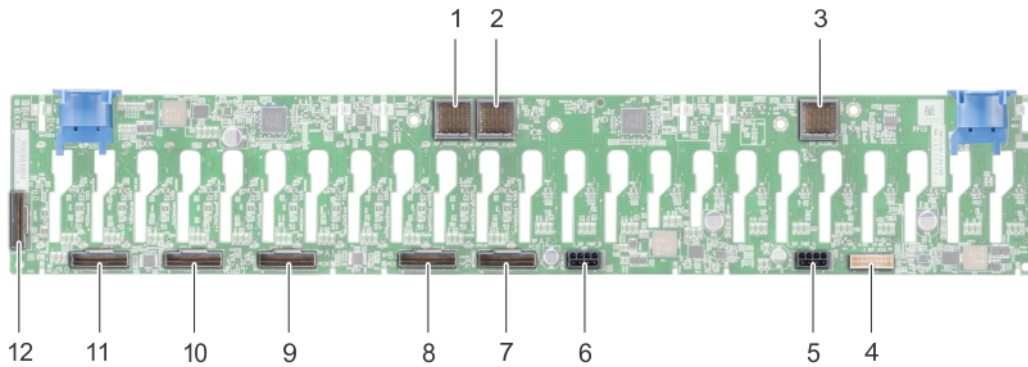
## Backplane

### Backplane details

Depending on your system configuration, the drive backplanes supported in PowerEdge R740xd are listed here:

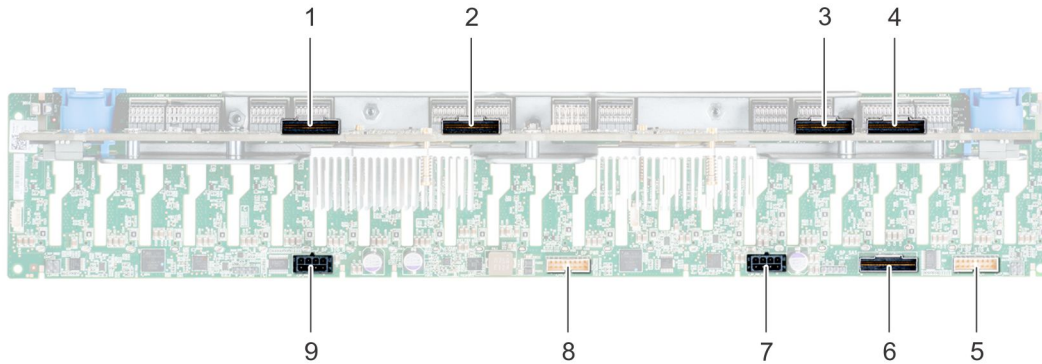
**Table 28. Supported backplane options for PowerEdge R740XD systems.**

System	Supported backplane options
PowerEdge R740xd	2.5 inch (x24) SAS/SATA/NVMe backplane or
	2.5 inch (x24) SAS/SATA/NVMe backplane, 2.5 inch (x4) SAS/SATA backplane on the mid drive tray and 2.5 inch (x4) SAS/SATA backplane (back) or
	2.5 inch (x24) SAS/SATA/NVMe backplane which supports 20 SAS/SATA drives and 4 NVMe drives, or
	3.5 inch (x12) SAS/SATA backplane, or
	3.5 inch (x12) SAS/SATA backplane, 3.5 inch (x4) SAS/SATA backplane on the mid drive tray and 3.5 inch (x2) SAS/SATA backplane (back), or
	3.5 inch (x12) SAS/SATA backplane, 3.5 inch (x4) SAS/SATA backplane on the mid drive tray and 2.5 inch (x4) SAS/SATA backplane (back) or
	3.5 inch (x12) SAS/SATA backplane and 3.5 inch (x2) SAS/SATA backplane (back) or
	3.5 inch (x12) SAS/SATA backplane and 2.5 inch (x4) SAS/SATA backplane (back) or
	2.5 inch (x24) NVMe backplane
	3.5 inch (x12) Hybrid backplane with NVMe U.2 SSD



**Figure 124. Back view of 24 x 2.5-inch backplane**

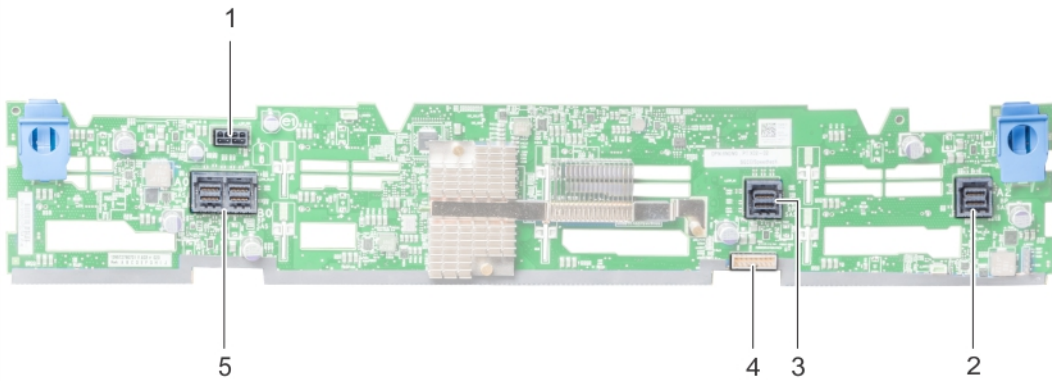
- |  |   |
|--|---|
| 1. backplane to expander board connector (BP_XCEDE_3)  | 2. backplane to expander board connector (BP_XCEDE_2) |
| 3. backplane to expander board connector (BP_XCEDE_31) | 4. signal connector (J_BP_SIG)                        |
| 5. power connector (J_PWR_A)                           | 6. power connector (J_PWR_B)                          |
| 7. PCIe connector (BP PCIE A2)                         | 8. PCIe connector (BP PCIE B2)                        |
| 9. PCIe connector (BP PCIE A1)                         | 10. PCIe connector (BP PCIE B1)                       |
| 11. PCIe connector (BP PCIE A0)                        | 12. PCIe connector (BP PCIE B0)                       |



**Figure 125. Back view of 24 x 2.5-inch (24 NVMe) backplane**

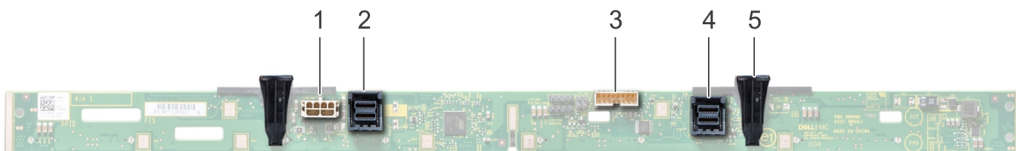
- |  |  |
|--|--|
| 1. expander board connector B1 (PE1_B) | 2. expander board connector A1 (PE1_A) |
| 3. expander board connector B2 (PE2_B) | 4. expander board connector A2 (PE2_A) |
| 5. signal connector (J_SIG_A1)         | 6. SAS connector (J_BP_SAS)            |
| 7. power connector (J_BP_PWR_A1)       | 8. signal connector (J_SIG_A2)         |
| 9. power connector (J_BP_PWR_A2)       |  |





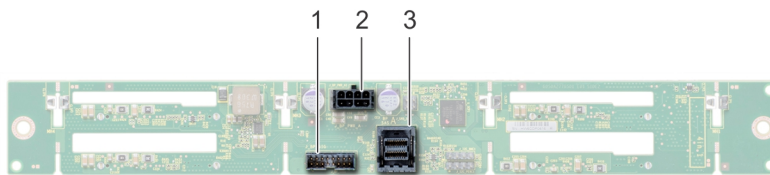
**Figure 126. Back view of 12 x 3.5-inch backplane**

- |                                |                               |
|--------------------------------|-------------------------------|
| 1. power connector (J_BP_PWR)  | 2. SAS connector (A2 BP SAS)  |
| 3. SAS connector (A1 BP SAS)   | 4. signal connector (BP SIG1) |
| 5. SAS connector (J_SAS_A0_B0) |                               |



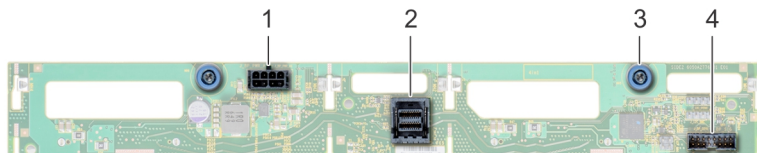
**Figure 127. Back view of 3.5-inch backplane (mid drive tray)**

- |                                |                             |
|--------------------------------|-----------------------------|
| 1. power connector (J_BP_PWR)  | 2. SAS connector (J_SAS_A1) |
| 3. signal connector (J_BP_SIG) | 4. SAS connector (J_SAS_B1) |
| 5. release tab (2)             |                             |



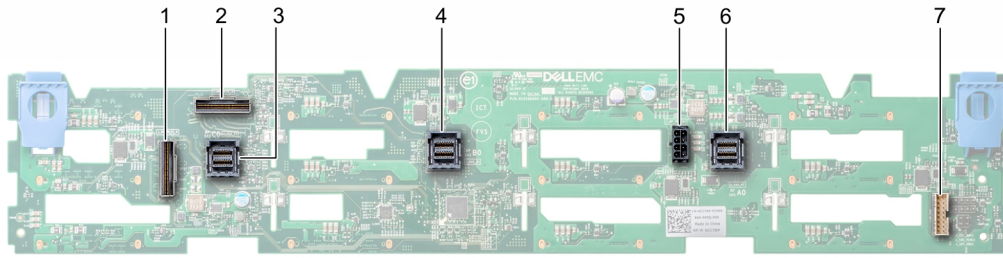
**Figure 128. Back view of 2.5-inch backplane (rear drive cage)**

- |                                 |
|---------------------------------|
| 1. signal connector (J_BP_SIG)  |
| 2. power connector (J_BP_PWR_A) |
| 3. SAS connector (J_SAS_1)      |



**Figure 129. Back view of 3.5-inch backplane (rear drive cage)**

- |                                 |                                |
|---------------------------------|--------------------------------|
| 1. power connector (J_BP_PWR_A) | 2. SAS connector (J_SAS_A)     |
| 3. release pin (2)              | 4. signal connector (J_BP_SIG) |



**Figure 130. Back view of the hybrid backplane with 3.5-inch Hot-Plug drive (both SATA and SAS) with NVMe U.2 SSD**

- |                                   |                                  |
|-----------------------------------|----------------------------------|
| 1. PCIe connector (J_BP_PCl_e_B)  | 2. PCIe connector (J_BP_PCl_e_A) |
| 3. SAS connector (J_SAS_C1)       | 4. SAS connector (J_SAS_B1)      |
| 5. power connector (J_BP_PWR_A1)  | 6. SAS connector (J_SAS_A1)      |
| 7. Sideband connector (J_BP_SIG1) |                                  |

## Removing the backplane

The procedure to remove the backplane is identical for all backplane configurations.

### Prerequisites

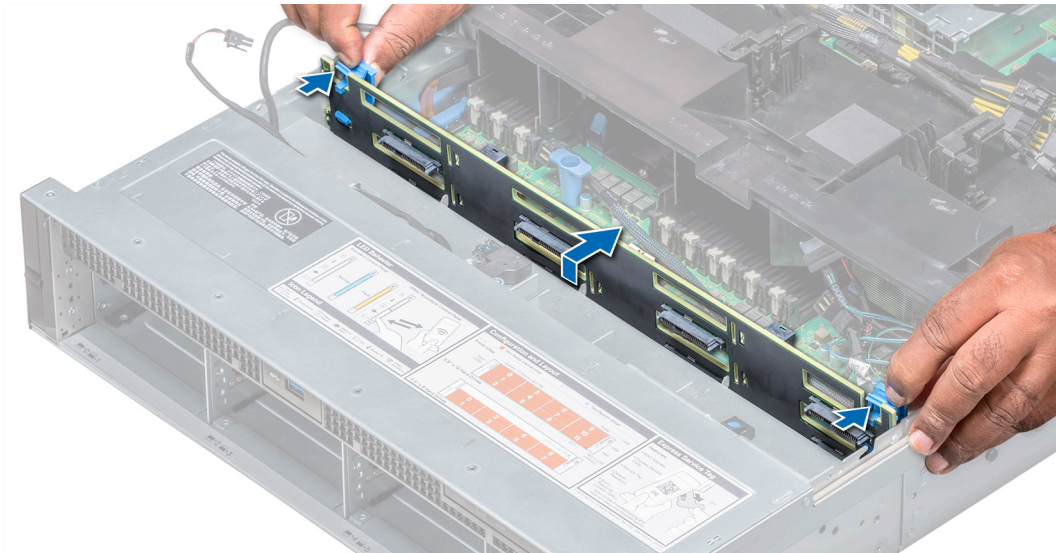
**CAUTION:** To prevent damage to the drives and backplane, remove the drives from the system before removing the backplane.

**CAUTION:** Note the number of each drive and temporarily label them before you remove the drive so that you can replace them in the same locations.

1. Follow the safety guidelines listed in [Safety instructions](#).
2. Follow the procedure listed in [Before working inside your system](#).
3. [Remove the air shroud](#).
4. [Remove the cooling fan assembly](#).
5. [Remove the backplane cover](#).
6. [Remove all drives](#).
7. Disconnect all the cables from the backplane.

### Steps

Press the release tabs and lift the backplane to disengage the backplane from the hooks on the system.



**Figure 131. Removing the backplane**

### Next steps

Install the backplane.

## Installing the backplane

The procedure to install the backplane is identical for all backplane configurations.

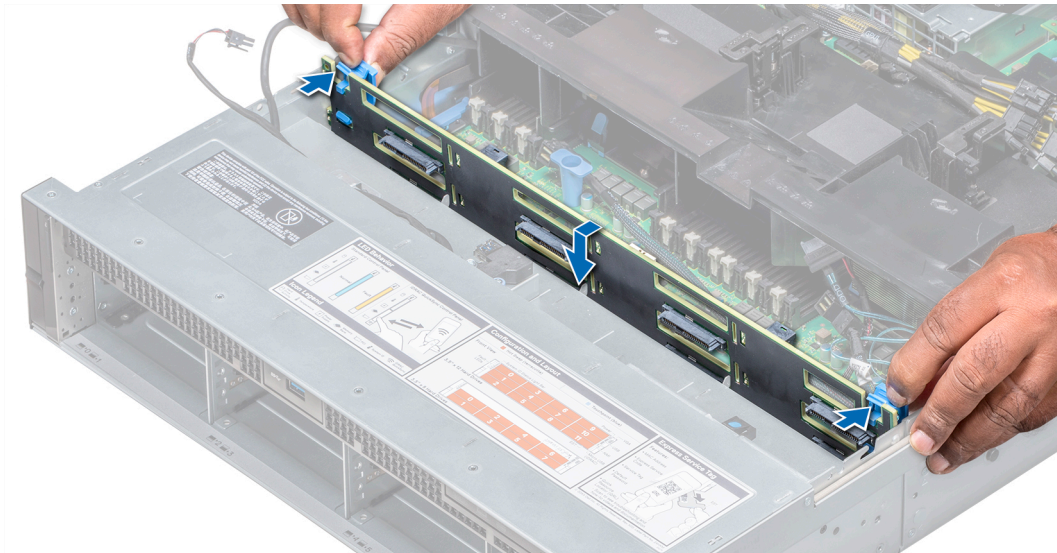
### Prerequisites

Follow the safety guidelines listed in [Safety instructions](#).

**CAUTION:** To prevent damage to the control panel flex cable, do not bend the control panel flex cable after it is inserted into the connector.

### Steps

1. Use the hooks on the system as guides to align the backplane.
2. Lower the backplane until the release tabs snap into place. If applicable, tighten the captive screws on the backplane.



**Figure 132. Installing the backplane**

### Next steps

1. Connect all the cables to the backplane.
2. [Install all the drives.](#)
3. [Install the backplane cover.](#)
4. [Install the cooling fan assembly.](#)
5. [Install the air shroud.](#)
6. Follow the procedure listed in [After working inside your system.](#)

## Removing mid drive tray backplane

The procedure to remove the backplane is identical for 2.5 and 3.5 inch configurations.

### Prerequisites

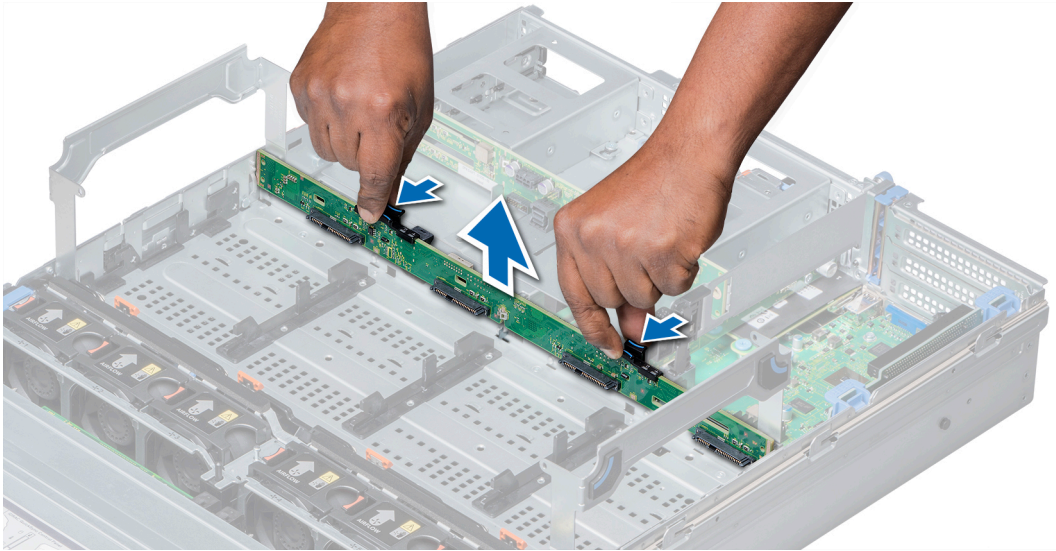
**CAUTION:** To prevent damage to the drives and backplane, you must remove the drives from the system before removing the backplane.

**CAUTION:** You must note the number of each drive and temporarily label them before removal so that you can replace them in the same locations.

1. Follow the safety guidelines listed in [Safety instructions.](#)
2. Follow the procedure listed in [Before working inside your system.](#)
3. [Remove all the drive carriers from the mid drive tray.](#)
4. Disconnect all the cables from the backplane.

### Steps

Press the release tabs and lift the backplane out of the drive tray.



**Figure 133. Removing mid drive tray backplane**

**Next steps**

Install the mid drive tray backplane.

## Installing mid drive tray backplane

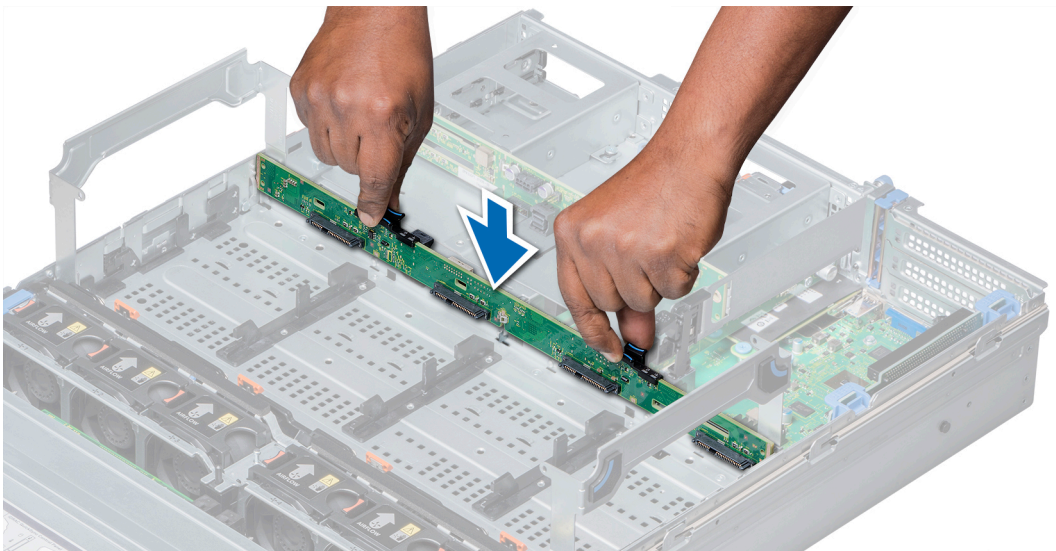
The procedure to install the backplane is identical for 2.5 and 3.5 inch configurations.

**Prerequisites**

Follow the safety guidelines listed in [Safety instructions](#).

**Steps**

Align the drive backplane with the guide pin on the system and lower the drive backplane into the system until it is firmly seated.



**Figure 134. Installing mid drive tray backplane**

### Next steps

1. Connect all the cables to the backplane.
2. [Install all the drives carriers into the mid drive tray.](#)
3. Follow the procedure listed in [After working inside your system.](#)

## Removing the 3.5 inch drive rear backplane

### Prerequisites

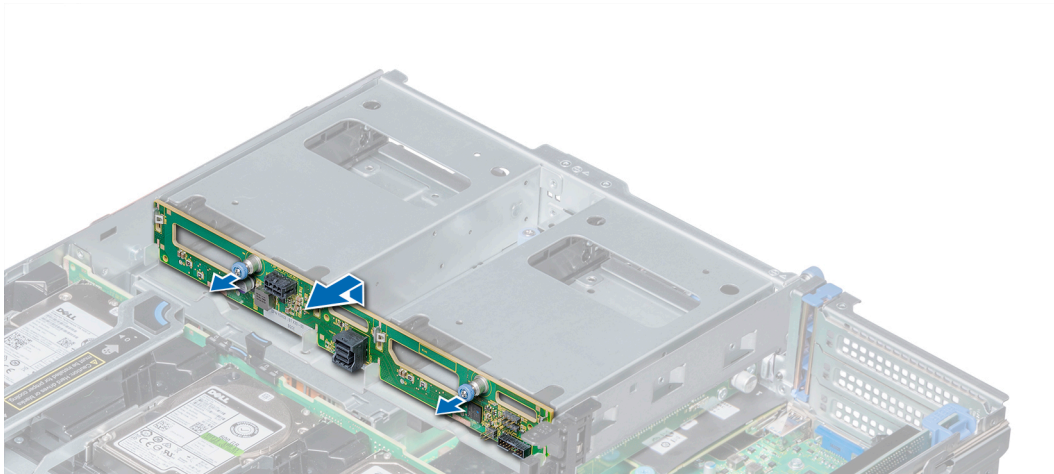
**CAUTION:** To prevent damage to the drives and backplane, you must remove the drives from the system before removing the backplane.

**CAUTION:** You must note the number of each drive and temporarily label them before removal so that you can replace them in the same locations.

1. Follow the safety guidelines listed in [Safety instructions.](#)
2. Follow the procedure listed in [Before working inside your system.](#)
3. [Remove all the drives.](#)
4. Disconnect all the cables from the backplane.

### Steps

1. Pull the release pins, and lift the drive backplane to disengage the backplane from the hooks on the rear drive module.
2. Remove the backplane from the system.



**Figure 135. Removing the 3.5 inch drive rear backplane**

### Next steps

[Install the 3.5 inch rear backplane.](#)

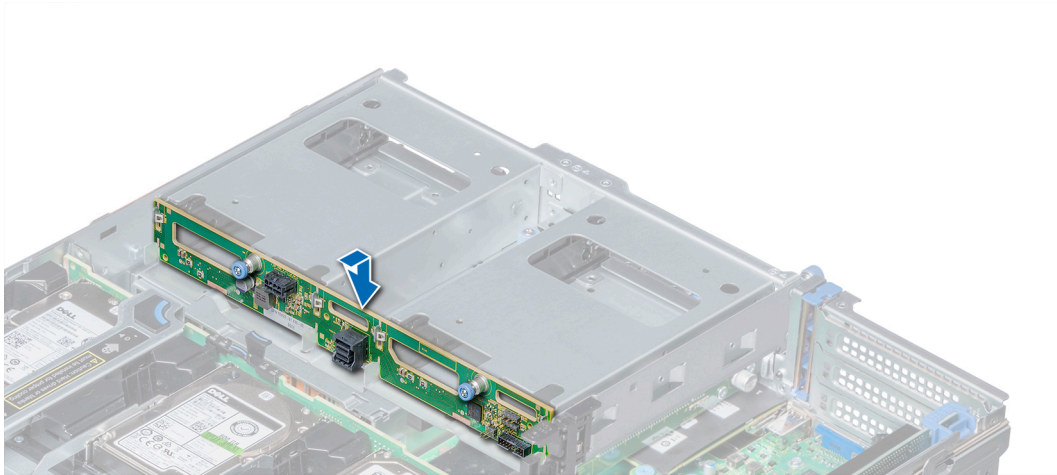
## Installing the 3.5 inch drive rear backplane

### Prerequisites

Follow the safety guidelines listed in [Safety instructions.](#)

### Steps

1. Use the hooks on the rear drive module as guides to align the drive backplane.
2. Lower the backplane into the system until it is firmly seated.



**Figure 136. Installing the 3.5 inch drive rear backplane**

### Next steps

1. [Install all the drives.](#)
2. Connect all the cables to the backplane.
3. Follow the procedure listed in [After working inside your system.](#)

## Removing the 2.5 inch drive rear backplane

### Prerequisites

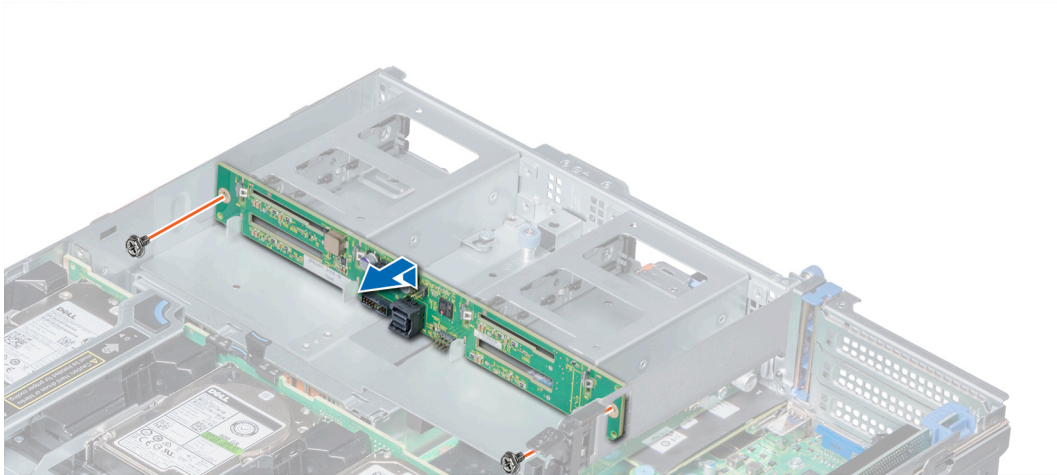
**CAUTION:** To prevent damage to the drives and backplane, you must remove the drives from the system before removing the backplane.

**CAUTION:** You must note the number of each drive and temporarily label them before removal so that you can replace them in the same locations.

1. Follow the safety guidelines listed in [Safety instructions.](#)
2. Follow the procedure listed in [Before working inside your system.](#)
3. [Remove all drives.](#)
4. Disconnect all the cables from the backplane.

### Steps

1. Using Phillips #2 screwdriver, remove the screws that secure the drive backplane to the rear drive cage.
2. Disengage the backplane from the hooks on the rear drive cage, and remove it from the rear drive cage.



**Figure 137. Removing the 2.5 inch drive rear backplane**

### Next steps

Install the 2.5 inch drive rear backplane.

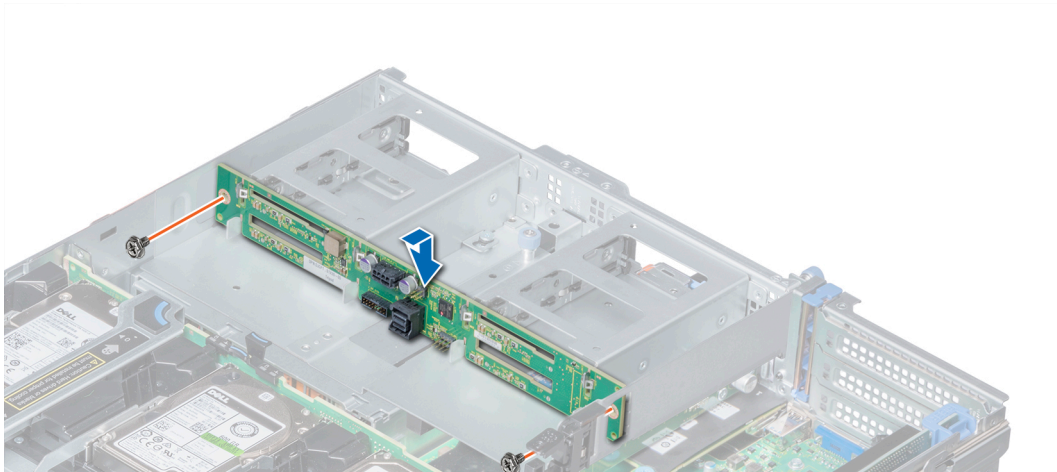
## Installing the 2.5 inch drive rear backplane

### Prerequisites

Follow the safety guidelines listed in [Safety instructions](#).

### Steps

1. Use the hooks on the rear drive cage as guides to align the drive backplane.
2. Lower the backplane into the system until it is firmly seated.
3. Using Phillips #2 screwdriver, replace the screws to secure the backplane to the rear drive cage.



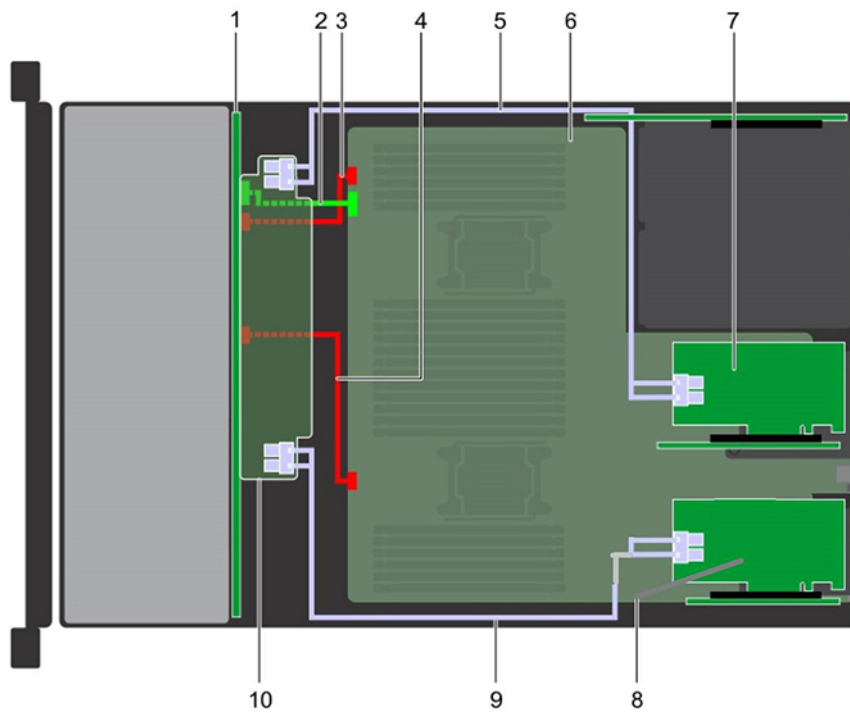
**Figure 138. Installing the 2.5 inch drive rear backplane**

### Next steps

1. [Install all the drives.](#)
2. Connect all the cables to the backplane.
3. Follow the procedure listed in [After working inside your system.](#)

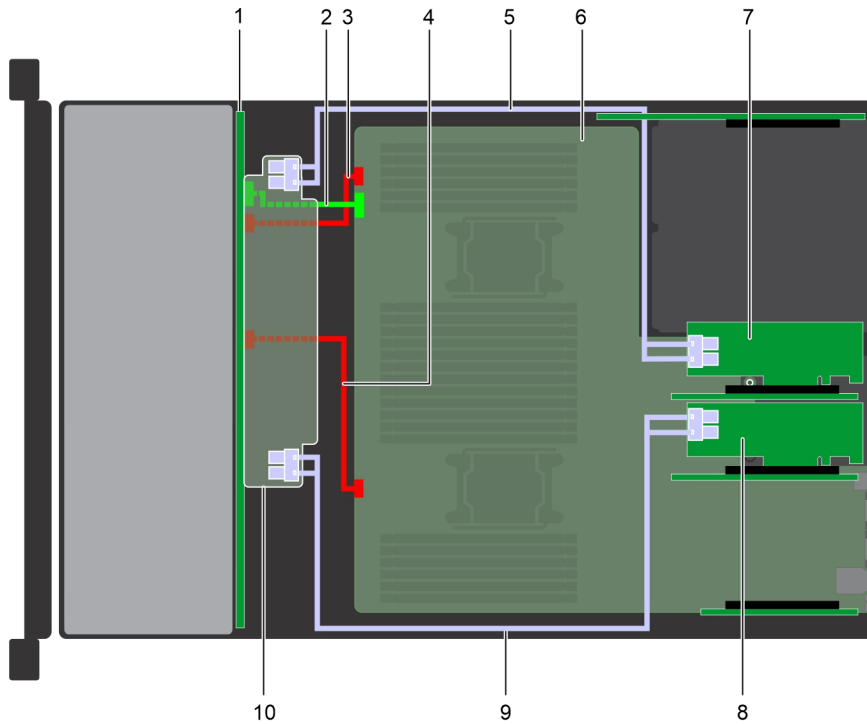


## Cable routing



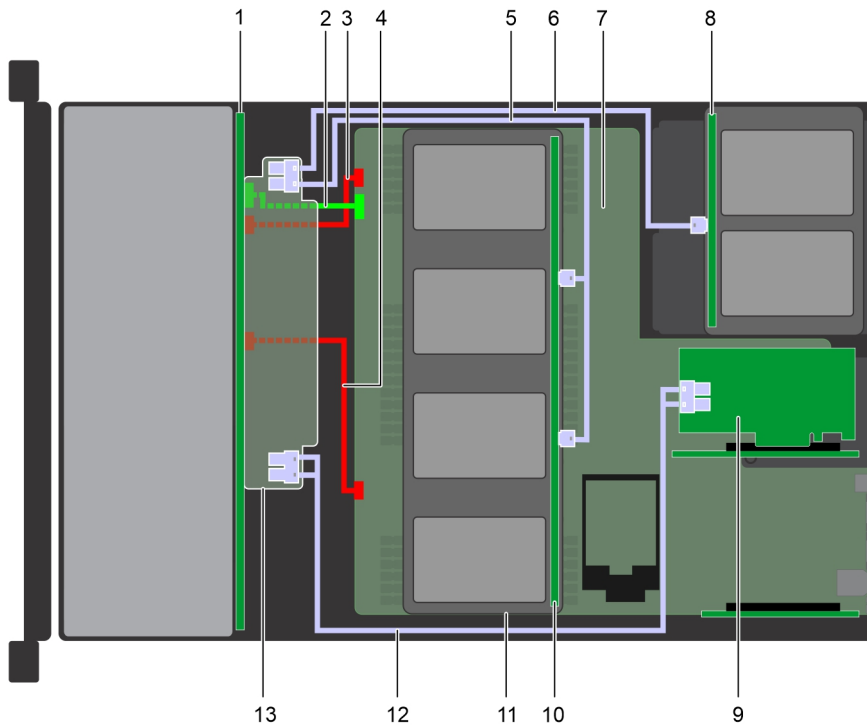
**Figure 139. Cable routing – 24 x 2.5 inch drive backplane with dual adapter PERC11/HBA**

1. backplane
2. backplane signal cable (BP: BPSIG1 to MB: BPSIG1)
3. backplane power cable A (BP: BP1 to MB: BP1)
4. backplane power cable B (BP: BP3 to MB: BP3)
5. SAS cable (BP: PE2\_A to adapter PERC11/HBA)
6. system board
7. adapter PERC11/HBA
8. adapter PERC11/HBA
9. SAS cable (BP: PE1\_B to adapter PERC11/HBA)
10. backplane expander



**Figure 140. Cable routing – 24 x 2.5 inch drive backplane with dual adapter PERC11/HBA**

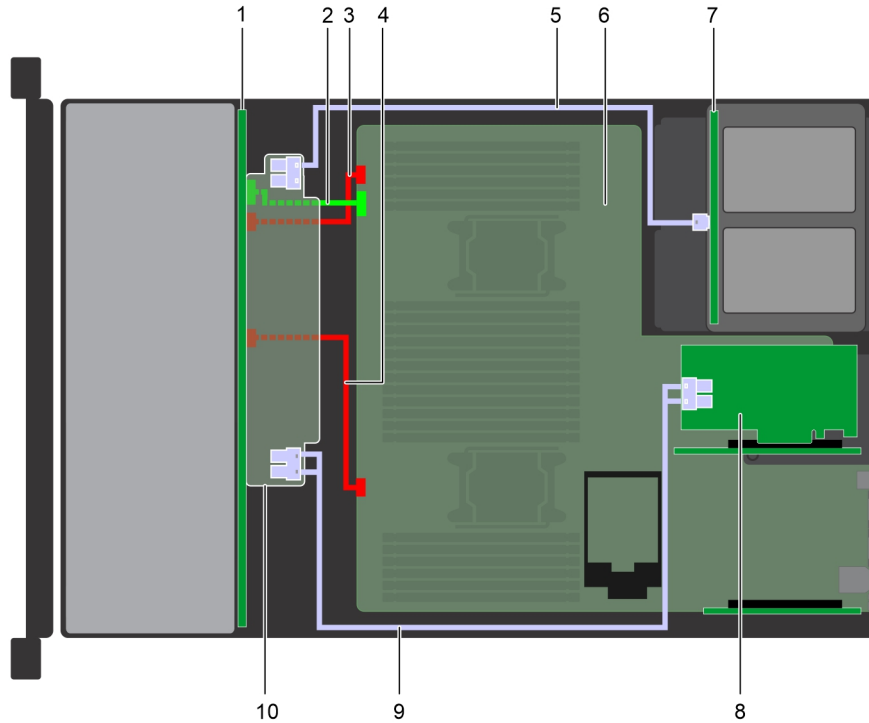
- |   |  |
|---|--|
| 1. backplane                                    | 2. backplane signal cable (BP: BPSIG1 to MB: BPSIG1) |
| 3. backplane power cable A (BP: BP1 to MB: BP1) | 4. backplane power cable B (BP: BP3 to MB: BP3)      |
| 5. SAS cable (BP: PE2_A to adapter PERC11/HBA)  | 6. system board                                      |
| 7. adapter PERC11/HBA                           | 8. adapter PERC11/HBA                                |
| 9. SAS cable (BP: PE1_B to adapter PERC11/HBA)  | 10. backplane expander                               |



**Figure 141. Cable routing – 24 x 2.5 inch drive backplane with 4 x 2.5 inch adapter mid drive tray backplane and 4 x 2.5 inch rear drive backplane with adapter PERC11/HBA**

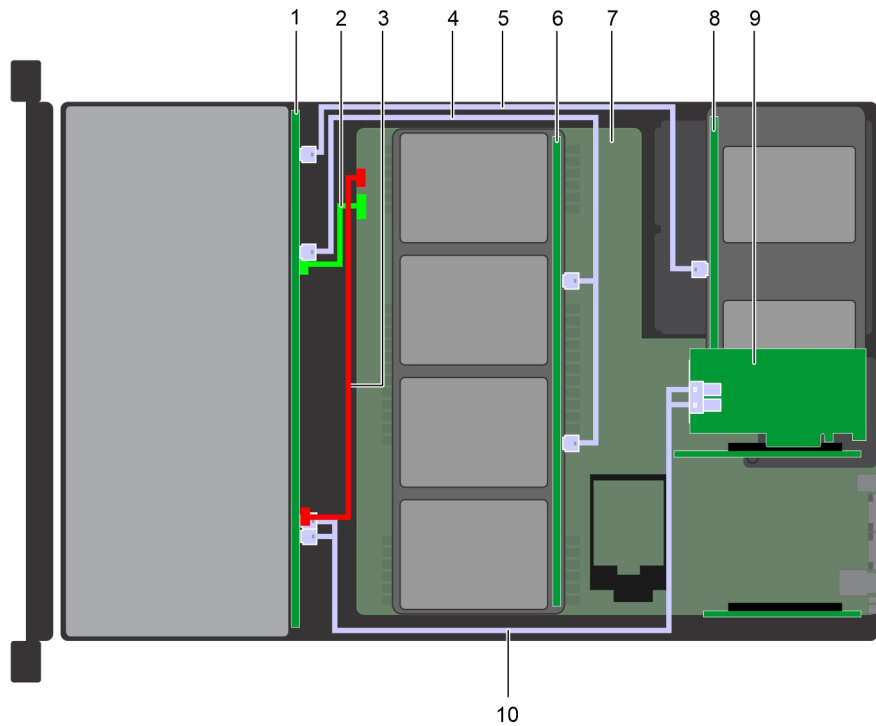
- |   |  |
|---|--|
| 1. backplane                                    | 2. backplane signal cable (BP: BPSIG1 to MB: BPSIG1) |
| 3. backplane power cable A (BP: BP1 to MB: BP1) | 4. backplane power cable B (BP: BP3 to MB: BP3)      |

- 5. SAS cable (BP to rear BP)
- 7. system board
- 9. adapter PERC11/HBA
- 11. 4 x 2.5 (with 4 x 2.5 adapter) inch drives
- 13. backplane expander
- 6. SAS cable (BP to Mid BP)
- 8. rear drive backplane
- 10. mid drive backplane
- 12. SAS cable (BP: PE1\_B to adapter PERC11/HBA)



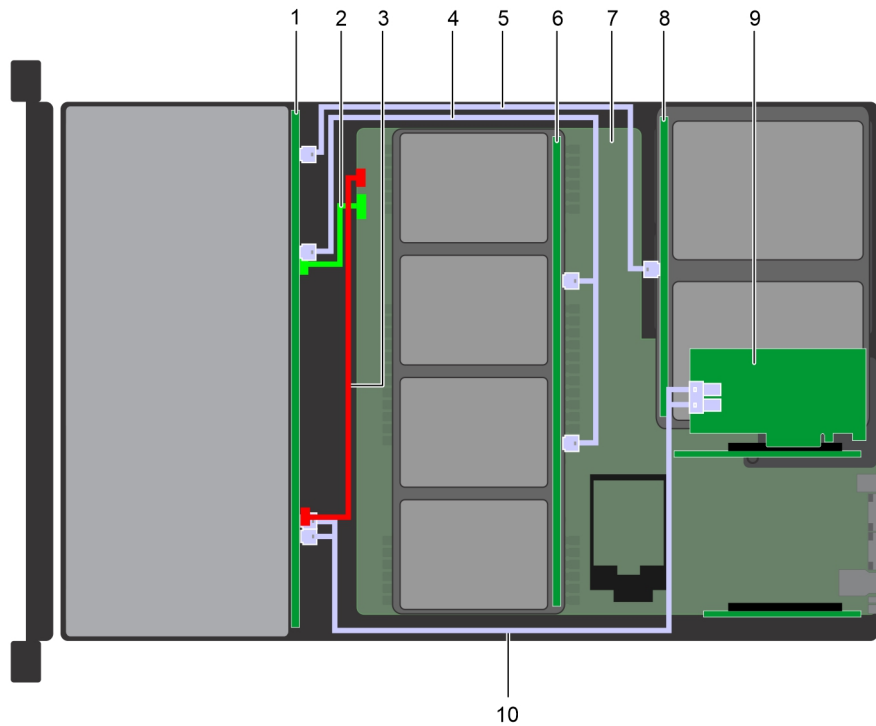
**Figure 142. Cable routing – 24 x 2.5 inch drive backplane with 4 x 2.5 inch rear drive backplane with adapter PERC11/HBA**

- 1. backplane
- 2. backplane signal cable (BP: BPSIG1 to MB: BPSIG1)
- 3. backplane power cable A (BP: BP1 to MB: BP1)
- 4. backplane power cable B (BP: BP3 to MB: BP3)
- 5. SAS cable (BP to rear BP)
- 6. system board
- 7. rear drive backplane
- 8. adapter PERC11/HBA
- 9. SAS cable (BP: PE1\_B to adapter PERC11/HBA)
- 10. backplane expander



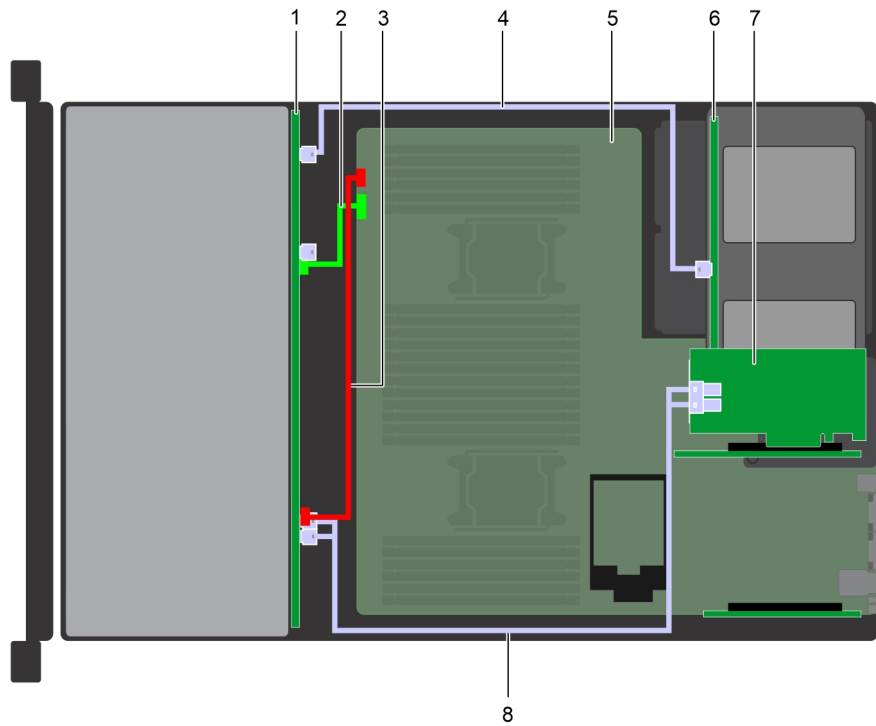
**Figure 143. Cable routing – 12 x 3.5 inch drive backplane with 4 x 3.5 inch (4 x 2.5 inch adapter) mid drive tray backplane and 4 x 2.5 inch rear drive backplane with adapter PERC11/HBA**

- |  |  |
|--|--|
| 1. backplane                                     | 2. backplane signal cable (BP: BPSIG1 to MB: BPSIG1)       |
| 3. backplane power cable (BP: BP1 to MB: BP1)    | 4. SAS cable (BP: A1 BP SAS to mid BP: J_SAS_A1, J_SAS_B1) |
| 5. SAS cable (BP: A2 BP SAS to rear BP: J_SAS_1) | 6. mid drive tray backplane                                |
| 7. system board                                  | 8. rear drive backplane                                    |
| 9. adapter PERC11/HBA                            | 10. SAS cable (BP: J_SAS_A0_B0 to adapter PERC11/HBA)      |



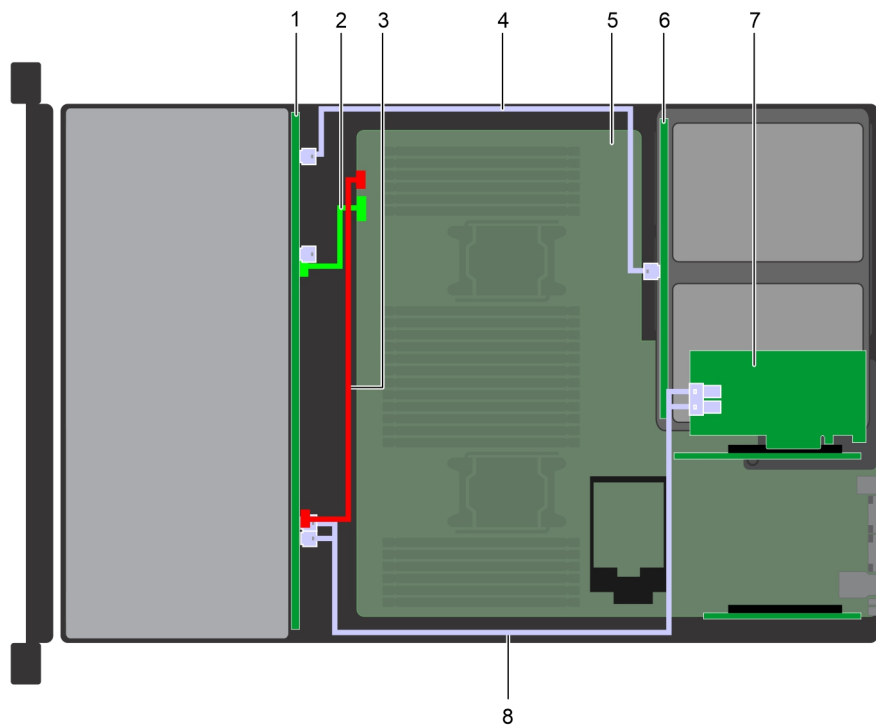
**Figure 144. Cable routing – 12 x 3.5 inch drive backplane with 4 x 3.5 inch (4 x 2.5 inch adapter) mid drive tray backplane and 2 x 3.5 inch rear drive backplane with adapter PERC11/HBA**

- |  |  |
|--|--|
| 1. backplane                                     | 2. backplane signal cable (BP: BPSIG1 to MB: BPSIG1)       |
| 3. backplane power cable (BP: BP1 to MB: BP1)    | 4. SAS cable (BP: A1 BP SAS to mid BP: J_SAS_A1, J_SAS_B1) |
| 5. SAS cable (BP: A2 BP SAS to rear BP: J_SAS_1) | 6. mid drive tray backplane                                |
| 7. system board                                  | 8. rear drive backplane                                    |
| 9. adapter PERC11/HBA                            | 10. SAS cable (BP: J_SAS_A0_B0 to adapter PERC11/HBA)      |



**Figure 145. Cable routing – 12 x 3.5 inch drive backplane with 4 x 2.5 inch rear drive backplane with adapter PERC11/HBA**

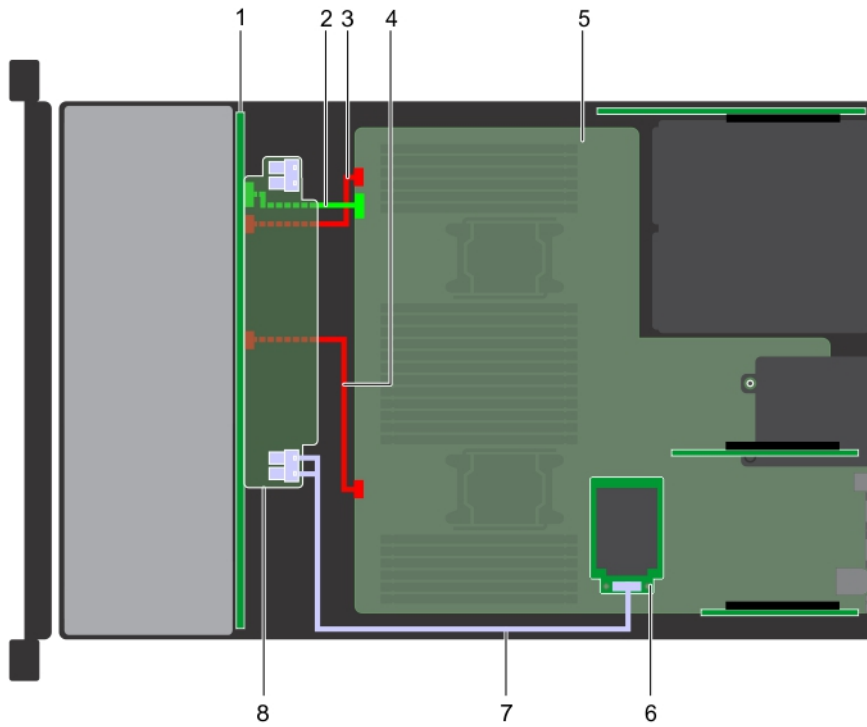
- |   |   |
|---|---|
| 1. backplane                                      | 2. backplane signal cable (Mid BP: J_BP_SIG to MB)              |
| 3. backplane power cable (Mid BP: J_BP_PWR to MB) | 4. SAS cable (BP: BP: A1 BP SAS to rear BP: J_SAS_A1, J_SAS_B1) |
| 5. system board                                   | 6. rear drive backplane   |
| 7. adapter PERC11/HBA                             | 8. SAS cable (BP: J_SAS_A0_B0 to adapter PERC11/HBA)            |



**Figure 146. Cable routing – 12 x 3.5 inch drive backplane with 2 x 3.5 inch rear drive backplane with adapter PERC11/HBA**

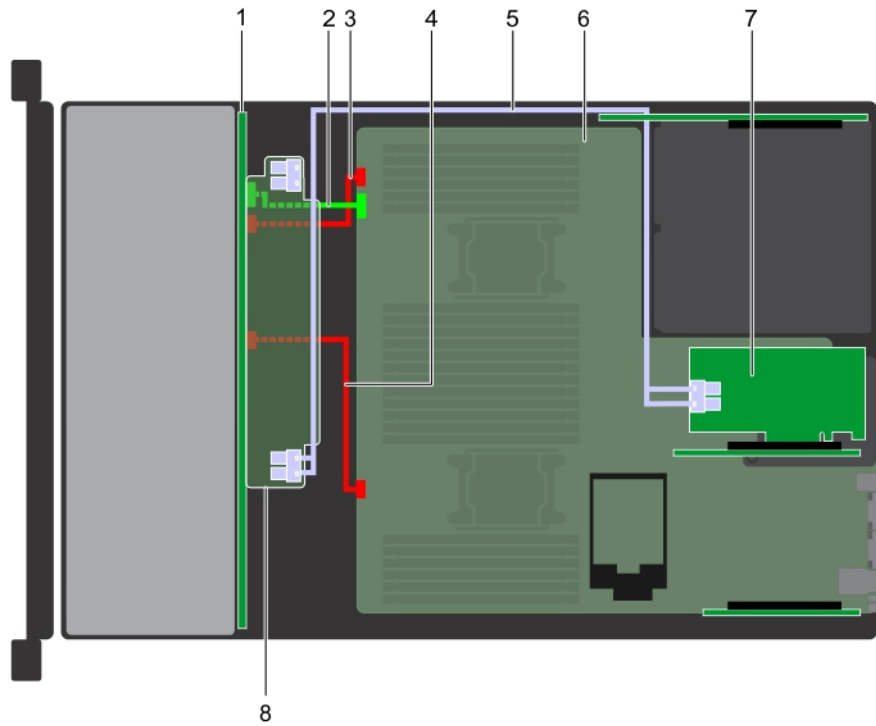
- |              |  |
|--------------|--|
| 1. backplane | 2. backplane signal cable (Mid BP: J_BP_SIG to MB) |
|--------------|--|

- 3. backplane power cable (Mid BP: J\_BP\_PWR to MB)
- 4. SAS cable (BP: BP: A1 BP SAS to rear BP: J\_SAS\_A1, J\_SAS\_B1)
- 5. system board
- 6. rear drive backplane
- 7. adapter PERC11/HBA
- 8. SAS cable (BP: J\_SAS\_A0\_B0 to adapter PERC11/HBA)



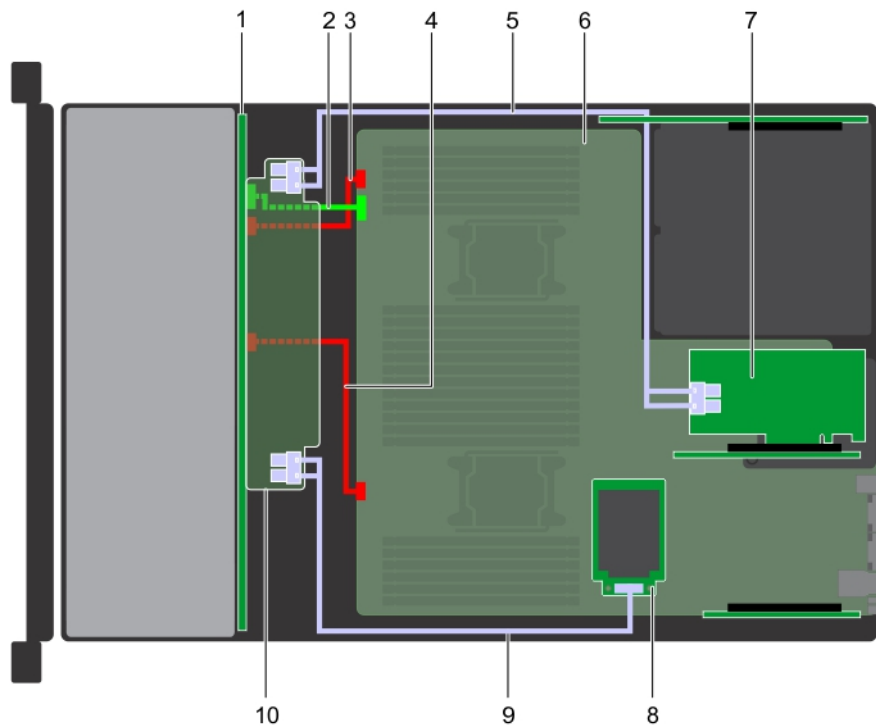
**Figure 147. Cable routing – 24 x 2.5 inch drive backplane with mini PERC**

- 1. backplane
- 2. backplane signal cable (BP: BPSIG1 to MB: BPSIG1)
- 3. backplane power cable A (BP: BP1 to MB: BP1)
- 4. backplane power cable B (BP: BP3 to MB: BP3)
- 5. system board
- 6. mini PERC
- 7. SAS cable (BP: PE1\_B to mini PERC)
- 8. backplane expander



**Figure 148. Cable routing – 24 x 2.5 inch drive backplane with adapter PERC**

- |   |  |
|---|--|
| 1. backplane                                    | 2. backplane signal cable (BP: BPSIG1 to MB: BPSIG1) |
| 3. backplane power cable A (BP: BP1 to MB: BP1) | 4. backplane power cable B (BP: BP3 to MB: BP3)      |
| 5. SAS cable (BP: PE1_B to adapter PERC)        | 6. system board                                      |
| 7. adapter PERC                                 | 8. backplane expander                                |

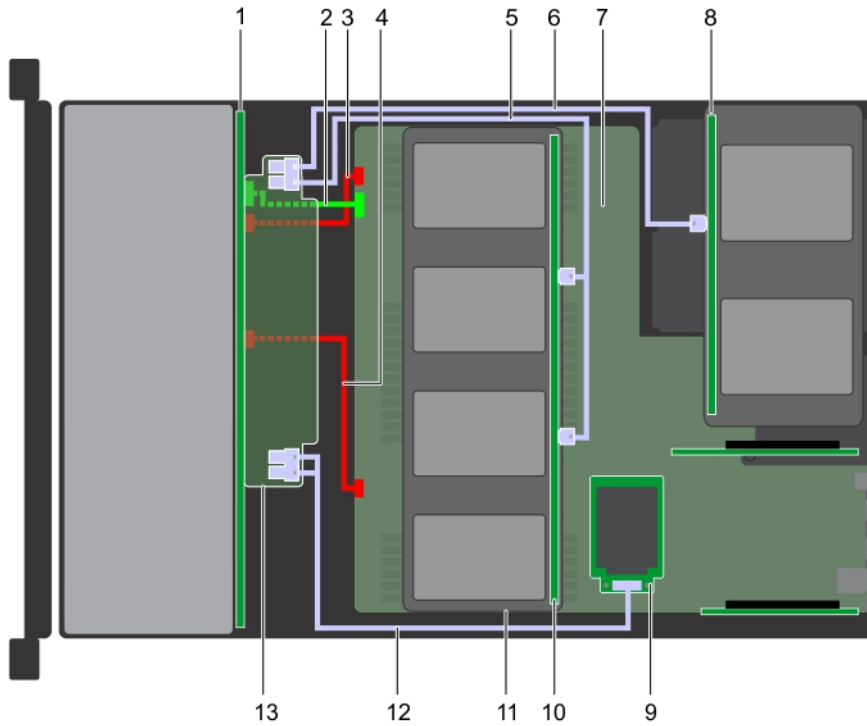


**Figure 149. Cable routing – 24 x 2.5 inch drive backplane with mini PERC/HBA and adapter PERC/HBA**

- |   |  |
|---|--|
| 1. backplane                                    | 2. backplane signal cable (BP: BPSIG1 to MB: BPSIG1) |
| 3. backplane power cable A (BP: BP1 to MB: BP1) | 4. backplane power cable B (BP: BP3 to MB: BP3)      |
| 5. SAS cable (BP: PE2_A to adapter PERC/HBA)    | 6. system board                                      |
|   | 8. mini PERC/HBA                                     |
|   | 9. backplane expander                                |
|   | 10. backplane expander                               |

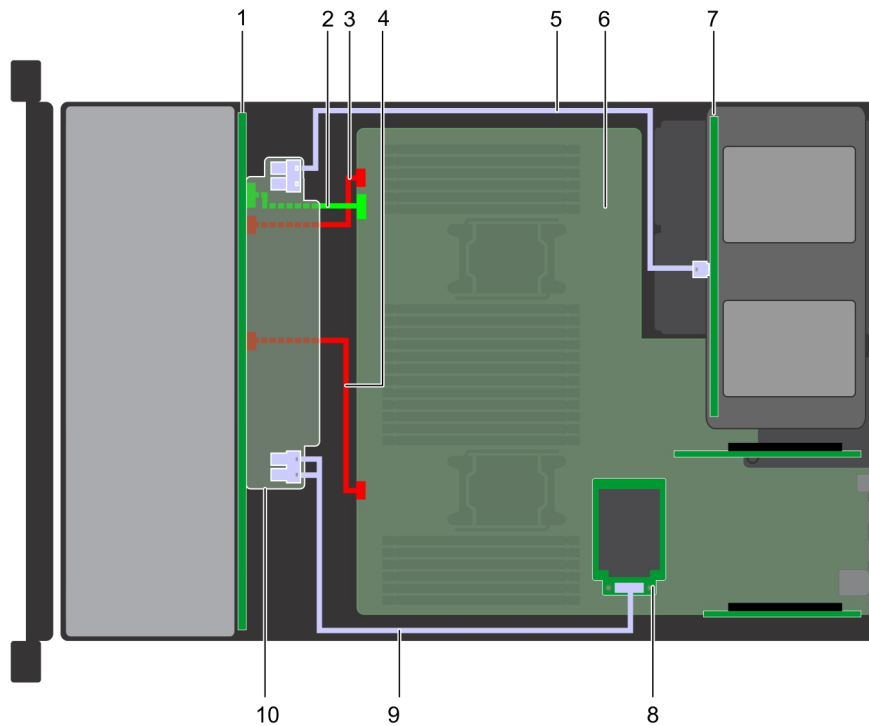


- 7. adapter PERC/HBA
- 8. mini PERC/HBA
- 9. SAS cable (BP: PE1\_B to mini PERC/HBA)
- 10. backplane expander



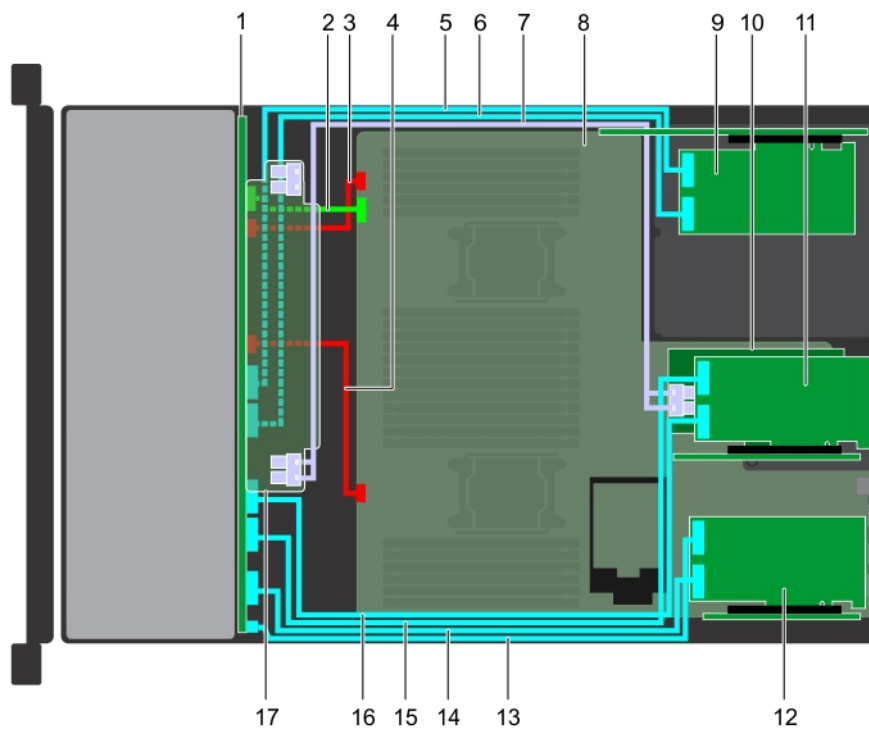
**Figure 150. Cable routing – 24 x 2.5 inch drive backplane with 4 x 2.5 inch adapter mid drive tray backplane and 4 x 2.5 inch rear drive backplane**

- 1. backplane
- 2. backplane signal cable (BP: BPSIG1 to MB: BPSIG1)
- 3. backplane power cable A (BP: BP1 to MB: BP1)
- 4. backplane power cable B (BP: BP3 to MB: BP3)
- 5. SAS cable (BP to mid BP)
- 6. SAS cable (BP to rear BP)
- 7. system board
- 8. rear drive backplane
- 9. mini PERC
- 10. mid drive backplane
- 11. 4 x 3.5 (with 4 x 2.5 adapter) inch drives
- 12. SAS cable (BP: PE1\_B to mini PERC)
- 13. backplane expander



**Figure 151. Cable routing – 24 x 2.5 inch drive backplane with 4 x 2.5 inch rear drive backplane**

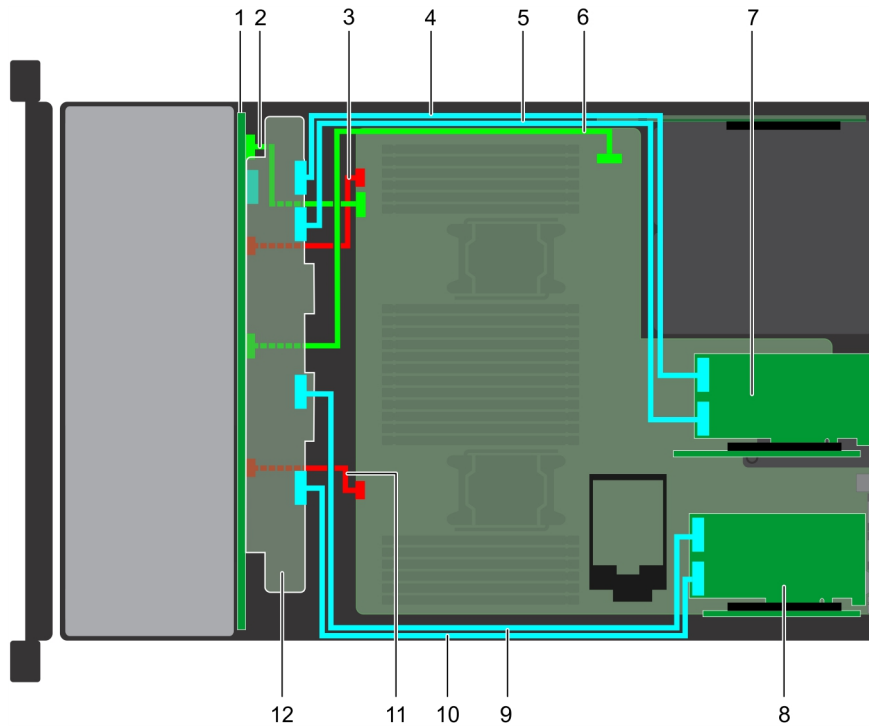
- |   |  |
|---|--|
| 1. backplane                                    | 2. backplane signal cable (BP: BPSIG1 to MB: BPSIG1) |
| 3. backplane power cable A (BP: BP1 to MB: BP1) | 4. backplane power cable B (BP: BP3 to MB: BP3)      |
| 5. SAS cable (BP to rear BP)                    | 6. system board                                      |
| 7. rear drive backplane                         | 8. mini PERC   |
| 9. SAS cable (BP: PE1_B to mini PERC)           | 10. backplane expander                               |



**Figure 152. Cable routing – 24 x 2.5 inch drive backplane with 12 SAS plus 12 PCIe and adapter PERC**

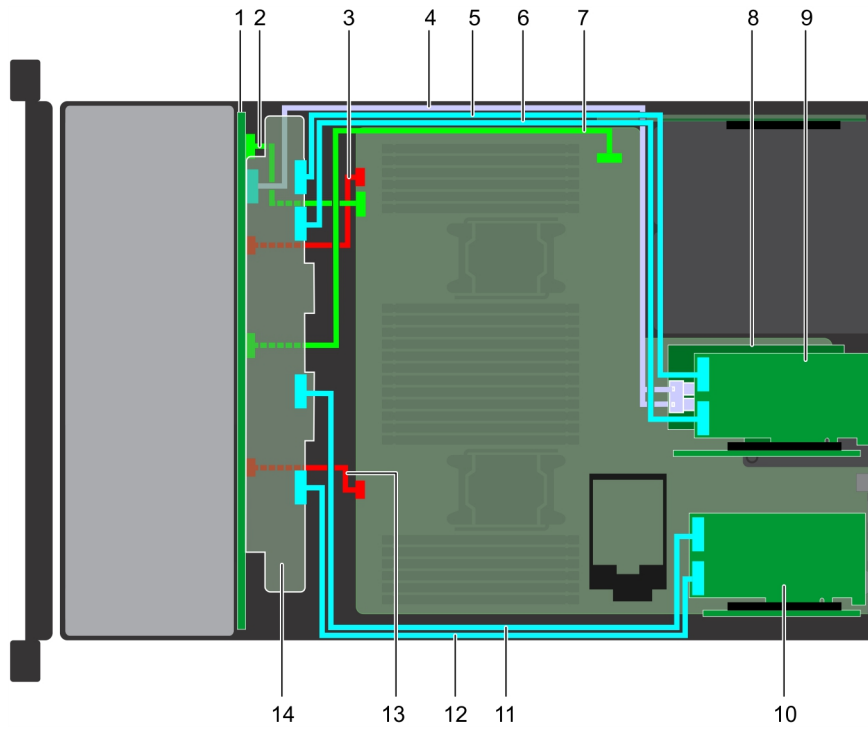
- |   |  |
|---|--|
| 1. backplane                                    | 2. backplane signal cable (BP: BPSIG1 to MB: BPSIG1) |
| 3. backplane power cable A (BP: BP1 to MB: BP1) | 4. backplane power cable B [BP: BP3 to MB (BP3)]     |

- 5. PCIe cable A of PCIe card 1 (BP: BP PCIE A2 to RAID controller)
- 6. PCIe cable B of PCIe card 1 (BP: BP PCIE B2 to RAID controller)
- 7. SAS cable (BP to adapter PERC)
- 8. system board
- 9. PCIe card 1 on riser 3A (slot 8)
- 10. adapter PERC on riser 2A (slot 6)
- 11. PCIe card 2 on riser 2A (slot 4)
- 12. PCIe card 3 on riser 1D (slot 1)
- 13. PCIe cable A of PCIe card 3 (BP: BP PCIE B0 to RAID controller )
- 14. PCIe cable B of PCIe card 3 (BP: BP PCIE A0 to RAID controller )
- 15. PCIe cable A of PCIe card 2 (BP: BP PCIE B1 to RAID controller)
- 16. PCIe cable B of PCIe card 2 (BP: BP PCIE A1 to RAID controller)
- 17. backplane expander



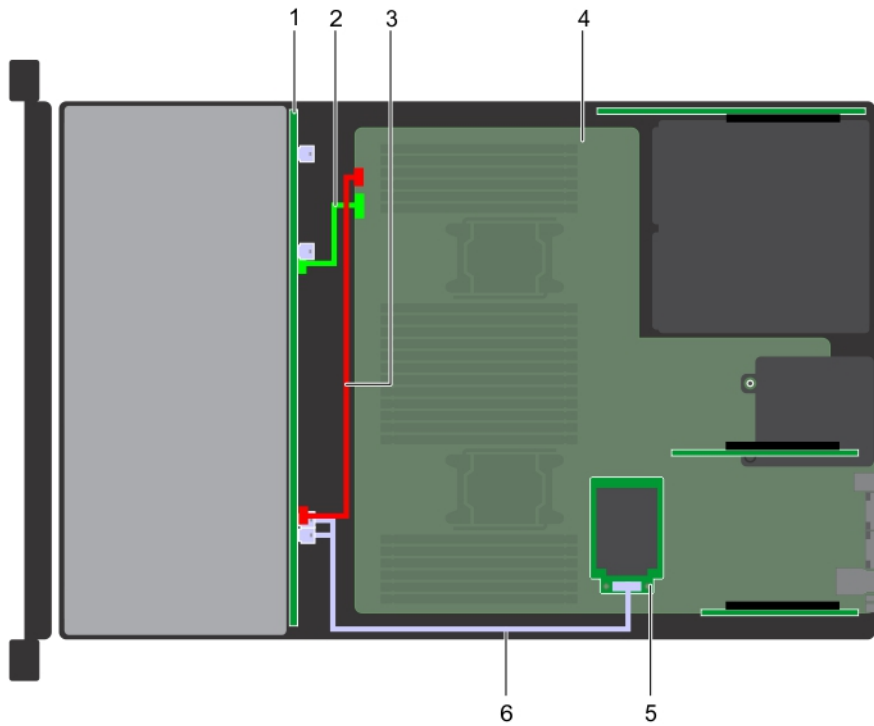
**Figure 153. Cable routing – 24 x 2.5 inch NVMe drive backplane**

- 1. backplane
- 2. backplane signal cable A (BP: J\_BP\_SIG to MB)
- 3. backplane power cable A (BP: J\_PWR\_A to MB)
- 4. PCIe cable A (BP: PE2\_A to RAID controller)
- 5. PCIe cable B (BP: PE2\_B to RAID controller)
- 6. backplane signal cable B
- 7. PCIe card on riser 2 (slot 4)
- 8. PCIe card on riser 1 (slot 3)
- 9. PCIe cable A (BP: PE1\_A to RAID controller)
- 10. PCIe cable B ( BP: PE1\_B to RAID controller)
- 11. backplane power cable B (BP: J\_PWR\_B to MB)
- 12. backplane expander



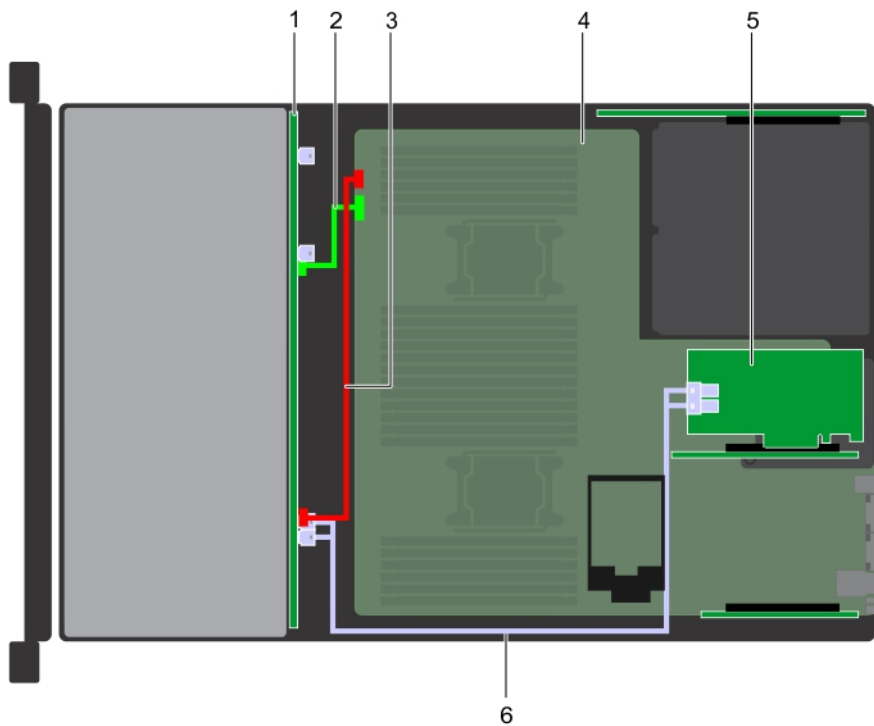
**Figure 154. Cable routing – 24 x 2.5 inch drive backplane with up to 24 NVMe or up to 8 SAS/SATA drives with NVMe**

- |   |  |
|---|--|
| 1. backplane                                    | 2. backplane signal cable A (BP: J_BP_SIG to MB) |
| 3. backplane power cable A (BP: J_PWR_A to MB)  | 4. SAS cable (BP to adapter PERC)                |
| 5. PCIe cable A (BP: PE2_A to RAID controller)  | 6. PCIe cable B (BP: PE2_B to RAID controller)   |
| 7. backplane signal cable B                     | 8. adapter PERC on riser 2 (slot 6)              |
| 9. PCIe card on riser 2 (slot 4)                | 10. PCIe card on riser 1 (slot 3)                |
| 11. PCIe cable A (BP: PE1_A to RAID controller) | 12. PCIe cable B (BP: PE1_B to RAID controller)  |
| 13. backplane power cable B (BP: J_PWR_B to MB) | 14. backplane expander                           |



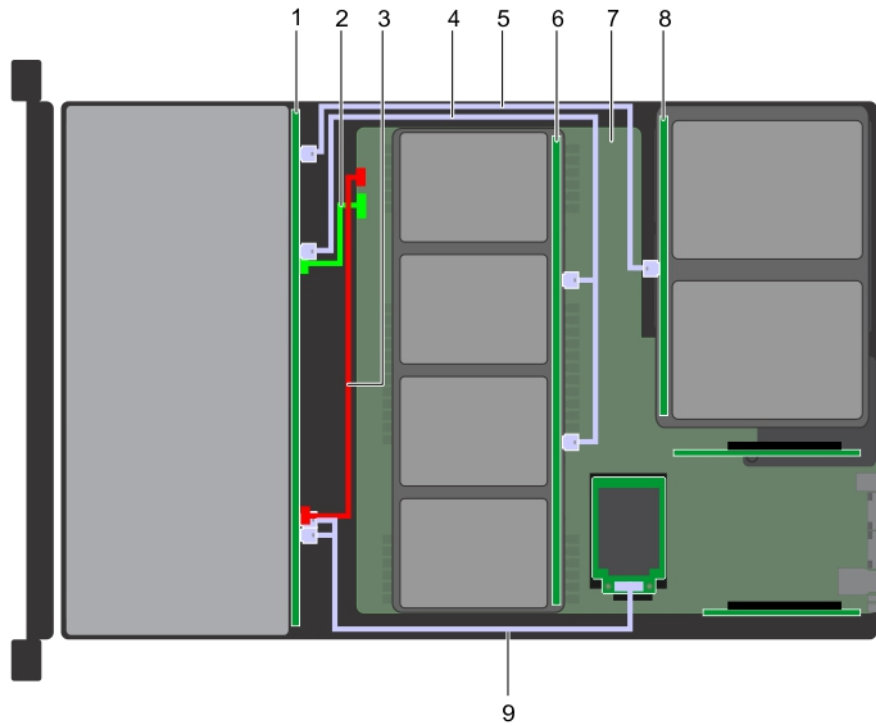
**Figure 155. Cable routing – 12 x 3.5 inch drive backplane with mini PERC**

- |   |  |
|---|--|
| 1. backplane                                  | 2. backplane signal cable (BP: BPSIG1 to MB: BPSIG1) |
| 3. backplane power cable (BP: BP1 to MB: BP1) | 4. system board                                      |
| 5. mini PERC                                  | 6. SAS cable (BP: J_SAS_A0_B0 to mini PERC)          |



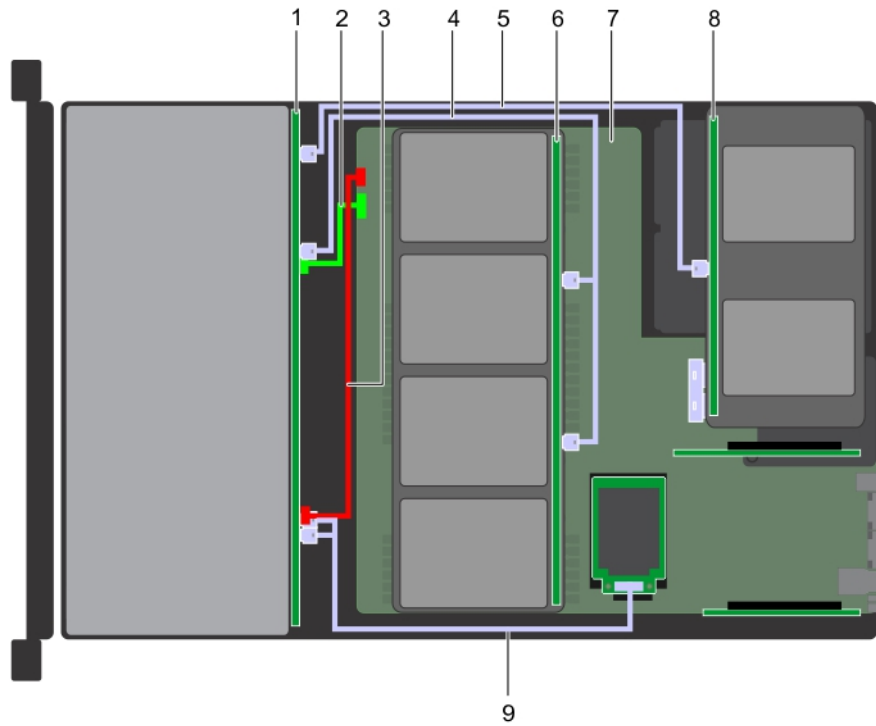
**Figure 156. 12 x 3.5 inch drive backplane with adapter PERC**

- |   |  |
|---|--|
| 1. backplane                                  | 2. backplane signal cable (BP: BPSIG1 to MB: BPSIG1) |
| 3. backplane power cable (BP: BP1 to MB: BP1) | 4. system board                                      |
| 5. adapter PERC                               | 6. SAS cable (BP: J_SAS_A0_B0 to adapter PERC)       |



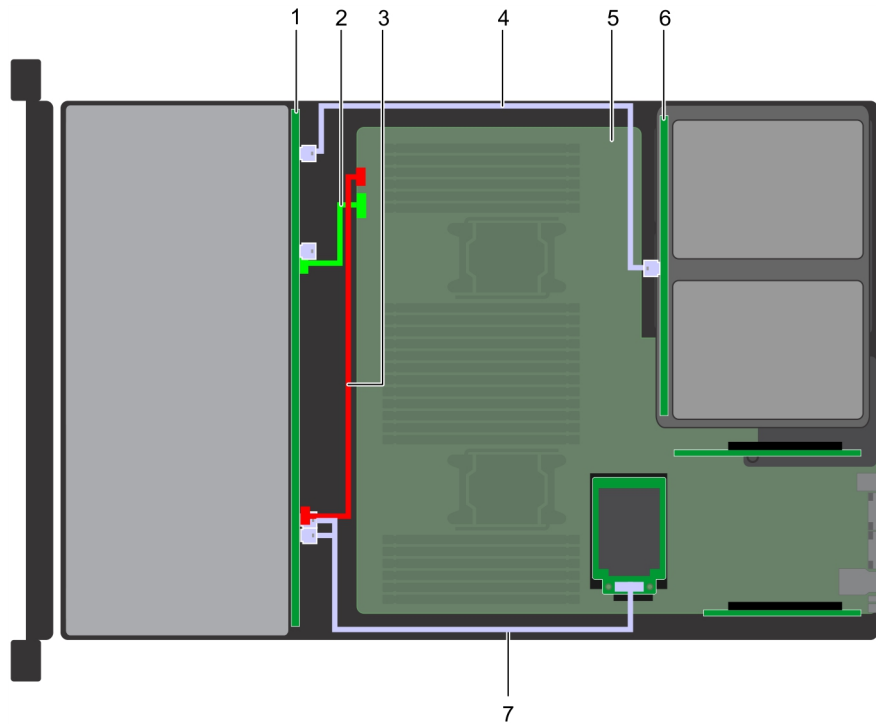
**Figure 157. Cable routing – 12 x 3.5 inch drive backplane with 4 x 3.5 inch (4 x 2.5 inch adapter) mid drive tray backplane and 2 x 3.5 inch rear drive backplane**

- |  |  |
|--|--|
| 1. backplane                                     | 2. backplane signal cable (BP: BPSIG1 to MB: BPSIG1)       |
| 3. backplane power cable (BP: BP1 to MB: BP1)    | 4. SAS cable (BP: A1 BP SAS to mid BP: J_SAS_A1, J_SAS_B1) |
| 5. SAS cable (BP: A2 BP SAS to rear BP: J_SAS_1) | 6. mid drive backplane                                     |
| 7. system board                                  | 8. rear drive backplane                                    |
| 9. SAS cable (BP: J_SAS_A0_B0 to mini PERC)      |  |



**Figure 158. Cable routing – 12 x 3.5 inch drive backplane with 4 x 3.5 inch (4 x 2.5 inch adapter) mid drive tray backplane and 4 x 2.5 inch rear drive backplane**

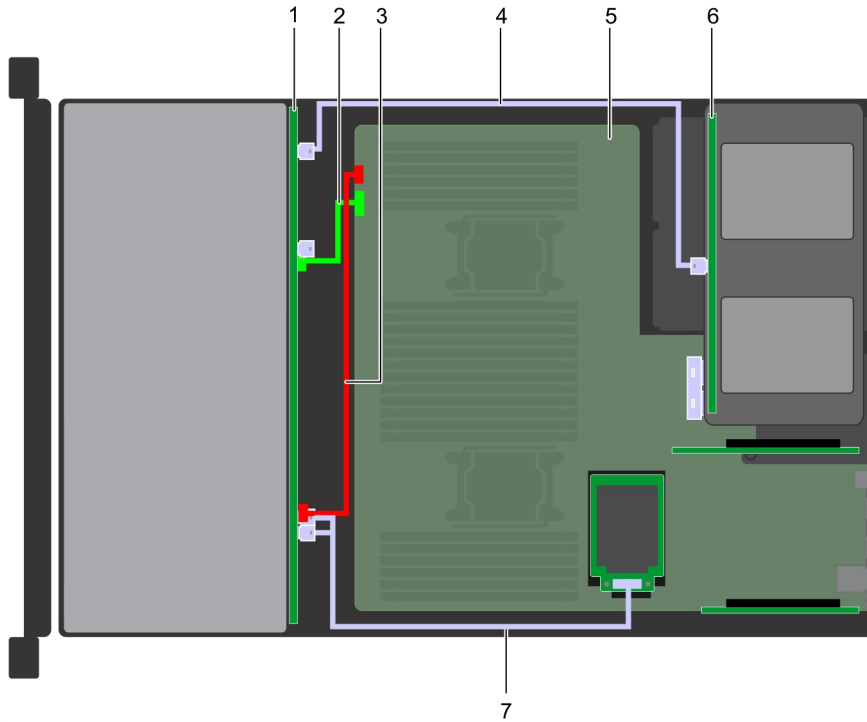
- |  |  |
|--|--|
| 1. backplane                                     | 2. backplane signal cable (BP: BPSIG1 to MB: BPSIG1)       |
| 3. backplane power cable (BP: BP1 to MB: BP1)    | 4. SAS cable (BP: A1 BP SAS to mid BP: J_SAS_A1, J_SAS_B1) |
| 5. SAS cable (BP: A2 BP SAS to rear BP: J_SAS_1) | 6. mid drive tray backplane                                |
| 7. system board                                  | 8. rear drive backplane                                    |
| 9. SAS cable (BP: J_SAS_A0_B0 to mini PERC)      |  |



**Figure 159. Cable routing – 12 x 3.5 inch drive backplane with 2 x 3.5 inch rear drive backplane**

- |              |  |
|--------------|--|
| 1. backplane | 2. backplane signal cable (Mid BP: J_BP_SIG to MB) |
|--------------|--|

- 3. backplane power cable (Mid BP: J\_BP\_PWR to MB)
- 4. SAS cable (BP: BP: A1 BP SAS to rear BP: J\_SAS\_A1, J\_SAS\_B1)
- 5. system board
- 6. rear drive backplane
- 7. SAS cable (BP: J\_SAS\_A0\_B0 to mini PERC)



**Figure 160. Cable routing – 12 x 3.5 inch drive backplane with 4 x 2.5 inch rear drive backplane**

- 1. backplane
- 2. backplane signal cable (Mid BP: J\_BP\_SIG to MB)
- 3. backplane power cable (Mid BP: J\_BP\_PWR to MB)
- 4. SAS cable (BP: BP: A1 BP SAS to rear BP: J\_SAS\_A1, J\_SAS\_B1)
- 5. system board
- 6. rear drive backplane
- 7. SAS cable (BP: J\_SAS\_A0\_B0 to mini PERC)

**NOTE:** The PERC11 H750 and HBA350i cards are not supported on 4x3.5 + 2x2.5 dual PERC, 10x2.5 + 2x2.5 dual PERC, or x10 NVMe configurations.

## System battery

### Replacing the system battery

#### Prerequisites


**WARNING:** There is a danger of a new battery exploding if it is incorrectly installed. Replace the battery only with the same or equivalent type recommended by the manufacturer. For more information, see the safety information that shipped with your system.

- 1. Follow the safety guidelines listed in [Safety instructions](#).
- 2. Follow the procedure listed in [Before working inside your system](#).
- 3. If applicable, close the PCIe card holder latch on the air shroud to release the full length card.
- 4. If applicable, disconnect the power or data cables from expansion card(s).
- 5. [Remove the expansion card riser 1A](#).



## Steps

1. Locate the battery socket. For more information, see the [System board jumpers and connectors](#) section.

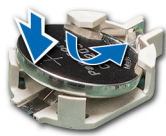
 **CAUTION:** To avoid damage to the battery connector, you must firmly support the connector while installing or removing a battery.

2. Use a plastic scribe to pry out the system battery.



**Figure 161. Removing the system battery**

3. To install a new system battery, hold the battery with the positive side facing up and slide it under the securing tabs.
4. Press the battery into the connector until it snaps into place.



**Figure 162. Installing the system battery**


## Next steps

1. [Install the expansion card riser 1A.](#)
2. If applicable, connect the cables to the expansion card(s).
3. If applicable, open the PCIe card holder latch on the air shroud to secure the full length expansion card.
4. Follow the procedure listed in [After working inside your system.](#)
5. While booting, press F2 to enter the System Setup and ensure that the battery is operating properly.
6. Enter the correct time and date in the System Setup **Time** and **Date** fields.
7. Exit the System Setup.

# Optional internal USB memory key


## Optional internal USB memory key details

An optional USB memory key can be installed in the internal USB 3.0 port.

 **NOTE:** To locate the internal USB port on the system board, see the [System board jumpers and connectors](#) section.

# Replacing the optional internal USB memory key

## Prerequisites

 **CAUTION:** To avoid interference with other components in the server, the maximum permissible dimensions of the USB memory key are 15.9 mm wide x 57.15 mm long x 7.9 mm high.

1. Follow the safety guidelines listed in [Safety instructions](#).
2. Follow the procedure listed in [Before working inside your system](#).

## Steps

1. Locate the USB port or USB memory key on the system board.  
To locate the USB port, see the [internal USB memory key details](#) section.
2. If installed, remove the USB memory key from the USB port.
3. Insert the replacement USB memory key into the USB port.

## Next steps

1. Follow the procedure listed in [After working inside your system](#).
2. While booting, press F2 to enter **System Setup** and verify that the system detects the USB memory key.


# Power supply units


## Power supply unit details


Your system supports one of the following:


- Two 2400 W, 2000 W, 1600 W, 1100 W, 750 W, or 495 W AC PSUs
- Two 1100 W DC PSUs
- Two 1100 W or 750 W Mixed Mode HVDC PSUs


 **NOTE:** For more information, see the [www.dell.com/poweredgemanuals](http://www.dell.com/poweredgemanuals) section.

 **CAUTION:** If two PSUs are installed, both the PSUs must have the same type of label. For example, **Extended Power Performance (EPP) label. Mixing PSUs from previous generations of PowerEdge servers is not supported, even if the PSUs have the same power rating. Mixing PSUs will result in mismatch condition or failure to turn the system on.**

 **NOTE:** Titanium PSU is nominally rated for 200 V AC to 240 V AC input only.

 **NOTE:** When two identical PSUs are installed, power supply redundancy (1+1 – with redundancy or 2+0 – without redundancy) is configured in system BIOS. In redundant mode, power is supplied to the system equally from both PSUs when Hot Spare is disabled. When Hot Spare is enabled, one of the PSUs is put into the sleep mode when system utilization is low in order to maximize efficiency.

 **NOTE:** If two PSUs are used, they must be of the same maximum output power.

 **NOTE:** PSUs are hot swappable.

## Hot spare feature

Your system supports the hot spare feature that significantly reduces the power overhead associated with power supply unit (PSU) redundancy.

When the hot spare feature is enabled, one of the redundant PSUs is switched to the sleep state. The active PSU supports 100 percent of the system load, thus operating at higher efficiency. The PSU in the sleep state monitors output voltage of the active PSU. If the output voltage of the active PSU drops, the PSU in the sleep state returns to an active output state.

If having both PSUs active is more efficient than having one PSU in the sleep state, the active PSU can also activate the sleeping PSU.

The default PSU settings are as follows:

- If the load on the active PSU is more than 50 percent of PSU rated power wattage, then the redundant PSU is switched to the active state.
- If the load on the active PSU falls below 20 percent of PSU rated power wattage, then the redundant PSU is switched to the sleep state.

You can configure the hot spare feature by using the iDRAC settings. For more information, see the iDRAC User's Guide available at [www.dell.com/poweredgemanuals](http://www.dell.com/poweredgemanuals).

## Removing a power supply unit blank

### Prerequisites

Follow the safety guidelines listed in [Safety instructions](#).

### Steps

If you are installing a second power supply unit (PSU), remove the PSU blank in the bay by pulling the blank outward.

**CAUTION:** To ensure proper system cooling, the PSU blank must be installed in the second PSU bay in a non-redundant configuration. Remove the PSU blank only if you are installing a second PSU.

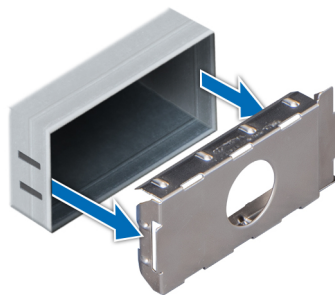


Figure 163. Removing a power supply unit blank

### Next steps

Install the PSU blank.

## Installing a power supply unit blank

### Prerequisites

1. Follow the safety guidelines listed in [Safety instructions](#).

**NOTE:** Install the power supply unit (PSU) blank only in the second PSU bay.

### Steps

Align the PSU blank with the PSU slot and push it into the PSU slot until it clicks into place.

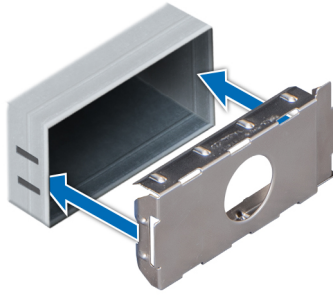


Figure 164. Installing a power supply unit blank

## Removing a power supply unit

The procedure for removing AC and DC PSUs is identical.

### Prerequisites

**CAUTION:** The system needs one power supply unit (PSU) for normal operation. On power-redundant systems, remove and replace only one PSU at a time in a system that is powered on.

1. Follow the safety guidelines listed in [Safety instructions](#).
2. Disconnect the power cable from the power source and from the PSU you intend to remove, and then remove the cable from the strap on the PSU handle.
3. Unlatch and lift the optional cable management arm if it interferes with the PSU removal.

For information about the cable management arm, see the system's rack documentation at [www.dell.com/poweredgemanuals](http://www.dell.com/poweredgemanuals).

### Steps

Press the orange release latch and slide the PSU out of the system by using the PSU handle.

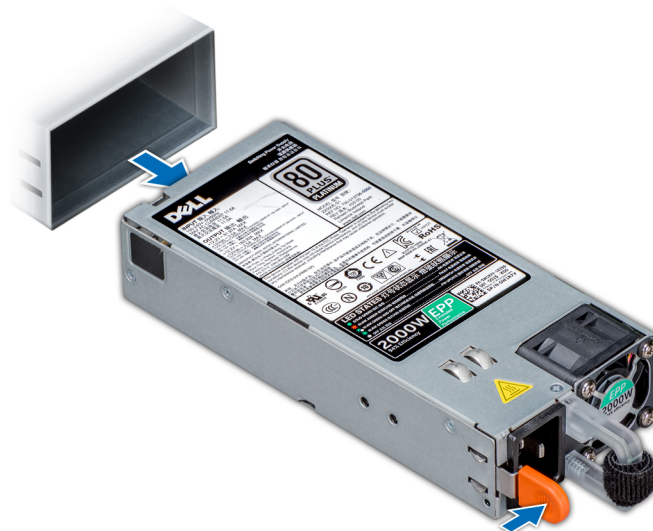


Figure 165. Removing a power supply unit

### Next steps

Install the PSU or PSU blank.

## Installing a power supply unit

The procedure for installing AC and DC PSUs is identical.

### Prerequisites

1. Follow the safety guidelines listed in [Safety instructions](#).
2. For systems that support redundant PSU, ensure that both the PSUs are of the same type and have the same maximum output power.

**NOTE:** The maximum output power (shown in watts) is listed on the PSU label.

### Steps

Slide the PSU into the system until the PSU is fully seated and the release latch snaps into place.

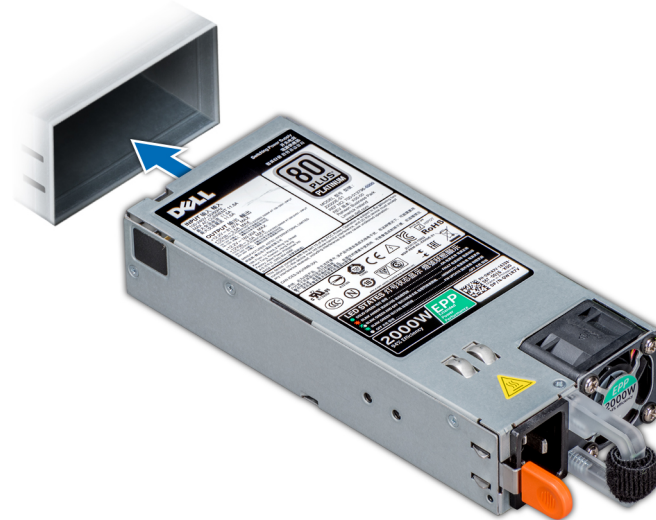


Figure 166. Installing a power supply unit

### Next steps

1. If you have unlatched the cable management arm, relatch it. For information about the cable management arm, see the system's rack documentation at [www.dell.com/poweredgemanuals](http://www.dell.com/poweredgemanuals).
2. Connect the power cable to the PSU, and plug the cable into a power outlet.

**CAUTION:** When connecting the power cable to the PSU, secure the cable to the PSU with the strap.

**NOTE:** When installing, hot swapping, or hot adding a new PSU, wait for 15 seconds for the system to recognize the PSU and determine its status. The PSU redundancy may not occur until discovery is complete. Wait until the new PSU is discovered and enabled before you remove the other PSU. The PSU status indicator turns green to signify that the PSU is functioning properly.

## Wiring instructions for a DC power supply unit

Your system supports up to two  $-(48-60)$  V DC power supply units (PSUs).

**NOTE:** For equipment using  $-(48-60)$  V DC power supply units (PSUs), a qualified electrician must perform all connections to DC power and to safety grounds. Do not attempt connecting to DC power or installing grounds yourself. All electrical wiring must comply with applicable local or national codes and practices. Damage due to servicing that is not authorized by Dell is not covered by your warranty. Read and follow all safety instructions that came with the product.

**CAUTION:** Wire the unit with copper only, unless otherwise specified, use only 10 American Wire Gauge (AWG) wire rated minimum 90°C for source and return. Protect the  $-(48-60)$  V DC (1 wire) with a branch circuit over-current protection rated 50 A for DC with a high interrupt current rating.

**CAUTION:** Connect the equipment to a  $-(48-60)$  V DC supply source that is electrically isolated from the AC source (reliably grounded  $-(48-60)$  V DC SELV source). Ensure that the  $-(48-60)$  V DC source is efficiently secured to earth (ground).

**NOTE:** A readily accessible disconnect device that is suitably approved and rated shall be incorporated in the field wiring.

## Input requirements

- Supply voltage:  $-(48-60)$  V DC
- Current consumption: 32 A (maximum)

## Kit contents

- Dell part number 6RYJ9 terminal block or equivalent (1)
- #6-32 nut equipped with lock washer (1)

## Required tools

Wire-stripper pliers capable of removing insulation from size 10 AWG solid or stranded, insulated copper wire.

**NOTE:** Use alpha wire part number 3080 or equivalent (65/30 stranding).

## Required wires

- One UL 10 AWG, 2 m maximum (stranded) black wire [ $-(48-60)$  V DC].
- One UL 10 AWG, 2 m maximum (stranded) red wire (V DC return).
- One UL 10 AWG, 2 m maximum, green with a yellow stripe, stranded wire (safety ground).

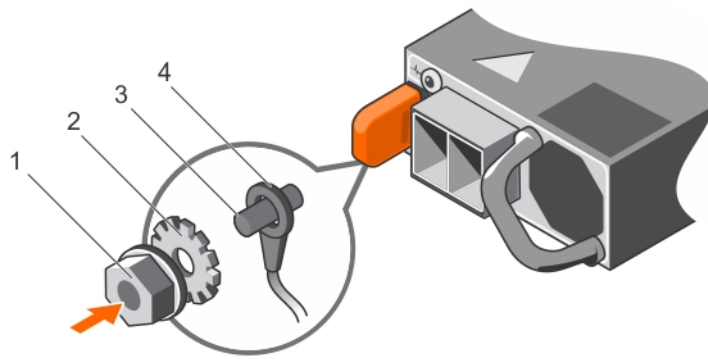
## Assembling and connecting safety ground wire

### Prerequisites

**NOTE:** For equipment using  $-(48-60)$  V DC power supply units (PSUs), a qualified electrician must perform all connections to DC power and to safety grounds. Do not attempt connecting to DC power or installing grounds yourself. All electrical wiring must comply with applicable local or national codes and practices. Damage due to servicing that is not authorized by Dell is not covered by your warranty. Read and follow all safety instructions that came with the product.

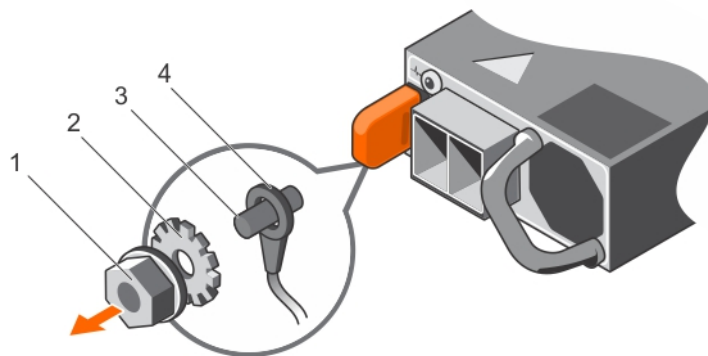
### Steps

1. Strip the insulation from the end of the green or yellow wire, exposing approximately 4.5 mm (0.175 inches) of copper wire.
2. Using a hand-crimping tool (Tyco Electronics, 58433-3 or equivalent), crimp the ring-tongue terminal (Jeerson Terminals Inc., R5-4SA or equivalent) to the green and yellow wire (safety ground wire).
3. Connect the safety ground wire to the grounding post on the back of the system by using a number 6-32 nut that is equipped with a locking washer.



**Figure 167. Assembling and connecting the safety ground wire**

- |                   |                       |
|-------------------|-----------------------|
| 1. #6-32 nut      | 2. spring washer      |
| 3. grounding post | 4. safety ground wire |



**Figure 168. Removing the safety ground wire**

- |                   |                       |
|-------------------|-----------------------|
| 1. #6-32 nut      | 2. spring washer      |
| 3. grounding post | 4. safety ground wire |

## Assembling DC input power wires

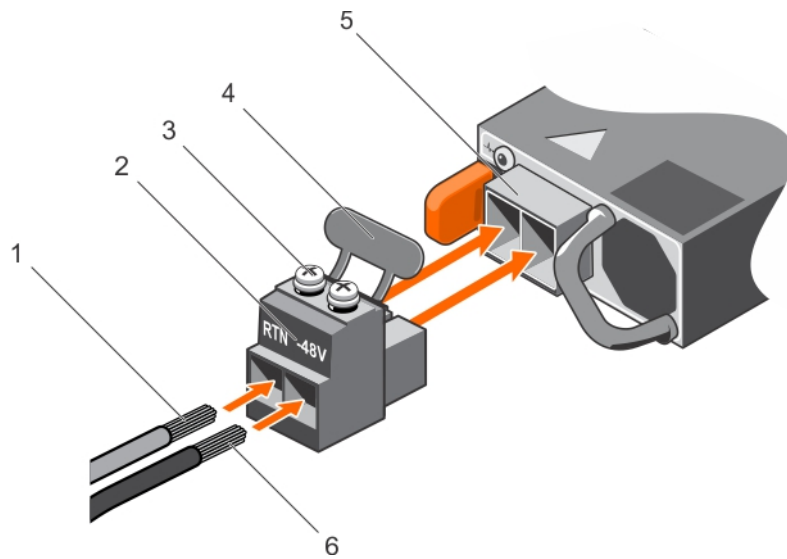
### Prerequisites

**NOTE:** For equipment using  $-(48-60)$  V DC power supply units (PSUs), a qualified electrician must perform all connections to DC power and to safety grounds. Do not attempt connecting to DC power or installing grounds yourself. All electrical wiring must comply with applicable local or national codes and practices. Damage due to servicing that is not authorized by Dell is not covered by your warranty. Read and follow all safety instructions that came with the product.

### Steps

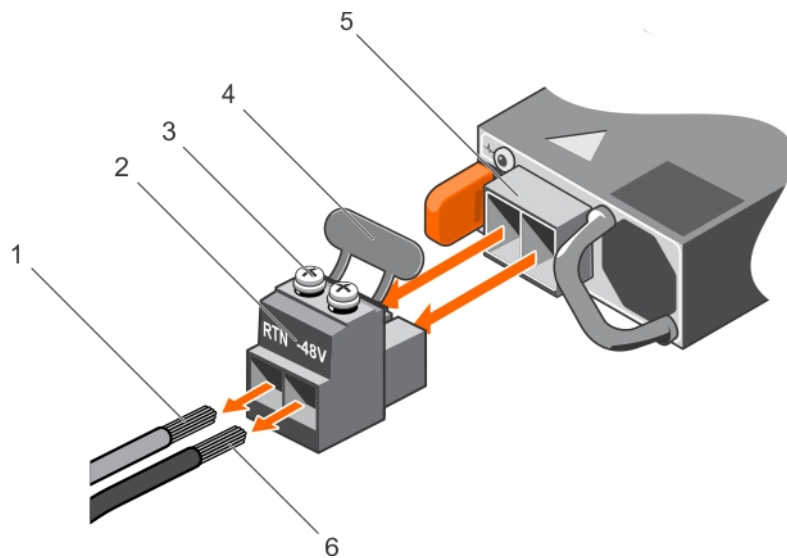
- Strip the insulation from the ends of the DC power wires, exposing approximately 13 mm (0.5 inches) of copper wire.
  - NOTE:** Reversing polarity when connecting DC power wires can permanently damage the power supply or the system.
- Insert the copper ends into the mating connectors and tighten the captive screws at the top of the mating connector using a Phillips number 2 screwdriver.
  - NOTE:** To protect the power supply from electrostatic discharge, the captive screws must be covered with the rubber cap before inserting the mating connector into the power supply.

3. Rotate the rubber cap clockwise to fix it over the captive screws.
4. Insert the mating connector into the power supply.



**Figure 169. Assembling the DC Input Power Wires**

- |                      |                       |
|----------------------|-----------------------|
| 1. DC wire RTN       | 2. DC power connector |
| 3. captive screw (2) | 4. rubber cap         |
| 5. DC power socket   | 6. DC wire -48 V      |



**Figure 170. Removing the DC Input Power Wires**


- |                      |                       |
|----------------------|-----------------------|
| 1. wire RTN          | 2. DC power connector |
| 3. captive screw (2) | 4. rubber cap         |
| 5. DC power socket   | 6. wire -48 V         |




# System board

## Removing system board

### Prerequisites

 **CAUTION:** If you are using the Trusted Platform Module (TPM) with an encryption key, you may be prompted to create a recovery key during program or System Setup. Be sure to create and safely store this recovery key. If you replace this system board, you must supply the recovery key when you restart your system or program before you can access the encrypted data on your drives.

 **CAUTION:** Do not attempt to remove the TPM plug-in module from the system board. Once the TPM plug-in module is installed, it is cryptographically bound to that specific system board. Any attempt to remove an installed TPM plug-in module breaks the cryptographic binding, and it cannot be re-installed or installed on another system board.

1. Follow the safety guidelines listed in [Safety instructions](#).
2. Follow the procedure listed in [Before working inside your system](#).
3. Remove the following:
  - a. [Air shroud](#)
  - b. [Cooling fan assembly](#)
  - c. [Rear drive cage](#) (if applicable)
  - d. [Mid drive tray](#) (if applicable)
  - e. [Power supply units](#)
  - f. [Expansion cards and expansion card risers](#)
  - g. [Integrated storage controller card](#)
  - h. [Optional IDSDM or vFlash card](#)
  - i. [Optional internal USB memory key](#) (if installed)
  - j. [Processor and heat sink module](#)
  - k. [Processor blank](#) (if installed)

 **CAUTION:** To prevent damage to the processor socket when replacing a faulty system board, ensure that you cover the processor socket with the processor dust cover.

- l. [Memory modules](#) and memory module blanks
- m. [Network daughter card](#)

### Steps

1. Disconnect all cables from the system board.

 **CAUTION:** Take care not to damage the system identification button while removing the system board from the system.

 **CAUTION:** Do not lift the system board by holding a memory module, processor, or other components.

2. Holding the system board holder, pull the blue release pin, and slide the system board toward the front of the system to disengage the connectors from the slots on the system.
3. Incline the system board at an angle, and lift the system board out of the system.

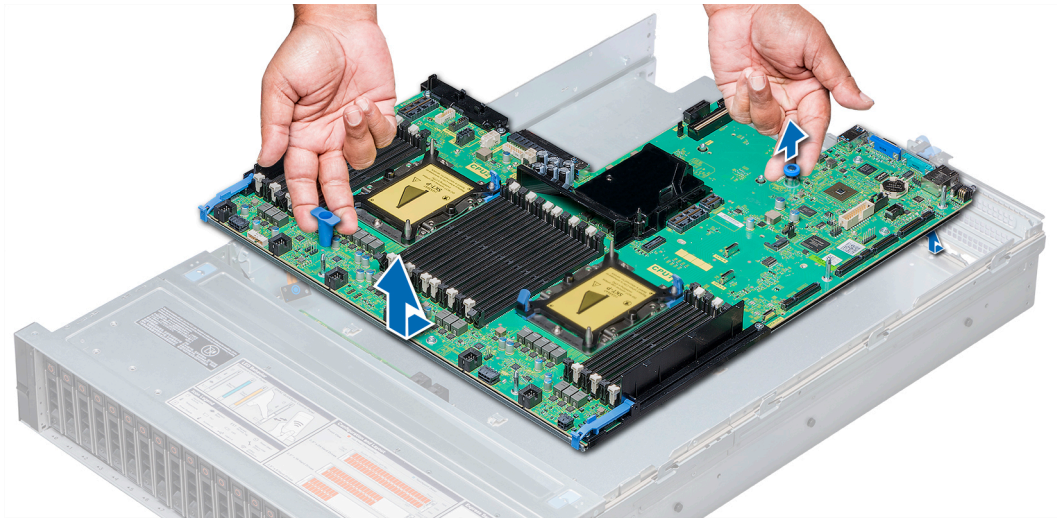


Figure 171. Removing system board

### Next steps

Install the system board.

## Installing system board

### Prerequisites

Follow the safety guidelines listed in [Safety instructions](#).

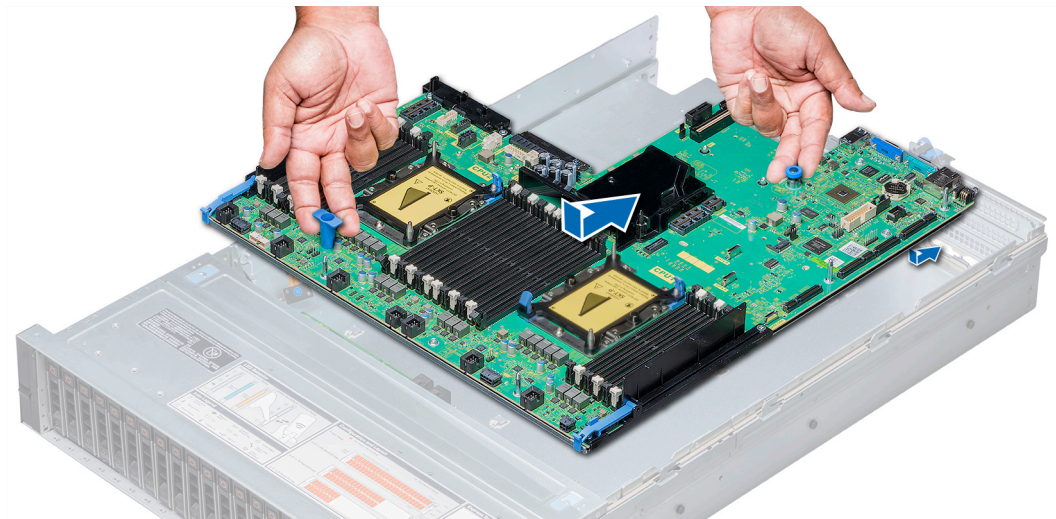
### Steps

1. Unpack the replacement system board assembly.

**CAUTION:** Do not lift the system board by holding a memory module, processor, or other components.

**CAUTION:** Take care not to damage the system identification button while placing the system board into the system.

2. Holding the system board holder and blue release pin, incline the system board, and lower the system board into the system.
3. Slide the system board toward the back of the system until the release pin clicks into place.



**Figure 172. Installing system board**

### Next steps

1. Replace the following:
  - a. [Trusted Platform Module](#)

**NOTE:** The TPM plug-in module is attached to the system board and cannot be removed. A replacement TPM plug-in module will be provided for all system board replacements where a TPM plug-in module was installed.
  - b. [Mid drive tray](#) (if applicable)
  - c. [Rear drive cage](#)
  - d. [Integrated storage controller card](#)
  - e. [Optional internal USB memory key](#) (if applicable)
  - f. [Optional IDSDM or vFlash module](#)
  - g. [Expansion cards and expansion card risers](#)
  - h. [Processor and heat sink module](#)
  - i. [Processor blank](#) (if applicable)
  - j. [Memory modules](#) and memory module blanks
  - k. [Network daughter card](#)
  - l. [Cooling fan assembly](#)
  - m. [Air shroud](#)
  - n. [Power supply units](#)
2. Reconnect all cables to the system board.
 

**NOTE:** Ensure that the cables inside the system are routed along the chassis wall and secured using the cable securing bracket.
3. Follow the procedure listed in [After working inside your system](#).
4. Ensure that you:
  - a. Use the Easy Restore feature to restore the Service Tag. For more information, see [Restoring the Service Tag using Easy Restore](#).
  - b. If the Service Tag is not backed up in the backup flash device, enter the Service Tag manually. For more information, see [Entering the system Service Tag by using System Setup](#).
  - c. Update the BIOS and iDRAC versions.
  - d. Re-enable the Trusted Platform Module (TPM). For more information, see [Upgrading the Trusted Platform Module](#).
5. Import your new or existing iDRAC Enterprise license. For more information, see [Integrated Dell Remote Access Controller User's Guide](#), at [www.dell.com/poweredgemanuals](http://www.dell.com/poweredgemanuals).

## Restoring the Service Tag using Easy Restore

The easy restore feature allows you to restore your service tag, license, UEFI configuration, and the system configuration data after replacing the system board. All data is backed up in a backup flash device automatically. If BIOS detects a new system board, and the service tag in the backup flash device, BIOS prompts the user to restore the backup information.

### About this task

Below is a list of options available:

- Restore the service tag, license, and diagnostics information, press **Y**
- Navigate to the Lifecycle Controller based restore options, press **N**.
- Restore data from a previously created **Hardware Server Profile**, press **F10**  
**i** **NOTE:** When the restore process is complete, BIOS prompts to restore the system configuration data.
- To restore the system configuration data, press **Y**
- To use the default configuration settings, press **N**  
**i** **NOTE:** After the restore process is complete, system reboots.

## Manually update the Service Tag

After replacing a system board, if Easy Restore fails, follow this process to manually enter the Service Tag, using **System Setup**.

### About this task

If you know the system service tag, use the **System Setup** menu to enter the service tag.

#### Steps

1. Turn on the system.
2. To enter the **System Setup**, press **F2**.
3. Click **Service Tag Settings**.
4. Enter the service tag.  
**i** **NOTE:** You can enter the service tag only when the **Service Tag** field is empty. Ensure that you enter the correct service tag. Once the service tag is entered, it cannot be updated or changed.
5. Click **OK**.

## Entering the system Service Tag by using System Setup

If Easy Restore fails to restore the Service Tag, use System Setup to enter the Service Tag.

#### Steps

1. Turn on the system.
2. Press F2 to enter System Setup.
3. Click **Service Tag Settings**.
4. Enter the Service Tag.  
**i** **NOTE:** You can enter the Service Tag only when the **Service Tag** field is empty. Ensure that you enter the correct Service Tag. After the Service Tag is entered, it cannot be updated or changed.
5. Click **OK**.
6. Import your new or existing iDRAC Enterprise license.  
For more information, see the *Integrated Dell Remote Access Controller User's Guide* at [www.dell.com/poweredgemanuals](http://www.dell.com/poweredgemanuals).

# Trusted Platform Module

## Upgrading the Trusted Platform Module


### Prerequisites


1. Follow the safety guidelines listed in [Safety instructions](#).
2. Follow the procedure listed in [Before working inside your system](#).

### NOTE:

- Ensure that your operating system supports the version of the TPM module being installed.
- Ensure that you download and install the latest BIOS firmware on your system.
- Ensure that the BIOS is configured to enable UEFI boot mode.

### About this task

 **CAUTION:** If you are using the Trusted Platform Module (TPM) with an encryption key, you may be prompted to create a recovery key during program or System Setup. Work with the customer to create and safely store this recovery key. When replacing this system board, you must supply the recovery key when you restart your system or program before you can access the encrypted data on your hard drives.

 **CAUTION:** Once the TPM plug-in module is installed, it is cryptographically bound to that specific system board. Any attempt to remove an installed TPM plug-in module breaks the cryptographic binding, the removed TPM cannot be reinstalled or installed on another system board.

## Removing the TPM

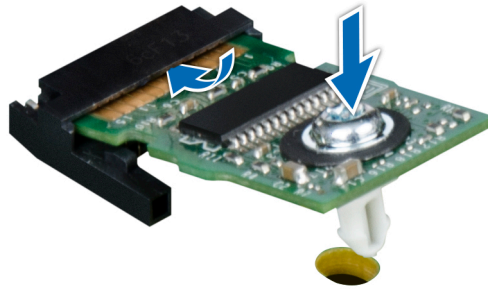
### Steps

1. Locate the TPM connector on the system board.
2. Press to hold the module down and remove the screw using the security Torx 8-bit shipped with the TPM module.
3. Slide the TPM module out from its connector.
4. Push the plastic rivet away from the TPM connector and rotate it 90° counterclockwise to release it from the system board.
5. Pull the plastic rivet out of its slot on the system board.

## Installing the TPM

### Steps

1. To install the TPM, align the edge connectors on the TPM with the slot on the TPM connector.
2. Insert the TPM into the TPM connector such that the plastic rivet aligns with the slot on the system board.
3. Press the plastic rivet until the rivet snaps into place.



**Figure 173. Installing the TPM**

4. Replace the screw that secures the TPM to the system board.

#### **Next steps**

1. [Install the system board.](#)
2. Follow the procedure listed in [After working inside your system.](#)

## **Initializing TPM for BitLocker users**

#### **Steps**

Initialize the TPM.

For more information, see .

The **TPM Status** changes to **Enabled, Activated**.

## **Initializing the TPM 1.2 for TXT users**

#### **Steps**

1. While booting your system, press F2 to enter System Setup.
2. On the **System Setup Main Menu** screen, click **System BIOS > System Security Settings**.
3. From the **TPM Security** option, select **On with Pre-boot Measurements**.
4. From the **TPM Command** option, select **Activate**.
5. Save the settings.
6. Restart your system.
7. Enter **System Setup** again.
8. On the **System Setup Main Menu** screen, click **System BIOS > System Security Settings**.
9. From the **Intel TXT** option, select **On**.

## **Initializing the TPM 2.0 for TXT users**

#### **Steps**

1. While booting your system, press F2 to enter System Setup.
2. On the **System Setup Main Menu** screen, click **System BIOS > System Security Settings**.
3. From the **TPM Security** option, select **On**.
4. Save the settings.
5. Restart your system.
6. Enter **System Setup** again.

7. On the **System Setup Main Menu** screen, click **System BIOS > System Security Settings**.
8. Select the **TPM Advanced Settings** option.
9. From the **TPM2 Algorithm Selection** option, select **SHA256**, then go back to **System Security Settings** screen.
10. On the **System Security Settings** screen, from the **Intel TXT** option, select **On**.
11. Save the settings.
12. Restart your system.

## Control panel

### Control panel details

Your system supports:

- - If the load on the active PSU is more than 50 percent of PSU rated power wattage, then the redundant PSU is switched to the active state.
  - If the load on the active PSU falls below 20 percent of PSU rated power wattage, then the redundant PSU is switched to the sleep state.

Left control panel: Contains status LEDs, system ID button, and iDRAC Quick Sync 2 (optional).

- Right control panel: Contains power button, USB 2.0 port, VGA port micro USB for iDRAC Direct, and status LED for iDRAC Direct.

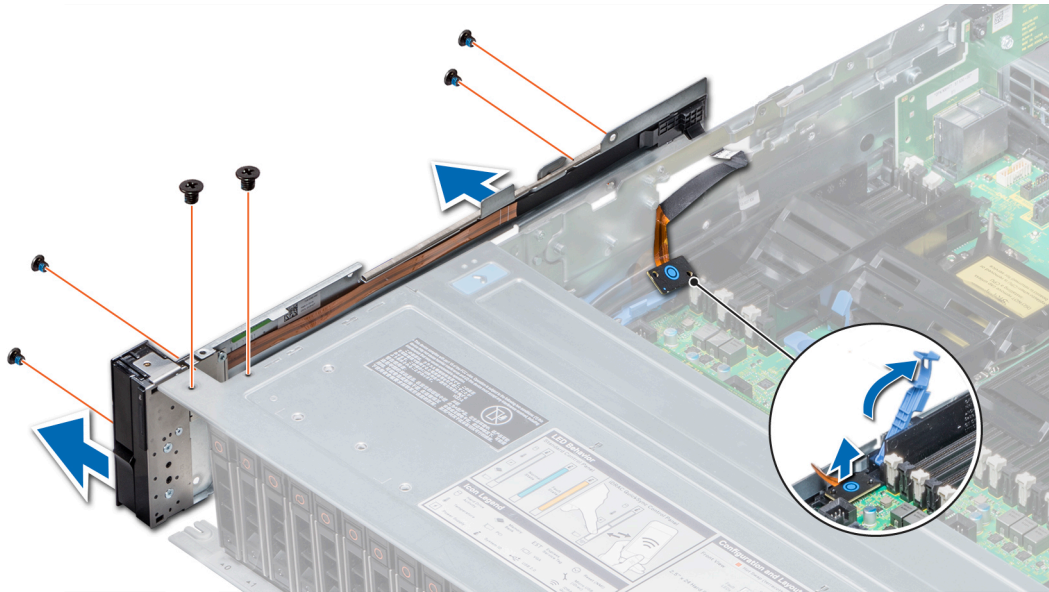
### Removing the left control panel

#### Prerequisites

1. Follow the safety guidelines listed in [Safety instructions](#).
2. Follow the procedure listed in [Before working inside your system](#).
3. [Remove the cooling fan assembly](#).
4. [Remove the air shroud](#)

#### Steps

1. Pull the cable latch and disconnect the control panel cable from the system board connector.
2. Using a Phillips #1 screwdriver, remove the screws to remove the cable cover, which secure the left control panel and cable tube to the system.
3. Holding the control panel and cable tube by its sides, remove the control panel and cable tube away from the system.



**Figure 174. Removing left control panel**

### **Next steps**

Install the left control panel.

## **Installing the left control panel**

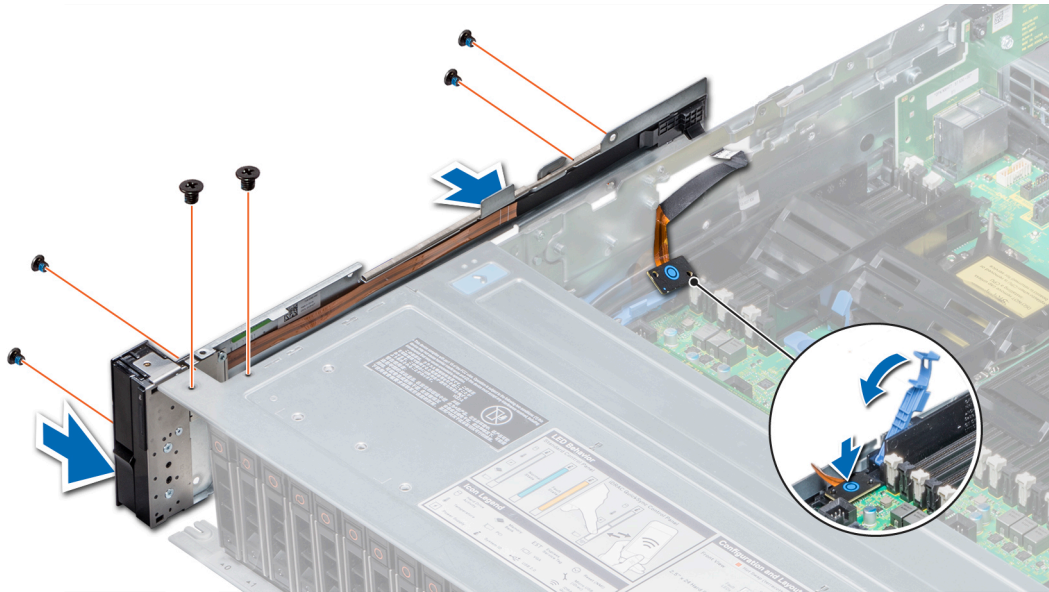
### **Prerequisites**

Follow the safety guidelines listed in [Safety instructions](#).

### **Steps**

1. Route the control panel cable through the side wall of the system.
2. Align the left control panel assembly with the control panel slot on the system and place the assembly in the slot on the system.
3. Connect the control panel cable to the system board connector and secure it using cable latch.
4. Using a Phillips #1 screwdriver, install the screws that secure the control panel and cable tube to the system.





**Figure 175. Installing left control panel**

#### **Next steps**

1. [Install the air shroud.](#)
2. [Install the cooling fan assembly.](#)
3. Follow the procedure listed in [After working inside your system.](#)

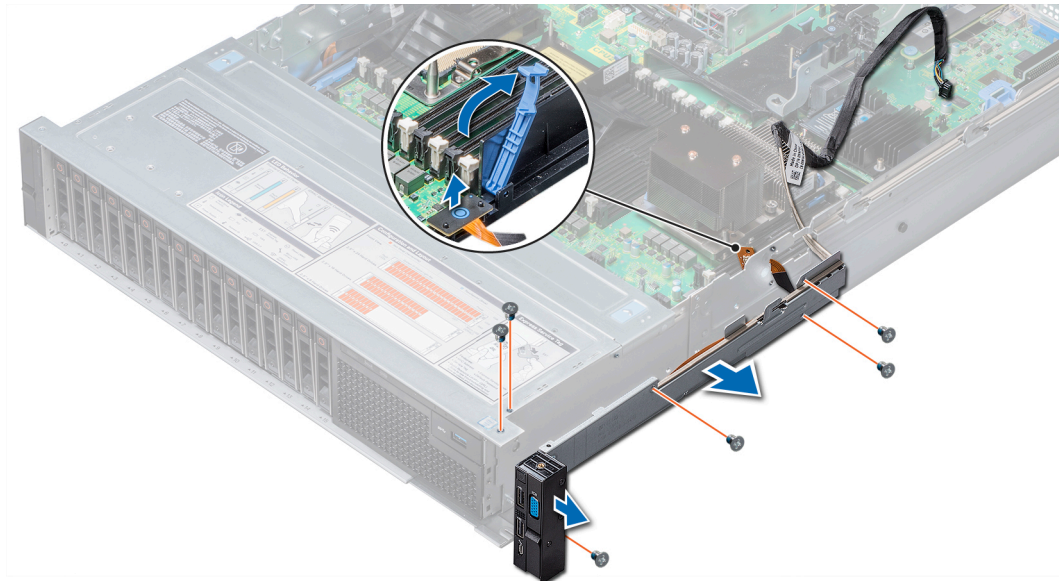
## **Removing the right control panel**

#### **Prerequisites**

1. Follow the safety guidelines listed in [Safety instructions.](#)
2. Follow the procedure listed in [Before working inside your system.](#)
3. [Remove the air shroud.](#)
4. [Remove the cooling fan assembly.](#)

#### **Steps**

1. Disconnect the VGA cable from the system board.
2. Pull the cable latch and disconnect the control panel cable from the system board connector.
3. Using Phillips #1 screwdriver, remove the screws that secure the control panel and cable tube to the system.
4. Holding the control panel and cable tube by its sides, remove the control panel and cable tube away from the system.



**Figure 176. Removing right control panel**

### **Next steps**

Install the right control panel.

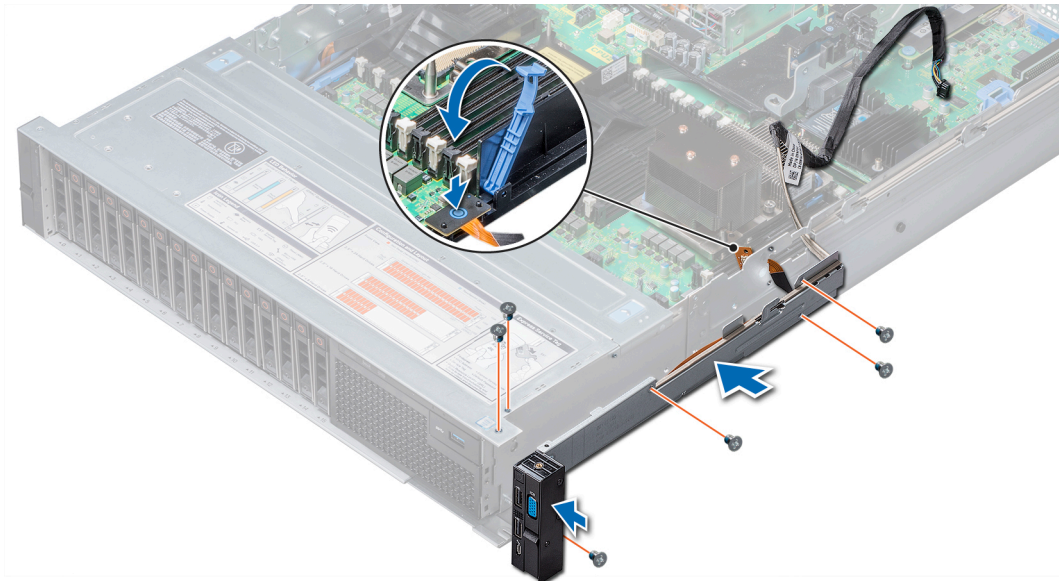
## **Installing the right control panel**

### **Prerequisites**

Follow the safety guidelines listed in [Safety instructions](#).

### **Steps**

1. Route the control panel cable and VGA cable through the side wall of the system.
2. Align the control panel with the control panel slot on the system and attach the control panel to the system.
3. Connect the VGA cable to the system board.
4. Connect the control panel cable to the connector on the system board and lower the cable latch to secure the cable in place.
5. Using a Phillips #1 screwdriver, install the screw that secures the control panel and cable tube to the system.



**Figure 177. Installing right control panel**

**Next steps**

1. Install the cooling fan assembly.
2. Install the air shroud.
3. Follow the procedure listed in [After working inside your system.](#)

# System diagnostics

If you experience a problem with your system, run the system diagnostics before contacting Dell for technical assistance. The purpose of running system diagnostics is to test your system hardware without using additional equipment or risking data loss. If you are unable to fix the problem yourself, service and support personnel can use the diagnostics results to help you solve the problem.

## Topics:

- [Dell Embedded System Diagnostics](#)

## Dell Embedded System Diagnostics

**NOTE:** The Dell Embedded System Diagnostics is also known as Enhanced Pre-boot System Assessment (ePSA) diagnostics.

The Embedded System Diagnostics provides a set of options for particular device groups or devices allowing you to:

- Run tests automatically or in an interactive mode
- Repeat tests
- Display or save test results
- Run thorough tests to introduce additional test options to provide extra information about the failed device(s)
- View status messages that inform you if tests are completed successfully
- View error messages that inform you of problems encountered during testing

## Running the Embedded System Diagnostics from Boot Manager

Run the Embedded System Diagnostics (ePSA) if your system does not boot.

### Steps

1. When the system is booting, press F11.
2. Use the up arrow and down arrow keys to select **System Utilities > Launch Diagnostics**.
3. Alternatively, when the system is booting, press F10, select **Hardware Diagnostics > Run Hardware Diagnostics**. The **ePSA Pre-boot System Assessment** window is displayed, listing all devices detected in the system. The diagnostics starts executing the tests on all the detected devices.

## Running the Embedded System Diagnostics from the Dell Lifecycle Controller

### Steps

1. As the system boots, press F10.
2. Select **Hardware Diagnostics → Run Hardware Diagnostics**. The **ePSA Pre-boot System Assessment** window is displayed, listing all devices detected in the system. The diagnostics starts executing the tests on all the detected devices.

## System diagnostic controls

Menu	Description
<b>Configuration</b>	Displays the configuration and status information of all detected devices.

<b>Menu</b>	<b>Description</b>
<b>Results</b>	Displays the results of all tests that are run.
<b>System health</b>	Provides the current overview of the system performance.
<b>Event log</b>	Displays a time-stamped log of the results of all tests run on the system. This is displayed if at least one event description is recorded.

## Jumpers and connectors

This topic provides specific information about the jumpers. It also provides some basic information about jumpers and switches and describes the connectors on the various boards in the system. Jumpers on the system board help to disable the system and setup passwords. You must know the connectors on the system board to install components and cables correctly.

### Topics:

- System board jumpers and connectors
- System board jumper settings
- Disabling forgotten password

## System board jumpers and connectors

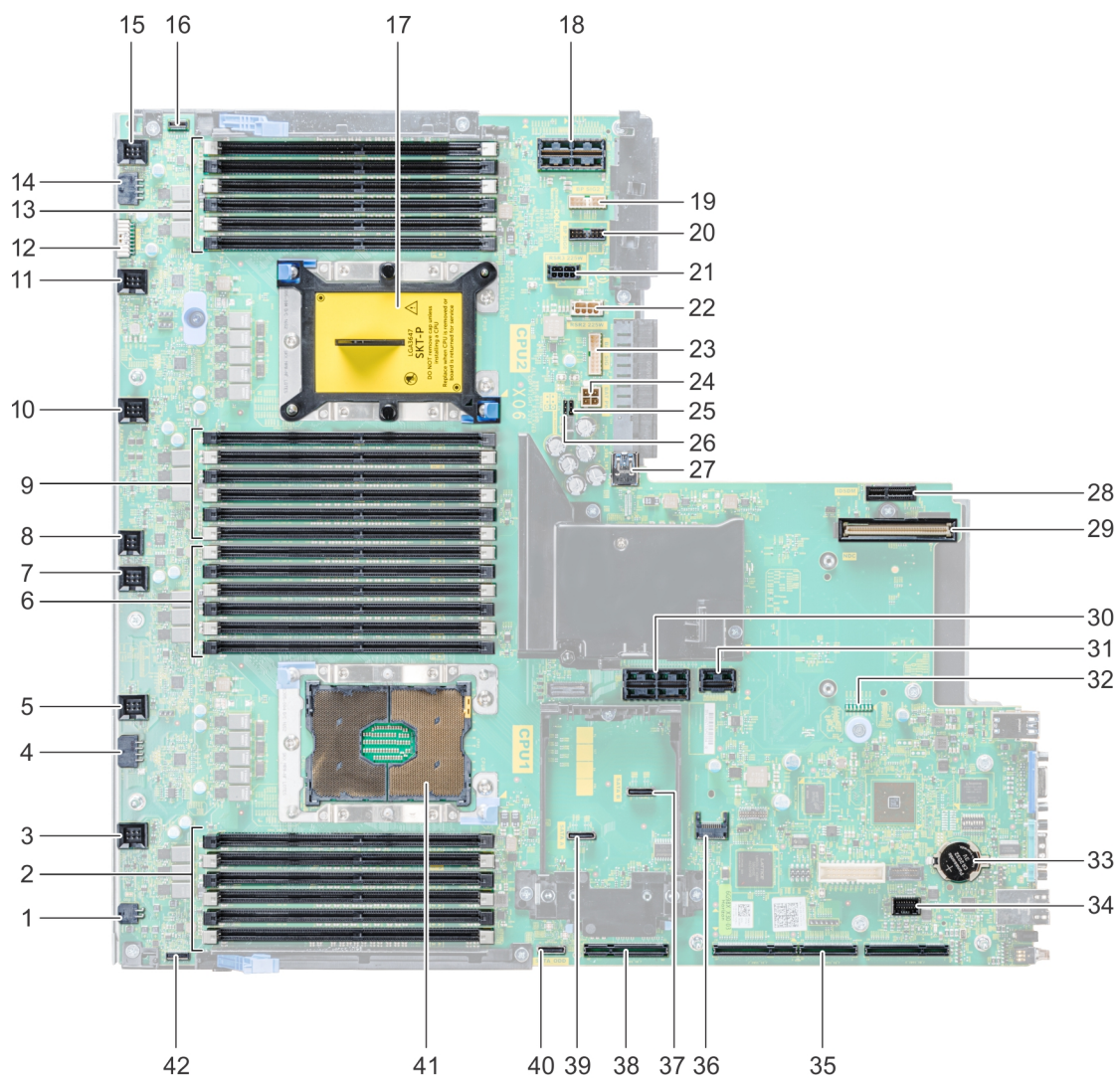


Figure 178. System board jumpers and connectors

**Table 29. System board jumpers and connectors**

<b>Item</b>	<b>Connector</b>	<b>Description</b>
1	J_ODD	Optical drive power connector
2	A7, A1, A8, A2, A9, A3	Memory module sockets
3	J_FAN2U_6	Cooling fan 6 connector
4	J_BP3	Backplane 3 power connector
5	J_FAN2U_5	Cooling fan 5 connector
6	A6, A12, A5, A11, A4, A10	Memory module sockets
7	J_FAN2U_4	Cooling fan 4 connector
8	INTRUSION_DET	Intrusion switch connector
9	B7, B1, B8, B2, B9, B3	Memory module sockets
10	J_FAN2U_3	Cooling fan 3 connector
11	J_FAN2U_2	Cooling fan 2 connector
12	J_BP_SIG1	Backplane 1 signal connector
13	B6, B12, B5, B11, B4, B10	Memory module sockets
14	J_BP1	Backplane 1 power connector
15	J_FAN2U_1	Cooling fan 1 connector
16	P_LFT_CP	Left control panel connector
17	CPU2	CPU2 processor and heat sink module socket (with dust cover)
18	J_R3_X24	Riser 3 connector
19	J_BP_SIG2	Backplane 2 signal connector
20	J_BP_SIG0	Backplane 0 signal connector
21	J_BP0 (RSR3_225W)	Backplane 0 power connector (Riser 3 PCIe 225 W power)
22	J_BP2 (RSR2_225W)	Backplane 2 power connector (Riser 2 PCIe 225 W power)
23	J_BATT_SIG	NVDIMM-N battery signal connector
24	J_BATT_PWR	NVDIMM-N battery power connector
25	PWRD_EN	Reset BIOS password
26	NVRAM_CLR	Clear NVRAM
27	J_USB_INT	Internal USB connector
28	J_IDSDM	IDS DM/vFlash connector
29	J_NDC	NDC connector
30	J_R2_X24_IT9	Riser 2 connector
31	J_R2_3R_X8_IT9	Riser 2 connector
32	LEDs	System board diagnostic LED indicators
33	BATTERY	Battery connector
34	J_FRONT_VIDEO	Video connector
35	J_R1_SS82_3 and J_R1_SS60_1	Riser 1 connector

**Table 29. System board jumpers and connectors (continued)**

Item	Connector	Description
36	J_TPM_MODULE	TPM connector
37	J_SATA_B	SATA B connector
38	J_R1_SS82_1	Riser 1 connector (Mini PERC option)
39	J_SATA_A	SATA A connector
40	J_SATA_C	SATA C connector (Optical drive SATA connector)
41	CPU1	CPU1 processor and heat sink module
42	P_RGT_CP	Right control panel connector

## System board jumper settings

For information on resetting the password jumper to disable a password, see the [Disabling a forgotten password](#) section.

## Disabling forgotten password

The software security features of the system include a system password and a setup password. The password jumper enables or disables password features and clears any password(s) currently in use.

### Prerequisites

**CAUTION:** Many repairs may only be done by a certified service technician. You should only perform troubleshooting and simple repairs as authorized in your product documentation, or as directed by the online or telephone service and support team. Damage due to servicing that is not authorized by Dell is not covered by your warranty. Read and follow the safety instructions that are shipped with your product.

### Steps

1. Power off the system, including any attached peripherals, and disconnect the system from the electrical outlet.
2. Remove the system cover.
3. Move the jumper on the system board jumper from pins 2 and 4 to pins 4 and 6.
4. Install the system cover.

The existing passwords are not disabled (erased) until the system boots with the jumper on pins 4 and 6. However, before you assign a new system and/or setup password, you must move the jumper back to pins 2 and 4.

**NOTE:** If you assign a new system and/or setup password with the jumper on pins 4 and 6, the system disables the new password(s) the next time it boots.

5. Reconnect the system to its electrical outlet and power on the system, including any attached peripherals.
6. Power off the system, including any attached peripherals, and disconnect the system from the electrical outlet.
7. Remove the system cover.
8. Move the jumper on the system board jumper from pins 4 and 6 to pins 2 and 4.
9. Install the system cover.
10. Reconnect the system to its electrical outlet and power on the system, including any attached peripherals.
11. Assign a new system and/or setup password.



# Getting help

## Topics:

- [Contacting Dell EMC](#)
- [Documentation feedback](#)
- [Accessing system information by using QRL](#)
- [Receiving automated support with SupportAssist](#)
- [Recycling or End-of-Life service information](#)

## Contacting Dell EMC

Dell EMC provides several online and telephone based support and service options. If you do not have an active internet connection, you can find contact information about your purchase invoice, packing slip, bill, or Dell EMC product catalog. Availability varies by country and product, and some services may not be available in your area. To contact Dell EMC for sales, technical assistance, or customer service issues:

### Steps

1. Go to [www.dell.com/support/home](http://www.dell.com/support/home).
2. Select your country from the drop-down menu on the lower right corner of the page.
3. For customized support:
  - a. Enter your system Service Tag in the **Enter your Service Tag** field.
  - b. Click **Submit**.  
The support page that lists the various support categories is displayed.
4. For general support:
  - a. Select your product category.
  - b. Select your product segment.
  - c. Select your product.  
The support page that lists the various support categories is displayed.
5. For contact details of Dell EMC Global Technical Support:
  - a. Click [Contact Technical Support](#).
  - b. Enter your system Service Tag in the **Enter your Service Tag** field on the Contact Us webpage.

## Documentation feedback

You can rate the documentation or write your feedback on any of our Dell EMC documentation pages and click **Send Feedback** to send your feedback.

## Accessing system information by using QRL

You can use the Quick Resource Locator (QRL) located on the information tag in the front of the system, to access the information about the PowerEdge system.

### Prerequisites

Ensure that your smartphone or tablet has the QR code scanner installed.

The QRL includes the following information about your system:

- How-to videos

- Reference materials, including the Installation and Service Manual, LCD diagnostics, and mechanical overview
- Your system service tag to quickly access your specific hardware configuration and warranty information
- A direct link to Dell to contact technical assistance and sales teams

### Steps

1. Go to [www.dell.com/qrl](http://www.dell.com/qrl) and navigate to your specific product or
2. Use your smartphone or tablet to scan the model-specific Quick Resource (QR) code on your system or in the Quick Resource Locator section.

## Quick Resource Locator for PowerEdge R740 and R740xd systems



Figure 179. Quick Resource Locator for PowerEdge R740 and R740xd systems

## Receiving automated support with SupportAssist

Dell EMC SupportAssist is an optional Dell EMC Services offering that automates technical support for your Dell EMC server, storage, and networking devices. By installing and setting up a SupportAssist application in your IT environment, you can receive the following benefits:

- **Automated issue detection** — SupportAssist monitors your Dell EMC devices and automatically detects hardware issues, both proactively and predictively.
- **Automated case creation** — When an issue is detected, SupportAssist automatically opens a support case with Dell EMC Technical Support.
- **Automated diagnostic collection** — SupportAssist automatically collects system state information from your devices and uploads it securely to Dell EMC. This information is used by Dell EMC Technical Support to troubleshoot the issue.
- **Proactive contact** — A Dell EMC Technical Support agent contacts you about the support case and helps you resolve the issue.

The available benefits vary depending on the Dell EMC Service entitlement purchased for your device. For more information about SupportAssist, go to [www.dell.com/supportassist](http://www.dell.com/supportassist).

## Recycling or End-of-Life service information

Take back and recycling services are offered for this product in certain countries. If you want to dispose of system components, visit [www.dell.com/recyclingworldwide](http://www.dell.com/recyclingworldwide) and select the relevant country.