



Harry Potter

71043



Booklet available in English on
Heft in deutscher Sprache erhältlich auf
Livret disponible en français sur
Libretto disponibile in italiano su
Folleto disponibile en español en
Folheto disponível em português em
A füzet magyarul ezen a honlapon olvasható:
Buklets latviešu valodā pieejams vietnē
如需中文版手册, 请访问 LEGO.com/harrypotter



LEGO.com/harrypotter

WIZARDING
WORLD

Welcome back to Hogwarts™



“Help will always be given
at Hogwarts to those who ask for it.”
Albus Dumbledore™

Begin a magical journey with this detailed replica of the iconic Hogwarts™ Castle.

Explore the prestigious school of witchcraft and wizardry. Experience a microscale LEGO® model built from over 6,000 pieces and packed with authentic details for a rewarding building experience. Discover the intricately designed chambers, towers, classrooms and many other hidden features depicting scenes from the Harry Potter™ series and recreate the movies’ pivotal moments of magic and adventure. The set also contains 27 microfigures including Harry, Hermione and Ron, in addition to a spellbinding assortment of iconic accessories and artefacts.

There’s magic in the details...

Transforming Movie Moments into LEGO® Scenes

Translating the magical onscreen locations into a LEGO® model in microscale was an exciting design challenge. To represent the key architectural structures, iconic silhouettes and details in tiny bricks, whilst retaining the unforgettable look and feel of the movies, was not an easy task.

In the Great Hall, many elements including the tables, fire pits and house banners had to be scaled to fit into the model.



Recreating the iconic Wizard's Chess game in the small space available in the model meant halving the proportions of the chessboard. By making this compromise, there was also room to have the base of another tower in the model.

In the movie series, Professor Snape™ says that students in his Potions class were there to 'learn the subtle science and exact art of potion making'. Therefore, our version of the classroom had to be filled with all the equipment that witches and wizards would need, including multiple shelves of potions, classroom desks featuring small cauldrons and gold scripture detailing on the walls.



We hope fans enjoy building their Hogwarts™ moments and that these small details bring the model to life and help the story live on.

The Four Founders

Hogwarts™ School of Witchcraft and Wizardry was founded by Godric Gryffindor, Helga Hufflepuff, Salazar Slytherin and Rowena Ravenclaw in the 10th Century. Each of the four founders then created their own house at the school. For many years, all was well amongst the founders. However, a rift appeared when Salazar Slytherin suggested that only pupils from 'pureblood', magical families were eligible to attend Hogwarts.



Godric Gryffindor

Godric valued courage and was known for his own bravery and skills as an accomplished dueler. Godric was the original owner of the Sorting Hat and also The Sword of Gryffindor that would present itself to any true Gryffindor™ in a moment of need.



Helga Hufflepuff

Helga strongly believed in justice and loyalty, values on which the Hufflepuff™ house stands. She was particularly gifted at food-related charms and was the talent behind many traditional Hogwarts recipes. Helga's portrait can be seen in the Hufflepuff

common room, toasting her students with her golden cup that was passed down to her descendants for centuries.



Salazar Slytherin

Salazar was a highly talented wizard as one of the first recorded Parselmouths and an accomplished Legilimens. He was also a notorious champion of pureblood supremacy and his hostile nature to Muggle-borns created a great divide and led to his departure from

the school. Before he left, he built a secret room inside the castle with a great statue of himself and a monster inside that only he could control.



Rowena Ravenclaw

Above all else, Rowena Ravenclaw valued intelligence and was regarded as one of the greatest witches of her age. Rowena also wore a diadem that was said to grant wisdom to the wearer. Legend has it that a broken heart contributed to her early demise. Her

daughter Helena (the Grey Lady) became the Ravenclaw house ghost.



Microfigures

Harry Potter™, Ron Weasley™, Hermione Granger™, Draco Malfoy™, Albus Dumbledore™, Professor McGonagall™, Severus Snape™, Remus Lupin, Professor Dolores Umbridge™, Argus Filch, Gryffindor students, Hufflepuff students, Slytherin students, Ravenclaw students, Lord Voldemort™, Bellatrix Lestrange, Chess pieces, Statue of the Hogwarts Architect, Dementors.

About the LEGO® Design Team

The project team for this model consisted of Model Designers, Graphic Designers, Element Designers, the Marketing Team, Building Instructions Developers, a Model Coach (who assessed if the model was designed correctly) and a Design Lead (who has the overview of the full project), amongst others.

From left to right/top-down:

Charlotte Fey - Project Manager

Hélène Despres - Marketing Manager

Pia Elisabeth Jungdal - Master Data Specialist

Susan Due - Building Instruction Specialist

Connie Bork - Model Coach

Joel Baker - Concept Designer

Justin Ramsden – Model Designer

Andrew Hugh Seenan - Design Manager

Michael Vibede Vanting

- Senior Marketing Manager

Crystal Marie Fontan - Graphic Designer



Justin Ramsden – LEGO® Model Designer:

“It has been a few years since the last LEGO® Hogwarts™ Castle was released. Even at its microscale, this is the eighth and largest Hogwarts Castle LEGO model to date. Another LEGO designer, Joel Baker designed a sketch model of the castle, so this was the starting point. I took over with the challenge of making that sketch into a model for fans. My design approach focused on capturing the essence of Hogwarts; its iconic silhouette, the exciting feeling of going back to school and starting a new adventure. I wanted to recreate all the iconic locations from the castle and moments from the movie series in ‘micro-detail’, including the moving staircases, the Whomping Willow™, Professor Lupin’s Boggart lesson in the Defence Against the Dark Arts classroom and the Basilisk encounter in the Chamber of Secrets.



For this model, we also managed to develop three new LEGO building elements that helped to further capture the fantastic architectural detail of Hogwarts. I was very excited to include these two new window arch elements and a half cone piece into the model as I am not only very eager to see how the fans will use the elements in new and exciting ways but, I can’t wait to see the new building opportunities that they bring to the LEGO building system.

As a LEGO® model designer, you can either work digitally or just get on your hands and knees and start building! The latter is how I approach it, making iteration after iteration until I get to the final product. During the design process, I tend to keep as many of the previous sketches of the castle as I can, so that I can see the physical progression from concept to finished model. Many of these sketch models have very unusual colour schemes, as I tend to use interesting colours when I build with whatever bricks are closest to hand!

One detail that LEGO fans may not notice is that the piece count of the Hogwarts™ Castle is 6,020 elements. This is personally significant for me because it is the set number of a classic LEGO Castle model that I had when I was five years old - a small model that co-incidentally featured a wizard. It was this set, amongst others, which inspired me to become a LEGO designer.

Furthermore, as 2018 is the 60th anniversary of the LEGO brick, I hid the iconic 2x4 red brick in as many places as I could.”



Crystal Marie Fontan – LEGO Graphic Designer:

“I worked closely with Justin and fellow LEGO Graphic Designer Djordje Djordjevic (with support from other graphic designers), in creating all the characters for the model, as well as the stickers and decorated elements.

Generally, with the stickers for models, less is more. Stickers are also important to bring in that layer of magic and storytelling from the Harry Potter™ series. For example, small details such as depicting the door to the Room of Requirement or the keys in the flying key room can only be achieved via stickers at this scale. Stickers are also where all the magical secrets get embedded in the model!



This was a great project to work on because I am such a big fan of the Harry Potter series; it’s like working in a magical universe. I really want other fans to enjoy the models, stickers and decorations that we have created for them!”





Godric Gryffindor Helga Hufflepuff Salazar Slytherin Rowena Ravenclaw



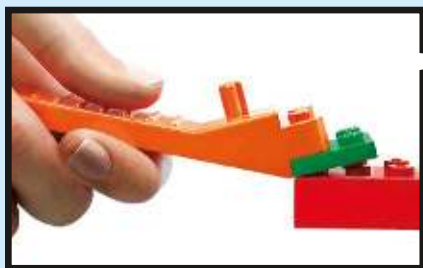
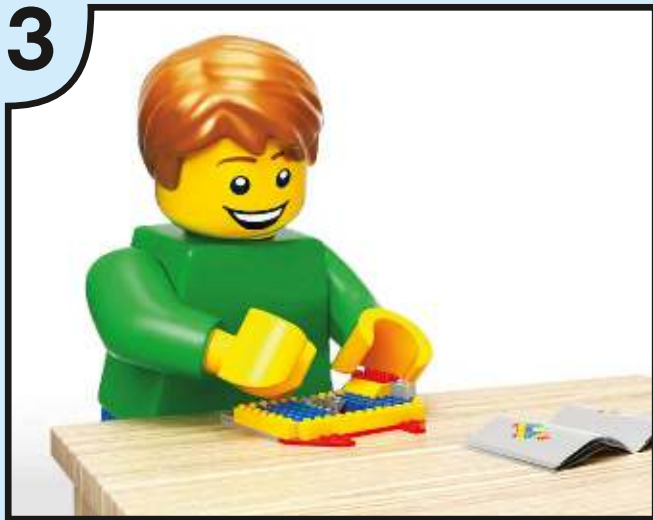

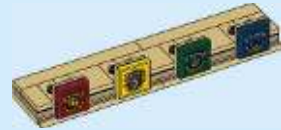

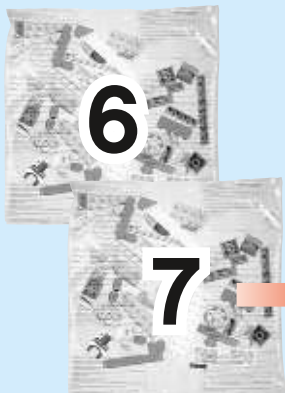
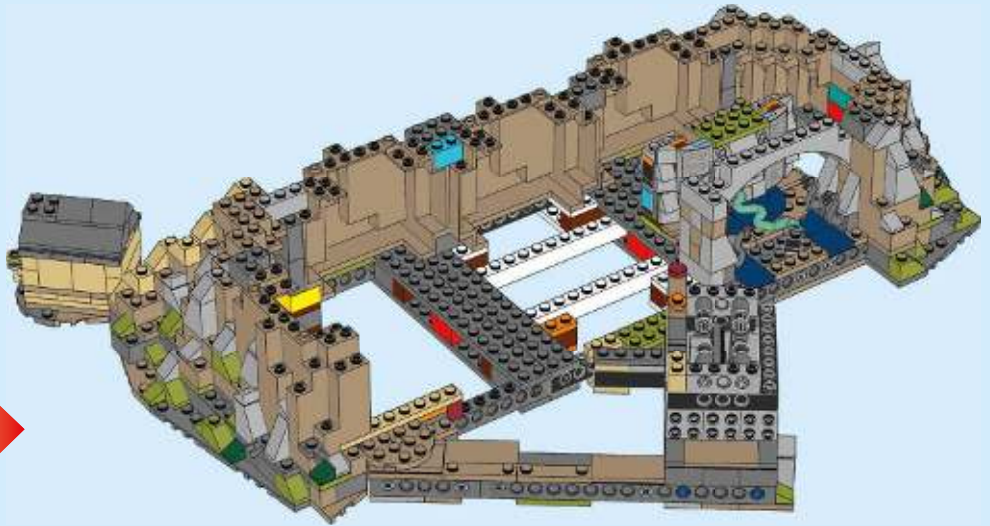

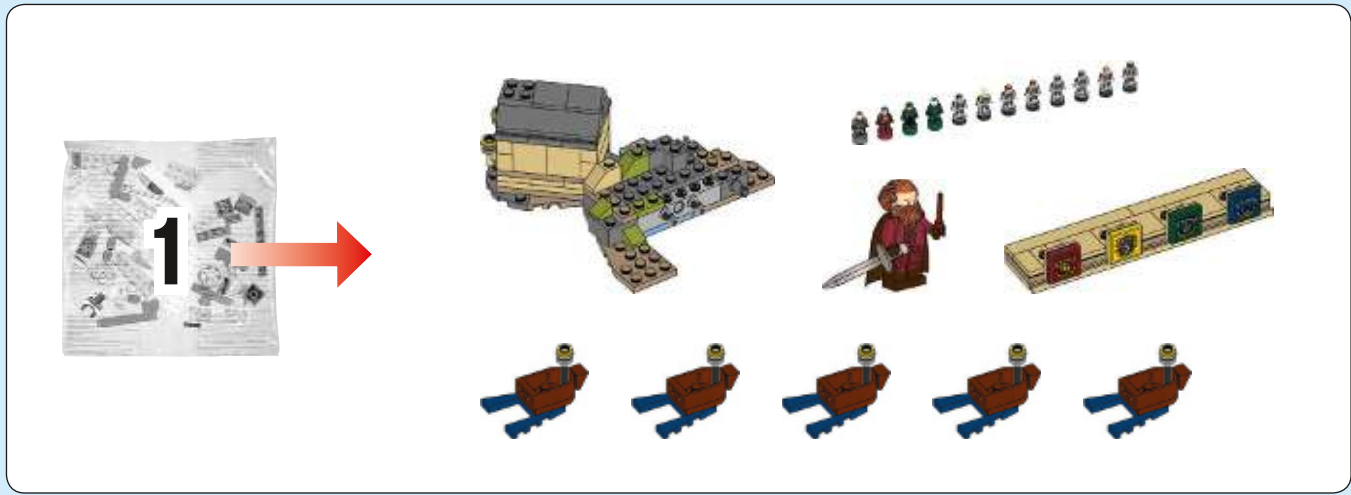

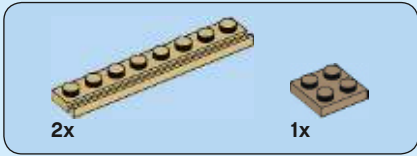
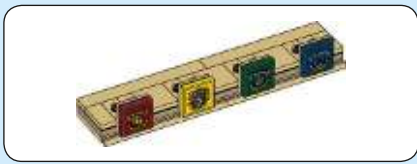

1

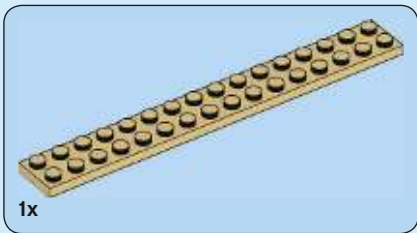
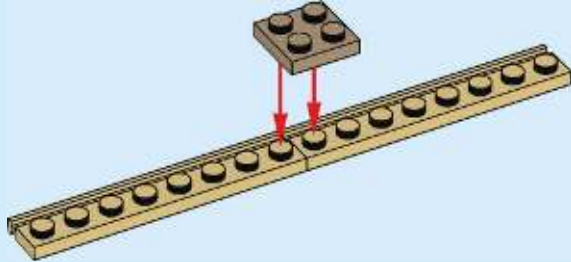

2

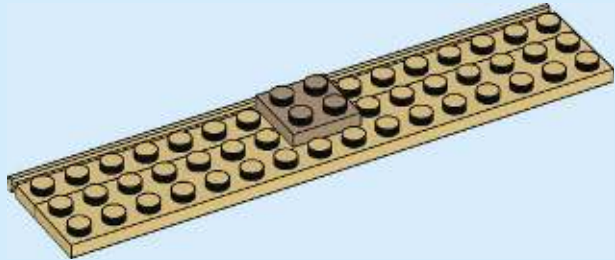

3

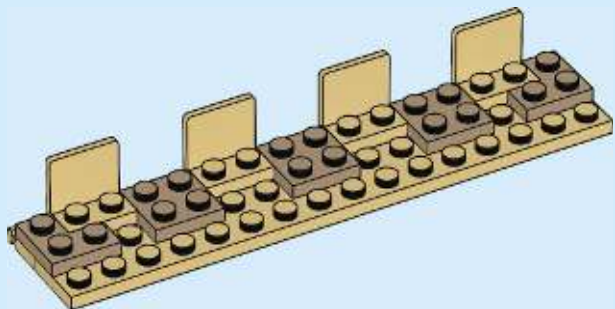



4

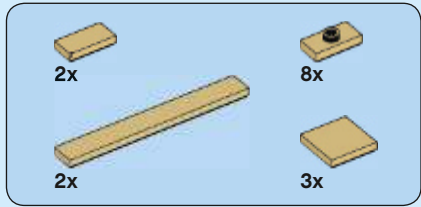
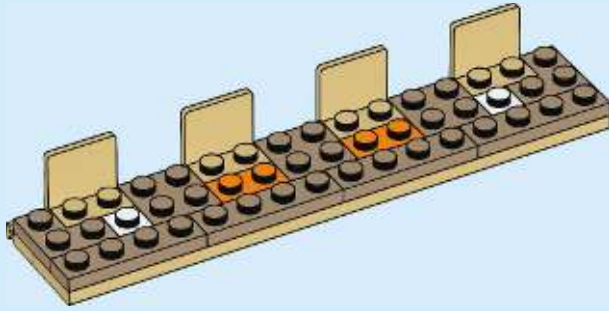

5

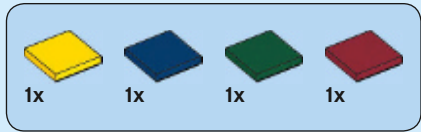
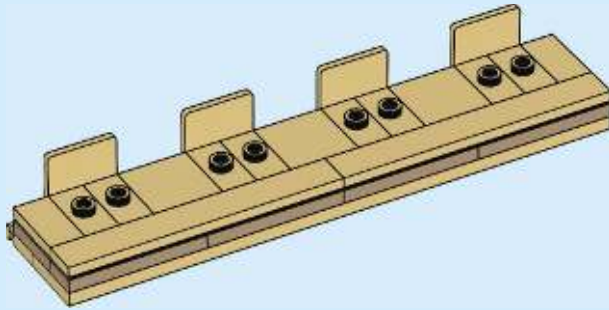

6

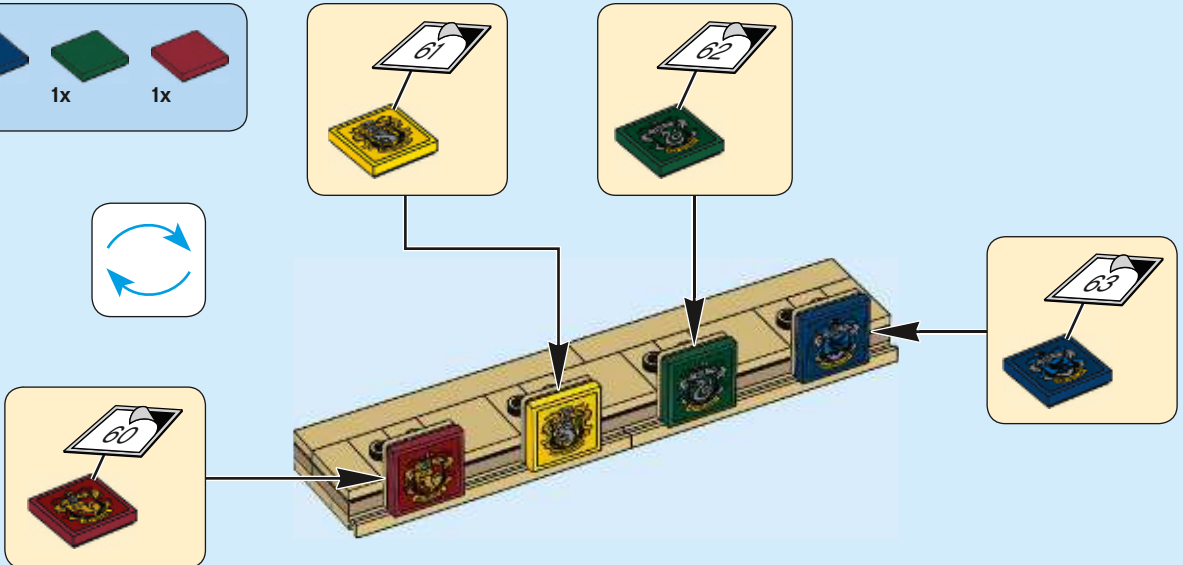



1

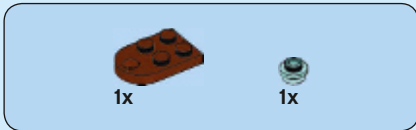

2

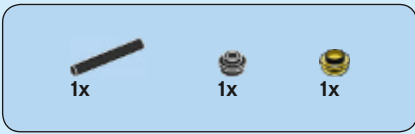
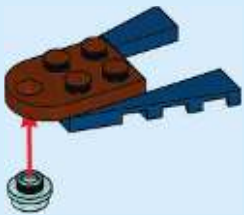

3

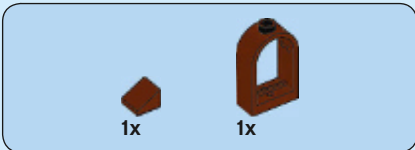
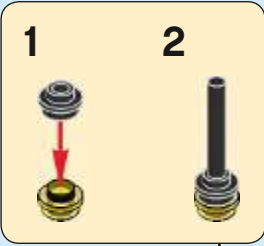

4

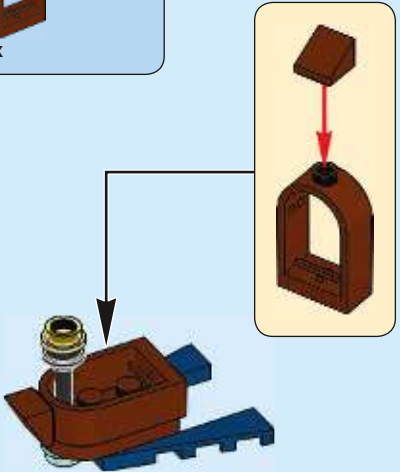

5x

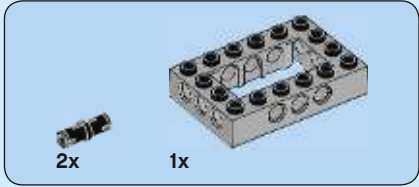
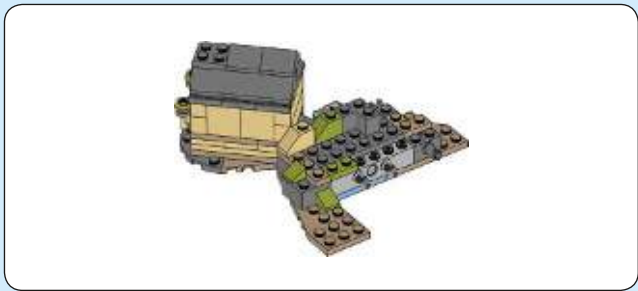

1

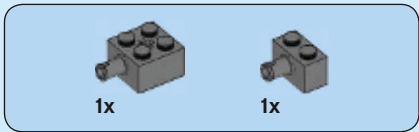
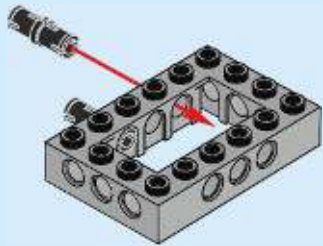

2

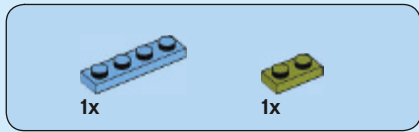
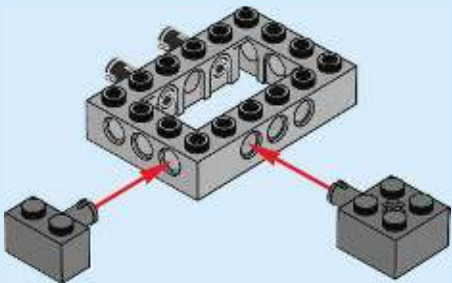

3

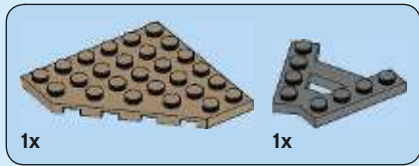
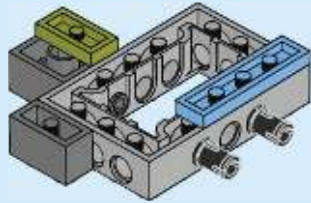
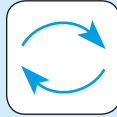

4

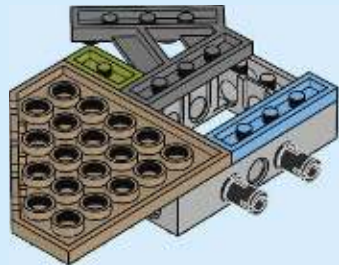



5

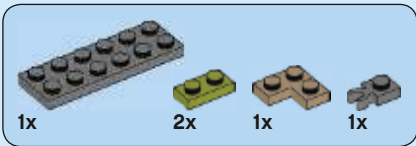

6

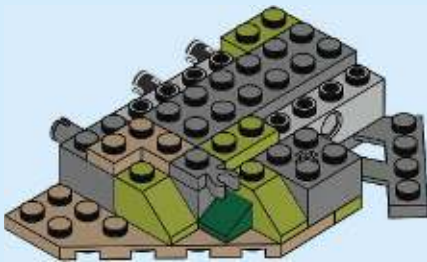

7

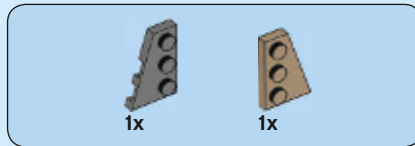
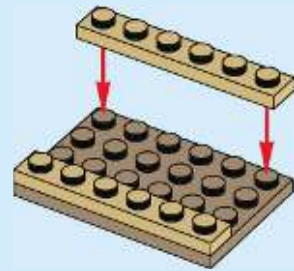
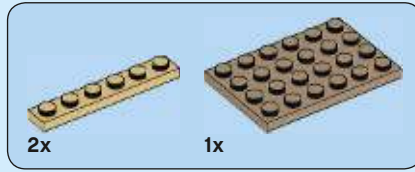

8

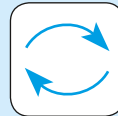



9

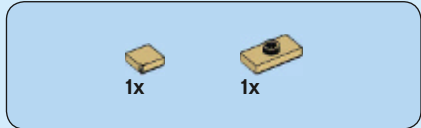

10

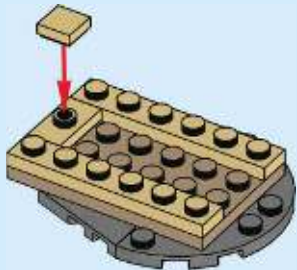
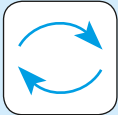

11

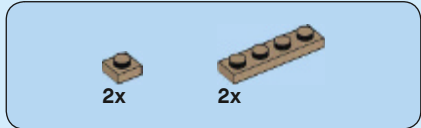
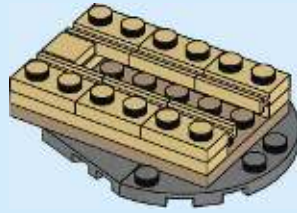

12

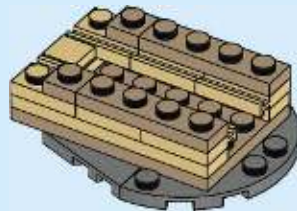

13

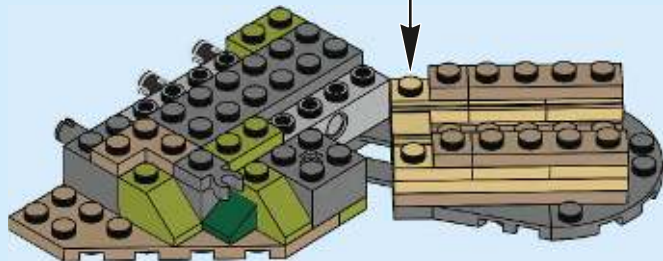

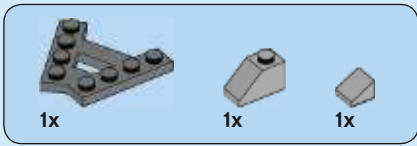

14

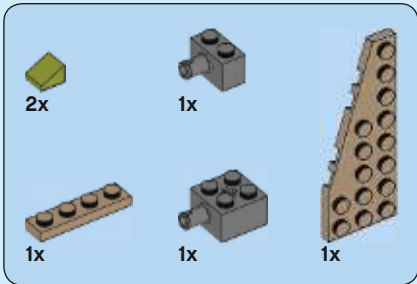
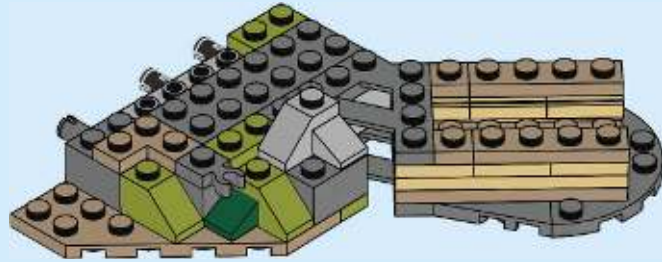

15

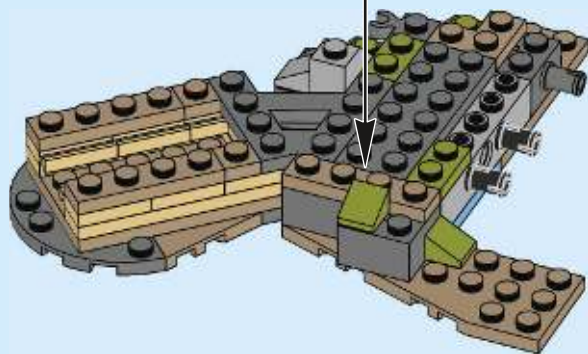
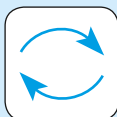
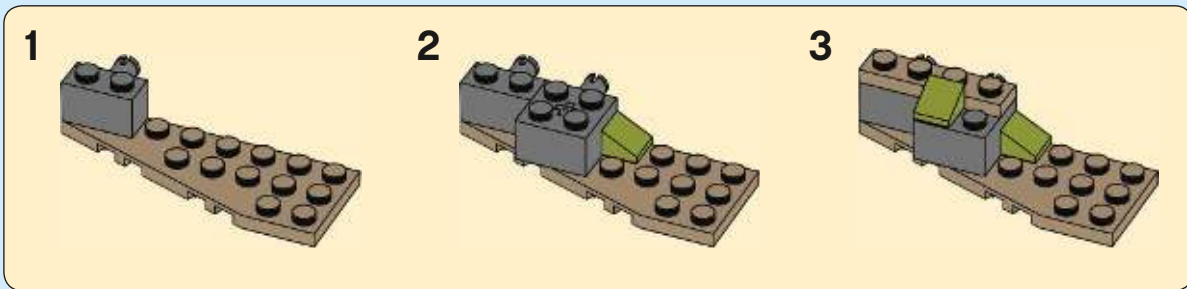

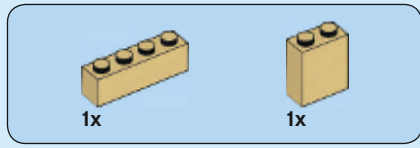

16

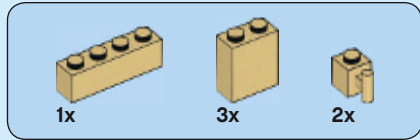
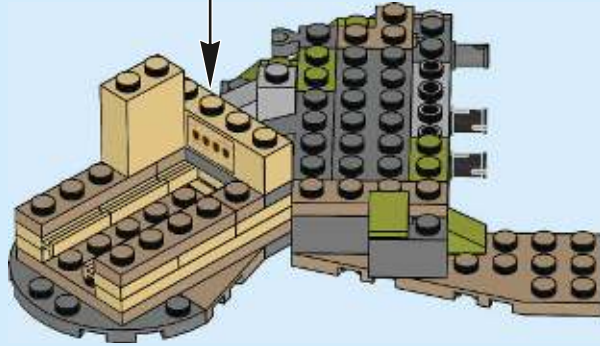
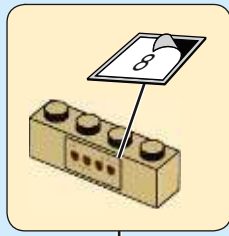

17

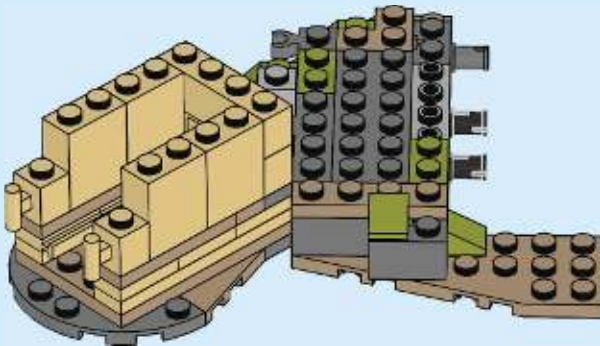

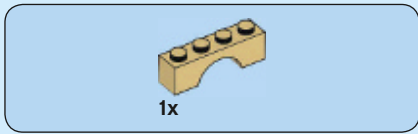

18

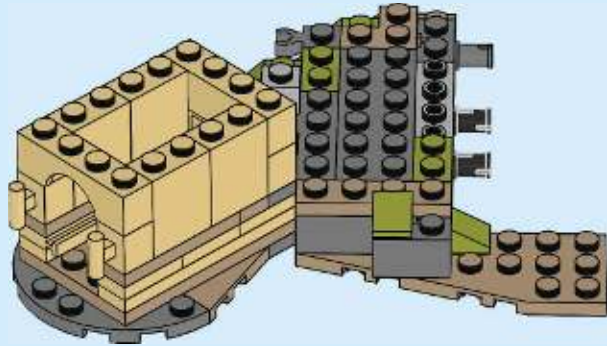

19

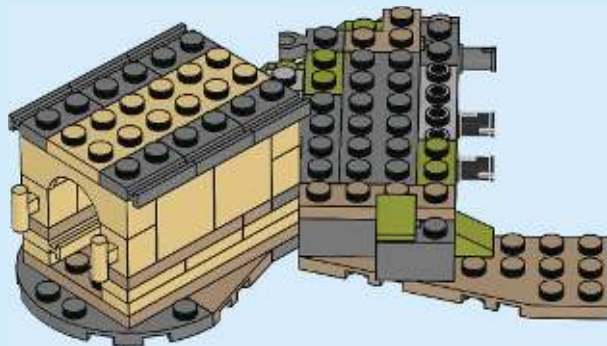

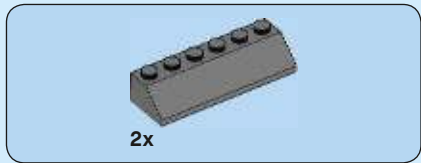

20

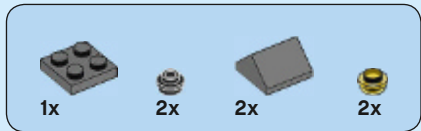
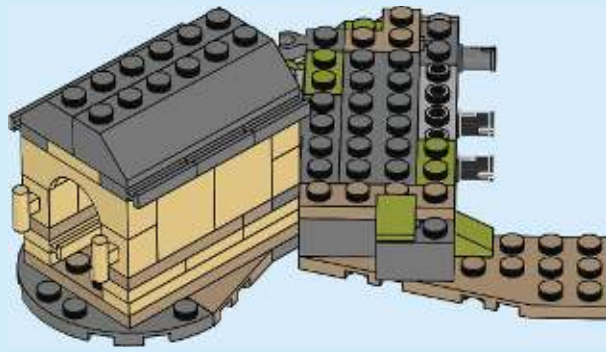

21

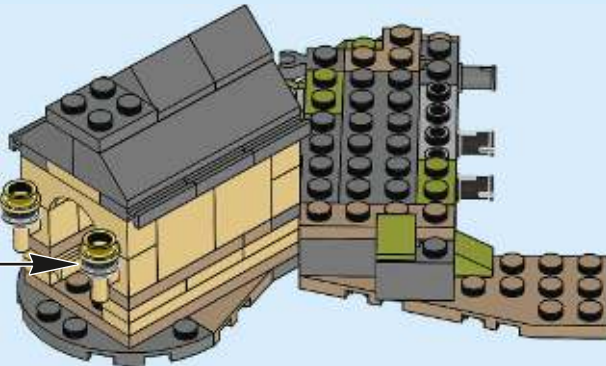

22

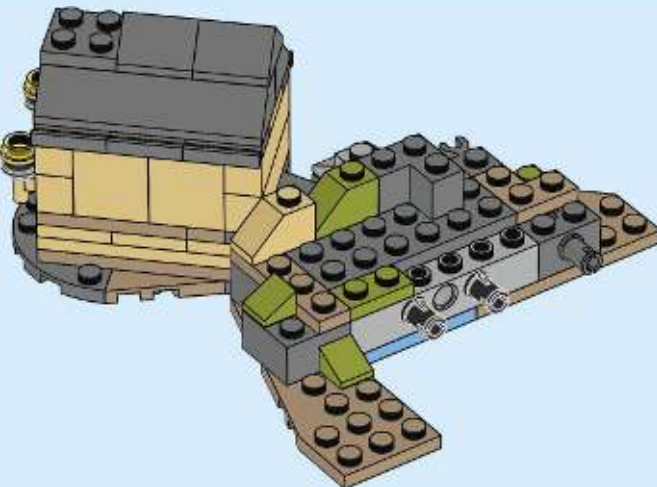

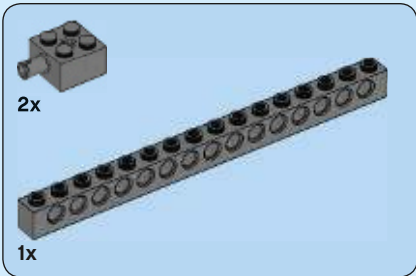
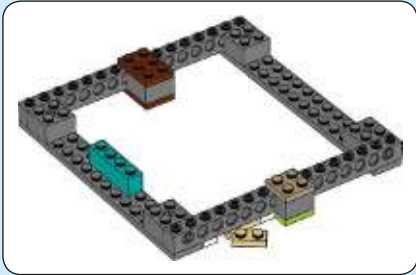
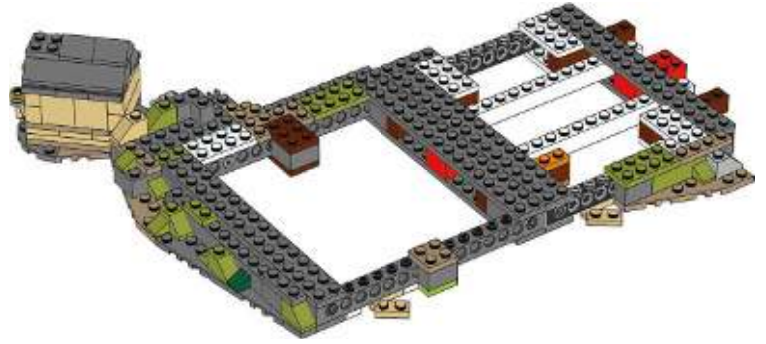

23



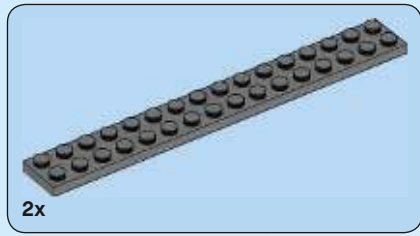

24

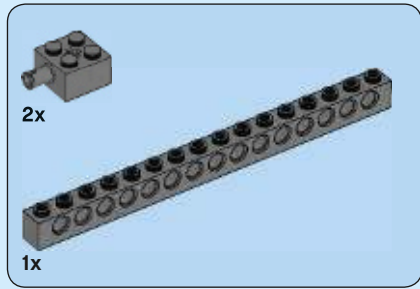
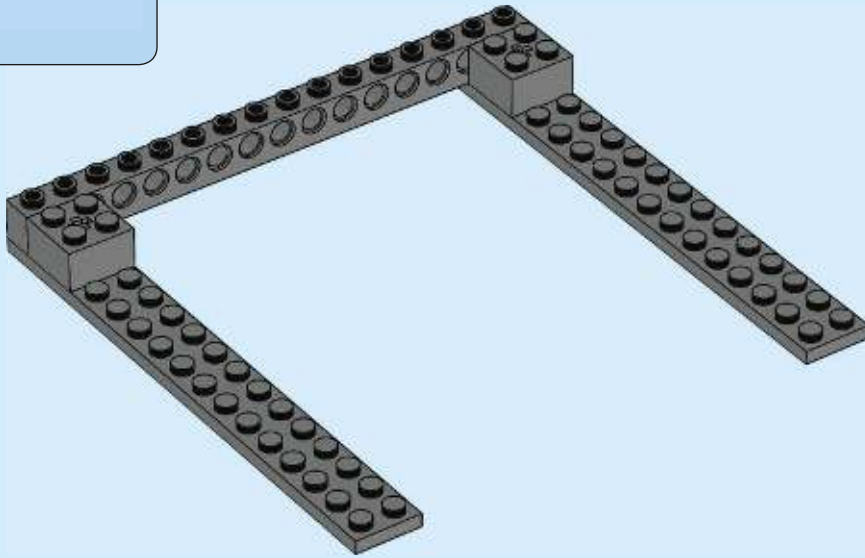

25

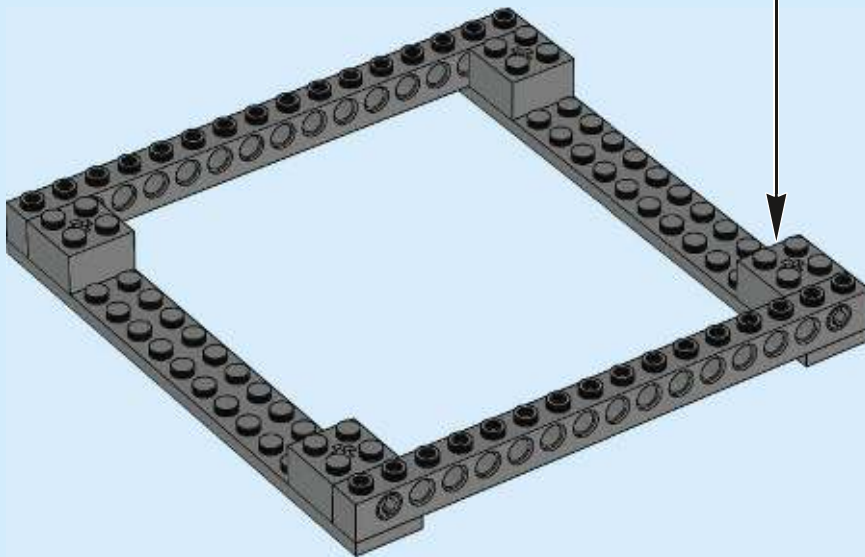
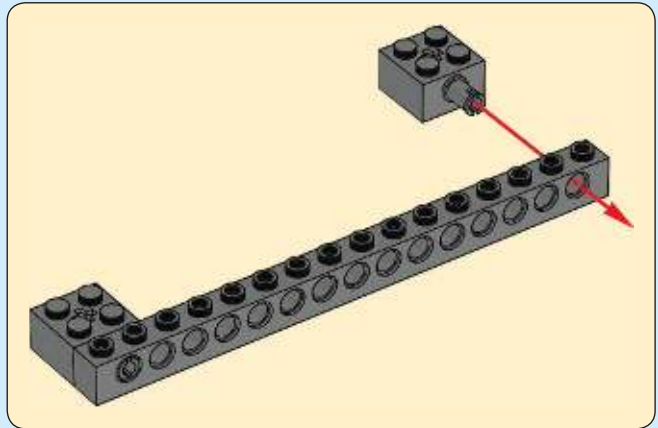

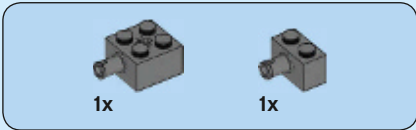

26

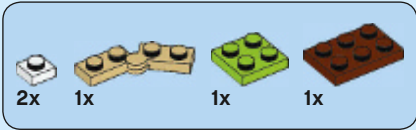
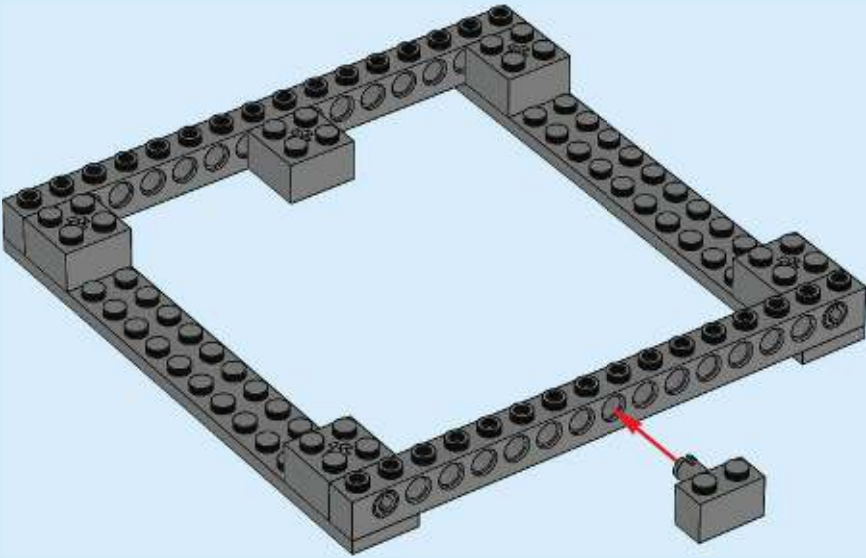

27

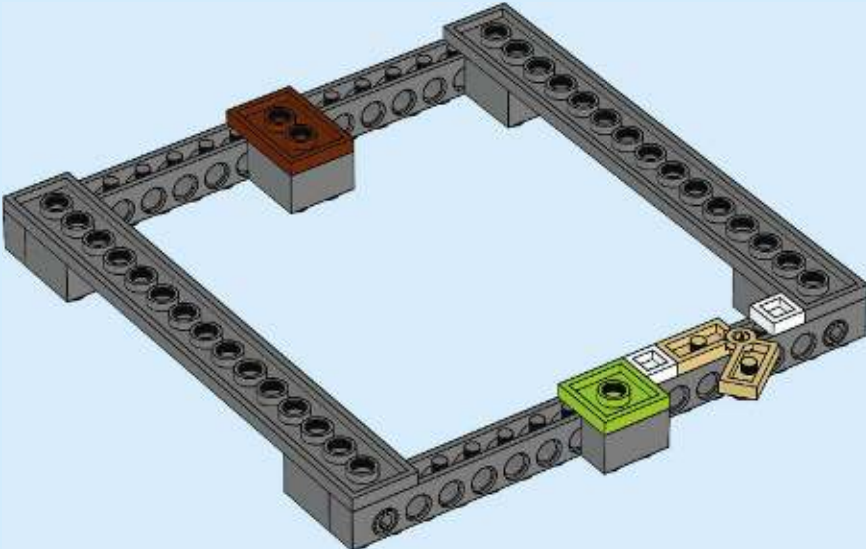
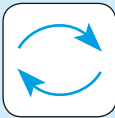

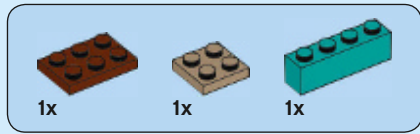

28

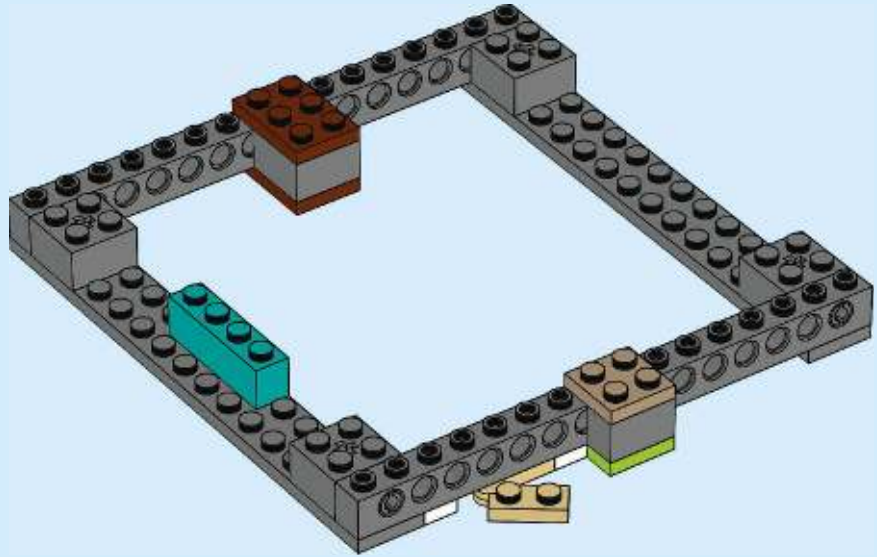
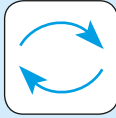

29

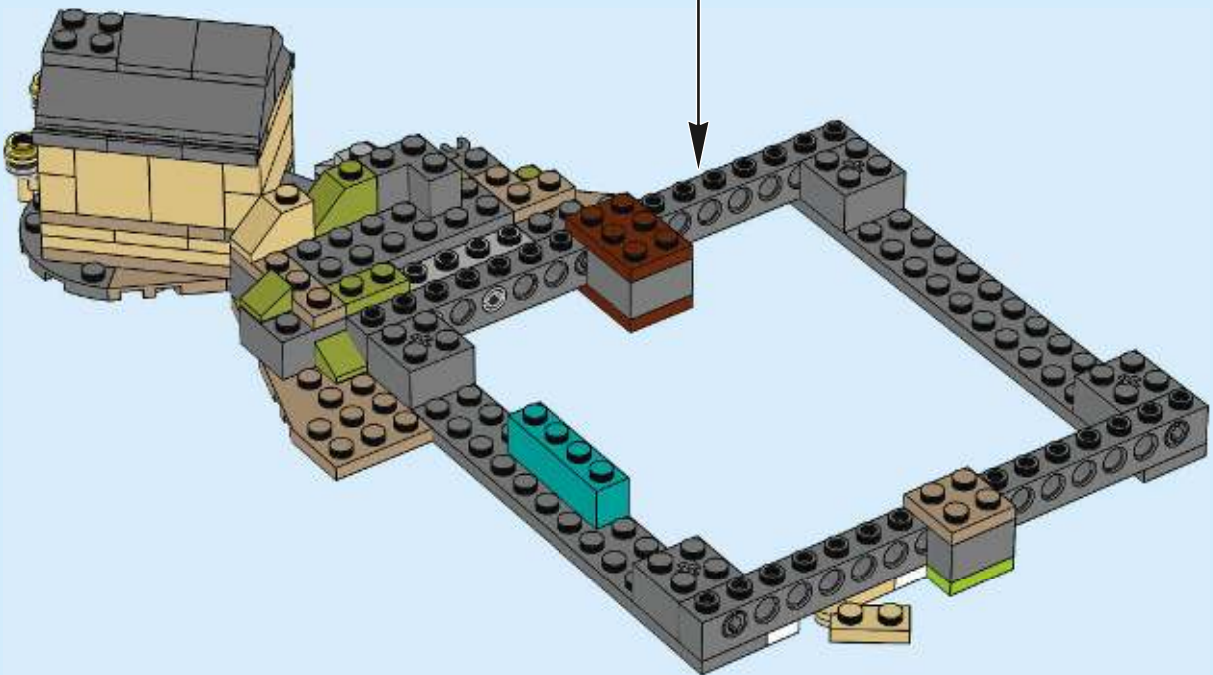



30



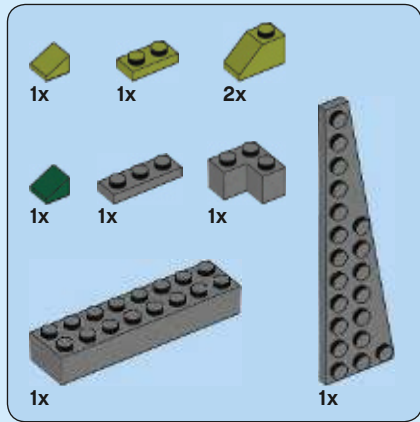

31

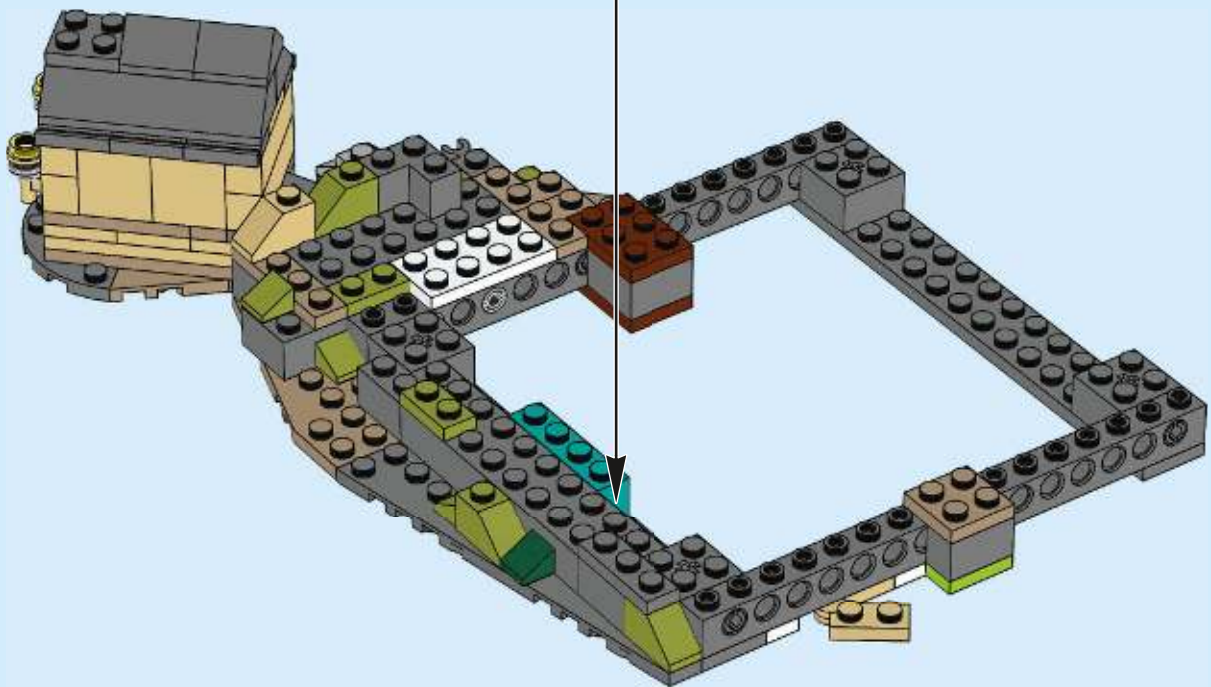
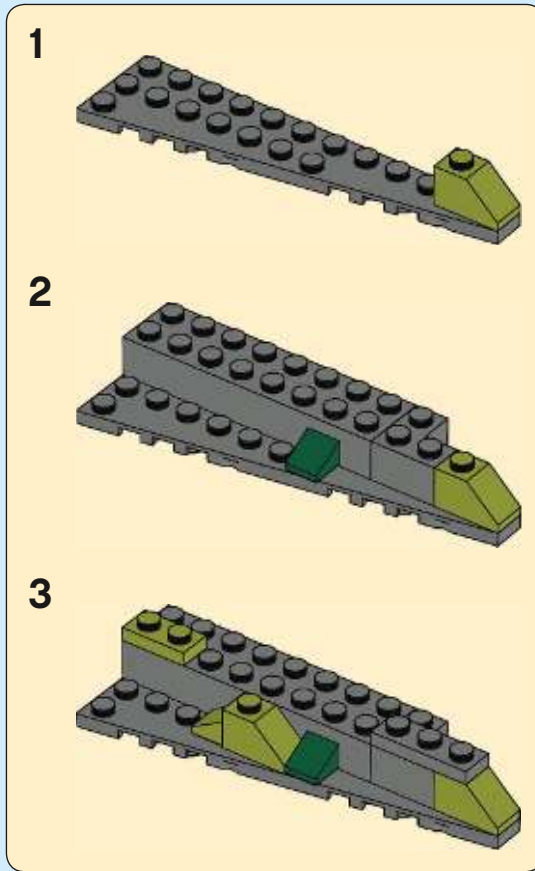

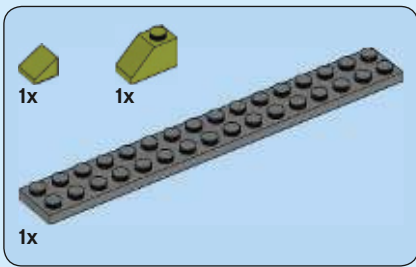

32

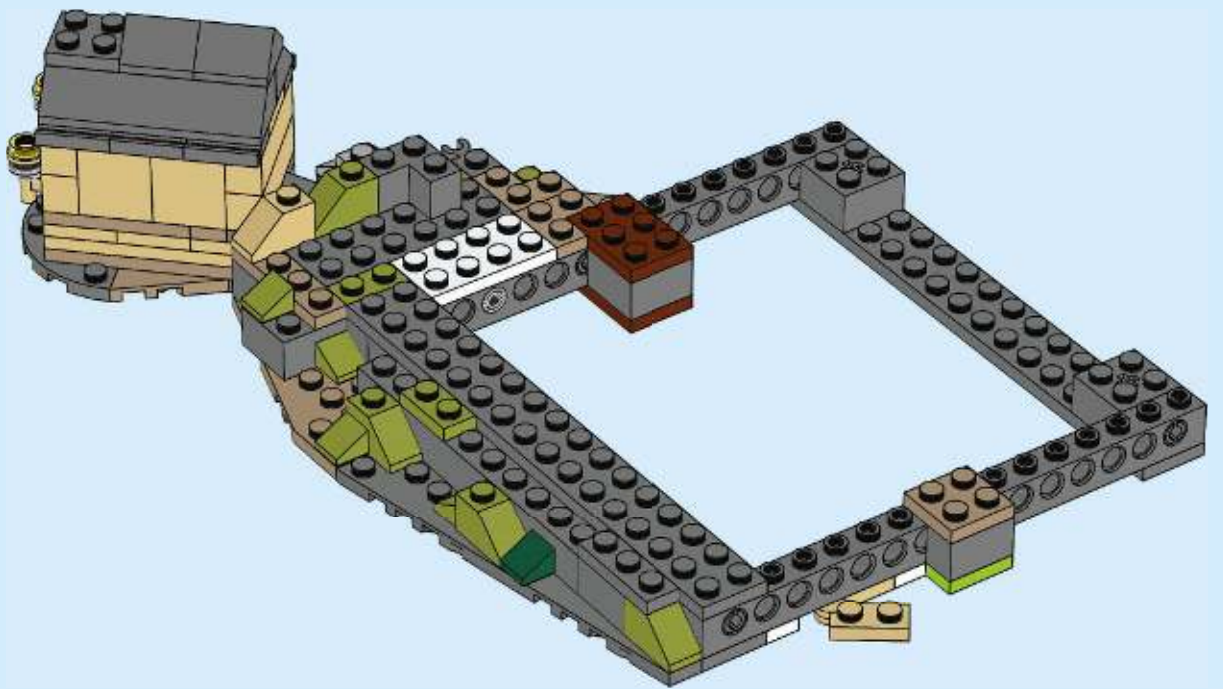

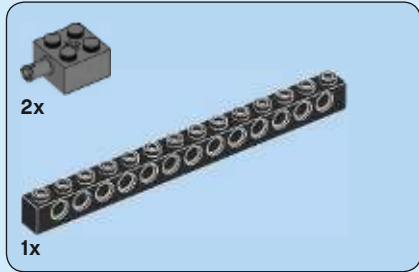

33

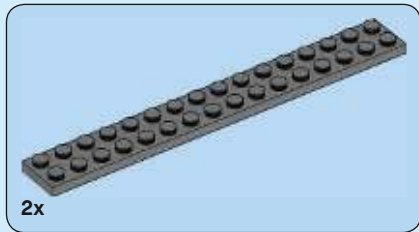
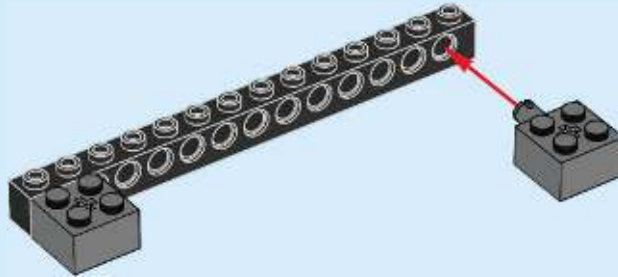

34

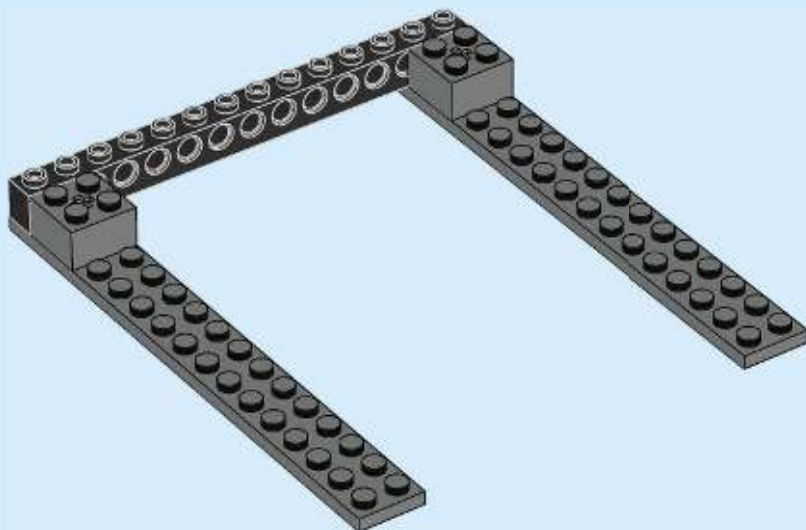

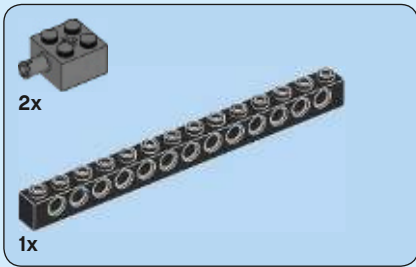

35

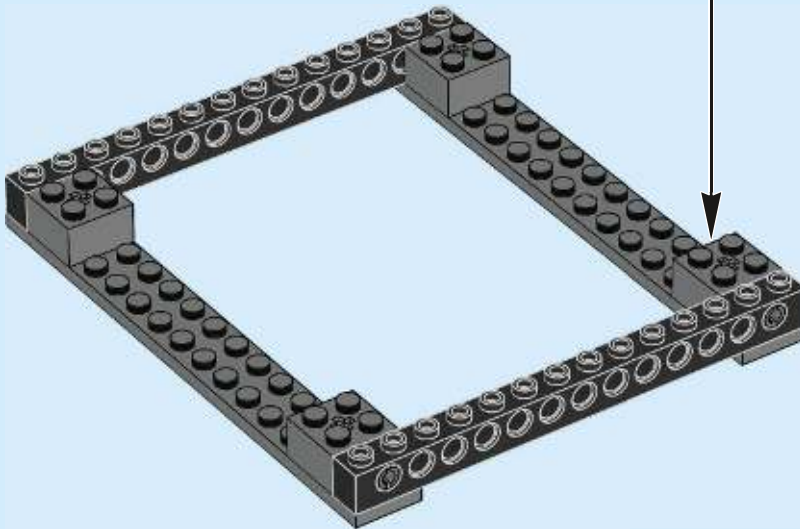
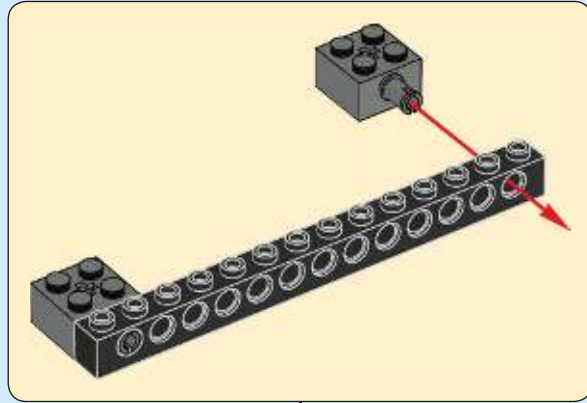

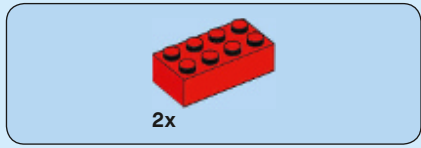

36

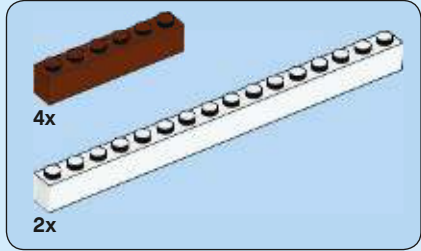
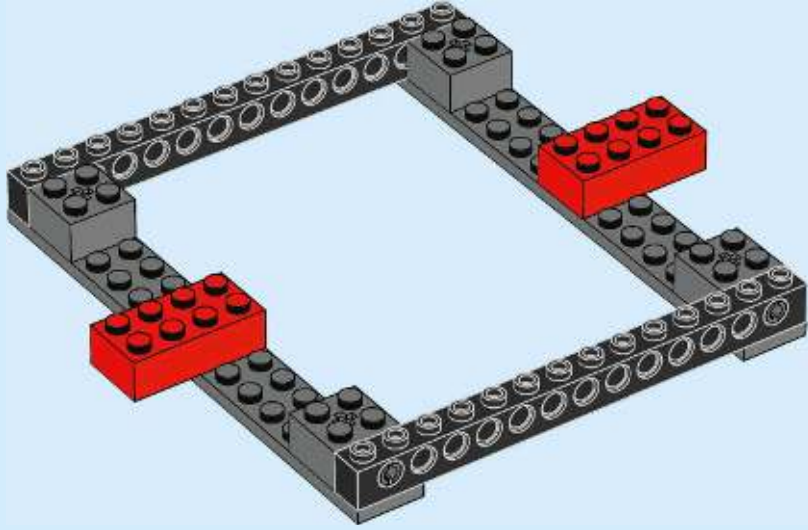

37

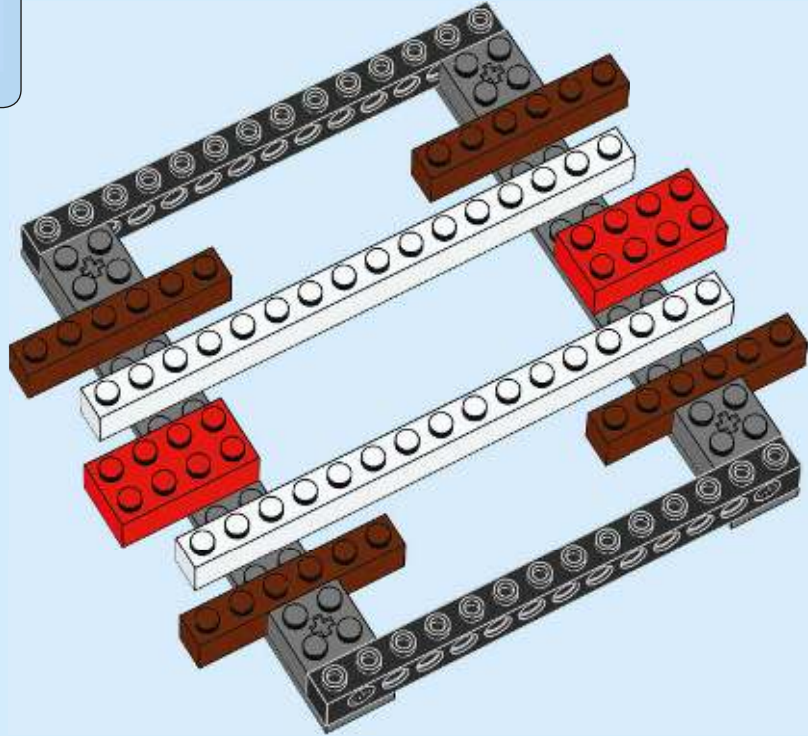

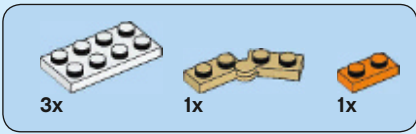

38

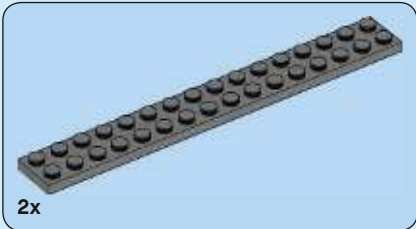
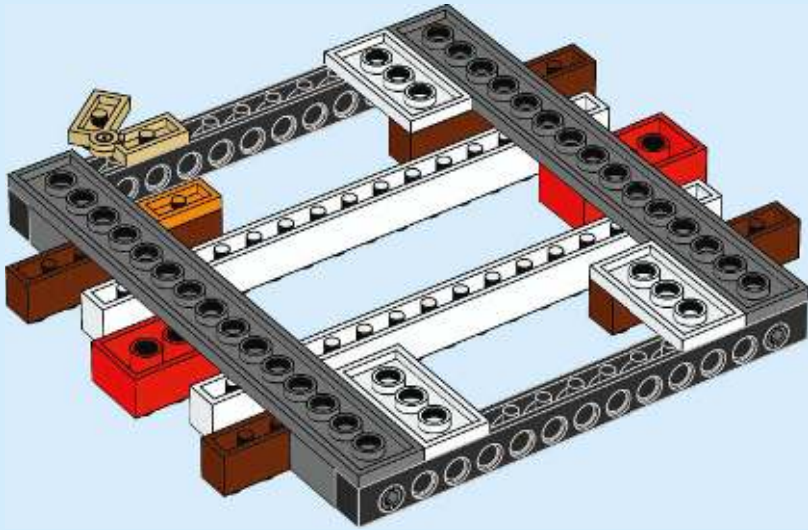
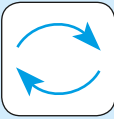

39

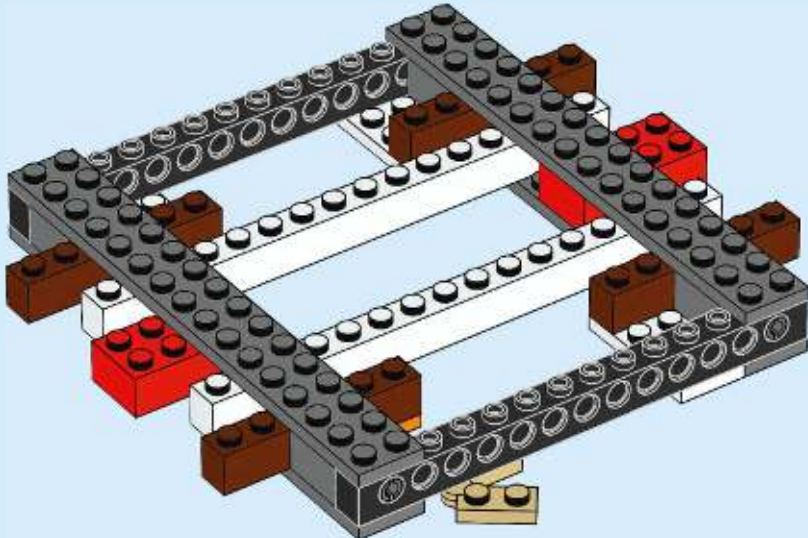
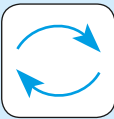



40

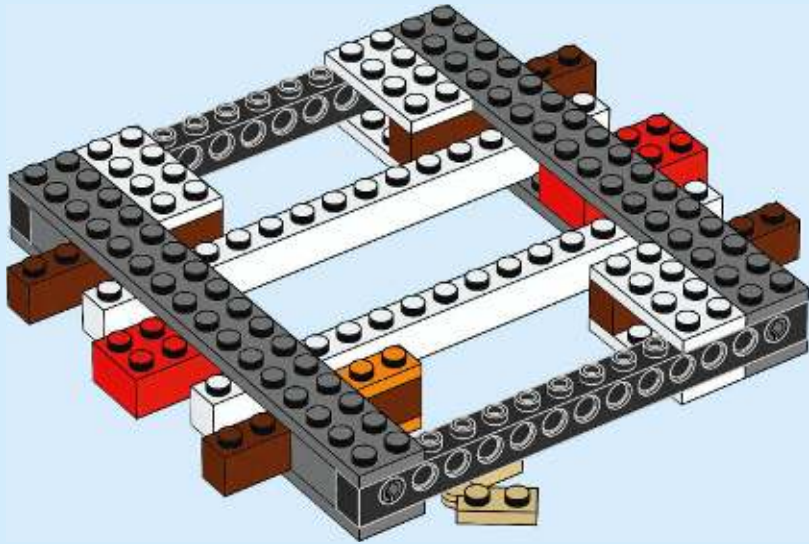

41

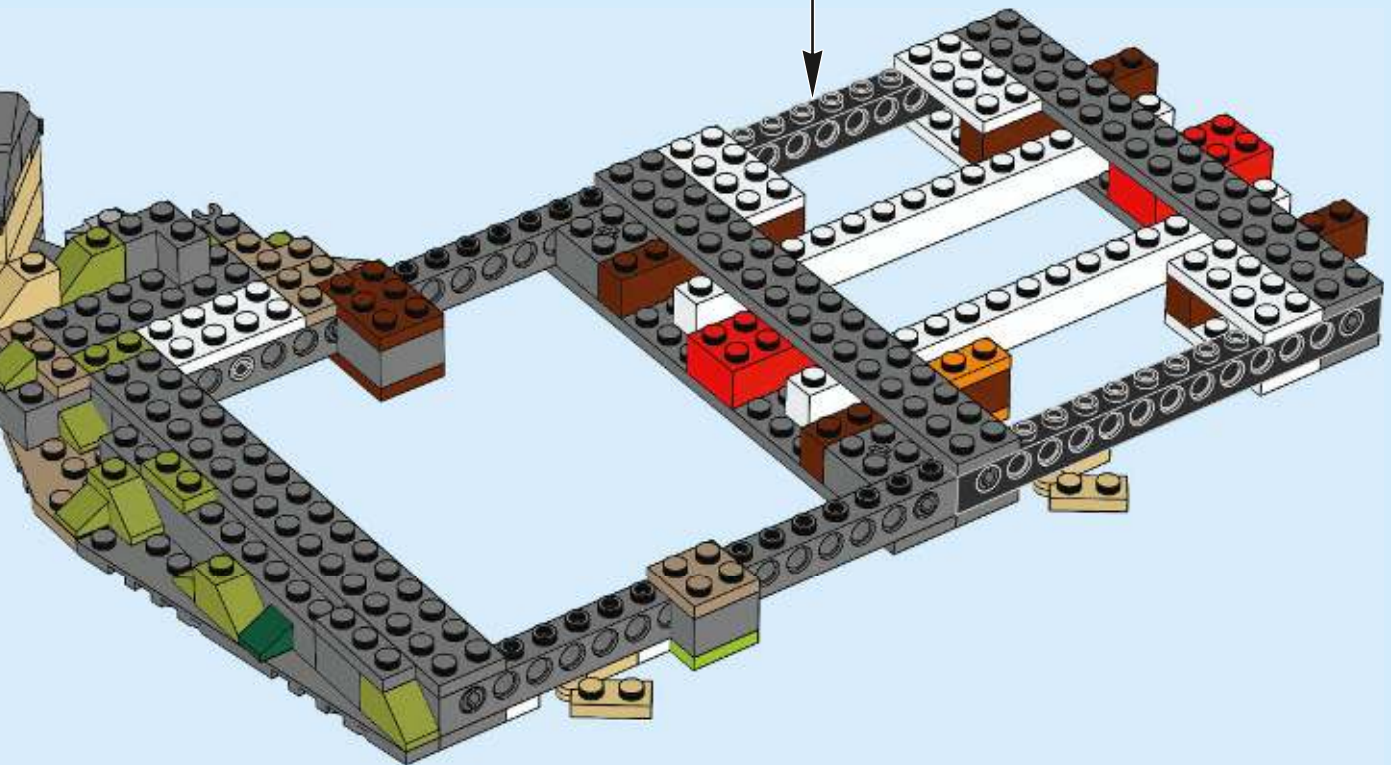

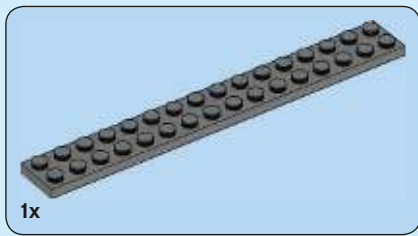

1x

42

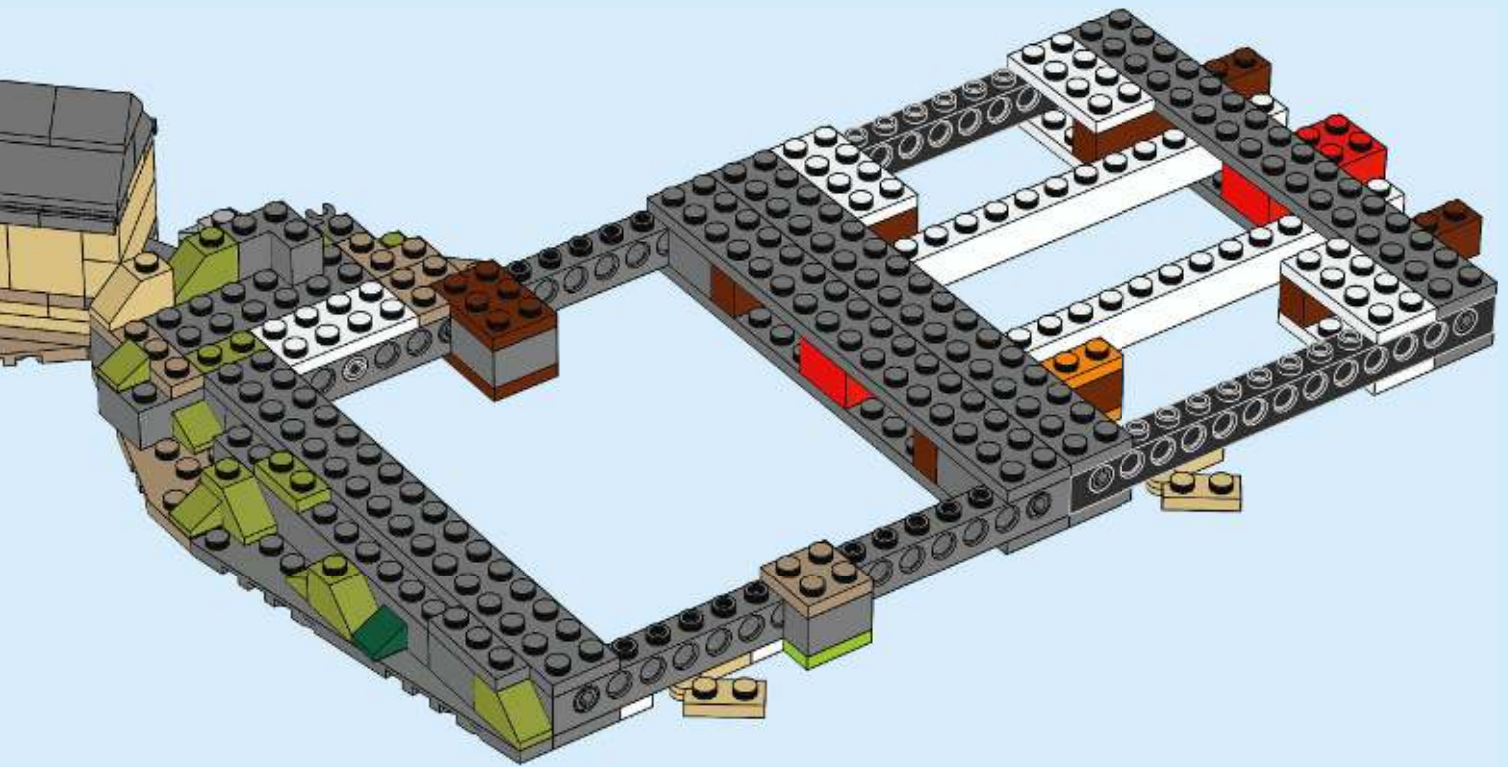

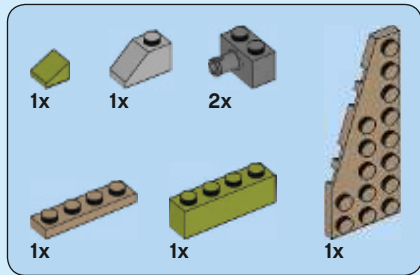

43

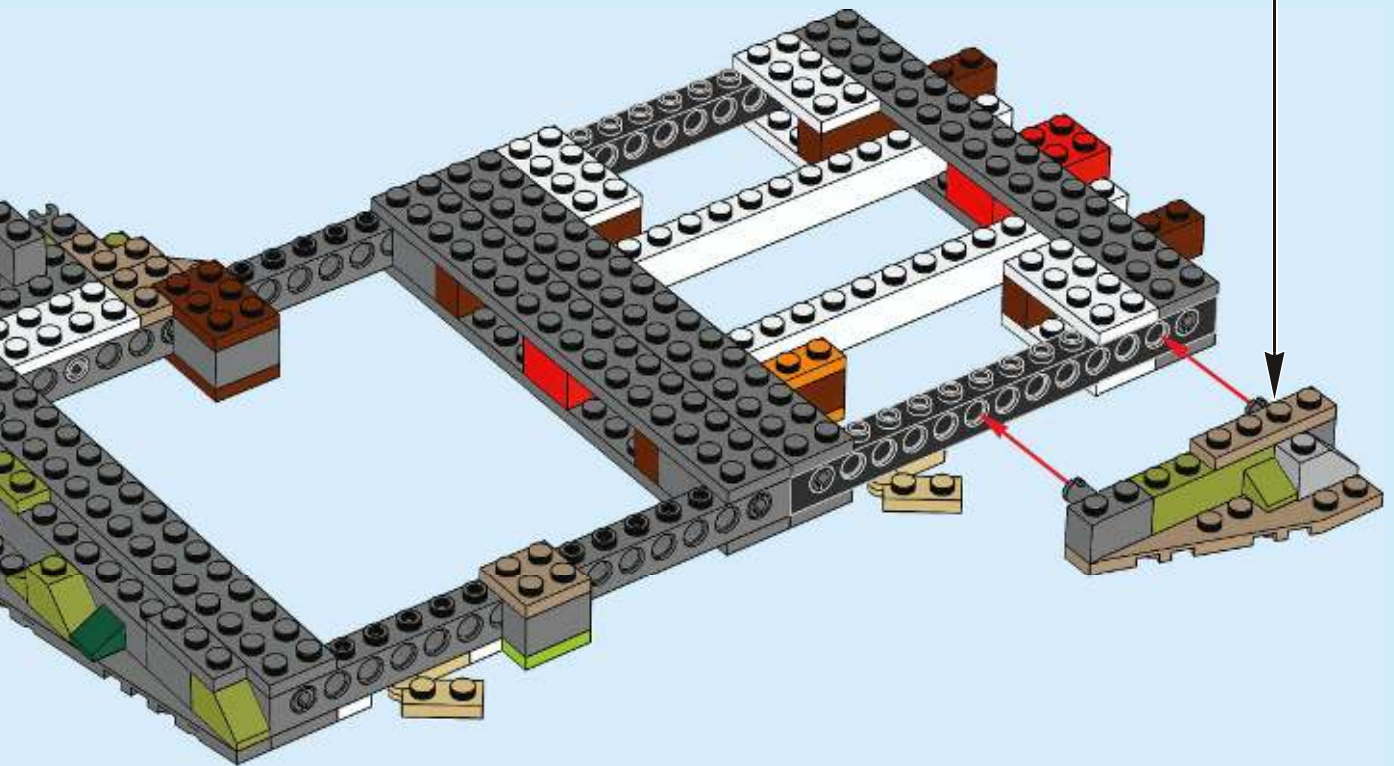
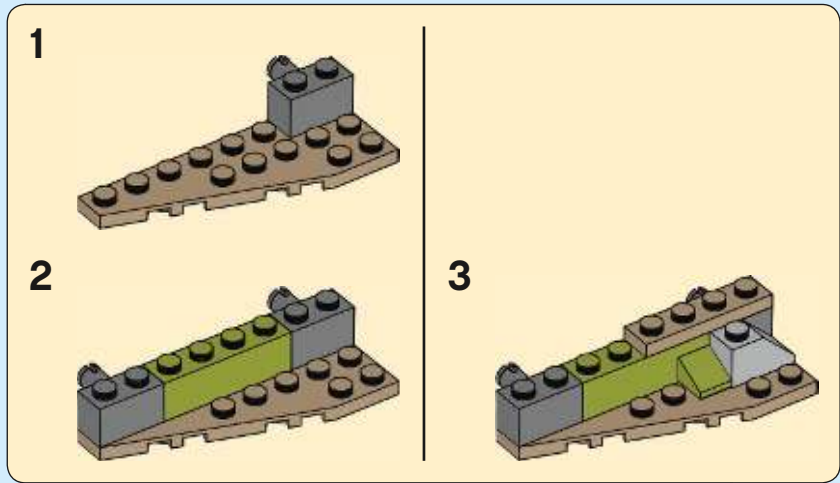

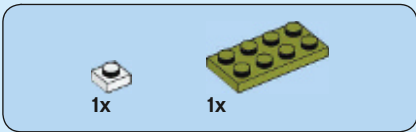

44

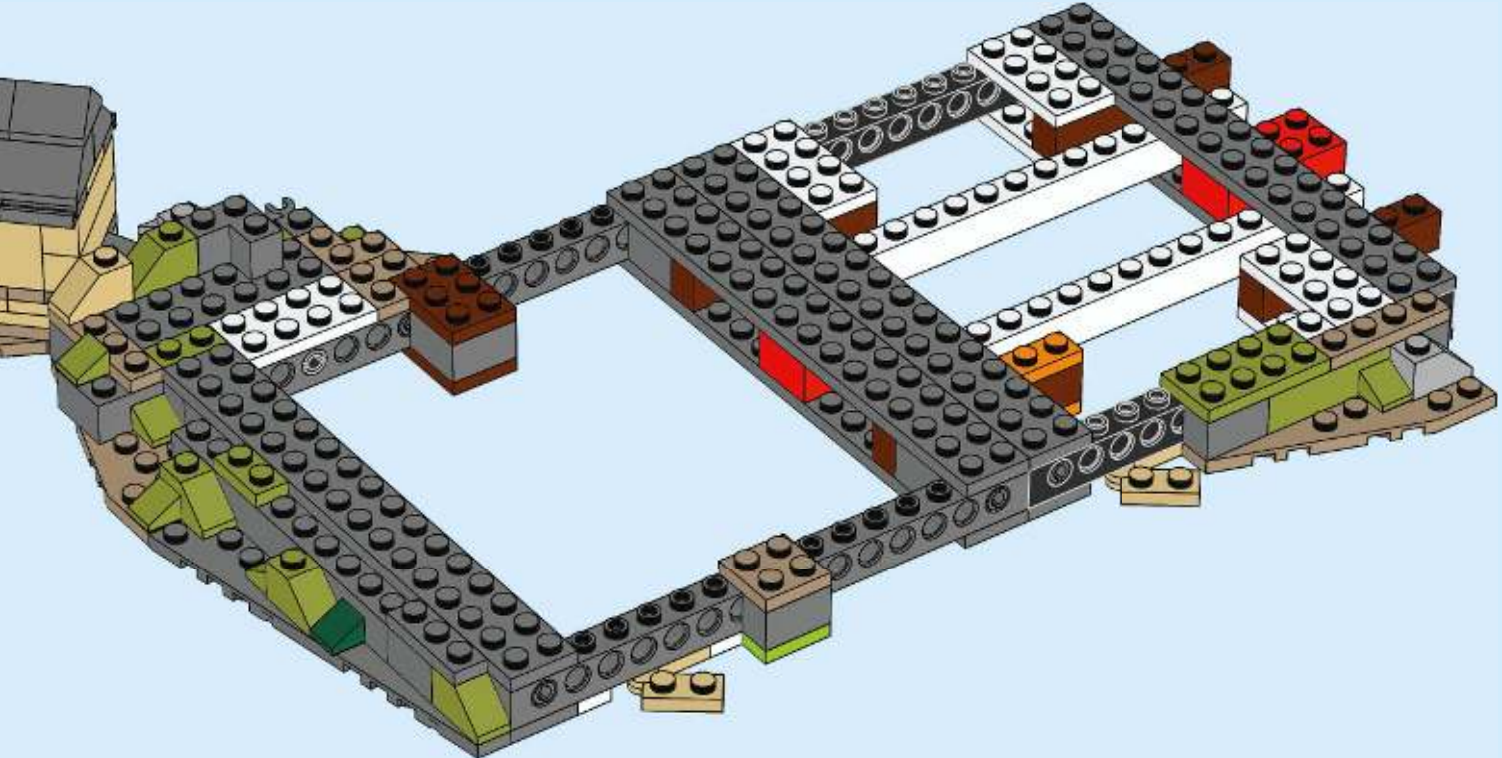

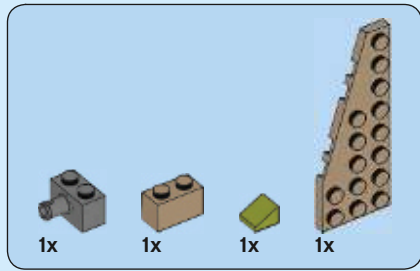

45

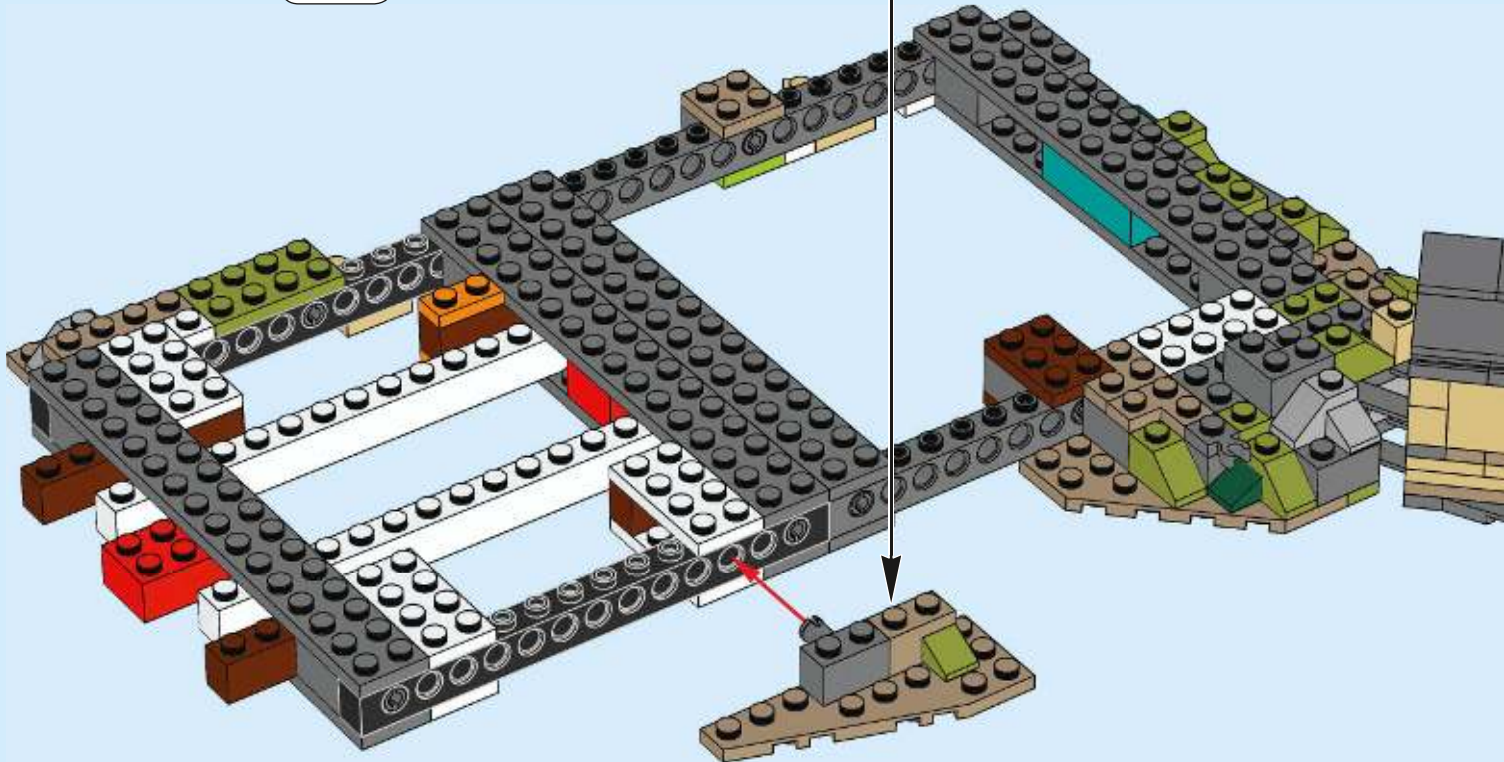
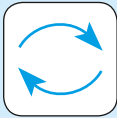
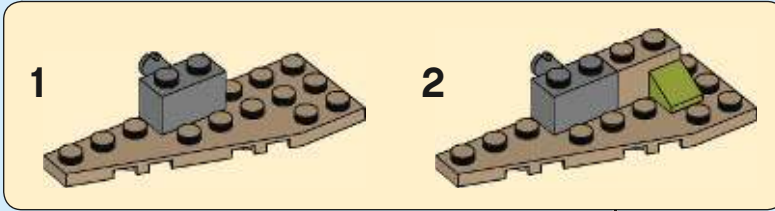

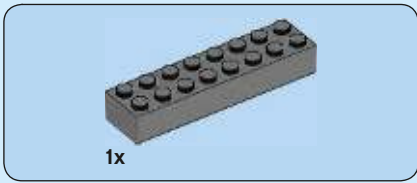

46

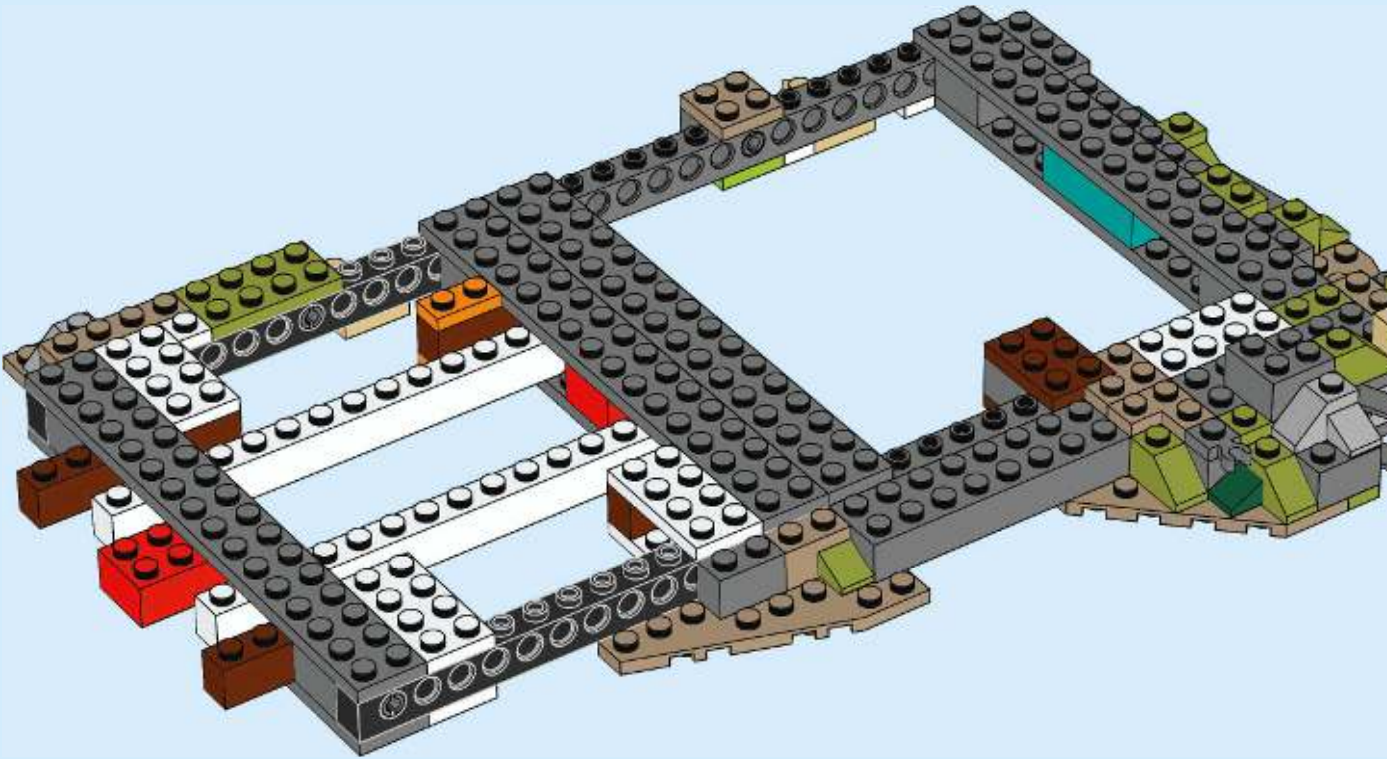



47

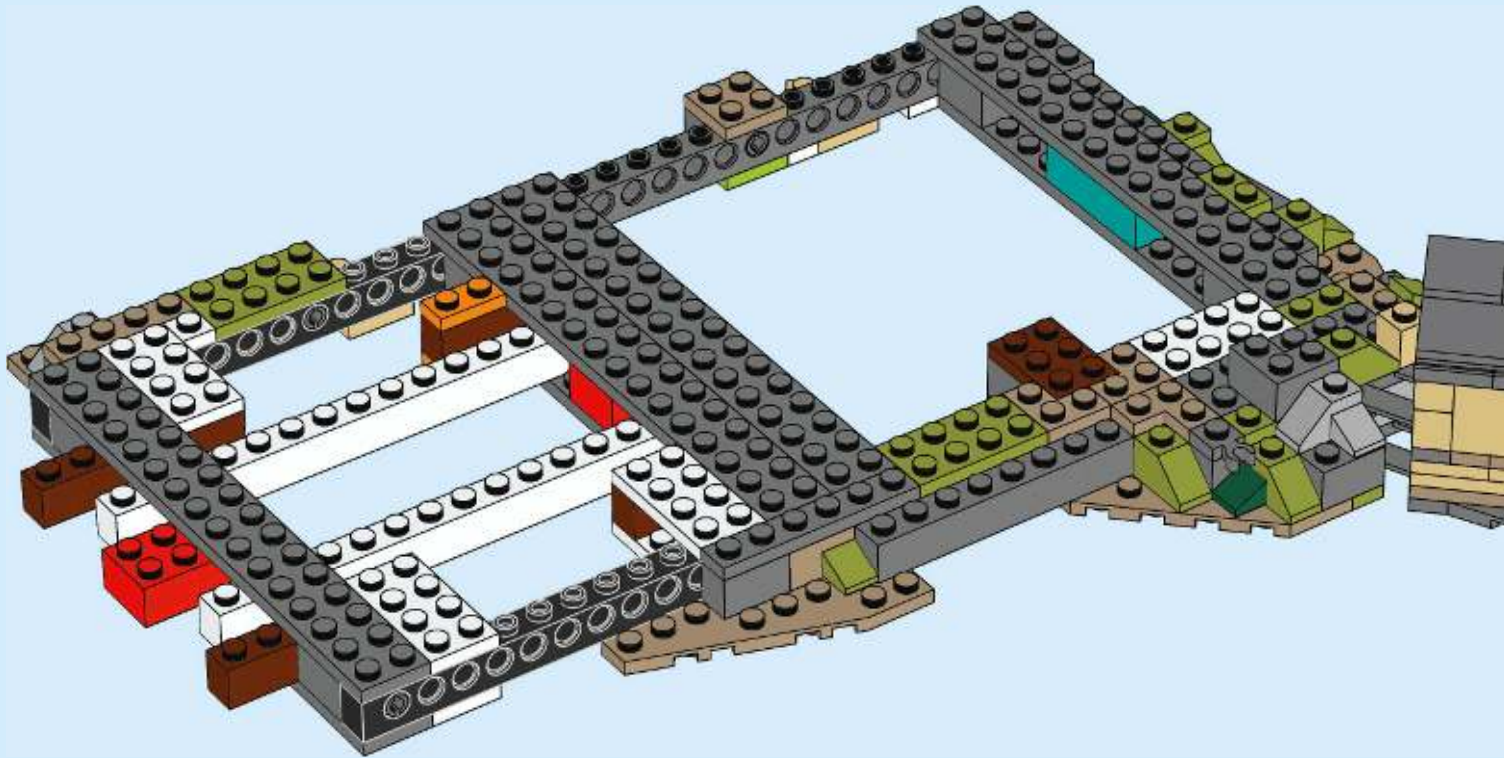

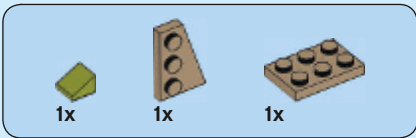

48

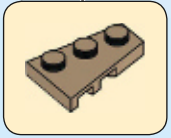
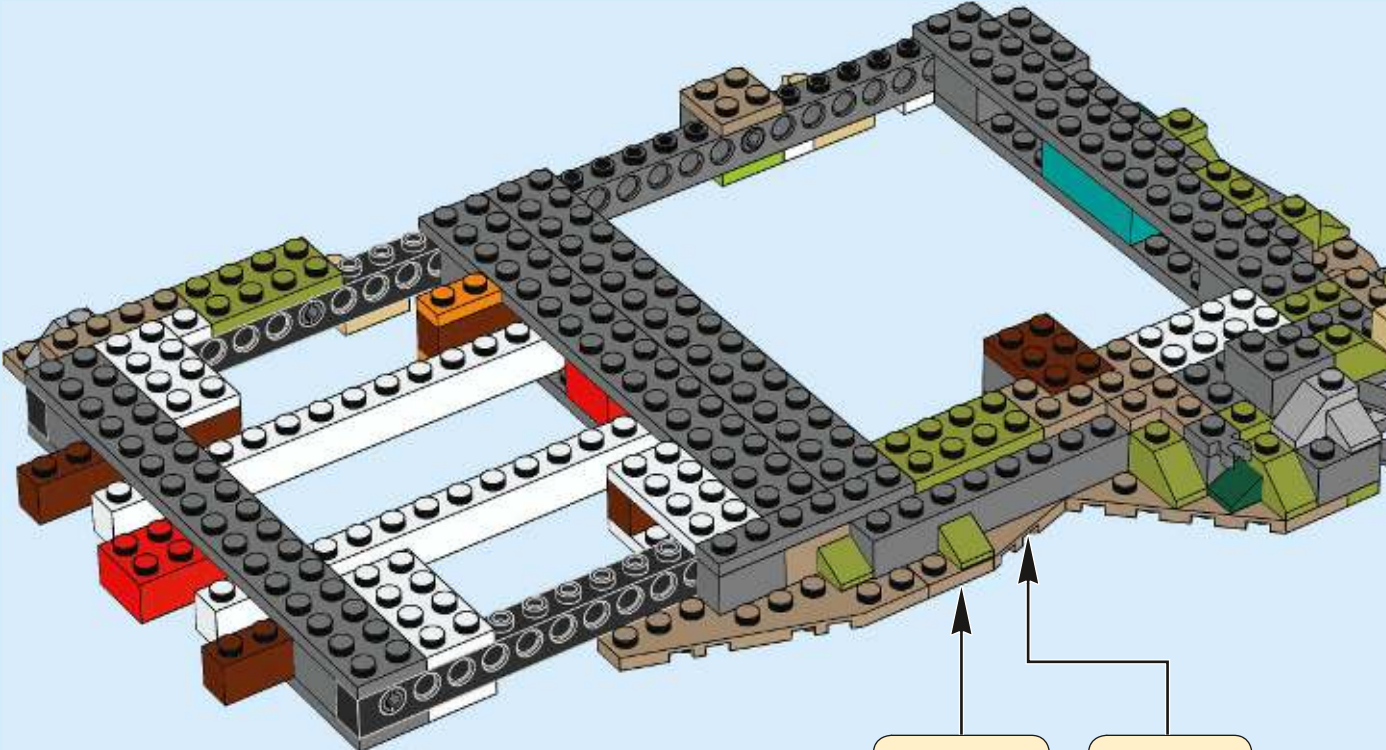

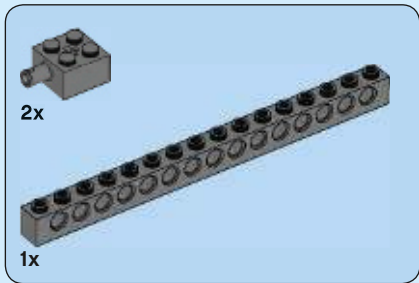
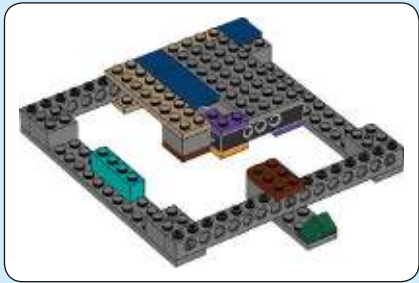
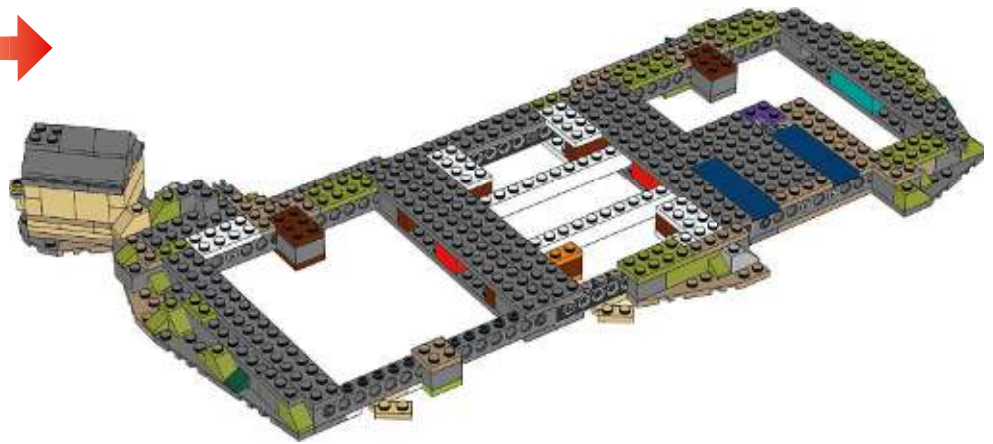

49



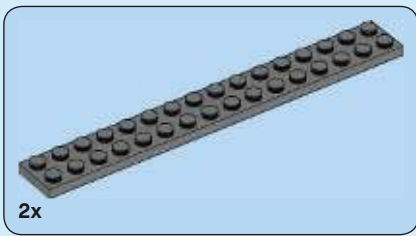

50

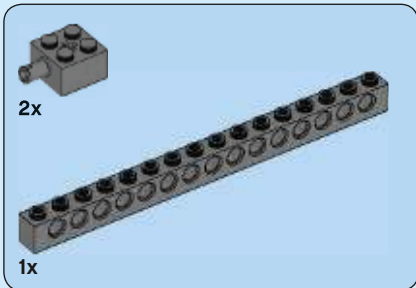
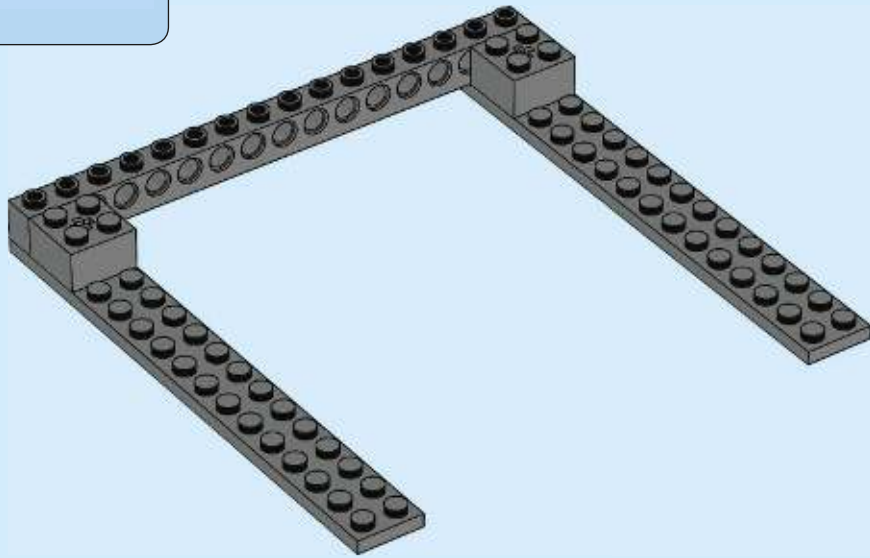

51

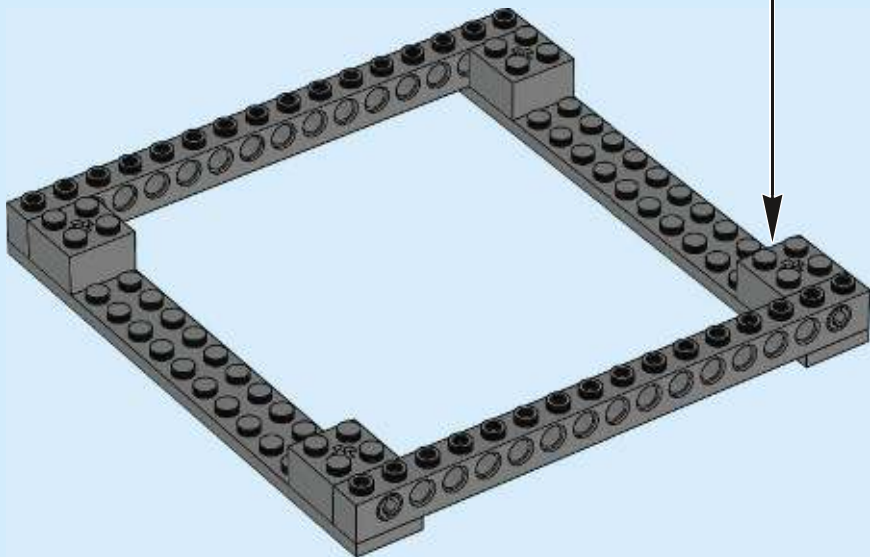
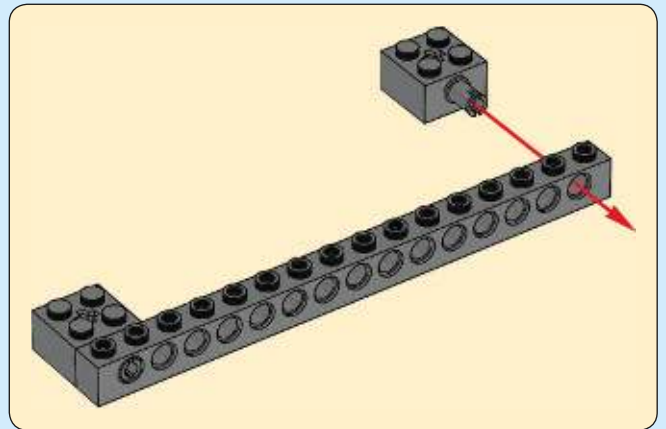

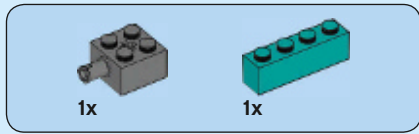

52

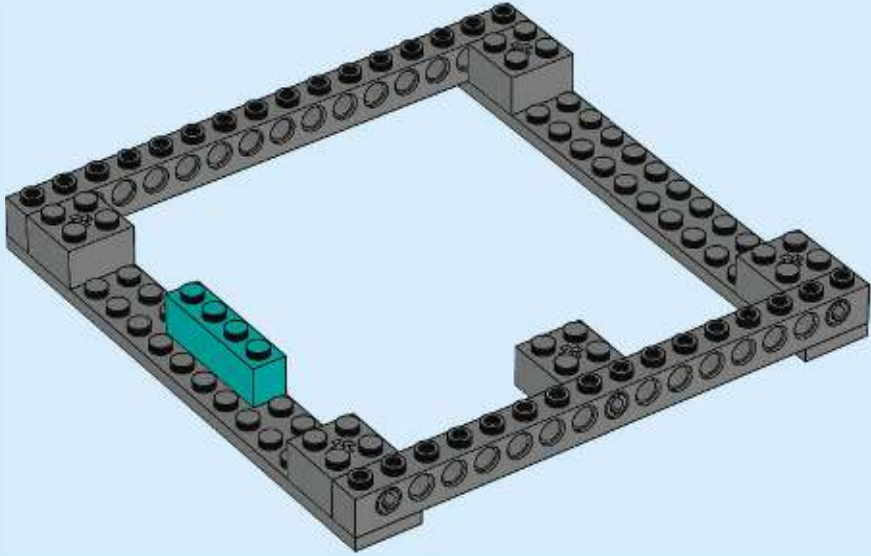

53

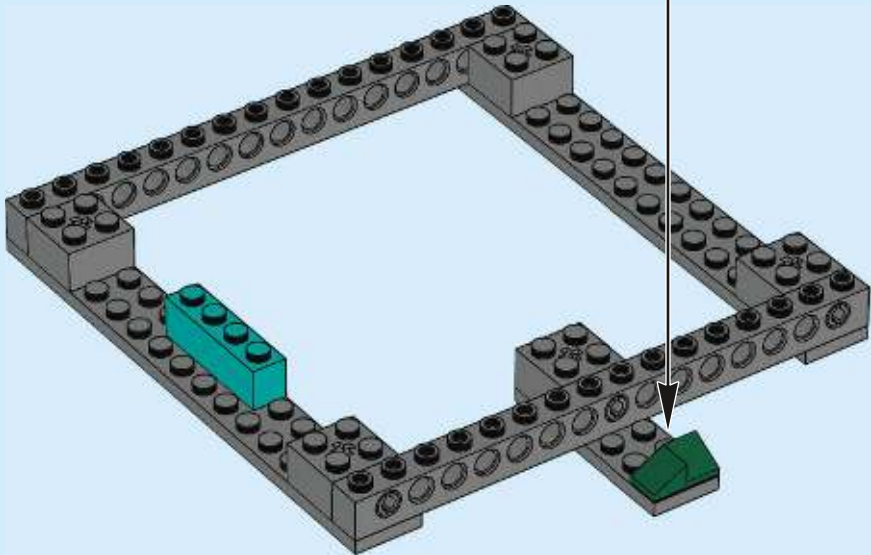
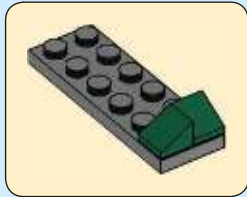

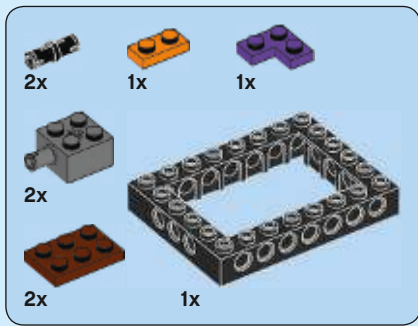

54

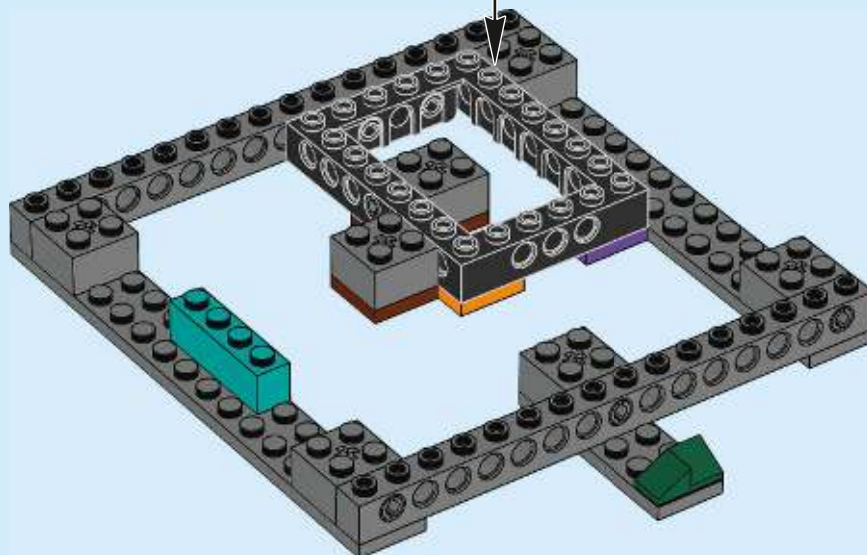
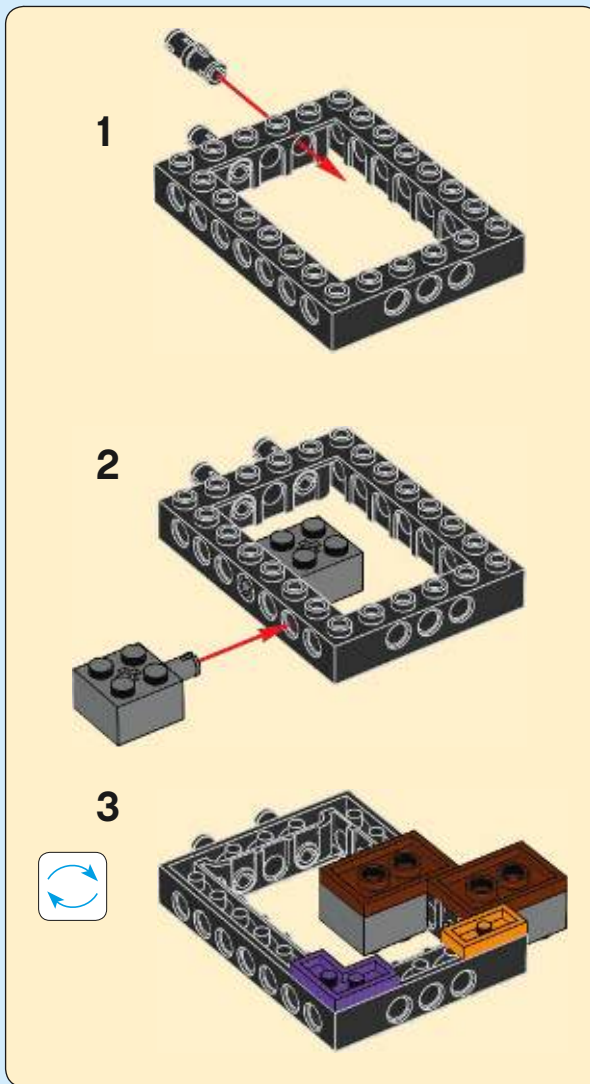



55

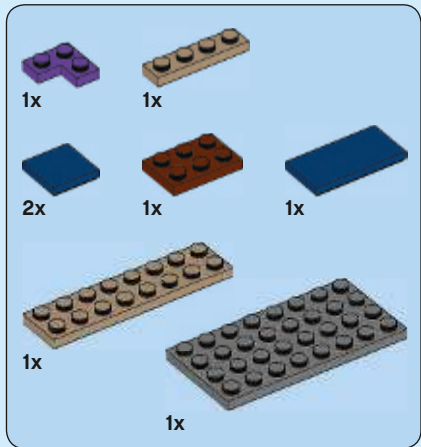
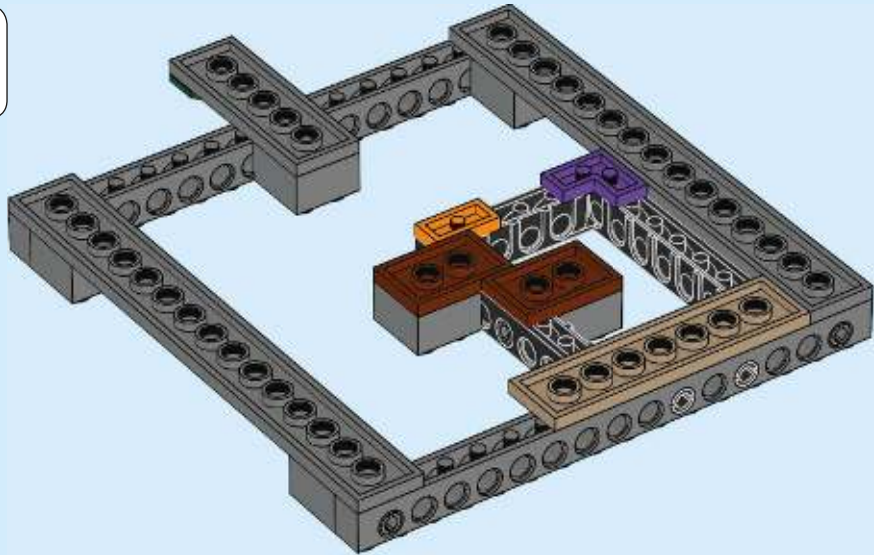
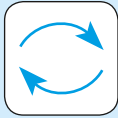

56

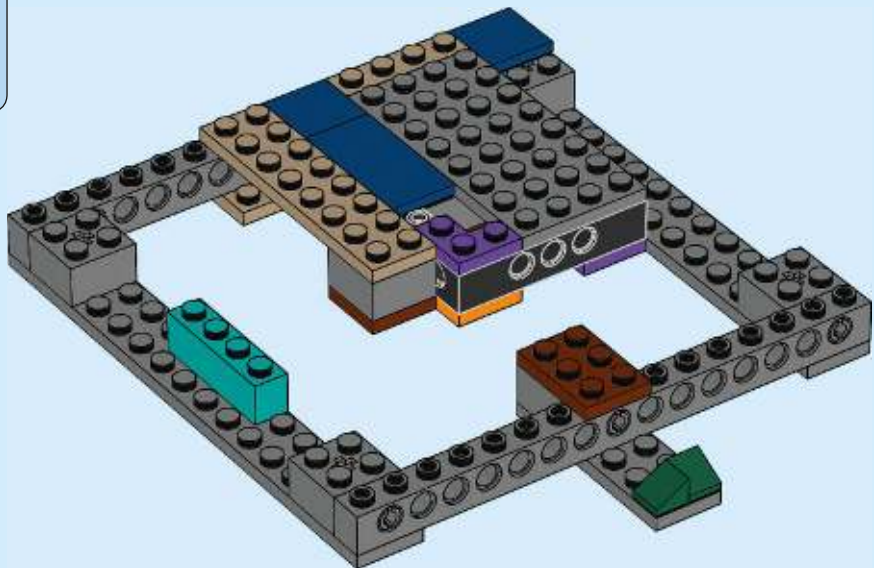
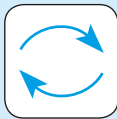

57

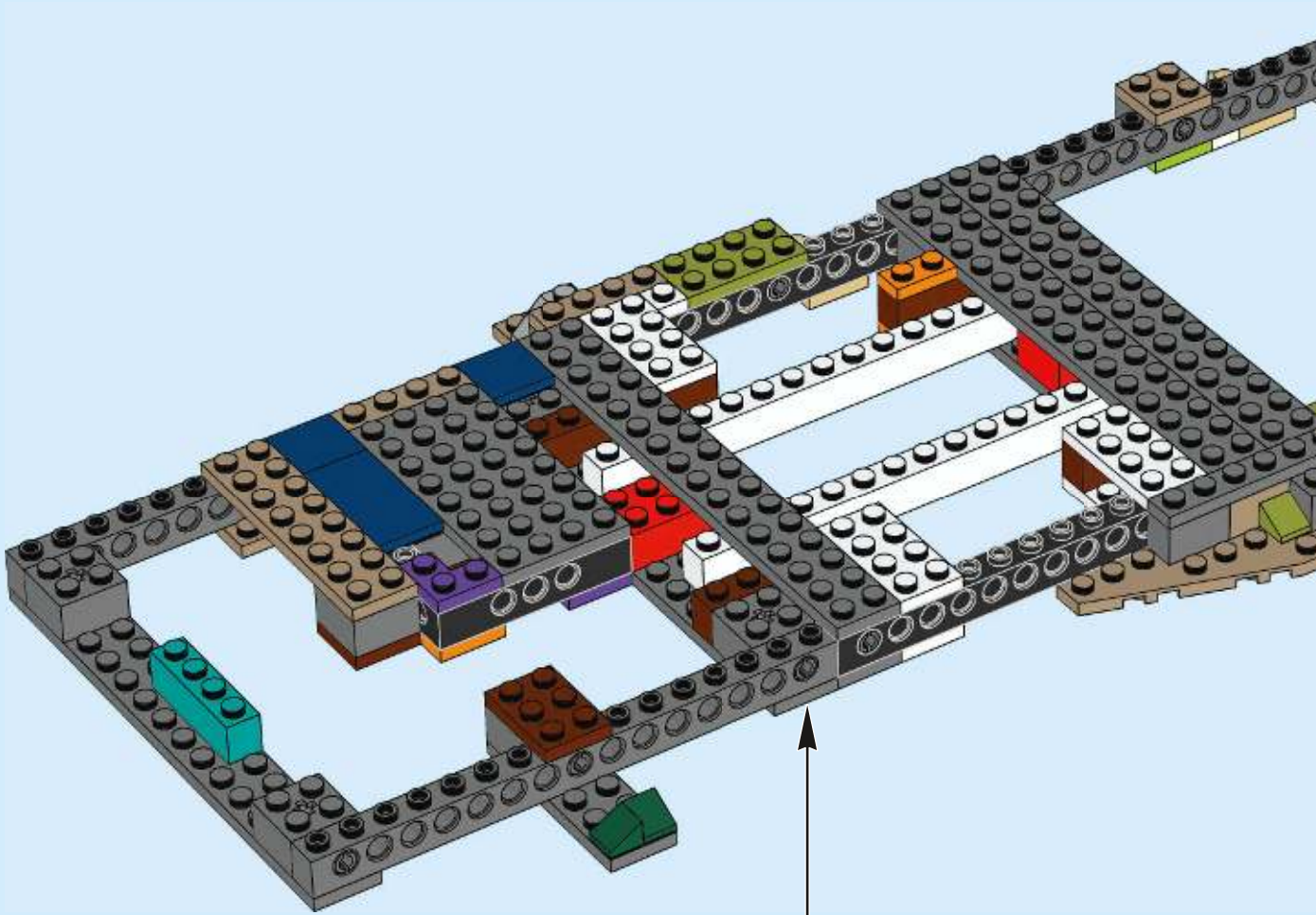

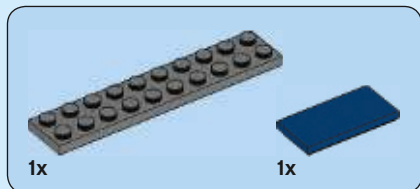

58

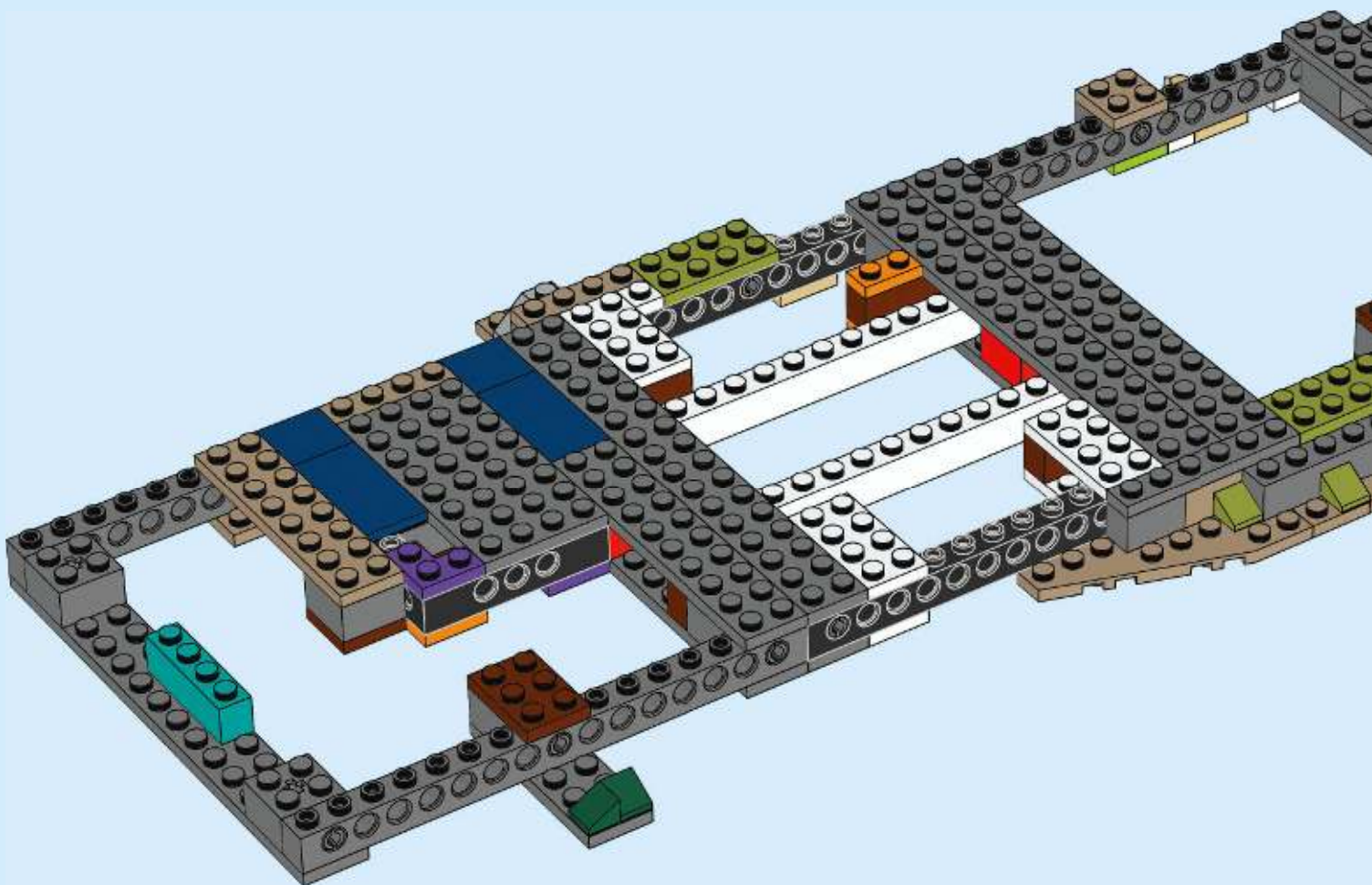

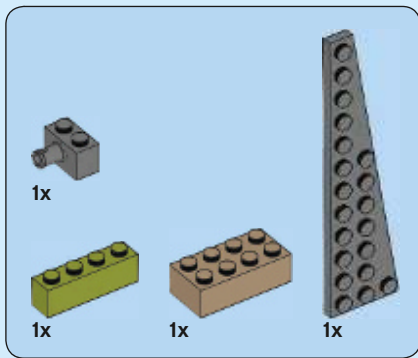

59

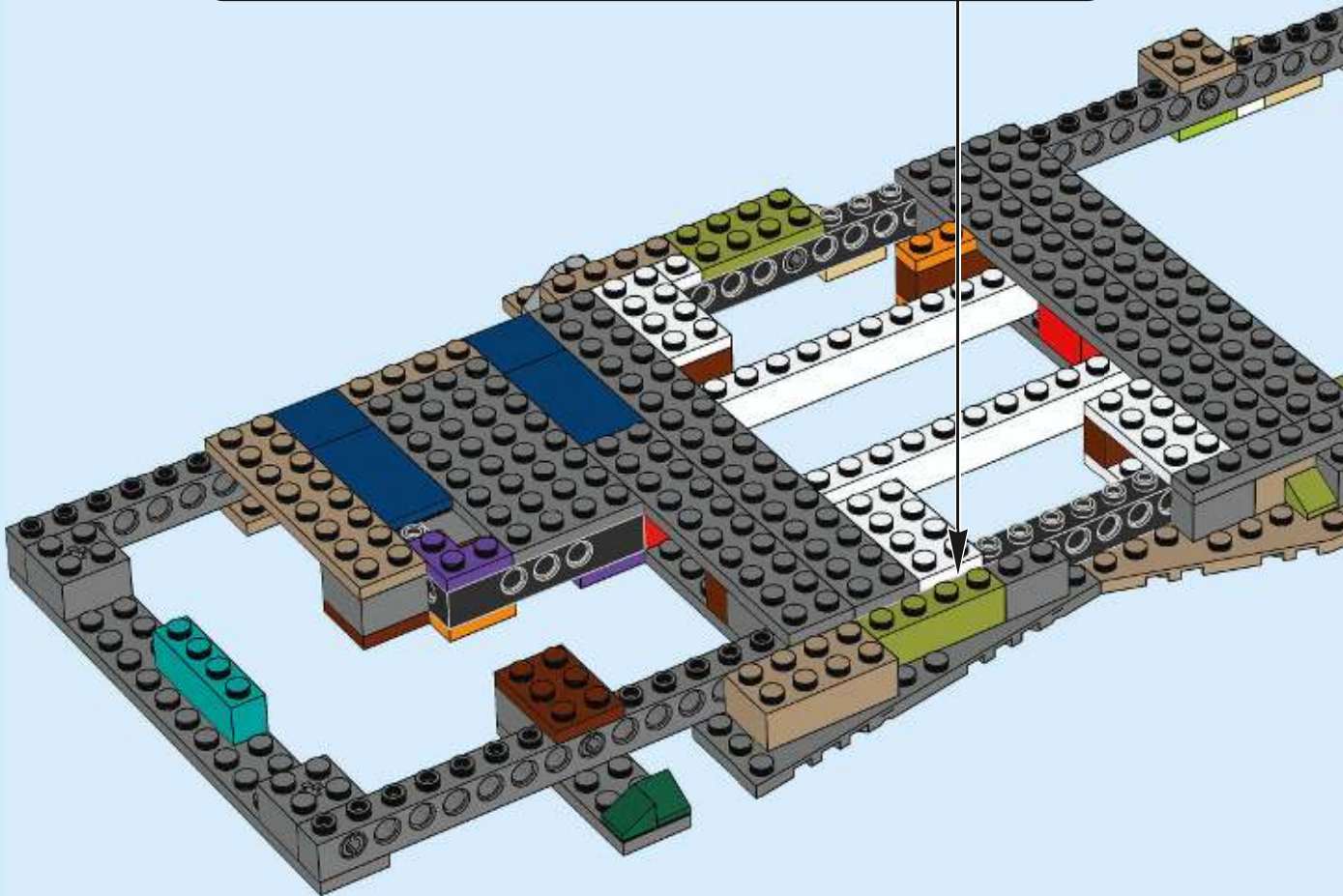
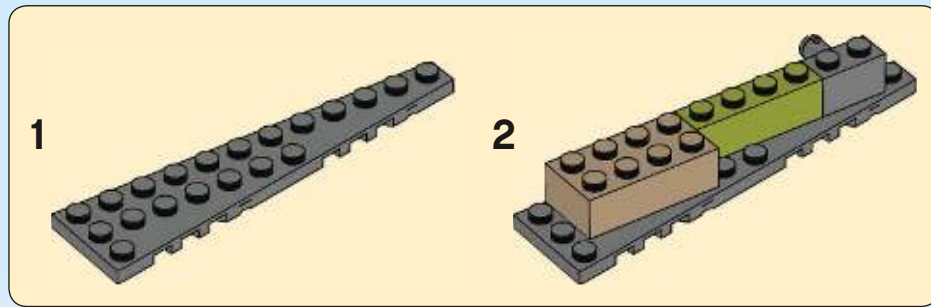

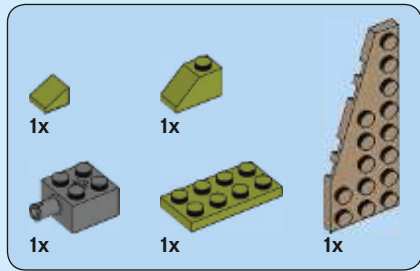

60

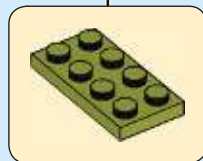
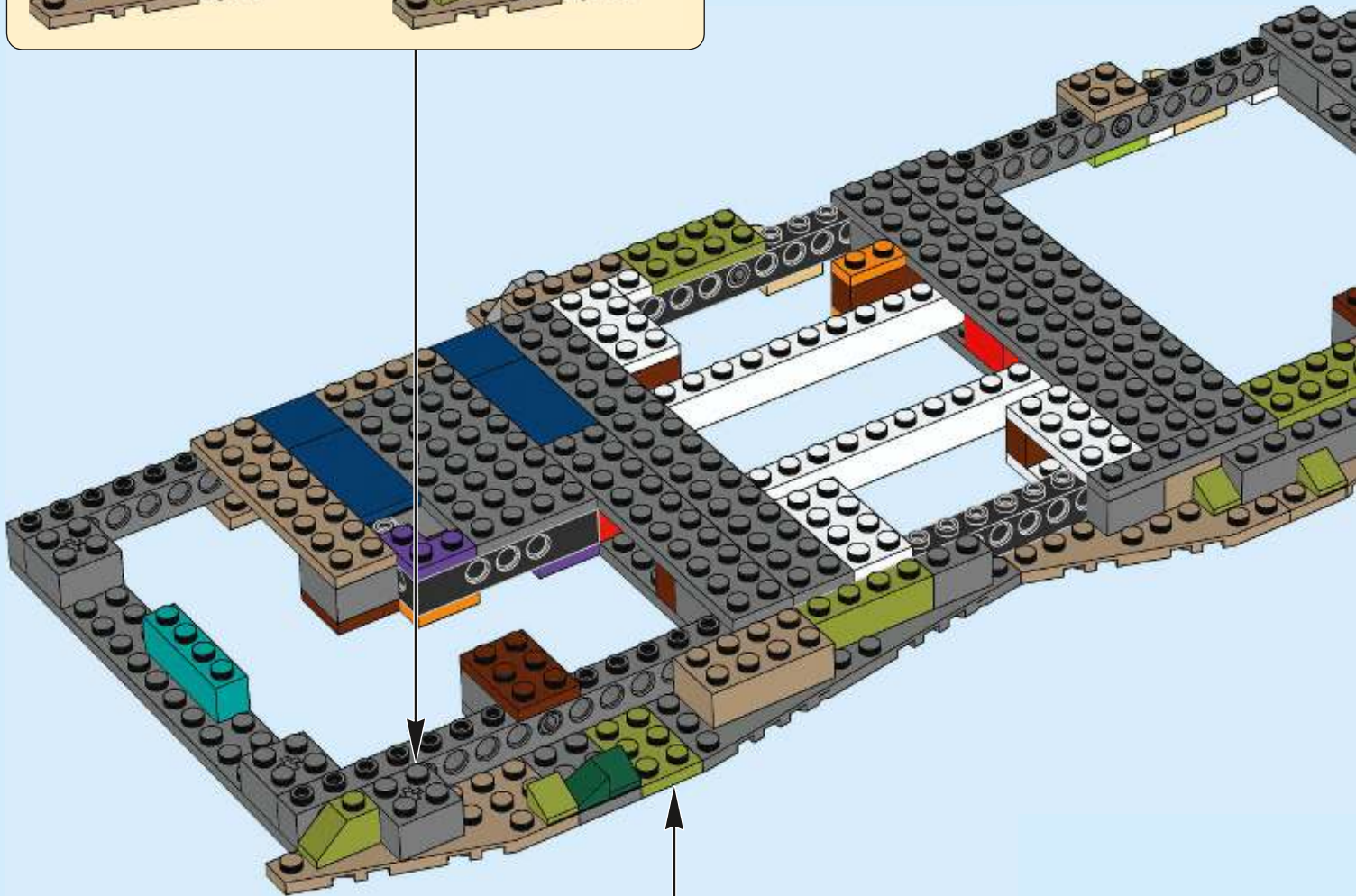
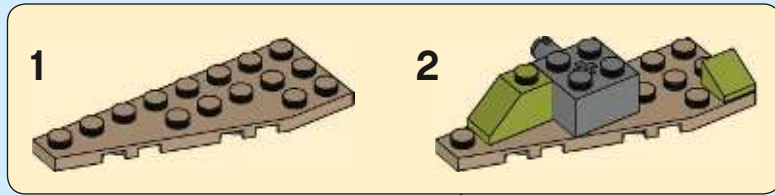

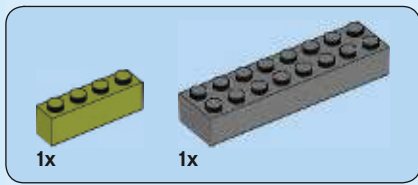

61

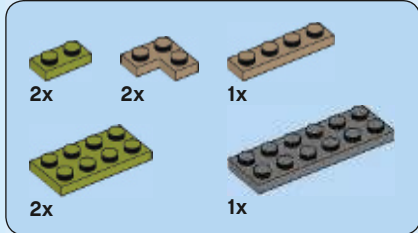
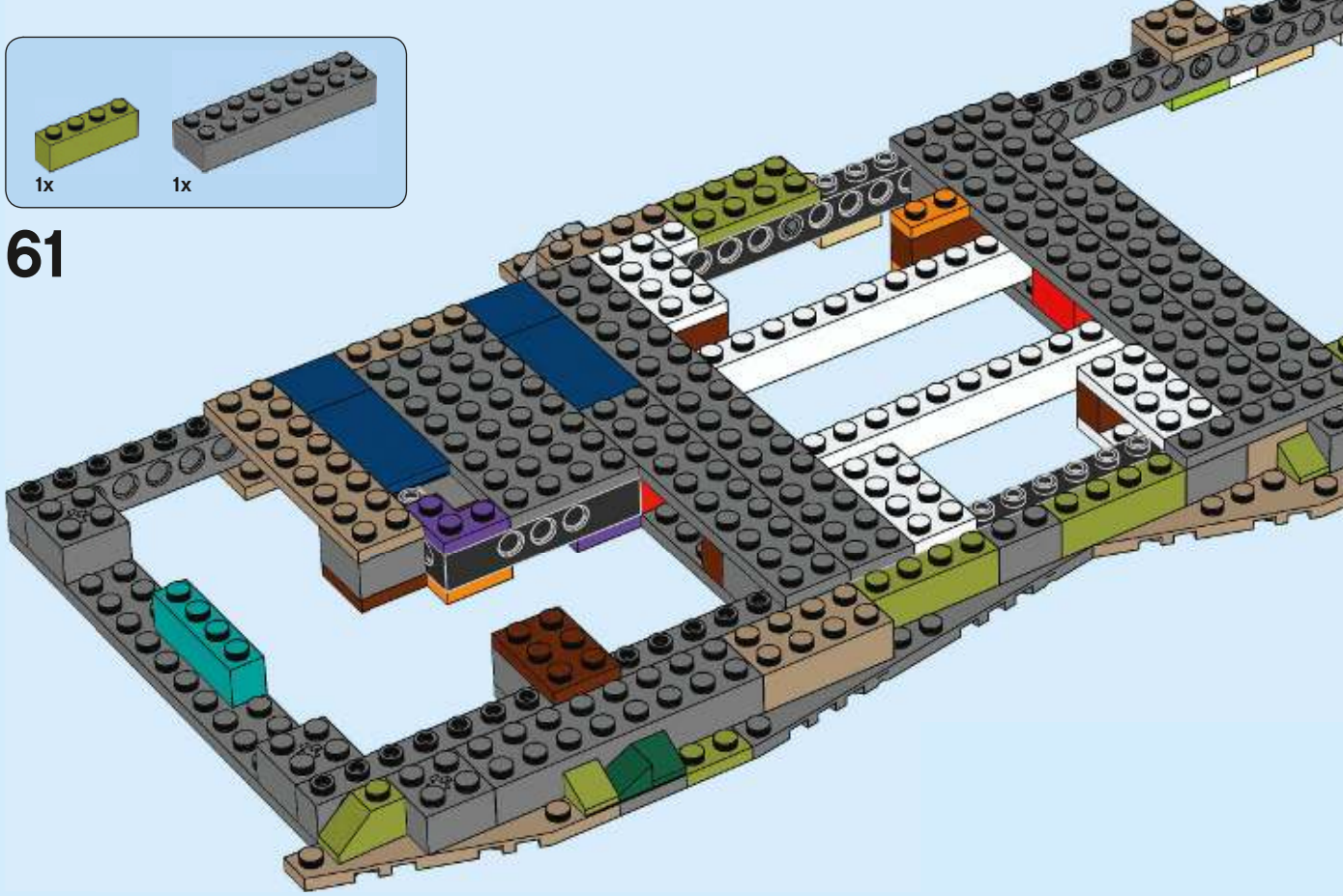

62

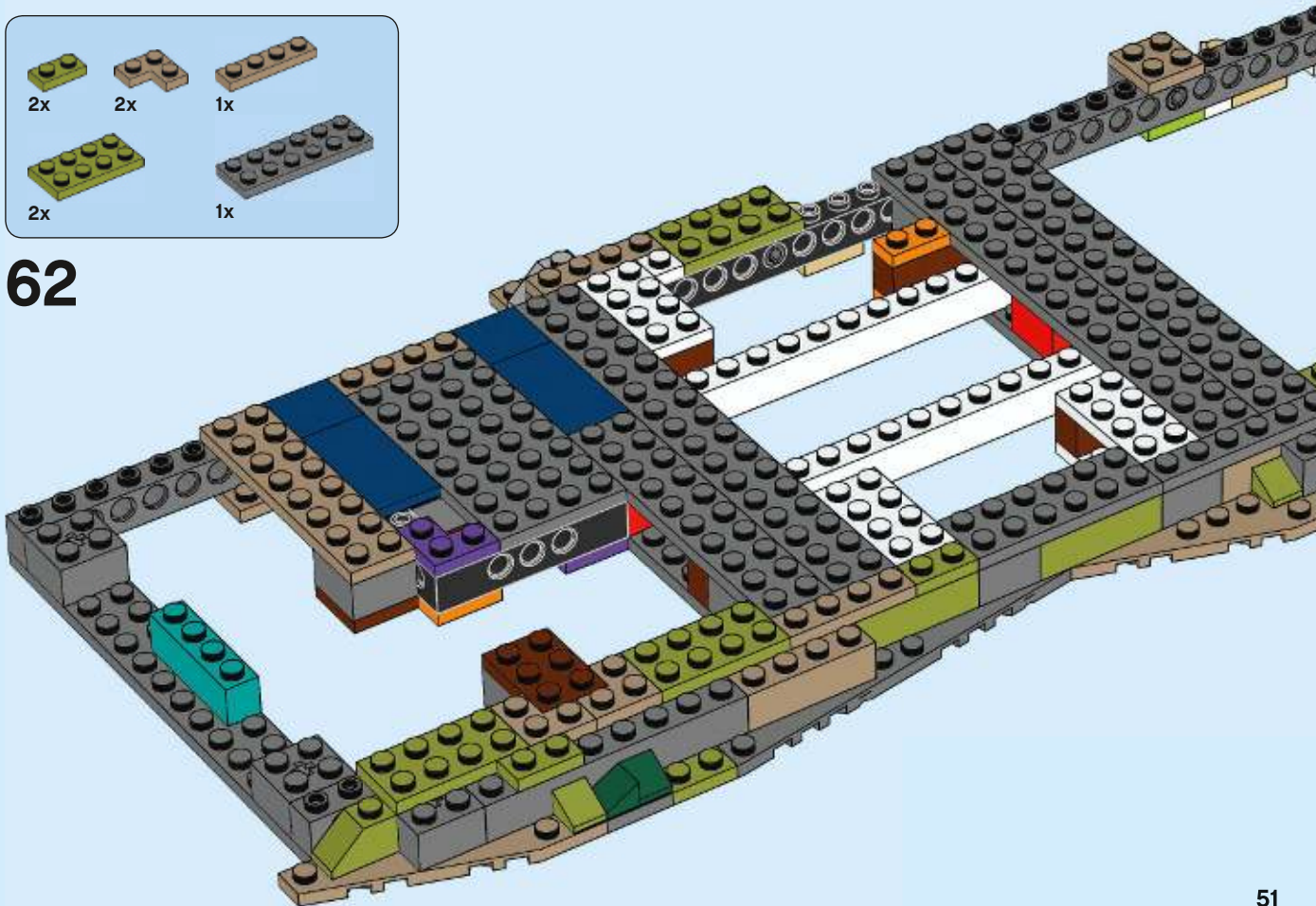

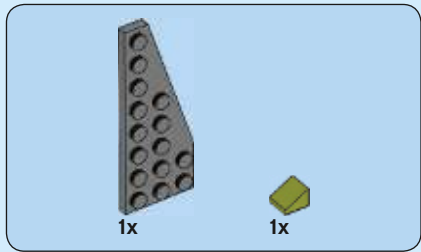

63

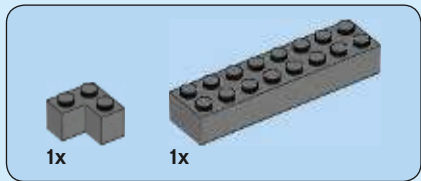

64

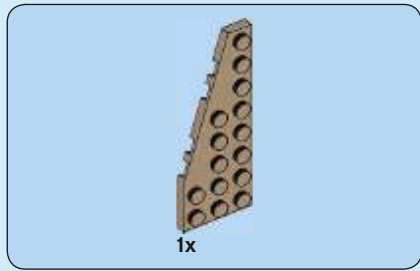
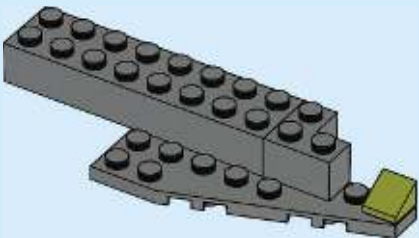

65

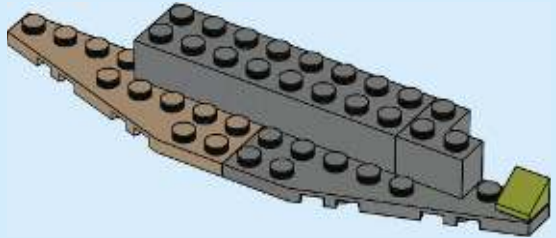

66

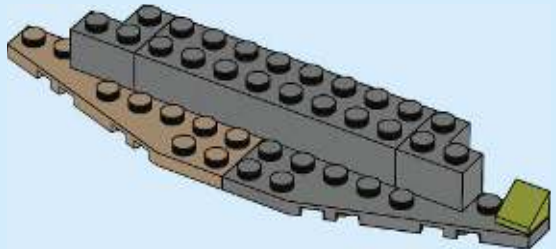

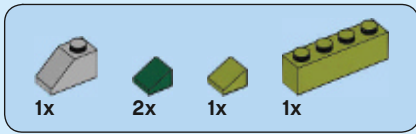

67

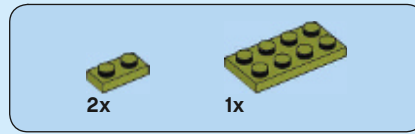
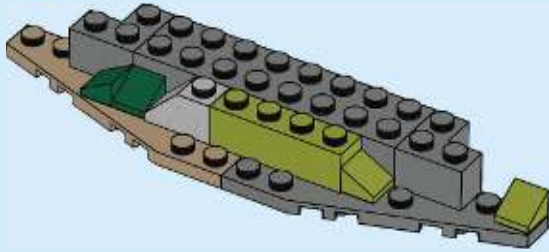

68

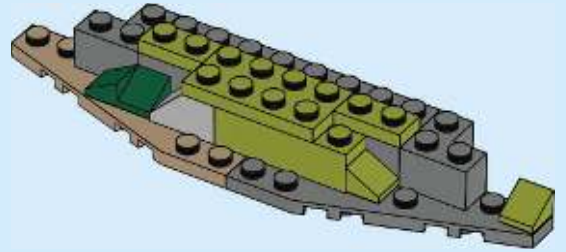

69

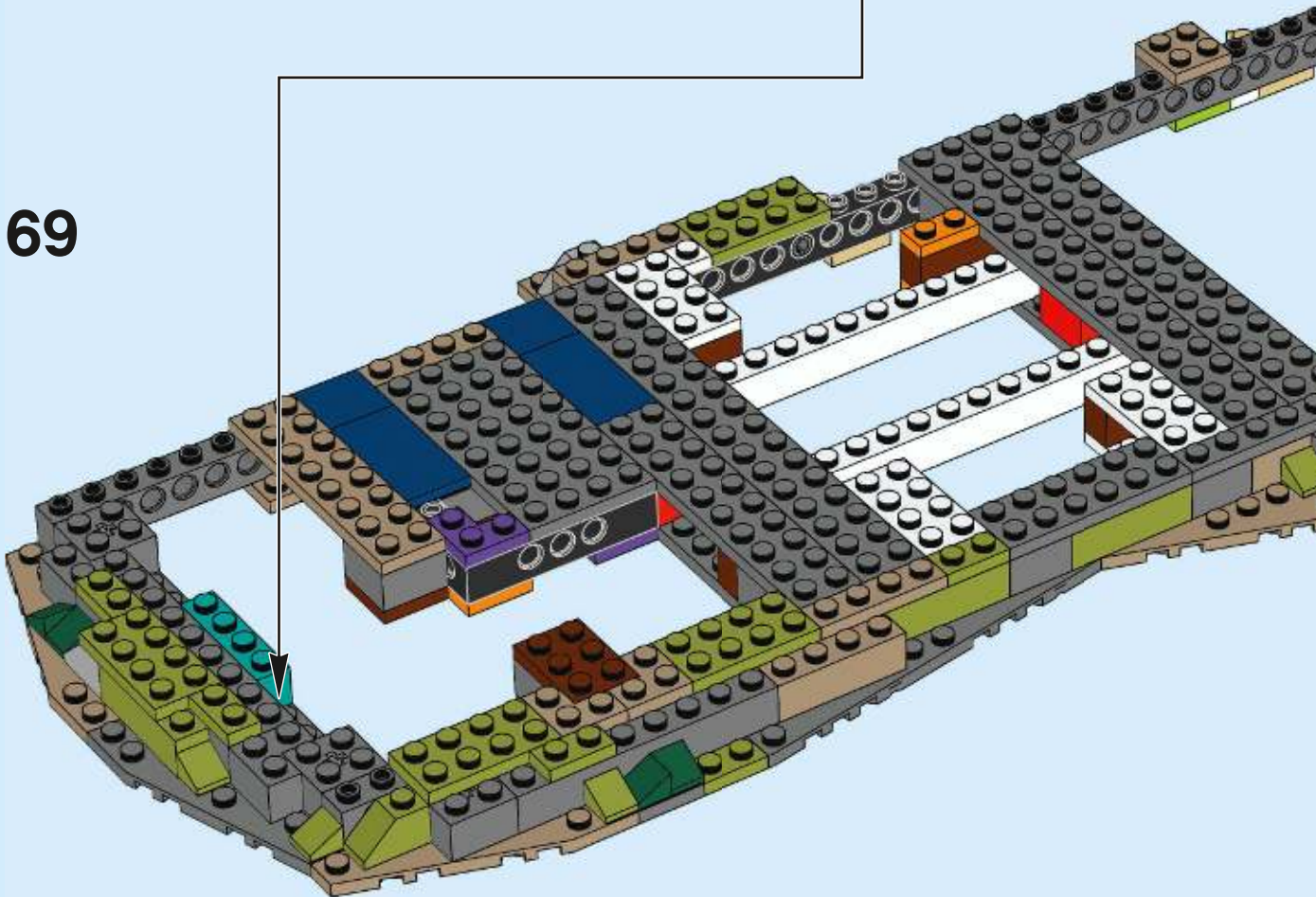

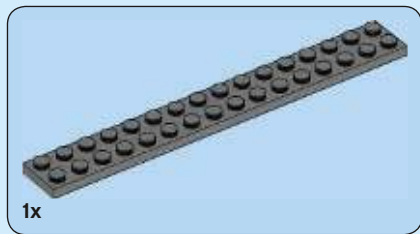

70

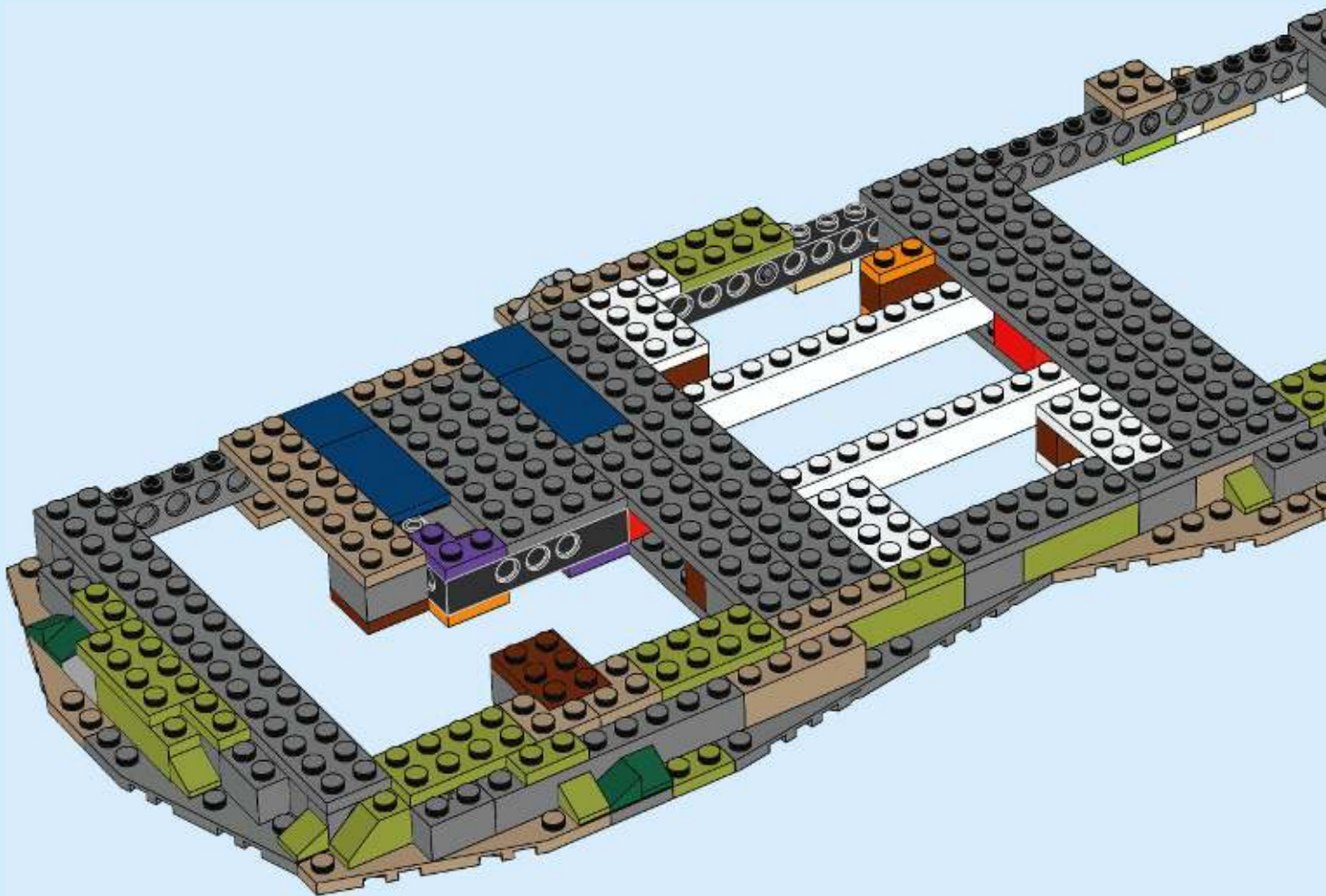

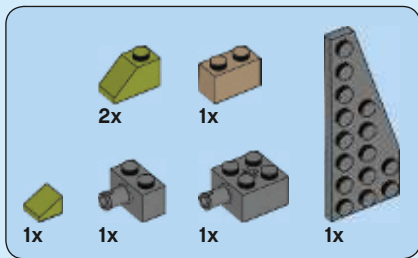

71

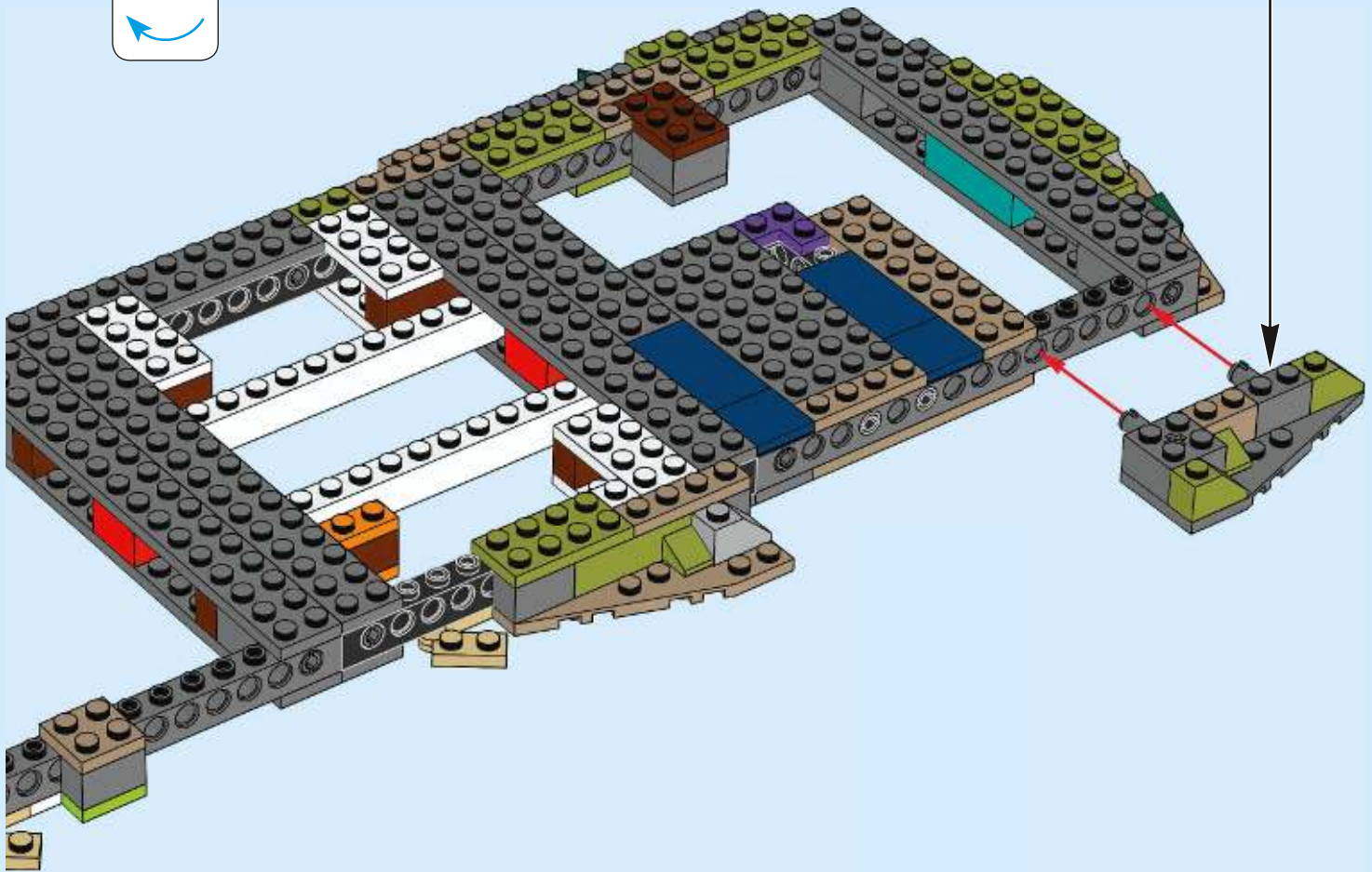
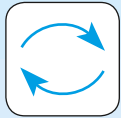
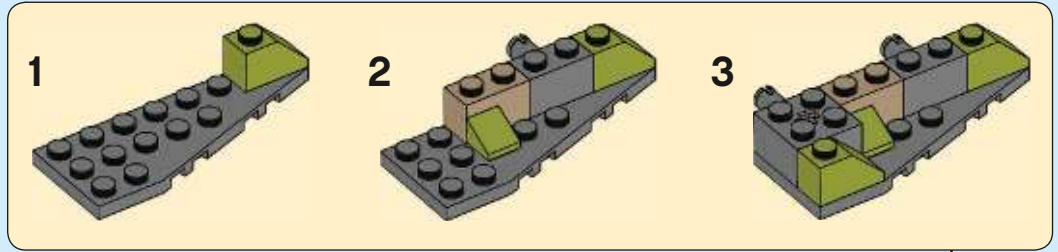



72



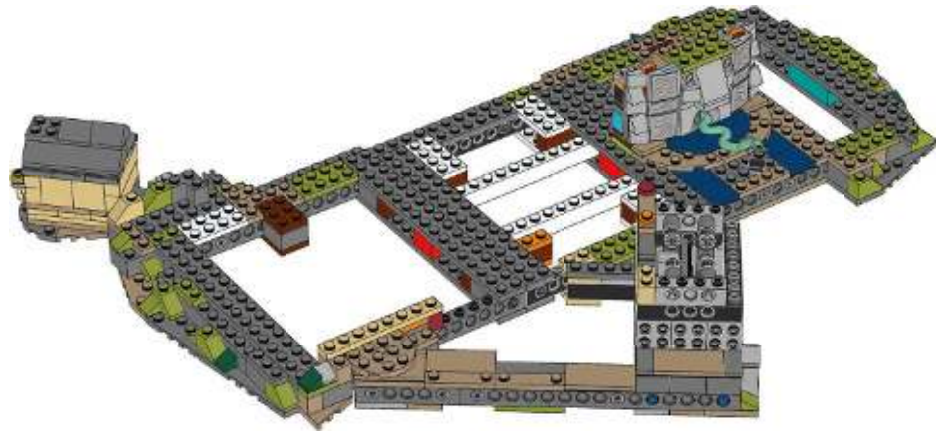

1x



2x



1x

73





74



75





76

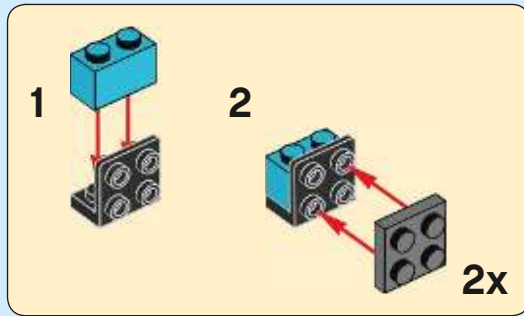

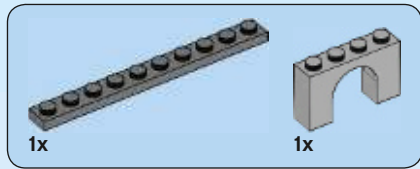

77

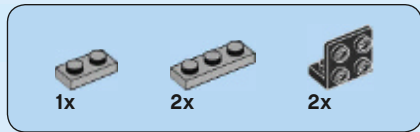

78



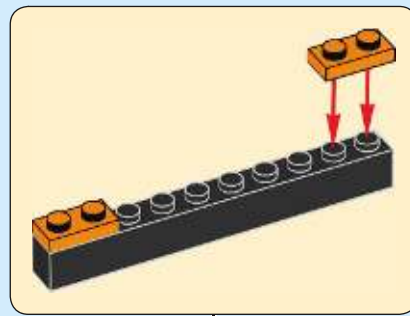
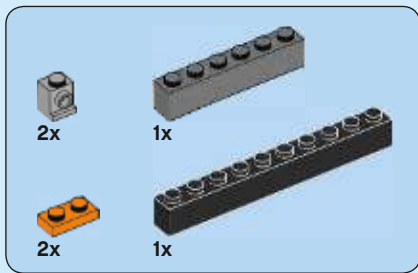

79



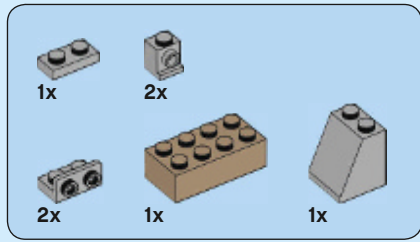

80

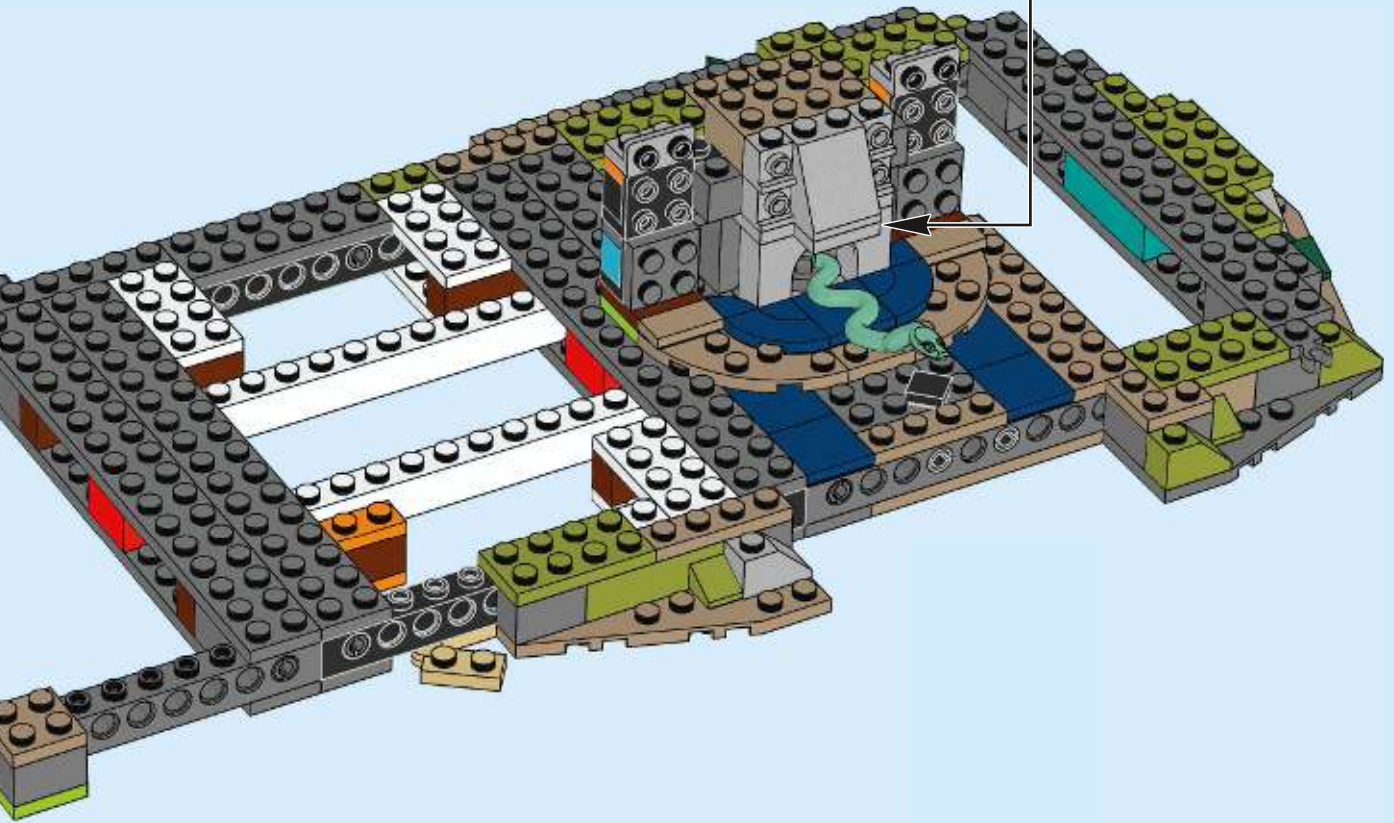
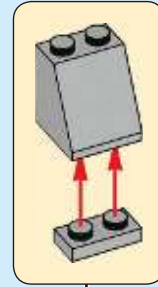



81

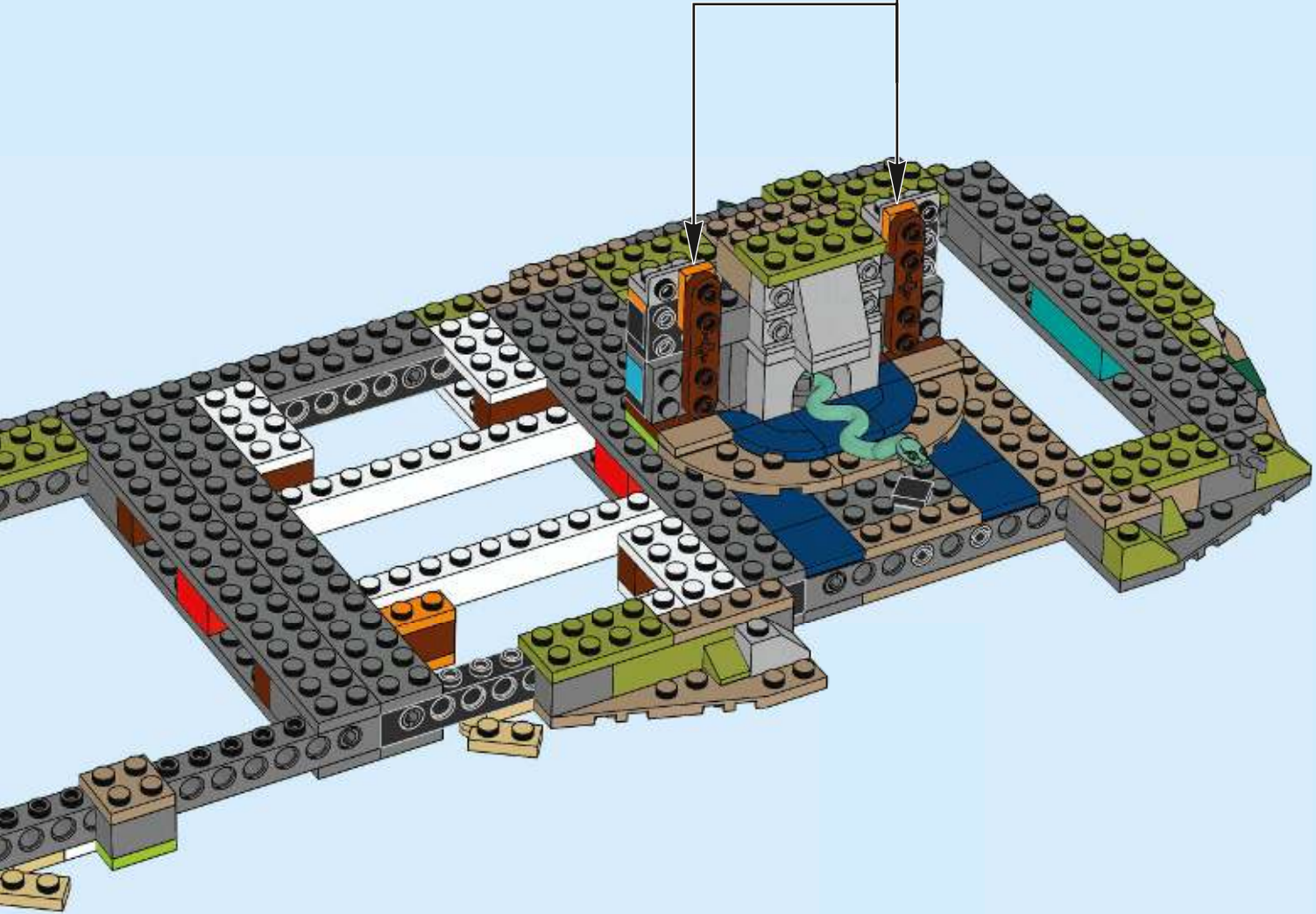
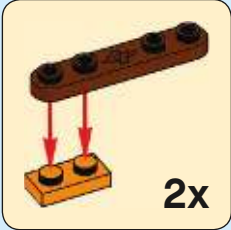



12x

82

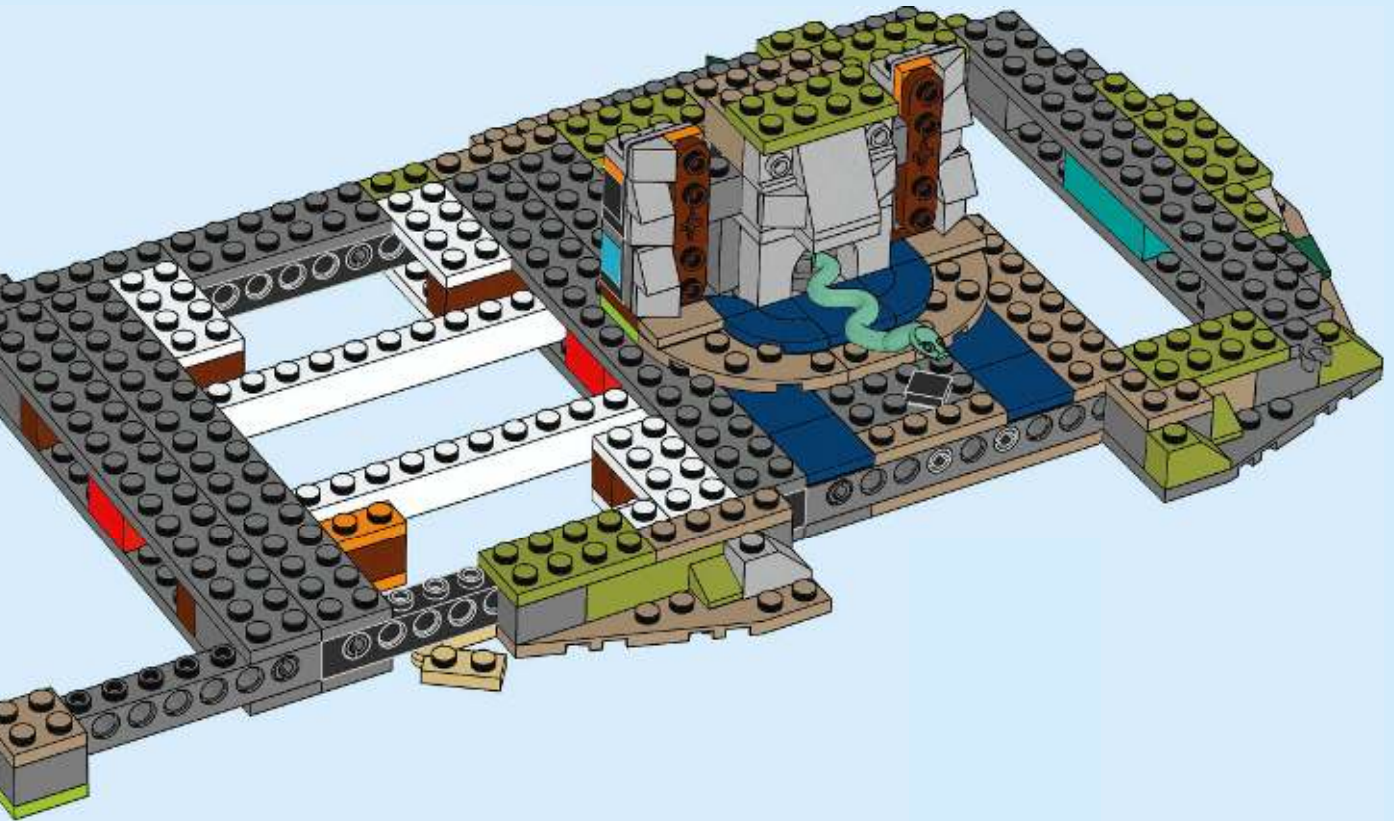

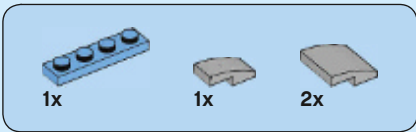

83

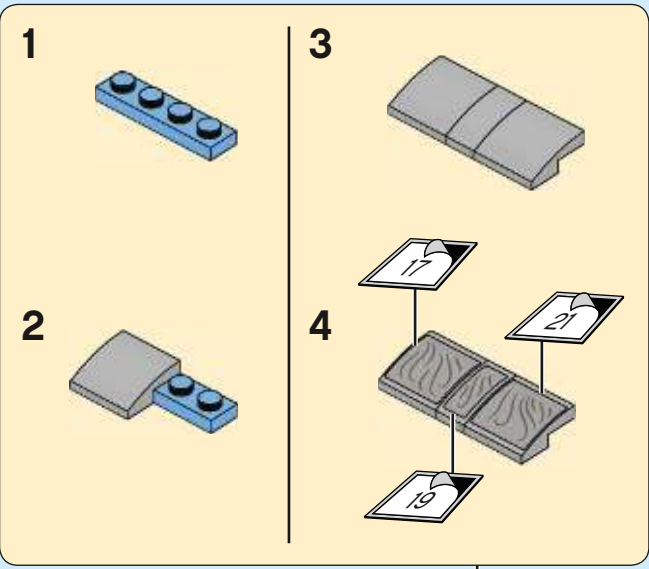

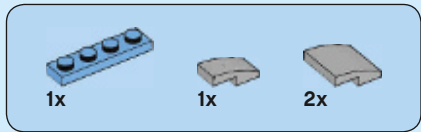

84

1 Blue 1x4 Technic beam
2 Blue 1x4 Technic beam with grey Technic 1/2 brick with hole attached
3 Grey Technic 1/2 brick with hole
4 Assembly of grey Technic 1/2 bricks with hole and numbered callouts 18, 20, and 22

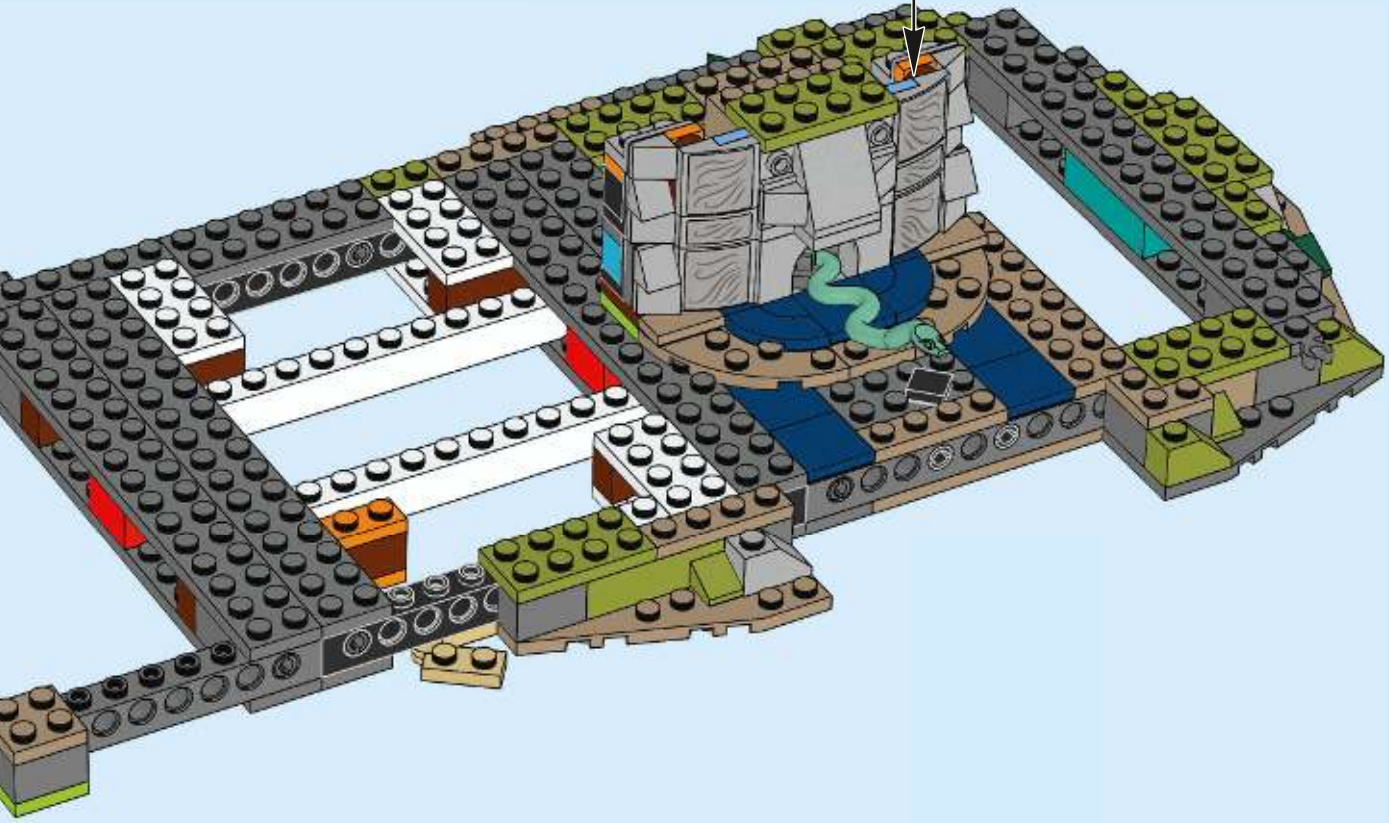

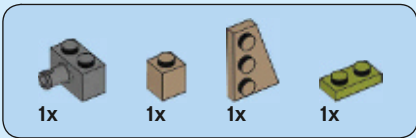

85

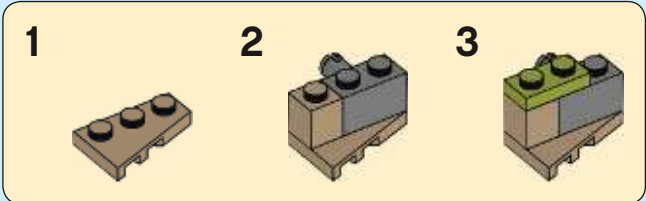

1x 1x 1x 1x

86

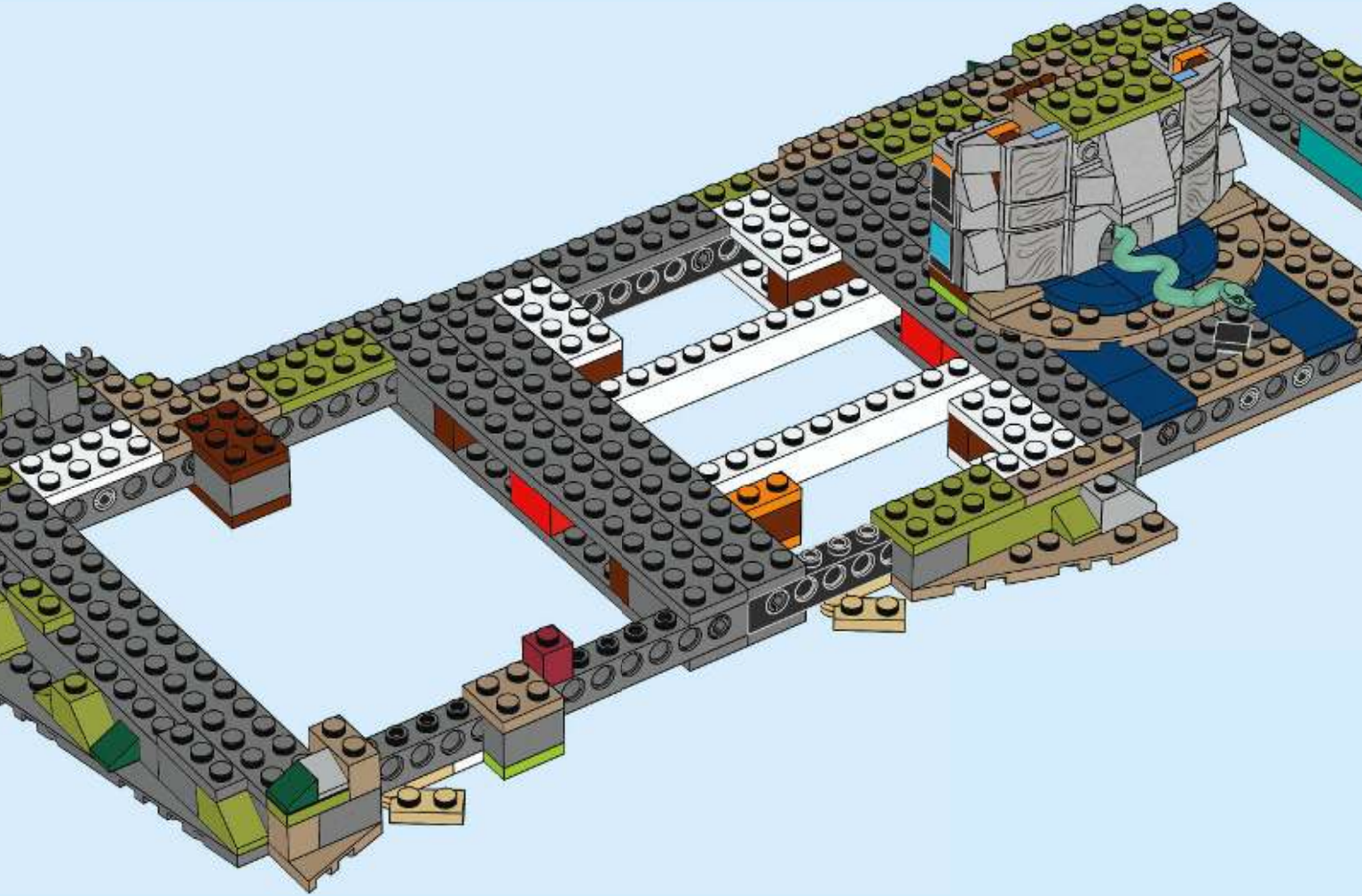

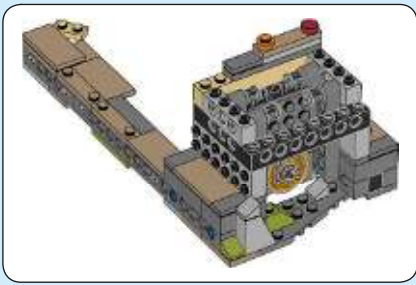

87

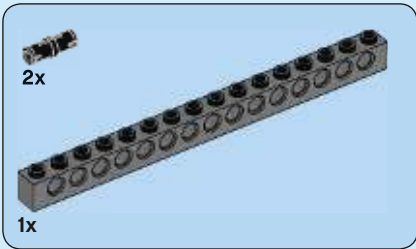

88

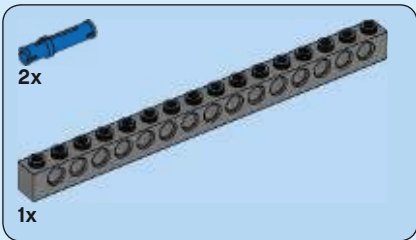
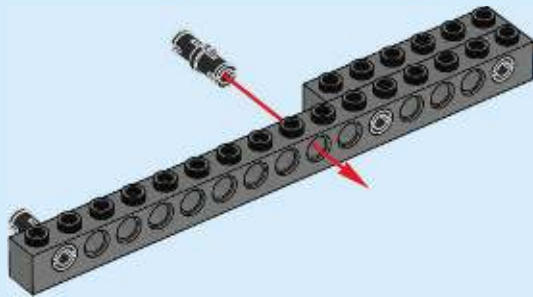

89



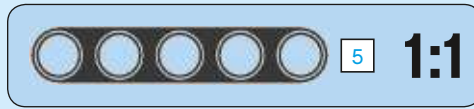
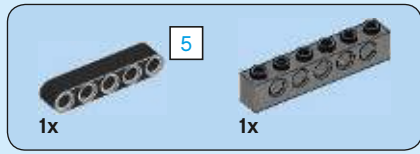

90

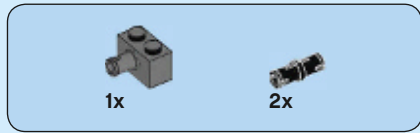
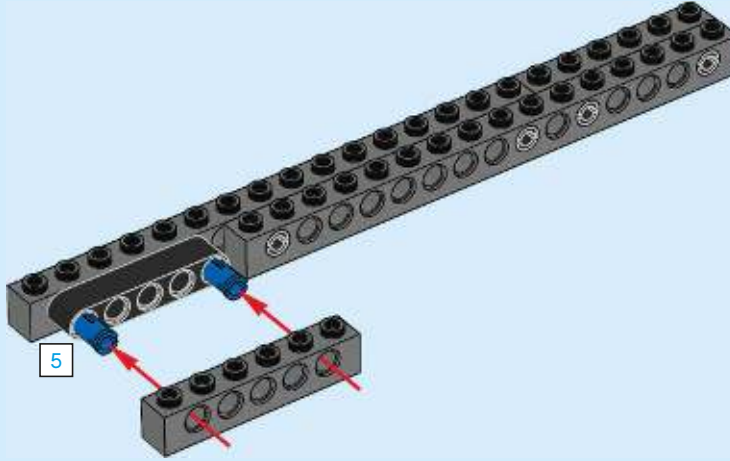

91

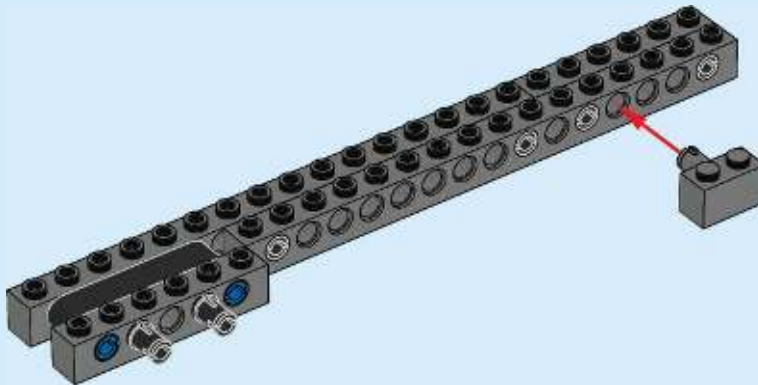

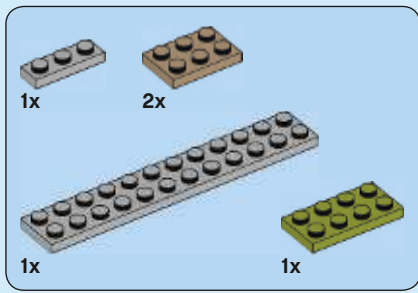

92

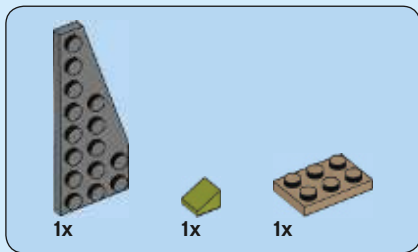
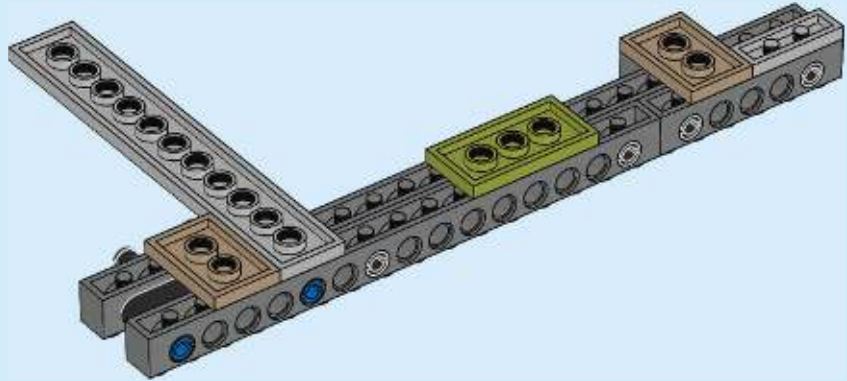
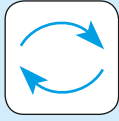

93

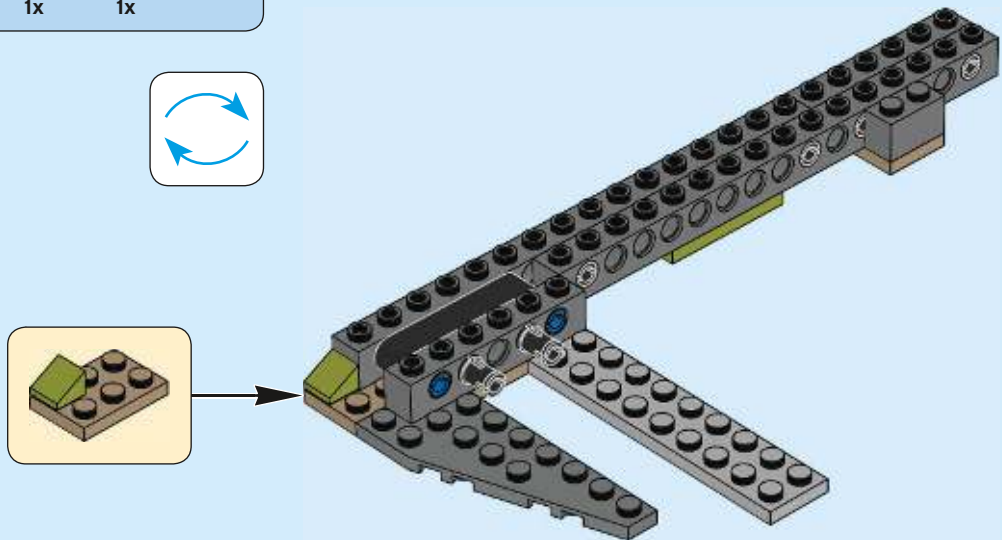
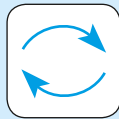

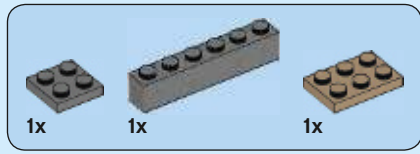

94

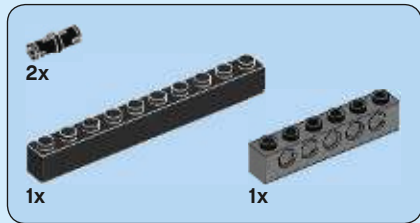
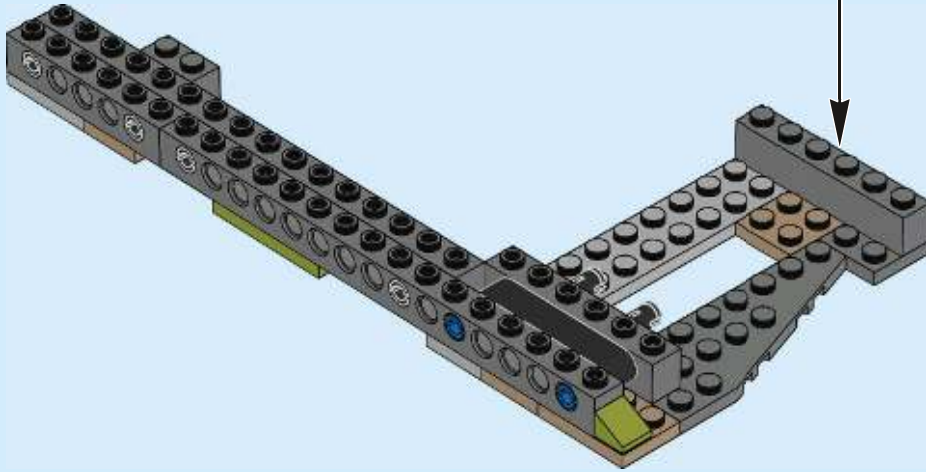
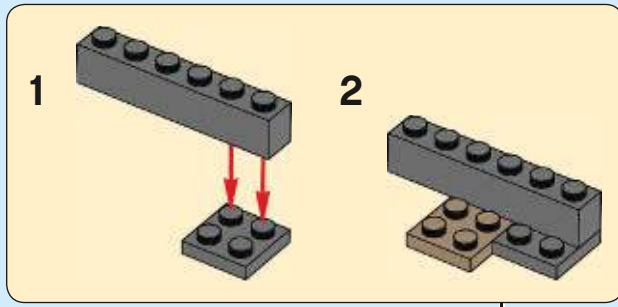
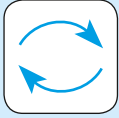

95

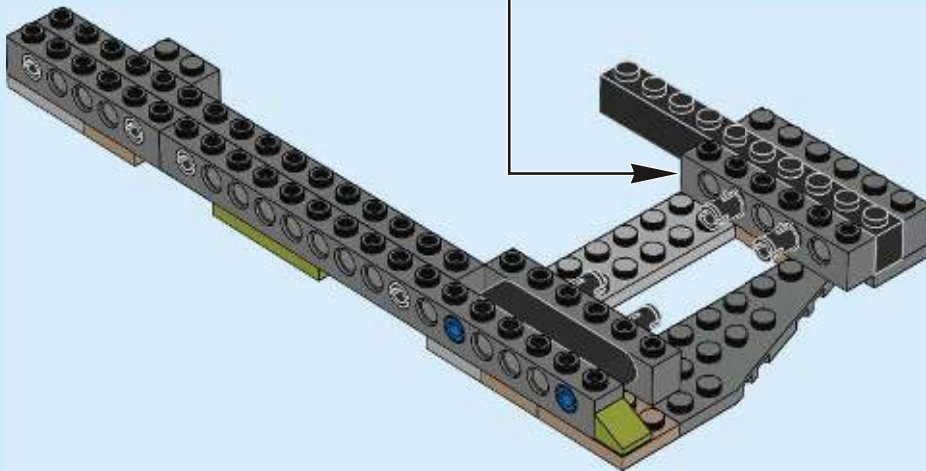
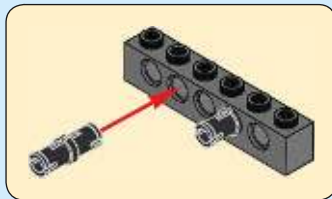

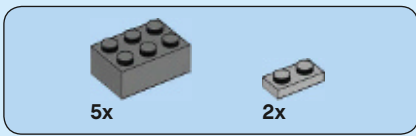

96

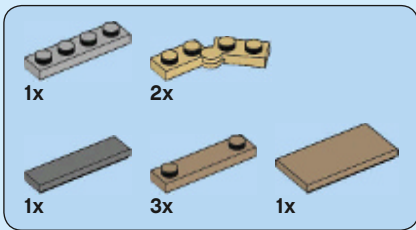
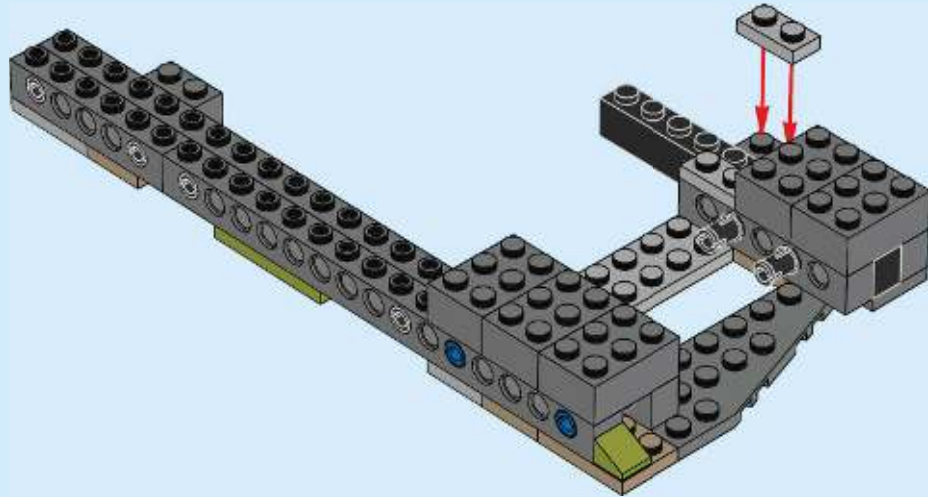

97

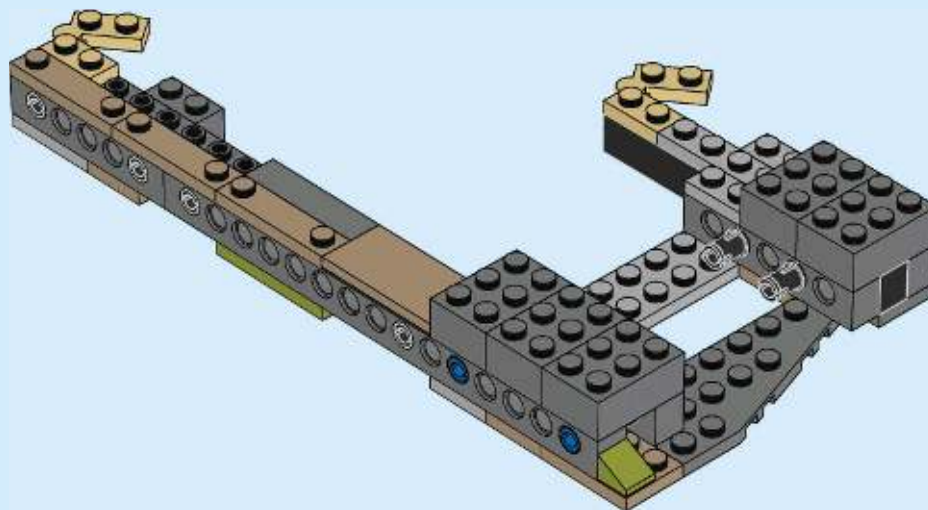

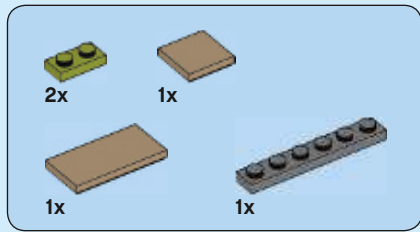

98

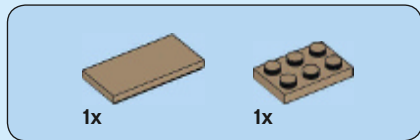
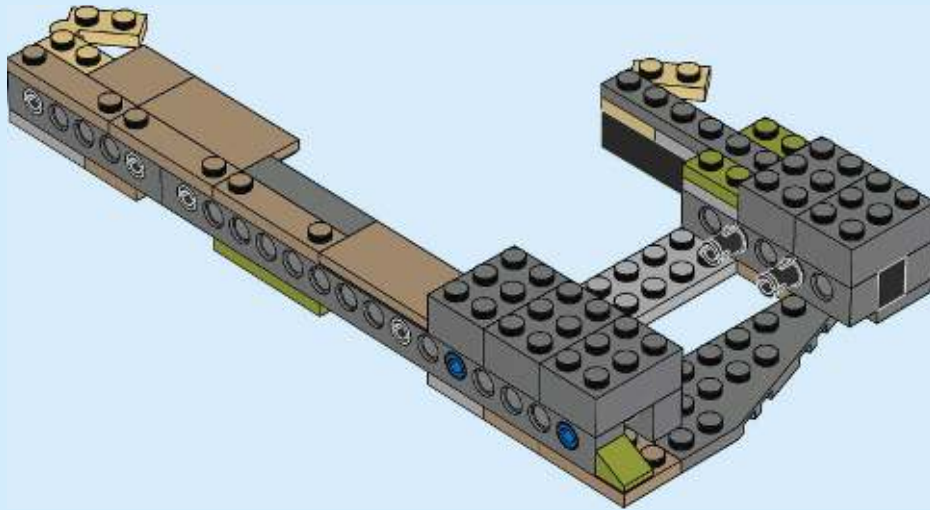

99

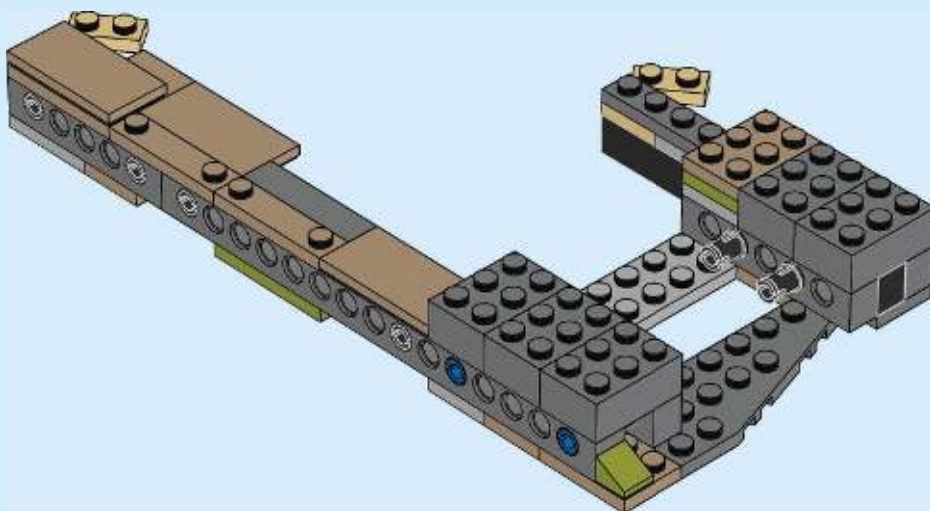

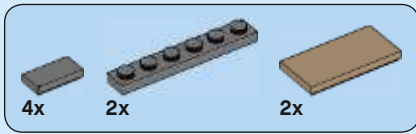

100

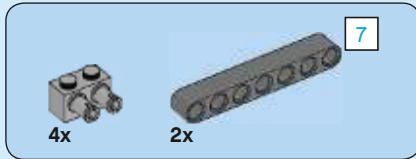
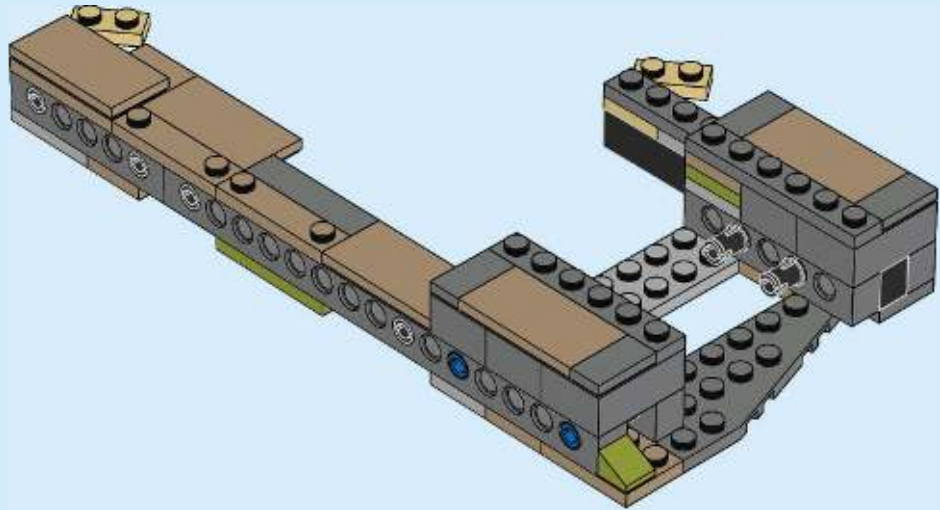

101

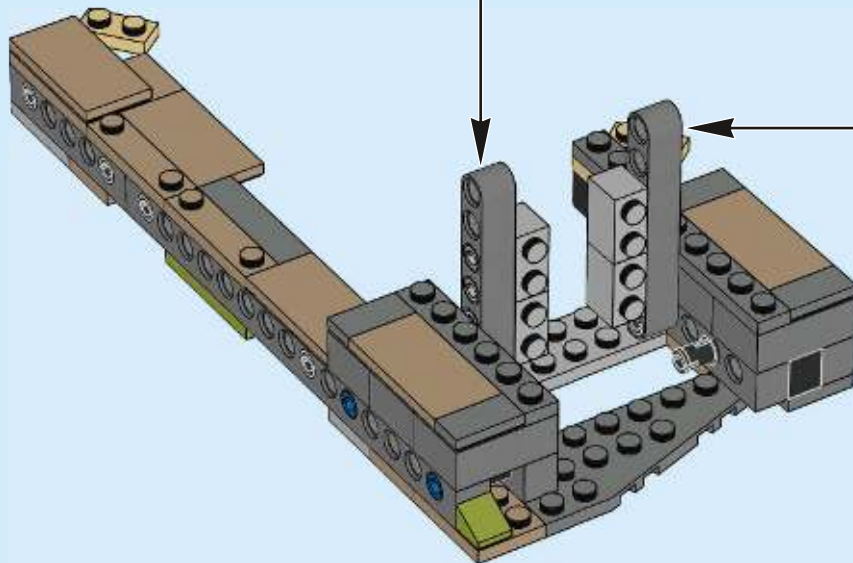
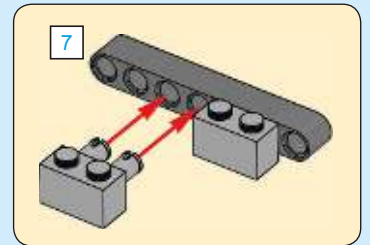
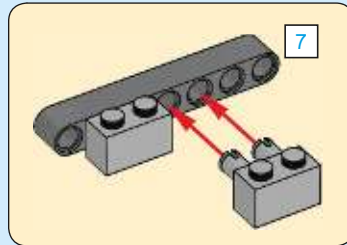

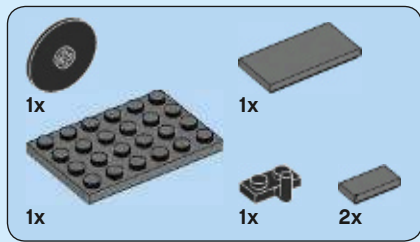

102

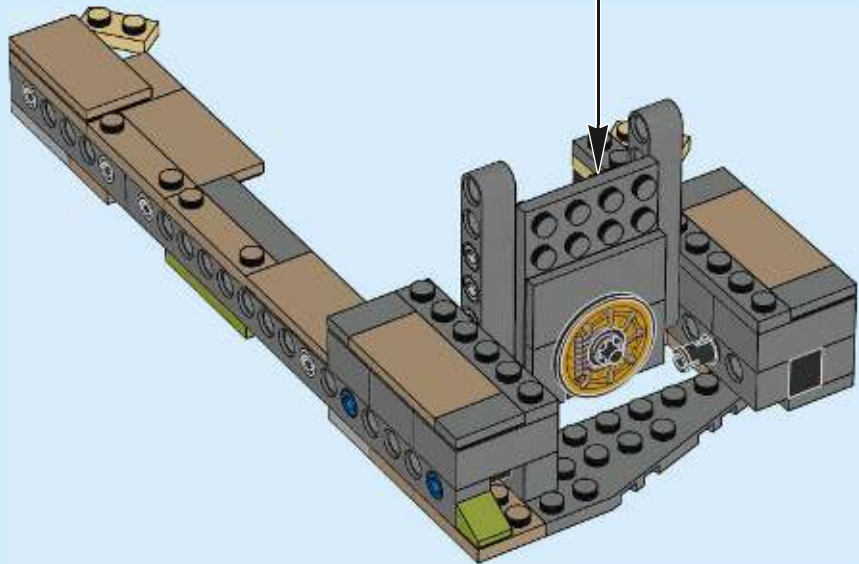
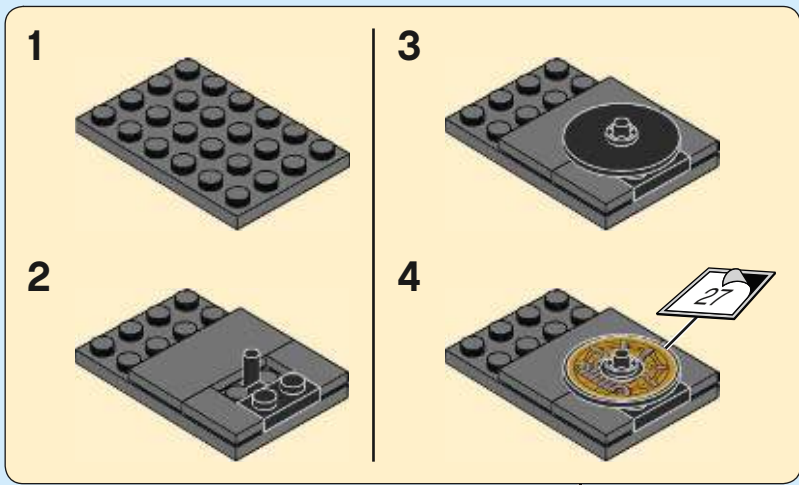

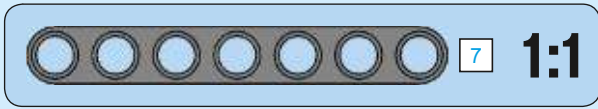
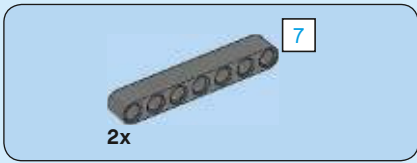

103

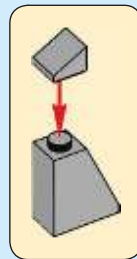
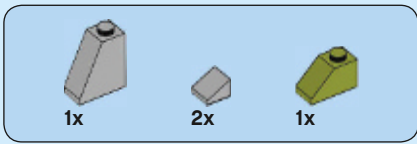
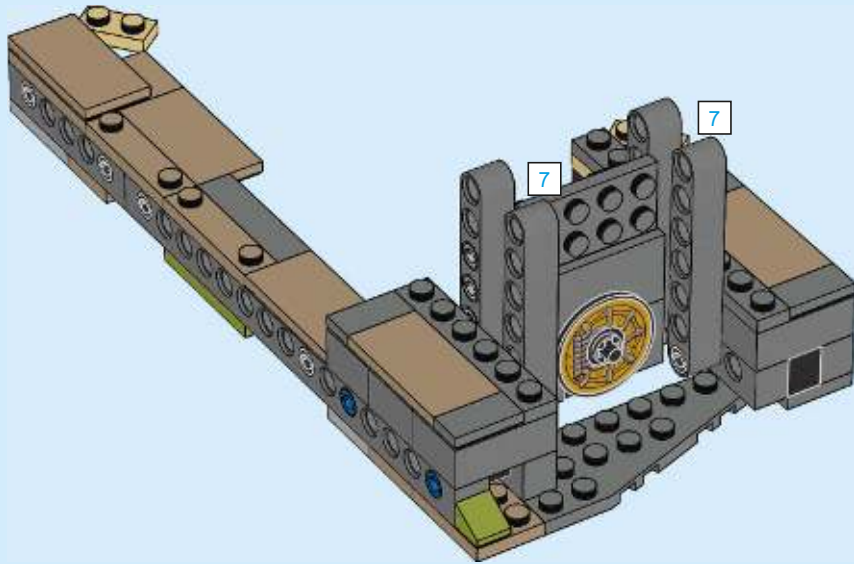

104

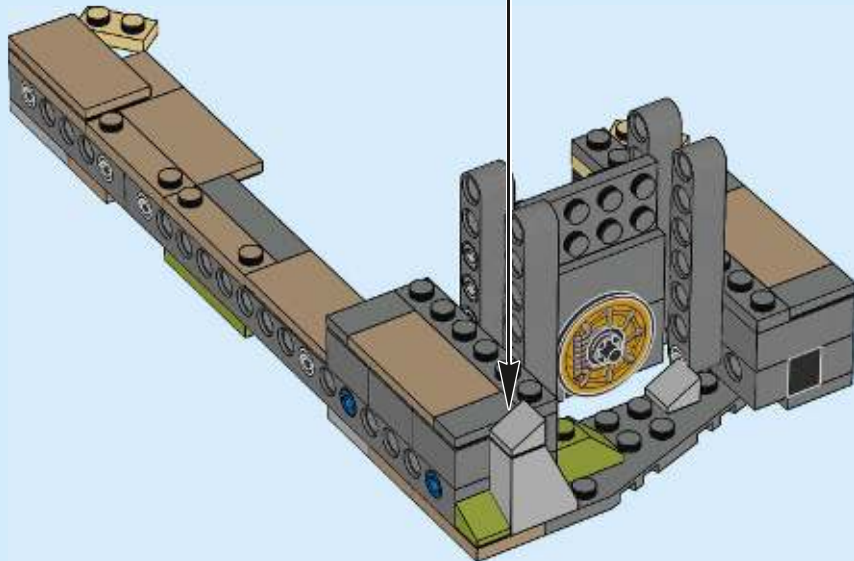



6x

105

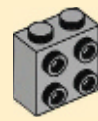
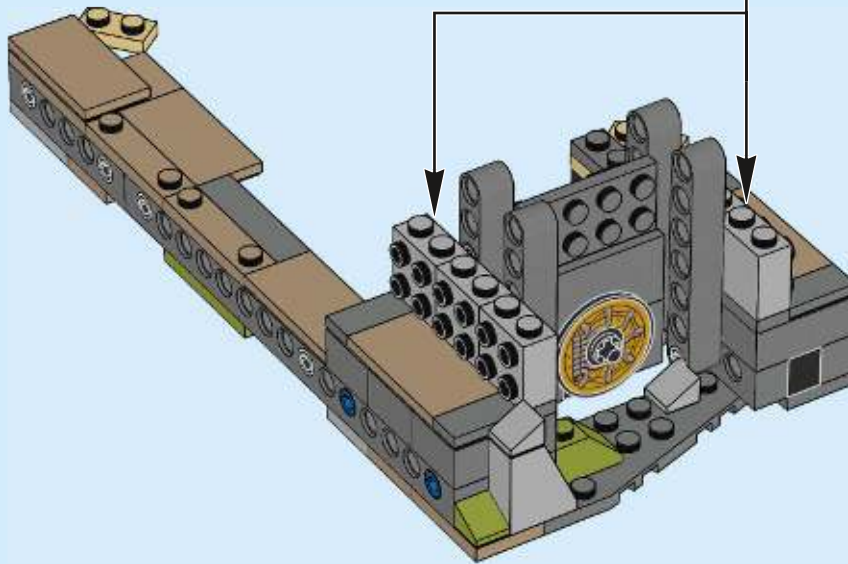

6x



1x

106

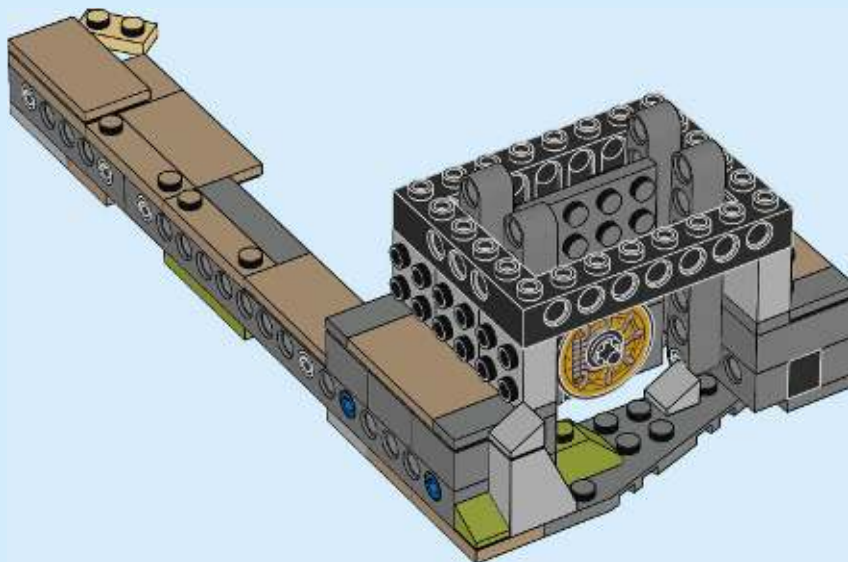

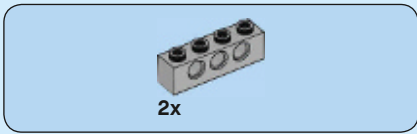

107

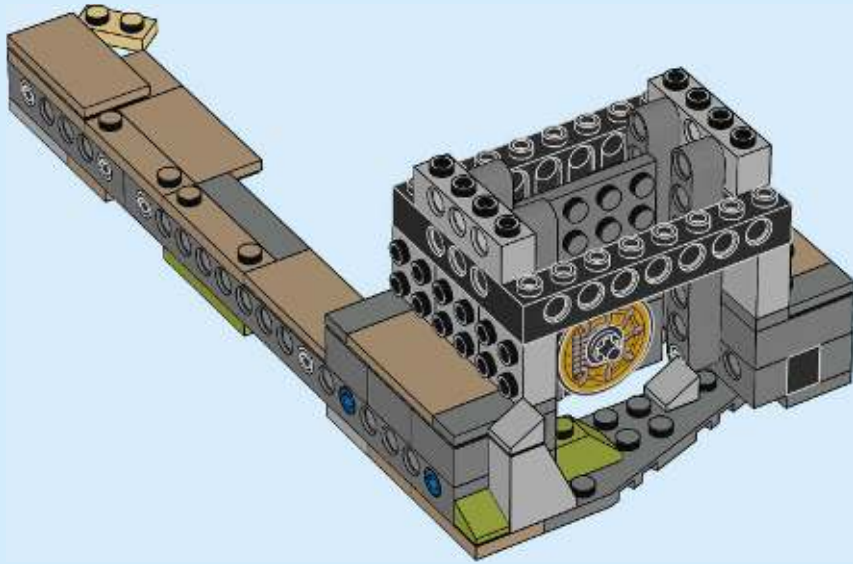

108

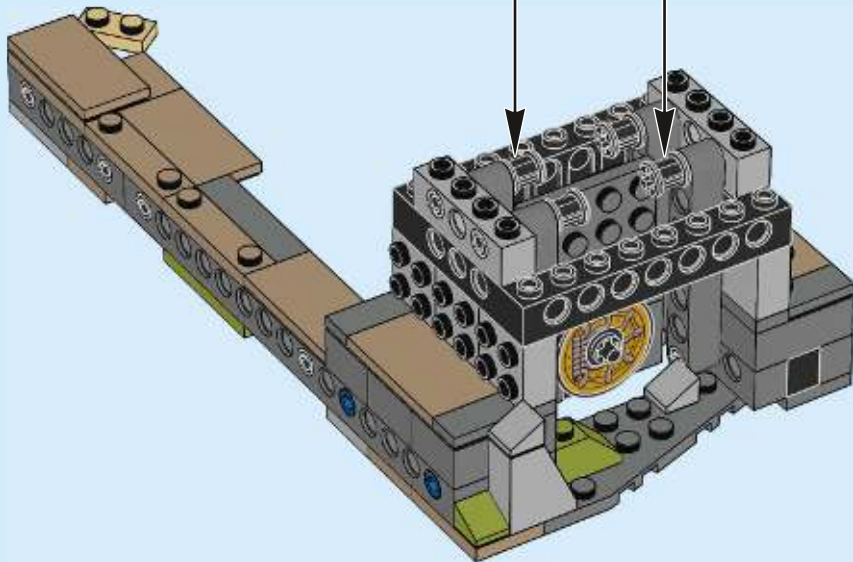

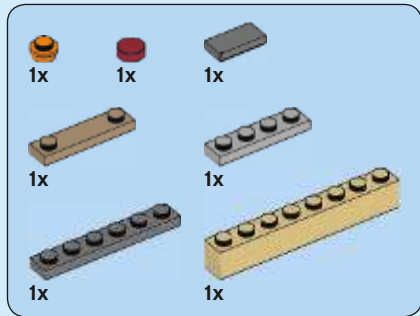

109

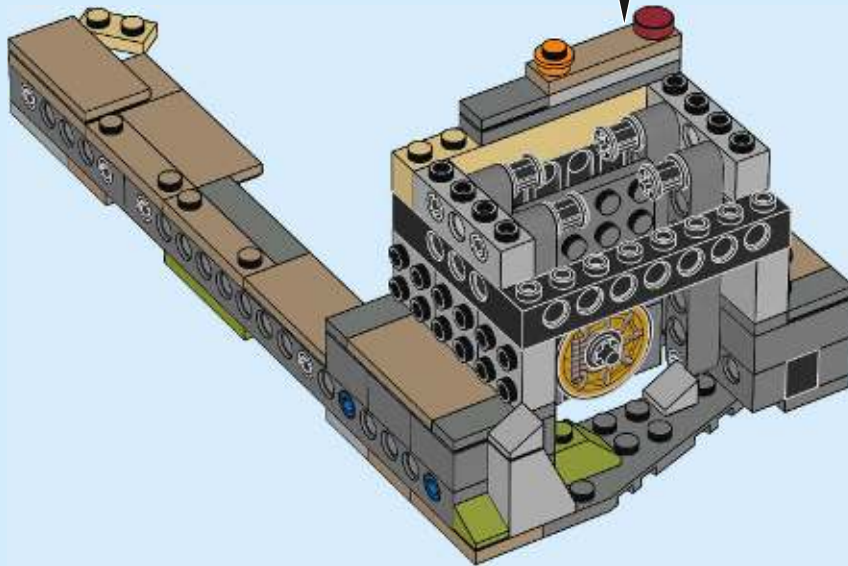
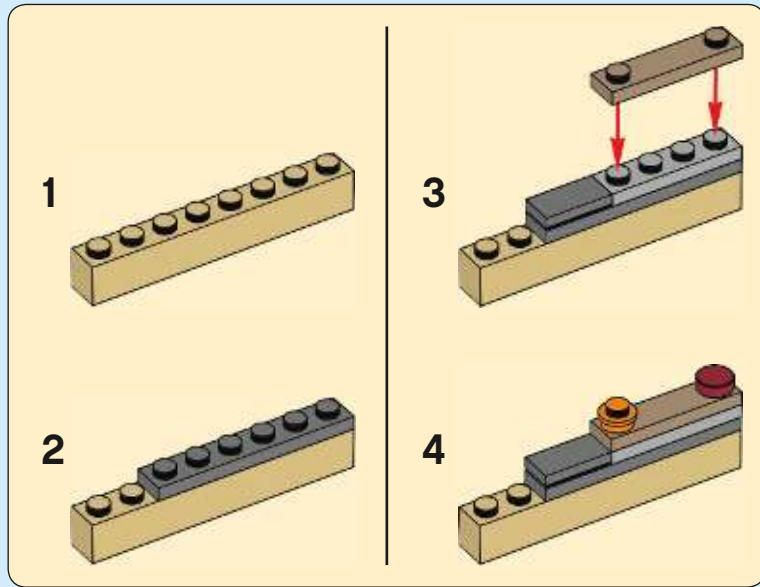

110

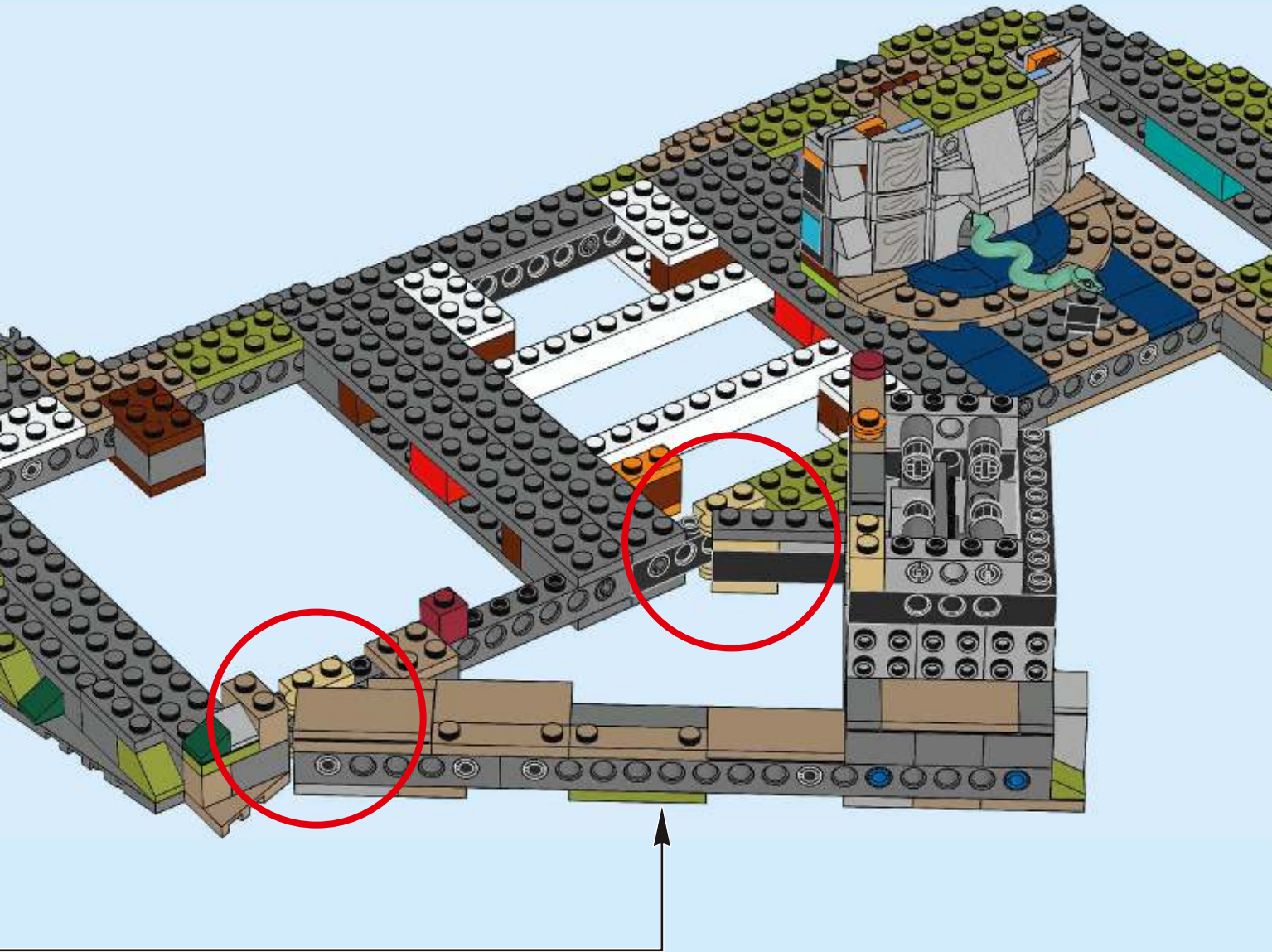

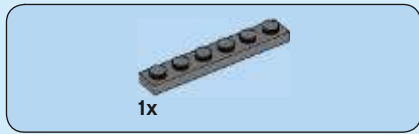

111

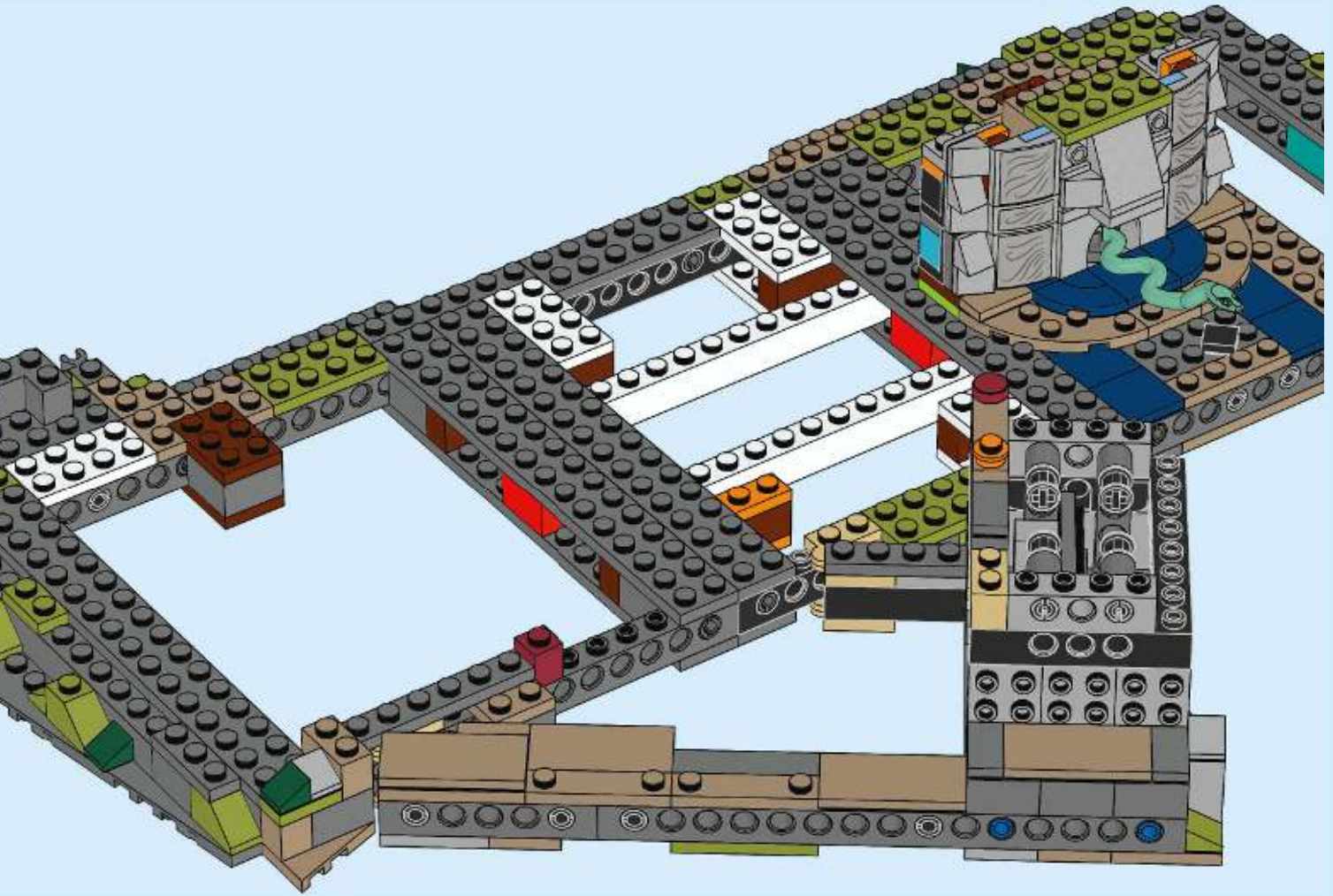

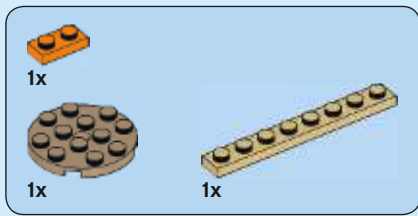

112

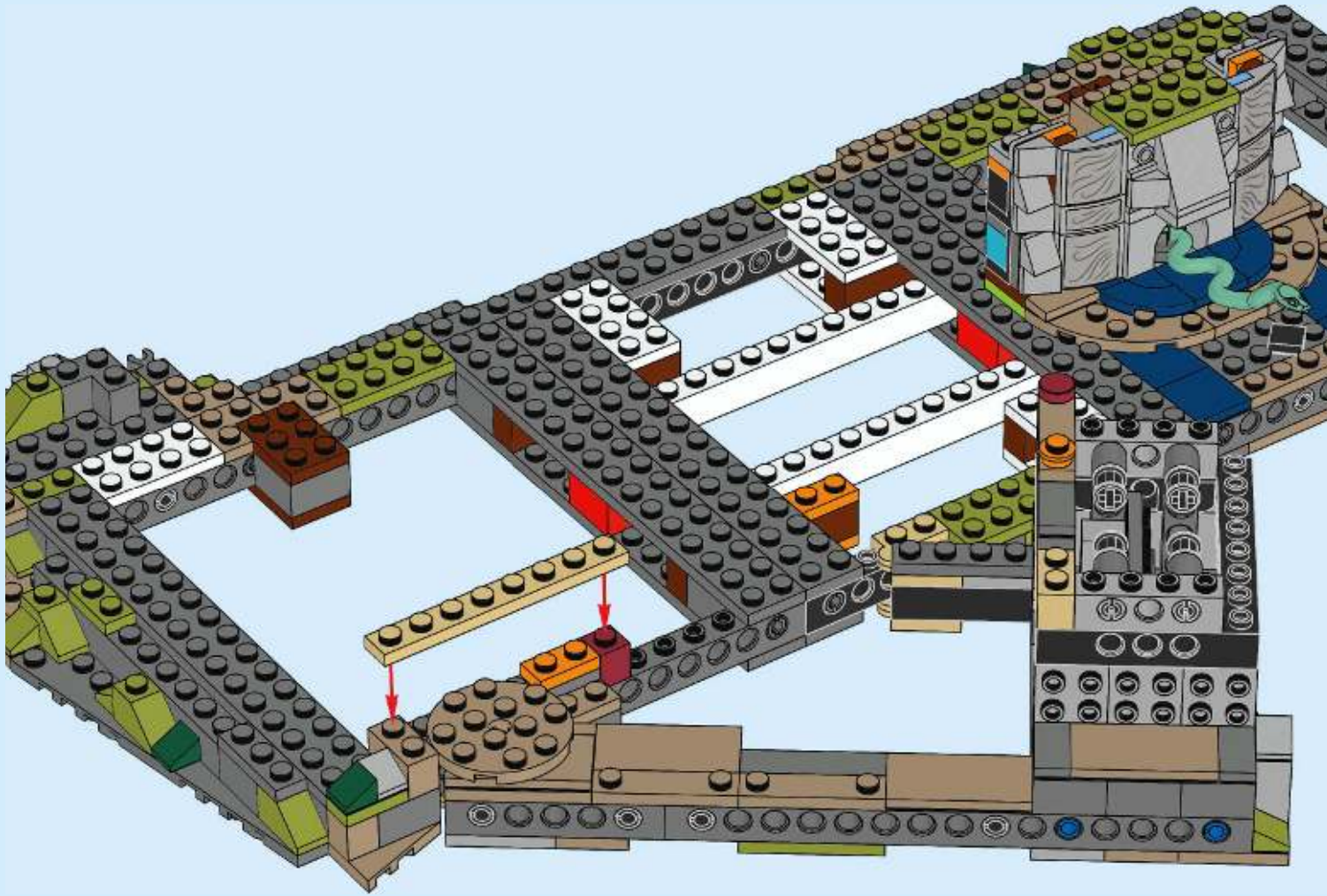

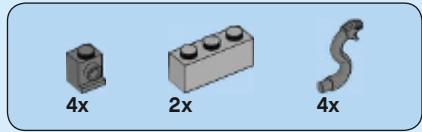
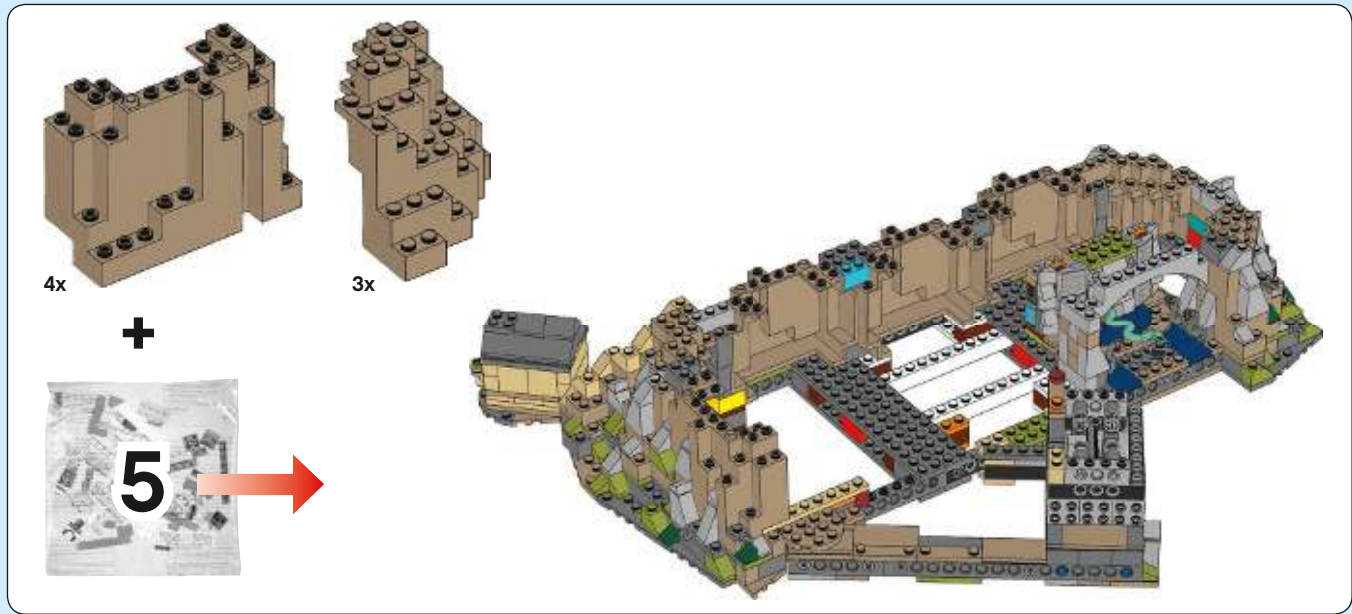

113

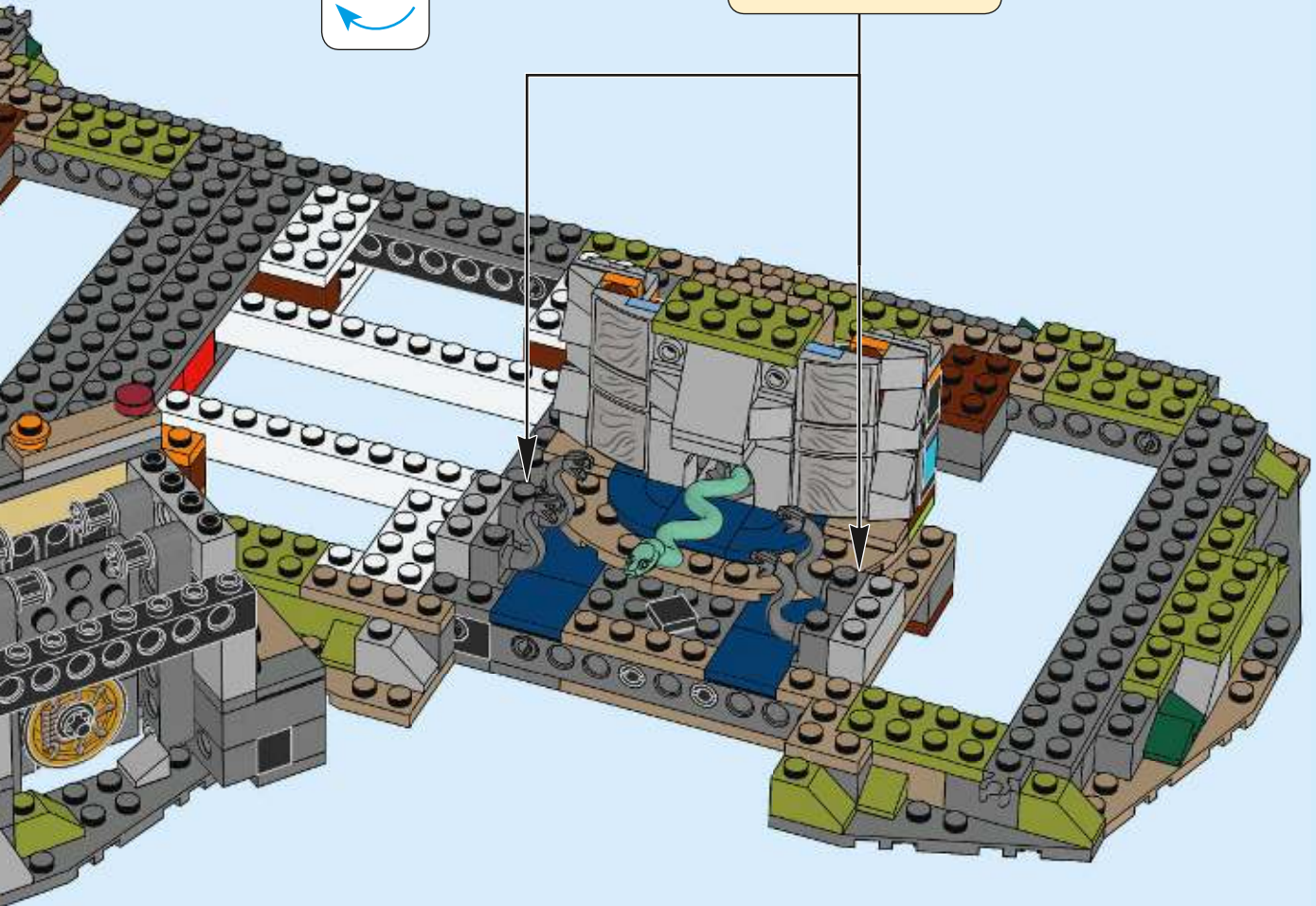
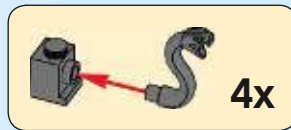
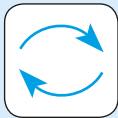

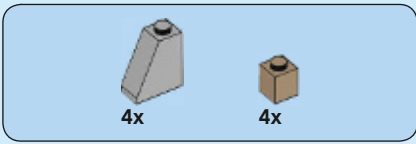

114

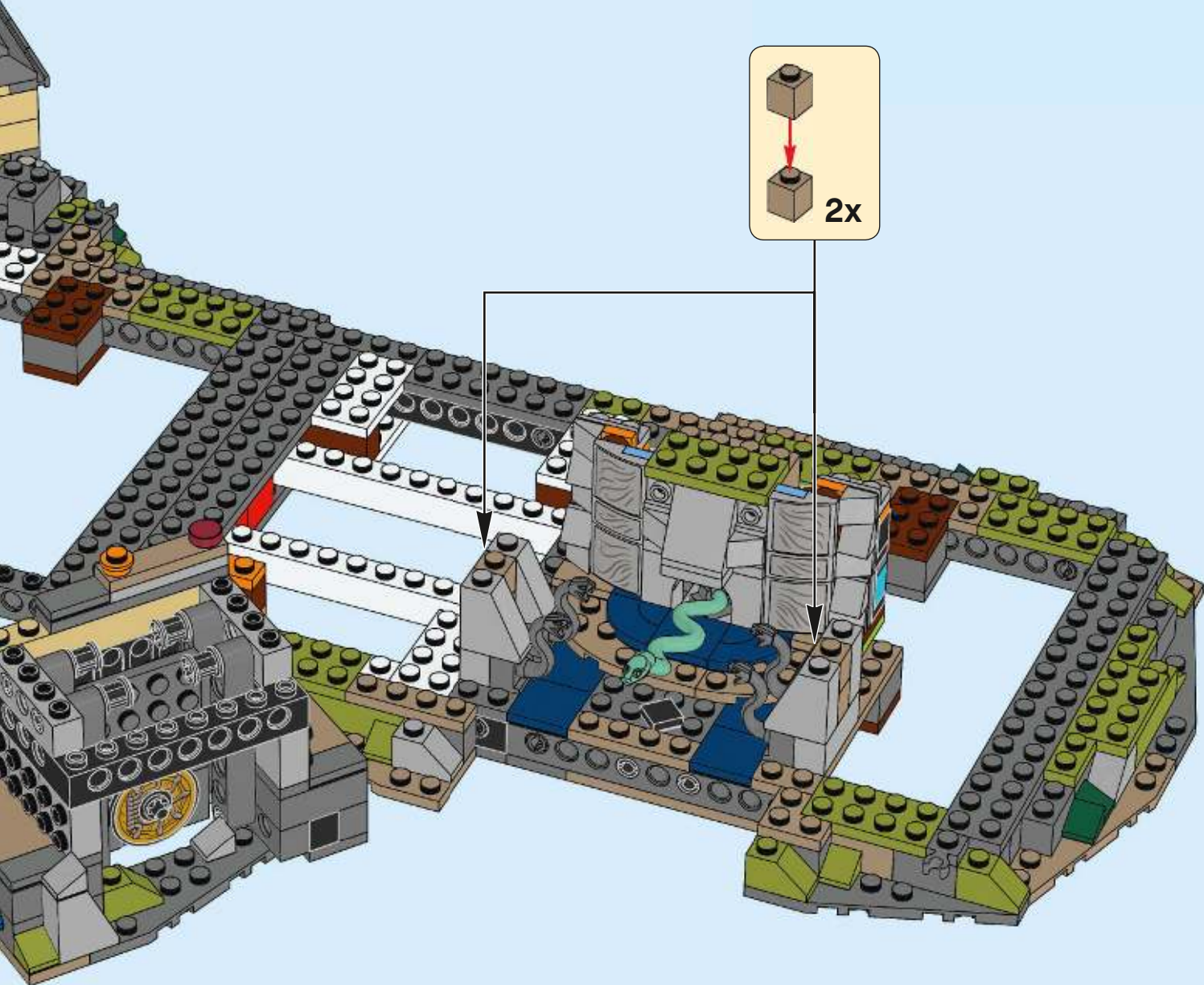

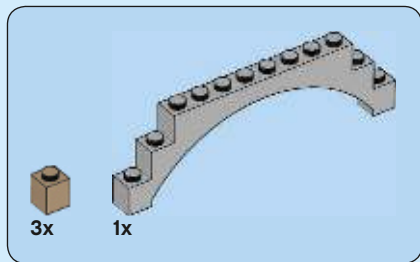

115

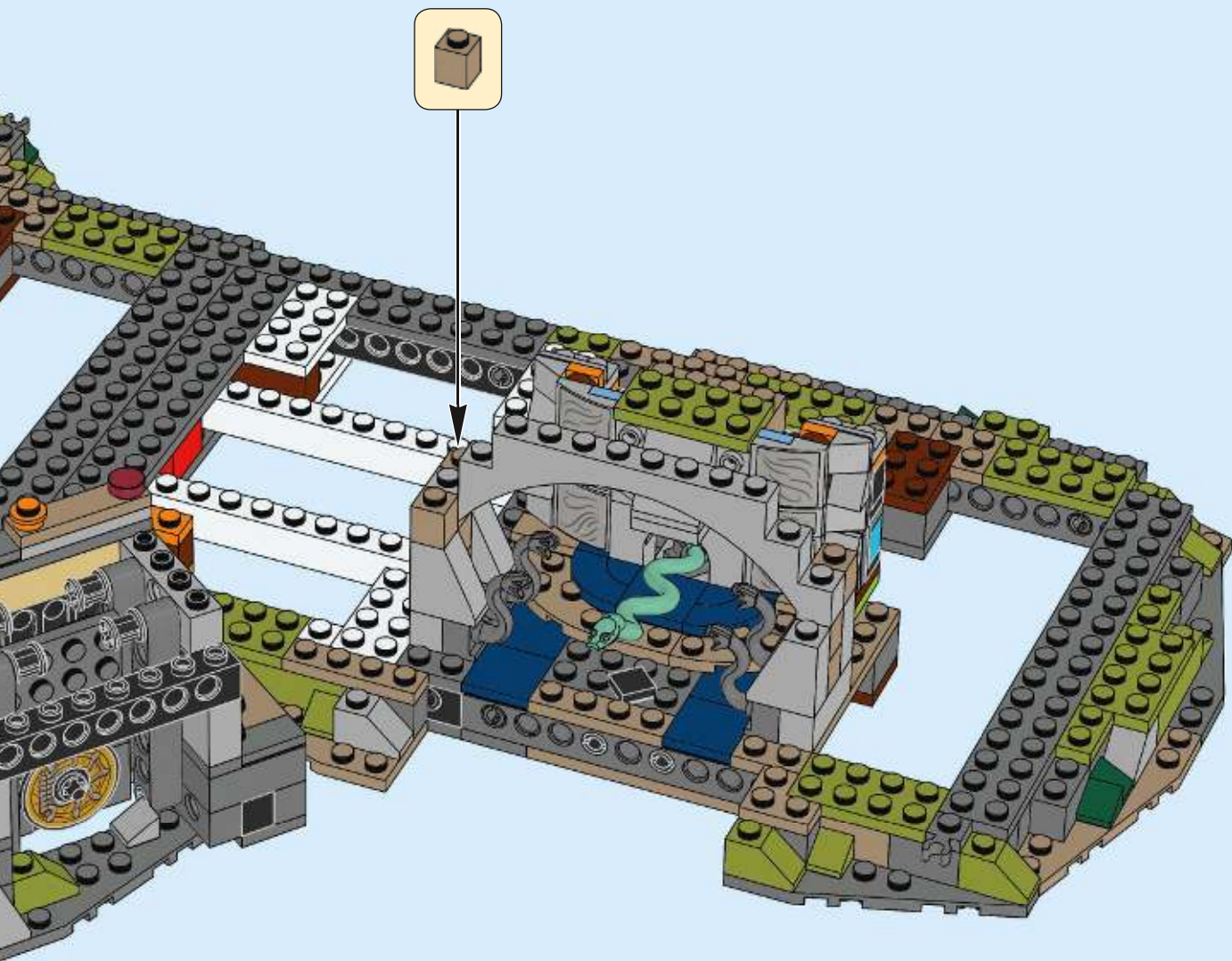

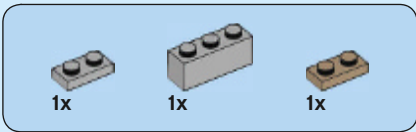



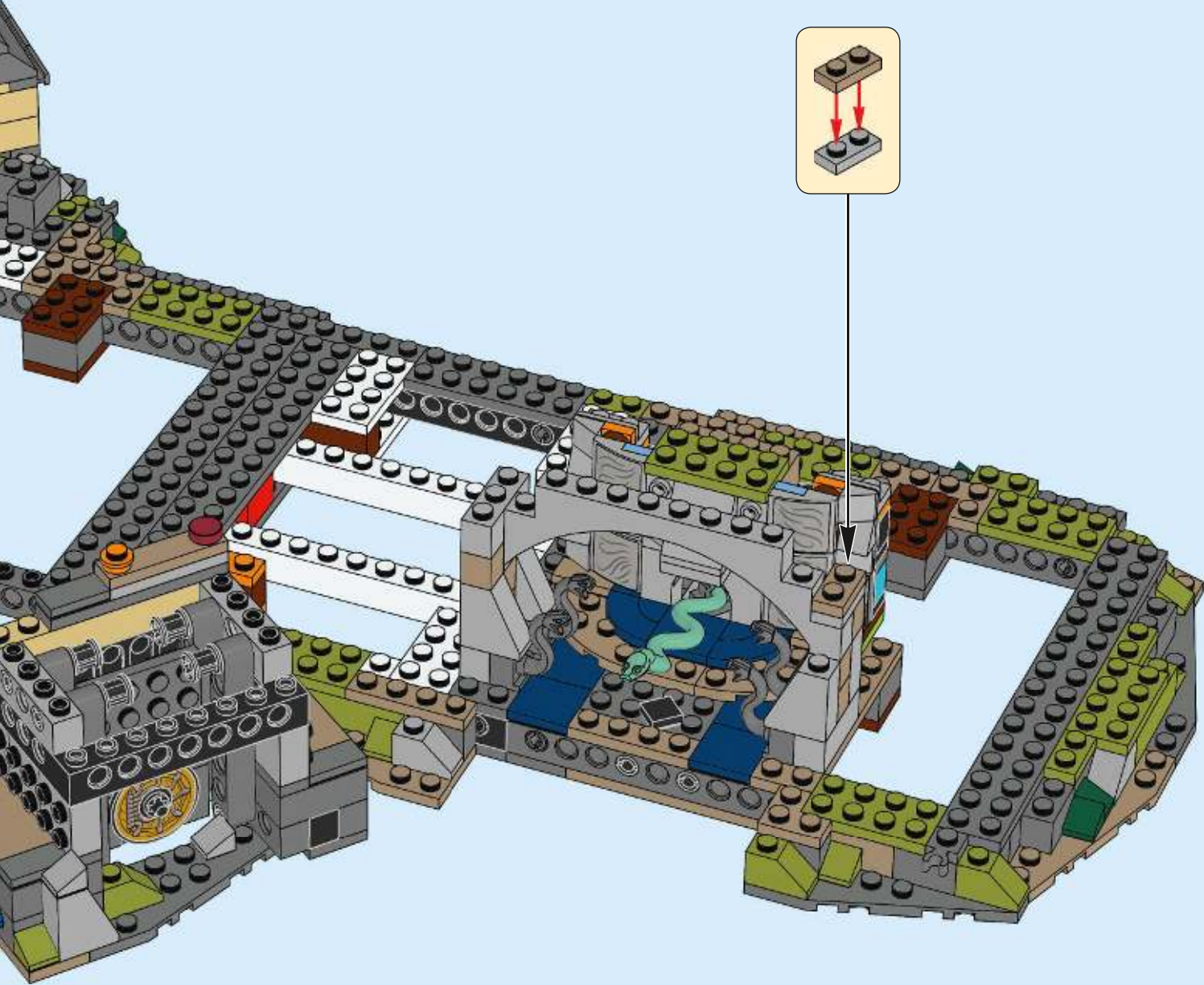

116





			
1x	2x	1x	1x

118

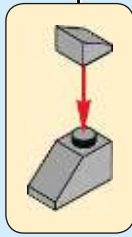
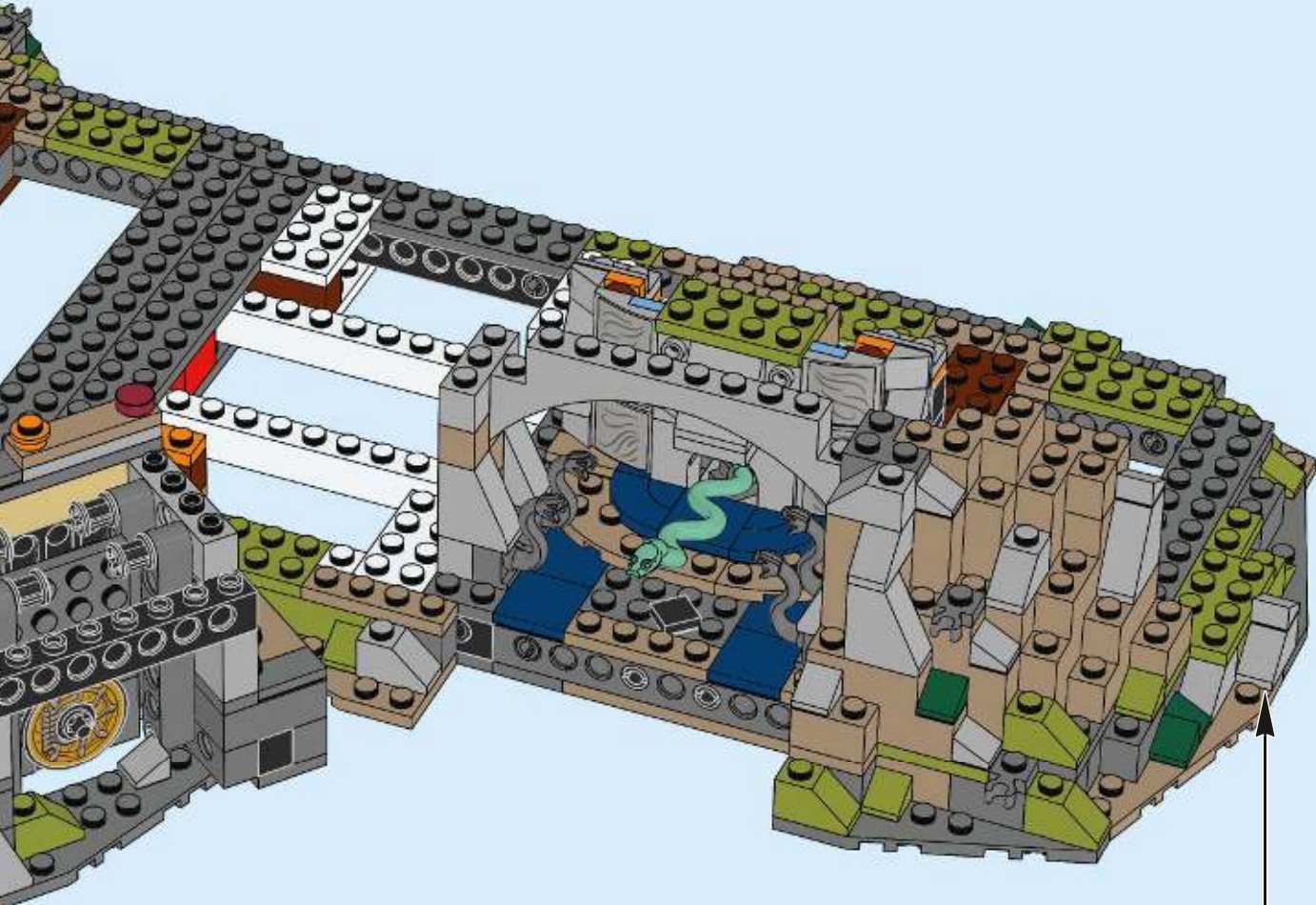

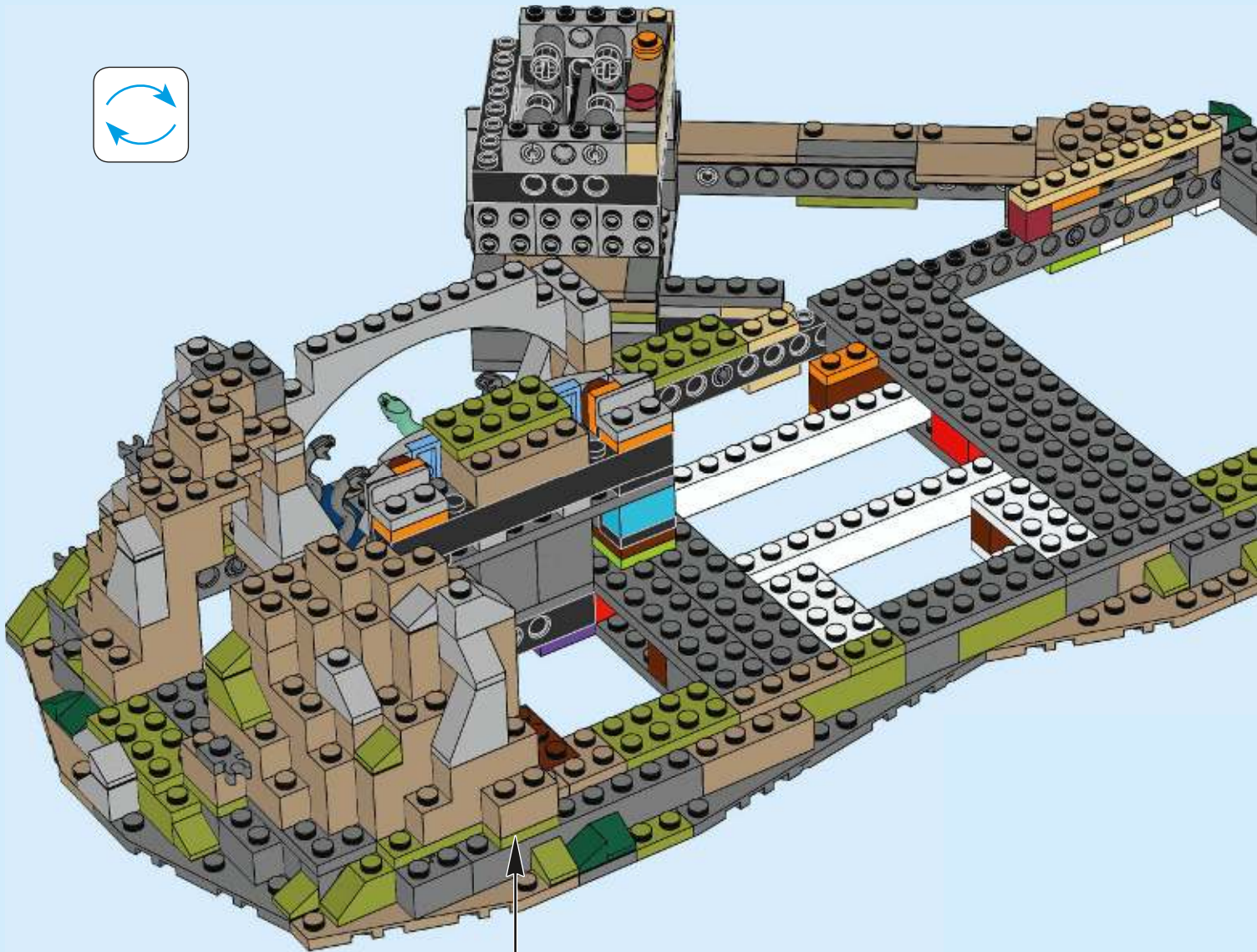
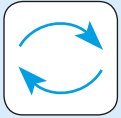

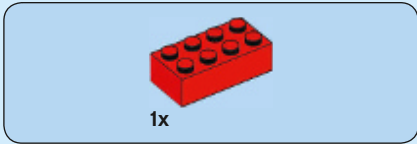
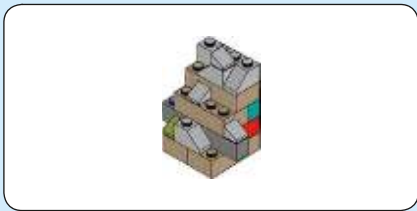

120

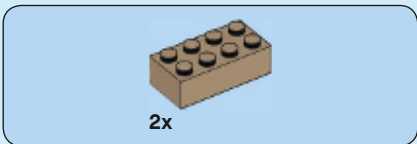
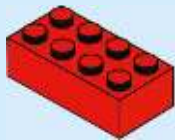

121

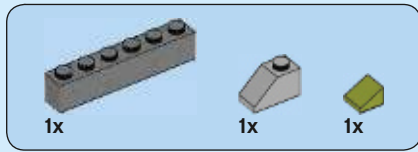
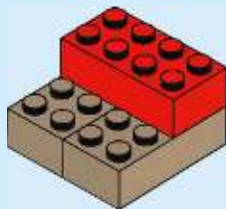

122

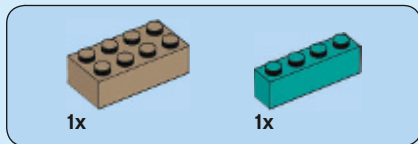
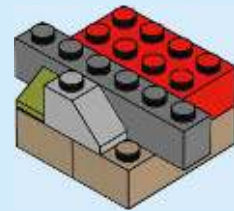

123

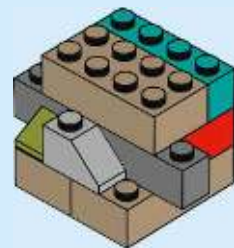

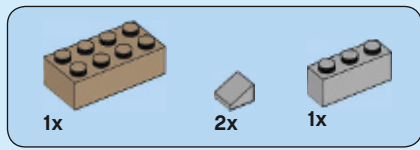

124

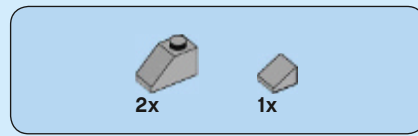
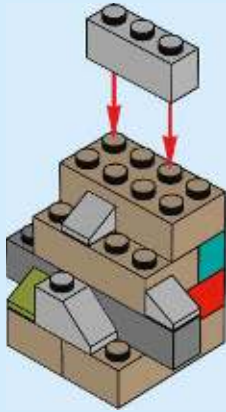

125

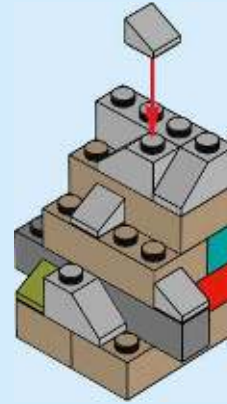

126

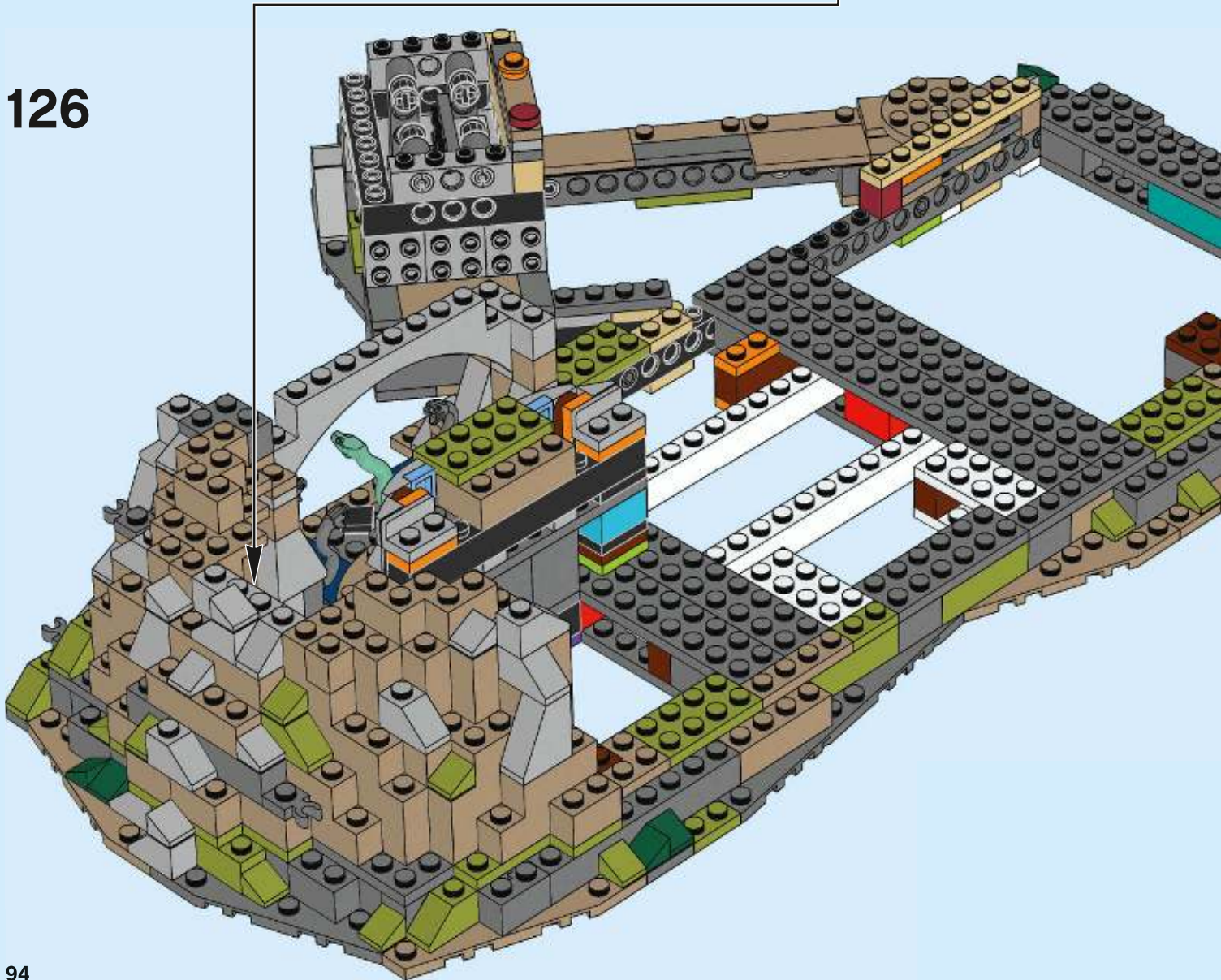



127

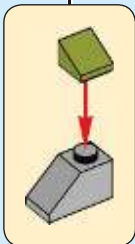
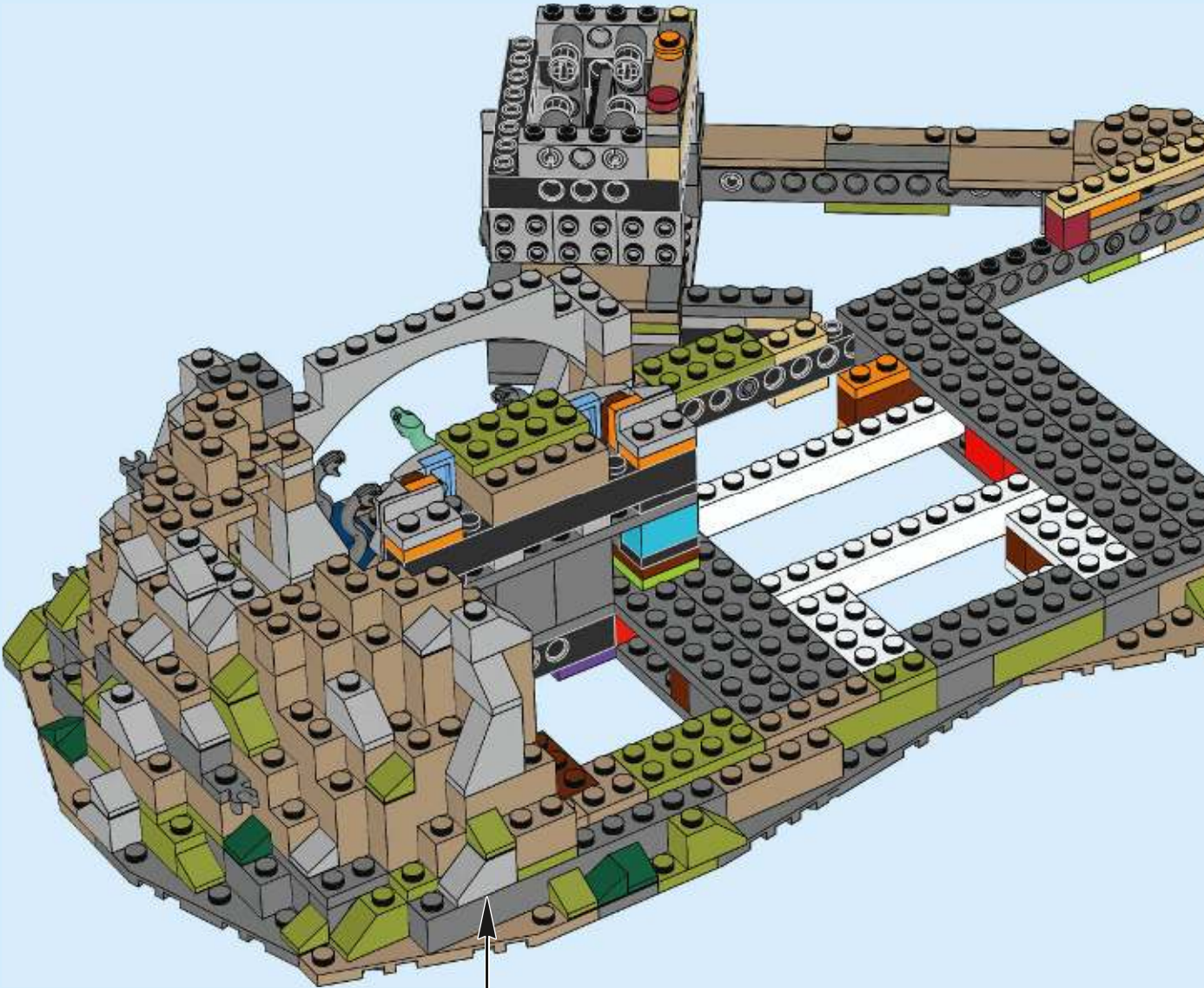

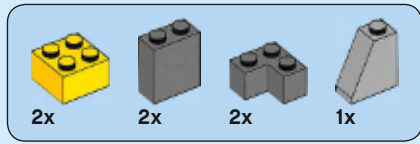

128

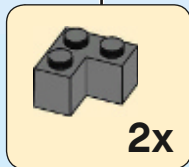
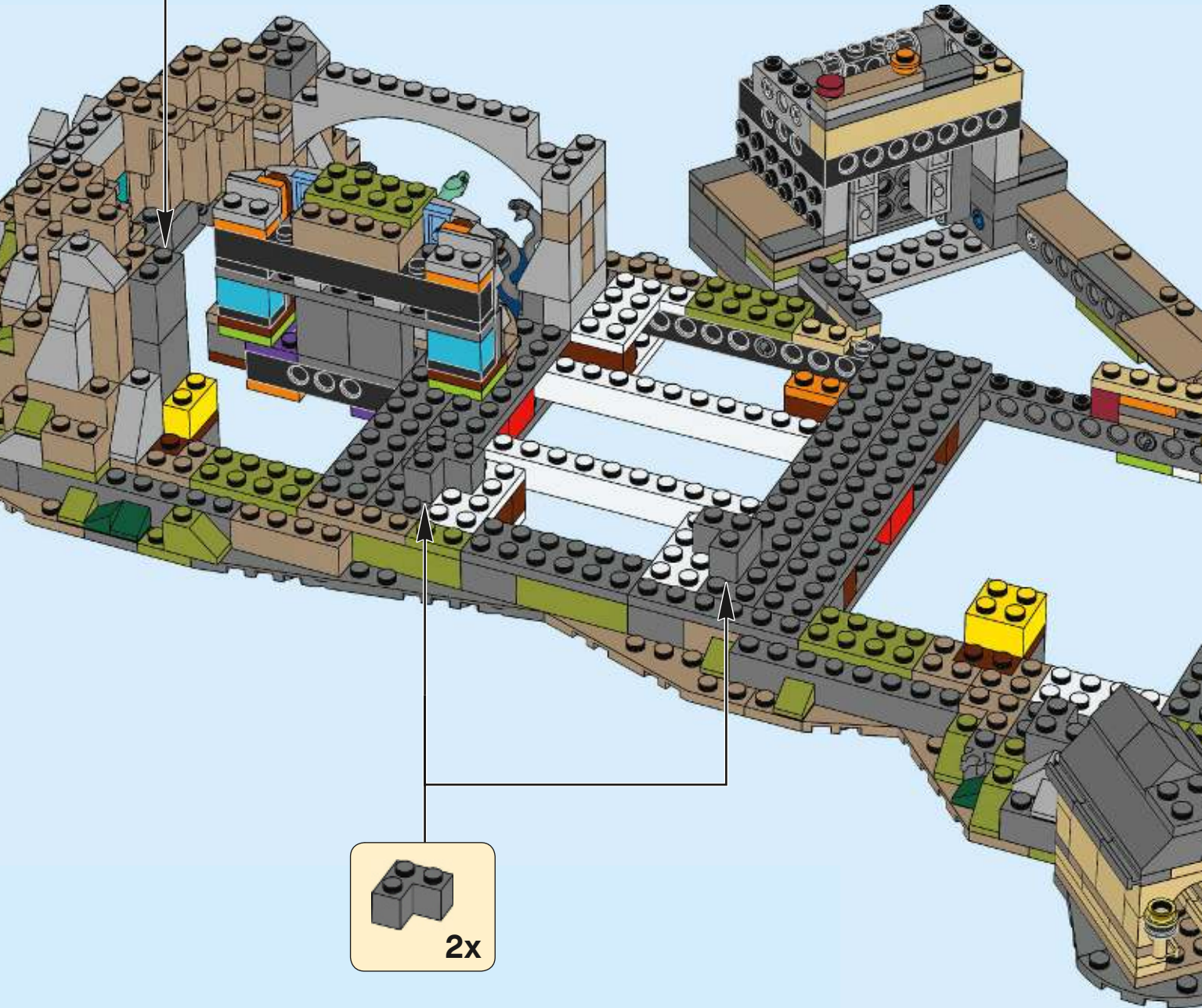
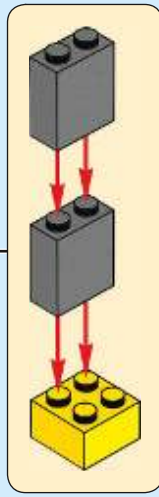
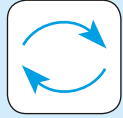

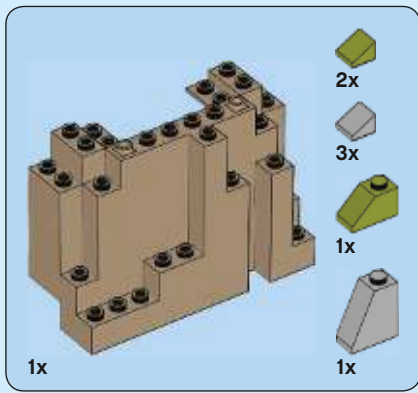

129

1

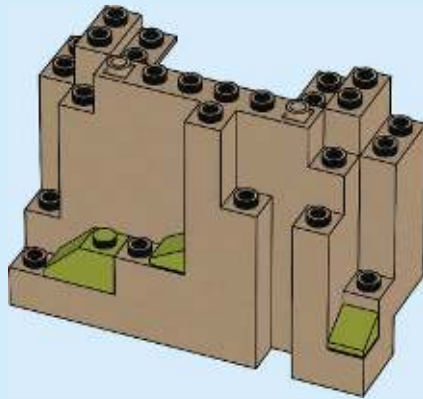

2

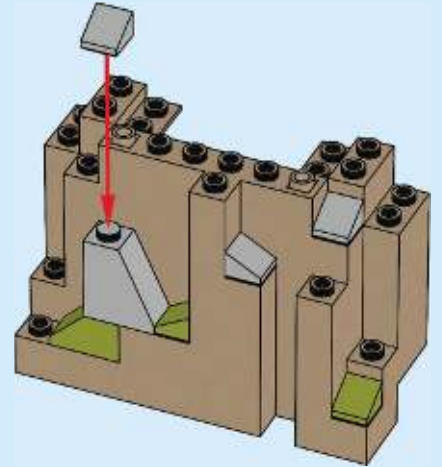

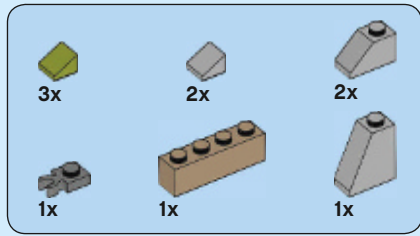

130

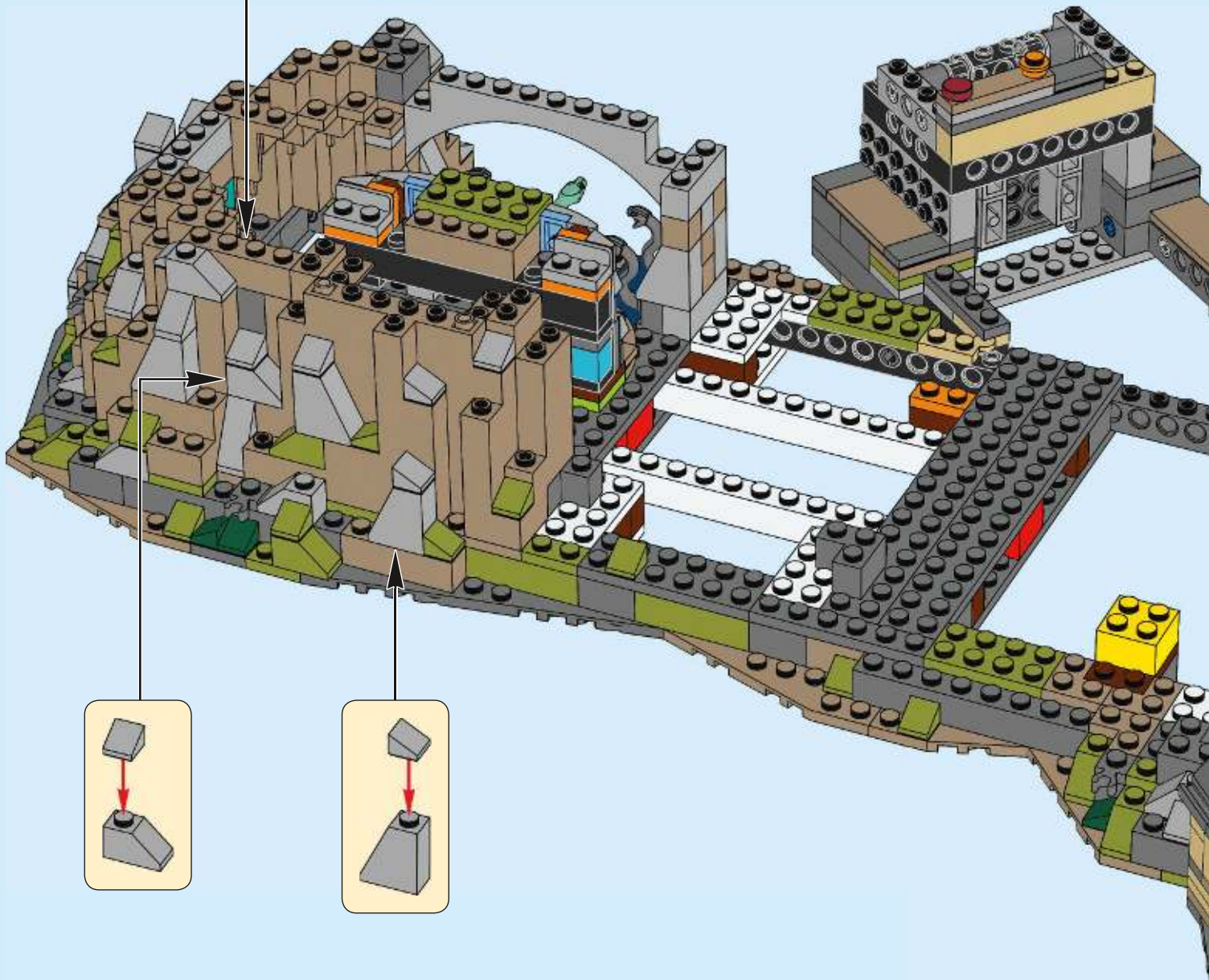
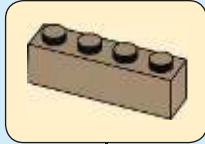

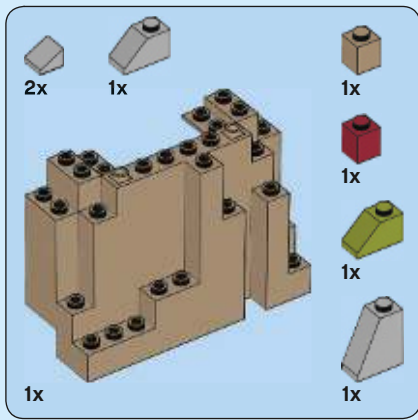

131

1

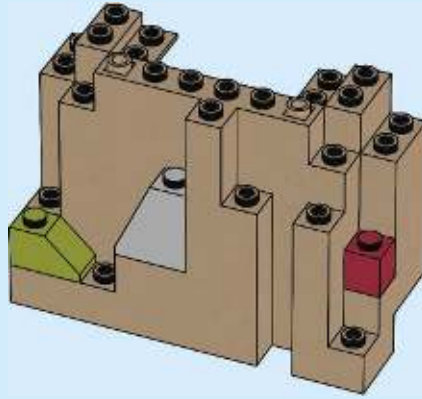

2

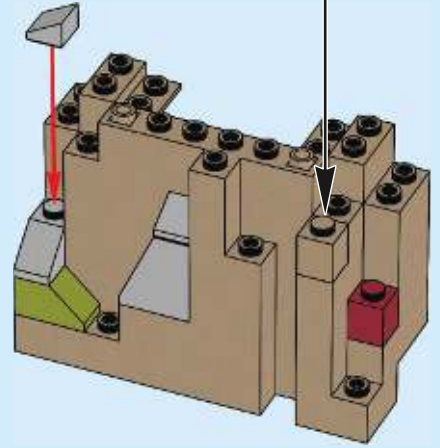

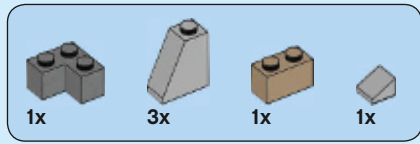

132



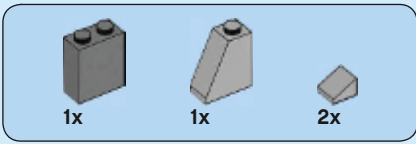

133



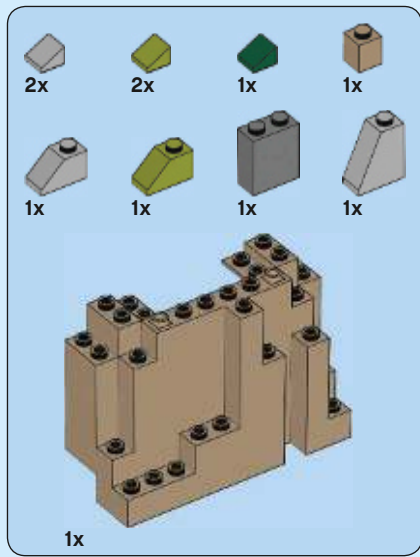

134

1

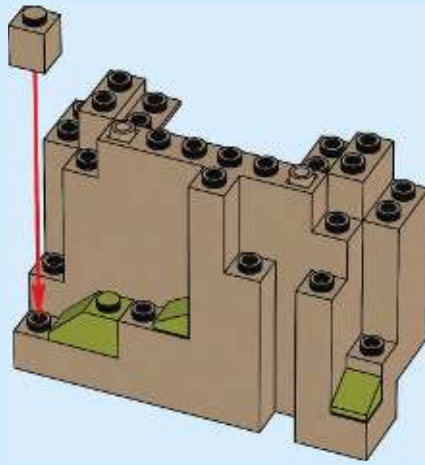

2

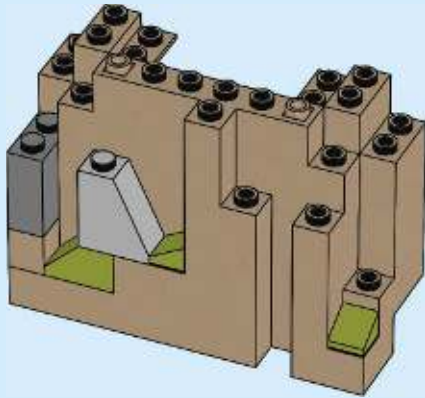

3

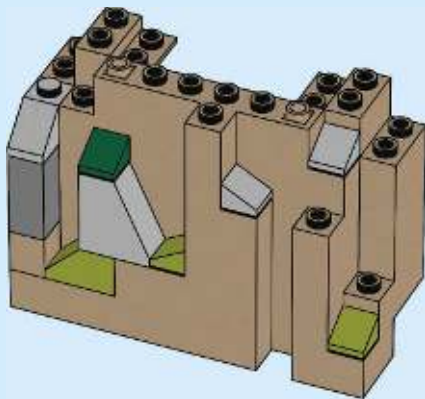

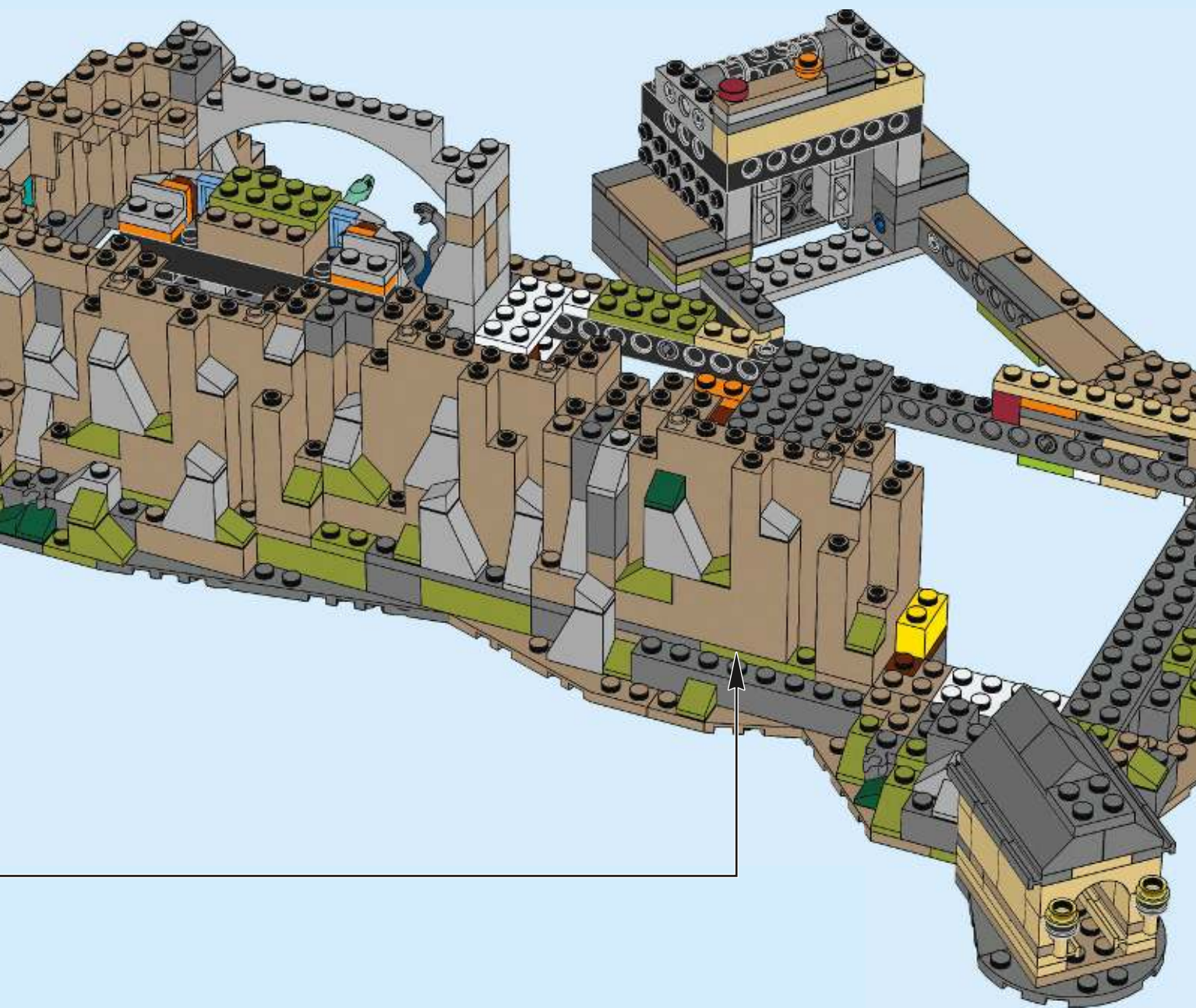

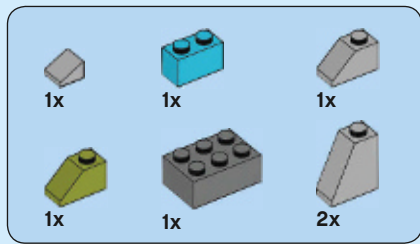

135





136

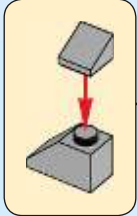
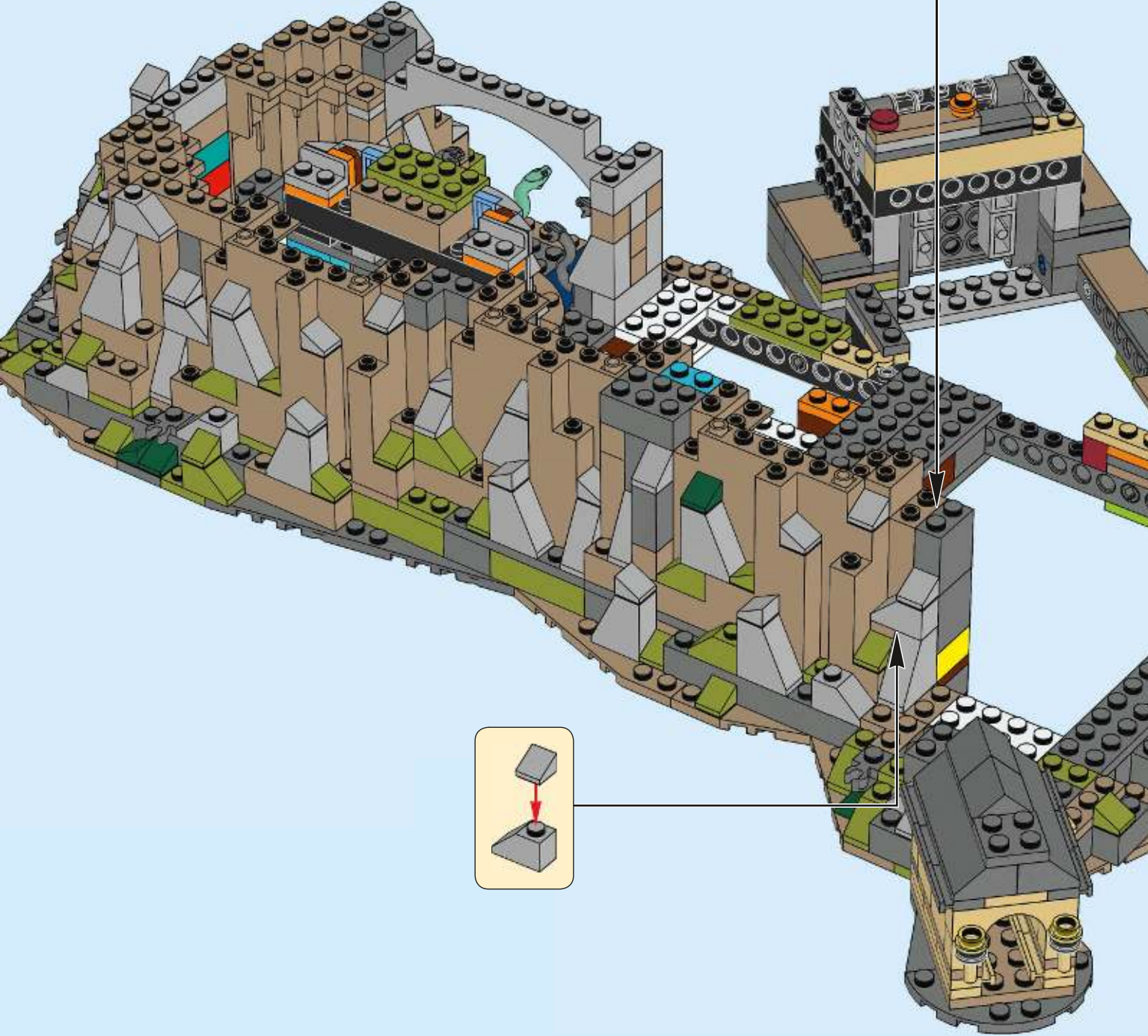
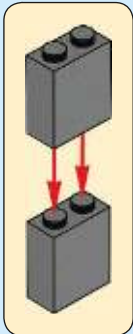

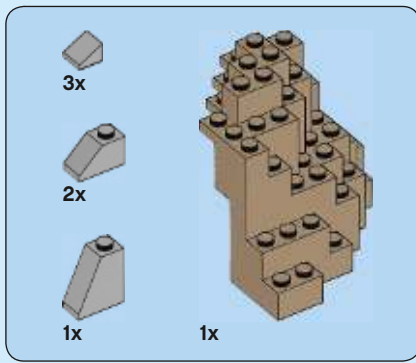

138

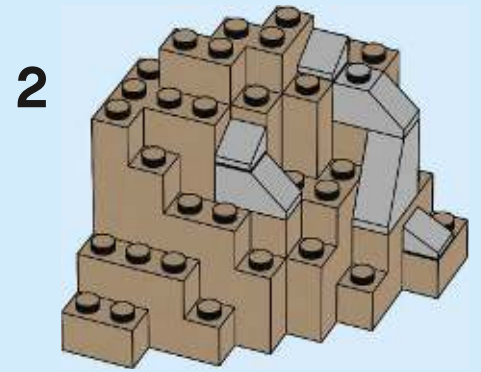
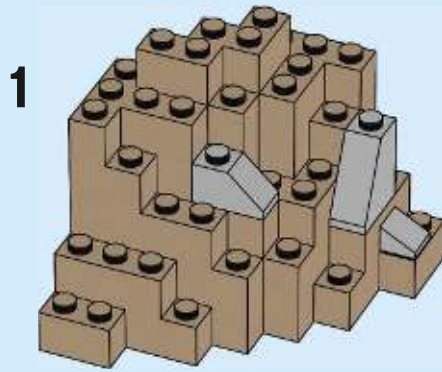

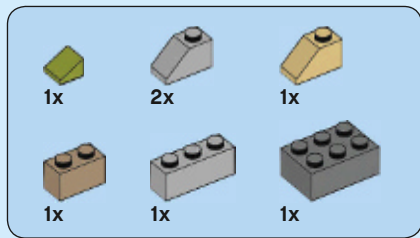

139

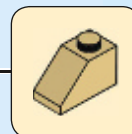
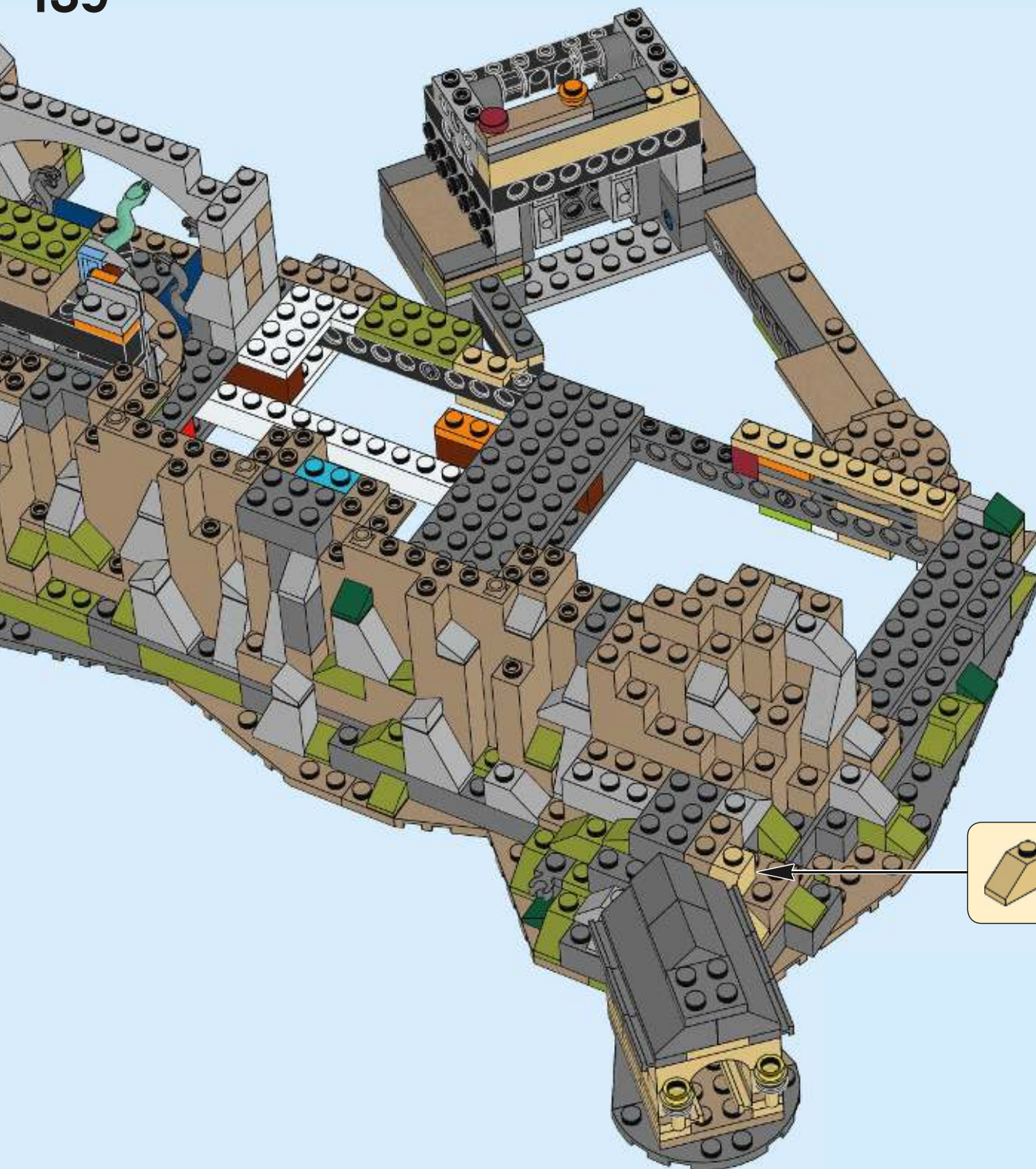

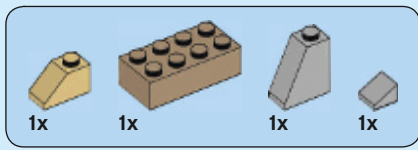

140



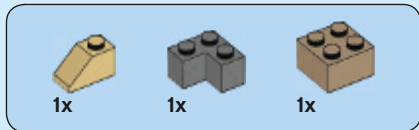

141



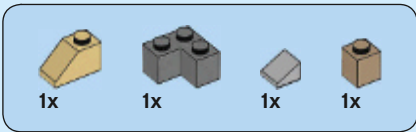

142



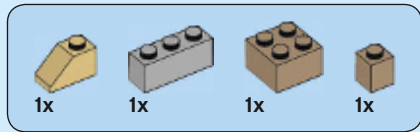

143

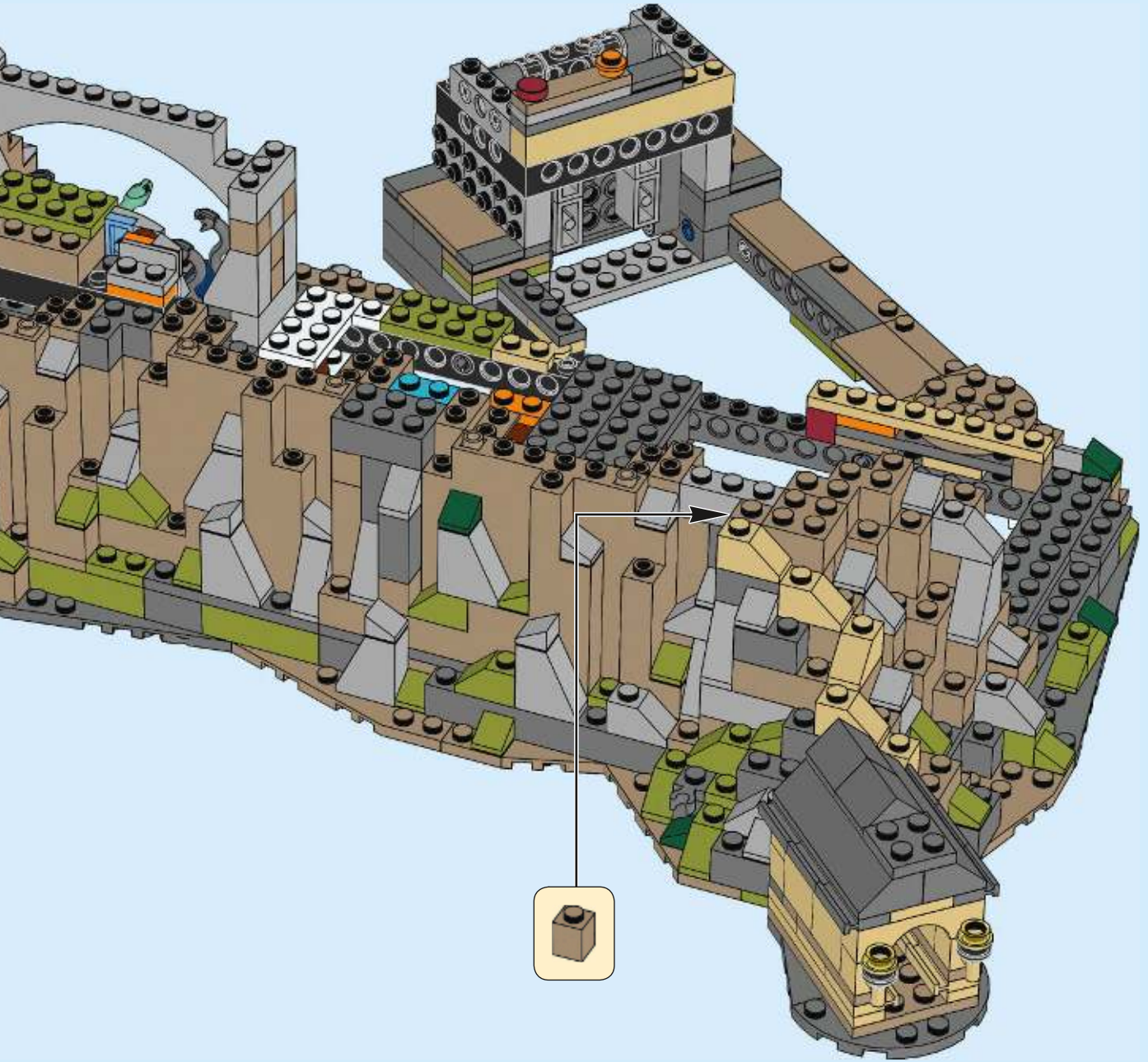

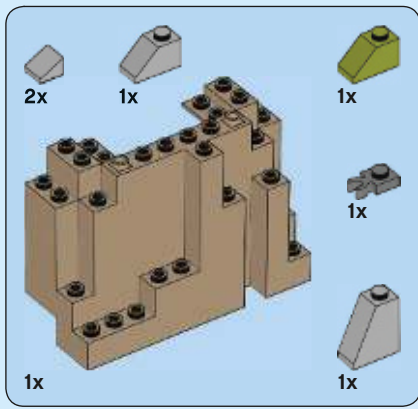

144

1

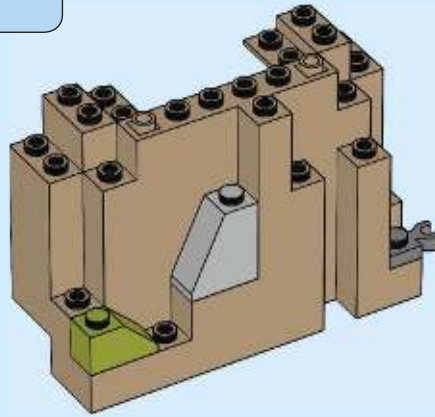

2

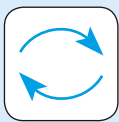
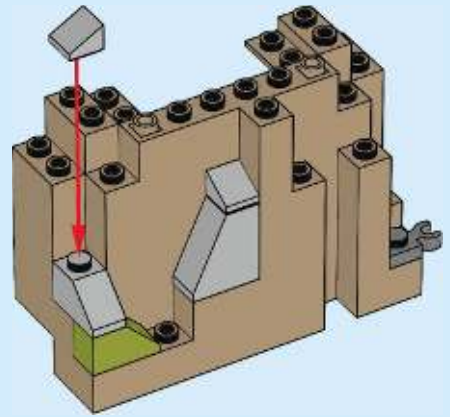

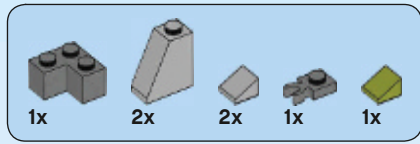

145

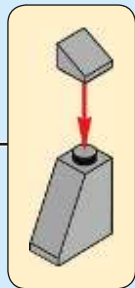
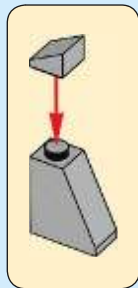

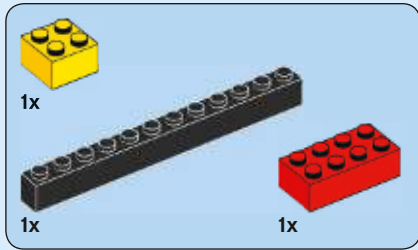

146

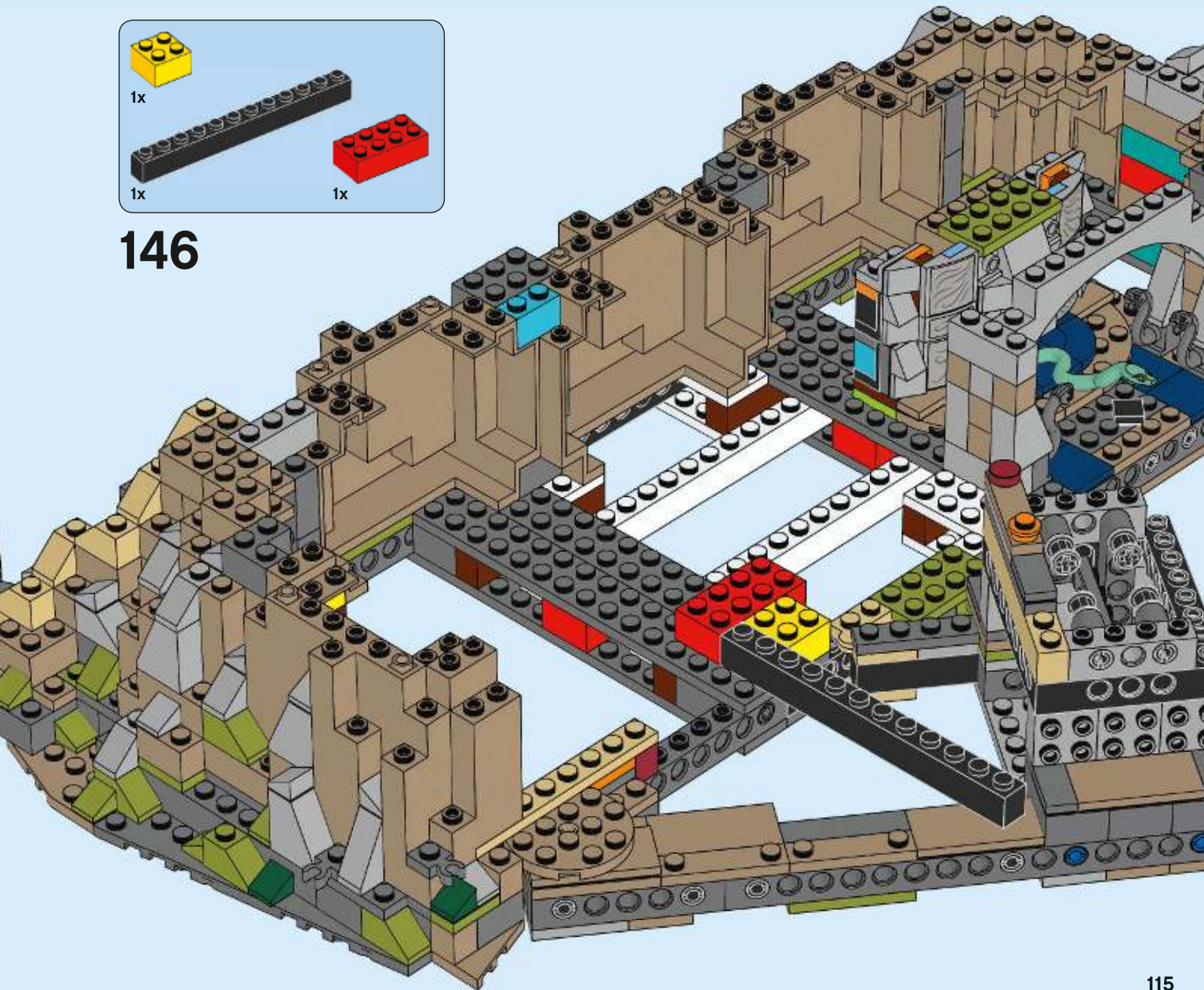

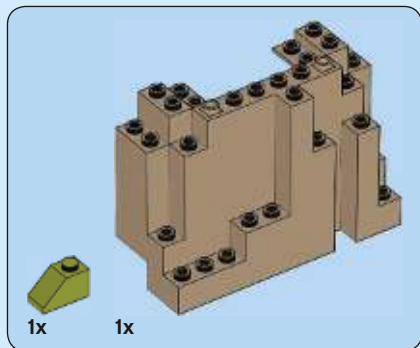

147

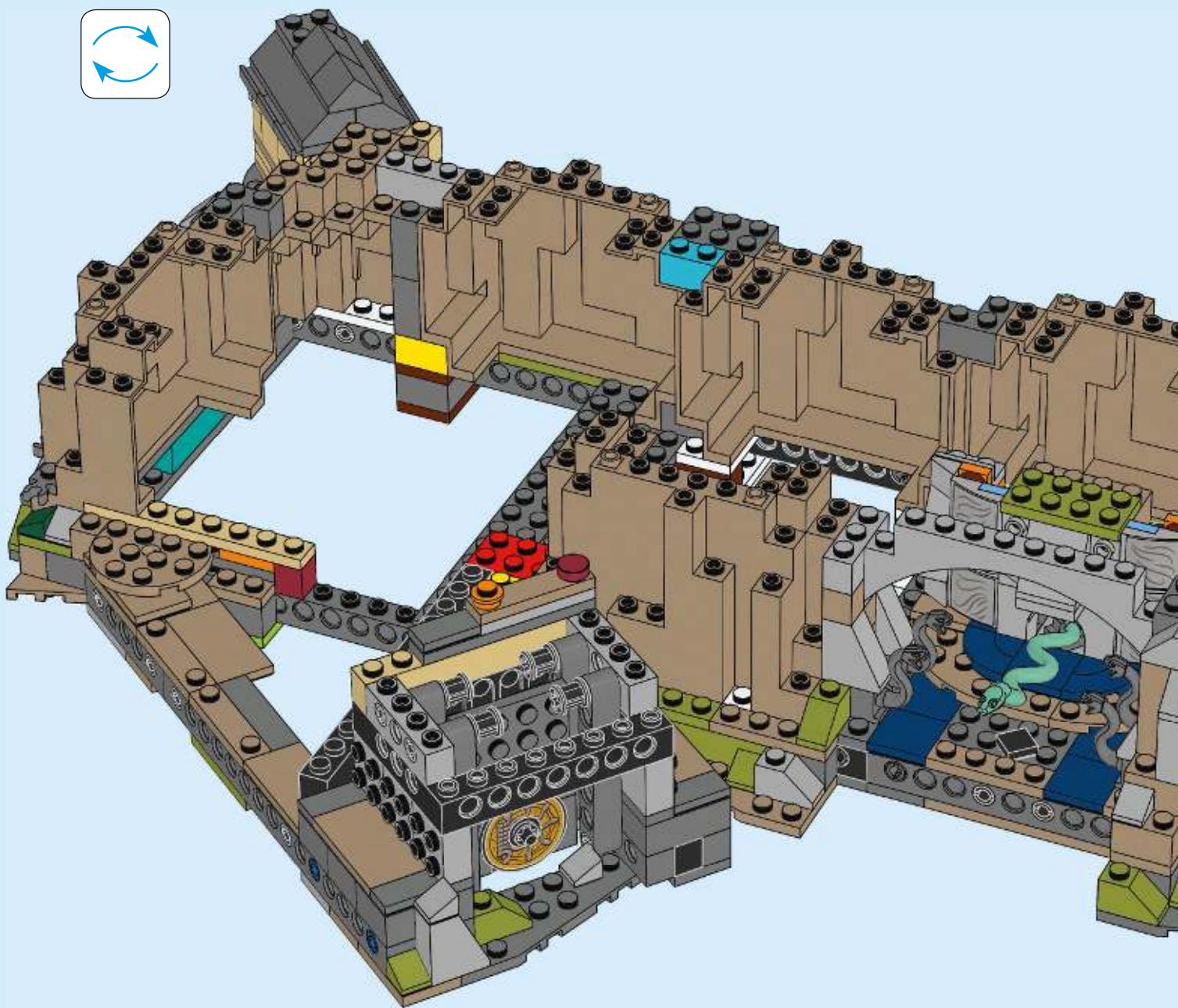
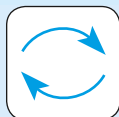

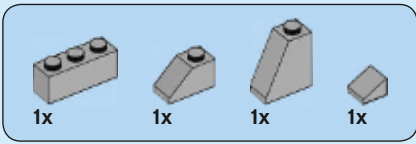

148

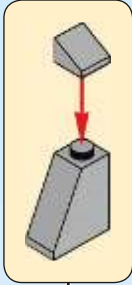

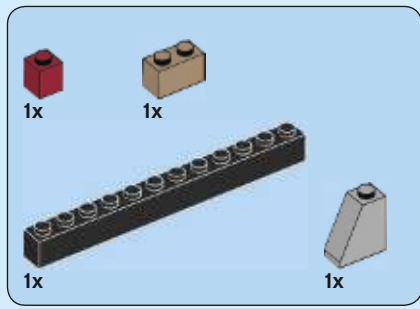

149

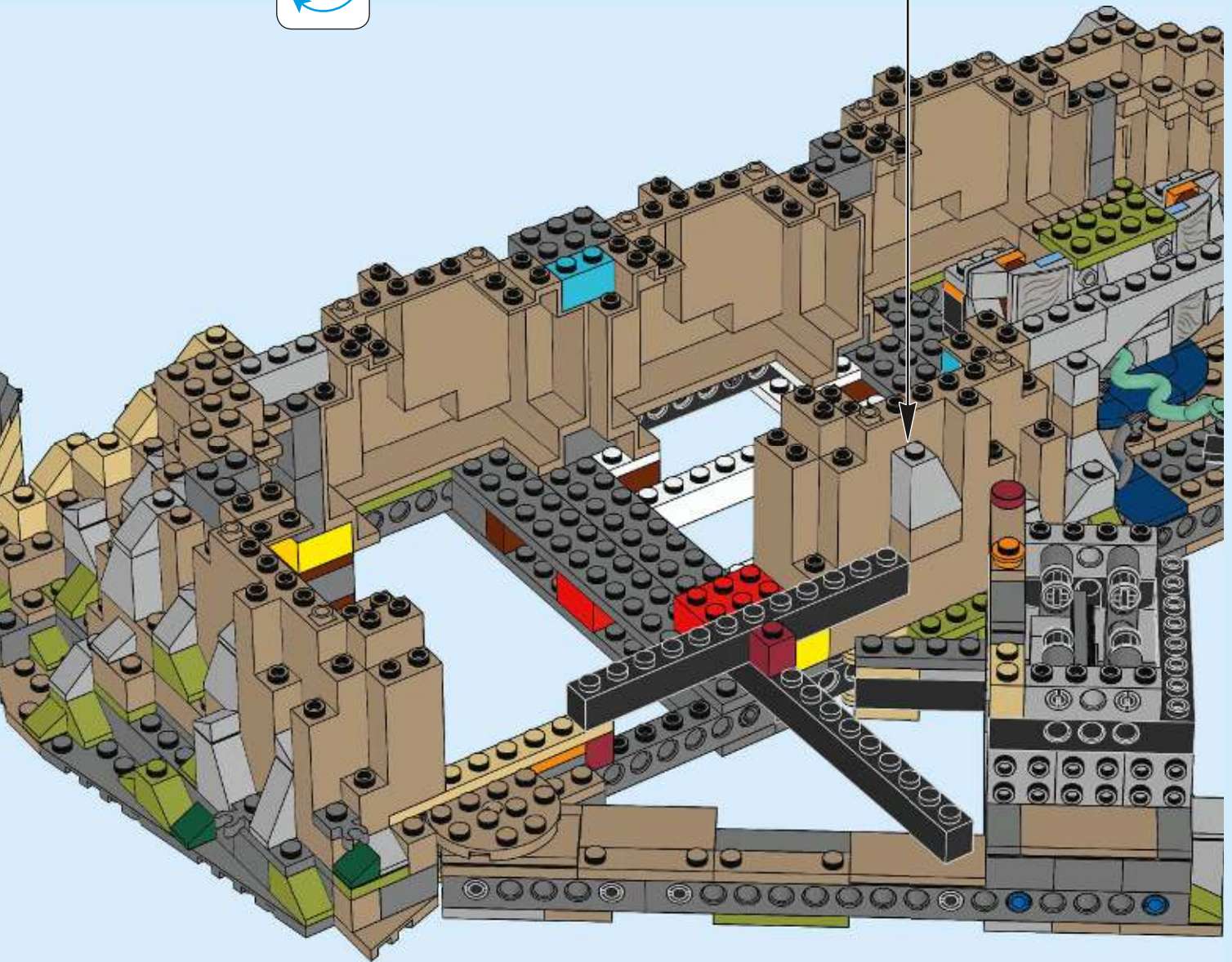
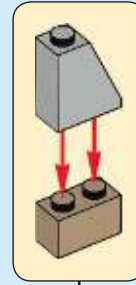
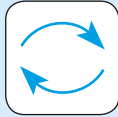



2x

150

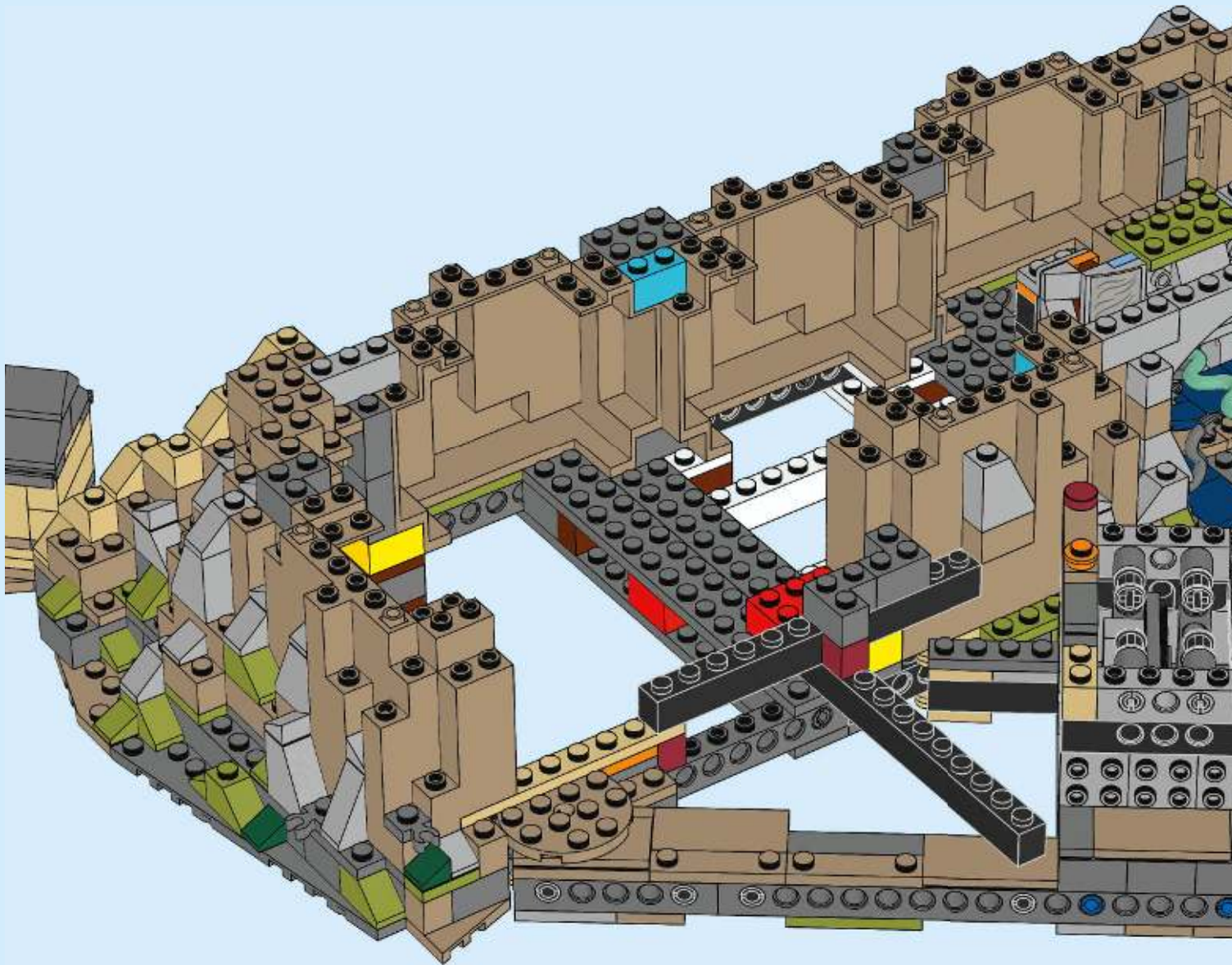

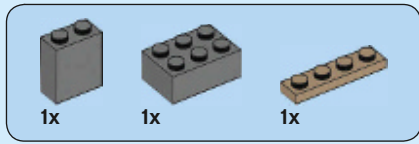

151

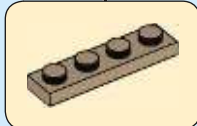
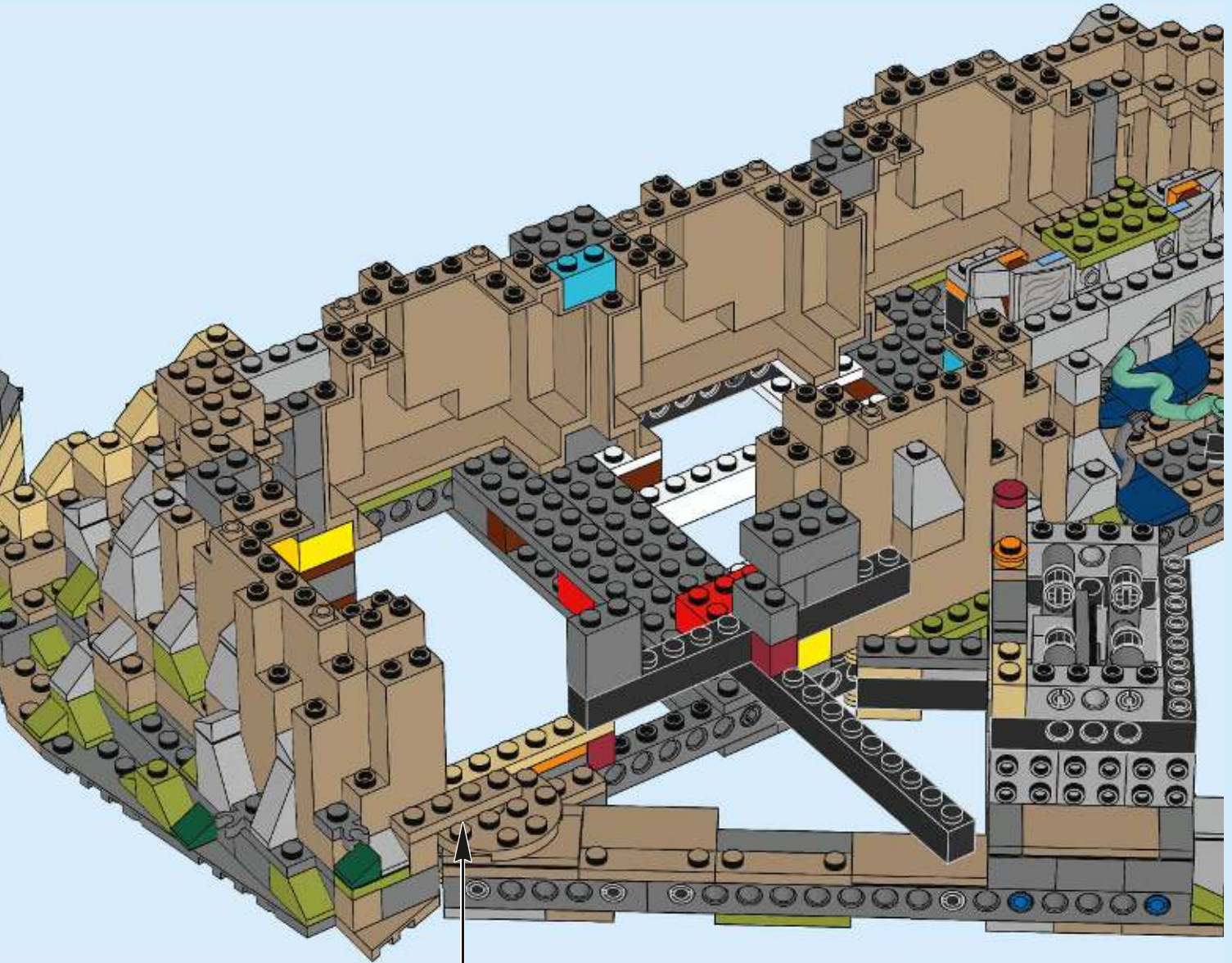

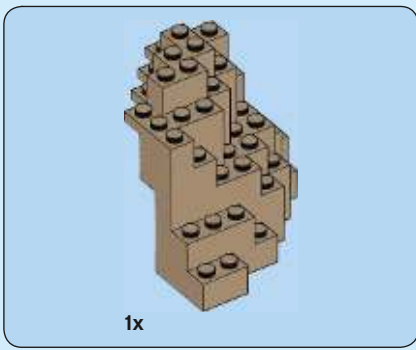

152



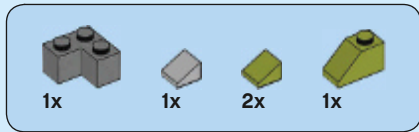

153

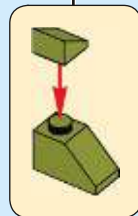

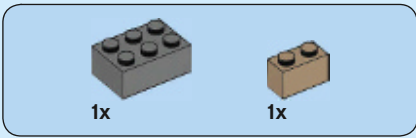

154



2x
1x
1x

155



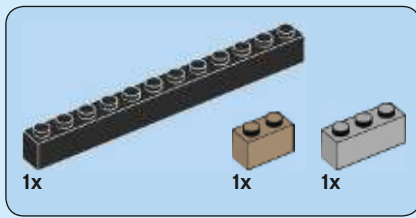

156



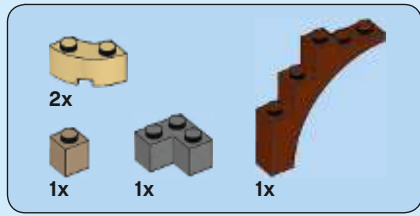

157



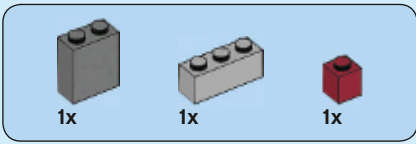

158



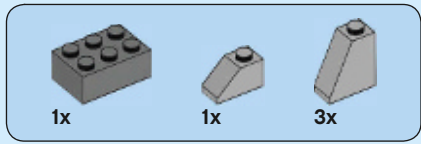

159



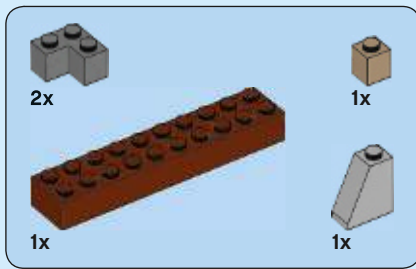

160



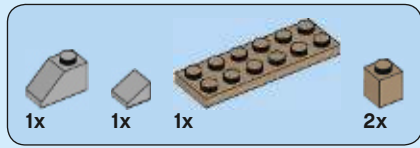

161



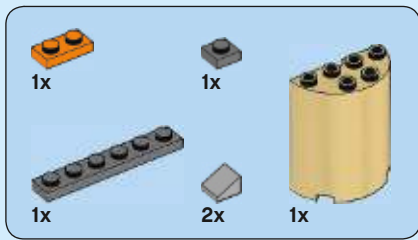

162



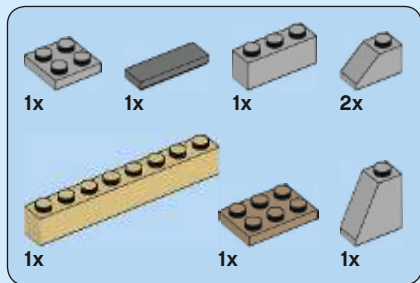

163

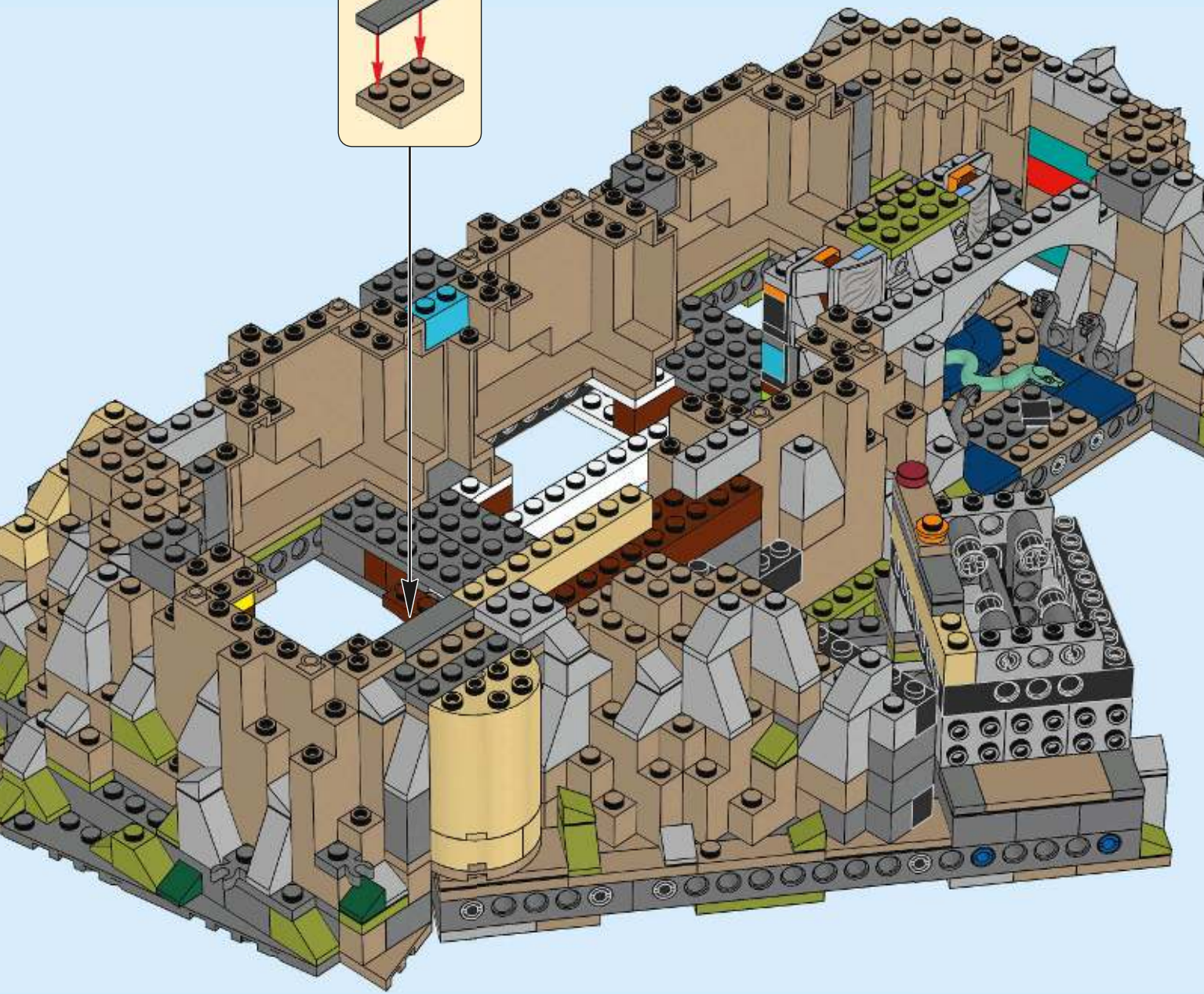
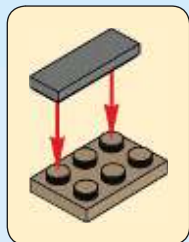

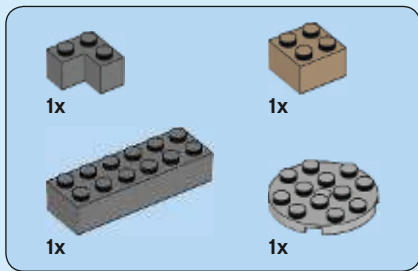

164

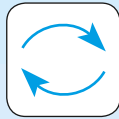

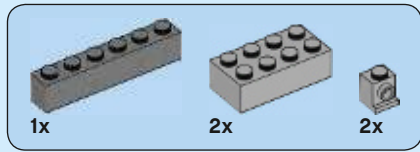

165



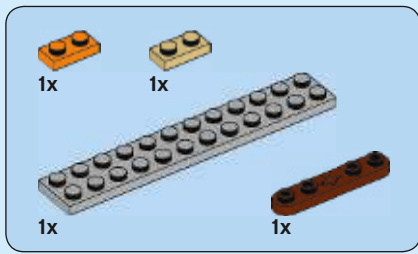

166

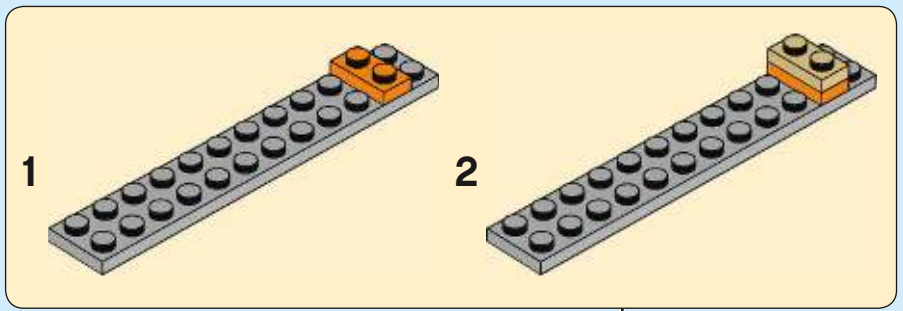

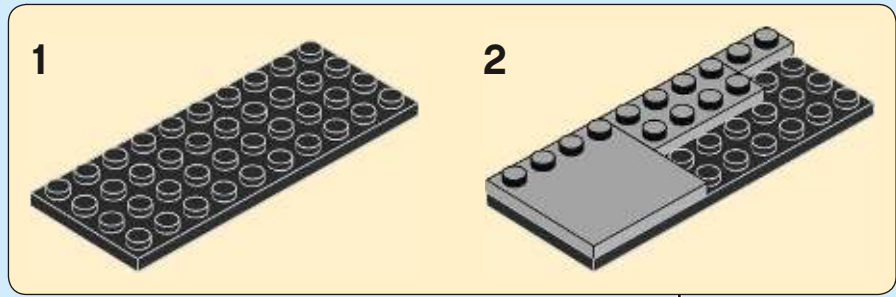
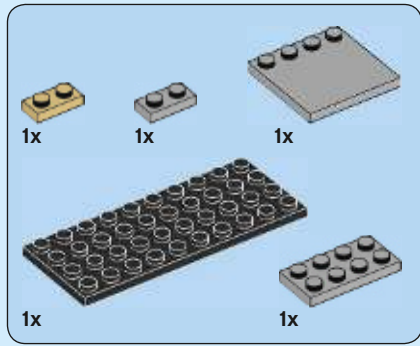

167



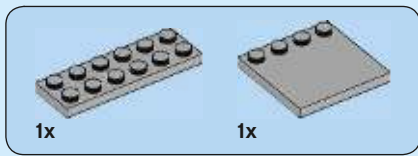

168



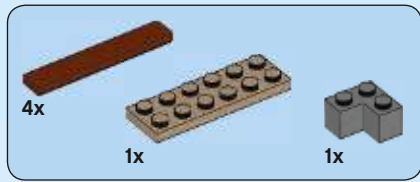

169

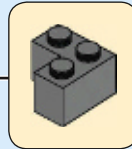



170

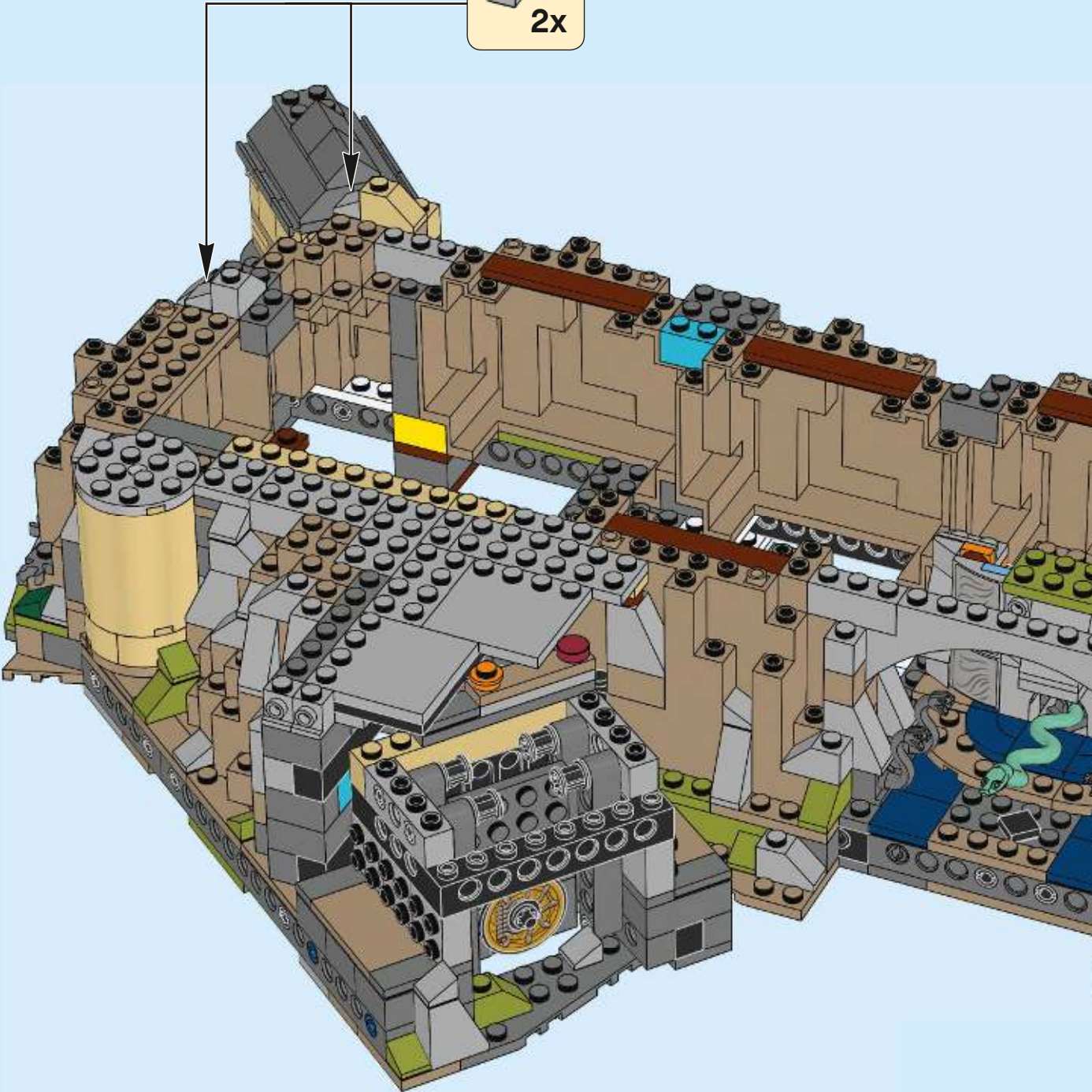
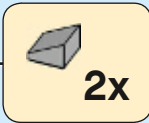

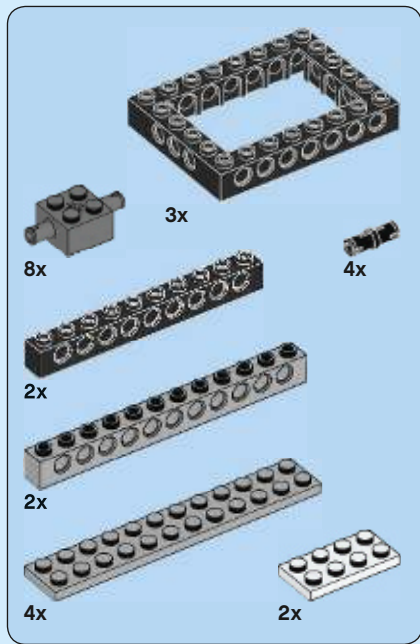

171

1

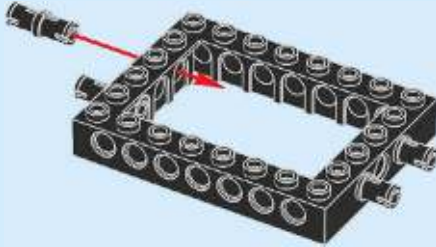

2

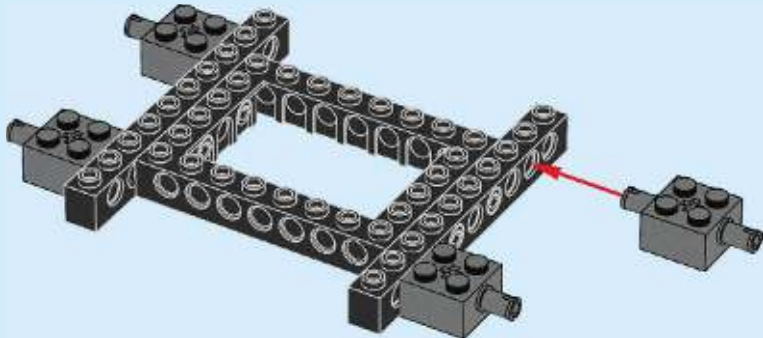

3

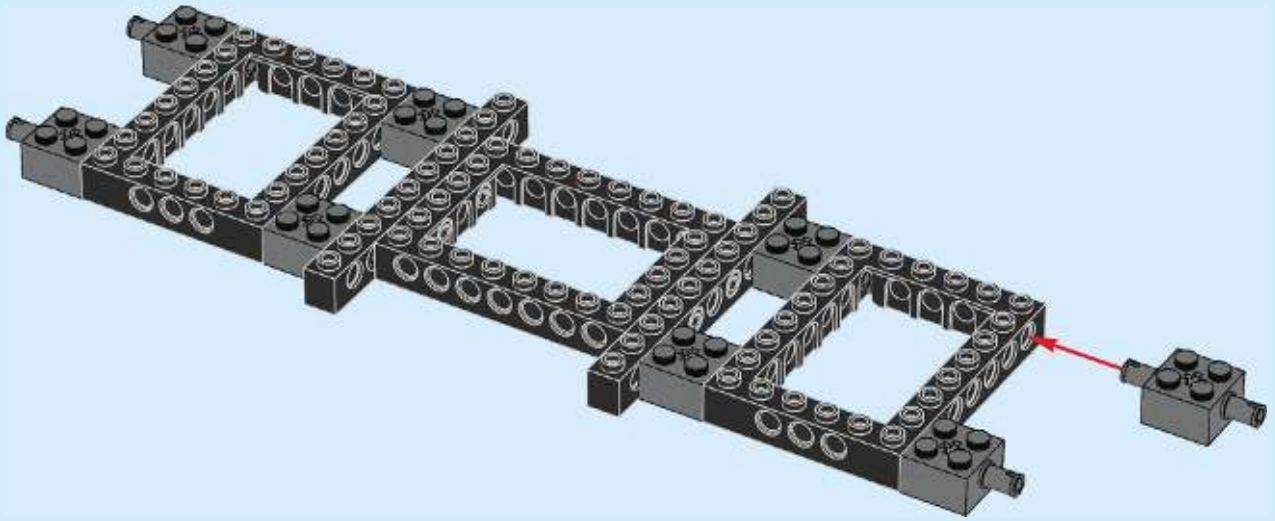

4

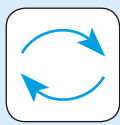
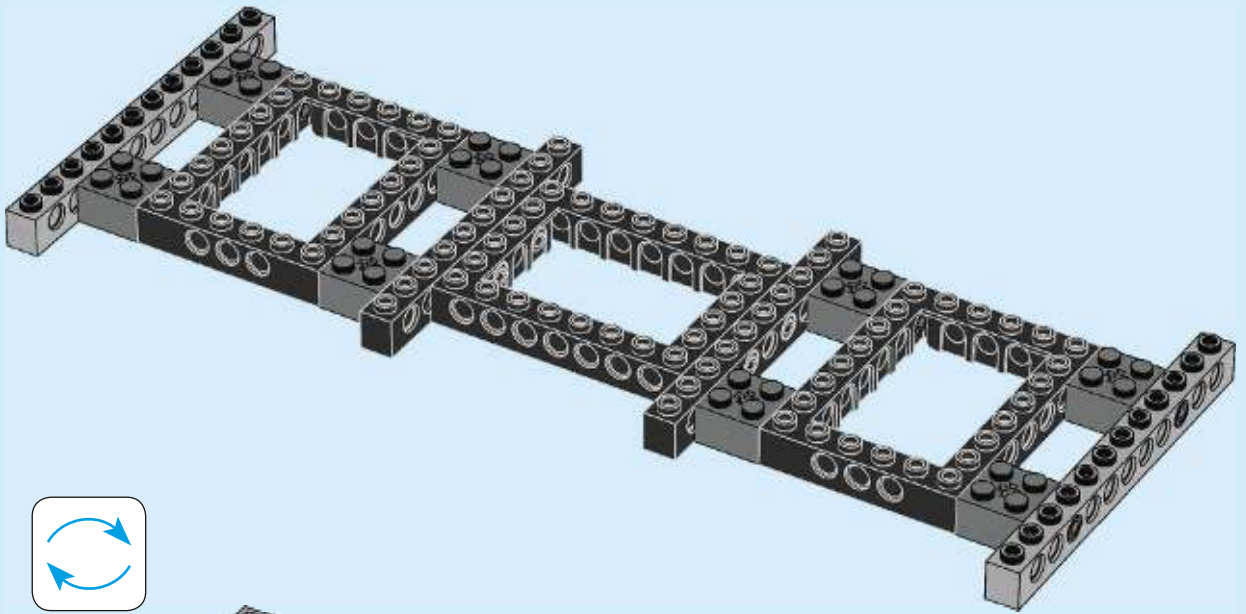

5

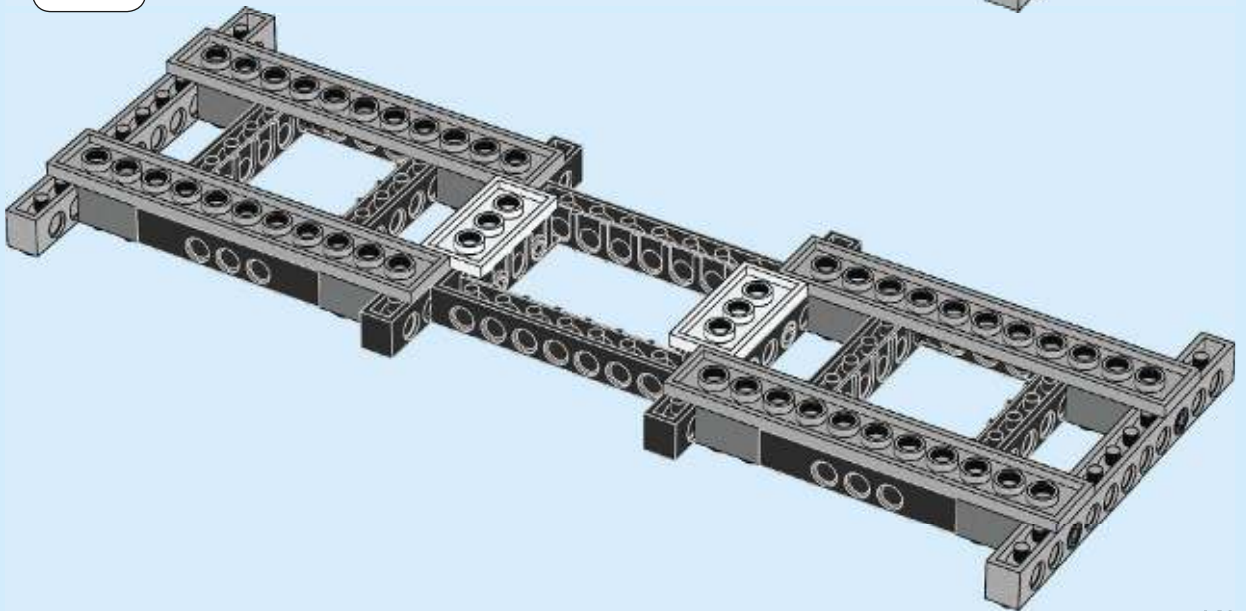



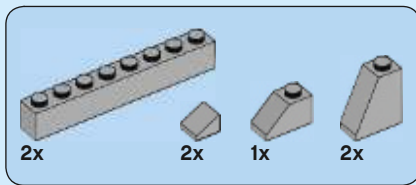

173





6x



4x



2x

174

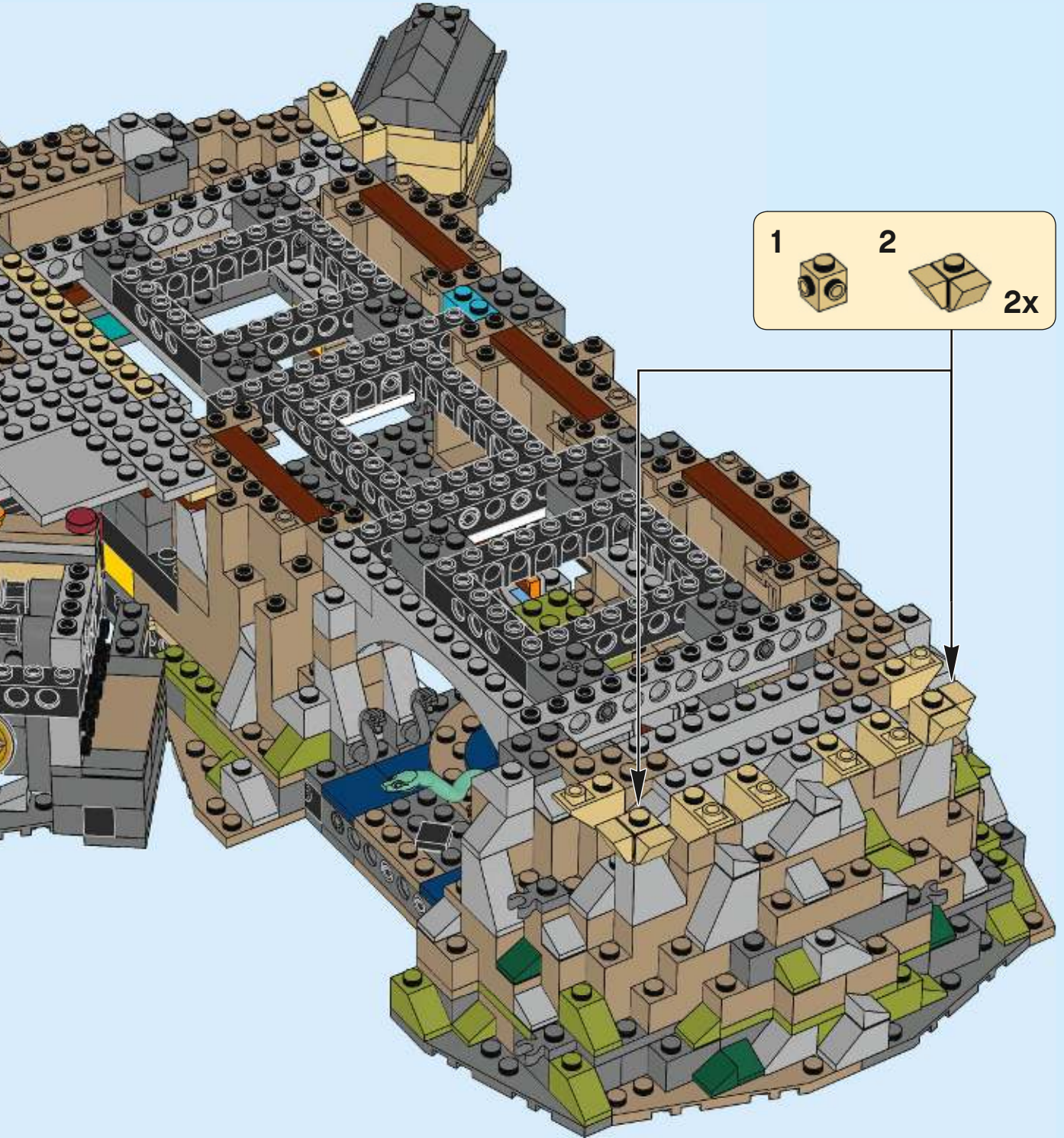

1



2



2x

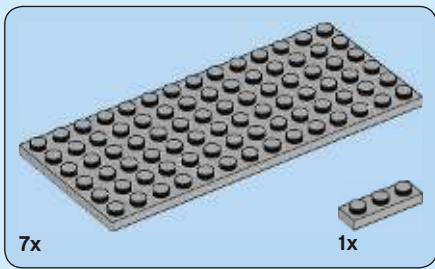

175

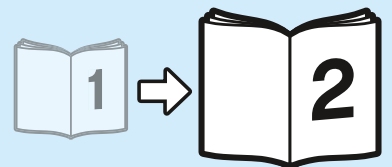
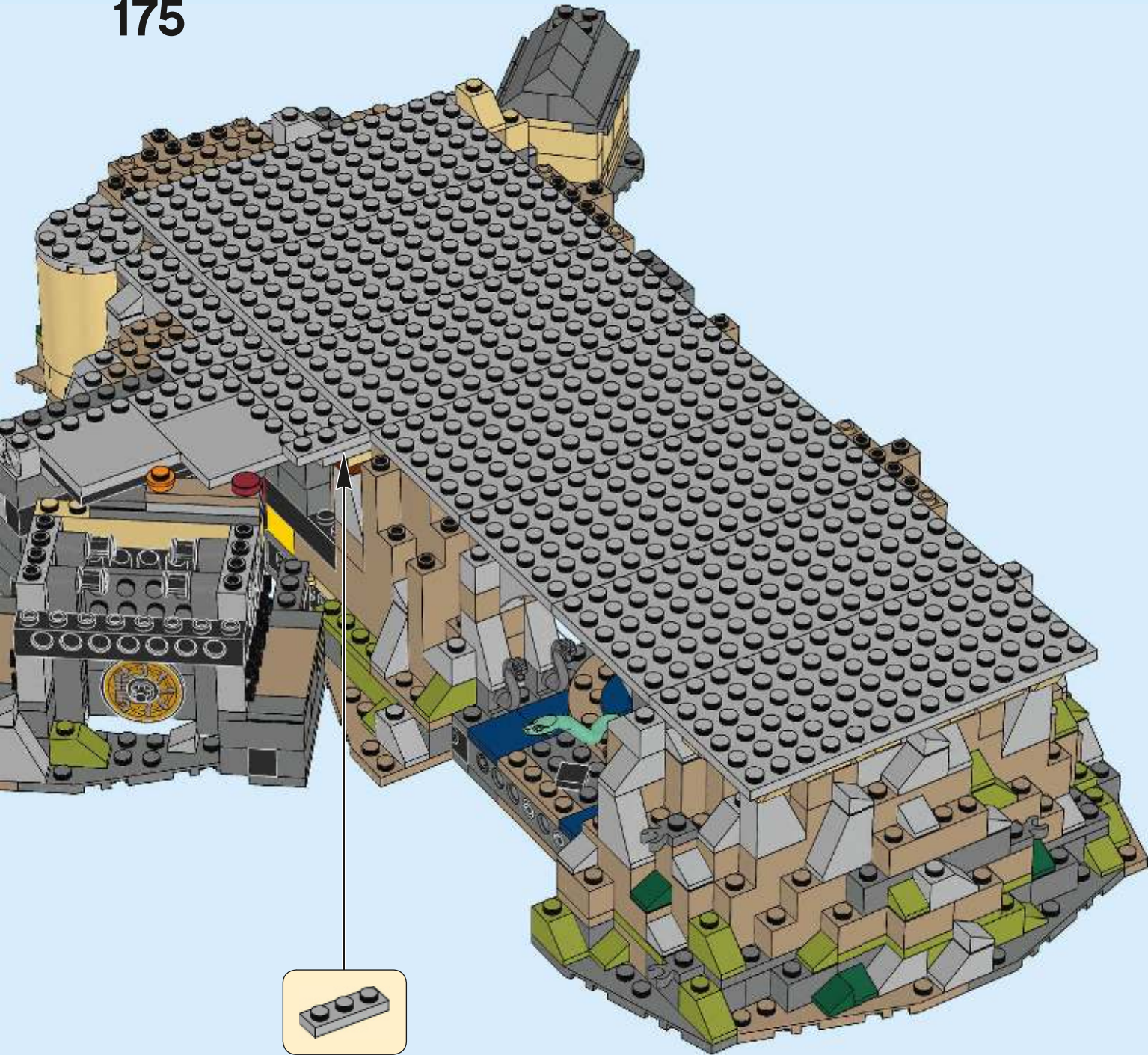

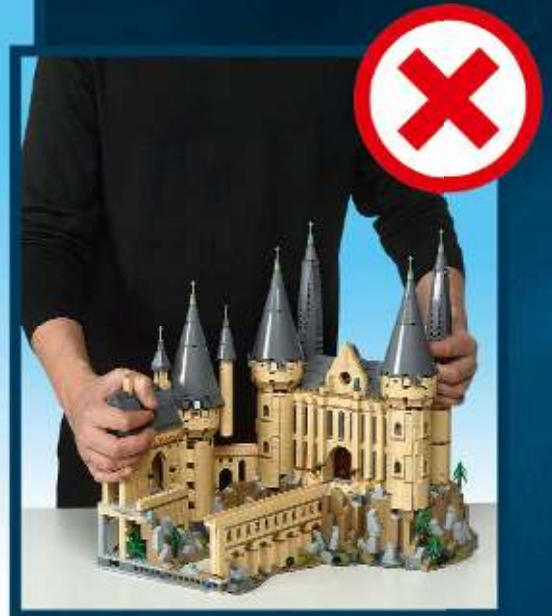



LEGO.com/life



WIN

GO TO WWW.LEGO.COM/PRODUCTFEEDBACK
AND GIVE US YOUR SHORT **FEEDBACK**
ABOUT THIS LEGO® SET FOR A CHANCE
TO WIN A COOL LEGO PRIZE.

Terms & Conditions apply



LEGO.com/productfeedback

GEWINNE

Erzähle uns auf
www.LEGO.com/productfeedback

etwas über die Erfahrungen, die du mit
diesem LEGO® Set gemacht hast, und
sichere dir die Chance auf einen coolen
LEGO Preis!

Es gelten die Teilnahmebedingungen

GAGNE

Rends-toi sur
www.LEGO.com/productfeedback

et donne-nous quelques commentaires
sur ce produit LEGO® pour avoir une
chance de gagner un prix LEGO !

Voir Conditions Générales

GANAN

Visita
www.LEGO.com/productfeedback

y envíanos tu opinión acerca de este
set LEGO®. ¡Participarás en el sorteo
de un premio LEGO!

Términos y Condiciones aplicables

获取奖品

登录
www.LEGO.com/productfeedback

给出关于此乐高®套装的简短反馈，
就有机会获得炫酷乐高奖品

《条款及条件》适用

경품 당첨 기회

www.LEGO.com/productfeedback

페이지로 이동하여 이 레고® 세트에 대한
간략한 피드백을 보내 주시고 멋진 레고
경품을 탈 수 있는 기회도 잡으십시오

약관 적용

ЗАПОЛНИ АНКЕТУ И ПОЛУЧИ ПРИЗ

Перейди по ссылке
www.LEGO.com/productfeedback

ответь всего на несколько вопросов
об этом наборе LEGO®, и у тебя появ-
ится шанс выиграть замечательный
приз от компании LEGO.

Применяются Условия и правила
участия



LEGO and the LEGO logo are trademarks of the LEGO Group. ©2018 The LEGO Group.
Anglia is a trademark owned and licensed by Ford Motor Company.
HARRY POTTER characters, names and related indicia are © & ™ Warner Bros. Entertainment Inc. WB SHIELD: © & ™ WBEI.
WIZARDING WORLD trademark and logo © & ™ Warner Bros. Entertainment Inc.
Publishing Rights © JKR. (s18)

6252747