



Multi-View KVMP™ Switch User Manual



Preface

EMC Information

FEDERAL COMMUNICATIONS COMMISSION INTERFERENCE STATEMENT: This equipment has been tested and found to comply with the limits for a Class A digital device, pursuant to Part 15 of the FCC Rules. These limits are designed to provide reasonable protection against harmful interference when the equipment is operated in a commercial environment. This equipment generates, uses, and can radiate radio frequency energy and, if not installed and used in accordance with the instruction manual, may cause harmful interference to radio communications. Operation of this equipment in a residential area is likely to cause harmful interference in which case the user will be required to correct the interference at his own expense.

The device complies with Part 15 of the FCC Rules. Operation is subject to the following two conditions: (1) this device may not cause harmful interference, and (2) this device must accept any interference received, including interference that may cause undesired operation.

FCC Caution: Any changes or modifications not expressly approved by the party responsible for compliance could void the user's authority to operate this equipment.

Warning: Operation of this equipment in a residential environment could cause radio interference.

KCC Statement

유선 제품용 / A 급 기기 (업무용 방송 통신 기기)
이 기기는 업무용 (A 급) 전자파적합기기로서 판매자 또는 사용자는 이 점을 주의하시기 바라며 , 가정 외의 지역에서 사용하는 것을 목적으로 합니다 .

RoHS

This product is RoHS compliant.



User Information

Online Registration

Be sure to register your product at our online support center:

International	http://eservice.aten.com
---------------	---

Telephone Support

For telephone support, call this number:

International	886-2-8692-6959
China	86-400-810-0-810
Japan	81-3-5615-5811
Korea	82-2-467-6789
North America	1-888-999-ATEN ext 4988 1-949-428-1111

User Notice

All information, documentation, and specifications contained in this manual are subject to change without prior notification by the manufacturer. The manufacturer makes no representations or warranties, either expressed or implied, with respect to the contents hereof and specifically disclaims any warranties as to merchantability or fitness for any particular purpose. Any of the manufacturer's software described in this manual is sold or licensed *as is*. Should the programs prove defective following their purchase, the buyer (and not the manufacturer, its distributor, or its dealer), assumes the entire cost of all necessary servicing, repair and any incidental or consequential damages resulting from any defect in the software.

The manufacturer of this system is not responsible for any radio and/or TV interference caused by unauthorized modifications to this device. It is the responsibility of the user to correct such interference.

The manufacturer is not responsible for any damage incurred in the operation of this system if the correct operational voltage setting was not selected prior to operation. PLEASE VERIFY THAT THE VOLTAGE SETTING IS CORRECT BEFORE USE.

Package Contents

The CM1164A package consists of:

- ◆ 1 CM1164A 4-Port USB DVI-D Multi-View KVM[™] Switch
- ◆ 4 KVM Cables (DVI-D, USB, Audio)
- ◆ 1 Power Cord
- ◆ 1 IR Remote Control
- ◆ 1 Rack Mount Kit
- ◆ 1 User Instructions*

The CM1284 package consists of:

- ◆ 1 CM1284 4-Port USB HDMI Multi-View KVM[™] Switch
- ◆ 4 KVM Cables (HDMI, USB, Audio)
- ◆ 1 Power Cord
- ◆ 1 IR Remote Control
- ◆ 1 Rack Mount Kit
- ◆ 1 User Instructions*

Check to make sure that all the components are present and that nothing got damaged in shipping. If you encounter a problem, contact your dealer.

Read this manual thoroughly and follow the installation and operation procedures carefully to prevent any damage to the unit, and/or any of the devices connected to it.

* Features may have been added to the Multi-View KVM[™] Switch since this manual was printed. Please visit our website to download the most up-to-date version.

© Copyright 2018 ATEN® International Co., Ltd.
Manual Date: 2018-11-06

ATEN and the ATEN logo are registered trademarks of ATEN International Co., Ltd. All rights reserved.
All other brand names and trademarks are the registered property of their respective owners.

Contents

Preface

EMC Information	ii
User Information	iii
Online Registration	iii
Telephone Support	iii
User Notice	iii
Package Contents	iv
Contents	v
About this Manual	ix
Conventions	x
Product Information	x

1. Introduction

Overview	1
Features	3
Requirements	5
Operating Systems	6
Optional Equipment	6
Components	7
CM1164A / CM1284 Front View	7
CM1164A Rear View	9
CM1284 Rear View	10
IR Remote Control	11

2. Hardware Setup

Rack Mounting	13
Grounding	15
Installation	16
CM1164A	16
Single Station Installation	16
Single Station Installation Diagram	17
Daisy Chain Installation Diagram	19
Cascade Installation Diagram	21
CM1284	22
Single Station Installation	22
Single Station Installation Diagram	23
Daisy Chain Installation Diagram	25
Cascade Installation Diagram	27

3. Basic Operation

Overview	29
Identifying the Source Device	29

Switching 30	
Manual Switching	30
LED Display	31
Hotkey Switching	32
Remote Switching	32
OSD Switching	33
Display Modes	35
Full Screen	35
Quad View	37
Picture in Picture - Dual	38
Picture in Picture - Triple	39
Picture in Picture - Quad	40
Picture on Picture	41
Picture by Picture - Dual	42
Picture by Picture - Triple	43
Picture by Picture - Quad	44
Preset Configuration	45

4. Hotkey Operation

Open the OSD Menu	47
The Hotkey Setting Mode	48
Hotkeys List	49
Auto Scanning	52
Auto Scanning - Display Modes	52

5. OSD Operation

Overview	53
The Quick Access Toolbar	53
The Editor Mode	55
The OSD Menu	57
Password Protection	57
Accessing the OSD Menu	58

6. RS-232 Operation

Overview	63
Setup	63
RS-232 Commands	65
Verification Messages	65
Log In	66
Logout	67
Open/Close RS-232 Link	68
Switch Port	69
PiP Mode	70
Quad View Mode	71
Change Display Mode	72
Port Disable	73

OSD Language	74
Keyboard Language Layout	75
Set Operating System	76
Auto Scan	77
Port ID Display	78
Security	79
Formula:.....	79
Station	80
DCC Control	81
Mouse Emulation	82
Keyboard Emulation	83
Video DynaSync	84
Hardware Cursor	85
Activate Beeper	86
Hotkey Setting	87
OSD Hotkey	88
Power on Detection	89
Fn Key	90
USB Reset	91
Restore Default Value	92
Firmware Upgrade	93
KVM Status	94
Hotkey List	95
Info	96

7. System Maintenance

Firmware Upgrades	97
Backup / Restore	100
Powering Off and Restarting	103
Restoring to Default Settings	103

Appendix

Safety Instructions	105
General	105
Rack Mounting	107
Technical Support	108
International	108
North America	108
Specifications	109
Troubleshooting	111
Fn Key Reference	112
Mac Keyboard Emulation	113
Sun Keyboard Emulation	114
Factory Default Hotkeys and Settings	115
Limited Warranty	116

About this Manual

This User Manual is provided to help you get the most from your system. It covers all aspects of installation, configuration, and operation for the following models of the Multi-View KVMP™ Switch:

Model	Product Name
CM1164A	4-Port USB DVI-D Multi-View KVMP™ Switch
CM1284	4-Port USB HDMI Multi-View KVMP™ Switch

An overview of the information found in the manual is provided below.

Chapter 1, Introduction, introduces you to the Multi-View KVMP™ Switch. Its purpose, features and benefits are presented, and its front and back panel components are described.

Chapter 2, Hardware Setup, describes how to set up your installation. Diagrams showing the necessary steps are provided.

Chapter 3, Basic Operation, explains the fundamental concepts involved in operating the Multi-View KVMP™ Switch.

Chapter 4, Keyboard Port Operation, details all of the concepts and procedures involved in the hotkey operation of your Multi-View KVMP™ Switch.

Chapter 5, OSD Operation, provides a complete description of the Multi-View KVMP™ Switch's On-Screen Display (OSD), and how to work with it.

Chapter 6, RS-232 Commands, provides details on the functions and RS-232 commands that you can use to control the Multi-View KVMP™ Switch using a serial controller.

Chapter 7, Maintenance, provides step-by-step information on firmware upgrades, restoring the device default, and how to safely restart your Multi-View KVMP™ Switch.

An Appendix, provides specifications and other technical information regarding the Multi-View KVMP™ Switch.

Conventions

This manual uses the following conventions:

- | | |
|---|--|
| Monospaced | Indicates text that you should key in. |
| [] | Indicates keys you should press. For example, [Enter] means to press the Enter key. If keys need to be chorded, they appear together in the same bracket with a plus sign between them: [Ctrl+Alt]. |
| 1. | Numbered lists represent procedures with sequential steps. |
| ◆ | Bullet lists provide information, but do not involve sequential steps. |
| → | Indicates selecting the option (on a menu or dialog box, for example), that comes next. For example, Start → Run means to open the <i>Start</i> menu, and then select <i>Run</i> . |
|  | Indicates critical information. |

Product Information

For information about all ATEN products and how they can help you connect without limits, visit ATEN on the Web or contact an ATEN Authorized Reseller. Visit ATEN on the Web for a list of locations and telephone numbers:

International	http://www.aten.com
North America	http://www.aten-usa.com

Chapter 1

Introduction

Overview

The Multi-View KVMP™ Switch charts a revolutionary new direction in KVM switch functionality by combining a 4-port DVI-D (CM1164A) / 4-port HDMI (CM1284) with a 2-port USB hub, and providing different display modes, including Quad View mode, Picture in Picture mode (Dual, Triple, or Quad), Picture by Picture mode (Dual, Triple, or Quad), Picture on Picture mode, and Full Screen mode. Control and switch between computers/video sources is versatile using the front-panel pushbuttons, IR remote control, On-Screen Display (OSD), RS-232 commands, or through hotkey combinations entered from the console keyboard.

The Multi-View KVMP™ Switch allows users to access 4 computers/devices from a single console, consisting of a USB keyboard, USB mouse, and DVI-D (CM1164A) or HDMI (CM1284) monitor. With the CM1284, you can connect up to two monitors – one acts as the main control and supports all the display modes, and the other acts as a secondary display that only shows a channel selected from the main monitor in full-screen mode. Video switching for the second monitor is easy with Boundless Switching which allows you to switch channels simply by moving the console mouse to the desired channel on the main display.

As a USB hub, the Multi-View KVMP™ Switch permits each computer to access connected peripherals on a one-computer-at-a-time basis. The Multi-View KVMP™ Switch's independent switching feature allows the KVM focus to be on one computer while the USB peripheral focus is on another. There is no need to purchase a separate USB hub, as well as separate stand-alone peripheral sharers.

The Multi-View KVMP™ Switch further improves on previous designs with DVI-D (CM1164A) or HDMI (CM1284) connectors, and the transfer of keyboard and mouse data to the computers via a fast, reliable USB connection. As with the USB peripherals, the audio focus can be independent of the KVM focus.

A Daisy Chain Control (DCC) port allows the user to connect and control up to four Multi-View KVMP™ Switches via a single set of keyboard and mouse. This enables the use of only one keyboard/mouse over several computers by switching the console keyboard and mouse focus to the monitor of each secondary station. This is convenient for growing networks that need to monitor and manage more computers – daisy chain up to four units and switch between up to 16 computers/video sources. You can also choose to have all sources displayed on one monitor by cascading, where CM1164A/CM1284 units are connected to one another via its KVM Ports. In a cascade setup, you can control and monitor up to 16 computers (4 additional Multi-View KVMP™ Switches) using a single console.

Setup is fast and easy; simply plug cables into their appropriate ports. There is no software to configure, no installation routines, and no incompatibility problems. Since the Multi-View KVMP™ Switch intercepts keyboard input directly, it works on Microsoft Windows, Linux, Sun and Mac platforms.

The Multi-View KVMP™ Switch improves operational efficiency for a wide range of practical applications, including control rooms, monitoring systems, and traffic control centers, as well as process control centers, server rooms, medical industries, broadcasting, production and automation, aircraft and vehicles. In combination with projectors, it is also used in presentations and conference rooms. Allowing you to switch seamlessly between four PCs, and share USB peripherals and audio (stereo audio for CM1164A; high-definition audio for CM1284), the Multi-View KVMP™ Switch is ideal for multimedia applications, and offers the ultimate in space-saving, streamlined KVM technology.

Features

- ◆ Multi-view modes allow users to view and control up to four video channels on one screen with display modes including Quad View, Picture in Picture (PiP), Picture by Picture (PbP), and Picture on Picture (PoP)
- ◆ The CM1284 supports dual video outputs on the console side. The primary monitor provides multi-view modes.
- ◆ Easy resizing and/or repositioning of PiP or PbP to suit users' viewing needs
- ◆ System configuration (display mode and KVM port selection) via the front panel, OSD, IR Remote control, and RS-232 commands
- ◆ Superior video quality – Up to 4K (4096 x 2160 @ 30 Hz) (CM1284 only)
- ◆ Drop-down menu – edit display windows and other functions with the console mouse and on-screen control panel
- ◆ KVM port selection via the front-panel pushbuttons, hotkeys, mouse, and RS-232 serial commands¹
- ◆ Boundless Switching – Simply moves the mouse cursor across windows to switch to other video sources
- ◆ Video DynaSync™ – exclusive ATEN technology that eliminates boot-up display problems and optimizes the resolution when switching among different sources
- ◆ EDID Expert™ – Selects optimum EDID settings for smooth power-up, high-quality display and use of the best video resolution across different screens
- ◆ DCC (Daisy Chain Control) – Controls up to 3 additional Multi-View KVMP™ Switches from a single console
- ◆ Cascade up to 2 levels – Controls up to 16 computers (with up to 4 x 4 multi-view mode)
- ◆ HDCP 1.4 compliant
- ◆ Console keyboard emulation / bypass feature that support most multimedia keyboards
- ◆ Console mouse port emulation / bypass feature that supports most mouse drivers and multifunction mice
- ◆ Independent switching for USB peripheral port, stereo audio (CM1164A), high-definition audio (CM1284) and KVM switch focus
- ◆ Power on detection

- ◆ Auto Scan feature
- ◆ Firmware upgradeable via computer's USB port
- ◆ Full base response that provides a rich experience for 2.0 channel audio
- ◆ Multilingual keyboard mapping – supports English, French, Japanese, and German keyboards
- ◆ Hot-pluggable
- ◆ Supports keyboard combinations via emulation (for Sun / Mac)²

Note:

1. Mouse port switching is only workable under the mouse emulation mode and applicable to 3-key USB wheel mice only.
 2. PC keyboard combinations emulate Mac keyboard. Mac keyboard only work with their computers.
-

Requirements

Refer to the table below to prepare the required devices, equipment, and cables to set up a CM1164A/CM1284 system.

	CM1164A	CM1284
Console	<ul style="list-style-type: none"> ◆ 1 x DVI-D Single Link display capable of the highest possible resolution ◆ 1 x USB mouse ◆ 1 x USB keyboard ◆ (Optional) Microphone and speakers 	<ul style="list-style-type: none"> ◆ 1 x HDMI cable ◆ 1 x USB mouse ◆ 1 x USB keyboard ◆ (Optional) Microphone and speakers
Computers	<p>Each computer¹ must be equipped with the following:</p> <ul style="list-style-type: none"> ◆ 1 x DVI port² ◆ 1 x USB Type A port ◆ (Optional) Audio ports 	<p>Each computer¹ must be equipped with the following:</p> <ul style="list-style-type: none"> ◆ 1 x HDMI port² ◆ 1 x USB Type A port ◆ (Optional) Audio ports
Cables	<ul style="list-style-type: none"> ◆ 1 x KVM cable (Single Link DVI-D, 2.0 channel audio, USB 2.0) ◆ 1 x IEC320 Power Cord ◆ 1 x Cat 5 cable with an RJ-45 connector for Daisy Chain Control ◆ 1 x IR Extension cable (sold separately) 	<ul style="list-style-type: none"> ◆ 1 x KVM cable (HDMI, 2.0 channel audio, USB 2.0) ◆ 1 x IEC320 Power Cord ◆ 1 x Cat 5 cable with an RJ-45 connector for Daisy Chain Control ◆ 1 x IR Extension cable (sold separately)

Note:

1. Make sure the computers' operating systems are supported. For information, see *Operating Systems*, page 6.
2. The quality of the display is affected by the quality of the computer's graphics card. ATEN recommends using a high quality product.

Operating Systems

Supported operating systems are shown in the table below:

OS		Version
Windows		7, 8.1, 10
Linux	RedHat	CentOS 7, Ubuntu 16.04
	SuSE	OpenSuSE 13.2
UNIX	Sun	10
Novell	Netware	X
Mac		10.12

Optional Equipment

An IR extension cable is available for the Multi-View KVMP™ Switch but is sold separately. To purchase the IR extension cable, contact your ATEN dealer and refer to the item's part number, 2XRT-0003G.

Components

CM1164A / CM1284 Front View

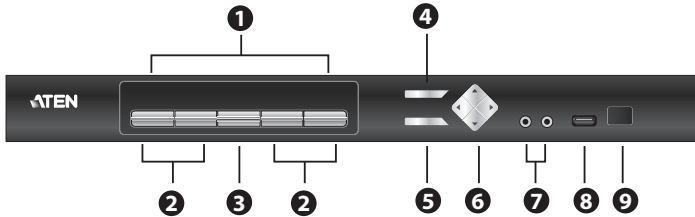

No.	Component	Description
1	KVM Status Panel	This panel contains LED icons that light to indicate mode and port status. The Mode and KVM Port Selection Pushbuttons each have three corresponding LED icons that represent audio , KVM , and USB Link status. See <i>Display Modes</i> , page 35, for full details.
2	KVM Port Selection Pushbuttons	<ul style="list-style-type: none"> ◆ Press the KVM Port Selection Pushbuttons to manually switch ports. See <i>Display Modes</i>, page 35, for full details. ◆ In a cascade setup, press a KVM Port Selection Pushbutton to switch the console display to the corresponding secondary KVMP™ Switch. ◆ Press and hold KVM Port Selection Pushbuttons 1 and 2 simultaneously for <i>2 seconds</i> to start Auto Scan Mode. See <i>Auto Scanning</i>, page 52, for full details. ◆ Press and hold KVM Port Selection Pushbuttons 3 and 4 simultaneously for <i>2 seconds</i> to detect the console keyboard and mouse again.
3	Mode Selection Pushbutton	This pushbutton allows you to cycle through the three modes of focus – KVM, stereo audio, and USB Link.
4	OSD (Esc) button	Press this to invoke the on-screen display (OSD) Menu. When the OSD Menu is enabled, press the OSD button to go back to the previous menu/submenu.
5	Select button	Press this to select an option in the OSD Menu.

No.	Component	Description
6	Direction / Function buttons	Use these buttons to: <ul style="list-style-type: none">◆ Switch between different preset configurations (Fn1 to Fn4). For details about Function modes, see <i>Preset Configuration</i>, page 45.◆ Cycle through the OSD Menu/selection. See <i>IR Remote Control</i>, page 11 for details.
7	Console Audio Ports	Your speakers and microphone plug in here. Note: When both the front-panel and rear-panel audio ports are used, the front panel takes priority.
8	USB 2.0 Peripheral Port	USB 2.0 peripherals (printers, scanners, etc.) plug into this port.
9	IR Receiver	This receives signals from the IR remote control.

CM1164A Rear View

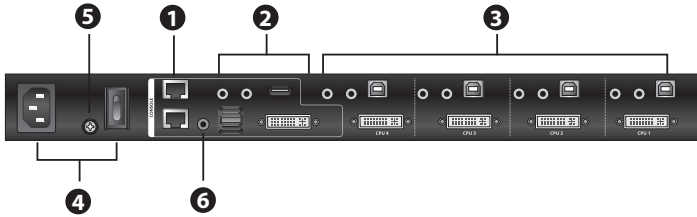

No.	Component	Description
1	Daisy Chain Control In / Out ports (DCC port)	<ul style="list-style-type: none"> Use these ports to connect to another CM1164A's DCC port to pass keyboard and mouse signals. You can daisy chain up to four CM1164A units. If the CM1164A is set up as a single station, you can control the CM1164A by sending serial commands through the DCC In port. For details, see Chapter 6, RS-232 Operation.
2	Console Ports	<p>The cables from your USB keyboard, USB mouse, DVI console display, a USB peripheral, microphone and speakers plug into this section.</p> <p>Note: When both the front-panel and rear-panel audio ports are used, the front panel takes priority.</p>
3	KVM Ports	<ul style="list-style-type: none"> The cables that link the CM1164A to your DVI-D Single Link computers plug in here. Each group of the DVI KVM ports is comprised of a microphone jack, speaker jack, USB Type B port, and a DVI Single Link connector. You can initiate firmware upgrades from the computer connected to these ports.
4	Power Socket / Power Switch	Plug in the power cord to the power socket and use the switch to power on the CM1164A.
5	Grounding Terminal	The grounding wire (used to ground the unit) attaches here.
6	IR Receiver (Extension)	This receives signals from the IR remote control through an IR extension, which can be purchased separately (see <i>Optional Equipment</i> , page 6).

CM1284 Rear View

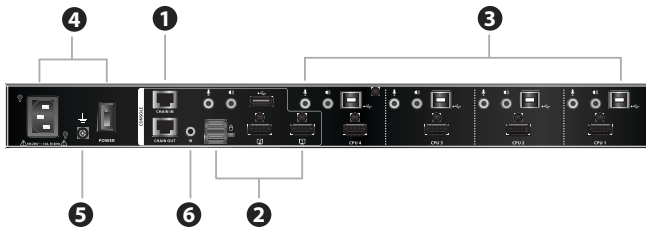

No.	Component	Description
1	Daisy Chain Control In / Out ports (DCC port)	<ul style="list-style-type: none"> Use these ports to connect to another CM1284's DCC port to pass keyboard and mouse signals. You can daisy chain up to four CM1284 units. If the CM1284 is set up as a single station, you can control the CM1284 by sending serial commands through the DCC In port. For details, see Chapter 6, RS-232 Operation.
2	Console Ports	<p>The cables from your USB keyboard, USB mouse, HDMI console displays, a USB peripheral, microphone and speakers plug into this section.</p> <p>Note:</p> <ol style="list-style-type: none"> HDMI Port 1 supports multi-view modes; HDMI Port 2 supports full-screen display only. When both the front-panel and rear-panel audio ports are used, the front panel takes priority.
3	KVM Ports	The cables that link the CM1284 to your computers plug in here. Each KVM port is comprised of a microphone jack, speaker jack, USB Type B, and an HDMI connector. You can initiate a firmware upgrade from the computer connected to these ports.
4	Power Socket and Power Switch	Plug in the power cord to the power socket and use the switch to power on the CM1284.
5	Grounding Terminal	The grounding wire (used to ground the unit) attaches here.
6	IR Receiver (Extension)	This receives signals from the IR remote control through an IR extension, which can be purchased separately (see <i>Optional Equipment</i> , page 6).

IR Remote Control

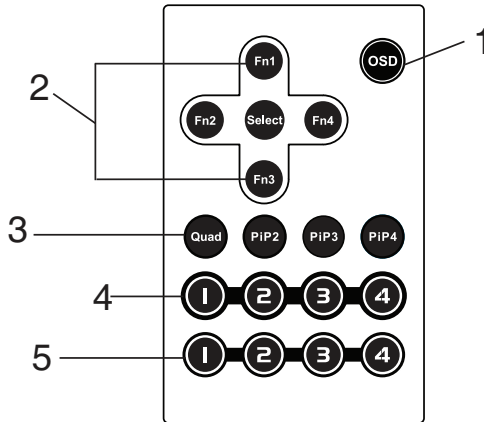

No.	Component	Description
1	OSD button	<p>Press this button to turn on or turn off the OSD Menu.</p> <p>When the OSD Menu is enabled, press the OSD button to go back to the previous menu/submenu.</p>
2	Fn1 / Fn2 / Fn3 / Fn4 Buttons and Select Button	<p>Use these buttons to switch between Function modes (Fn1 to Fn4), and to cycle through the OSD Menu/selection.</p> <p>See <i>Preset Configuration</i>, page 45 for details on how to store function mode settings, which you can invoke for later use.</p> <p>The Fn1~Fn4 buttons are positioned to correspond to the up / down / left / right direction.</p> <ul style="list-style-type: none"> ◆ When cycling through the menu options, press the Select button to go the submenu. ◆ If you want to change or adjust a selection/value, press the Select button then the Fn1 (up) / Fn2 (left) / Fn3 (down) / Fn4 (right) buttons to go through all the selections/values. Press the Select button again to confirm a selection.
3	Display Mode buttons	<p>Select the Display Mode you want to view. See <i>Display Modes</i>, page 35.</p>

No.	Component	Description
4	KVM Port Selection Buttons 1~4	<ul style="list-style-type: none">◆ Press these buttons to switch ports (1~4).◆ In a cascade setup, press these buttons to switch the console display to the corresponding secondary KVMP™ Switch.
5	Station Selection Buttons	If the Multi-View KVMP™ Switch is daisy chained to one or several units (up to 4), press the button corresponding to the KVMP™ Switch that you want to configure or operate.

Chapter 2

Hardware Setup



1. Important safety information regarding the placement of this device is provided on page 105. Please review it before proceeding.
2. Make sure that the power to all devices connected to the installation is turned off. You must unplug the power cords of any computers that have the Keyboard Power On function.

Rack Mounting

For convenience and flexibility, the Multi-View KVMP™ Switch can be mounted on system racks. To rack mount a unit, do the following:

1. Remove the screws attached to the unit as shown in the diagram below:

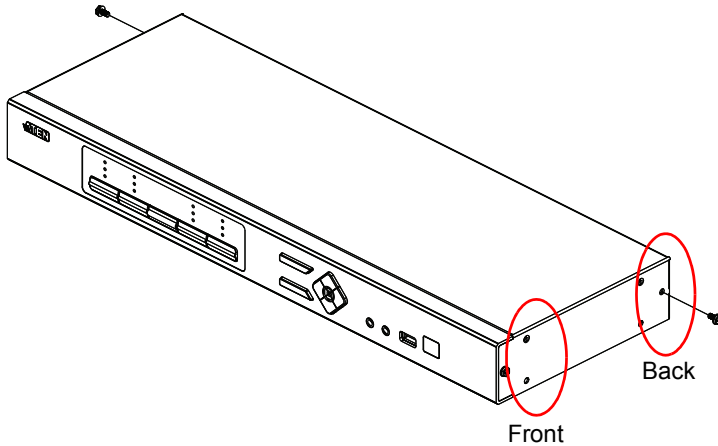

Note: You can remove the screws on the front side panels or the back side panels. The succeeding diagrams show the rack mounting steps for the back panel.

- Using the screws provided in the Mounting Kit (not included with this package), screw the mounting bracket into the side of the unit as show in the diagram below:

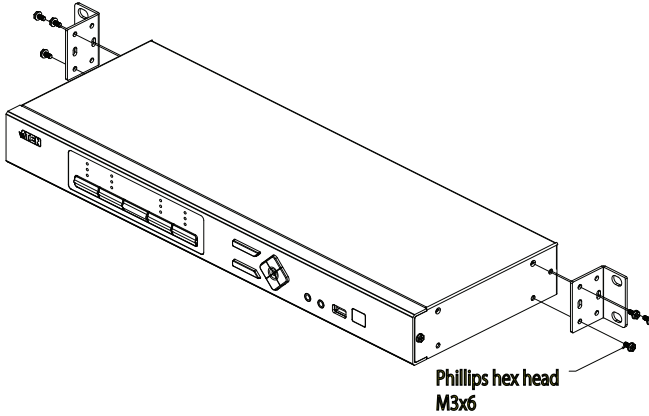

- Screw the bracket into any convenient location on the rack.

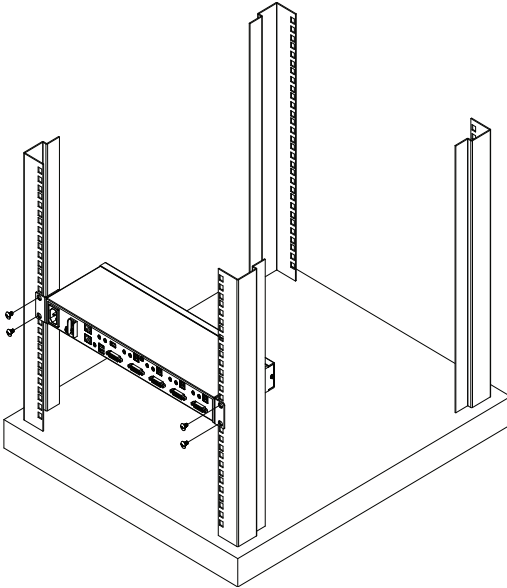

Note: These screws are not provided in the Mounting Kit. We recommend that you use M5 x 12 Phillips Type I cross, recessed type screws.

Grounding

To prevent damage to your installation it is important that all devices are properly grounded.

Note: The grounding wire is not included in the package. Please contact your dealer for the appropriate cable.

1. Use a grounding wire to ground the Multi-View KVMP™ Switch by connecting one end of the wire to the grounding terminal, and the other end of the wire to a suitable grounded object.
2. Make sure that the computer(s)/device(s) that the Multi-View KVMP™ Switch connects to are properly grounded.

Installation

CM1164A

You can install the CM1164A as a single station, daisy chain up to 4 CM1164A units, or cascade up to 4 additional CM1164A units to a primary CM1164A.

Single Station Installation

To set up a single CM1164A unit, refer to the installation diagram on page 17 (the numbers in the diagrams correspond to the steps below), and do the following:

1. Plug your USB keyboard and USB mouse into the USB Console Ports located on the unit's rear panel.
2. Plug your DVI display into the Console DVI Single Link Port located on the unit's rear panel.
3. (Optional) To use separate microphone and speakers, plug them into the analog audio ports on the unit's front panel or the ones on the rear panel. When both the front-panel and rear-panel audio ports are used, the front panel takes priority.
4. Using the USB DVI KVM cable, plug the DVI-D Single Link cable connector and the accompanying USB and audio connectors to their corresponding ports on the rear of the KVM switch.
5. At the other end of the cable, plug the DVI and USB cables into their respective ports on the source computer.
6. Plug your USB peripherals into the Type A ports (one easy-access port is located on the front for portable devices; the second is located on the rear).
7. Plug the power cord into the CM1164A power socket, and then plug the other end of the power cord into an AC power source.
8. Power on the KVM switch, the display, and the computers/devices.

Note: The recommended power-on sequence is Port 1–Port 2–Port 3–Port 4.

Single Station Installation Diagram

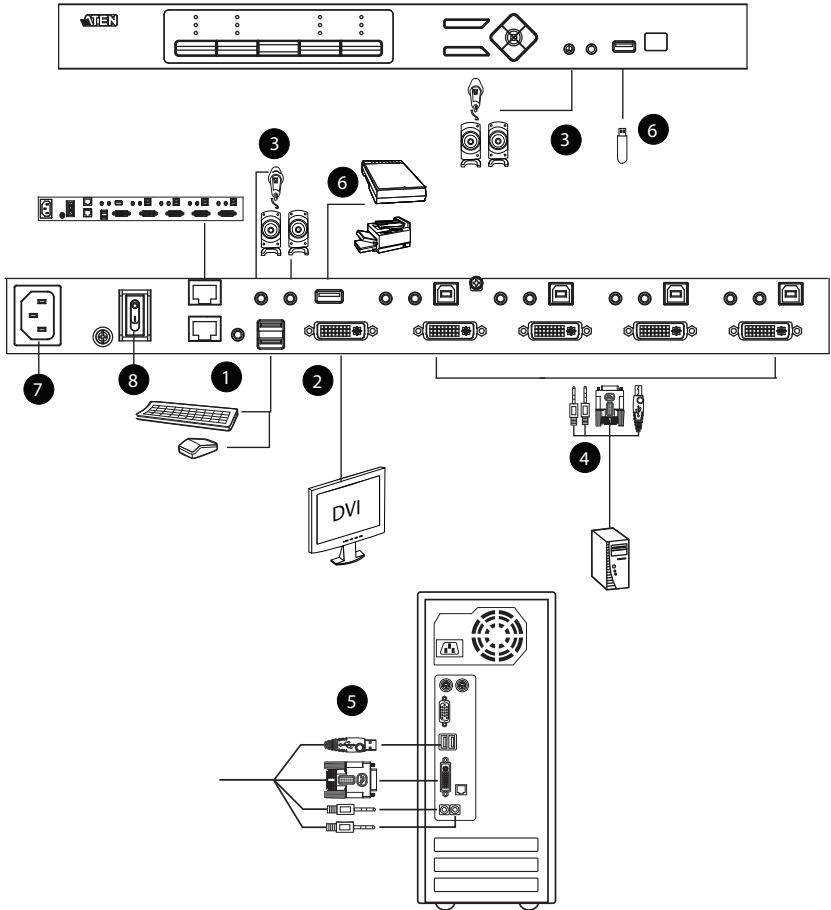

Daisy Chaining

To display even more computers/video source devices, up to 3 additional CM1164A units can be daisy chained from the original CM1164A. As many as 16 computers/video source devices can be controlled from a single console in a complete daisy chain installation. Each CM1164A in a daisy chain requires its own monitor as the video signals cannot be passed through to other units on a daisy chain.

To set up a daisy chain installation, make sure that the power to all devices has been turned off, and do the following:

1. Use an RJ-45 cable to connect the *DCC Out* port of the primary CM1164A to the *DCC In* port of the secondary CM1164A unit(s) (first station out to second station in, second station out to third station in, etc.).
2. Plug a DVI display into the Console DVI Port located on each unit's rear panel.
3. Cable up the computer and the switch according to the information provided under *Single Station Installation*, page 16.
4. Repeat the above for any other switches you want to add to the chain (up to three).
5. Power up the installation: plug in the power cord for the first station, then power on each station on the installation in turn (second station, then third station, etc.). After all the stations are up, power on the computers/video source devices.
6. Make sure the Expansion setting is set to **Daisy Chain** in the OSD Menu (**Advanced > Expansion**).
7. To switch to a computer in a daisy chain, select from the Control Station setting in the OSD Menu (**Advanced > Control Station**). When switching to a computer, only the keyboard and mouse signals are connected.

Note: The second, third, and fourth units in a daisy chain will not be able to use the IR remote for control. Only the first (primary) CM1164A can use the IR remote for control.

Daisy Chain Installation Diagram

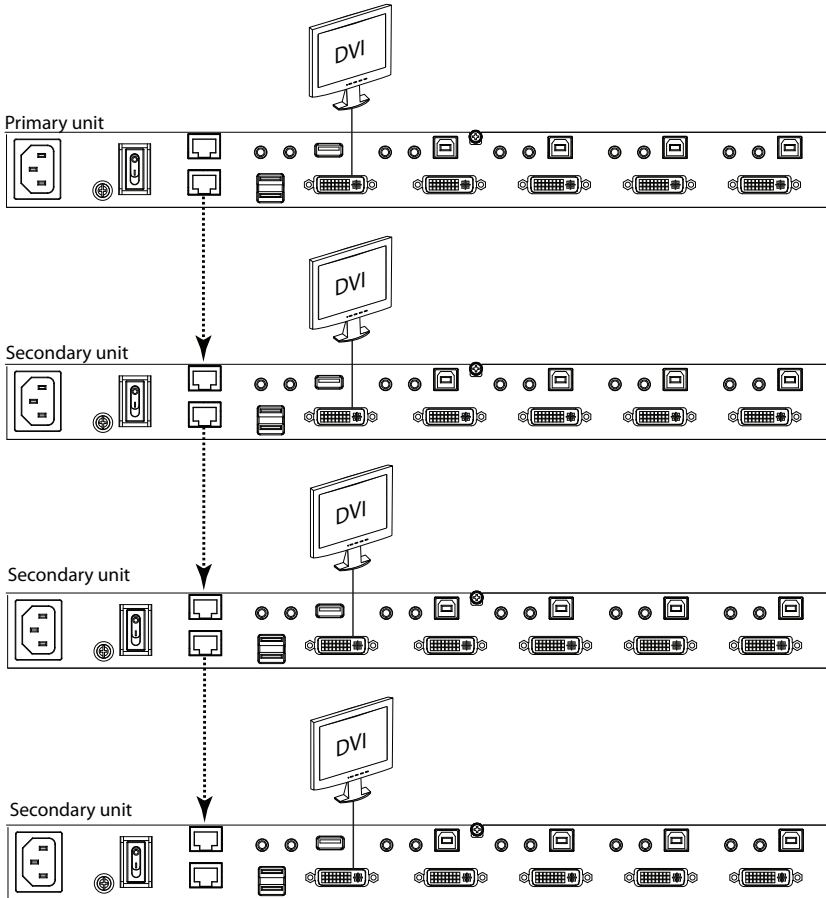

Cascading

To centrally control up to 4 CM1164A units (16 computers/video sources), cascade 4 additional CM1164A units to another CM1164A. As many as 16 computers/video source devices can be controlled from a single CM1164A console in a complete cascade installation.

To set up a cascade installation, make sure that the power to all devices has been turned off, and then do the following:

1. Connect the console ports of a secondary CM1164A to any of the DVI KVM Ports on the primary CM1164A using the provided KVM cables.
2. To cascade another CM1164A, repeat step 1.
3. Connect the secondary CM1164A units with computers/video sources. For detailed steps, see *Single Station Installation*, page 16.
4. Connect the primary CM1164A with a USB keyboard and a USB mouse.
5. Power up the installed CM1164A units. After all the stations are up, power on the connected computers/video source devices.
6. Change the installation setting from **Daisy Chain** to **Cascade** in the OSD Menu (**Advanced > Expansion**).
7. Each secondary CM1164A unit is recognized as an input source (port 1 ~ 4) to the primary CM1164A. To only display the sources of a particular secondary CM1164A, use any of the following methods:
 - ◆ Press the corresponding front-panel port pushbutton
 - ◆ Press the corresponding port button on the remote control

Cascade Installation Diagram

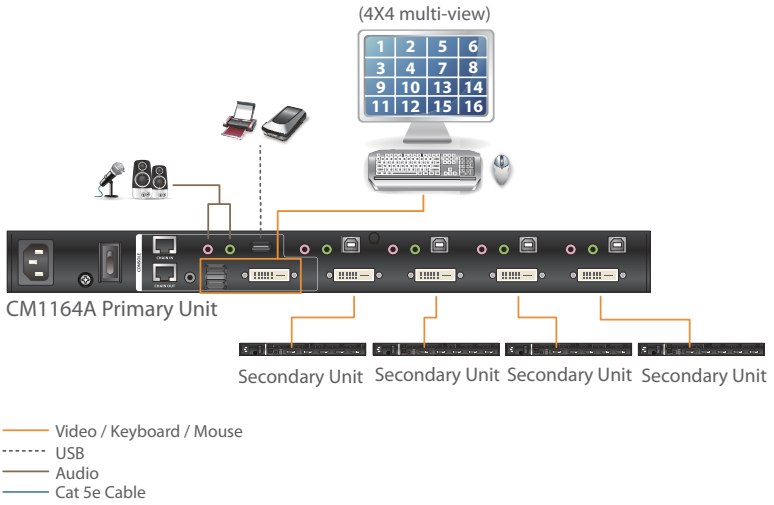

CM1284

You can install the CM1284 as a single station, daisy chain up to 4 CM1284 units, or cascade up to 4 additional CM1284 units to a primary CM1284.

Single Station Installation

To set up a single CM1284 unit, refer to the installation diagram on page 23 (the numbers in the diagrams correspond to the steps below), and do the following:

1. Ground the CM1284 by connecting one end of a grounding wire to the grounding terminal, and the other end of the wire to a suitable grounded object.
2. Plug your USB keyboard and USB mouse into the USB Console Ports located on the unit's rear panel.
3. Plug your main HDMI display to the Console HDMI Port 1 located on the unit's rear panel, and the second display to the Console HDMI Port 1.

Note: The main display here refers to the display that you use to operate and configure the Multi-View KVMP™ Switch and display multi-view modes; the second display is limited to displaying a selected source in full screen only.

4. (Optional) To use separate microphone and speakers, plug them into the analog audio ports on the unit's front panel or the ones on the rear panel. When both the front-panel and rear-panel audio ports are used, the front panel takes priority.
5. Using the USB HDMI KVM cables, plug the HDMI connectors and the accompanying USB and audio connectors to their corresponding ports on the rear of the KVM switch.
6. At the other end of the USB HDMI KVM cables, plug the HDMI and USB connectors into their respective ports on the source computer.
7. Plug your USB peripherals into the Type A ports (one easy-access port is located on the front for portable devices; the second is located on the rear).
8. Plug the power cord into the CM1284's power socket, and then plug the other end of the power cord into an AC power source.
9. Power on the KVM switch, the displays, and the computers/devices.

Note: The recommended power-on sequence is Port 1–Port 2–Port 3–Port 4.

Single Station Installation Diagram

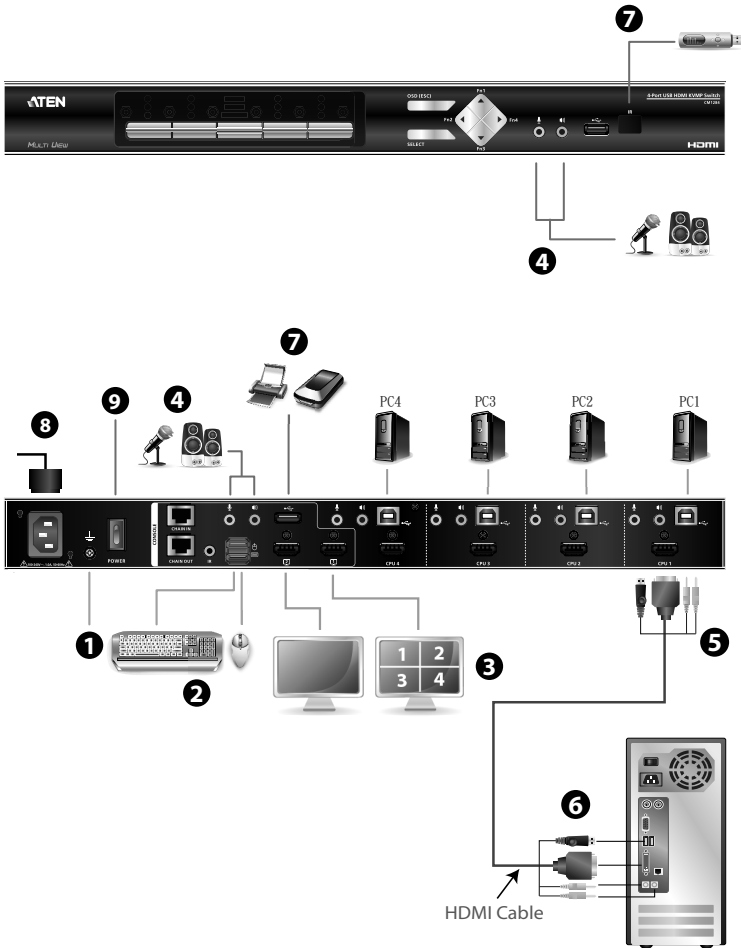

Daisy Chaining

To display even more computers/video source devices, up to 3 additional CM1284 units can be daisy chained from the original CM1284. As many as 16 computers/video source devices can be controlled from a single console in a complete daisy chain installation. Each CM1284 in a daisy chain requires its own monitor as the video signals cannot be passed through to other units on a daisy chain.

To set up a daisy chain installation, make sure that the power to all devices has been turned off, and do the following:

1. Use an RJ-45 cable to connect the *DCC Out* port of the primary CM1284 to the *DCC In* port of the secondary CM1284 unit(s) (first station out to second station in, second station out to third station in, etc.).
2. Plug your main HDMI display to the Console HDMI Port 1 located on the unit's rear panel, and the second display to the Console HDMI Port 1.

Note: The main display here refers to the display that you use to operate and configure the Multi-View KVMP™ Switch and display multi-view modes; the second display is limited to displaying a selected source in full screen only.

3. Cable up the computer and the switch according to the information provided under *Single Station Installation*, page 22.
4. Repeat the above for any other switches you want to add to the chain (up to three).
5. Power up the installation: plug in the power cord for the first station, then power on each station on the installation in turn (second station, then third station, etc.). After all the stations are up, power on the computers/video source devices.
6. Make sure the Expansion setting is set to **Daisy Chain** in the OSD Menu (**Advanced** > **Expansion**).
7. To switch to a computer in a daisy chain, select from the Control Station setting in the OSD Menu (**Advanced** > **Control Station**). When switching to a computer, only the keyboard and mouse signals are connected.

Note: The second, third, and fourth units in a daisy chain will not be able to use the IR remote for control. Only the first (primary) CM1284 can use the IR remote for control.

Daisy Chain Installation Diagram

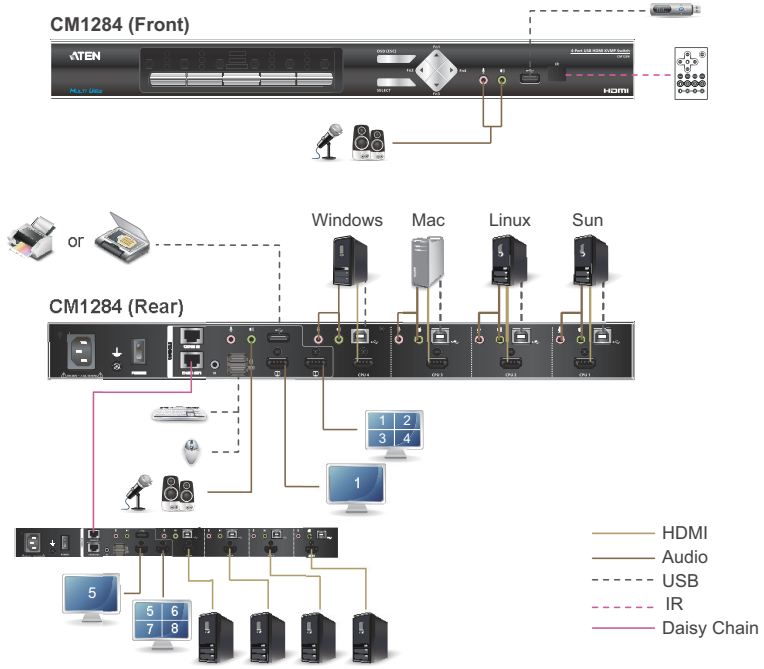

Cascading

To centrally control up to 4 CM1284/CM1164A units (16 computers/video sources) from a CM1284 unit, cascade 4 additional CM1284/CM1164A units to the primary CM1284. As many as 16 computers/video source devices can be controlled from a single CM1284 console in a complete cascade installation.

To set up a cascade installation, make sure that the power to all devices has been turned off, and then do the following:

1. Connect the console ports of a secondary CM1284/CM1164A to any set of the KVM Ports on the primary CM1284 using the provided KVM cables.

Note: Make sure to connect the Console HDMI Port 1 of the secondary CM1284 instead of its Port 2 to the primary CM1284 to be able to display multi-view modes.

2. To cascade another CM1284, repeat step 1.
3. Connect the secondary CM1284/CM1164A units with computers/video sources. For detailed steps, see *Single Station Installation*, page 22.
4. Connect the primary CM1284 with a USB keyboard and a USB mouse.
5. Power up the installed CM1284/CM1164A units. After all the stations are up, power on the connected computers/video source devices.
6. Change the installation setting from **Daisy Chain** to **Cascade** in the OSD Menu (**Advanced > Expansion**).
7. Each secondary CM1284/CM1164A unit is recognized as an input source (port 1 ~ 4) to the primary CM1284. To only display the sources of a particular secondary CM1284/CM1164A, use any of the following methods:
 - ◆ Press the corresponding front-panel port pushbutton
 - ◆ Press the corresponding port button on the remote control

Cascade Installation Diagram

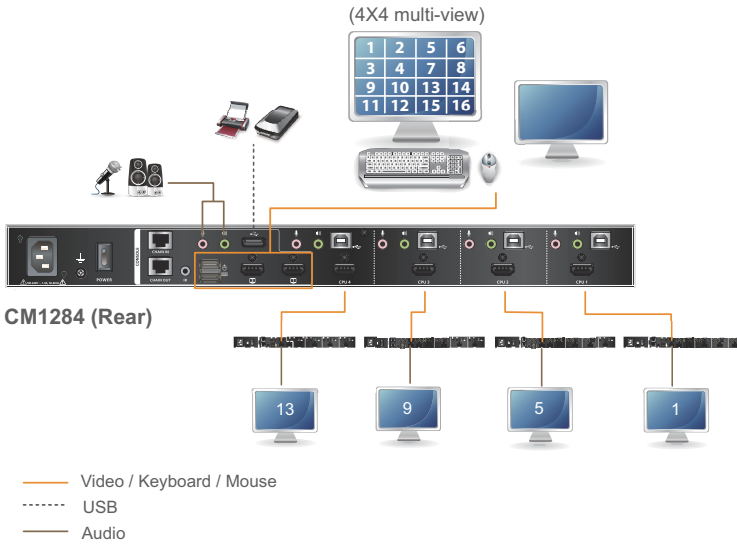

This Page Intentionally Left Blank

Chapter 3

Basic Operation

Overview

This chapter explains the basic components used to switch and display computers connected to the Multi-View KVMP™ Switch.

Identifying the Source Device

You can identify each source connected to the Multi-View KVMP™ Switch by the port ID number and the device name at the top-left corner in the screen. In the following example, the port ID number for this computer is **1**, and its device name is **PC 1**.



- ◆ Port ID number: This number is assigned according to the port that the computer is connected to on the rear of the KVM Switch. For example, a computer connected to port 1 is assigned port ID 1.

Note: In a cascade setup, a port ID number of “1-3” indicates that the video source comes from the third port of the secondary Multi-View KVMP™ Switch connected to port 1 of the primary Multi-View KVMP™ Switch.

- ◆ Device name: By default, the computer connected to port 1 is named PC 1, the computer connected to port 2 is named PC 2, and so forth. To change the device name, go to **System Settings > Port Configuration**.

Switching

The Multi-View KVMP™ Switch supports group switching and independent switching:

- ◆ Group switching: switches to the KVM (keyboard, video, mouse), audio, and USB sources of one computer.
- ◆ Independent switching: switches to KVM (keyboard, video, mouse), audio, and USB sources independently, on different computers. This allows you to work on one computer (KVM), access the audio on another (Audio), and connect to peripheral devices on a third (USB).

Note: In a CM1284 system, Display 2 shows a video that is shown on Display 1, or of the focused video on Display 1 when Display 1 is in a multi-view mode. To have Display 2 show video of a particular computer, configure the **Display B Status** setting in the OSD.

Manual Switching

To manually switch sources, use the **Port Selection** and **Mode** pushbuttons located on the front panel. The selected sources are indicated with LEDs on the front panel. For more information about LED indicators, see *LED Display*, page 31.

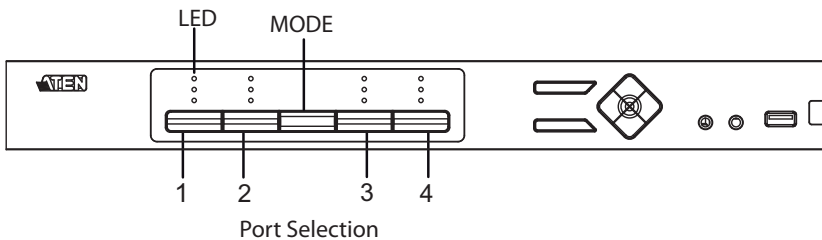



- ◆ To switch KVM, Audio, and USB access to a computer, press the **KVM Port Selection** pushbutton that corresponds to the computer you want to access.
- ◆ To switch KVM access to a computer, press **Mode** 2 times, and then press the **KVM Port Selection** pushbutton that corresponds to the computer.
- ◆ To switch Audio access to a computer, press **Mode** 3 times, and then press the **KVM Port Selection** pushbutton that corresponds to the computer.

- ◆ To switch USB access to a computer, press **Mode** 4 times, and then press the **KVM Port Selection** pushbutton that corresponds to the computer.
- ◆ Press **KVM Port Selection** pushbuttons **1** and **2** for 2 seconds to start Auto Scan Mode. To stop auto scan, press and release either port selection pushbutton.

LED Display

The front panel has three LEDs that represent the KVM, Audio and USB source. The LEDs light green or orange depending on which source is being accessed on what computer, as explained in the table.



LED		Indication
Icon	KVM 	<ul style="list-style-type: none"> ◆ Lights BRIGHT ORANGE to indicate KVM is selected. ◆ Flashes ORANGE to indicate that the computer is being accessed in Auto Scan Mode. ◆ All flash ORANGE to indicate the firmware upgrade has been invoked. ◆ The corresponding port LED of the USB keyboard/ mouse flashes when Keyboard Bypass is enabled. ◆ Lights a faint ORANGE to indicate that a computer is powered on.
	Audio 	<ul style="list-style-type: none"> ◆ Lights BRIGHT GREEN to indicate Audio is selected. ◆ Flashes GREEN to indicate that Audio is selected on a computer in a Daisy Chain setup.
	USB Link 	<ul style="list-style-type: none"> ◆ Lights BRIGHT GREEN to indicate USB is selected. ◆ Flashes GREEN to indicate that USB Link is selected on a computer in a Daisy Chain setup.

Hotkey Switching

You can switch to a computer using hotkeys from the keyboard.

To switch to computer 1, do the following:

1. Press and hold down **[Num Lock]**.
2. Press and release **[-]**.
3. Release **[Num Lock]**.
4. Press **[1]**.
5. Press **[Enter]**.

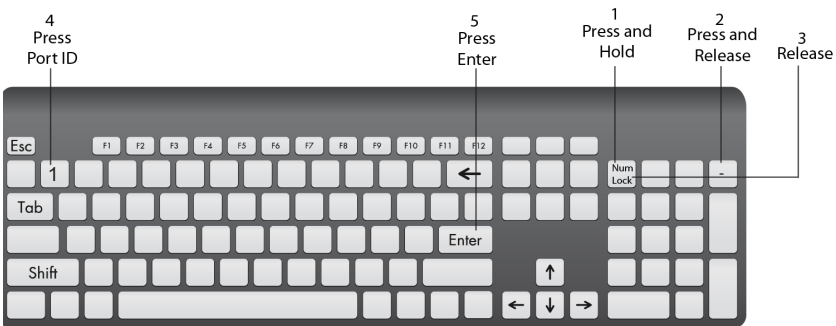

Repeat the steps using Port ID (1, 2, 3, 4) in step 4 to switch to the computer connected to that port. For more hotkeys, see *Hotkey Operation*, page 47.

Remote Switching

You can switch to a computer with the remote control. Point the remote at the Multi-View KVMP™ Switch and press the *Port Selection* button of the computer you want to access.

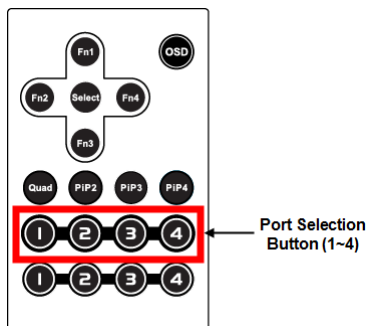



OSD Switching

You can switch to a computer by accessing the Quick Access Toolbar with the console mouse.

To switch computers with the OSD, do the following:

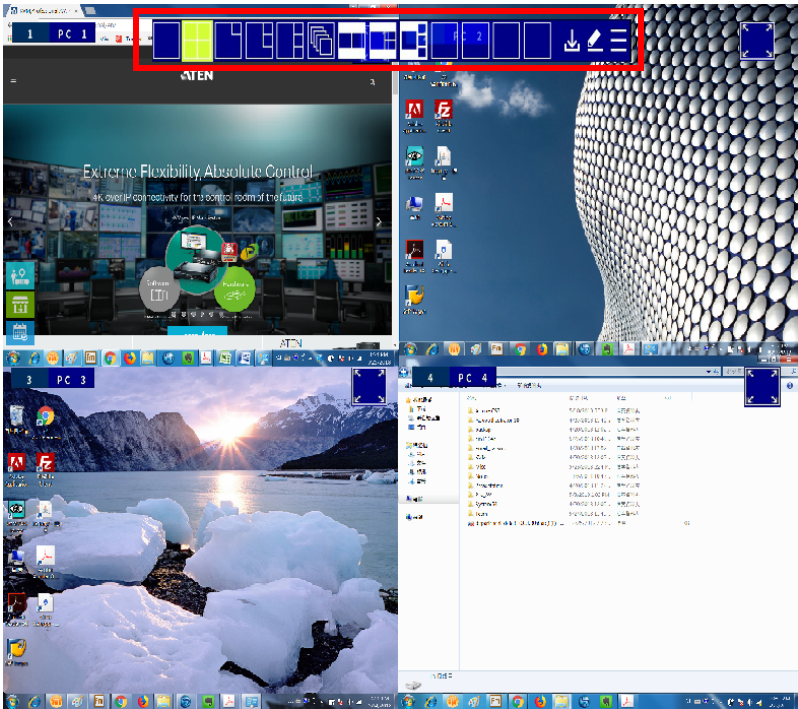
1. Move the cursor to the top of the OSD to display the Quick Access Bar.



- From the Quick Access Toolbar, click  to activate the editor mode. This screen appears.

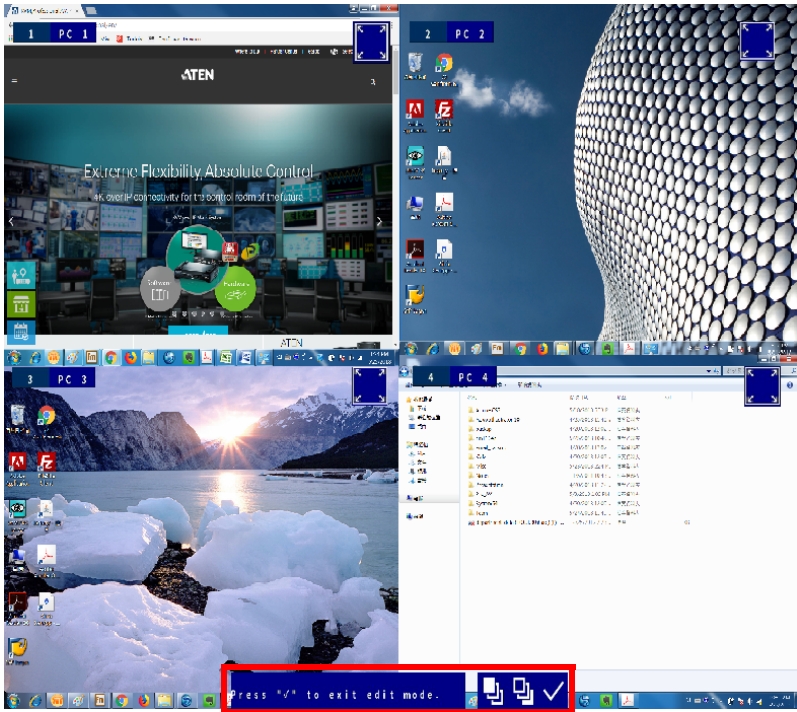

- Click the port number at the top-left corner to open drop-down list, and then select a computer: **1**, **2**, **3**, or **4**. The display is immediately switched to the selected computer.
- When you finish configuring, click  to end the editor mode.

Display Modes

You can view multiple computers connected to the Multi-View KVM[™] Switch on the same screen, in different layout by setting the display mode. This section introduces you to different display modes, and ways of switching to them.



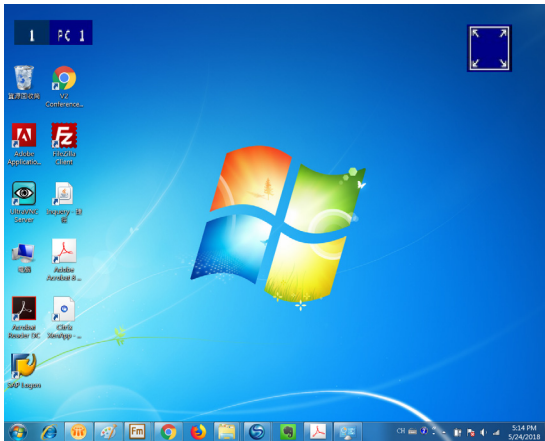

Note: In a CM1284 system, Display 2 supports full-screen mode only.

Full Screen

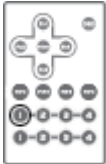
A full-screen view displays one computer in full extension.







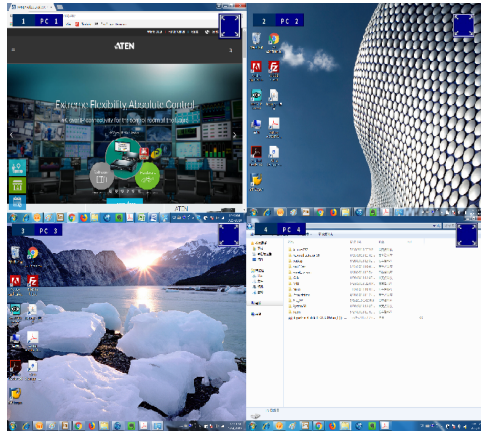

Method	Action	Description
Front Panel	Press a KVM Port Selection Pushbutton .	
IR Remote Control	Press a KVM Port Selection Pushbutton .	

Method	Action	Description
Mouse Wheel	In any PiP mode, move the cursor to the display you wish to extend, and double-click the mouse wheel. Note: This function is disabled by default. To enable this function, enable the Advanced > Mouse Wheel Switching function from the OSD Menu.	N/A
Quick Access Toolbar	Move mouse to top center of the OSD and select from the Quick Access Toolbar. Note: Hardware Cursor Mode must be enabled, see <i>The OSD Menu</i> , page 51.	
Hotkey	Enter the illustrated hotkeys. See <i>Hotkey Setting Mode</i> , page 40 for hotkey instructions.	
OSD Menu	In the OSD, click  from the Quick Access Toolbar, go to Display > Multiview Mode , and then select Single .	

Quad View

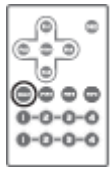
A quad view displays four computers on the monitor in equal sized windows.



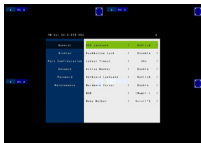



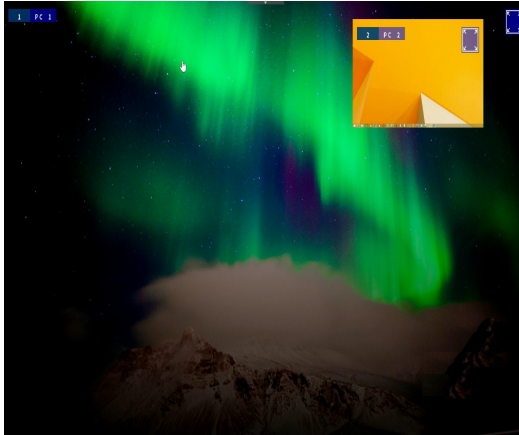

Method	Action	Description
Front Panel	Press Select to cycle through display modes.	 <p>Push to cycle</p>
IR Remote Control	Press the Quad button.	
Quick Access Toolbar	Move mouse to top center of the OSD and select from the Quick Access Toolbar. Note: Hardware Cursor Mode must be enabled, see <i>The OSD Menu</i> , page 51.	
Hotkey	Enter the illustrated hotkeys. See <i>Hotkey Setting Mode</i> , page 40 for hotkey instructions.	
OSD Menu	In the OSD, click  from the Quick Access Toolbar, go to Display > Multiview Mode , and then select Quad .	

Picture in Picture - Dual

A dual PiP view shows 2 computers on the monitor with one as the main display, and the other overlapping the main display in an inset window.







Method	Action	Description
Front Panel	Press Select to cycle through display modes.	
IR Remote Control	Press the PIP2 button.	
Quick Access Toolbar	Move mouse to top center of <i>The OSD Menu</i> , page 51. Note: Hardware Cursor Mode must be enabled, see <i>The OSD Menu</i> , page 51.	
Hotkey	Enter the illustrated hotkeys. See <i>Hotkey Setting Mode</i> , page 40 for hotkey instructions.	
OSD Menu	In the OSD, click  from the Quick Access Toolbar, go to Display > Multiview Mode , and then select PIP2 .	

Picture in Picture - Triple

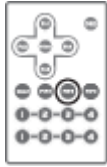
A triple PiP view has 3 computers on the monitor with one computer as the main display and the other two overlapping the main display in inset windows.







Method	Action	Description
Front Panel	Press Select to cycle through display modes.	
Remote Control	Press the PIP3 button	
Quick Access Toolbar	Move mouse to top center of the OSD and select from the Quick Access Toolbar. Note: Hardware Cursor Mode must be enabled, see <i>The OSD Menu</i> , page 51.	
Hotkey	Enter the illustrated hotkeys. See <i>Hotkey Setting Mode</i> , page 40 for hotkey instructions.	
OSD Menu	In the OSD, click  from the Quick Access Toolbar, go to Display > Multiview Mode , and then select PIP3 .	

Picture in Picture - Quad

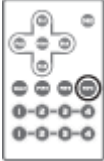
A quad PiP view has 4 computers on the monitor with one computer as the main display and the other three overlapping the main display in inset windows.





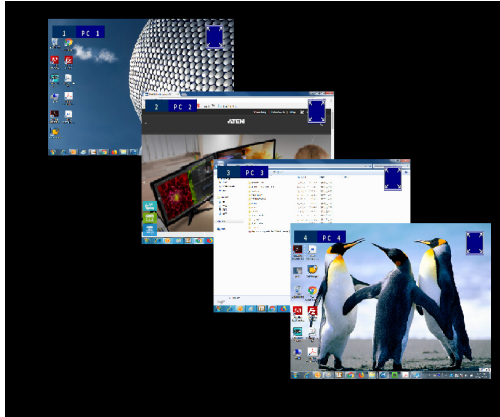

Method	Action	Description
Front Panel	Press Select to cycle through display modes.	
Remote Control	Press the Pi4 button.	
Quick Access Toolbar	Move mouse to top center of the OSD and select from the Quick Access Toolbar. Note: Hardware Cursor Mode must be enabled, see <i>The OSD Menu</i> , page 51.	
Hotkey	See <i>Hotkey Setting Mode</i> , page 40 for hotkey instructions.	
OSD Menu	In the OSD, click ≡ from the Quick Access Toolbar, go to Display > Multiview Mode , and then select PIP4 .	

Picture on Picture

A picture-on-picture (PoP) view shows 4 computers in separate windows on the monitor. In editor mode, you can use the console mouse to resize and re-position each window on the screen.







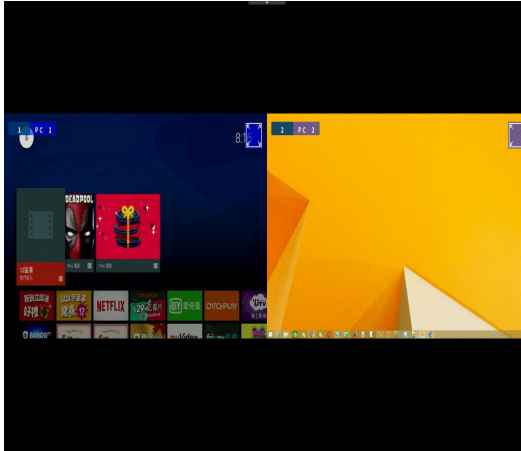

Method	Action	Description
Front Panel	Press Select to cycle through display modes.	
Quick Access Toolbar	Move mouse to top center of the OSD and select from the Quick Access Toolbar. Note: Hardware Cursor Mode must be enabled, see <i>The OSD Menu</i> , page 51.	
Hotkey	Enter the illustrated hotkeys. See <i>Hotkey Setting Mode</i> , page 40 for hotkey instructions.	
OSD Menu	In the OSD, click  from the Quick Access Toolbar, go to Display > Multiview Mode , and then select PoP .	

Hint: To reverse the order of the overlaps, click  in the Quick Access Bar to enable the Editor mode, and click  or  to adjust.

Picture by Picture - Dual

The picture-by-picture (dual) view displays 2 computers side by side on the monitor.





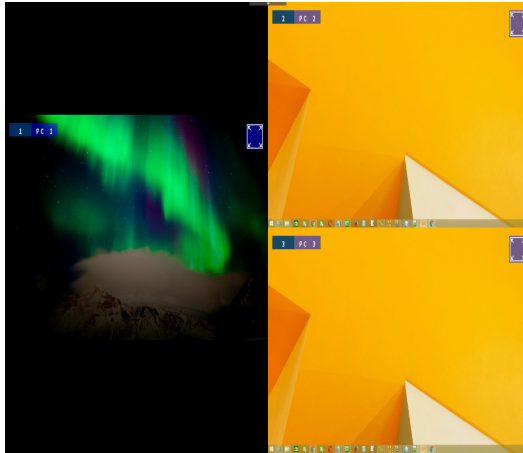

Method	Action	Description
Front Panel	Press Select to cycle through display modes.	
Quick Access Toolbar	Move mouse to top center of the OSD and select from the Quick Access Toolbar. Note: Hardware Cursor Mode must be enabled, see <i>The OSD Menu</i> , page 51.	
Hotkey	Enter the illustrated hotkeys. See <i>Hotkey Setting Mode</i> , page 40 for hotkey instructions.	
OSD Menu	In the OSD, click  from the Quick Access Toolbar, go to Display > Multiview Mode , and then select PbP2 .	

Picture by Picture - Triple

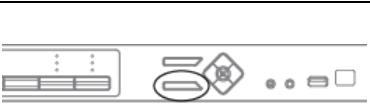
The picture-by-picture (triple) view displays 3 computers side by side on the monitor.







Method	Action	Description
Front Panel	Press Select to cycle through display modes.	
Quick Access Toolbar	Move mouse to top center of the OSD and select from the Quick Access Toolbar. Note: Hardware Cursor Mode must be enabled, see <i>The OSD Menu</i> , page 51.	
Hotkey	Enter the illustrated hotkeys. See <i>Hotkey Setting Mode</i> , page 40 for hotkey instructions.	
OSD Menu	In the OSD, click  from the Quick Access Toolbar, go to Display > Multiview Mode , and then select PbP3 .	

Picture by Picture - Quad

The picture-by-picture (quad) view displays 4 computers side by side on the monitor.



Method	Action	Description
Front Panel	Press Select to cycle through display modes.	
Quick Access Toolbar	Move mouse to top center of the OSD and select from the Quick Access Toolbar. Note: Hardware Cursor Mode must be enabled, see <i>The OSD Menu</i> , page 51.	
Hotkey	Enter the illustrated hotkeys. See <i>Hotkey Setting Mode</i> , page 40 for hotkey instructions.	
OSD Menu	In the OSD, click  from the Quick Access Toolbar, go to Display > Multiview Mode , and then select PbP4 .	

Preset Configuration

You can save up to 4 sets of configuration, including the display mode, source assignment, division sizes, division locations, and KVM/Audio/USB focus status to easily toggle between different display configurations.



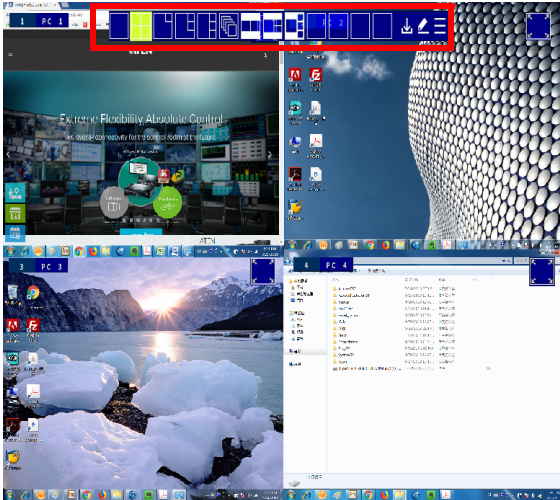

To save a configuration, follow the steps below.

1. Configure the display settings as required.
2. Move the console mouse to the top of the screen. The Quick Access Toolbar appears.



3. Click  and select a preset (Fn) to save the current configuration.

To apply a preset configuration, use any of the following methods.

Method	Action	Description
Front Panel Pushbutton	Press the Fn1 , Fn2 , Fn3 , or Fn4 pushbutton.	
Remote Control	Press the Fn1 , Fn2 , Fn3 , or Fn4 button.	
Quick Access Toolbar (<i>Hardware Cursor Mode must be enabled, see The OSD Menu, page 51</i>)	Move mouse to top center of the OSD and then select from the Quick Access Toolbar. Note: Hardware Cursor Mode must be enabled, see <i>The OSD Menu</i> , page 51.	
Hotkey	Enter the illustrated hotkeys. See <i>Hotkey Setting Mode</i> , page 40 for hotkey instructions.	
3-button wheel mouse	Use the mouse wheel to toggle between different Fn settings.	N/A

Chapter 4

Hotkey Operation

The Multi-View KVMP™ Switch provides easy-to-use hotkeys to control and configure your KVM installation from the keyboard.

Open the OSD Menu

To activate the OSD using your keyboard, tap the **Scroll Lock** key twice:

[Scroll Lock] [Scroll Lock]

You can close the OSD menu by pressing [**Esc**] or **Spacebar**.

- ♦ [**Esc**] returns to the previous page.
- ♦ **Spacebar** immediately exits the OSD.

Note: The hotkey to activate the OSD can be changed to the **Ctrl** key. See *The OSD Menu*, page 57 for details.

The Hotkey Setting Mode

You can operate and configure the Multi-View KVMP™ Switch with hotkeys when the Hotkey Setting Mode (HSM) is enabled. To use hotkeys, do the following:

1. Invoke the Hotkey Setting Mode.
 - a) Press and hold down **[Num Lock]**.
 - b) Press and release **[-]**.
 - c) Release **[Num Lock]**. The HSM is activated. The Caps Lock, and Scroll Lock LEDs flash in succession to indicate that the HSM is in effect.

Note:

- ◆ When the HSM is activated, ordinary keyboard and mouse functions are suspended – only hotkey keystrokes can be used.
 - ◆ To change the keys for invoking the HSM, see *The OSD Menu*, page 57 for details.
-

2. Type the hotkeys and press **[Enter]** to execute actions.
For a list of supported actions and corresponding hotkeys, see *Hotkeys List*, page 49.
3. To disable the HSM, press **[Esc]** or **[Space Bar]**.

Hotkeys List

Hotkey		Action
Port Switching	[Enter]	Switches the focus for all the devices, including KVM, USB hub and audio to the next computer. (Port 1 to Port 2, Port 2 to Port 3, Port 3 to Port 4, and Port 4 to Port 1.)
	[Port ID] [n]	Switches the focus of the specified device to the computer device that corresponds to the port ID entered in a single station setup . [Port ID] sets the computer to which the CM1164A/CM1284 switches. When [Port ID] is omitted, the CM1164A/CM1284 switches to the specified device (N) on the next computer device. [n] sets the focused device: <ul style="list-style-type: none"> ◆ N = K or omitted (KVM) ◆ N = U (USB hub) ◆ N = S (Microphone and speakers) To switch two or all three devices at the same time, enter the [N] keys. For example, [Port ID] [K] [U] will switch the KVM and USB hub focus to the specified port.
	[Station ID] [Port ID] [Device]	Switches the focus of the specified device to the computer device that corresponds to the station ID and the port ID entered in a cascaded or daisy-chained setup . [Port ID] sets the computer to which the CM1164A/CM1284 switches. When [Port ID] is omitted, the CM1164A/CM1284 switches to the specified device (N) on the next computer device. [Device] sets the focused device: <ul style="list-style-type: none"> ◆ [Device] = K or omitted (KVM) ◆ [Device] = U (USB hub) ◆ [Device] = S (Microphone and speakers) To switch two or all three devices at the same time, enter the [N] keys. For example, [Station ID] [Port ID] [K] [U] will switch the KVM and USB hub focus to the specified port.
	[E]	Enables or disables Power On Detection with which the Multi-View KVMP™ Switch switches to the next powered-on computer when a computer that has KVM focus is powered off.

Hotkey		Action
Display Settings	[A] [n]	Starts Auto Scan where the KVM focus cycles from port to port at the specified interval (n = 5, 10, 15, 30, 60, 90 seconds). The default interval is 5 seconds. See <i>Auto Scanning</i> , page 52 for more information.
	[J] [n]	Sets the video content for Monitor 2. This function is only supported on the CM1284. [n] specifies the source of the displayed video. <ul style="list-style-type: none"> ◆ n is omitted (Displays the content of the focused window on Monitor 1) ◆ n = 1 (Always displays the video from port 1) ◆ n = 2 (Always displays the video from port 2) ◆ n = 3 (Always displays the video from port 3) ◆ n = 4 (Always displays the video from port 4)
	[P] [n]	Switches to the specified (n) display mode. For more information on display modes, See <i>Display Modes</i> , page 35. <ul style="list-style-type: none"> ◆ n = 0 (PoP) ◆ n = 1 (Quad view) ◆ n = 2 (PiP dual view) ◆ n = 3 (PiP triple view) ◆ n = 4 (PiP quad view) ◆ n = 5 (PbP dual view) ◆ n = 6 (PbP triple view) ◆ n = 7 (PbP quad view)
	[V] [n]	[n] specifies the port's EDID to adopt. sets the KVM Switch to use the EDID of the display connected to the specified port [n]: <ul style="list-style-type: none"> ◆ n = 1 (Port 1 mode) ◆ n = 2 (Port 2 mode) ◆ n = 3 (Remix mode) ◆ n = 4 (ATEN Default: 4096 x 2160 @30Hz for CM1284, 1920 x 1080 @60Hz for CM1164A) ◆ n = 5 (For CM1284 only, ATEN Default 2560 x 1600 @60Hz) ◆ n = 6 (For CM1284 only, ATEN Default 1920 x 1080 @60Hz)

Hotkey	Action
General Settings	[F1] Sets the operating system to SPC.
	[F2] Enables or disables Mac keyboard emulation.
	[F3] Enables or disables Sun keyboard emulation.
	[F4] Lists the current settings of the Multi-View KVMP™ Switch. To use this function, open a text editor or word processor, and place the cursor in the page window before invoking the HSM and enter the hotkey.
	[F5] Resets USB devices. If any USB devices lose focus or connectivity, a USB reset may solve the issue.
	[F6] [n] [n] sets the keyboard language: <ul style="list-style-type: none"> ◆ n = 08 (French) ◆ n = 09 (German) ◆ n = 15 (Japanese) ◆ n = 33 (English)
	[B] Enables or disables the beeper. Enable or disable the beeper.
	[F] [n] Applies the specified Fn preset configurations (n = 1, 2, 3, or 4). For more information on Fn preset configurations, see <i>Preset Configuration</i> , page 45.
	[H] Enables or disables the Hardware Cursor Mode.
	[L] Locks or unlocks the front-panel pushbuttons.
	[M] / [m] Enables or disables mouse emulation. Enables or disables mouse emulation.
	[N] / [n] Enables or disables keyboard emulation.
	[u][p][g][r][a][d][e] Initiates a firmware upgrade.
	[W] / [w] Enables or disables port switching using the console mouse.

Auto Scanning

The Auto Scan feature automatically cycles the KVM focus through the computer ports at regular intervals. This allows you to monitor the computer activity without having to switch from port to port manually. Although the video focus switches from port to port, the keyboard, mouse, and USB focus do not switch. They stay with the port they were on when Auto Scanning started.

While Auto Scan Mode is in effect, ordinary keyboard and mouse functions are suspended – only Auto Scan Mode keystrokes and mouse clicks can be input. You must exit Auto Scan Mode in order to regain normal control of the console.

Auto Scanning - Display Modes

Auto scan can be invoked with Full Screen, PiP Dual, PiP Triple, PbP Dual, and PbP Triple modes. When you start auto scan with PiP Dual or PiP Triple one of the secondary windows (channels) is used to auto scan two or three computers.

Auto Scan mode does not work with the **Quad View, PiP Quad, or PoP mode** as these modes already display all computers on the screen. (see *Display Modes*, page 35).

Chapter 5

OSD Operation

Overview

The Multi-View KVMP™ Switch can be operated and configured via the following OSD components:



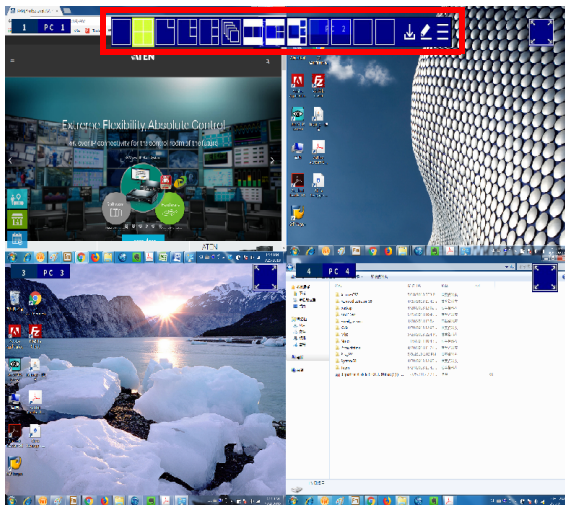

- ♦ Quick Access Toolbar: This toolbar provides quick access for changing the display mode, saving display templates, and customizing division sizes. For details, see *The Quick Access Toolbar*, page 53.
- ♦ OSD Menu: This contains controls for all system settings. For details, see *The OSD Menu*, page 57.

The Quick Access Toolbar

You can use the Quick Access Toolbar to conveniently switch display modes, customize window size and location via the editor mode, and apply and save display templates.



To display the Quick Access Toolbar, move the console mouse to the top of the screen. The Quick Access Toolbar provides the following controls:

- ◆ : Click an icon to apply the display mode.
- ◆ : Click this icon to enable the editor mode to allow you to assign source to a particular channel and resize inset windows.
- ◆ : Click a Function icon to apply the selected display template.
- ◆ : Click this icon to save the current display configuration to a display template.
- ◆ : Click this icon to open the OSD menu. For details, see *The OSD Menu*, page 57.

Note:

- ◆ Make sure to enable Hardware Cursor and Mouse Emulation to access the Quick Access Toolbar using the console mouse.
 - ◆ To change the display position, go to **Display > Toolbar Position** in the OSD menu.
-



The Editor Mode

Use the editor mode to customize the source display. You can resize windows, change the display source, or relocate windows. To enable the editor mode, follow the steps below.

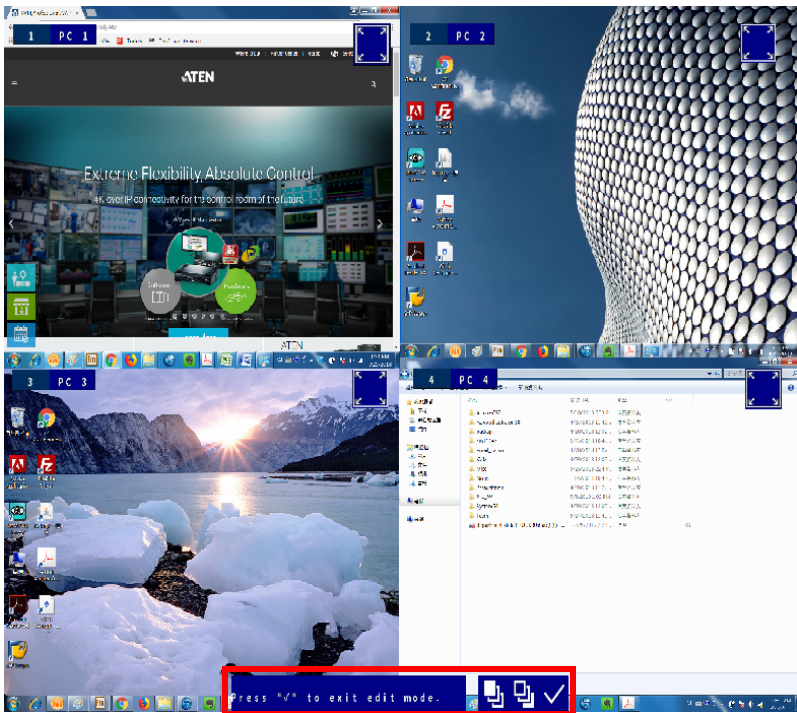
1. Make sure the following functions are enabled to allow console mouse to operate. For details, see *The OSD Menu*, page 57.
 - ◆ Hardware Cursor
 - ◆ Mouse Emulation
2. Move the console mouse to the top of the screen to display the Quick Access Toolbar.
3. Click  from the Quick Access Tool. A Press “✓” to quit edit mode message appears to indicate that the editor mode is enabled.



4. Configure and adjust the display as required. You can do the following when the editor mode is enabled:

Function	Action
Change the display mode	<ul style="list-style-type: none"> ◆ Click a display mode from the Quick Access Toolbar. ◆ Click  to display the window in full screen.
Apply a preset configuration	Click an Fn icon from the Quick Access Toolbar. For more information, see <i>Preset Configuration</i> , page 45.
Change the source	Click the port number and select a port.
Resize the window	Click on a window, move the cursor to a corner of the window, and drag the corner to resize the window.
Relocate the window	Click and hold on a window to drag it to a desired location on the screen.
Change the display order when windows overlap	Click a window and then click  to keep the window on top of other windows, or click  to keep the it at the bottom.

Note: When the editor mode is enabled, the OSD menu will not be accessible and the hotkeys functionality will be disabled.

5. When you finish configuring, click  to quit the editor mode.

The OSD Menu

The OSD menu contains all the display settings and system settings for the Multi-View KVMP™ Switch.

FW Ver V1.0.078.001		X
General	OSD Language	English
Display	Pushbutton Lock	Disable
Port Configuration	Logout Timeout	30s
Advance	Active BeePer	Enable
Password	Keyboard Language	English
Maintenance	Hardware Cursor	Enable
	HSM	[Numl-]
	Menu Hotkey	Scroll*2

Password Protection

By default, the Multi-View KVMP™ Switch's OSD Menu is protected by password and will be locked if the system has not been operated for over **30 seconds**. This is to secure the advanced settings from general operations. To regain access to the OSD Menu, enter the default password, **password**. When the OSD is locked, you will still be able to perform the following operations via the Quick Access Toolbar in the OSD:

- ◆ Change the display mode
- ◆ Switch sources
- ◆ Resize and relocate the windows in any multiview mode
- ◆ Change the display order of the PoP mode
- ◆ Save configurations
- ◆ Apply preset configurations
- ◆ Swap ports
- ◆ Re-assign channel position in any multiview mode

Note:

- ◆ To disable password protection or to change the password, go to **Password > Password Protection** in the OSD Menu.
 - ◆ To configure the timeout setting, go to **General > Logout Timeout** in the OSD Menu.
-

Accessing the OSD Menu

To display the OSD menu, use any of the following methods:

- ◆ Press the OSD pushbutton on the front panel
- ◆ Press the OSD button on the IR remote control
- ◆ Tap **[Scroll Lock]** twice on the console keyboard
- ◆ Click  from the Quick Access Toolbar using the console mouse

The following settings are available in the OSD Menu. Default settings are indicated in bold.

Setting	Options	Description
General		
OSD Language	English / Chinese TW / Chinese CN / Japanese, Korean / French / German / Italian / Russian	Sets the language for the OSD menu.
Pushbutton Lock	Enable / Disable	Locks or unlocks the Multi-View KVMP™ Switch's panel pushbuttons.
Logout Timeout	Never / 10s / 30s / 60s / 5 mins / 10 mins	Sets how long the OSD waits (or the RS-232 controller remains linked to the Multi-View KVMP™ Switch) after the last input (or command) before automatically logging out a user.
Active Beeper	Enable / Disable	Enable this function for Multi-View KVMP™ Switch to sound a beep to indicate and confirm user configuration.

Setting	Options	Description
Display B Status	Follow A / Port 1 / Port 2 / Port 3 / Port 4	Sets the video source of the display connected to the HDMI Console Port 2 on the CM1284.
Keyboard Language	English / German / Japanese / French	Sets the language of the console keyboard. For these options to be available, make sure to enable Keyboard Emulation in the OSD menu.
Hardware Cursor	Enable / Disable	Enable this function to allow the use of console mouse to customize division sizes, shift between divisions, and display the Quick Access Toolbar. The Channel Editor provides a way to change display modes and other settings with the mouse and an on-screen control panel. Note: Mouse Emulation must be enabled for Hardware Cursor Mode to work (see <i>Mouse Emulation</i> , page 62).
HSM	[Num][-] / [Ctrl][F12]	Defines the hotkey combination for enabling the Hotkey Setting Mode (HSM).
Menu Hotkey	Scroll*2 / Ctrl*2	Sets the hotkey combination for opening the menu.

Display

Channel Info	Enable / Disable	Enable this setting to display port ID numbers and device names.
Multiview Mode	Single / Quad / PiP2 / PiP3 / PiP4 / PoP / PbP1 / PbP2 / PbP3 / Fn1 / Fn2 / Fn3 / Fn4	Sets or changes the display mode for the Multi-View KVMP™ Switch. For details about each display mode, see <i>Display Modes</i> , page 35.

Setting	Options	Description
Channel 1	Port 1 / Port 2 / Port 3 / Port 4	Sets the source assignment for each channel. For example, if you select Port 2 for Channel 1, port 2 source will be displayed on Channel 1, and port 1 source will be displayed at Channel 2.
Channel 2	Port 1 / Port 2 / Port 3 / Port 4	
Channel 3	Port 1 / Port 2 / Port 3 / Port 4	
Channel 4	Port 1 / Port 2 / Port 3 / Port 4	
Save to Fn	Fn1 / Fn2 / Fn3 / Fn4	Saves the view mode settings to the selected Function mode.
Toolbar Position	Top / Bottom	Sets the position of the Quick Access Toolbar.

Port Configuration

Port 1 Name	N/A	Type to name the computers connected to port 1 / port 2 / port 3 / port 4 on the Multi-View KVMP™ Switch. The Multi-View KVMP™ Switch only supports English characters of upper and lower cases, numbers, hyphens, and underscores.
Port 2 Name	N/A	
Port 3 Name	N/A	
Port 4 Name	N/A	
Port 1 OS	Win / Mac / SUN / SPC	Defines the operating system for each of the connected computers.
Port 2 OS	Win / Mac / SUN / SPC	
Port 3 OS	Win / Mac / SUN / SPC	
Port 4 OS	Win / Mac / SUN / SPC	

Advanced

Expansion	Daisy Chain / Cascade	Sets the Multi-View KVMP™ Switch's deployment type.
Control Station	Station 1 / Station 2 / Station 3 / Station 4	This setting is only available when Expansion is set to Daisy Chain . Select a daisy-chained secondary station for keyboard and mouse control.
Auto Scan	Enable / Disable	Enable this function to have the Multi-View KVMP™ Switch cycle from port to port at the defined Auto Scan Duration. This gives users an automated way of viewing all the computers connected to the ports. Double-click the mouse wheel to switch to the next port.

Setting	Options	Description
Auto Scan Duration	5s / 10s / 15s / 30s / 60s / 90s	This setting is only available when Auto Scan is enabled. Sets the duration that a port has KVM focus before the focus switches to the next port.
Auto Scan Mode	Cycle / Powered-on PC	This setting is only available when Auto Scan is enabled. <ul style="list-style-type: none"> ◆ Cycle: Sets the Auto Scan to cycle through all computers. ◆ Powered on: Sets the Auto Scan to only scan powered on computers.
EDID Mode	Display A / Display B / Remix / ATEN Default	<ul style="list-style-type: none"> ◆ Display A / Display B: This mode sends the EDID of the selected display (Display A or B) to all connected sources. <p>Note:</p> When an error occurs and the video can not be displayed using the specified EDID mode, the Multi-View KVMP™ Switch will automatically default the EDID mode to ATEN Default. ◆ Remix: This mode sends the optimum EDID to all connected displays. ◆ ATEN Default: This mode sends ATEN-predefined EDID to the connected sources.
Keyboard Emulation	Enable / Disable	Enable keyboard emulation to allow for error-free booting and hotkey functionality. <p>Note:</p> <ul style="list-style-type: none"> ◆ PC keyboard combinations emulate Sun/Mac keyboards. ◆ Sun/Mac keyboards only work with their own computers.
Mouse Emulation	Enable / Disable	Enable mouse emulation to allow for error-free booting. Mouse emulation must be enabled for Hardware Cursor Mode, Channel Wheel Mode, and Mouse Switching to work.

Setting	Options	Description
Mouse Wheel Switching	Enable / Disable	Enable this function to allow the mouse wheel to switch to the next port when it is clicked twice. Note: This function applies to 3-key USB wheel mice only.
Power On Detection	Enable / Disable	Enable this function to have the Multi-View KVMP™ Switch switch to the next powered-on computer when a computer that has KVM focus is powered off.
Password		
Password Protection	Enable / Disable	Enable this function to password protect access to the OSD menu. The default password is password .
Change Password	Enable / Disable	Enable this function to change the login password for the OSD menu. This setting is only available when Password Protection is enabled. Note: The password is case-sensitive and only supports English alphabets and/or numeric characters.
Maintenance		
Firmware Upgrade	Yes / No	Select Yes to perform a firmware upgrade. For details about firmware upgrades, see <i>Firmware Upgrades</i> , page 97.
Save Configuration	Profile 1 / Profile 2 / Profile 3 / Profile 4	Select an option to back up the current OSD configuration.
Load Configuration	Profile 1 / Profile 2 / Profile 3 / Profile 4	Select an option load a previously backed up OSD configuration.
Reset to Default	Yes / No	Select Yes to set the Multi-View KVMP™ Switch to default.
MFG No.	Read-only information	Displays the manufacturing code of the Multi-View KVMP™ Switch.

Chapter 6

RS-232 Operation

Overview

The Multi-View KVMP™ Switch supports system control via RS-232 serial commands sent through a PC or a high-end controller. Note that the RS-232 serial control is only possible when the Multi-View KVMP™ Switch is not daisy-chained with any secondary unit because the Switch's **DCC In** port is required as the communication port for serial control.

Setup

1. Connect your controller or PC to the Multi-View KVMP™ Switch.
Use an RJ-45 to DB-9 serial adapter (SA0141) to connect the computer's serial port to the *DCC In* port of the Multi-View KVMP™ Switch, as shown below:

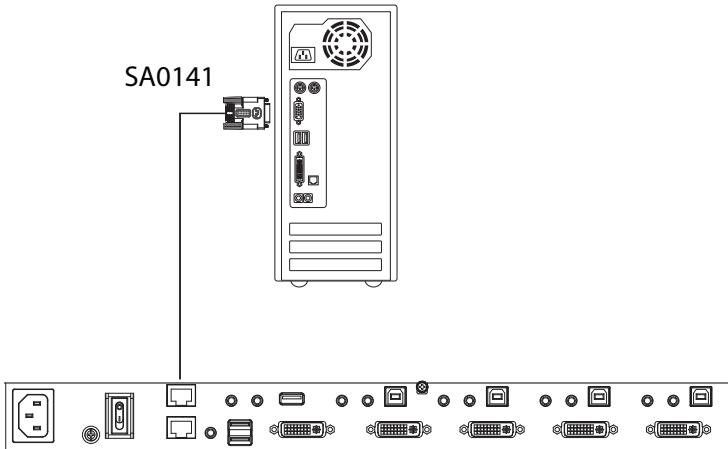

2. Download controller software that supports RS-232 serial control and the operating system of your controller PC.

3. Execute the software and configure the connection settings as follows:
 - ◆ Serial line to connect to: **COM1**
 - ◆ Speed (baud): **19200**
 - ◆ Data bits: **8**
 - ◆ Stop bits: **1**
 - ◆ Parity: **None**
 - ◆ Flow Control: **None**
4. When the session is connected, you can send RS-232 commands to control the Multi-View KVMP™ Switch from the controller PC. For information on RS-232 commands, see *RS-232 Commands*, page 65.

RS-232 Commands

This section lists the RS-232 commands and provides information on command syntax.

Verification Messages

Refer to the following table for details on verification messages that appear in the command line after entering a command.

Verification Message	Description
Command OK	Command or parameter is correct.
Command incorrect	Command or parameter is incorrect.
NOT Login	Command sent without RS-232 login.
login OK	Password correct and login successful.
login FAIL	Incorrect password.
SETTING OK	Some commands support the "save" parameter, so when you input "save" the system will check all current input commands and parameters, and a feedback message of "SETTING OK" will return if all commands and parameters are correct. Otherwise the system will return a "SETTING FAIL" message.
SETTING FAIL	Some commands support the "save" parameter, so when you input "save" the system will check all current input commands and parameters, and a feedback message of "SETTING FAIL" will return if a command or parameter is incorrect.

Log In

The Login command allows you to login to the Multi-View KVMP™ Switch and begin sending RS-232 commands. When you log in, the RS-232 link is “opened” and the Multi-View KVMP™ Switch will not respond to front panel pushbuttons, hotkeys, OSD, or remote control commands - until the RS-232 link is closed (see *Open/Close RS-232 Link*, page 68). For username/password information, see *Security*, page 79. Type your command in the following format:

Command + Control + Number + [Enter]

Command	Description
login	Login Command

Control	Description
p	Input password

Number	Description
xxxxxx	Sets 6 digit password, x= 0~9

For example, to login to the system with the password 123456, type the following:

login p123456 [Enter]

Note: Each command string can be separated with a space.

Logout

The Logout command allows you to logout of the Multi-View KVMP™ Switch and close the RS-232 link. Type your command in the following format:

Command + [Enter]

Command	Description
logout	Logout Command

For example, to logout of the Multi-View KVMP™ Switch, type the following:

logout [Enter]

Note: Each command string can be separated with a space.

Open/Close RS-232 Link

The Open/Close RS-232 Link command allows you to open/close the link between the computer sending RS-232 commands and the Multi-View KVMP™ Switch. When the link is “open” the Multi-View KVMP™ Switch only accepts RS-232 commands and will not respond to front-panel pushbuttons, hotkeys, OSD, or remote control commands - until the link is closed. The link opens when you log in and closes after 30seconds if no command is sent. To change the timeout settings, configure the Logout Timeout setting in the OSD menu (see page 57). Type your command in the following format:

Command + [Enter]

Command	Description
open	Open RS-232 Link Command
close	Close RS-232 Link Command

For example, to open the RS-232 Link between the computer and Multi-View KVMP™ Switch, type the following:

open [Enter]

For example, to close the RS-232 Link between the computer and Multi-View KVMP™ Switch, type the following:

close [Enter]

Switch Port

The switch port command allows you to switch between computers connected to the Multi-View KVMP™ Switch's ports. Type your command in the following format:

Command + Input Command + [Enter]

Command	Description
sw	Switch Port Command

Input Command	Description
px	Input port number, x= 1~4 (Default: 1) Example: p2

For example, to switch to port 2, type the following:

sw p2 [Enter]

-
- Note:**
1. Each command string can be separated with a space.
 2. The **Port Number** command string can be skipped, and the default value will be used.
-

PiP Mode

The PiP Mode command allows you to change the Picture in Picture display mode settings. Type your command in the following format:

PiP Configuration Setting:

Command + Config1 + Config2 + Config3 + Config4 + Config5 + [Enter]

PiP Setting Execute:

Command + Execute + [Enter]

PiP Advance Setting:

Command + Control1 + Control2 + Config1 + Config2 + Execute + [Enter]

Command	Description
pip2	Picture in Picture Dual Mode
pip3	Picture in Picture Triple Mode
pip4	Picture in Picture Quad Mode

Control	Description
cxy	c: Output channel, x= 1~4 p: Input port, y= 1~4 Example: c2p4

For example, to Enable Channel Scan for Picture in Picture Triple Mode, type the following:

pip3 c2scanon [Enter]

Note:

- ◆ Each command string can be separated with a space.
 - ◆ The **Port Number** command string can be skipped, and the default value will be used.
-

Quad View Mode

The Quad View Mode command allows you to change the Quad View display mode settings. Type your command in the following format:

Command + Control1 + Control2 + Control3 + Control4 + [Enter]

Command + Control + [Enter]

Command	Description
quad	Quad View Mode Command

Control	Description
cxy	c: Output channel, x= 1~4 p: Input port, y= 1~4 Example: c2p4
default	Resets Quad View Mode back to the default setting Example: c1p1~c4p4

For example, to set Quad View Mode you must configure the four channels, as follows:

quad c1p1 c2p2 c3p3 c4p4 [Enter]

For example, to set Quad View Mode to the default settings, type the following:

quad default [Enter]

Note: Each command string can be separated with a space.

Change Display Mode

The Change Display Mode command allows you to change the Display mode being used. Type your command in the following format:

Command + Control + [Enter]

Command	Description
display	Change Display Mode Command

Control	Description
full	Enable console port to full screen display
quad	Enable Quad display mode, console port focus remains the same
pip2	Enable PiP Dual display, console port focus remains the same on channel 1, and channel 2 displays the video of the port next to the console port being displayed
pip3	Enable PiP Triple display, console port focus remains the same on channel 1, with channel 2 and channel 3 displaying the video of the ports next to the console port being displayed
pip4	Enable PiP Quad display, console port focus remains the same on channel 1, with channel 2, channel 3, and channel 4 displaying the video of the ports next to the console port being displayed
pop	Enable PoP display, console port focus remains the same.
pbp1	Enable the dual picture-by-picture display, console port focus remains the same.
pbp2	Enable the triple picture-by-picture display, console port focus remains the same.
pbp3	Enable the quad picture-by-picture display, console port focus remains the same.

For example, to set the Quad display mode, type the following:

display quad [Enter]

Note: Each command string can be separated with a space.

Port Disable

The Port Disable command allows you to disable a ports display from being shown. Type your command in the following format:

Command + Control + Control + [Enter]

Command	Description
chn	Port Disable Command

Control	Description
px	Disable video out of port number, x= 1~4 Example: p3
on	Disable channel display
off	Enable channel display

For example, to set disable the video output of port 4, type the following:

chn p4 on [Enter]

For example, to set enable the video output of port 1, type the following:

chn p1 off [Enter]

Note: Each command string can be separated with a space.

OSD Language

The OSD Language command allows you to change the OSD language setting. Type your command in the following format:

Command + Control + [Enter]

Command	Description
lang	OSD Language Command

Control	Description
en	Change OSD language to English.
ger	Change OSD language to German.
fr	Change OSD language to French.
jp	Change OSD language to Japanese.
tc	Change OSD language to Traditional Chinese.
sc	Change OSD language to Simplified Chinese.
ru	Change OSD language to Russian.
ita	Change OSD language to Italian.
kr	Change OSD language to Korean.

For example, to change the OSD Language to Traditional Chinese, type the following:

lang tc [Enter]

Note: Each command string can be separated with a space.

Keyboard Language Layout

The Keyboard Language Layout command allows you to change the keyboard language layout. Type your command in the following format:

Command + Control + [Enter]

Command	Description
layout	Keyboard Language Layout Command

Control	Description
en	Change the keyboard language layout to English.
ger	Change the keyboard language layout to German.
fr	Change the keyboard language layout to French.
jp	Change the keyboard language layout to Japanese.

For example, to change the keyboard language layout to Japanese, type the following:

layout jp [Enter]

Note: Each command string can be separated with a space.

Set Operating System

The Set Operating System command allows you to set the operating system for a port. Type your command in the following format:

Command + Control + Control1 + [Enter]

Command	Description
os	Set Operating System Command

Control	Description
px	p: Port number, x= 1~4 Example: p2

Control1	Description
auto	Change operating system to Windows
mac	Change operating system to Mac
sun	Change operating system to Sun
spc	Change operating system to SPC (Linux)

For example, to change port 3's operating system to Mac, type the following:

os p3 mac [Enter]

For example, to change port 2's operating system to Auto Detect, type the following:

os p2 auto [Enter]

Note: Each command string can be separated with a space.

Auto Scan

The Auto Scan command allows you to set and enable Auto scan mode. Type your command in the following format:

Command + Control + [Enter]

Command	Description
scan	Auto Scan Command

Control	Description
all	Auto scan all ports
pon	Auto scan all ports with computers powered on
txx	Sets the KVM focus duration when scanning, xx= 5, 10, 15, 60, 90 seconds Example: t60

For example, to auto scan all ports, type the following:

scan all [Enter]

For example, to set the scan's focus on each port for a duration of 15 seconds before continuing on, type the following:

scan t15 [Enter]

Note: Each command string can be separated with a space.

Port ID Display

The Port ID Display command allows you to configure the port ID for each port. Type your command in the following format:

Command + Control + [Enter]

Command	Description
portid	Port ID Display Command

Control	Description
p <code>xyy</code>	Change the port ID number. x= 1~4 (Current Port ID) yy = A ~ Z, a ~ z, 0 ~ 9, dash, underscore, maximum 20 characters (New Port ID)
default	Reset all port IDs to the factory default.

For example, to set all port ID's to the factory default, type the following:

portid default [Enter]

For example, to change port 4's ID number to **Computer_A**, type the following:

portid pComputer_A [Enter]

Note: Each command string can be separated with a space.

Security

The Security command allows you to password protect the OSD menu. Use the **Formula** - to set **Parameters** - to create a **Command**.

Formula:

Command + Control + [Enter]

Command	Description
security	Security Command

Control	Description
off	Disable password protection to the OSD menu.
on	Enable password protection to the OSD menu.

For example, to enable password protection of the OSD menu, type the following:

security on [Enter]

Note: Each command string can be separated with a space.

Station

The Station command allows you to switch the console focus to the next station in a daisy chain setup. Type your command in the following format:

Command + Control + Number + [Enter]

Command	Description
station	Station Command

Control	Description
id	Station ID

Number	Description
x	Station number of switch in daisy chain, x= 1~4

For example, to switch the console to station 2 of a daisy chain, type the following:

station id2 [Enter]

Note: Each command string can be separated with a space.

DCC Control

The DCC Control command allows you to enable/disable the DCC Control mode for the Multi-View KVMP™ Switch. Type your command in the following format:

Command + Control + [Enter]

Command	Description
clone on	Sets the default DCC clone mode.
clone off	
dcc on	Sets the Multi-View KVMP™ Switch to the daisy chain mode.
dcc off	Sets the Multi-View KVMP™ Switch to the cascade mode.

Control	Description
off	Disables the specified command.
on	Enables the specified command.

For example, to enable DCC control, type the following:

dcc on [Enter]

Note: Each command string can be separated with a space.

Mouse Emulation

The Mouse Emulation command allows you to set mouse emulation and mouse switching features. Type your command in the following format:

Command + Control + [Enter]

Command + Control2 + [Enter]

Command	Description
msemu	Mouse Emulation Command

Control	Description
off	Disable mouse emulation function
on	Enable mouse emulation function

Control2	Description
wheeloff	Disable mouse switching function
wheelon	Enable mouse switching function

For example, to disable mouse emulation, type the following:

msemu off [Enter]

For example, to enable mouse switching, type the following:

msemu wheelon [Enter]

Note: Each command string can be separated with a space.

Keyboard Emulation

The Keyboard Emulation command allows you to enable/disable the keyboard emulation feature. Type your command in the following format:

Command + Control + [Enter]

Command	Description
kbemu	Keyboard Emulation Command

Control	Description
off	Disable keyboard emulation function
on	Enable keyboard emulation function

For example, to disable keyboard emulation, type the following:

kbemu off [Enter]

For example, to enable keyboard emulation, type the following:

kbemu on [Enter]

Note: Each command string can be separated with a space.

Video DynaSync

The Video DynaSync command allows you to set the EDID settings. Type your command in the following format:

Command + Control + [Enter]

Command	Description
vds	Video DynaSync Command

Control	Description
default	Set the EDID to ATEN default settings: <ul style="list-style-type: none">◆ For CM1164A, the resolution is 1920 x 1080 @60Hz◆ For CM1284, the resolution is 4096 x 2160 @30Hz
port 1	Set the EDID to the EDID of the monitor connected to port 1 of the Multi-View KVMP™ Switch.
port 2	Set the EDID to the EDID of the monitor connected to port 2 of the CM1284.
remix	Set the EDID to an optimum among all the connected displays.

For example, to set the default EDID setting, type the following:

vds default [Enter]

For example, to enable EDID detection, type the following:

vds on [Enter]

Note: Each command string can be separated with a space.

Hardware Cursor

The Hardware Cursor command allows you to enable/disable the hardware cursor feature. Type your command in the following format:

Command + Control + [Enter]

Command	Description
hc	Hardware Cursor Command

Control	Description
off	Disable the hardware cursor
on	Enable the hardware cursor

For example, to enable the hardware cursor, type the following:

hc on [Enter]

Note: Each command string can be separated with a space.

Activate Beeper

The Activate Beeper command allows you to enable/disable the beeper function. Type your command in the following format:

Command + Control + [Enter]

Command	Description
beeper	Activate Beeper Command

Control	Description
off	Disable beeper
on	Enable beeper

For example, to enable the beeper, type the following:

beeper on [Enter]

Note: Each command string can be separated with a space.

Hotkey Setting

The Hotkey Setting command allows you to enable/disable and change the hotkey used to invoke the HSM (Hotkey Setting Mode). Type your command in the following format:

Command + Control + [Enter]

Command	Description
hotkey	Hotkey Setting Command

Control	Description
num	Change the HSM invoke key to: [Num Lock] + [-]
f12	Change the HSM invoke key to: [Ctrl] + [F12]
off	Disable hotkey function
on	Enable hotkey function

For example, to enable the hotkey function, type the following:

hotkey on [Enter]

For example, to change the HSM invoke key to [Ctrl] + [F12], type the following:

hotkey f12 [Enter]

Note: Each command string can be separated with a space.

OSD Hotkey

The OSD hotkey command allows you to change the hotkey used to invoke the OSD. Type your command in the following format:

Command + Control + [Enter]

Command	Description
osdkey	OSD hotkey command

Control	Description
scroll	Change OSD invoke key to: [Scroll] [Scroll]
ctrl	Change OSD invoke key to: [Ctrl] [Ctrl]

For example, to change the OSD invoke key to [Scroll] + [Scroll], type the following:

osdkey scroll [Enter]

For example, to change the OSD invoke key to [Ctrl] + [Ctrl], type the following:

osdkey ctrl [Enter]

Note: Each command string can be separated with a space.

Power on Detection

The Power on Detection command allows you to enable/disable the power on detection feature. Type your command in the following format:

Command + Control + [Enter]

Command	Description
pod	Power on Detection Command

Control	Description
on	Enable power on detection function
off	Disable power on detection function

For example, to enable power on detection, type the following:

pod on [Enter]

Note: Each command string can be separated with a space.

Fn Key

The Fn Key command allows you to save and select Fn keys for a focused ports display settings. Type your command in the following format:

Command + Control + [Enter]

Command	Description
fn	Fn Key Command

Control	Description
save x	Save display setting for current port focus, $x= 1\sim 4$ Example: save3
default	Restore all Fn key settings to the default
select x	Enable display setting for current port focus, $x= 1\sim 4$ Example: select2

For example, to save the display setting and current port focus as Fn1, type the following:

fn save1 [Enter]

For example, to set all Fn keys back to the default, type the following:

fn default [Enter]

Note: Each command string can be separated with a space.

USB Reset

The USB Reset command allows you to reset the USB connection. Type your command in the following format:

Command + Control + [Enter]

Command	Description
usbreset	USB Reset Command

Control	Description
on	Enable USB reset connection

For example, to reset the USB connection, type the following:

usbreset on [Enter]

Note: Each command string can be separated with a space.

Restore Default Value

The Restore Default Value command allows you to reset all of the Multi-View KVMP™ Switch's settings back to the default. Type your command in the following format:

Command + Control + [Enter]

Command	Description
redefault	Restore Default Value Command

Control	Description
on	Enable restore default values

For example, to restore all Multi-View KVMP™ Switch settings back to the default, type the following:

redefault on [Enter]

Note: Each command string can be separated with a space.

Firmware Upgrade

The Firmware Upgrade command allows you to enable the firmware upgrade mode. Type your command in the following format:

Command + Control + [Enter]

Command	Description
upgrade	Firmware Upgrade Command

Control	Description
on	Enable firmware upgrade mode

For example, to enable firmware upgrade mode, type the following:

upgrade on [Enter]

Note: Each command string can be separated with a space.

KVM Status

The KVM Status command allows you to display read-only information about the Multi-View KVMP™ Switch's current configuration status. Type your command in the following format:

Command + [Enter]

Command	Description
status	KVM Status Command

For example, to display the Multi-View KVMP™ Switch's configuration status, type the following:

status [Enter]

Hotkey List

The Hotkey List command allows you to display a list of the KVM's hotkeys. Type your command in the following format:

Command + [Enter]

Command	Description
list	Hotkey List Command

For example, to display the KVM's hotkey list, type the following:

list [Enter]

Info

The Info command allows you to display the Multi-View KVMP™ Switch's current firmware version and copyright information. Type your command in the following format:

Command + [Enter]

Command	Description
info	Info Command

For example, to display the Multi-View KVMP™ Switch's device information, type the following:

info [Enter]

Chapter 7

System Maintenance

Firmware Upgrades

The Windows-based Firmware Management Utility provides a smooth, automated process for upgrading the Multi-View KVMP™ Switch's firmware. New firmware packages are posted on our Website as new firmware revisions become available. Check the web site regularly to find the latest packages and information.

To upgrade your Multi-View KVMP™ Switch, follow the steps below.

1. Connect a PC to the Multi-View KVMP™ Switch's USB KVM Port 1 using a USB cable.

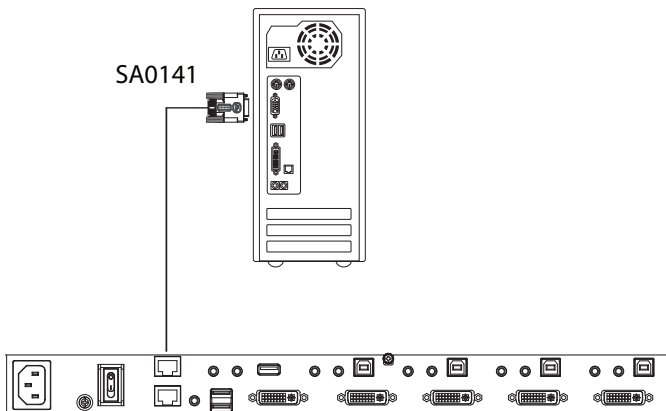

2. Download the firmware upgrade package.
 - a) From the computer you just connected to the Multi-View KVMP™ Switch, go to the web page for your model of the Multi-View KVMP™ Switch.
 - b) Click the **Support and Downloads** tab and download the Firmware Upgrade Package.
3. Use one of the following methods to enable the Firmware Upgrade setting.
 - ◆ From the OSD menu, set the Firmware Upgrade setting to **Yes**. All the LEDs flash orange to indicate that Firmware Upgrade Mode is in effect.

- ◆ Use the hotkeys: Invoke the HSM, press **[u][p][g][r][a][d][e]**, and then press **[Enter]**.

All the LEDs flash orange to indicate that the Firmware Upgrade Mode is in effect.

Note: The console mouse and hotkey functionality will be suspended while the upgrade is in progress.

4. Run the downloaded Firmware Upgrade Package file – either by double clicking the file icon, or by executing the upgrade command (page 93). This screen appears.



5. Select the **Firmware Upgrade Utility** and click **Next**. This window appears.

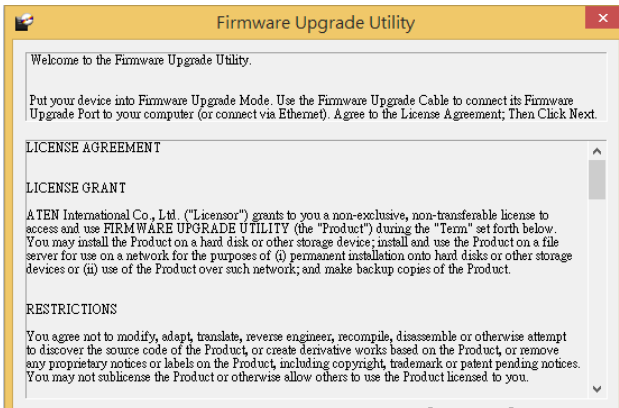

6. Read the License Agreement, select **I Agree**, and click **Next**. The Firmware Upgrade Utility main screen appears. All the devices capable of being upgraded by the package are listed in the Device List panel.

7. Select a device from the Device List. The device description appears in the Device Description panel. Click **Next** to start the upgrade.

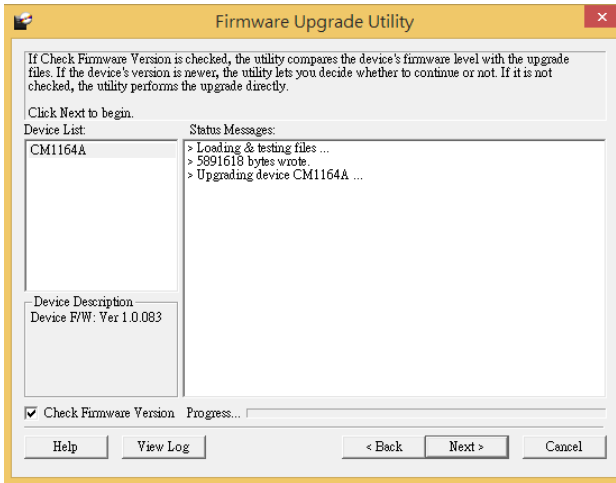

Note: Select **Check Firmware Version** for the Utility to compare the device's firmware version with that of the upgrade files. If the device's firmware is of a newer version, you will be prompted to verify if you wish to proceed with the downgrade.

8. After the upgrade is complete, a screen appears to inform you that the procedure is successful and then the KVM Switch reboots itself.

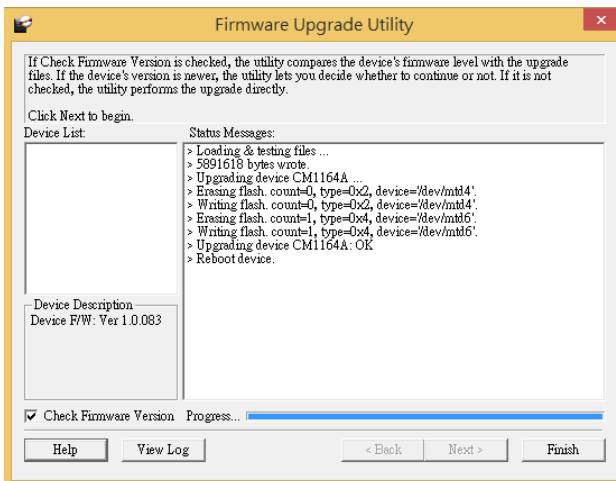

Backup / Restore

To backup/restore the Multi-View KVMP™ Switch's OSD configuration, do the following:

1. Use an RJ-45 to DB-9 serial adapter (SA0141) to connect the computer's serial port to the **RS232 In** port on the KVM Switch.

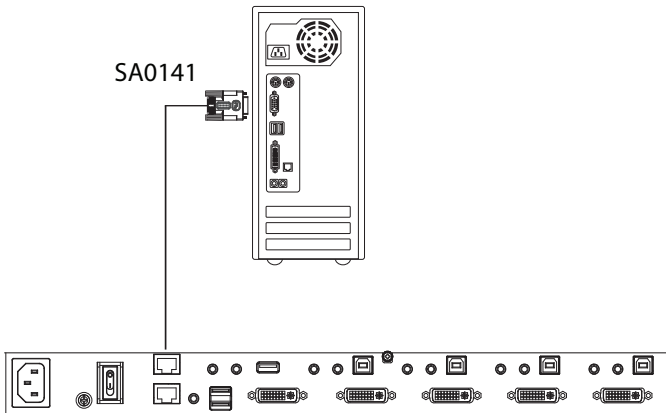

2. Download the most recent firmware package from our website. Open the OSD and go to **Maintenance > Firmware Upgrade**.
3. Run the Firmware Management Utility, select **OSD Configuration Backup/Restore** and click **Next**



- At the next screen click **Connect**.

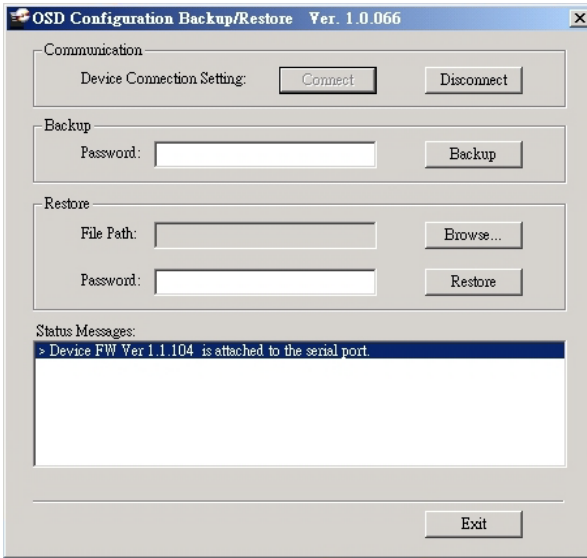

- If the computer is connected correctly a message will appear in the *Status Messages*:

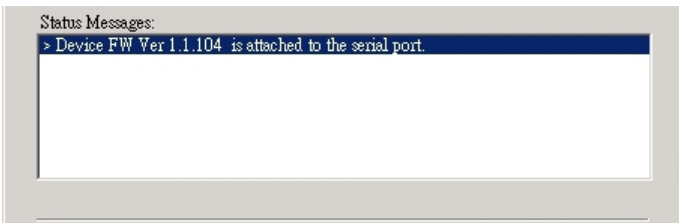

- To backup the OSD configuration, in the *Password* field, key in a password for the file and click **Backup**.

Note: 1. Setting a password is optional. If you do not set one, the file can be restored without specifying a password.

2. If you do set a password, make a note of it, since you will need it to be able to restore the file.

- When the confirmation message appears, click **Yes**.

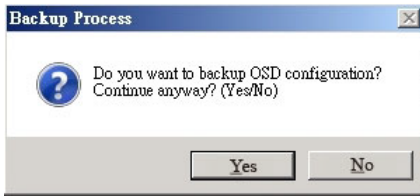

8. Provide a name for the backup and click **Save**.



9. A message appears indicating the backup was successful.

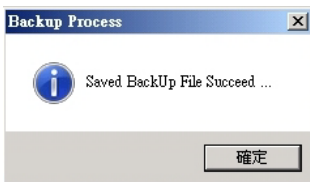

10. To restore an OSD configuration, in the *Password* field, key in a password for the file (optional) and click **Browse**.

11. Open the restore file and click **Yes**.

12. The OSD configuration is restored and the KVM Switch automatically restarts.

Powering Off and Restarting

If it becomes necessary to power off the unit, before starting it back up you must do the following:

1. Shut down all the computers that are attached to the switch.
2. Unplug the switch's power adapter cable.
3. Wait 10 seconds, then plug the switch's power adapter cable back in.
4. After the switch is up, Power On the computers.

Restoring to Default Settings

To reset your complete KVM installation to the factory default settings, set the Reset to Default setting to **Yes** in the OSD menu.

This Page Intentionally Left Blank

Safety Instructions

General

- ◆ This product is for indoor use only.
- ◆ Read all of these instructions. Save them for future reference.
- ◆ Follow all warnings and instructions marked on the device.
- ◆ Do not place the device on any unstable surface (cart, stand, table, etc.). If the device falls, serious damage will result.
- ◆ Do not use the device near water.
- ◆ Do not place the device near, or over, radiators or heat registers.
- ◆ The device cabinet is provided with slots and openings to allow for adequate ventilation. To ensure reliable operation, and to protect against overheating, these openings must never be blocked or covered.
- ◆ The device should never be placed on a soft surface (bed, sofa, rug, etc.) as this will block its ventilation openings. Likewise, the device should not be placed in a built in enclosure unless adequate ventilation has been provided.
- ◆ Never spill liquid of any kind on the device.
- ◆ Unplug the device from the wall outlet before cleaning. Do not use liquid or aerosol cleaners. Use a damp cloth for cleaning.
- ◆ Avoid circuit overloads. Before connecting equipment to a circuit, know the power supply's limit and never exceed it. Always review the electrical specifications of a circuit to ensure that you are not creating a dangerous condition or that one doesn't already exist. Circuit overloads can cause a fire and destroy equipment.
- ◆ The device should be operated from the type of power source indicated on the marking label. If you are not sure of the type of power available, consult your dealer or local power company.
- ◆ The device is designed for IT power distribution systems with 230V phase-to-phase voltage.
- ◆ To prevent damage to your installation, it is important that all devices are properly grounded.
- ◆ The device is equipped with a 3-wire grounding type plug. This is a safety feature. If you are unable to insert the plug into the outlet, contact your

electrician to replace your obsolete outlet. Do not attempt to defeat the purpose of the grounding-type plug. Always follow your local/national wiring codes.

- ◆ Do not allow anything to rest on the power cord or cables. Route the power cord and cables so that they cannot be stepped on or tripped over.
- ◆ If an extension cord is used with this device make sure that the total of the ampere ratings of all products used on this cord does not exceed the extension cord ampere rating. Make sure that the total of all products plugged into the wall outlet does not exceed 15 amperes.
- ◆ To help protect your system from sudden, transient increases and decreases in electrical power, use a surge suppressor, line conditioner, or un-interruptible power supply (UPS).
- ◆ Position system cables and power cables carefully; Be sure that nothing rests on any cables.
- ◆ Never push objects of any kind into or through cabinet slots. They may touch dangerous voltage points or short out parts resulting in a risk of fire or electrical shock.
- ◆ Do not attempt to service the device yourself. Refer all servicing to qualified service personnel.
- ◆ If the following conditions occur, unplug the device from the wall outlet and bring it to qualified service personnel for repair.
 - ◆ The power cord or plug has become damaged or frayed.
 - ◆ Liquid has been spilled into the device.
 - ◆ The device has been exposed to rain or water.
 - ◆ The device has been dropped, or the cabinet has been damaged.
 - ◆ The device exhibits a distinct change in performance, indicating a need for service.
 - ◆ The device does not operate normally when the operating instructions are followed.
- ◆ Only adjust those controls that are covered in the operating instructions. Improper adjustment of other controls may result in damage that will require extensive work by a qualified technician to repair.

Rack Mounting

- ◆ Before working on the rack, make sure that the stabilizers are secured to the rack, extended to the floor, and that the full weight of the rack rests on the floor. Install front and side stabilizers on a single rack or front stabilizers for joined multiple racks before working on the rack.
- ◆ Always load the rack from the bottom up, and load the heaviest item in the rack first.
- ◆ Make sure that the rack is level and stable before extending a device from the rack.
- ◆ Use caution when pressing the device rail release latches and sliding a device into or out of a rack; the slide rails can pinch your fingers.
- ◆ After a device is inserted into the rack, carefully extend the rail into a locking position, and then slide the device into the rack.
- ◆ Do not overload the AC supply branch circuit that provides power to the rack. The total rack load should not exceed 80 percent of the branch circuit rating.
- ◆ Make sure that all equipment used on the rack – including power strips and other electrical connectors – is properly grounded.
- ◆ Ensure that proper airflow is provided to devices in the rack.
- ◆ Ensure that the operating ambient temperature of the rack environment does not exceed the maximum ambient temperature specified for the equipment by the manufacturer
- ◆ Do not step on or stand on any device when servicing other devices in a rack.

Technical Support

International

- ◆ For online technical support – including troubleshooting, documentation, and software updates: **<http://eservice.aten.com>**
- ◆ For telephone support, *Telephone Support*, page iii.

North America

Email Support		support@aten-usa.com
Online Technical Support	Troubleshooting Documentation Software Updates	http://www.aten-usa.com/support
Telephone Support		1-888-999-ATEN ext 4988

When you contact us, please have the following information ready beforehand:

- ◆ Product model number, serial number, and date of purchase.
- ◆ Your computer configuration, including operating system, revision level, expansion cards, and software.
- ◆ Any error messages displayed at the time the error occurred.
- ◆ The sequence of operations that led up to the error.
- ◆ Any other information you feel may be of help.

Specifications

Function		CM1164A	CM1284	
Computer Connections		4		
Port Selection		Front panel Pushbuttons Hotkeys IR Remote Control On-screen Display (OSD), RS-232 Commands		
Connectors	Console Ports	Keyboard	1 x USB Type A Female (Black rear panel)	1 x USB Type A Female (Black, rear panel)
		Video	1 x Single Link DVI-D Female (White)	2 x HDMI Female (Black)
		Mouse	1 x USB Type A Female (Black rear panel)	1 x USB Type A Female (Black, rear panel)
		Speaker	2 x 3.5mm Audio Jack Female (Green; 1 x front panel, 1 x rear panel)	
		Mic.	2 x 3.5mm Audio Jack Female (Pink; 1 x front, 1 x rear)	
		DC Control	2 x RJ-45	
	KVM Ports	KB/Mouse	4 x USB Type B Female (White)	
		Video	4 x Single Link DVI-D Female (White)	4 x HDMI Female (Black)
		Speaker	4 x Mini Stereo Jack Female (Green)	
		Mic.	4 x Mini Stereo Jack Female (Pink)	
	Power	1 x IEC60320-1 Appliance Inlet (Type C14)	1 x IEC320 Jack	
	USB Hub	2 x USB 2.0 Type A Female (1 x front panel, 1 x rear panel)		
	Emulation	Keyboard / Mouse	USB	
	Switches	Selected	11 pushbuttons	
Video		1920 x 1200 @ 60Hz (DVI-D)	4096 x 2160 @ 30Hz (HDMI)	
LEDs	KVM	4 (Orange)		
	Audio	4 (Green)		
	USB	4 (Green)		
Scan Interval		5, 10, 15, 30, 60, 90 secs (Default: 5 secs)		
Maximum Input Power Rating		100 - 200Vac, 50 - 60Hz, 1.0A	100 - 240Vac, 50 - 60Hz, 1.0A	
Power Consumption		AC110V/9.7W:71BTU AC220V/9.5W:70BTU	AC110V:16.0W; AC220V:14.8W	
Environment	Operating Temp.	0–40°C	0–50°C	
	Storage Temp.	-10–60°C	-20–60°C	
	Humidity	0–80% RH, Non-condensing	0–95% RH, Non-condensing	

Function		CM1164A	CM1284
Physical Properties	Housing	Metal	
	Weight	2.46 kg	
	Dimensions (L x W x H)	43.72 x 16.40 x 4.40 cm	

Troubleshooting













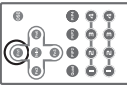
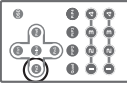
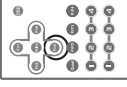

Operation problems can be due to a variety of causes. The first step in resolving them is to make sure that all cables are securely attached and seated completely in their sockets. In addition, updating the product's firmware may solve problems that have been discovered and resolved since the prior version was released. If your product is not running the latest firmware version, we strongly recommend that you upgrade. For details, see *Firmware Upgrades*, page 97.

Symptom	Possible Cause	Action
Mouse and/or Keyboard not responding.	Improper mouse and/or keyboard reset.	Unplug the cable(s) from the console port(s), then plug it/them back in.
	KVM switch needs to be reset.	Power off all devices on the installation (see safety note, page 13); power off the KVM switch; wait five seconds; then power up
USB devices not responding.	USB ports need to reset.	Unplug the device's USB cable from the USB port on the switch's rear panel, then plug it back in.
	PC or OS does not support USB 2.0.	The Multi-View KVMP™ Switch has a built-in USB 2.0 hub, so does not support PCs or OS that do not support USB 2.0.
Device not recognized (Windows).	Windows timing problem.	Unplug the KVM cable from the computer's USB port; go into Windows' <i>System Settings</i> and remove the <i>Unknown Device</i> entry; plug the KVM cable back in. Windows now recognizes the device.
Cannot switch ports by pressing [Scroll Lock] twice	Keyboard is incompatible with Scroll Lock invocation.	Press Ctrl key instead.
Monitor does not display after a KVM cable is hot plugged.	Some DVI graphics cards are incompatible with the KVM cable hot plugging.	Power off all devices on the installation (see safety note, page 13); power off the Multi-View KVMP™ Switch; confirm all KVM cables are properly connected; power on the Multi-View KVMP™ Switch; power on the computers
When switching ports, the monitor does not display.	Monitor is new or this is a first time installation.	Switch ports again and wait two or more seconds for the PC's EDID to pass to the monitor.
The GUI connection window stalls / does not connect	The Multi-View KVMP™ Switch needs to be reset.	Perform a KVM reset or reinstall the latest Multi-View KVMP™ Switch software on all your computers.

Fn Key Reference









Use the information below as a quick reference to invoke the Fn keys.

Choose a preset configuration (Fn keys)

Preset configuration	Fn1	Fn2	Fn3	Fn4
KVM Front Panel				
IR Remote				
Quick Access Toolbar (mouse)				
Keyboard Hotkey				

Mac Keyboard Emulation







The PC compatible (101/104 key) keyboard can emulate the functions of the Mac keyboard. The emulation mappings are listed in the table below.

PC Keyboard	Mac Keyboard
[Shift]	Shift
[Ctrl]	Ctrl
	
[Ctrl] [1]	
[Ctrl] [2]	
[Ctrl] [3]	
[Ctrl] [4]	
[Alt]	Alt
[Print Screen]	F13
[Scroll Lock]	F14
	=
[Enter]	Return
[Backspace]	Delete
[Insert]	Help
[Ctrl] 	F15

Note: When using key combinations, press and release the first key (Ctrl), then press and release the activation key.

Sun Keyboard Emulation

The PC compatible (101/104 key) keyboard can emulate the functions of the Sun keyboard when the Control key [Ctrl] is used in conjunction with other keys. The corresponding functions are shown in the table below.

PC Keyboard	Sun Keyboard
[Ctrl] [T]	Stop
[Ctrl] [F2]	Again
[Ctrl] [F3]	Props
[Ctrl] [F4]	Undo
[Ctrl] [F5]	Front
[Ctrl] [F6]	Copy
[Ctrl] [F7]	Open
[Ctrl] [F8]	Paste
[Ctrl] [F9]	Find
[Ctrl] [F10]	Cut
[Ctrl] [1]	
[Ctrl] [2]	
[Ctrl] [3]	
[Ctrl] [4]	
[Ctrl] [H]	Help
	Compose
	

Note: When using key combinations, press and release the first key (Ctrl), then press and release the activation key.

Factory Default Hotkeys and Settings

Setting	Hotkey	Default
Invoking HSM	[H]	[Number Lock] [-]
Port Switching (Default / Alternate)	[T]	[Scroll Lock] [Scroll Lock]
Auto Scan Interval	[Scroll Lock] [Scroll Lock] [A] [Enter]	5 seconds
Keyboard Operating Platform	[F10]	PC Compatible
Mouse Emulation	[M]	Enabled
Keyboard Emulation	[N]	Enabled
Mouse Wheel Support	[W]	Disabled
Buzzer	[B]	Enabled
Keyboard Language	[F6] [nn] [Enter] Note: nn is the language number	English

Limited Warranty

ATEN warrants its hardware in the country of purchase against flaws in materials and workmanship for a Warranty Period of two [2] years (warranty period may vary in certain regions/countries) commencing on the date of original purchase. This warranty period includes the LCD panel of ATEN LCD KVM switches. Select products are warranted for an additional year (see *A+ Warranty* for further details). Cables and accessories are not covered by the Standard Warranty.

What is covered by the Limited Hardware Warranty

ATEN will provide a repair service, without charge, during the Warranty Period. If a product is defective, ATEN will, at its discretion, have the option to (1) repair said product with new or repaired components, or (2) replace the entire product with an identical product or with a similar product which fulfills the same function as the defective product. Replaced products assume the warranty of the original product for the remaining period or a period of 90 days, whichever is longer. When the products or components are replaced, the replacing articles shall become customer property and the replaced articles shall become the property of ATEN.

To learn more about our warranty policies, please visit our website:

<http://www.aten.com/global/en/legal/policies/warranty-policy/>