



**THE DISPLAY CHOICE
OF PROFESSIONALS™**

RX-32E, RX-42E & RX-55E LED-Backlit Display

www.agneovo.com

User Manual

TABLE OF CONTENTS

SAFETY INFORMATION	1
Federal Communications Commission (FCC) Notice (U.S. Only).....	1
Polish Center for Testing and Certification Notice	2
Electric, Magnetic and Electromagnetic Fields (“EMF”)	3
Information for U.K. only.....	3
North Europe (Nordic Countries) Information.....	5
End-of-Life Disposal	5
Waste Electrical and Electronic Equipment-WEEE.....	5
Turkey RoHS.....	6
Ukraine RoHS	6
PRECAUTIONS	7
Cautions When Setting Up	7
Cautions When Using.....	8
Cleaning and Maintenance.....	8
Notice for the LCD Display	9
CHAPTER 1: PRODUCT DESCRIPTION.....	10
1.1 Package Contents	10
1.2 Preparing for the Installation	11
1.3 Installing and Removing Table Stands (optional)	11
1.4 Wall Mounting Installation.....	12
1.4.1 VESA Grid	13
1.4.2 Ventilation Requirements for Enclosure Locating.....	13
1.5 Mounting in Portrait Position	14
1.6 Installing OPS Device.....	15
1.7 LCD Display Overview	16
1.7.1 Control Panel.....	16
1.7.2 Input/Output Terminals	19
1.8 Remote Control	22
1.8.1 General Functions	22
1.8.2 ID Remote Control.....	23
1.8.3 Inserting the Batteries in the Remote Control	24
1.8.4 Handling the Remote Control	24
1.8.5 Operating Range of the Remote Control.....	24
CHAPTER 2: MAKING CONNECTIONS.....	25
2.1 Connecting the Power	25
2.2 Connecting a Computer	27
2.2.1 Using VGA Input	27
2.2.2 Using DVI Input	28
2.2.3 Using HDMI Input	30
2.2.4 Using DisplayPort Input.....	31
2.3 Connecting External Equipment (Video Player).....	33
2.3.1 Using COMPONENT Video Input	33

TABLE OF CONTENTS

2.3.2 Using Video Source Input.....	34
2.3.3 Using HDMI Video Input	36
2.4 Connecting Audio Equipment.....	37
2.4.1 Connecting an External Audio Device	37
2.5 Connecting Multiple Displays in a Daisy-chain Configuration	39
2.5.1 Display Control Connection.....	39
2.5.2 Digital Video Connection	39
2.5.3 Analogue Video Connection	41
2.6 IR Connection.....	41
2.7 IR Pass-Through Connection	42
2.8 Connecting to Wired Network.....	42
CHAPTER 3: USING THE LCD DISPLAY.....	43
3.1 Turning on the Power	43
3.2 Selecting the Input Source Signal	43
3.3 Adjusting the Volume.....	44
3.4 Changing the Picture Format	44
3.5 Using the Quick Menu	45
3.6 Playing Multimedia Files via Local Area Network.....	47
3.6.1 Set Up the Network	47
3.6.2 How to Use DLNA-DMP	48
3.6.3 How to Use DLNA-DMR from PC.....	49
3.7 Playing Multimedia Files from USB Device.....	50
3.8 Play Options.....	52
3.8.1 Playing Music Files.....	52
3.8.2 Playing Movie Files	53
3.8.3 Playing Photo Files.....	54
CHAPTER 4: ON SCREEN DISPLAY MENU.....	55
4.1 Using the OSD Menu	55
4.2 OSD Menu Tree	57
CHAPTER 5: ADJUSTING THE LCD DISPLAY	59
5.1 Picture Settings	59
5.2 Sound Settings.....	63
5.3 Tiling Settings.....	65
5.4 General Settings.....	67
5.5 Network Settings	76
CHAPTER 6: APPENDIX.....	79
6.1 Warning Messages.....	79
6.2 USB Device Compatibility	80
6.3 Supported Resolution.....	83
6.4 Cleaning	84
6.5 Troubleshooting.....	85
6.6 Transporting the LCD Display	86

TABLE OF CONTENTS

CHAPTER 7: SPECIFICATIONS	89
7.1 Display Specifications	89
7.2 Display Dimensions	91

SAFETY INFORMATION

Federal Communications Commission (FCC) Notice (U.S. Only)



This equipment has been tested and found to comply with the limits for a Class B digital device, pursuant to part 15 of the FCC Rules. These limits are designed to provide reasonable protection against harmful interference in a residential installation. This equipment generates, uses and can radiate radio frequency energy and, if not installed and used in accordance with the instructions, may cause harmful interference to radio communications. However, there is no guarantee that interference will not occur in a particular installation. If this equipment does cause harmful interference to radio or television reception, which can be determined by turning the equipment off and on, the user is encouraged to try to correct the interference by one or more of the following measures:

- Reorient or relocate the receiving antenna.
- Increase the separation between the equipment and receiver.
- Connect the equipment into an outlet on a circuit different from that to which the receiver is connected.
- Consult the dealer or an experienced radio/TV technician for help.



Changes or modifications not expressly approved by the party responsible for compliance could void the user's authority to operate the equipment.

Use only an RF shielded cable that was supplied with the display when connecting this display to a computer device.

To prevent damage which may result in fire or shock hazard, do not expose this appliance to rain or excessive moisture.

THIS CLASS B DIGITAL APPARATUS MEETS ALL REQUIREMENTS OF THE CANADIAN INTERFERENCE-CAUSING EQUIPMENT REGULATIONS.



This device complies with Part 15 of the FCC Rules. Operation is subject to the following two conditions: (1) this device may not cause harmful interference, and (2) this device must accept any interference received, including interference that may cause undesired operation.

SAFETY INFORMATION

Polish Center for Testing and Certification Notice

The equipment should draw power from a socket with an attached protection circuit (a three-prong socket). All equipment that works together (computer, display, printer, and so on) should have the same power supply source.

The phasing conductor of the room's electrical installation should have a reserve short-circuit protection device in the form of a fuse with a nominal value no larger than 16 amperes (A).

To completely switch off the equipment, the power supply cable must be removed from the power supply socket, which should be located near the equipment and easily accessible.

A protection mark "B" confirms that the equipment is in compliance with the protection usage requirements of standards PN-93/T-42107 and PN-89/E-06251.

Wymagania Polskiego Centrum Badań i Certyfikacji

Urządzenie powinno być zasilane z gniazda z przyłączonym obwodem ochronnym (gniazdo z kolkiem). Współpracujące ze sobą urządzenia (komputer, monitor, drukarka) powinny być zasilane z tego samego źródła.

Instalacja elektryczna pomieszczenia powinna zawierać w przewodzie fazowym rezerwową ochronę przed zwarciami, w postaci bezpiecznika o wartości znamionowej nie większej niż 16A (amperów).

W celu całkowitego wyłączenia urządzenia z sieci zasilania, należy wyjąć wtyczkę kabla zasilającego z gniazdka, które powinno znajdować się w pobliżu urządzenia i być łatwo dostępne.

Znak bezpieczeństwa "B" potwierdza zgodność urządzenia z wymaganiami bezpieczeństwa użytkowania zawartymi w PN-93/T-42107 i PN-89/E-06251.

Pozostałe instrukcje bezpieczeństwa

- Nie należy używać wtyczek adapterowych lub usuwać kolka obwodu ochronnego z wtyczki. Jeżeli konieczne jest użycie przedłużacza to należy użyć przedłużacza 3-żyłowego z prawidłowo połączonym przewodem ochronnym.
- System komputerowy należy zabezpieczyć przed nagłymi, chwilowymi wzrostami lub spadkami napięcia, używając eliminatora przepięć, urządzenia dopasowującego lub bezzakłóceńowego źródła zasilania.
- Należy upewnić się, aby nic nie leżało na kablach systemu komputerowego, oraz aby kable nie były umieszczone w miejscu, gdzie można byłoby na nie nadeptywać lub potykać się o nie.
- Nie należy rozlewać napojów ani innych płynów na system komputerowy.
- Nie należy wpychać żadnych przedmiotów do otworów systemu komputerowego, gdyż może to spowodować pożar lub porażenie prądem, poprzez zwarcie elementów wewnętrznych.
- System komputerowy powinien znajdować się z dala od grzejników i źródeł ciepła. Ponadto, nie należy blokować otworów wentylacyjnych. Należy unikać kładzenia luźnych papierów pod komputer oraz umieszczania komputera w ciasnym miejscu bez możliwości cyrkulacji powietrza wokół niego.

SAFETY INFORMATION

Electric, Magnetic and Electromagnetic Fields (“EMF”)

- We manufacture and sell many products targeted at consumers, which, like any electronic apparatus, in general have the ability to emit and receive electromagnetic signals.
- One of our leading Business Principles is to take all necessary health and safety measures for our products, to comply with all applicable legal requirements and to stay well within the EMF standards applicable at the time of producing the products.
- We are committed to develop, produce and market products that cause no adverse health effects.
- We confirm that if its products are handled properly for their intended use, they are safe to use according to scientific evidence available today.
- We play an active role in the development of international EMF and safety standards, enabling us to anticipate further developments in standardization for early integration in its products.

Information for U.K. only

WARNING - THIS APPLIANCE MUST BE EARTHED.

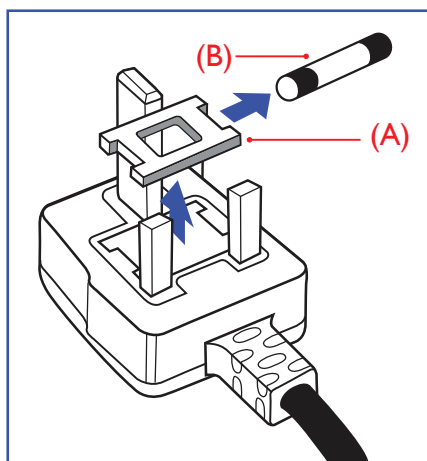

Important:

This apparatus is supplied with an approved moulded 13A plug. To change a fuse in this type of plug proceed as follows:

- 1 Remove fuse cover and fuse.
- 2 Fit new fuse which should be a BS 1362 5A, A.S.T.A. or BSI approved type.
- 3 Refit the fuse cover.



Note:

The severed plug must be destroyed to avoid a possible shock hazard should it be inserted into a 13A socket elsewhere.

SAFETY INFORMATION

If the fitted plug is not suitable for your socket outlets, it should be cut off and an appropriate 3-pin plug fitted in its place.

If the mains plug contains a fuse, this should have a value of 5A. If a plug without a fuse is used, the fuse at the distribution board should not be greater than 5A.

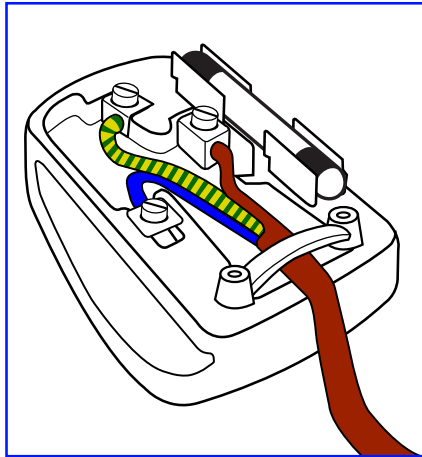

How to connect a plug

The wires in the mains lead are coloured in accordance with the following code:

BLUE - "NEUTRAL" ("N")

BROWN - "LIVE" ("L")

GREEN & YELLOW - "EARTH" ("E")

- The GREEN & YELLOW wire must be connected to the terminal in the plug which is marked with the letter "E" or by the Earth symbol or coloured GREEN or GREEN & YELLOW.
- The BLUE wire must be connected to the terminal which is marked with the letter "N" or coloured BLACK.
- The BROWN wire must be connected to the terminal which marked with the letter "L" or coloured RED.

Before replacing the plug cover, make certain that the cord grip is clamped over the sheath of the lead - not simply over the three wires.

SAFETY INFORMATION

North Europe (Nordic Countries) Information

Placering/Ventilation

WARNING: FÖRSÄKRA DIG OM ATT HUVUDBRYTARE OCH UTTAG ÄR LÄTÅTKOMLIGA, NÄR DU STÄLLER DIN UTRUSTNING PÅPLATS.

Placering/Ventilation

ADVARSEL: SØRG VED PLACERINGEN FOR, AT NETLEDNINGENS STIK OG STIKKONTAKT ER NEMT TILGÆNGELIGE.

Paikka/Ilmankierto

VAROITUS: SIJOITA LAITE SITEN, ETTÄ VERKKOJOHTO VOIDAAN TARVITTAESSA HELPOSTI IRROTTAA PISTORASIESTA.

Plassering/Ventilasjon

ADVARSEL: NÅR DETTE UTSTYRET PLASSERES, MÅ DU PASSE PÅ AT KONTAKTENE FOR STØMTILFØRSEL ER LETTE Å NÅ.

End-of-Life Disposal

Your new Public Information Display contains materials that can be recycled and reused. Specialized companies can recycle your product to increase the amount of reusable materials and to minimize the amount to be disposed of.

Please find out about the local regulations on how to dispose of your old display from your local dealer.

(For customers in Canada and U.S.A.)

This product may contain lead and/or mercury. Dispose of in accordance to local-state and federal regulations. For additional information on recycling contact www.eia.org (Consumer Education Initiative).

Waste Electrical and Electronic Equipment-WEEE

Attention users in European Union private households



This marking on the product or on its packaging illustrates that, under European Directive 2012/19/EU governing used electrical and electronic appliances, this product may not be disposed of with normal household waste. You are responsible for disposal of this equipment through a designated waste electrical and electronic equipment collection. To determine the locations for dropping off such waste electrical and electronic, contact your local government office, the waste disposal organization that serves your household or the store at which you purchased the product.

Attention users in United States:

Please dispose of according to all Local, State and Federal Laws. For the disposal or recycling information, contact: www.mygreenelectronics.com or www.eiae.org.

SAFETY INFORMATION

End of Life Directives-Recycling



Your new Public Information Display contains several materials that can be recycled for new users.

Please dispose of according to all Local, State, and Federal laws.

Restriction on Hazardous Substances statement (India)

This product complies with the "India E-waste Rule 2011" and prohibits use of lead, mercury, hexavalent chromium, polybrominated biphenyls or polybrominated diphenyl ethers in concentrations exceeding 0.1 weight % and 0.01 weight % for cadmium, except for the exemptions set in Schedule 2 of the Rule.

E-Waste Declaration for India



This symbol on the product or on its packaging indicates that this product must not be disposed of with your other household waste. Instead it is your responsibility to dispose of your waste equipment by handing it over to a designated collection point for the recycling of waste electrical and electronic equipment. The separate collection and recycling of your waste equipment at the time of disposal will help to conserve natural resources and ensure that it is recycled in a manner that protects human health and the environment.

Batteries



For EU: The crossed-out wheeled bin implies that used batteries should not be put to the general household waste! There is a separate collection system for used batteries, to allow proper treatment and recycling in accordance with legislation.

Please contact your local authority for details on the collection and recycling schemes.

For Switzerland: The used battery is to be returned to the selling point.

For other non-EU countries: Please contact your local authority for correct method of disposal of the used battery.

According to EU directive 2006/66/EC, the battery can't be disposed improperly. The battery shall be separated to collect by local service.

Turkey RoHS

Türkiye Cumhuriyeti: EEE Yönetmeliğine Uygundur.

Ukraine RoHS

Обладнання відповідає вимогам Технічного регламенту щодо обмеження використання деяких небезпечних речовин в електричному та електронному обладнанні, затвердженого постановою Кабінету Міністрів України від 3 грудня 2008 № 1057.

PRECAUTIONS

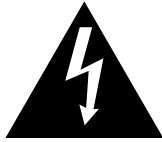

Symbols used in this manual

	This icon indicates the existence of a potential hazard that could result in personal injury or damage to the product.
	This icon indicates important operating and servicing information.

Notice

- Read this User Manual carefully before using the LCD display and keep it for future reference.
- The product specifications and other information provided in this User Manual are for reference only. All information is subject to change without notice. Updated content can be downloaded from our web site at <http://www.agneovo.com>.
- To register online, go to <http://www.agneovo.com>.
- To protect your rights as a consumer, do not remove any stickers from the LCD display. Doing so may affect the determination of the warranty period.

Cautions When Setting Up

- Do not place the LCD display near heat sources, such as a heater, exhaust vent, or in direct sunlight.
- Do not cover or block the ventilation holes in the housing.
- Place the LCD display on a stable area. Do not place the LCD display where it may subject to vibration or shock.
- Place the LCD display in a well-ventilated area.
- Do not place the LCD display outdoors.
- To avoid the risk of shock or permanent damage to the set, do not expose the display to dust, rain, water or an excessively moist environment.
- Do not spill liquid or insert sharp objects into the LCD display through the ventilation holes. Doing so may cause accidental fire, electric shock or damage the LCD display.

PRECAUTIONS

Cautions When Using

- Use only the power cord supplied with the LCD display.
- The power outlet should be installed near the LCD display and be easily accessible.
- If an extension cord is used with the LCD display, ensure that the total current consumption plugged into the power outlet does not exceed the ampere rating.
- Do not allow anything to rest on the power cord. Do not place the LCD display where the power cord may be stepped on.
- If the LCD display will not be used for an indefinite period of time, unplug the power cord from the power outlet.
- To disconnect the power cord, grasp and pull by the plug head. Do not tug on the cord; doing so may cause fire or electric shock.
- Do not unplug or touch the power cord with wet hands.
- When turning off the display by detaching the power cord, wait 6 seconds before re-attaching the power cord for normal operation.
- Do not knock or drop the display during operation or transportation.

Cleaning and Maintenance

- To protect your display from possible damage, do not put excessive pressure on the LCD panel. When moving your display, grasp the frame to lift; do not lift the display by placing your hand or fingers on the LCD panel.
- Unplug the display if you need to clean it with a slightly damp cloth. The screen may be wiped with a dry cloth when the power is off. However, never use organic solvent, such as, alcohol, or ammonia-based liquids to clean your display.
- If your display becomes wet, wipe it with dry cloth as soon as possible.
- If a foreign substance or water gets in your display, turn the power off immediately and disconnect the power cord. Then remove the foreign substance or water, and send the unit to the maintenance center.
- In order to maintain the best performance of your display and ensure a longer lifetime, we strongly recommend using the display in a location that falls within the following temperature and humidity ranges.
 - ◆ Temperature: 0-40°C (32-104°F)
 - ◆ Humidity: 20-80% RH



Warning:



Unplug the power cord from the power outlet and refer to qualified service

personnel under the following conditions:

- ◆ When the power cord is damaged.
- ◆ If the LCD display has been dropped or the housing has been damaged.
- ◆ If the LCD display emits smoke or a distinct odor.

PRECAUTIONS

Notice for the LCD Display

- In order to maintain the stable luminous performance, it is recommended to use low brightness setting.
- Due to the lifespan of the lamp, it is normal that the brightness quality of the LCD display may decrease with time.
- When static images are displayed for long periods of time, the image may cause an imprint on the LCD display. This is called image retention or burn-in.
 - ◆ To prevent image retention, do any of the following:
 - Set the LCD display to turn off after a few minutes of being idle.
 - Use a screen saver that has moving graphics or a blank white image.
 - Execute the Anti-Burn-in™ function of the LCD display. See “Anti-Burn-in” on page 67.
 - Switch desktop backgrounds regularly.
 - Adjust the LCD display to low brightness settings.
 - Turn off the LCD display when the system is not in use.
 - ◆ Things to do when the LCD display shows image retention:
 - Turn off the LCD display for extended periods of time. It can be several hours or several days.
 - Use a screen saver and run it for extended periods of time.
 - Use a black and white image and run it for extended periods of time.
- There are millions of micro transistors inside the LCD display. It is normal for a few transistors to be damaged and to produce spots. This is acceptable and is not considered a failure.
- **IMPORTANT:** Always activate a moving screen saver program when you leave your display unattended. Always activate a periodic screen refresh application if the unit will display unchanging static content. Uninterrupted display of still or static images over an extended period may cause “burn in”, also known as “after-imaging” or “ghost imaging”, on your screen. This is a well-known phenomenon in LCD panel technology. In most cases, the “burned in” or “after-imaging” or “ghost imaging” will disappear gradually over a period of time after the power has been switched off.
- **WARNING:** Severe “burn-in” or “after-image” or “ghost image” symptoms will not disappear and cannot be repaired. This is also not covered under the terms of your warranty.

CHAPTER 1: PRODUCT DESCRIPTION

1.1 Package Contents

When unpacking, check if the following items are included in the package. If any of them is missing or damaged, contact your dealer.

LCD Display



Quick start guide



Remote control

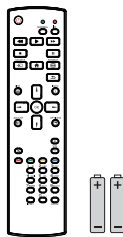

Power cord

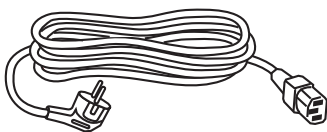

RS232 Daisy-Chain cable

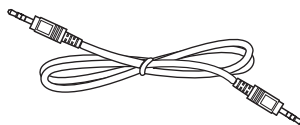

RS232 cable

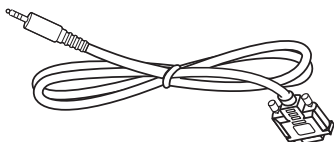

Note:

- ◆ Remote control is shipped with the supplied AAA batteries.
- ◆ For all other regions, apply a power cord that conforms to the AC voltage of the power socket and has been approved by and complies with the safety regulations of the particular country.
- ◆ You might like to save the package box and packing material for shipping the display.

Note:

- ◆ The pictures are for reference only. Actual items may vary upon shipment.

PRODUCT DESCRIPTION

1.2 Preparing for the Installation

- Due to the high power consumption, always use the plug exclusively designed for this product. If an extended line is required, please consult your service agent.
- The product should be installed on a flat surface to avoid tipping. The distance between the back of the product and the wall should be maintained for proper ventilation. Avoid installing the product in the kitchen, bathroom or any other places with high humidity so as not to shorten the service life of the electronic components.
- The product can normally operate only under 5000m in altitude. In installations at altitudes above 3000m, some abnormalities may be experienced.

1.3 Installing and Removing Table Stands (optional)

To install table stands:

- 1 Ensure your display is powered off.
- 2 Spread a protective sheet on a flat surface.
- 3 Grab the carrying handles and place the display face-down on the protective sheet.
- 4 After inserting the stand in the guide block, tighten the screws on both sides of the display.

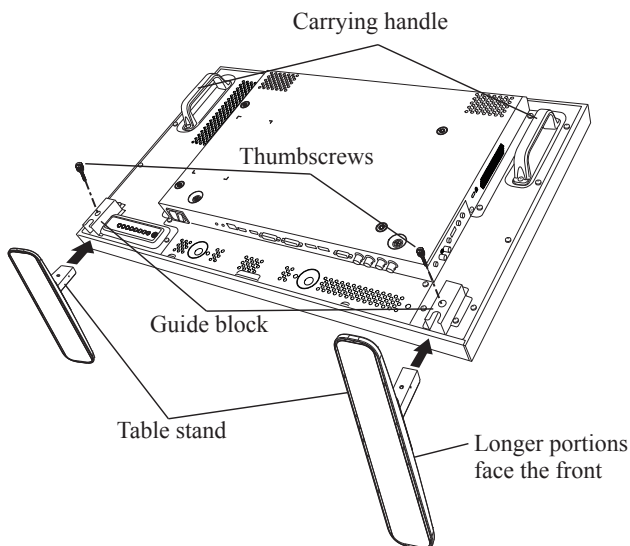

To remove table stands:

- 1 Power off the display.
- 2 Spread a protective sheet on a flat surface.
- 3 Grab the carrying handles and place the display face-down on the protective sheet.
- 4 Remove screws using a screwdriver and place them in a safe place for reuse.



Warning:

- ◆ Do not press too hard on the LCD panel or edge of the frame, as this may cause the device to malfunction.
- ◆ During unpacking, make sure to hold the carrying handles to remove the device from its packaging.

Note:

- ◆ The longer side of the stand should face the front of the display.

PRODUCT DESCRIPTION

1.4 Wall Mounting Installation

To mount this display to a wall, you will have to obtain a standard wall-mounting kit (commercially available). We recommend using a mounting interface that complies with TUV-GS and/or UL1678 standard in North America.

To wall-mount the LCD display, screw the mounting bracket to the VESA holes at the rear of the LCD display.

RX-32E

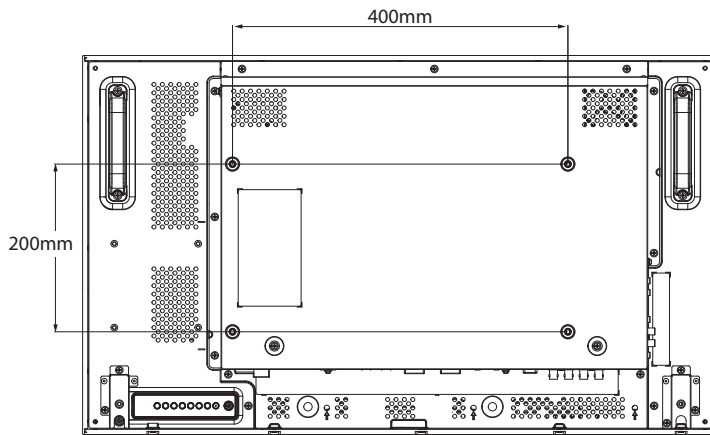

RX-42E

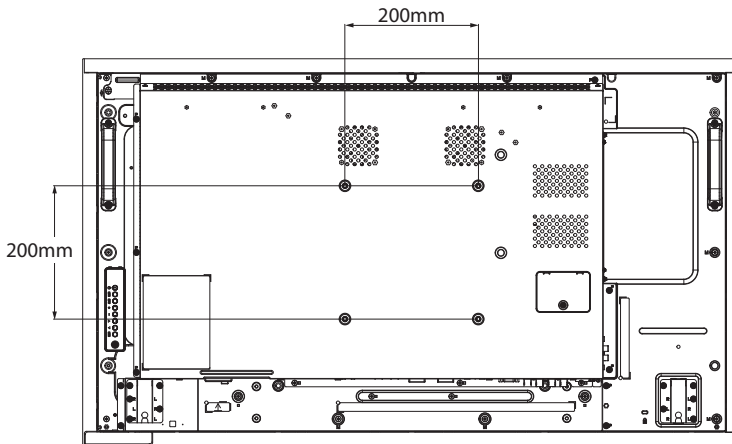

RX-55E

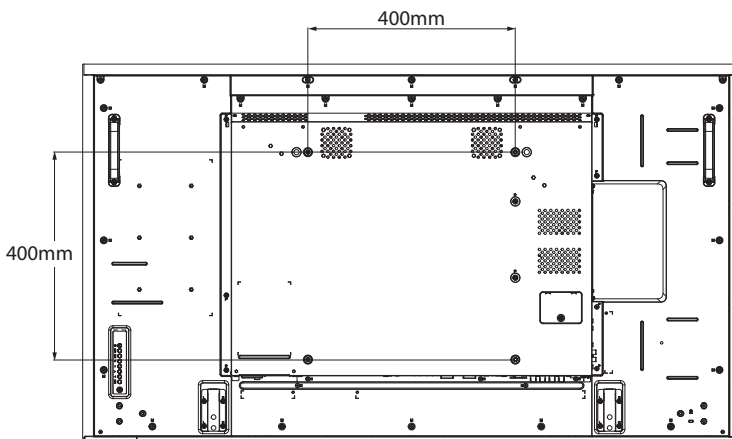

Note:

- ◆ Avoid the wall-mounting kit to block the ventilation holes on the back of the display.
- ◆ Secure the LCD display on a solid wall strong enough to bear its weight.
- ◆ Lay a protective sheet on a table, which was wrapped around the display when it was packaged, beneath the screen surface so as not to scratch the screen face.
- ◆ Ensure you have all accessories for mounting this display (wall mount, ceiling mount, table stand, etc).
- ◆ Follow the instructions that come with the base mounting kit. Failure to follow correct mounting procedures could result in damage to the equipment or injury to the user or installer. Product warranty does not cover damage caused by improper installation.

PRODUCT DESCRIPTION

1.4.1 VESA Grid

Model Name	VESA Grid
RX-32E	400(H) x 200(V) mm
RX-42E	200(H) x 200(V) mm
RX-55E	400(H) x 400(V) mm

Caution:

To prevent the display from falling:

- ◆ For wall or ceiling installation, we recommend installing the display with metal brackets which are commercially available. For detailed installation instructions, refer to the guide received with the respective bracket.
- ◆ To lessen the probability of injury and damage resulting from fall of the display in case of earthquake or other natural disaster, be sure to consult the bracket manufacturer for installation location.

1.4.2 Ventilation Requirements for Enclosure Locating

To allow heat to disperse, leave space between surrounding objects as shown in the diagram below.

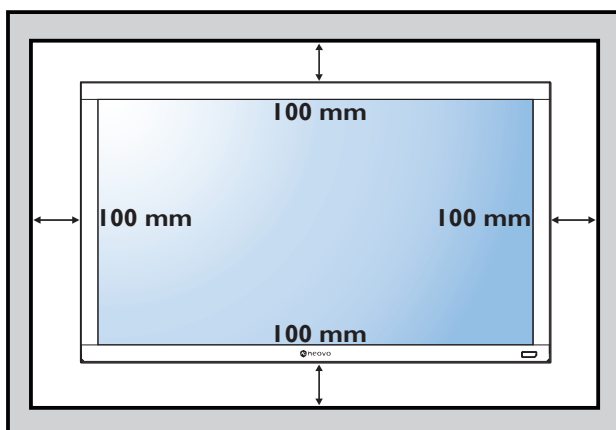

Note:

- ◆ For the wall-mounting kit, use M6 mounting screws (having a length 10 mm longer than the thickness of the mounting bracket) and tighten them securely.
- ◆ The equipment and its associated mounting means still remain secure during the test. For use only with UL Listed Wall Mount Bracket with minimum weight/load:
RX-32E=21.0 kg /
RX-42E=30.7 kg /
RX-55E=47.4 kg

PRODUCT DESCRIPTION

1.5 Mounting in Portrait Position

This display can be installed in portrait position.

- 1 Remove the table stand, if attached.
- 2 To change the display orientation from a landscape orientation to portrait orientation, rotate the device 90 degrees counter-clockwise as illustrated below.

RX-32E

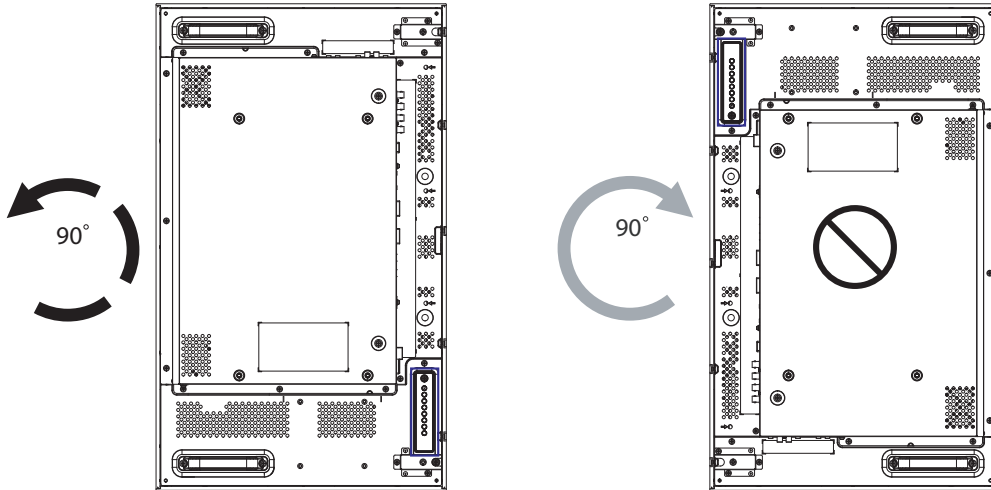

RX-42E

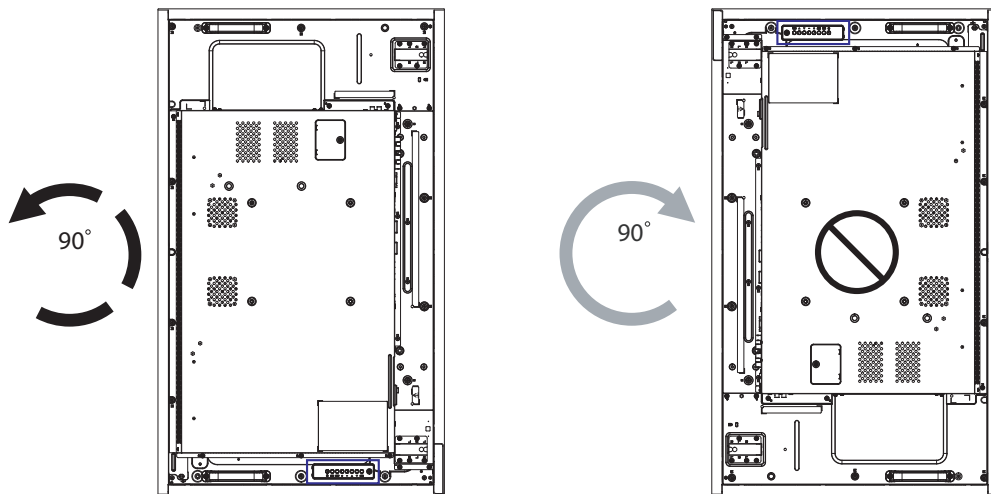

RX-55E

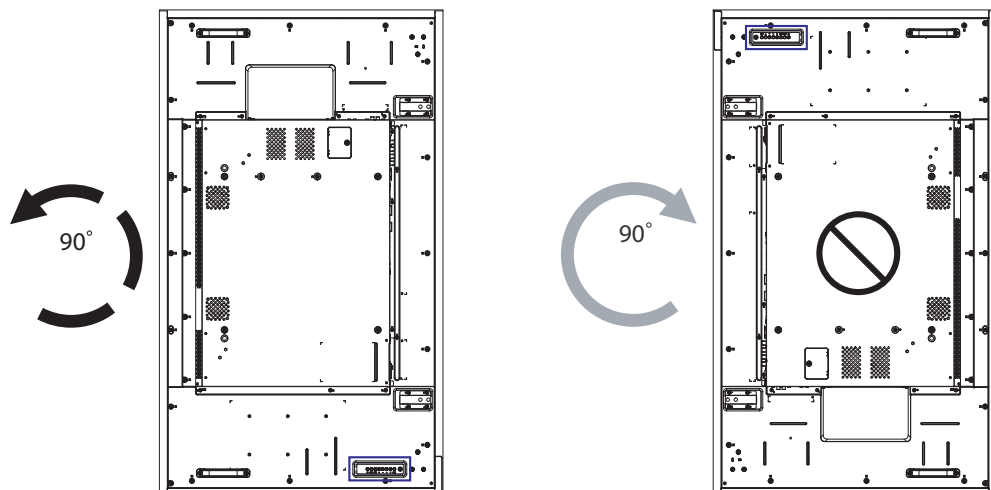

PRODUCT DESCRIPTION

1.6 Installing OPS Device

To install OPS device into its slot on the LCD display, do the following:

- 1 Remove the screws on the OPS cover, and then remove the OPS cover.
- 2 Install the OPS device into its slot.
- 3 Secure the OPS device by screws.

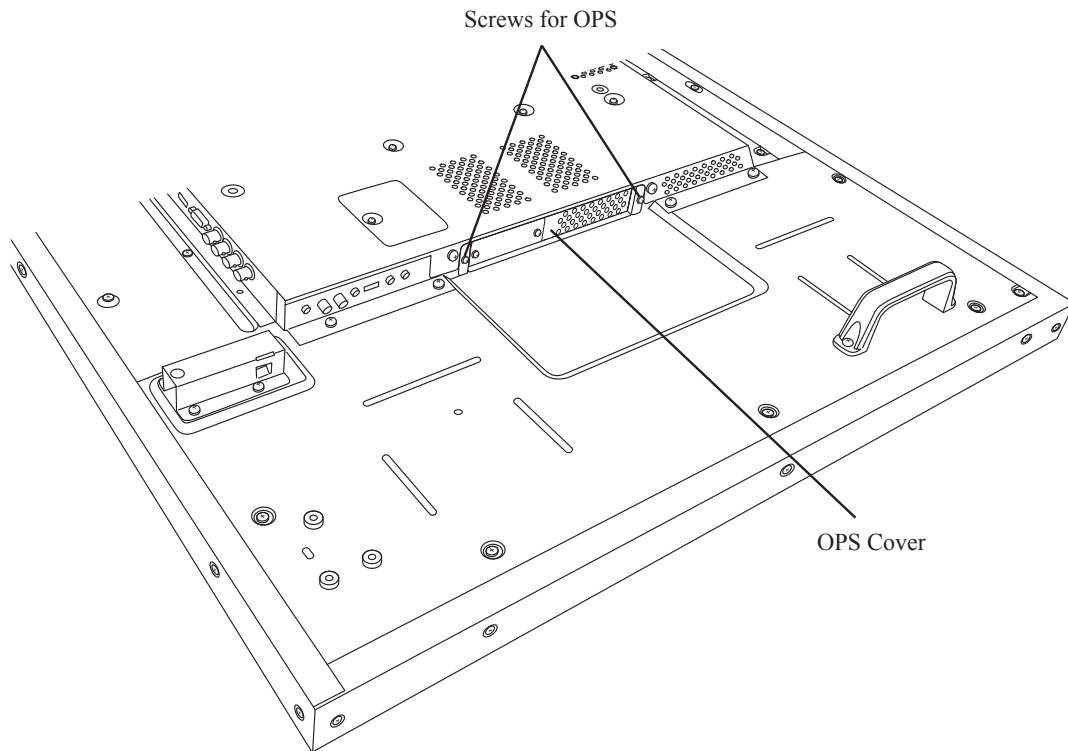

Note:

- ◆ The OPS slot is only available for RX-42E and RX-55E models.

PRODUCT DESCRIPTION

1.7 LCD Display Overview

1.7.1 Control Panel

RX-32E

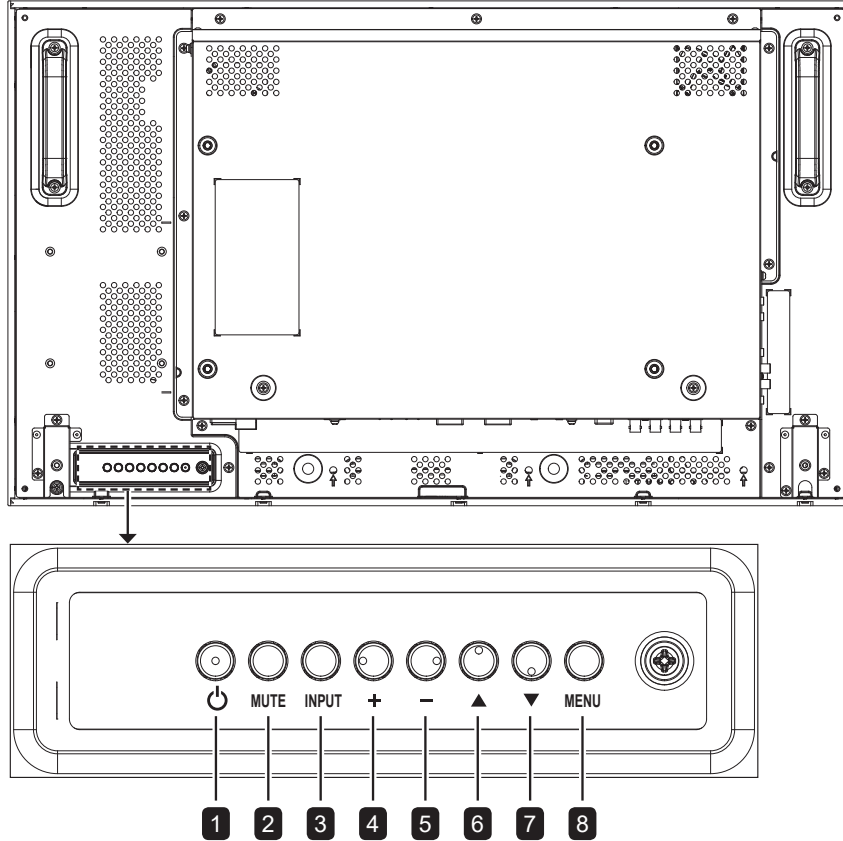

RX-42E

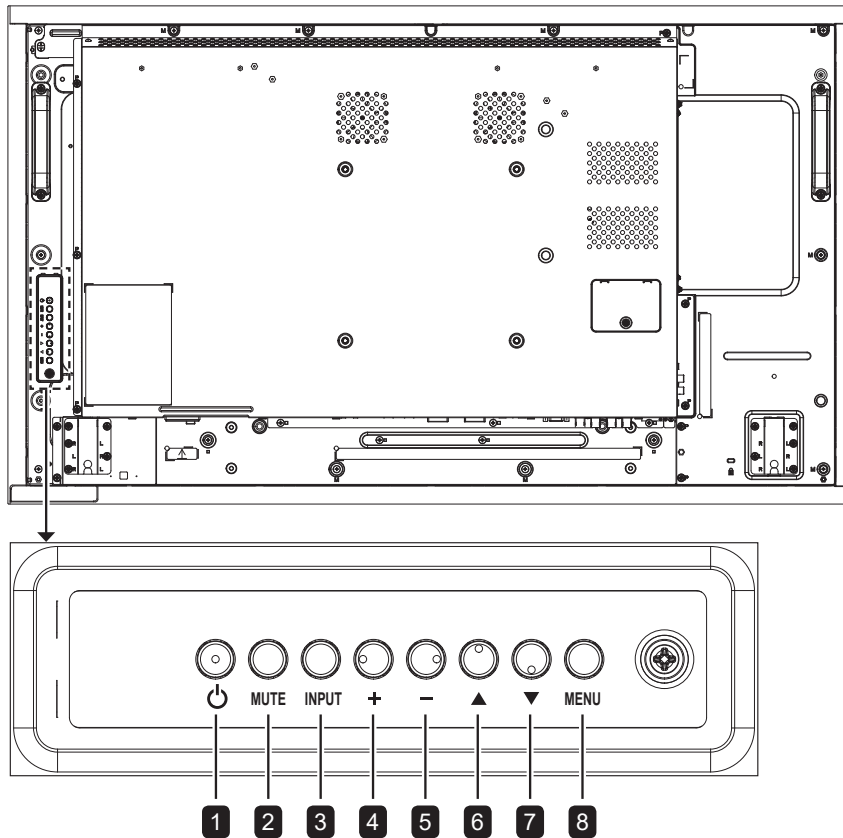

PRODUCT DESCRIPTION

RX-55E

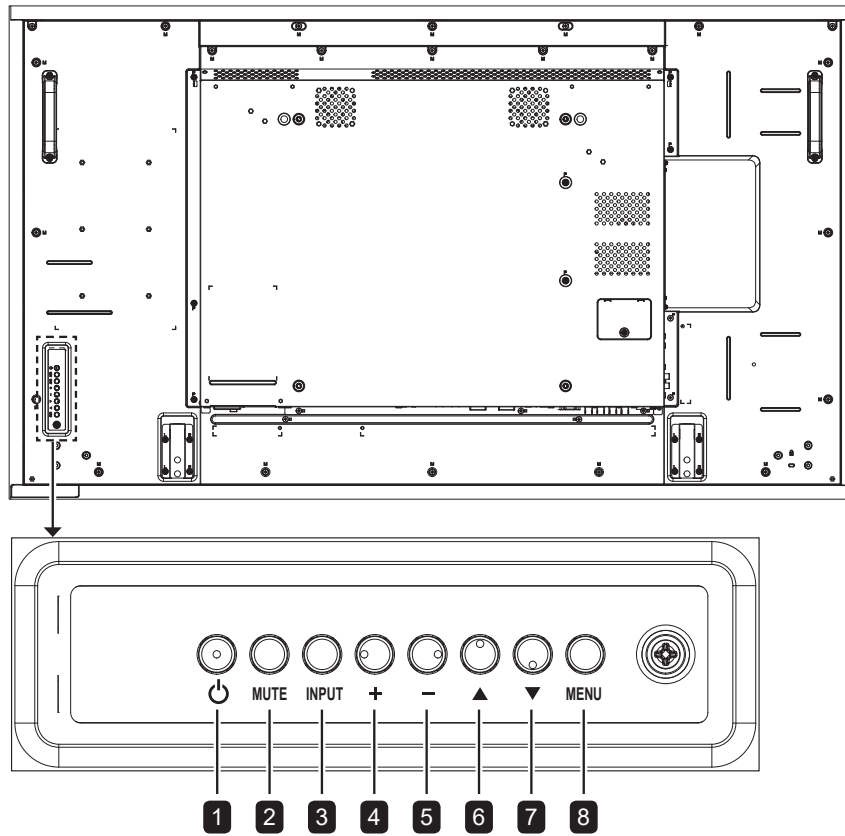

RX-32E/RX-42E/RX-55E

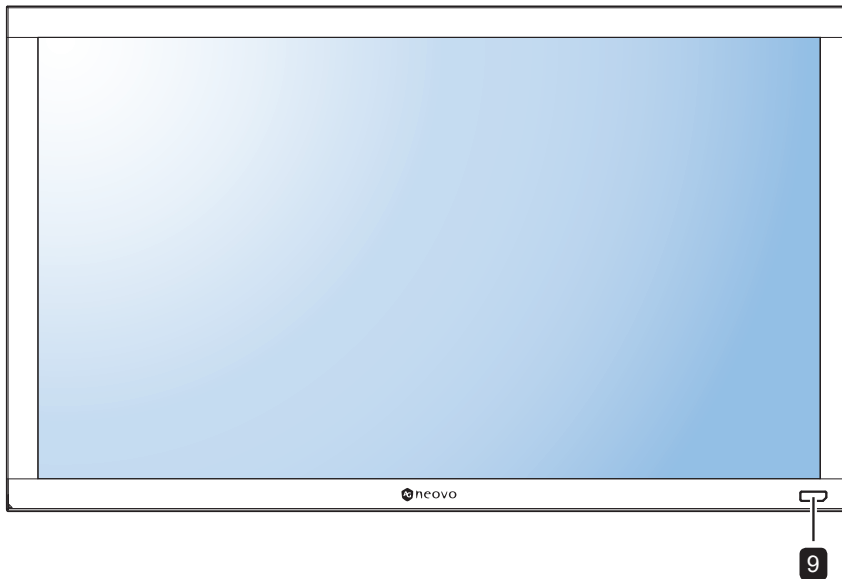

PRODUCT DESCRIPTION

1 [⏻] Power

Turn the display on or put the display to standby.

2 MUTE

Switch the audio mute ON/OFF.

3 INPUT

- Choose the input source.
- Used as the OK button while OSD menu is on.

4 [+] Increase

- Increase the adjustment while OSD menu is on.
- Increase the audio output level while OSD menu is off.

5 [-] Decrease

- Decrease the adjustment while OSD menu is on.
- Decrease the audio output level while OSD menu is off.

6 [▲] Up

Move the highlight bar up to adjust the selected item while OSD menu is on.

7 [▼] Down

Move the highlight bar down to adjust the selected item while OSD menu is on.

8 MENU

- Close the OSD menu while OSD menu is on.
- Activate the OSD menu when OSD menu is off.

9 Remote control sensor, power status indicator, and auto brightness (Light sensor)

- Receive command signals from the remote control.
- Indicate the operating status of the display:
 - Lights green when the display is turned on
 - Lights amber when the display is in standby mode
 - Lights off when the main power of the display is turned off
- Detect ambient lighting conditions and automatically adjusts the brightness levels. Refer to “Auto Brightness” on page 68 for more information.

PRODUCT DESCRIPTION

1.7.2 Input/Output Terminals

RX-32E

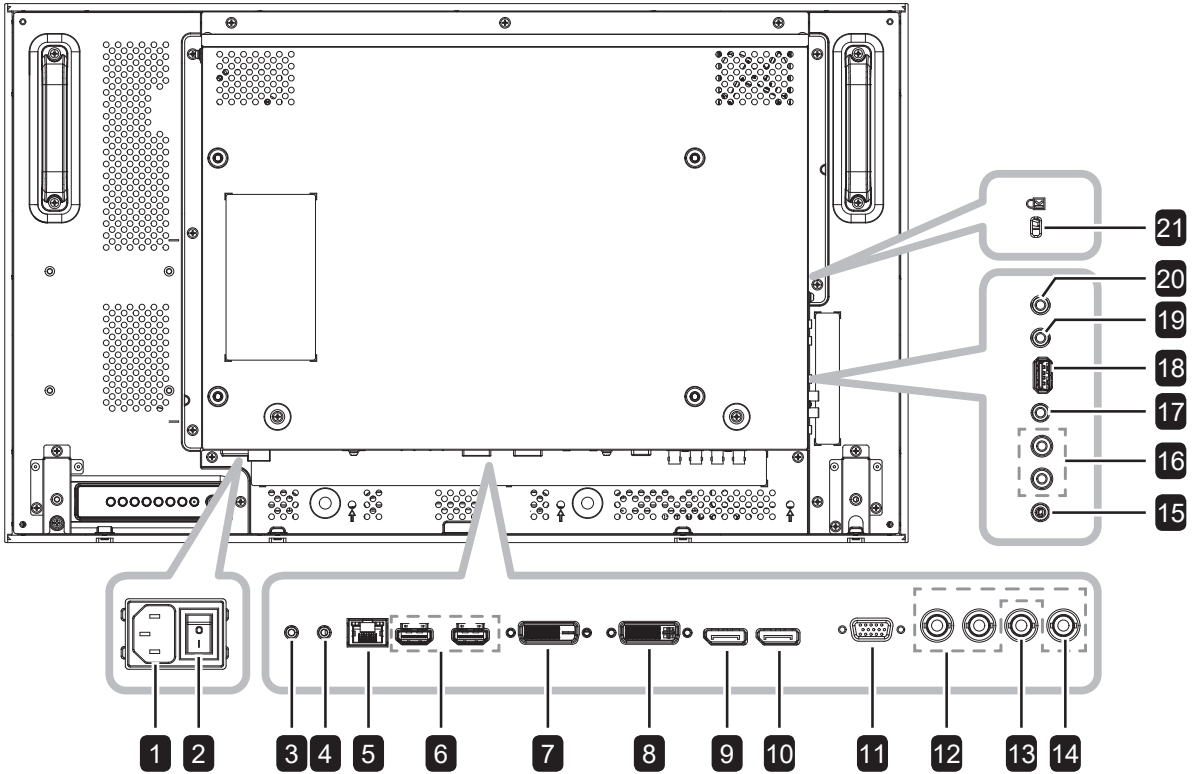

RX-42E

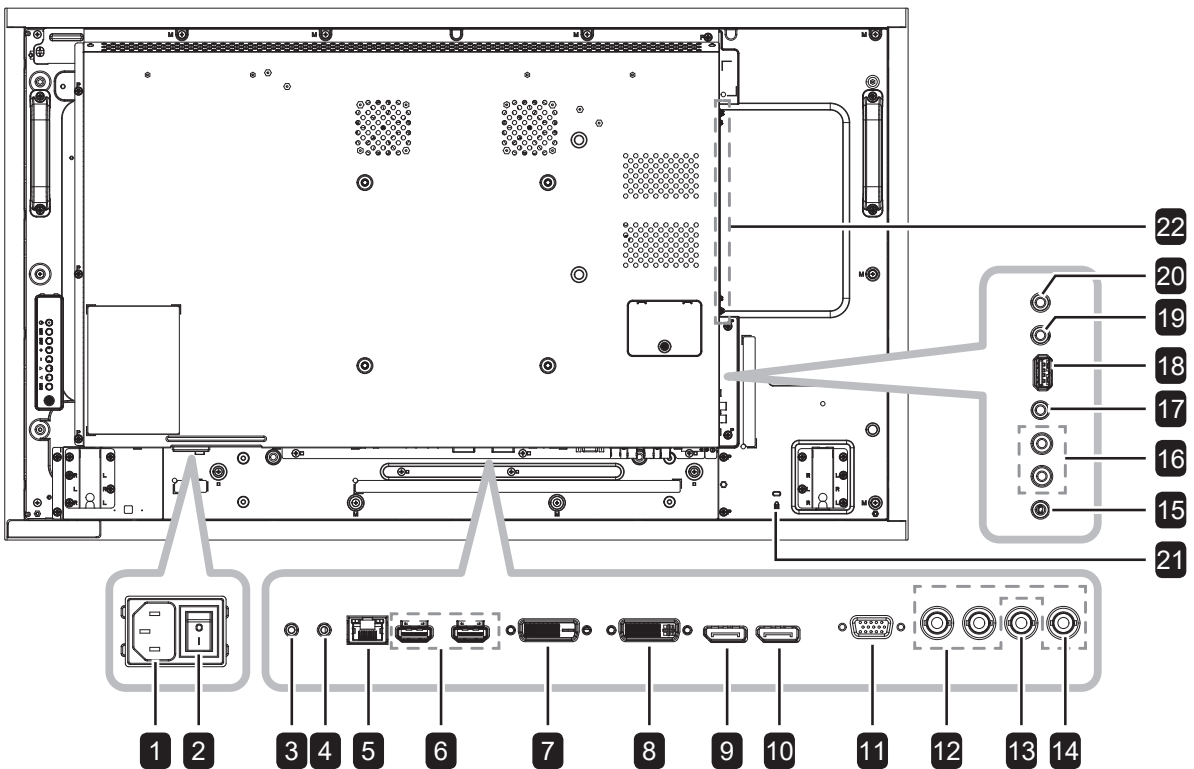

PRODUCT DESCRIPTION

RX-55E

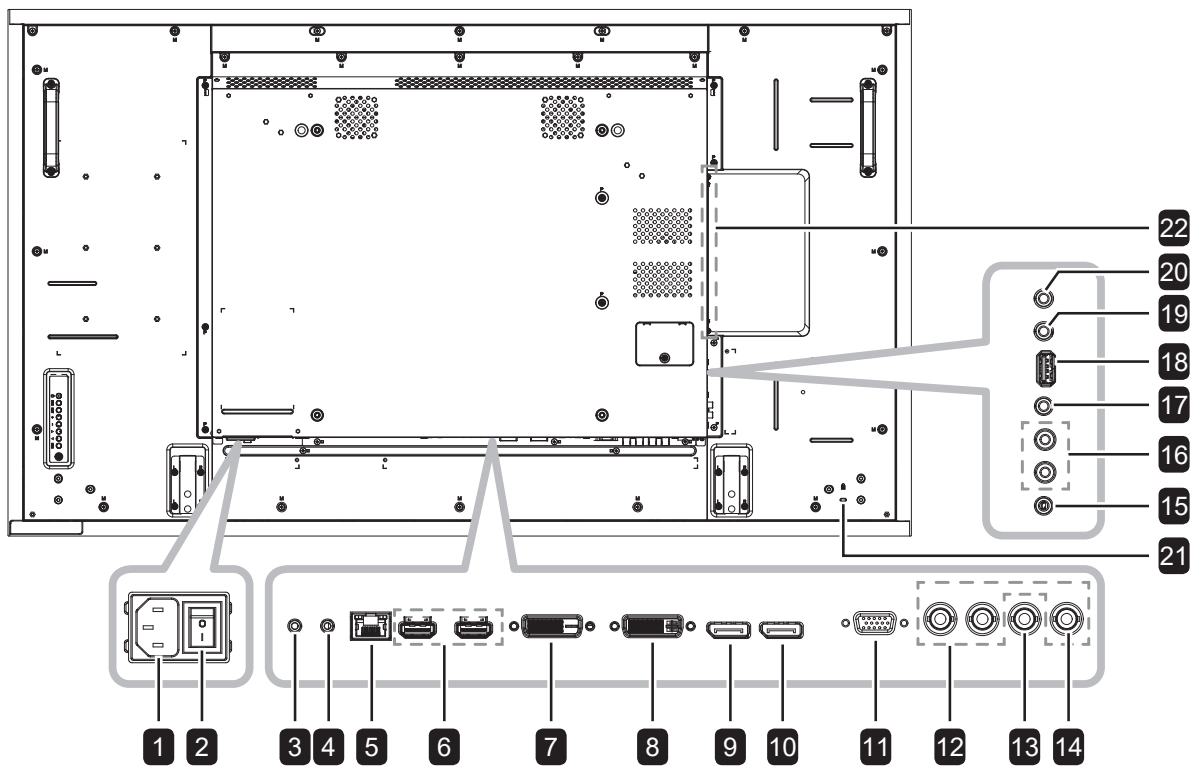

PRODUCT DESCRIPTION

1 AC IN

AC power input from the wall outlet.

2 Main power switch

Switch the main power on/off.

3 RS232 IN

RS232 network input for the loop-through function.

4 RS232 OUT

RS232 network output for the loop-through function.

5 LAN

LAN control function for the use of remote control signal from the control center.

6 HDMI1 IN/ HDMI2 IN

HDMI video/audio input.

7 DVI IN

DVI-D video input.

8 DVI OUT

DVI-I, VGA, or HDMI video output.

9 DisplayPort IN

DisplayPort video input.

10 DisplayPort OUT

DisplayPort video output.

11 VGA IN (D-Sub)

VGA video input.

12 COMPONENT VIDEO

Component YPbPr video source input.

13 CVBS OUT

CVBS video source output.

14 Y/CVBS IN

CVBS video source input.

15 PC Audio In

Audio input for PC source (3.5mm stereo phone).

16 AUDIO IN

Audio input from external AV device (RCA).

17 AUDIO OUT

Audio output to external AV device.

18 USB (FW/Multi Media Function)

For FW update/media playback.

19 IR OUT

IR signal output for the loop-through function.

20 IR IN

IR signal input for the loop-through function.

Note:

- ◆ This display's remote control sensor will stop working if the [IR IN] jack is connected.
- ◆ To remotely control your A/V device via this display, refer to page 42 for IR Pass-Through connection.

21 SECURITY LOCK

Used for security and theft prevention.

22 OPS SLOT

Slot for installing the optional OPS module.

PRODUCT DESCRIPTION

1.8 Remote Control

1.8.1 General Functions

1 [POWER] POWER

Turn the display on or to put the display into standby mode.

2 [PLAY] PLAY

Control playback in multimedia mode.

3 [SOURCE] SOURCE

Choose input source. Press the ▲ or ▼ button to choose from USB, Network, HDMI 1, HDMI 2, DisplayPort, OPS, DVI-D, YPbPr, AV, or VGA. Press the OK button to confirm and exit.

Note:

- ◆ The OPS option is only available for RX-42E and RX-55E models.

4 [HOME] HOME

Access the OSD menu.

5 [LIST] LIST

No function.

6 [NAVIGATION] NAVIGATION buttons

Navigate through menus and choose items.

7 [OK] OK

Confirm an entry or selection.

8 [ADJUST] ADJUST

Access currently available picture and sound menus.

9 [MUTE] MUTE

Turn the mute function on/off.

10 [COLOR] COLOR

Choose tasks or options.

11 [Number/ ID SET/ ENTER]

- Enter text for network setting.
- Set the display ID. Refer to 1.8.2 ID Remote Control for more detail.

12 [FORMAT] FORMAT

Change the aspect ratio.

13 [BACK] BACK

Return to the previous menu or exit from the previous function.

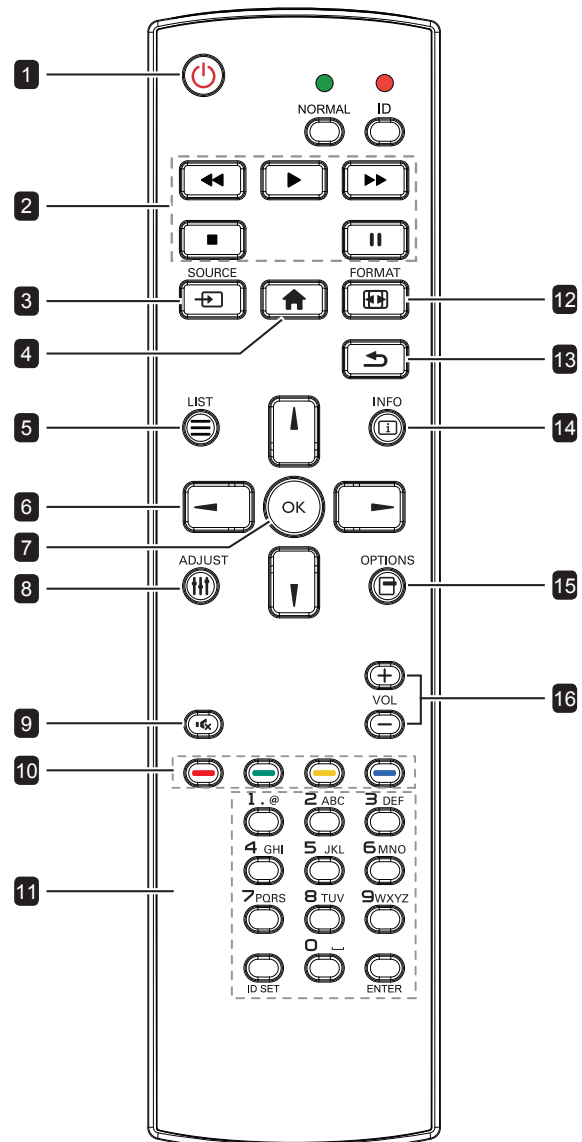

14 [INFO] INFO

View the information about the display.

15 [OPTIONS] OPTIONS

Access currently available options, picture, and sound menus.

Note:

- ◆ In multimedia mode, user can adjust the picture, sound, ECO, and clock settings.

16 [VOLUME] VOLUME

Adjust the volume level.

PRODUCT DESCRIPTION

1.8.2 ID Remote Control

You can set the remote control ID when you want to use this remote control on one of several different displays.

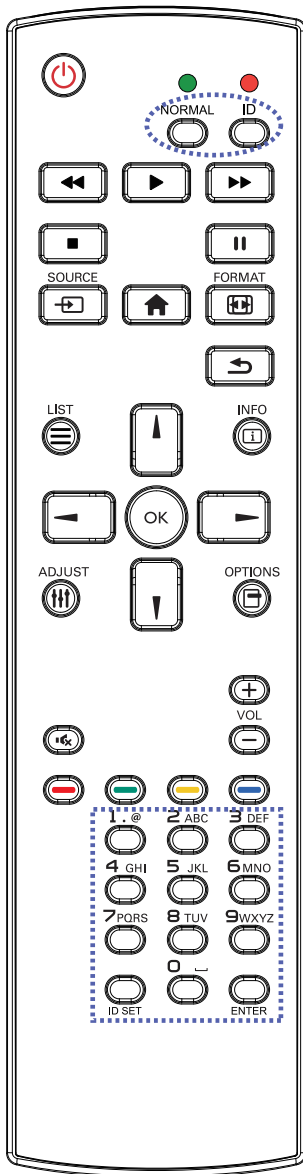

To set the remote control ID:

- 1 Press the **ID** button. The red LED blinks twice.
- 2 Press the **ID SET** button for 3 seconds to enter the ID mode. The red LED lights up.
Press the **ID SET** button again will exit the ID mode. The red LED lights off.
- 3 Press the digit numbers [0] ~ [9] to select the display you want to control.
For example:
 - Display ID #1: press [0], [0], [1]
 - Display ID #11: press [0], [1], [1]The numbers available are from [001] ~ [255].
 - Not pressing any button within 10 seconds will exit the ID mode.
 - If an error pressing of buttons other than the digits occurred, wait 1 second after the red LED lights off and then lights up again, then press the correct digits again.
- 4 Press the **ENTER** button to confirm. The red LED blinks twice and then lights off.

Note:

- ◆ Press the **NORMAL** button. The green LED blinks twice, indicating the remote control returns to normal operation.
- ◆ It is necessary to set up the ID number for each display before selecting its ID number.

PRODUCT DESCRIPTION

1.8.3 Inserting the Batteries in the Remote Control

The remote control is powered by two 1.5V AAA batteries.

To install or replace batteries:

- 1 Press and then slide the cover to open it.
- 2 Align the batteries according to the (+) and (-) indications inside the battery compartment.
- 3 Replace the cover.

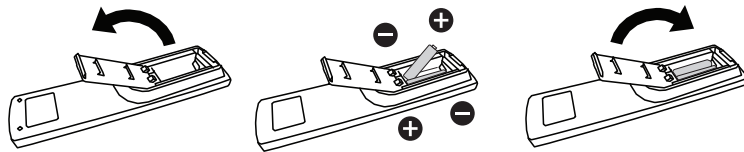

1.8.4 Handling the Remote Control

- Do not subject to strong shock.
- Do not allow water or other liquid to splash the remote control. If the remote control gets wet, wipe it dry immediately.
- Avoid exposure to heat and steam.
- Other than to install the batteries, do not open the remote control.

1.8.5 Operating Range of the Remote Control

Point the top of the remote control toward the display's remote control sensor (front side) when pressing a button.

Use the remote control within the range which is shown in the following table.

Operation Angle	RC operational distance
$\theta = 0^\circ$ (for H & V)	$\geq 8\text{m}$
$\theta = 20^\circ$ (for H & V)	$\geq 5\text{m}$
$\theta = 45^\circ$ (for H only)	$\geq 2\text{m}$

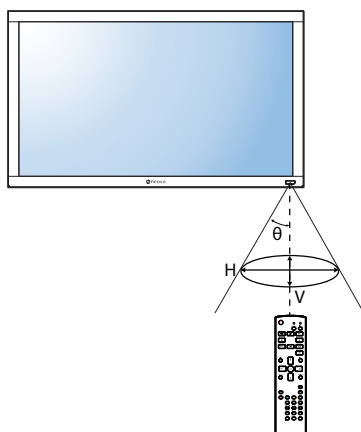

Caution:

The incorrect use of batteries can result in leaks or bursting. Be sure to follow these instructions:

- ◆ Place “AAA” batteries matching the (+) and (-) signs on each battery to the (+) and (-) signs of the battery compartment.
- ◆ Do not mix battery types.
- ◆ Do not combine new batteries with used ones. It causes shorter life or leakage of batteries.
- ◆ Remove the dead batteries immediately to prevent them from liquid leaking in the battery compartment. Don't touch exposed battery acid, as it can damage your skin.

Note:

- ◆ If you do not intend to use the remote control for a long period, remove the batteries.
- ◆ The remote control may not function properly when the remote control sensor on this display is under direct sunlight or strong illumination, or when there is an obstacle in the path of signal transmission.

CHAPTER 2: MAKING CONNECTIONS

2.1 Connecting the Power

- 1 Connect one end of the power cord to the AC IN connector at the rear of the LCD display.
- 2 Connect the other end of the power cord to a power outlet or a power supply.
- 3 Set the **Main Power** switch to ON.

RX-32E

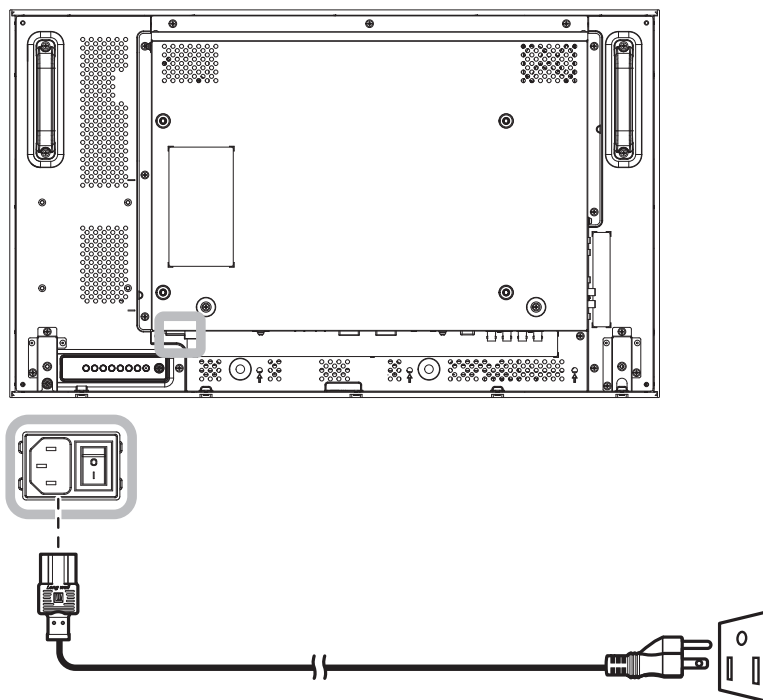

RX-42E

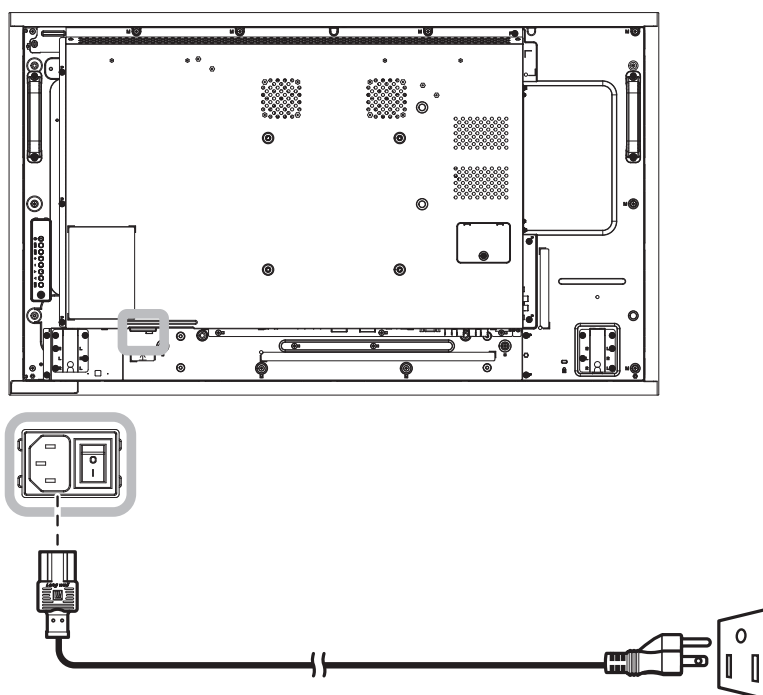

MAKING CONNECTIONS

RX-55E

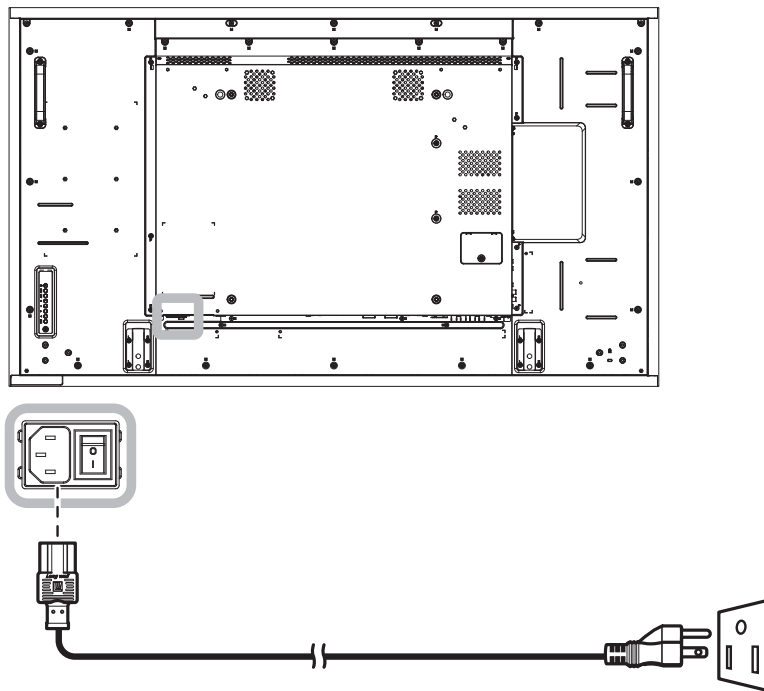

 **Caution:**

- ◆ Make sure that the LCD display is not connected to the power outlet before making any connections. Connecting cables while the power is ON may cause electric shock or personal injury.
- ◆ When unplugging the power cord, hold the power cord by the plug head. Never pull by the cord.

MAKING CONNECTIONS

2.2 Connecting a Computer

2.2.1 Using VGA Input

Connect one end of a VGA cable to the VGA IN connector of the LCD display and the other end of a VGA cable to the VGA OUT (D-Sub) connector of the computer.

For audio input, connect one end of an audio cable to the AUDIO IN connector of the LCD display and the other end of an audio cable to the AUDIO OUT connector of the computer.

RX-32E

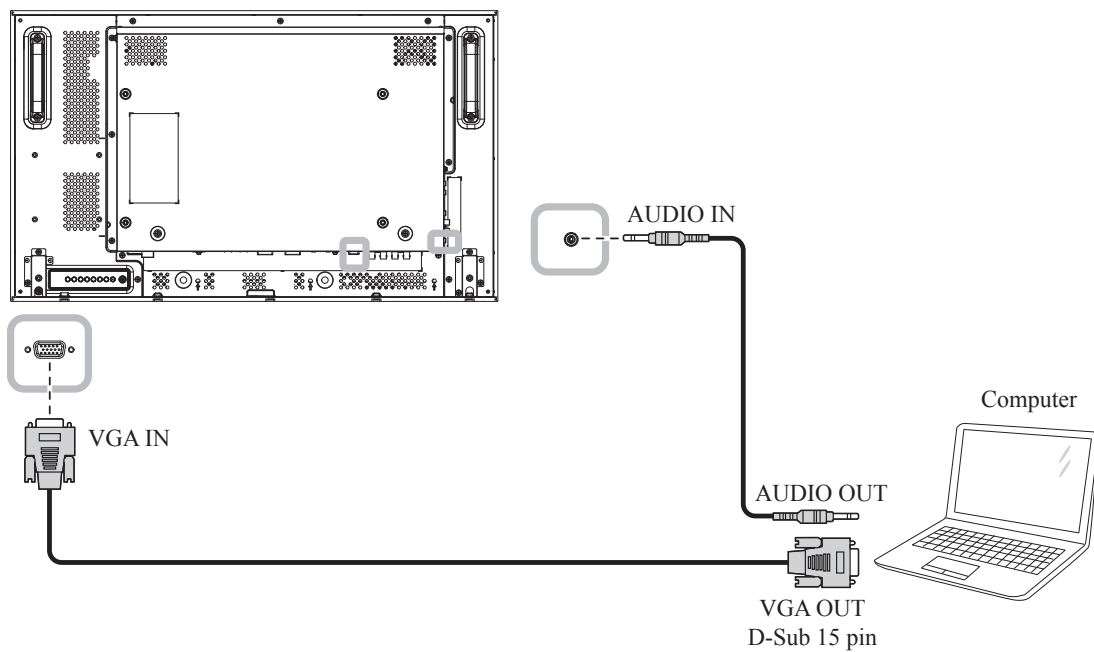

RX-42E

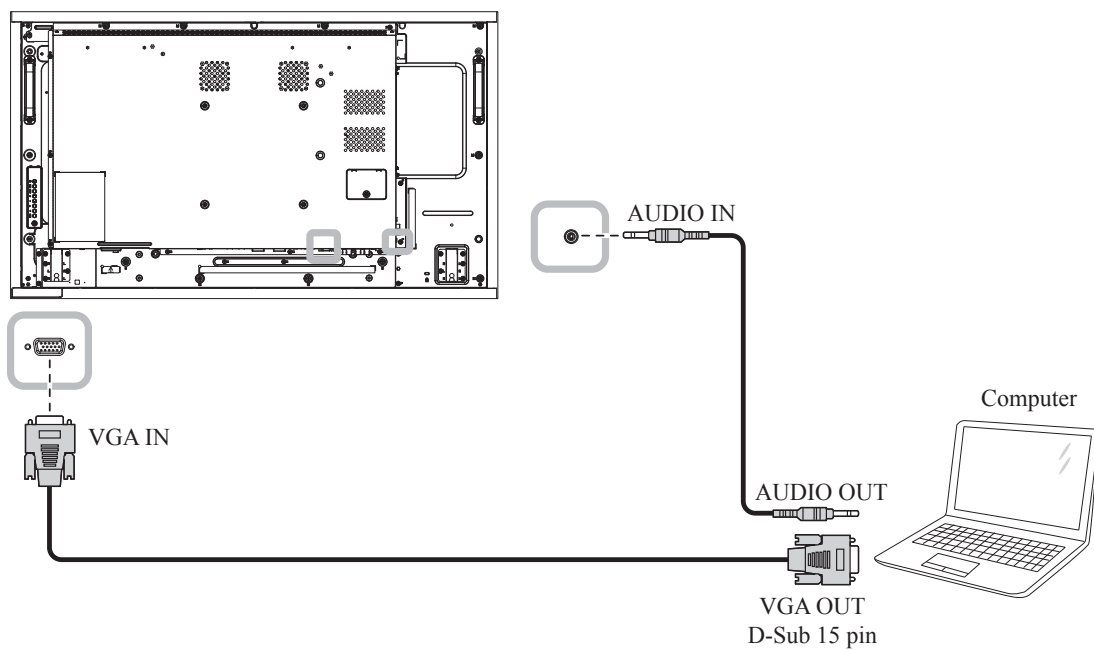

MAKING CONNECTIONS

RX-55E

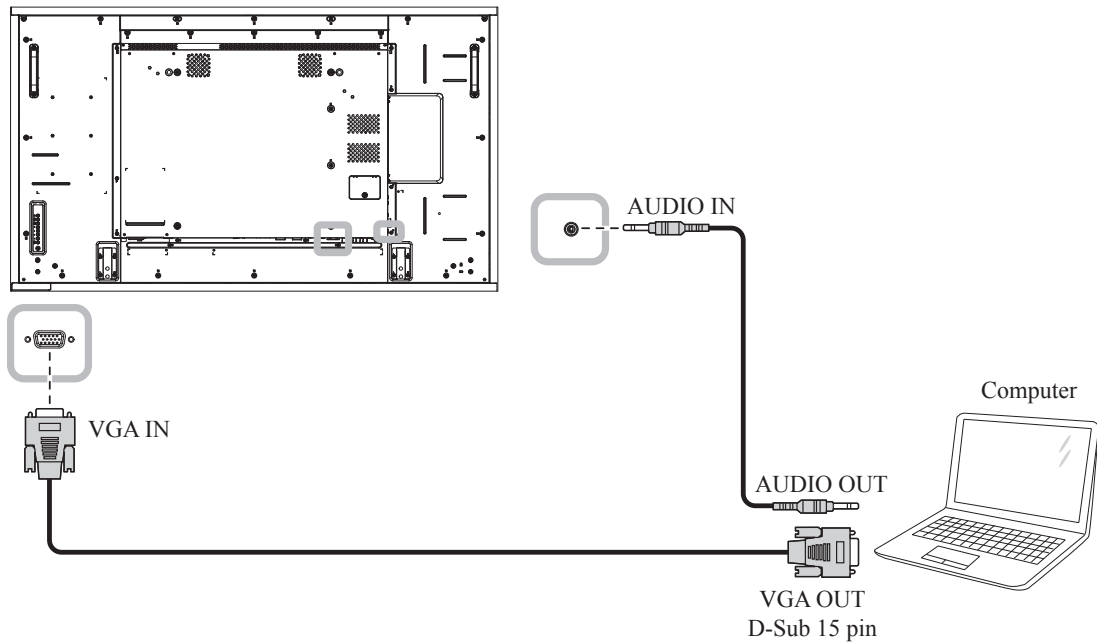

2.2.2 Using DVI Input

Connect one end of a DVI cable to the DVI IN connector of the LCD display and the other end of a DVI cable to the DVI OUT connector of the computer.

For audio input, connect one end of an audio cable to the AUDIO IN connector of the LCD display and the other end of an audio cable to the AUDIO OUT connector of the computer.

RX-32E

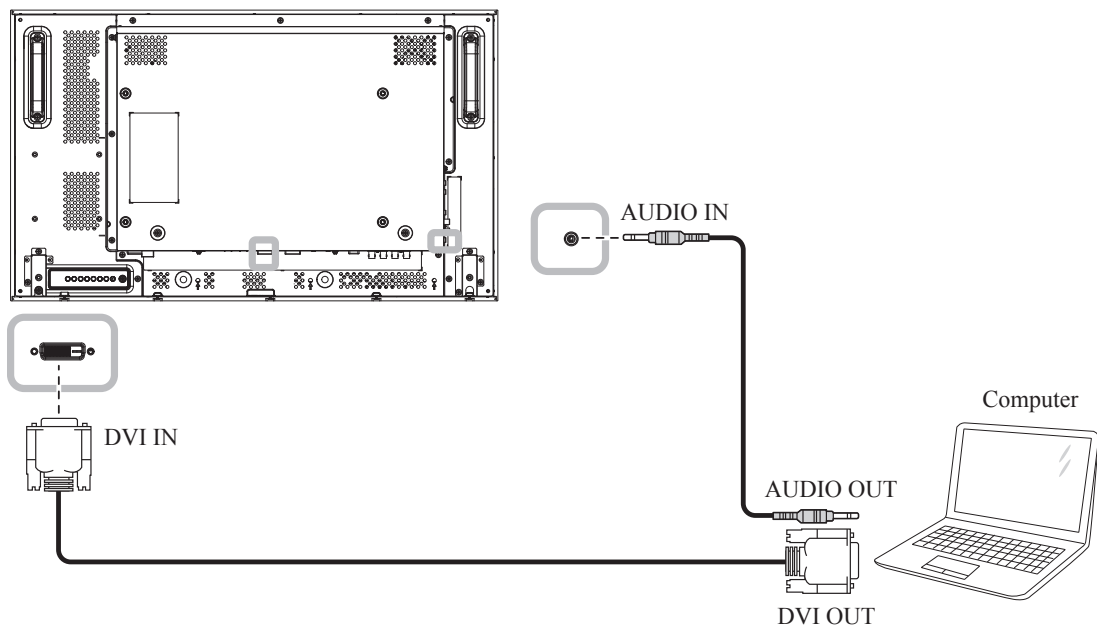

MAKING CONNECTIONS

RX-42E

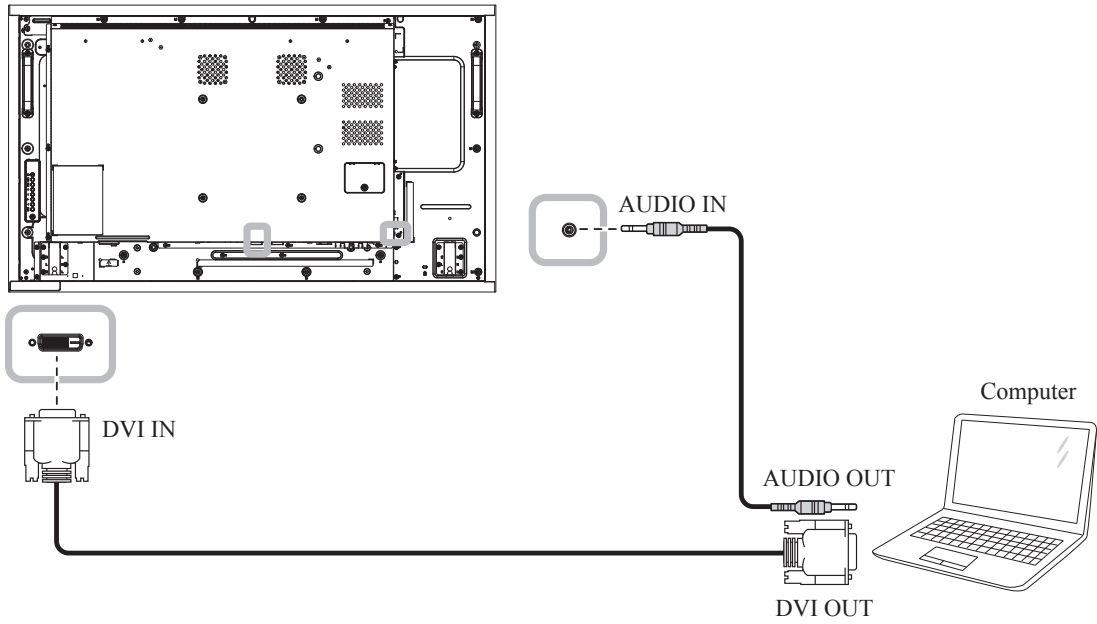

RX-55E

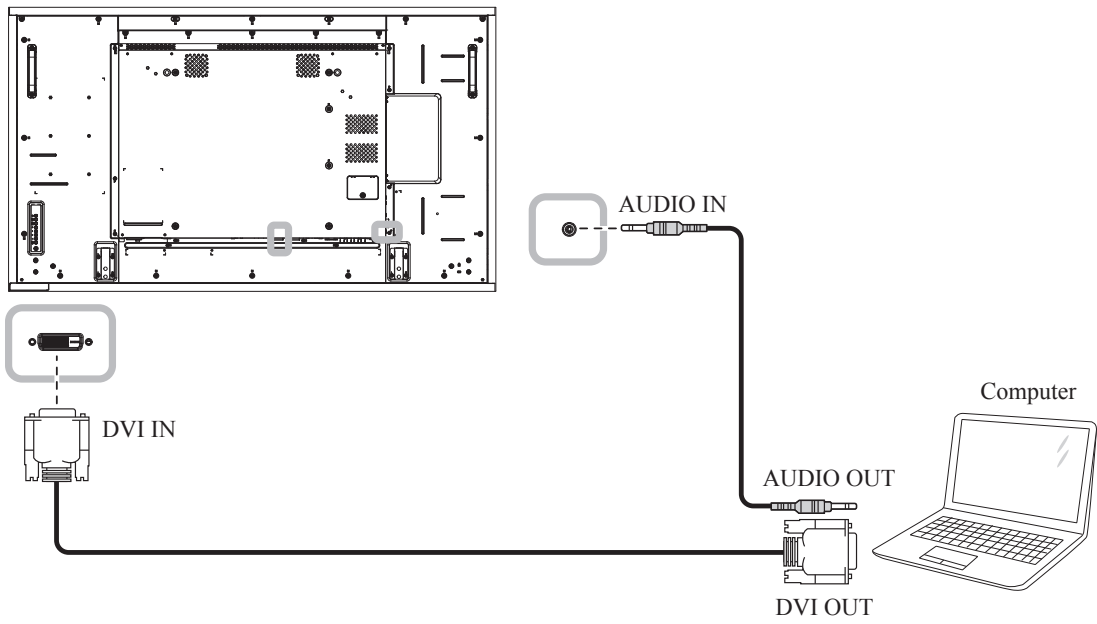

MAKING CONNECTIONS

2.2.3 Using HDMI Input

Connect one end of an HDMI cable to the HDMI1 IN/ HDMI2 IN connector of the LCD display and the other end of an HDMI cable to the HDMI OUT connector of the computer.

RX-32E

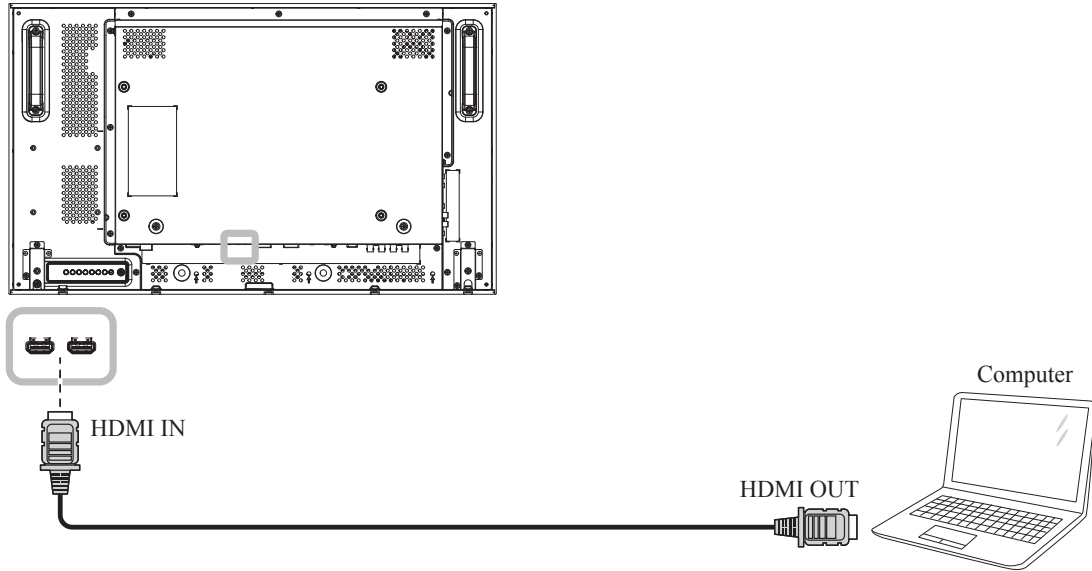

RX-42E

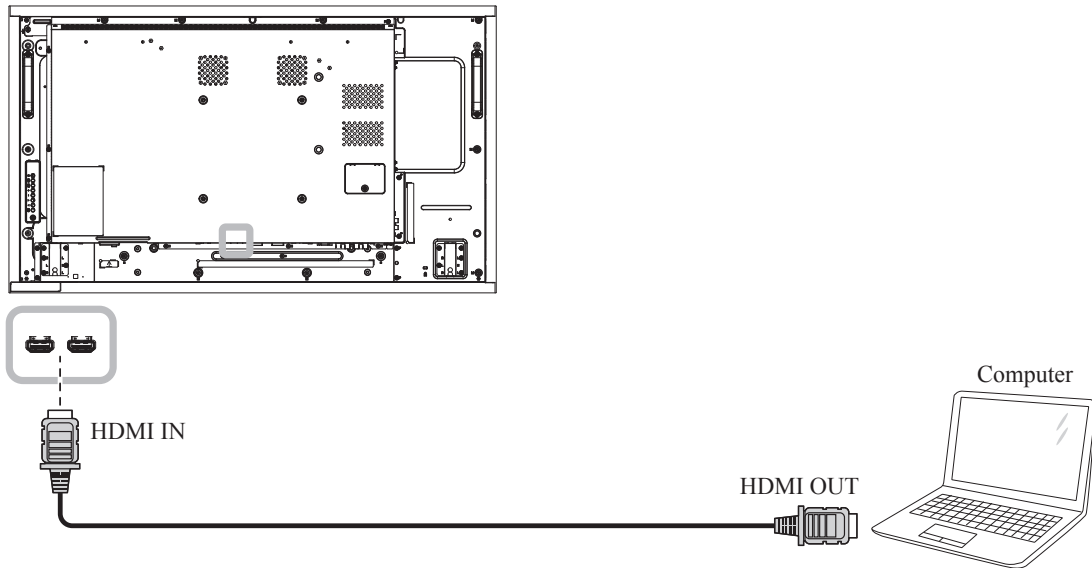

MAKING CONNECTIONS

RX-55E

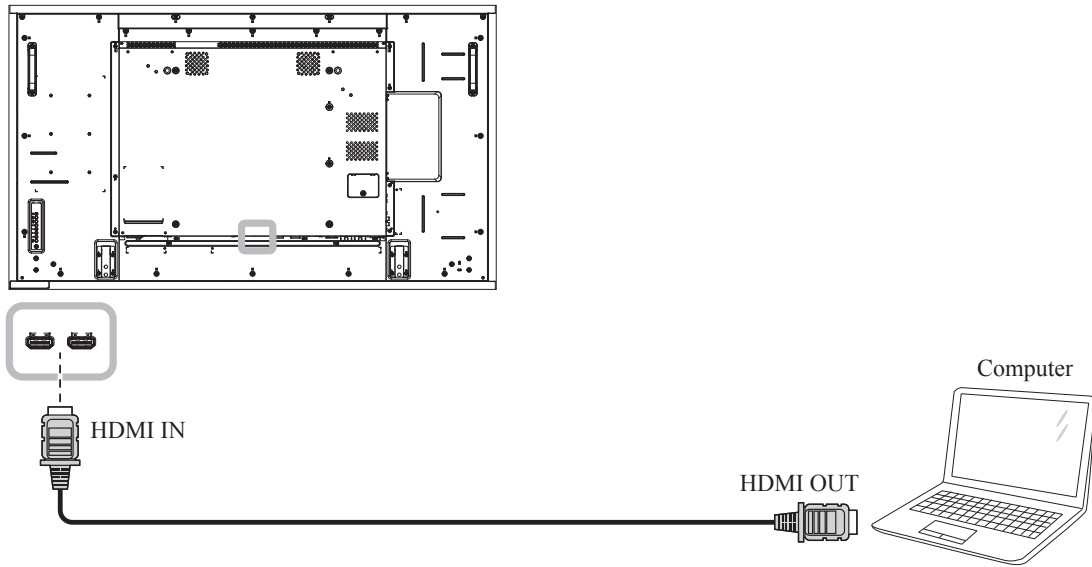

2.2.4 Using DisplayPort Input

Connect one end of a DisplayPort cable to the DisplayPort IN connector of the LCD display and the other end of a DisplayPort cable to the DisplayPort OUT connector of the computer.

RX-32E

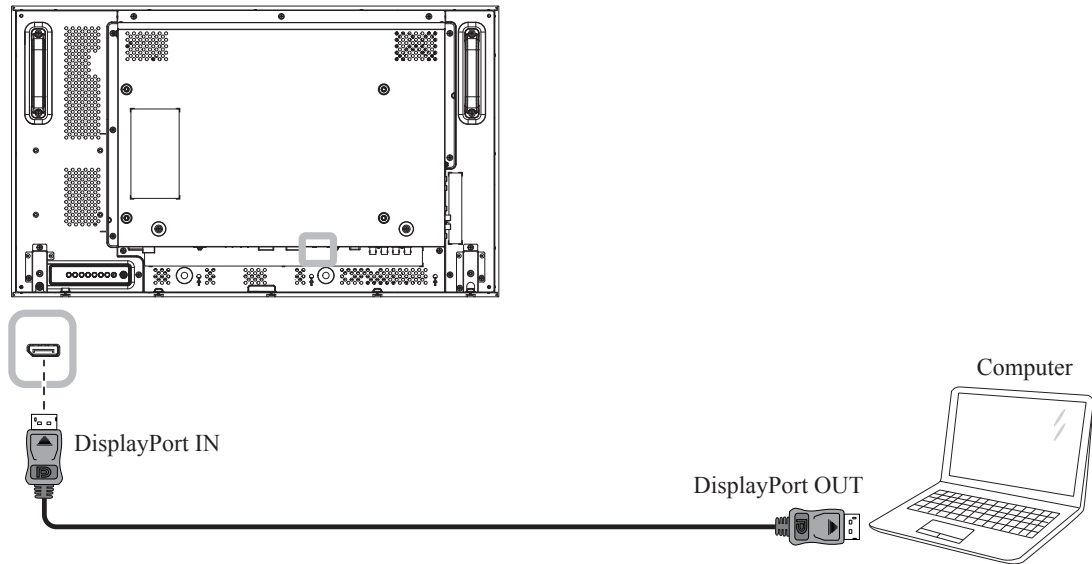

MAKING CONNECTIONS

RX-42E

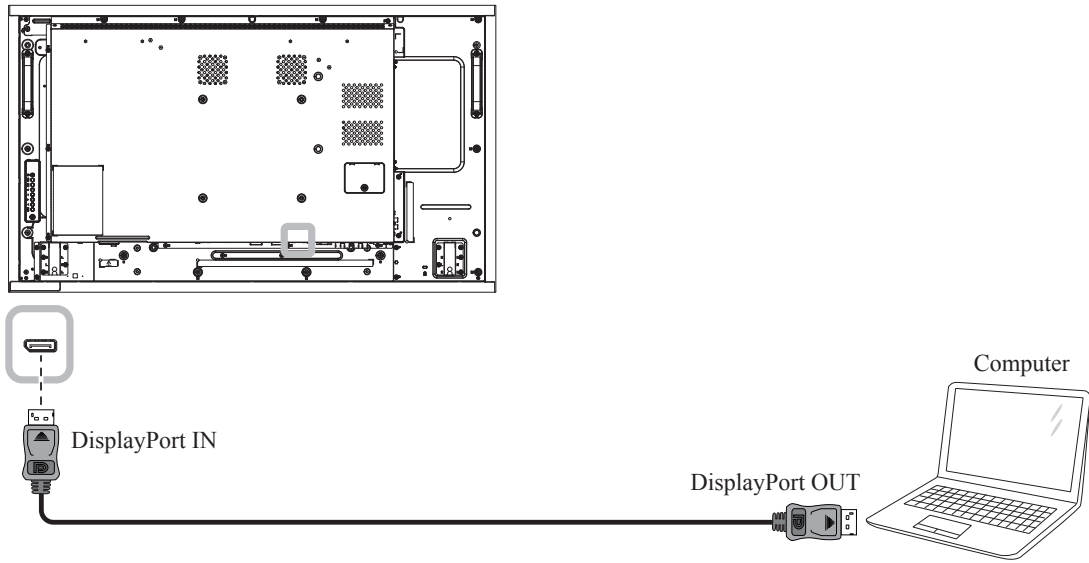

RX-55E

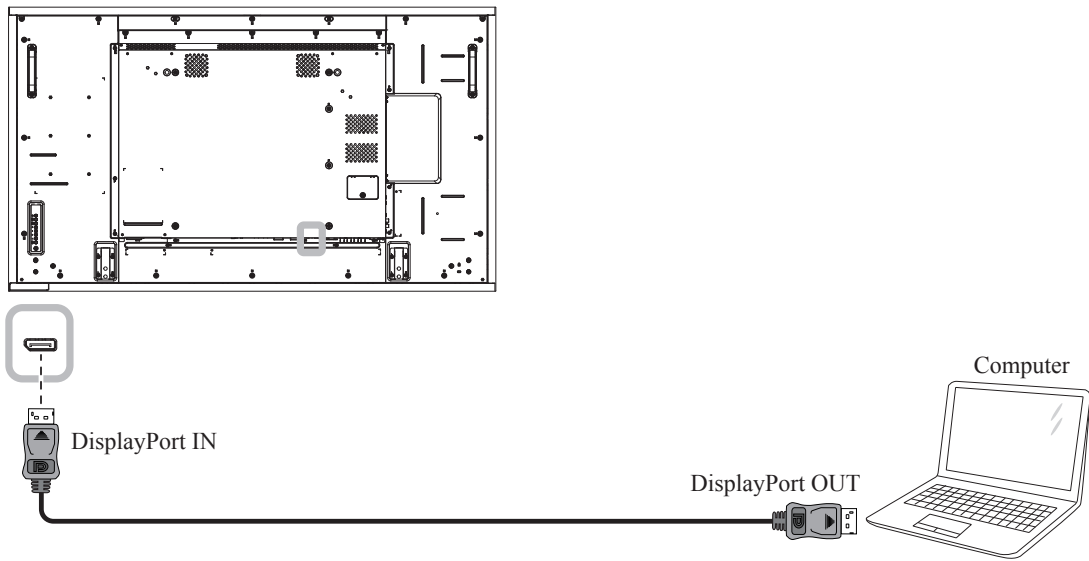

MAKING CONNECTIONS

2.3 Connecting External Equipment (Video Player)

2.3.1 Using COMPONENT Video Input

Connect one end of a component cable to the COMPONENT IN connector of the LCD display and the other end of a component cable to the COMPONENT OUT connector of the video player.

For audio input, connect one end of an audio cable to the AUDIO IN connector of the LCD display and the other end of an audio cable to the AUDIO OUT connector of the video player.

RX-32E

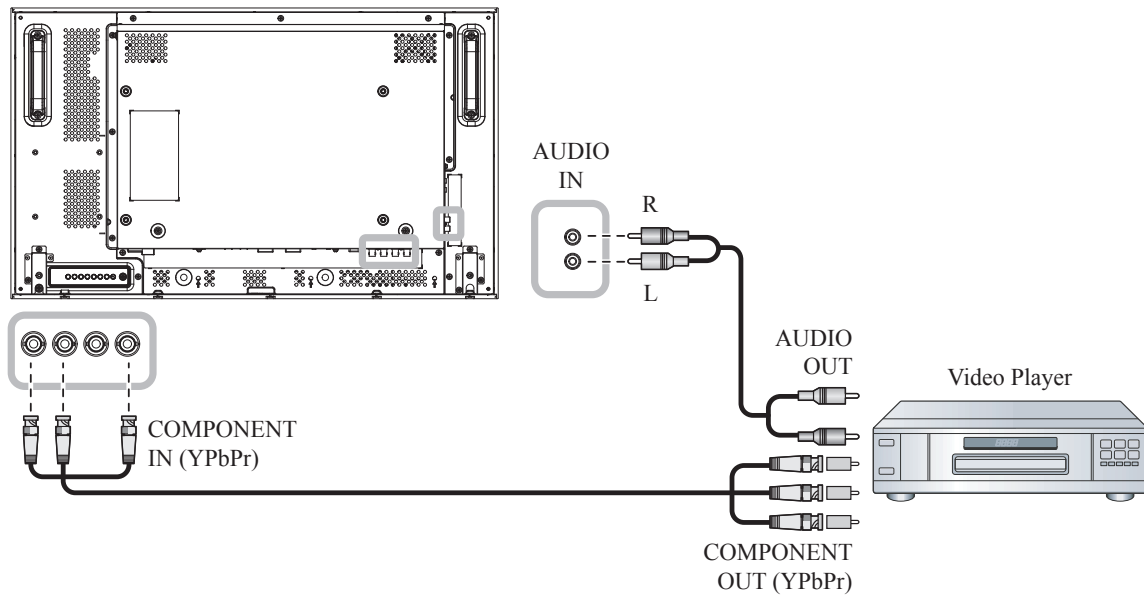

RX-42E

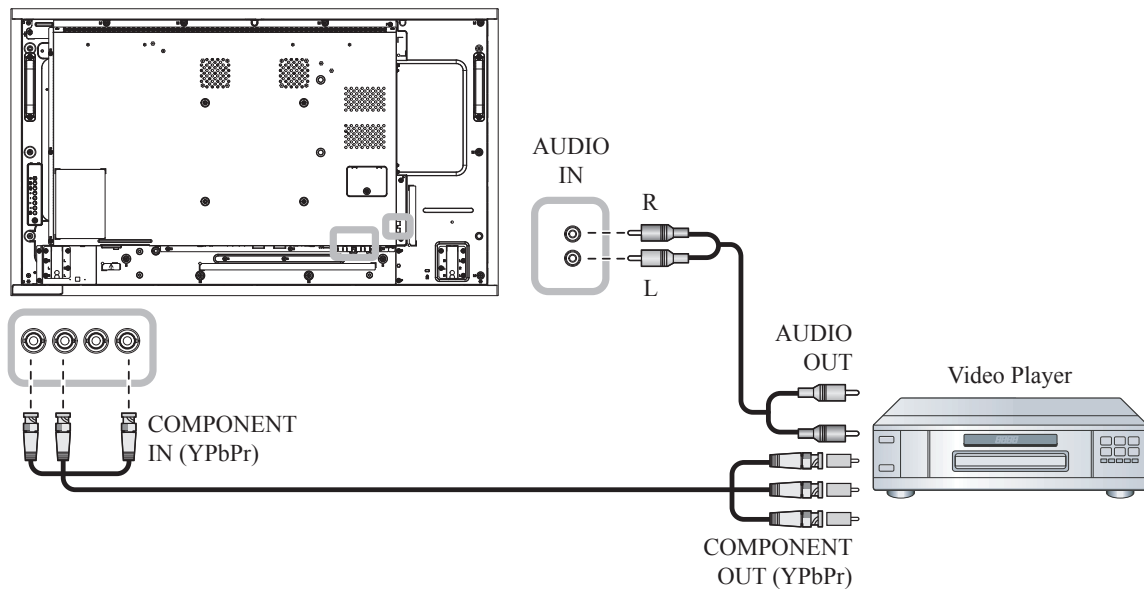

MAKING CONNECTIONS

RX-55E

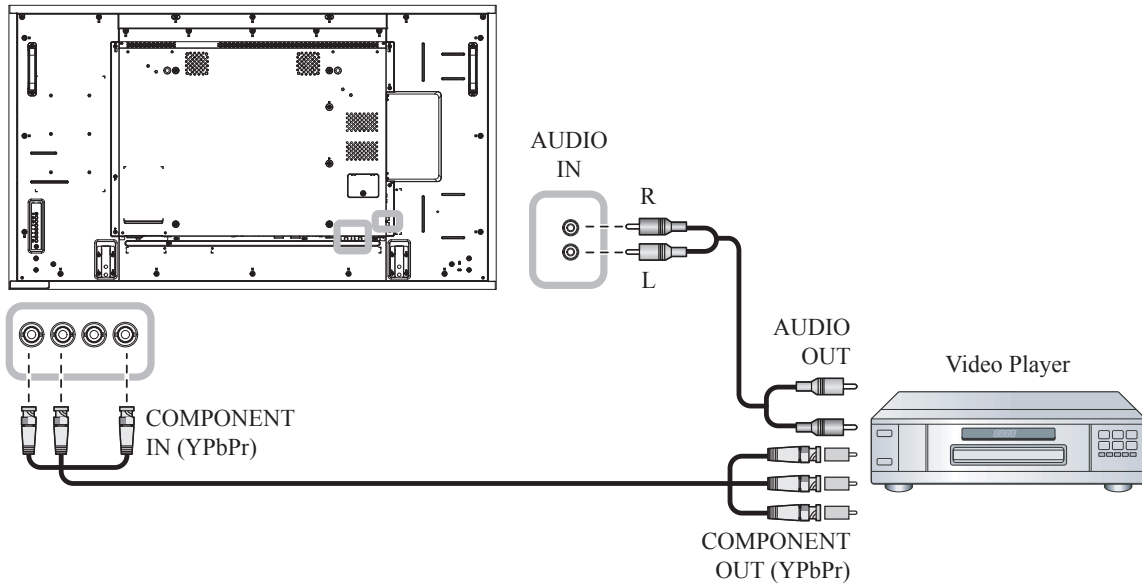

2.3.2 Using Video Source Input

Connect one end of a video cable to the Y/CVBS IN port of the LCD display and the other end of a video cable to the COMPONENT VIDEO/CVBS OUT port of the video player.

For audio input, connect one end of an audio cable to the AUDIO IN connector of the LCD display and the other end of an audio cable to the AUDIO OUT connector of the video player.

RX-32E

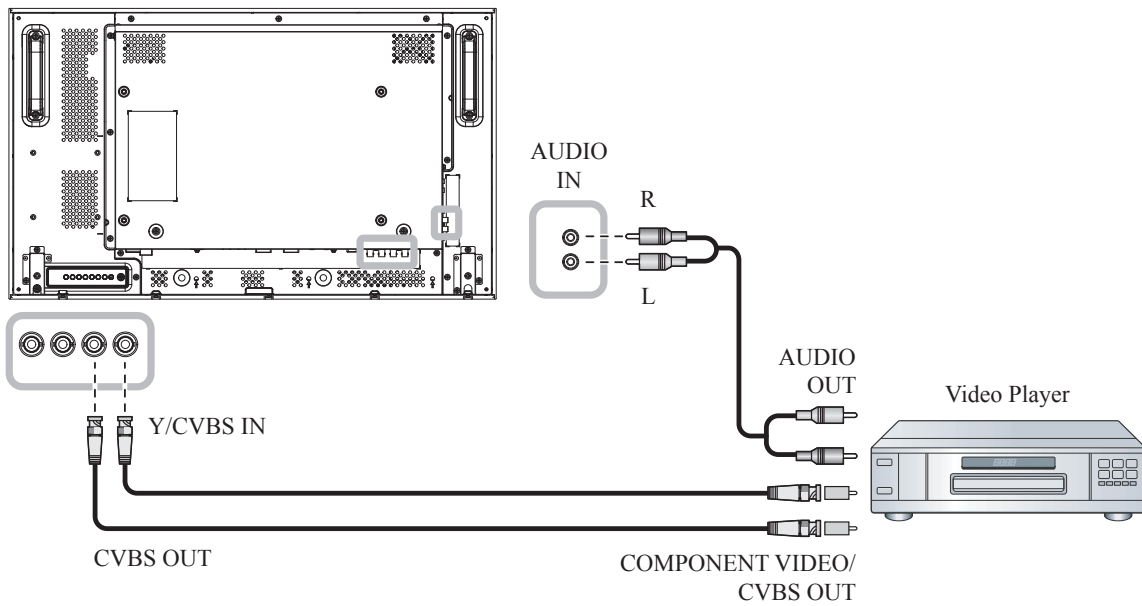

MAKING CONNECTIONS

RX-42E

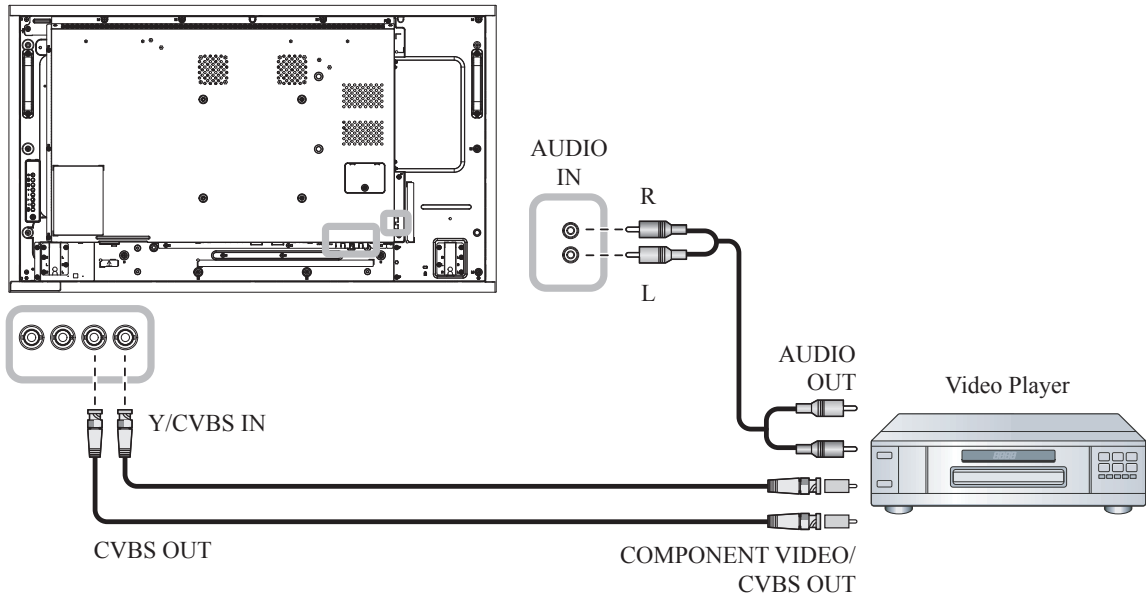

RX-55E

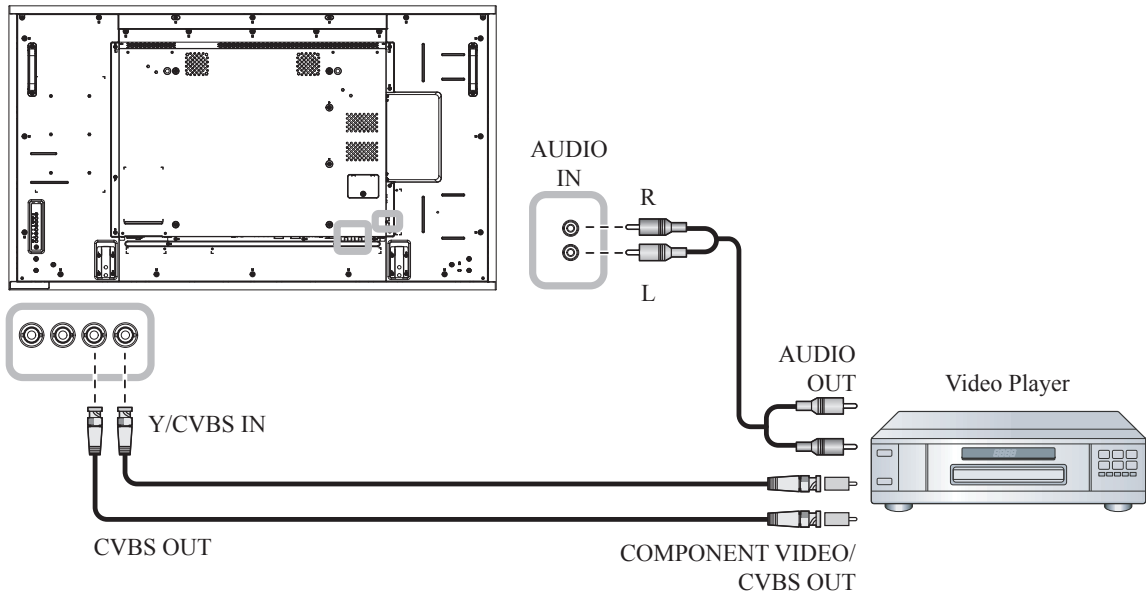

MAKING CONNECTIONS

2.3.3 Using HDMI Video Input

Connect one end of an HDMI cable to the HDMI1 IN/ HDMI2 IN connector of the LCD display and the other end of an HDMI cable to the HDMI OUT connector of the video player.

RX-32E

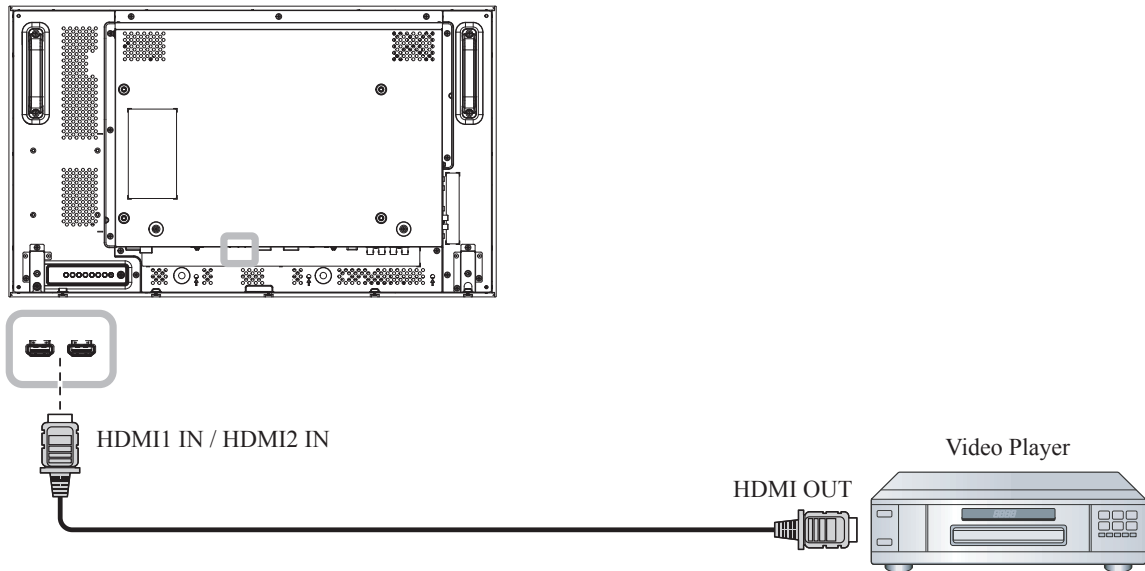

RX-42E

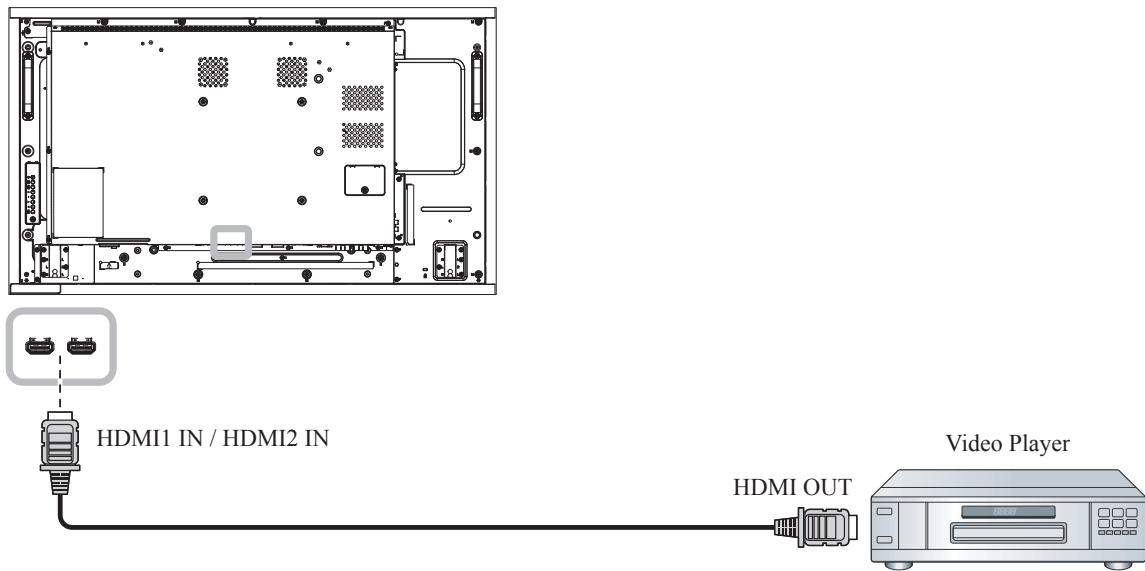

MAKING CONNECTIONS

RX-55E

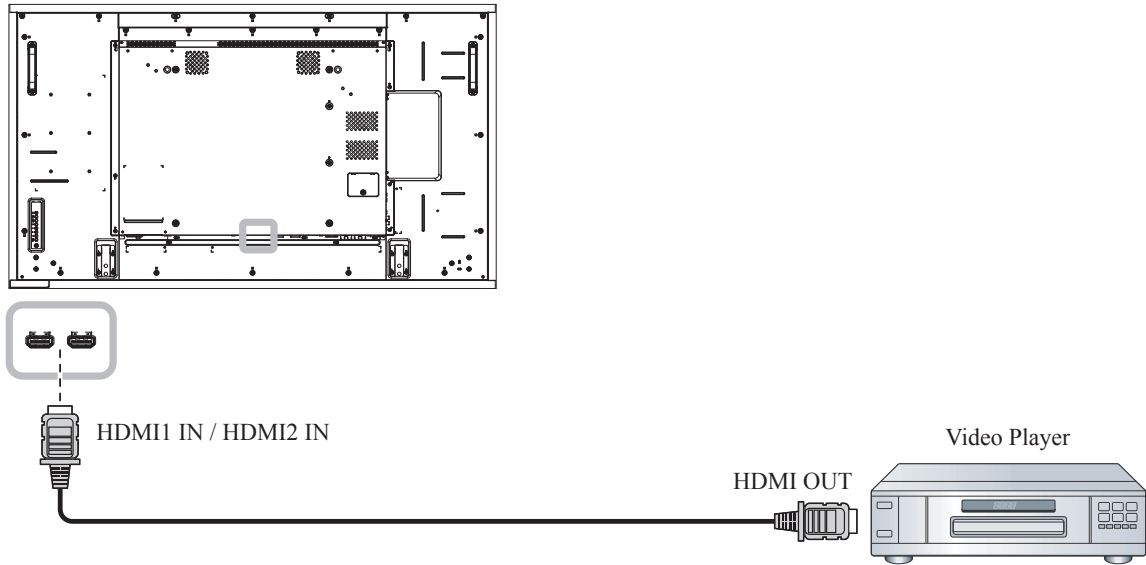

2.4 Connecting Audio Equipment

2.4.1 Connecting an External Audio Device

Connect one end of an audio cable to the AUDIO OUT connector of the LCD display and the other end of an audio cable to the AUDIO IN connector of the audio device.

RX-32E

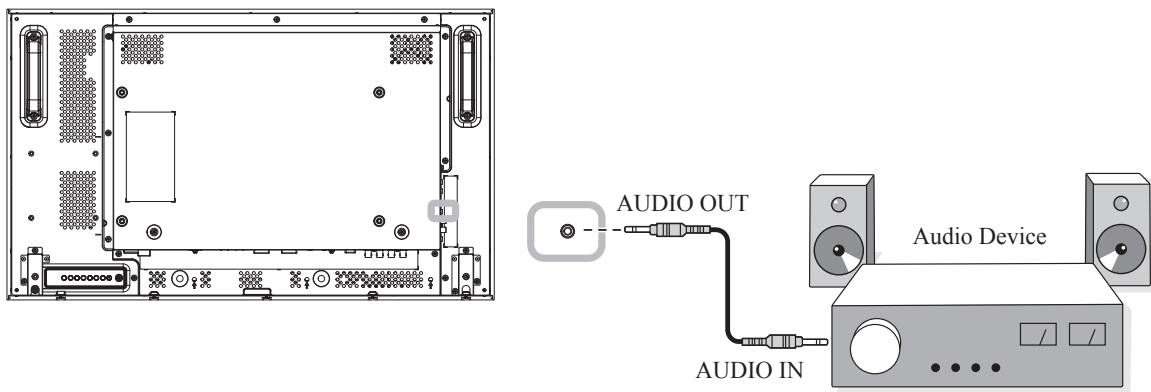

MAKING CONNECTIONS

RX-42E

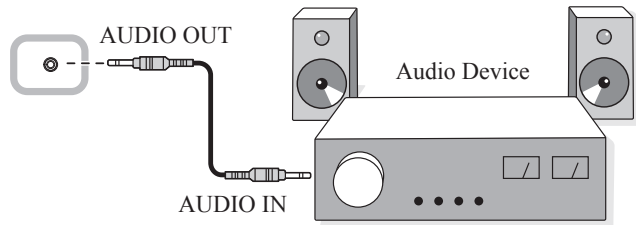
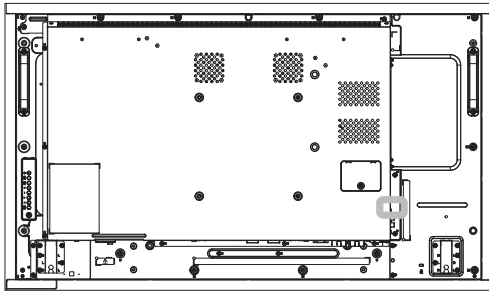

RX-55E

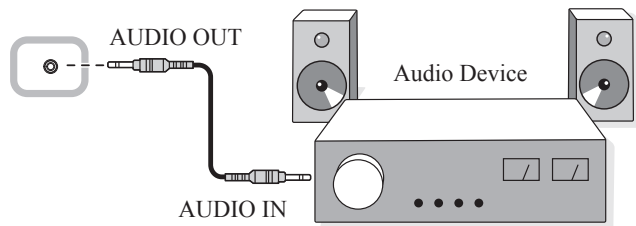
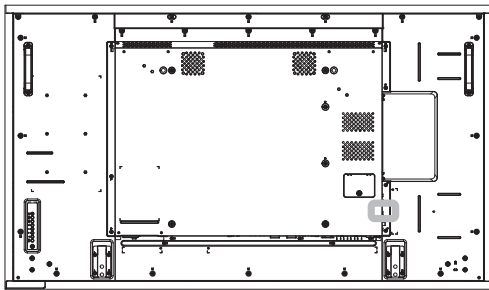

MAKING CONNECTIONS

2.5 Connecting Multiple Displays in a Daisy-chain Configuration

You can interconnect multiple displays to create a daisy-chain configuration for applications such as a video wall.

Caution:

To avoid unnecessary strain on the bezel, it is highly recommended to keep a minimum space of 0.5mm in which a business card is able to slip between all displays on all sides.

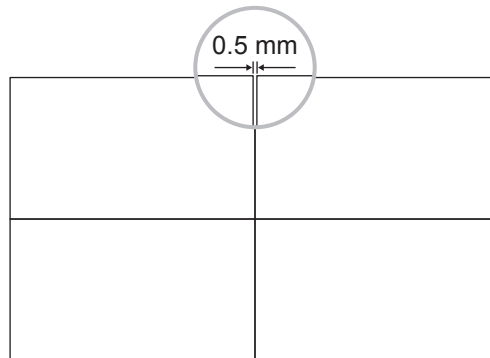

2.5.1 Display Control Connection

Connect the RS232 OUT connector of DISPLAY 1 to the RS232 IN connector of DISPLAY 2.

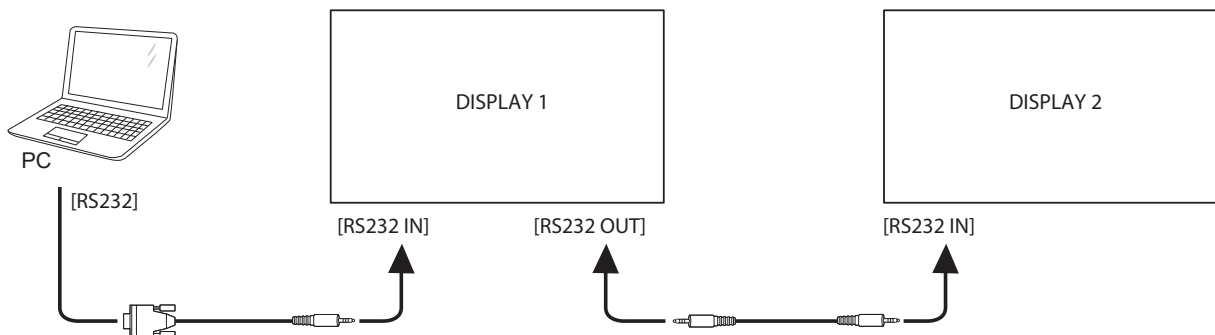

2.5.2 Digital Video Connection

Connect the DVI OUT connector of DISPLAY 1 to the DVI IN connector of DISPLAY 2.

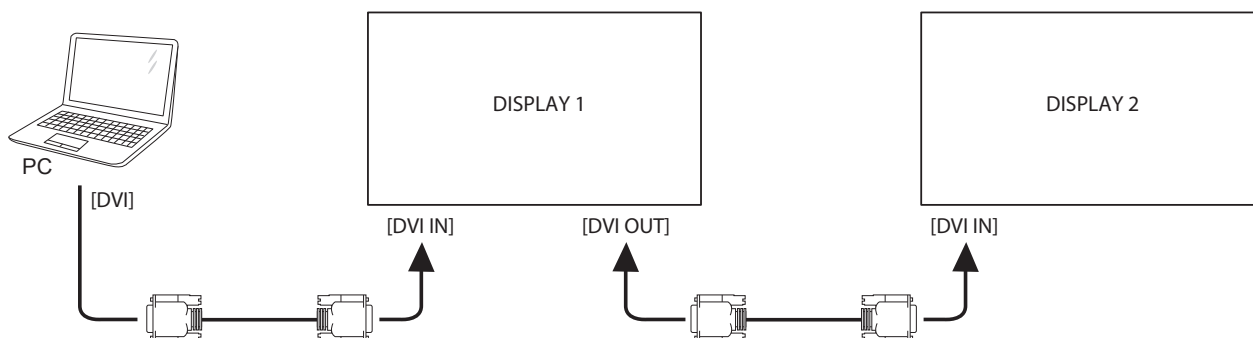

MAKING CONNECTIONS

Connect the DisplayPort OUT connector of DISPLAY 1 to the DisplayPort IN connector of DISPLAY 2.

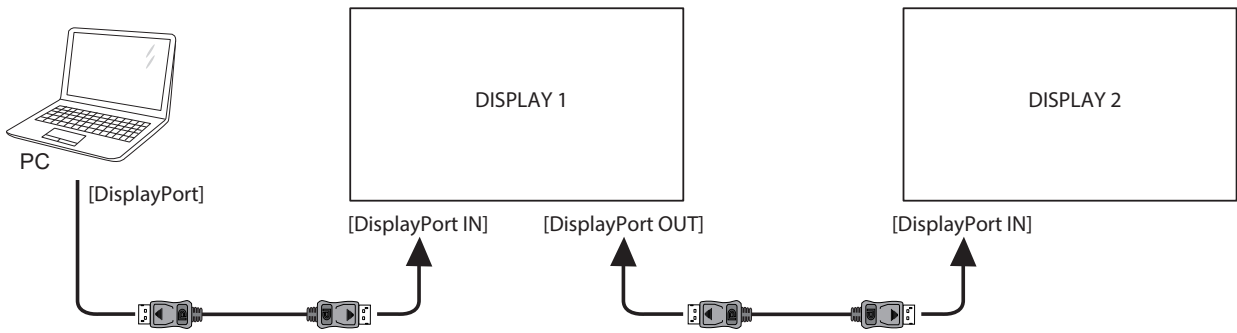

Note:

- ◆ Before selecting the DisplayPort 1.1a (**DisplayPort Ver. > 1.1a**) version, make sure the **Tiling mode > Enable** setting is set to **Off**.
- ◆ When using DisplayPort 1.1a, each display will clone the same content as the source.
- ◆ DisplayPort 1.2 supports MST up to 4 displays.

Connect the video player connector of DISPLAY 1 to the video player connector of DISPLAY 2.

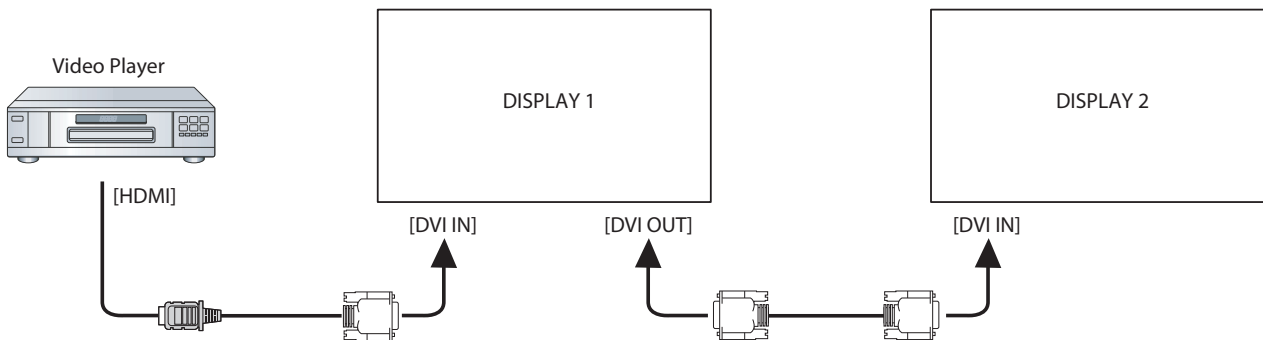

Connect the DVI OUT connector of DISPLAY 1 to the DVI IN connector of DISPLAY 2.

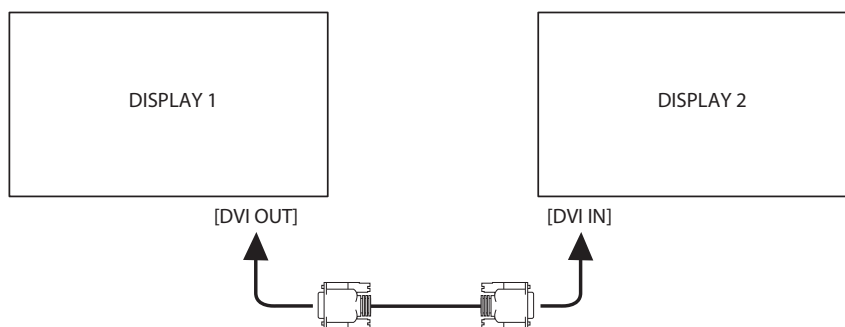

MAKING CONNECTIONS

2.5.3 Analogue Video Connection

Connect the DVI OUT connector of DISPLAY 1 to the VGA IN connector of DISPLAY 2.

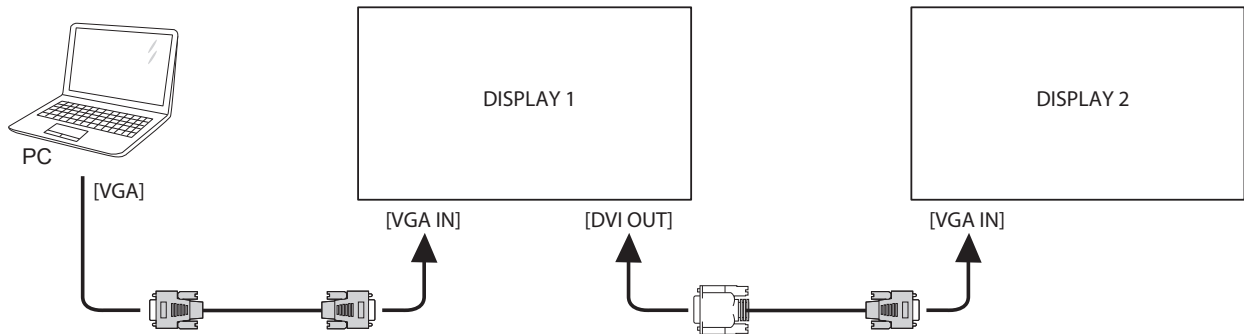

2.6 IR Connection

Connect the IR sensor cable to the IR IN connector of the LCD display.

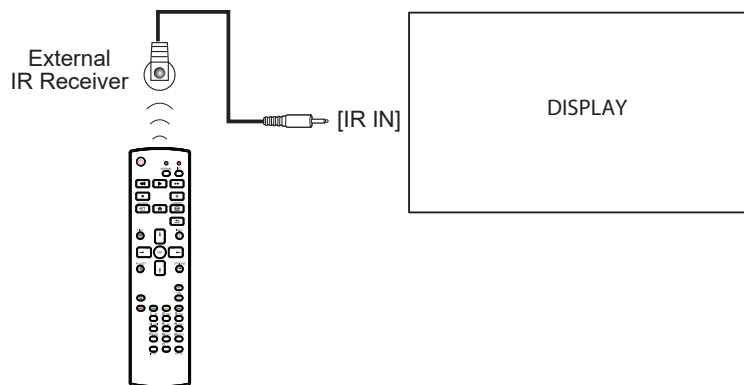

Note:

- ◆ This display's remote control sensor will stop working if the [IR IN] is connected.

MAKING CONNECTIONS

2.7 IR Pass-Through Connection

Connect one end of an IR extender cable to the IR OUT connector of the LCD display and the other end of an IR extender cable to the IR IN connector of the video player.

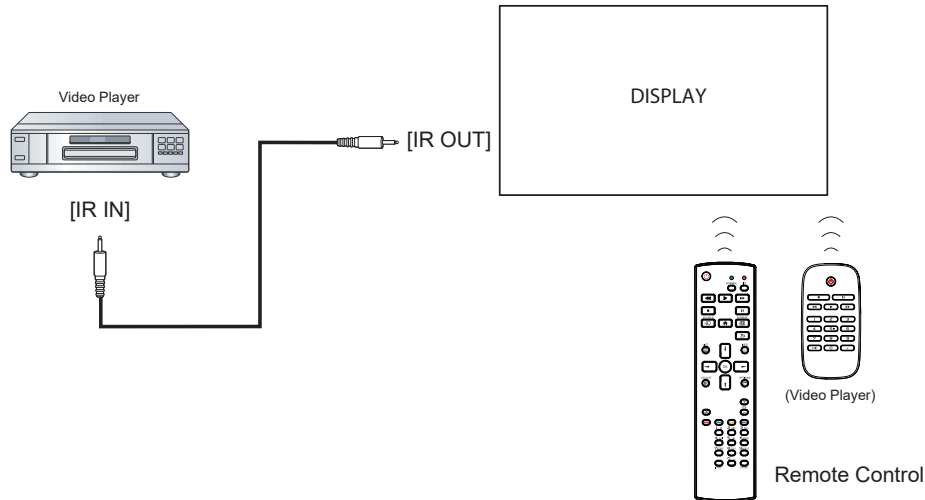

2.8 Connecting to Wired Network

If you connect this LCD display to a home network, you can play photos, music, and videos from your computer.

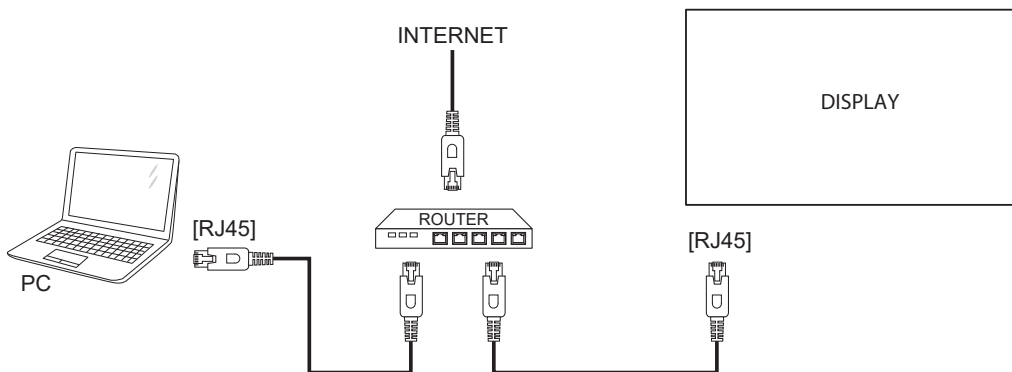

To setup the network:

- 1 Switch on the router and switch on its DHCP setting.
- 2 Connect the router to the LCD display with an Ethernet cable.
- 3 Press the **Home** button to display the OSD menu.
- 4 Press the **Up** or **Down** button to select **Network**. Press the **OK** button to enter its submenu.
- 5 Press the **Up** or **Down** button to select **Network configuration**. Press the **OK** to enter its submenu.
- 6 Press the **Up** or **Down** button to select **DHCP & Auto IP**. Press the **OK** button to confirm.

Note:

- ◆ Connecting with a shielded CAT-5 Ethernet cable to comply with the EMC directive.
- ◆ To manually configure the network parameters, set the **Network > Network configuration** setting to **Static IP**.

CHAPTER 3: USING THE LCD DISPLAY

3.1 Turning on the Power

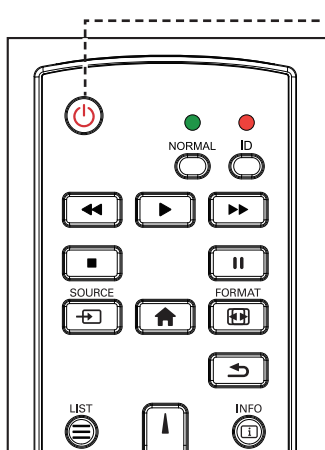

- 1 Plug the power cord to a power outlet or power supply.
- 2 Set the **Main Power** switch to ON.
- 3 Press the  button to turn the LCD display on.



When the LCD display is turned on, press the  button to turn off the LCD display.

Note:

- ◆ The LCD display still consumes power as long as the power cord is connected to the power outlet. Disconnect the power cord to completely cut off power.

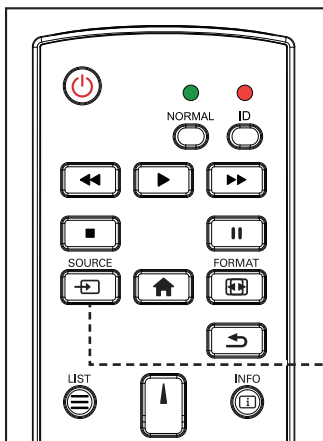
3.2 Selecting the Input Source Signal



- 1 Press the  button.
- 2 Press the  or  button to choose a device, then press the OK button.

Note:

- ◆ After pressing the  button, a menu with available input sources will be displayed on the screen.

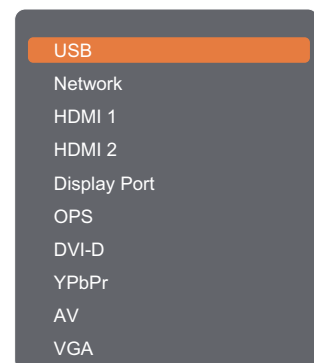

Note:

- ◆ The OPS option is only available for RX-42E and RX-55E models.
- ◆ If the selected input source signal is not connected to the LCD display or is turned off, the no signal message is displayed on the screen.

 No signal

USING THE LCD DISPLAY

3.3 Adjusting the Volume

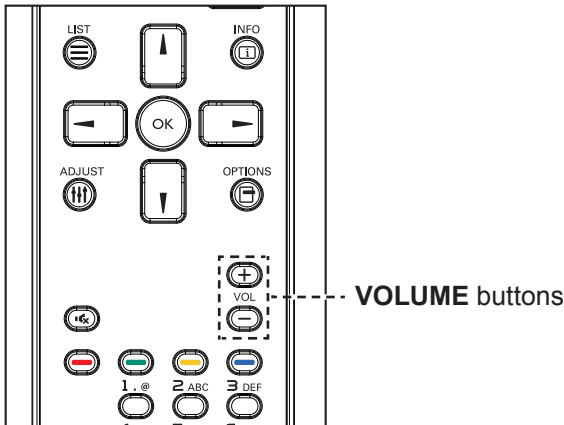

Press the — or + button to adjust the volume.

3.4 Changing the Picture Format

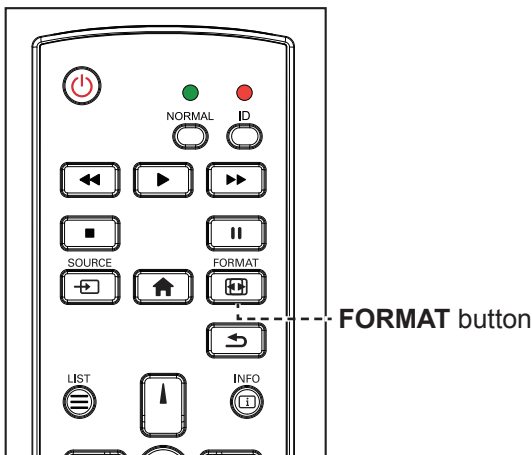

1 Press the  button.

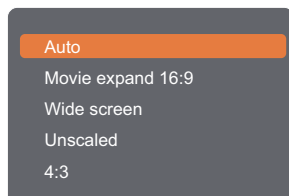

2 Press the ▲ or ▼ button to choose a picture format, then press the OK button.

Note:

- ◆ After pressing the — or + button, the volume icon is displayed on the screen automatically.



- ◆ Press the  button to mute the audio.

Note:

The available picture formats include:

- ◆ **Auto:** Enlarge the picture to fill the screen. Recommended for minimal screen distortion but not for HD or PC.
- ◆ **Movie expand 16:9:** Scale 4:3 format to 16:9. Not recommended for HD or PC.
- ◆ **Wide screen:** Shows wide screen format content unstretched. Not recommended for HD or PC.
- ◆ **Unscaled:** Provide maximum detail for PC. Only available when PC mode is selected in the Picture menu.
- ◆ **4:3:** Display the classic 4:3 format.

USING THE LCD DISPLAY

3.5 Using the Quick Menu

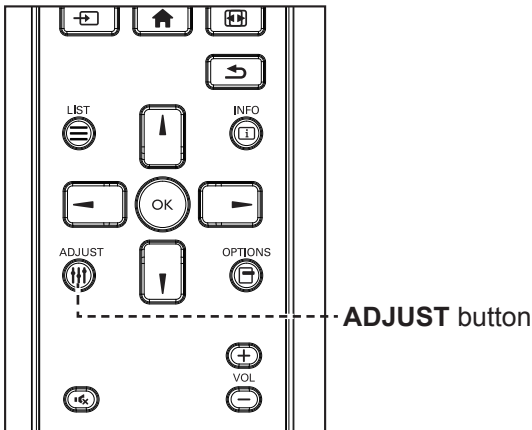

- 1 While this display is playing PC or video source, press the button.

The Quick Menu opens with the following options:

PC mode:

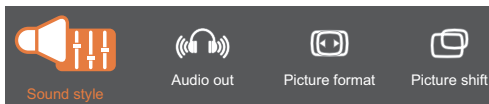

Video mode:

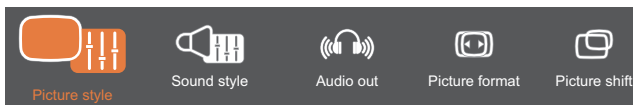

- 2 Press the or button to choose **Picture style** (only in Video mode), **Sound style**, **Audio out**, **Picture format**, or **Picture shift**, then press the **OK** button.

- **Picture style** (only in Video mode):

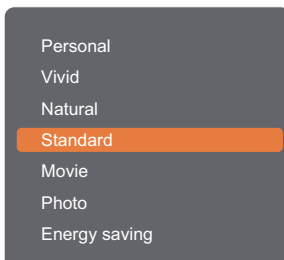

Press the , button to choose an option, then press the **OK** button.

- **Sound style:**

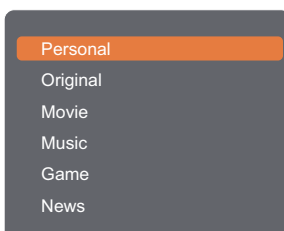

Press the , button to choose an option, then press the **OK** button.

Note:

The available picture styles include:

- ◆ **Personal:** Apply your personalised picture settings.
- ◆ **Vivid:** Rich and dynamic settings, ideal for daytime viewing.
- ◆ **Natural:** Natural picture settings.
- ◆ **Standard:** Default settings that suit most environments and types of video.
- ◆ **Movie:** Ideal settings for movies.
- ◆ **Photo:** Ideal settings for photos.
- ◆ **Energy saving:** Settings that conserve the most energy.

The available sound settings include:

- ◆ **Personal:** Apply your personalised sound settings.
- ◆ **Original:** Settings that suit most environments and types of audio.
- ◆ **Movie:** Ideal settings for movies.
- ◆ **Music:** Ideal settings for listening to music.
- ◆ **Game:** Ideal settings for games.
- ◆ **News:** Ideal settings for spoken audio, such as the news.

USING THE LCD DISPLAY

- **Audio out:**

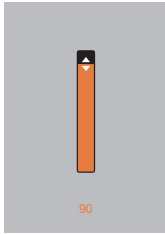

Press the ▲, ▼ button to adjust the value.

- **Picture format:**

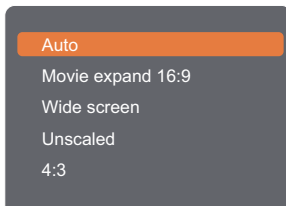

Press the ▲, ▼ button to choose an option, then press the OK button.

- **Picture shift:**



Press the ▲, ▼, ◀, or ▶ button to adjust the value.

Note:

- ◆ For the available Picture formats, see page 44.

USING THE LCD DISPLAY

3.6 Playing Multimedia Files via Local Area Network

To play files via Local Area Network, you will need:

- A wired home network, connected with a Universal Plug and Play (uPnP) router.
- Optional: A LAN cable that connects your display to your home network.
- A media server running on your computer.
- Appropriate settings on your computer firewall to allow you to run the media server.

3.6.1 Set Up the Network

- 1 Connect your display and the computer to the same home network. See illustration below to connect your display to a network.
- 2 Switch on your computer and the router.
 - Single display setup:

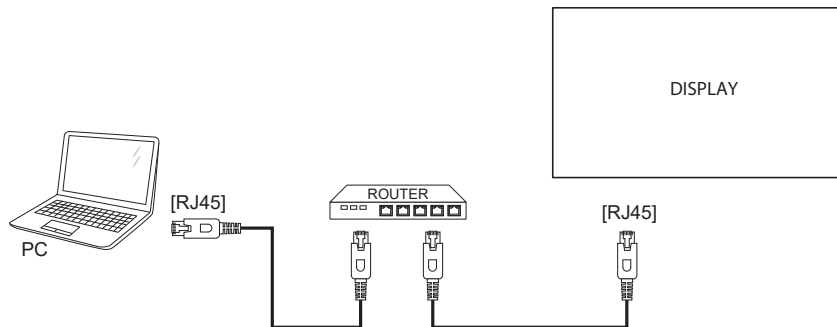

- Multiple display setup:

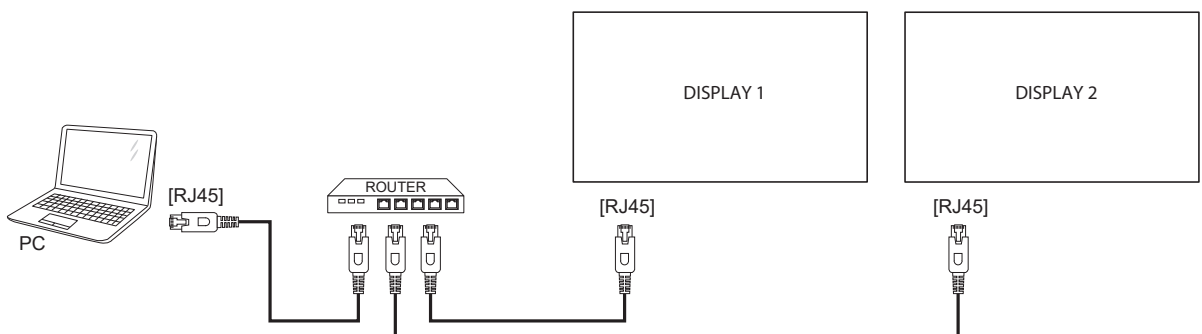

USING THE LCD DISPLAY

Set Up Media Sharing

- 1 Install a media server on your computer to share media files. These are some media servers:
 - For PC: Windows Media Player 11 (or higher) or TVersity
 - For Mac: Twonky
- 2 Switch on media streaming on your computer using the media server. For more information on how to set up the media server, refer to the website of the media server.

3.6.2 How to Use DLNA-DMP



- 1 Please connect display and your PC to the same router via RJ45.
- 2 Run Windows Media Player. Set stream handling as public sharing.

Play Files from Display

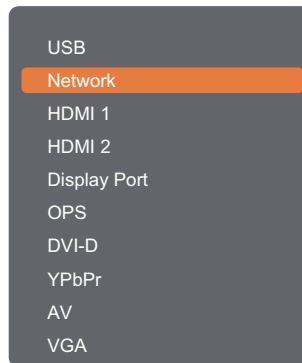
- 1 Press the  button, choose network and press the **OK** button.



Note:

- ◆ The OPS option is only available for RX-42E and RX-55E models.
- 2 Now, you can see all the PC's connected to the same router on the screen. Choose the right one.
 - 3 Press the  or  button to choose the directory and files to play.
 - 4 You can connect up to 4 displays to the same PC and play same media stream.

We suggest to use DLNA-DMP function via wired network for the sake of higher security and sufficient network bandwidth.

USING THE LCD DISPLAY

3.6.3 How to Use DLNA-DMR from PC

- 1 Press the  button. Then choose **Network** and press the OK button.

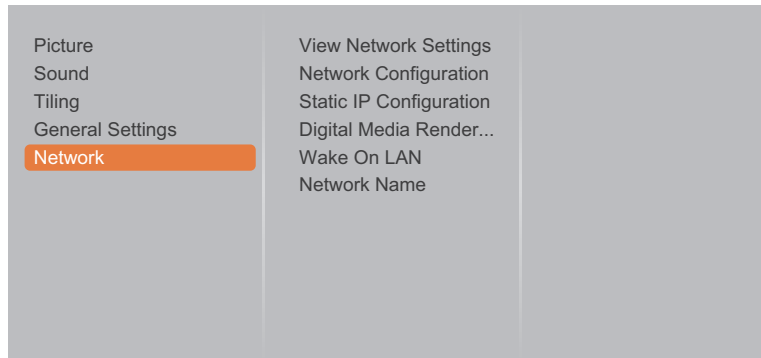

- 2 Set the **Digital Media Renderer -DMR** setting to **On**.

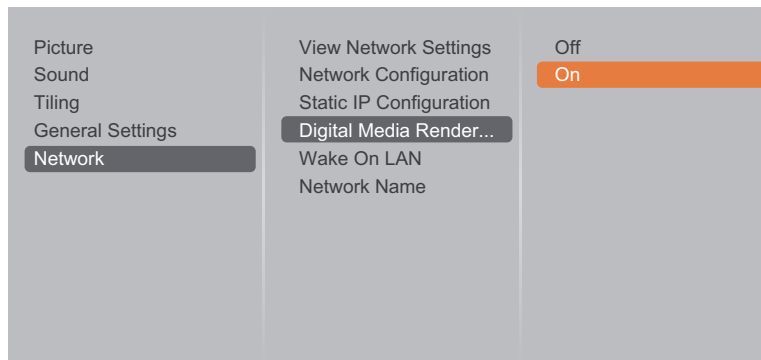



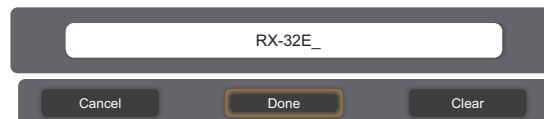
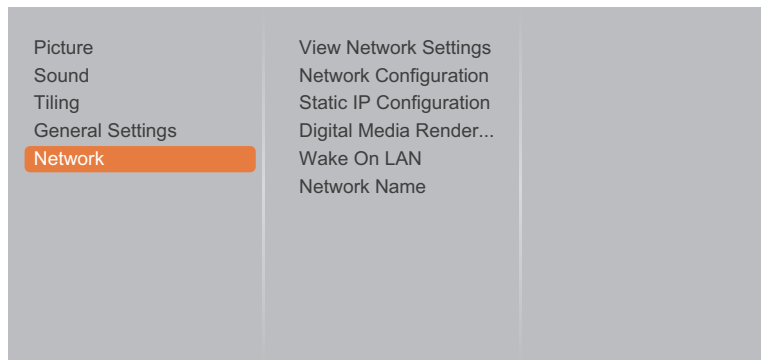



- 3 Set the name of your display.



- 4 Press the  button, choose **Network** and press the OK button.
- 5 On your PC, go to **Network and Sharing Center**, and click **Choose homegroup and sharing options**.
- 6 Check the media formats. Then, click **Choose media streaming options.....**
- 7 Go to **Advanced sharing settings**, and check **Turn on network discovery**.
- 8 Now, go to the directory of your media files. Choose the media file by right click. On the submenu from **Play To**, You can find all displays connected to your network. Choose the display, and click the media file to play.

USING THE LCD DISPLAY

Play Files

- 1 Press the  button. Then choose **Network** and press the **OK** button.
- 2 Choose a file from the content browser, and press the **OK** button to start playing.
- 3 Press the **PLAY** buttons (, , , , ) on the remote control to control the media playback.

Tips:

- Choose the top bar to filter your files by type.
- Choose **Sort** to arrange the files by album name, artist, or other fields.
- To clear the list of offline media servers, press the  button. Then, choose **Clear offline servers** and press the **OK** button.

3.7 Playing Multimedia Files from USB Device

- 1 Connect your USB device to the USB connector on the LCD display.

RX-32E

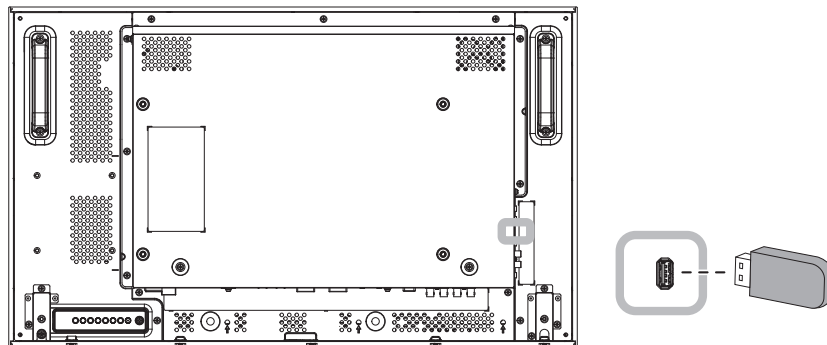

RX-42E

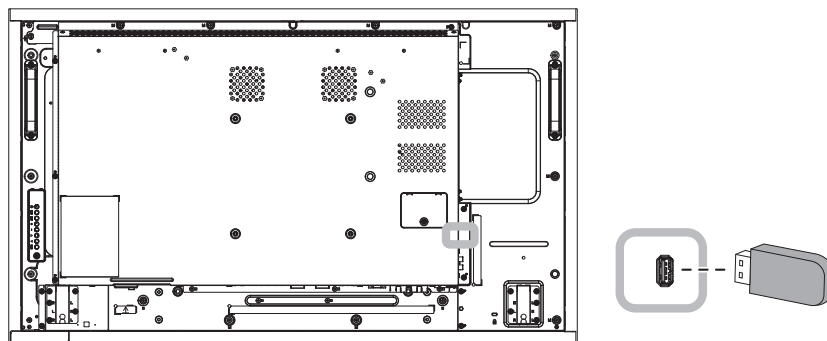

RX-55E

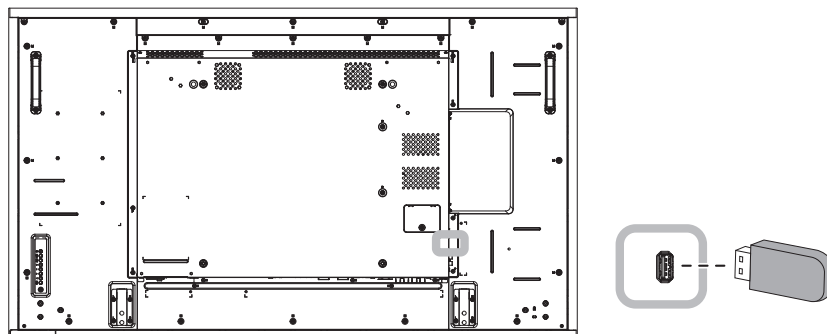

USING THE LCD DISPLAY

- 2 Press the  button. Then choose **USB**, and press the **OK** button.

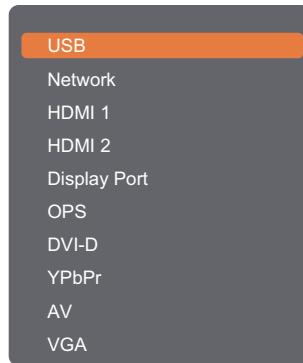

Note:





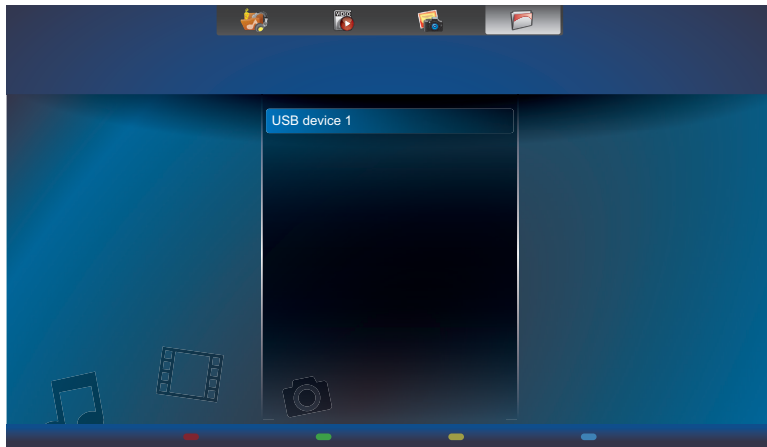

- ◆ The OPS option is only available for RX-42E and RX-55E models.

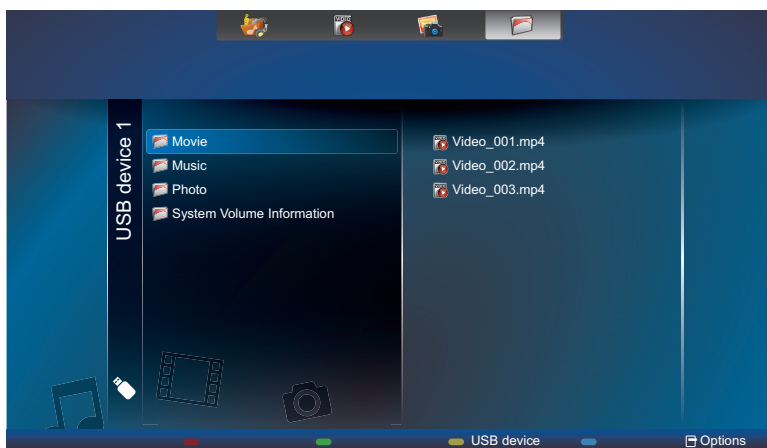



- 3 Press the **OK** button to enter the USB mode.



- 4 By default, it displays the files in Folder view.



Press the  button to go up the top layer in the screen. Then press the  or  button to select the desired file type:  Music,  Movie, and  Photo.

- 5 Press the **OK** button to enter its play list.
- 6 Choose the file you want. Press the **OK** button to start playing.
- 7 Follow the on-screen instructions to control the play option.
- 8 Press the **PLAY** buttons (, , , , ) on the remote control to control the media playback.

USING THE LCD DISPLAY

3.8 Play Options









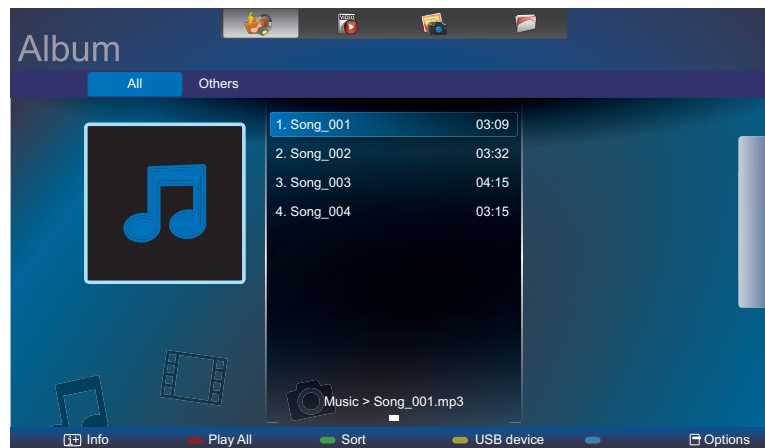

3.8.1 Playing Music Files

- 1 Choose  **Music** in the top bar.







- 2 Choose one music track, and press the OK button.





- To play all the tracks in a folder, choose one music file. Then, press the  button to **Play All**.
- To view USB device, press the  button.
- To skip to the next or previous track, press the  or  button.
- To pause the track, press the OK or  button. Press the OK or  button again to resume playback.
- To skip backward or forward 10 seconds, press the  or  button.
- To search backward or forward, press the  or  button, press repeatedly to toggle between different speeds.
- To stop the music, press the  button.

Music options

While you play music, press the  button, then use the , , , or  to choose an option. Then press the OK button to select an option:

- **Shuffle:** Enable or disable random play of tracks.
- **Repeat:** Choose **Repeat** to play a track or an album repeatedly, or choose **Play Once** to play a track once.
- **Subtitles:** Choose the available subtitle settings.

Note:

- ◆ To view information about a song (for example, title, artist or duration), choose the song, then press the  button. To hide the information, press the  button again.

USING THE LCD DISPLAY







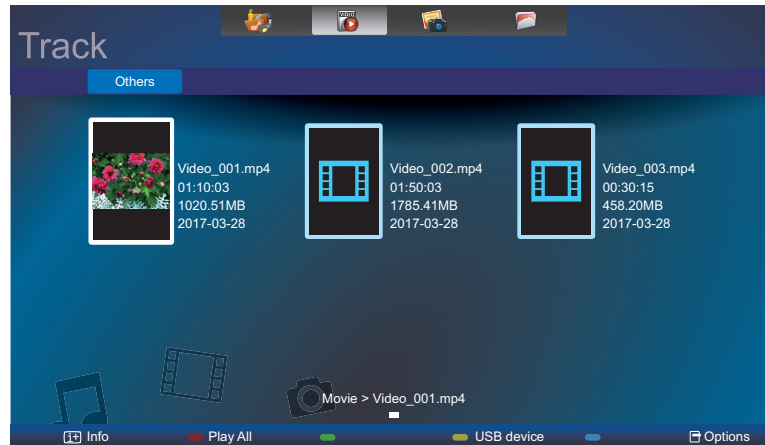

3.8.2 Playing Movie Files

- 1 Choose  **Movie** in the top bar.







- 2 Choose a video, and press the OK button.



- To play all the videos in a folder, choose one video file. Then, press the  button to **Play All**.
- To view USB device, the  button.
- To pause the video, press the **OK** or  button. Press the **OK** or  button again to resume playback.
- To skip backward or forward 10 seconds, press the  or  button.
- To search backward or forward, press the  or  button, press repeatedly to toggle between different speeds.
- To stop the video, press the  button.

Movie options

While playing video, press the  button, then use , , , or  to choose an option. Then press the **OK** button to select an option:

- **Subtitles:** Choose the available subtitle settings.
- **Shuffle:** Enable or disable random play of video files.
- **Repeat:** Choose **Repeat** to play the video file repeatedly or **Play Once** to play the video file once.

USING THE LCD DISPLAY

3.8.3 Playing Photo Files

- 1 Choose  **Photo** in the top bar.





- 2 Choose a photo thumbnail, then press the **OK** button.



Start a Slideshow

If there are multiple photos in a folder, choose a photo. Then, press the  button to **Play All**.

- To skip to the previous or next photo, press the  or  button, and then press the **OK** button.
- To stop the slideshow, press the  button.

Slideshow options

While you play a slideshow, press the  button, then press the **OK** button to choose an option:



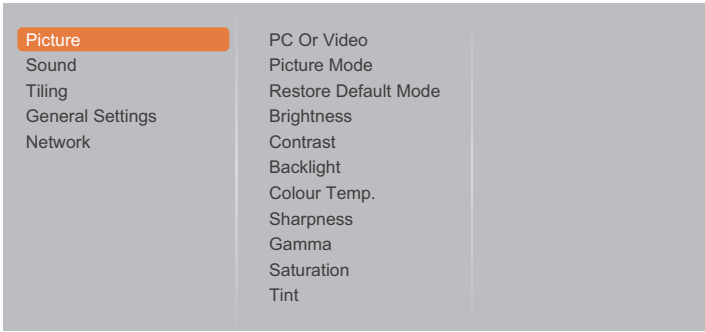
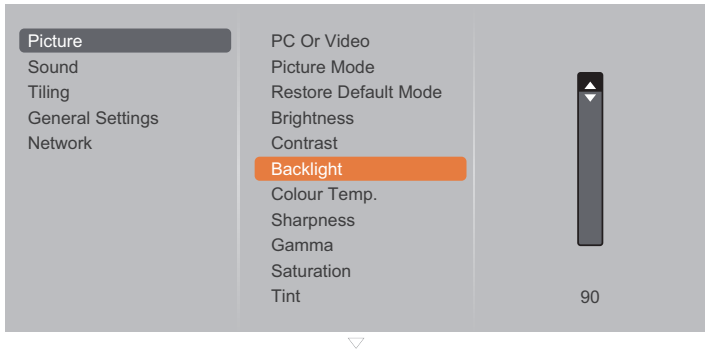
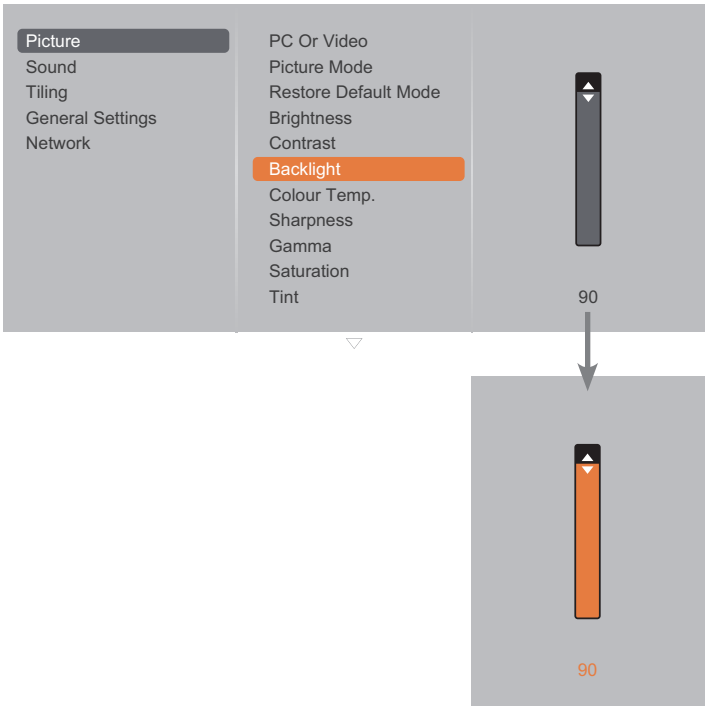

- **Shuffle**: Enable or disable random display of pictures in the slideshow.
- **Repeat**: Choose **Repeat** to watch a slideshow repeatedly or **Play Once** to watch once.
- **Slideshow Time**: Choose the displaying time for each photo in the slideshow.
- **Slideshow Transitions**: Choose the transition from one photo to the next.

CHAPTER 4: ON SCREEN DISPLAY MENU

4.1 Using the OSD Menu

#	Menu Navigation	Operation	
		Control Panel	Remote Control
1	<p>Display the main menu screen.</p> 	Press the MENU button.	Press the ⬆ button.
2	<p>Enter the submenu.</p>  <p>The highlighted item (orange) indicates the active submenu.</p>	<ol style="list-style-type: none"> 1 Press the ▲ or ▼ button to select the menu item. 2 Press the INPUT button to enter the submenu. 	<ol style="list-style-type: none"> 1 Press the ⬇ or ⬆ button to select the menu item. 2 Press the OK or ▶ button to enter the submenu.
3	<p>Adjust the settings.</p> <p>The highlighted item indicates the active submenu.</p> <p>For example:</p> 	<ol style="list-style-type: none"> 1 Press the ▲ or ▼ button to adjust the value of the menu item. 2 Press the INPUT button to confirm. 	<ol style="list-style-type: none"> 1 Press the ⬇ or ⬆ button to adjust the value of the menu item. 2 Press the OK button to confirm.

ON SCREEN DISPLAY MENU

#	Menu Navigation	Operation	
		Control Panel	Remote Control
4	Exit the submenu.	Press the  button to return to the previous menu.	Press the  or  button to return to the previous menu.
5	Close the OSD window.	Press the MENU button again.	Press the  button again.

When settings are modified, all changes are saved when the user does the following:

- Proceeds to the another menu.
- Exits the OSD menu.
- Waits for the OSD menu to disappear.

Note:

- ◆ Availability of some menu items depend on the input source signal.

ON SCREEN DISPLAY MENU

4.2 OSD Menu Tree

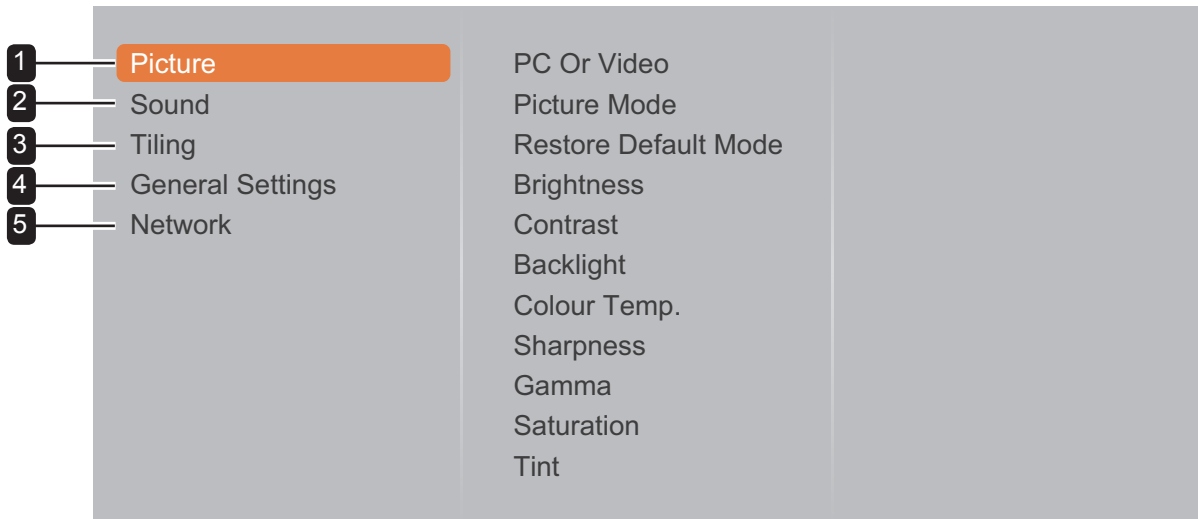

Main Menu	Submenu	Remarks
1. Picture	<ul style="list-style-type: none"> • PC Or Video • Picture Mode • Restore Default Mode • Brightness • Contrast • Backlight • Colour Temp. • Sharpness • Gamma • Saturation • Tint • Aspect Ratio • Color Range • Advanced • VGA Auto Adjust • VGA Input Resolution 	See page 59.
2. Sound	<ul style="list-style-type: none"> • Sound Mode • Restore Default Mode • Bass • Treble • Balance • Surround Mode • Volume • Advanced • OPS Audio 	See page 63.

ON SCREEN DISPLAY MENU

Main Menu	Submenu	Remarks
3. Tiling	<ul style="list-style-type: none"> • Tiling Mode • H Monitors • V Monitors • Position • Frame Comp. 	See page 65.
4. General settings	<ul style="list-style-type: none"> • Language • Logo • Information OSD • Anti-Burn-in • Alink • Advanced Power Management • Auto Brightness • DisplayPort Ver. • KEY Lock • RC Lock • Source Detect • Sleep Timer • Monitor ID • Clock • Scheduling • Cooling Fan • RS232 Control Port • Factory Defaults 	See page 67.
5. Network	<ul style="list-style-type: none"> • View Network Settings • Network Configuration • Static IP Configuration • Digital Media Renderer - DMR • Wake On LAN • Network Name 	See page 76.

Note:

- ◆ Availability of some menu items depend on the input source signal.
- ◆ “Cooling Fan” and “RS232 Control Port” options are only applicable for RX-42E and RX-55E models.

CHAPTER 5: ADJUSTING THE LCD DISPLAY

5.1 Picture Settings

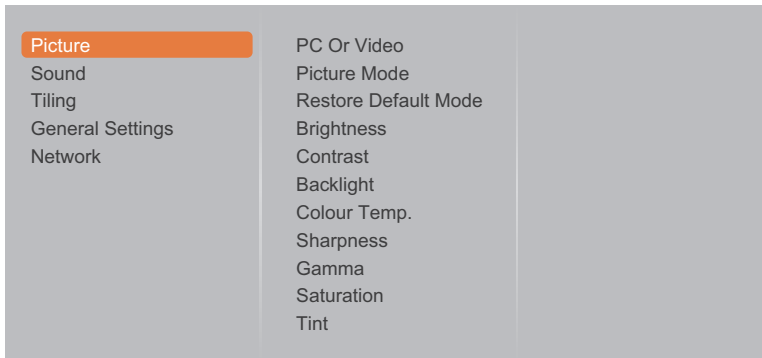

- 1 Press the **MENU** button on the control panel or the **⬆** button on the remote control to call out the OSD window.
- 2 Select **Picture**, then press the **INPUT** button on the control panel or the **OK** button on the remote control.
- 3 Press the **▲/▼** button on the control panel or the **⬆/⬆** button on the remote control to select an option.
- 4 Press the **INPUT** button on the control panel or the **OK** button on the remote control to enter the submenu.

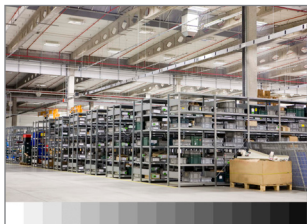
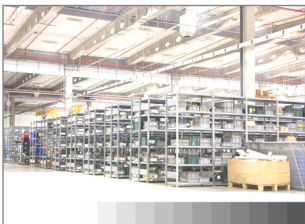
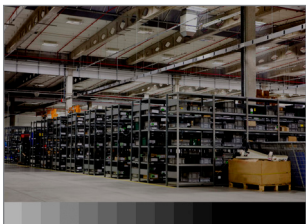
Item	Function	Operation	Range
PC or Video	Switch to the correct mode depending on your input source. Note: This option is not available in VGA, DVI, AV, and YPbPr modes.		Video PC
Picture Mode	Choose a predefined picture setting. Note: This option is not available in PC mode.	Press the ▲/▼ button on the control panel or the ⬆/⬆ button on the remote control to select the setting.	Personal Vivid Natural Standard Movie Photo Energy saving
Restore Default Mode	Restore the last-selected predefined picture setting.	a) Press the +/- button on the control panel or the ⬅/➡ button on the remote control to select the setting. b) Press the INPUT button on the control panel or the OK button on the remote control to confirm.	Yes No
Brightness	Adjust the luminance of the screen image.	Press the ▲/▼ button on the control panel or the ⬆/⬆ button on the remote control to adjust the value.	0 to 100
			<div style="display: flex; justify-content: space-around; text-align: center;"> <div> <p>Original Setting</p>  </div> <div> <p>High Setting</p>  </div> <div> <p>Low Setting</p>  </div> </div>

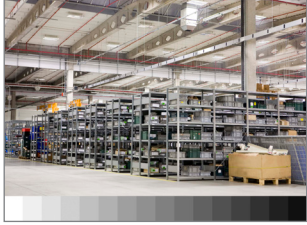
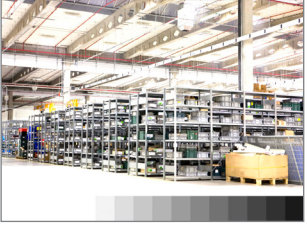
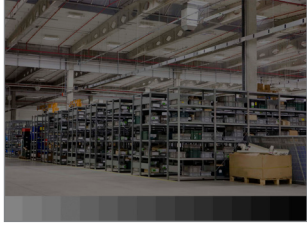

ADJUSTING THE LCD DISPLAY

Item	Function	Operation	Range
Contrast	Adjust the difference between the black level and the white level.	Press the ▲▼ button on the control panel or the M button on the remote control to adjust the value.	0 to 100
	<p style="text-align: center;"><i>Original Setting</i></p>  <p style="text-align: center;"><i>High Setting</i></p>  <p style="text-align: center;"><i>Low Setting</i></p> 		
Backlight	Adjust the brightness of the LCD display's backlight.	Press the ▲▼ button on the control panel or the M button on the remote control to adjust the value.	0 to 100
Colour Temp.	<p>Adjust the color temperature of the screen image. Select one of the Colour options:</p> <ul style="list-style-type: none"> • Cool: Apply a bluish tint for cooler colours. • Neutral: Use in neutral lighting conditions. • Warm: Apply a reddish tint for warmer colours. • sRGB: Display accurate colours. Most suitable for viewing images on the Internet. • User: Set the colour temperature by adjusting the R, G, B settings according to your preference. <p>Note: If you set the colour temperature to User option, adjust the R, G, B level in Picture > Colour Temp. > User menu. For manual setting, the adjustment range of each color is 0 to 255. For automatic adjustment, select the setting among Cool, Neutral, Warm, and sRGB.</p>	Press the ▲▼ button on the control panel or the M button on the remote control to select the setting.	<p>Cool</p> <p>Neutral</p> <p>Warm</p> <p>sRGB</p> <p>User</p>
Sharpness	Adjust the clarity and focus of the screen image.	Press the ▲▼ button on the control panel or the M button on the remote control to adjust the value.	0 to 100

ADJUSTING THE LCD DISPLAY

Item	Function	Operation	Range
Gamma	Adjust the non-linear setting for picture luminance and contrast.	Press the ▲/▼ button on the control panel or the M/ button on the remote control to select the setting.	1.8 2.0 2.2 2.4 S
Saturation	Adjust the colour saturation of the screen image.	Press the ▲/▼ button on the control panel or the M/ button on the remote control to adjust the value.	0 to 100
Tint	Adjust the colour tint.		0 to 100
Aspect Ratio	Adjust the aspect ratio of the screen image. Note: This option is not available in PC mode. • Picture Format: Choose the picture format depending on the screen image.	Press the ▲/▼ button on the control panel or the M/ button on the remote control to select the setting.	Auto Movie Expand 16:9 Wide Screen Unscaled 4:3
	• Picture Shift: Adjust the picture position.	Press the ▲/▼/+/− button on the control panel or the M/←/→ button on the remote control to adjust the setting.	Up Down Left Right
Color Range	Choose the output setting for the video input signal. Note: ◆ This option is not available in PC, AV, and YPbPr modes. ◆ Select Limited when displaying the signal that uses 16-255 RGB levels. Otherwise select Full when displaying the signal that uses 0-255 RGB levels.	Press the ▲/▼ button on the control panel or the M/ button on the remote control to select the setting.	Auto Limited Full
Advanced	Configure the advanced settings of the LCD display. Note: This option is not available in PC mode. • Noise Reduction: Adjust the noise reduction to help remove noise from the screen images. This helps produce clearer and crisper images.		Off Low Medium High

ADJUSTING THE LCD DISPLAY

Item	Function	Operation	Range
	<p align="center">Noise Reduction Off</p> 	<p align="center">Noise Reduction On</p> 	
Advanced	<ul style="list-style-type: none"> • MPEG Artifact Reduction: Smoothen transitions and haziness in the digital picture. 	Press the ▲▼ button on the control panel or the M/ button on the remote control to select the setting.	Off On
	<ul style="list-style-type: none"> • Advanced Sharpness: Enable superior sharpness, especially on lines and contours in the picture. 		Off On
	<ul style="list-style-type: none"> • Dynamic Contrast: Enable superior sharpness, especially on lines and contours in the picture. 		Off Low Medium High
	<ul style="list-style-type: none"> • Color Enhancement: Dynamically enhance the vividness and details of colours. 		Off Low Medium High
VGA Auto Adjust	Use this function to automatically optimize the display of VGA input image.	a) Press the +/- button on the control panel or the ←/→ button on the remote control to select the setting. b) Press the INPUT button on the control panel or the OK button on the remote control to confirm.	Cancel Start
VGA Input Resolution	Choose the display resolution. Note: This option is available only in VGA mode and can be selected only if the timing is supported by the VGA source.	Press the ▲▼ button on the control panel or the M/ button on the remote control to select the setting.	1366x768@60 1360x768@60 1280x768@60 1024x768@60 1680x1050@60 1400x1050@60

ADJUSTING THE LCD DISPLAY

5.2 Sound Settings

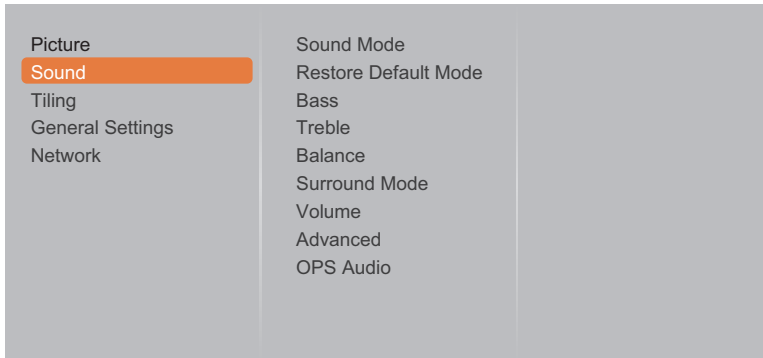

- 1 Press the **MENU** button on the control panel or the **⬆️** button on the remote control to call out the OSD window.
- 2 Select **Sound**, then press the **INPUT** button on the control panel or the **OK** button on the remote control.
- 3 Press the **▲/▼** button on the control panel or the **⬆️/⬆️** button on the remote control to select an option.
- 4 Press the **INPUT** button on the control panel or the **OK** button on the remote control to enter the submenu.

Item	Function	Operation	Range
Sound Mode	Choose the sound mode for the audio content.	Press the ▲/▼ button on the control panel or the ⬆️/⬆️ button on the remote control to select the setting.	Personal Original Movie Music Game News
Restore Default Mode	Restore the last-selected predefined sound setting.	a) Press the +/- button on the control panel or the ←/→ button on the remote control to select the setting. b) Press the INPUT button on the control panel or the OK button on the remote control to confirm.	Yes No
Bass	Adjust to increase or decrease lower-pitched sounds.	Press the ▲/▼ button on the control panel or the ⬆️/⬆️ button on the remote control to adjust the value.	-8 to +8
Treble	Adjust to increase or decrease higher-pitched sounds.		-8 to +8
Balance	Adjust to emphasize left or right audio output balance.		-8 to +8
Surround Mode	Enhance your audio experience.	Press the ▲/▼ button on the control panel or the ⬆️/⬆️ button on the remote control to select the setting.	Off On

ADJUSTING THE LCD DISPLAY

Item	Function	Operation	Range
Volume	Adjust the audio volume.	Press the ▲/▼ button on the control panel or the M button on the remote control to adjust the value.	0 to 100
Advanced	<ul style="list-style-type: none"> • Internal Speakers: Turn on or off the internal speakers. 	Press the ▲/▼ button on the control panel or the M button on the remote control to select the setting.	Off On
	<ul style="list-style-type: none"> • External Audio Volume: Adjust the external audio volume. 	Press the ▲/▼ button on the control panel or the M button on the remote control to adjust the value.	0 to 100
	<ul style="list-style-type: none"> • Auto Volume Leveling: Enable the reduction of sudden volume changes. 	Press the ▲/▼ button on the control panel or the M button on the remote control to select the setting.	Off On
	<ul style="list-style-type: none"> • Clear sound: Enhance sound quality. 	Press the ▲/▼ button on the control panel or the M button on the remote control to select the setting.	Off On
OPS Audio	Specify the OPS audio output format. Note: This option is only applicable for RX-42E and RX-55E models with the input source is set to OPS.	Press the ▲/▼ button on the control panel or the M button on the remote control to adjust the value.	Auto Analog Digital

ADJUSTING THE LCD DISPLAY

5.3 Tiling Settings



- 1 Press the **MENU** button on the control panel or the **⬆** button on the remote control to call out the OSD window.
- 2 Select **Tiling**, then press the **INPUT** button on the control panel or the **OK** button on the remote control.
- 3 Press the **▲/▼** button on the control panel or the **↕** button on the remote control to select an option.
- 4 Press the **INPUT** button on the control panel or the **OK** button on the remote control to enter the submenu.

Item	Function	Operation	Range
Tiling Mode	<p>With this function, you can create a single large-screen matrix (video wall) that consists of up to 100 sets of this display (up to 10-sets on the vertical and 10-sets on the horizontal sides).</p> <p>If tiling is enabled, you can configure the following display settings:</p> <ul style="list-style-type: none"> • H Monitors • V Monitors • Position • Frame Comp. 	Press the ▲/▼ button on the control panel or the ↕ button on the remote control to select the setting.	Off On
H Monitors	Adjust displays on the horizontal side.	Press the ▲/▼ button on the control panel or the ↕ button on the remote control to adjust the value.	1 to 10
V Monitors	Adjust displays on the vertical side.	Press the ▲/▼ button on the control panel or the ↕ button on the remote control to adjust the value.	1 to 10

ADJUSTING THE LCD DISPLAY

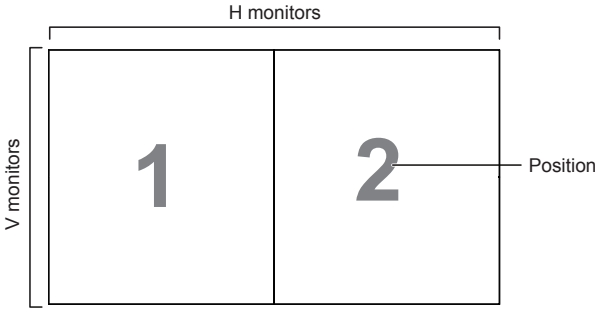
Item	Function	Operation	Range
Position	Adjust the position of this display in the screen matrix. Please see the Example1 for reference.	Press the ▲/▼ button on the control panel or the ⏪ button on the remote control to adjust the value.	0 to 100
	<p><u>Example1</u>: 1 x 2 screen matrix (2 displays)</p> <ul style="list-style-type: none"> • H monitors = 2 displays • V monitors = 1 display 		
Frame Comp.	<p>If frame compensation is enabled, then the display will adjust the image to compensate for the width of the display bezels in order to accurately display the image.</p> <ul style="list-style-type: none"> • Frame Comp. H 0~100 • Frame Comp. V 0~100 	Press the ▲/▼ button on the control panel or the ⏪ button on the remote control to select the setting.	Off On

ADJUSTING THE LCD DISPLAY

5.4 General Settings







- 1 Press the **MENU** button on the control panel or the **⬆** button on the remote control to call out the OSD window.
- 2 Select **General settings**, then press the **INPUT** button on the control panel or the **OK** button on the remote control.
- 3 Press the **▲/▼** button on the control panel or the **⬆/⬇** button on the remote control to select an option.
- 4 Press the **INPUT** button on the control panel or the **OK** button on the remote control to enter the submenu.

Item	Function	Operation	Range
Language	Choose the language used for OSD menus.	Press the ▲/▼ button on the control panel or the ⬆/⬇ button on the remote control to select the setting.	English Deutsch 繁體中文 Français Italiano Español Русский Polski Türkçe 简体中文 Português اللغة العربية 日本語
Logo	When enabled, the AG Neovo logo will be shown on the startup screen.		Off On
Information OSD	When this function is enabled and the display is turned on while in standby mode, an information OSD is displayed on the upper left corner of the screen.		Off On
Anti-Burn-in	For video input sources, enable Anti-Burn-in™ function to protect the display from “burn-in” or “afterimage” symptoms when the display is not being in use for a period of time.		

ADJUSTING THE LCD DISPLAY

Item	Function	Operation	Range
Anti-Burn-in	<ul style="list-style-type: none"> • Mode: Set the “Anti-Burn-in” mode. 	<p>Press the ▲/▼ button on the control panel or the ⏪ button on the remote control to select the setting.</p>	Off
	<ul style="list-style-type: none"> • Interval (HOURS): Set the interval time in hours between activating the Anti-Burn-in™ function. 		A
			B
			C
			4
Alink	<p>Enable or disable HDMI Consumer Electronics Control control.</p> <p>If the setting is set to On, you can control the connected HDMI CEC-compatible device on the same power on or power off status.</p>	<p>Press the ▲/▼ button on the control panel or the ⏪ button on the remote control to select the setting.</p>	5
			6
	8		
	Off		
	On		
Advanced Power Management	<p>Configure advanced power settings.</p> <ul style="list-style-type: none"> • Power Saving Mode: Enable or disable power saving mode. When the LCD display turns into power saving mode, the screen turns black and the LED indicator lights amber. 	<p>Press the ▲/▼ button on the control panel or the ⏪ button on the remote control to adjust the value.</p>	Off
	<ul style="list-style-type: none"> • Switch Power On State: Choose the display status used for the next time you connect the power cord. 		On
	<ul style="list-style-type: none"> • Switch Power On Delay Times: Adjust the power-on delaying time (in seconds) allows a sequential powering-on for each display by their ID number when multiple displays are connected. 		Standby
	<ul style="list-style-type: none"> • Energy Saving: Choose Normal for PC wake up. 		Last Status
	<ul style="list-style-type: none"> • LED Indicator: Set the LCD monitor’s LED indicator on or off. 		0 to 60
Auto Brightness	Automatically adjust the screen brightness according to the ambient light.	<p>Press the ▲/▼ button on the control panel or the ⏪ button on the remote control to select the setting.</p>	Normal
			Low Power
			Standby
			Off
			On
			Off
			On

ADJUSTING THE LCD DISPLAY

Item	Function	Operation	Range
DisplayPort Ver.	<p>Set the DisplayPort version to 1.1a or 1.2. This setting is only valid on DisplayPort input and output as follows.</p> <ul style="list-style-type: none"> • 1.1a: Switch DisplayPort Ver. to 1.1a(default), then the DisplayPort output is the clone of the DisplayPort input. • 1.2: Switch DisplayPort Ver. to 1.2 to support MST(Multi-Stream Transport). <p>Note: If the display is black screen or abnormal under DisplayPort source, please switch to 1.1a and turn AC off and on.</p>		<p>1.1a 1.2</p>
KEY Lock	<p>Choose to enable or disable the keyboard (control panel buttons) function of the LCD display.</p> <ul style="list-style-type: none"> • Unlock: Enable the keyboard function. • Lock all: Lock all keyboard function. • Lock but volume: Disable all the keyboard function except the + or - button. • Lock but power: Disable all the keyboard function except the  button. • Lock all except volume and power: Disable all the keyboard function except the +, -, or  button. <p>Note: To disable the KEY Local function, press the  button and buttons 1 9 9 8 on the remote control.</p>	<p>Press the  button on the control panel or the  button on the remote control to select the setting</p>	<p>Unlock Lock All Lock But Volume Lock But Power Lock All Except Volume and Power</p>

ADJUSTING THE LCD DISPLAY

Item	Function	Operation	Range
RC Lock	<p>Choose to enable or disable the button function of the remote control.</p> <ul style="list-style-type: none"> • Unlock: Enable the button function of the remote control. • Lock all: Lock all button functions of the remote control. • Lock but volume: Disable all the button functions except the — or + button. • Lock but power: Disable all the button functions except the ⏻ button. • Lock all except volume and power: Disable all the button functions of the remote control except the —, +, or ⏻ button. <p>Note: To disable the RC Lock function, press the 🏠 button and buttons 1 9 9 8 on the remote control.</p>	Press the ▲/▼ button on the control panel or the ↕ button on the remote control to select the setting.	Unlock Lock All Lock But Volume Lock But Power Lock All Except Volume and Power
Source Detect	<p>Configure how the LCD monitor detects the input source.</p> <ul style="list-style-type: none"> • Status: Set the source detection to On to allow the monitor to detect the input source automatically or to Off to set the source manually. You can also set the source detection to Failover and configure input source priority list (Failover1 ~ Failover7) in case of multiple sources. 		Status Failover1 Failover2 Failover3 Failover4 Failover5 Failover6 Failover7 Off On Failover





ADJUSTING THE LCD DISPLAY

Item	Function	Operation	Range
Source Detect	<ul style="list-style-type: none"> • Failover1~Failover7: If you have set the General Settings > Status to Failover, configure up to 7 failover signal sources in an order from 1 to 7. <p>Note: The OPS option is only applicable for RX-42E and RX-55E models.</p>	<p>a) Press the ▲/▼ button on the control panel or the M button on the remote control to select the setting.</p> <p>b) Press the INPUT button on the control panel or the OK button on the remote control to confirm.</p>	USB HDMI1 HDMI2 DisplayPort OPS DVI-D YPbPr AV VGA
Sleep timer	Switch off the display after a specified time.	Press the ▲/▼ button on the control panel or the M button on the remote control to select the setting.	Off 5 mins 10 mins 15 mins ... 240 mins
Monitor ID	Adjust the ID number for controlling the display via the RS232 connection. Each display must have a unique ID number when multiple sets of this display are connected.	Press the ▲/▼ button on the control panel or the M button on the remote control to adjust the value.	1 to 255
Clock	Set the current date and time for the display's internal clock.		
	<ul style="list-style-type: none"> • Daylight saving: Choose the daylight saving time. 	Press the ▲/▼ button on the control panel or the M button on the remote control to select the setting.	Daylight Saving Time Standard Time
	<ul style="list-style-type: none"> • Date: Set current date. 	<p>a) Press the ▲/▼ button on the control panel or the M button on the remote control to set month, day, and year.</p> <p>b) Press the +/- button on the control panel or the ←/→ button on the remote control to navigate between month, day, and year fields.</p> <p>c) Press the INPUT button on the control panel or the OK button on the remote control to confirm.</p>	Cancel Done





ADJUSTING THE LCD DISPLAY

Item	Function	Operation	Range
Clock	<ul style="list-style-type: none"> • Time: Set current time. 	<p>a) Press the ▲/▼ button on the control panel or the M button on the remote control to set hours and minutes.</p> <p>b) Press the +/- button on the control panel or the ←/→ button on the remote control to navigate between hours and minutes fields.</p> <p>c) Press the INPUT button on the control panel or the OK button on the remote control to confirm.</p>	Cancel Done
Scheduling	<p>This function allows you to program up to 7 different scheduled time intervals for this display to activate.</p> <p>You can set:</p> <ul style="list-style-type: none"> • Which input source the display will use for each scheduled activation period. • The time for the display to turn on and turn off. • The days in a week for the display to activate. <p>Note:</p> <ul style="list-style-type: none"> ◆ We recommend you to set up current date and time in the Clock menu before using this function. ◆ After changing the Clock option in the General settings menu, you need to set this Scheduling again. 		
	<ul style="list-style-type: none"> • Status: Enable or disable the schedule. 	Press the ▲/▼ button on the control panel or the M button on the remote control to select the setting.	Off On
	<ul style="list-style-type: none"> • Source: Choose the source for the schedule. <p>Note: The OPS option is only applicable for RX-42E and RX-55E models.</p>	Press the ▲/▼ button on the control panel or the M button on the remote control to select the setting.	USB HDMI 1 HDMI 2 Display Port OPS DVI-D YPbPr AV VGA

ADJUSTING THE LCD DISPLAY

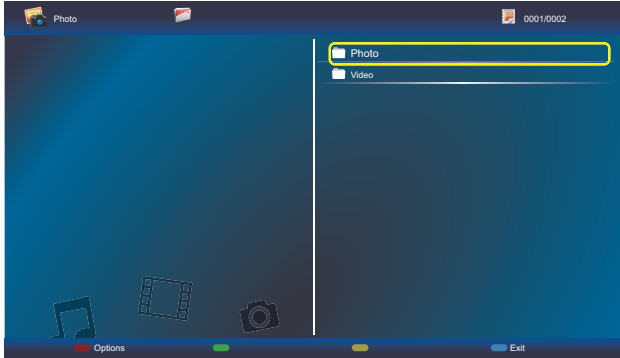
Item	Function	Operation	Range
Scheduling (continued)	<ul style="list-style-type: none"> • On Time: Set time when the schedule is turned on. 	a) Press the ▲/▼ button on the control panel or the  button on the remote control to set hours and minutes. b) Press the +/- button on the control panel or the  button on the remote control to navigate between hours and minutes fields. c) Press the INPUT button on the control panel or the OK button on the remote control to confirm.	Cancel Done
	<ul style="list-style-type: none"> • Off Time: Set time when the schedule is turned off. 	a) Press the ▲/▼ button on the control panel or the  button on the remote control to set hours and minutes. b) Press the +/- button on the control panel or the  button on the remote control to navigate between hours and minutes fields. c) Press the INPUT button on the control panel or the OK button on the remote control to confirm.	Cancel Done
	<ul style="list-style-type: none"> • Repeat: Choose the days in a week when the schedule is activated. 	a) Press the ▲/▼ button on the control panel or the  button on the remote control to set hours and minutes. b) Press the INPUT button on the control panel or the OK button on the remote control to confirm.	Never Every Sunday Every Monday Every Tuesday Every Wednesday Every Thursday Every Friday Every Saturday
	<ul style="list-style-type: none"> • Play setting: Choose the file to be included in the playlist. <p>Note:</p> <ul style="list-style-type: none"> ◆ Each playlist supports up to 30 files. ◆ Playlist will not be cleared after Factory settings. You have to manually remove the files or delete <i>usb_schedulinglist.txt</i> on the USB disk drive. 		

ADJUSTING THE LCD DISPLAY

Item	Function	Operation	Range
Scheduling (continued)	<p>a) Press the ▲/▼ button on the control panel or the M button on the remote control to choose the file.</p> <p>b) Press the INPUT button on the control panel or the OK button on the remote control to set or clear the playlist.</p>	<p style="text-align: center;">Playlist View</p> 	
	<p>a) Press the  button on the remote control, then select Save list to save the playlist.</p> <p>b) Press the  button on the remote control to exit Playlist and return to the OSD menu.</p>	<p style="text-align: center;">Save List</p> 	

ADJUSTING THE LCD DISPLAY

Item	Function	Operation	Range
Cooling Fan	<p>Set the cooling fan operation.</p> <ul style="list-style-type: none"> • Off: Cooling fan is turned off. • On: Cooling fan is turned on all the time during the LCD display is in operation. • Auto: Cooling fan turns on when the LCD display temperature reaches 60°C (140°F). <p>Note:</p> <ul style="list-style-type: none"> ◆ A temperature warning message will appear on the screen when the temperature reaches 70°C (158°F). ◆ Regardless the cooling fan status off or on, the cooling fan is turned on automatically if the temperature reaches 70°C (158°F), for three successive minutes and a temperature-waning message is shown on the screen for 10 seconds. In this situation, the LCD display is shut down and the Power LED indicator will be blinking red and green. ◆ This option is only applicable for RX-42E and RX-55E models. 	<p>Press the ▲/▼ button on the control panel or the M button on the remote control to select the setting.</p>	<p>Off On Auto</p>
RS232 Control Port	<p>Choose the RS232 control from the Card OPS or embedded RS232 in the display.</p> <p>Note: This option is only applicable for RX-42E and RX-55E models.</p>	<p>Press the ▲/▼ button on the control panel or the M button on the remote control to select the setting.</p>	<p>RS232 OPS RS232</p>
Factory settings	<p>Reset all your customized settings to the factory defaults.</p>	<p>Press the +/- button on the control panel or the ←/→ button on the remote control to select the setting.</p>	<p>OK Cancel</p>

ADJUSTING THE LCD DISPLAY

5.5 Network Settings

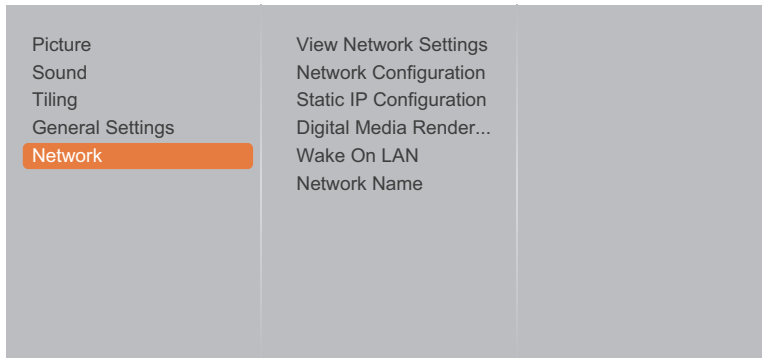





- 1 Press the **MENU** button on the control panel or the **⬆** button on the remote control to call out the OSD window.
- 2 Select **Network**, then press the **INPUT** button on the control panel or the **OK** button on the remote control.
- 3 Press the **▲/▼** button on the control panel or the **⬆/⬆** button on the remote control to select an option.
- 4 Press the **INPUT** button on the control panel or the **OK** button on the remote control to enter the submenu.

Item	Function	Operation	Range
View Network Settings	View connected network status.	Press the INPUT button on the control panel or the OK button on the remote control.	Close
Network Configuration	Choose how the LCD display should assign addresses to the network resources.	a) Press the ▲/▼ button on the control panel or the ⬆/⬆ button on the remote control to select the setting. b) Press the INPUT button on the control panel or the OK button on the remote control to confirm.	DHCP & Auto IP Static IP

ADJUSTING THE LCD DISPLAY





Item	Function	Operation	Range
Static IP Configuration	<p>Configure the network parameters, such as IP address, netmask, gateway, DNS 1, and DNS 2.</p> <p>Note: This function can be only configured when the Network configuration setting is set to Static IP.</p>	<p>a) Press the ▲/▼ button on the control panel or the M button on the remote control to select the item.</p> <p>b) Then press the INPUT button on the control panel or the OK button on the remote control to confirm the selection.</p> <p>c) Press the +/- button on the control panel or the ←/→ button on the remote control if necessary and then use the digit numbers from [0] ~ [9] on the remote control to configure the network parameters.</p> <p>d) When the setting is complete, press the INPUT button on the control panel or the OK button. Press the +/- button on the control panel or the ←/→ button on the remote control to select Done. Then press the INPUT button on the control panel or the OK button on the remote control to save the setting.</p>	<p>IP Address</p> <p>Netmask</p> <p>Gateway</p> <p>DNS 1</p> <p>DNS 2</p>
Digital Media Renderer - DMR	Enable this function to allow the display to receive multimedia files from the connected device from the network.	Press the ▲/▼ button on the control panel or the M button on the remote control to select the setting.	<p>Off</p> <p>On</p>
Wake On LAN	Enable this feature to allow the display to be switched on over the network.	Press the ▲/▼ button on the control panel or the M button on the remote control to select the setting.	<p>Off</p> <p>On</p>

ADJUSTING THE LCD DISPLAY

Item	Function	Operation	Range
Network Name	In the multiple-display connection, you can rename each display for easy identification.	<p>a) Press the INPUT button on the control panel or the OK button on the remote control on the network name field to open the on-screen keyboard.</p> <p>b) Use the on-screen keyboard to enter the name:</p> <p>i) Press the ▲/▼/+/– button on the control panel or the ⏪/⏩ button on the remote control to select the characters on the on-screen keyboard.</p> <p>ii) Press the INPUT button on the control panel or the OK button on the remote control to confirm the selection.</p> <p>Note: While using the on-screen keyboard, press the  button on the remote control to switch the on-screen keyboard keys to lowercase,  button on the remote control to switch the on-screen keyboard keys to uppercase,  button on the remote control to enter symbols, or  button on the remote control to enter backspace.</p> <p>c) When done, select Done and press the INPUT button on the control panel or the OK button on the remote control.</p> <p>d) When the setting is complete, press the +/– button on the control panel or the ⏪/⏩ button on the remote control to select Done. Then press the INPUT button on the control panel or the OK button on the remote control to save the setting.</p>	N/A

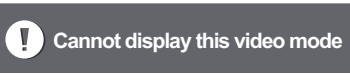
CHAPTER 6: APPENDIX

6.1 Warning Messages

Warning Messages	Cause	Solution
	The resolution or the refresh rate of the graphics card of the computer is set too high.	<ul style="list-style-type: none">• Change the resolution or the refresh rate of the graphics card.
	The LCD display cannot detect the input source signal.	<ul style="list-style-type: none">• Check if the input source is turned On.• Check if the signal cable is properly connected.• Check if any pin inside the cable connector is twisted or broken.
	The operation using the control panel buttons has been locked by the user.	<ul style="list-style-type: none">• Disable the KEY Lock function. See page 69.
	The operation using the remote control buttons has been locked by the user.	<ul style="list-style-type: none">• Disable the RC Lock function. See page 70.

APPENDIX

6.2 USB Device Compatibility

USB Video Subtitle Formats (for language subtitles, etc.).

File Extensions	Container	Video codec	Maximum resolution	Max. Frame Rate (fps)	Max. Bit Rate (Mbps)	Audio codec
.mpg mpeg .vob	PS	MPEG-1	1920x1080	25p,30p,50i,60i	30	MPEG-1(L1&L2), MPEG-1,2,2.5 L3, AAC/HE-AAC(v1&v2), DVD-PCM,AC3
		MPEG-2	1920x1080	25p,30p,50i,60i	30	
		MPEG-4 ASP	1920x1080	25p,30p,50i,60i	30	
		H.264	1920x1080	25p,30p,50p,60p,60i	30	
.ts	TS	MPEG-2	1920x1080	25p,30p,50i,60i	30	MPEG-1(L1&L2), MPEG-1,2,2.5 L3, AAC/HE-AAC (v1&v2), AC3,E-AC3, Dolby Pulse
		MPEG-4 ASP	1920x1080	25p,30p,50i,60i	30	
		H.264	1920x1080	25p,30p,50p,60p,60i	30	
		MVC	1920x1080i@field rate=50, 60Hz 1920x1080p@frame rate=24, 25,30Hz 1280x720p@frame rate=50, 60Hz	-	30	
.ts .m2ts .mts .mt2	MaTS TTS	MPEG-2	1920x1080	25p,30p,50i,60i	30	MPEG-1(L1&L2), MPEG-1,2,2.5 L3, AAC/HE-AAC (v1&v2), AC3,E-AC3, Dolby Pulse
		MPEG-4 ASP	1920x1080	25p,30p,50i,60i	30	
		H.264	1920x1080	25p,30p,50p,60p,60i	30	
		MVC	1920x1080i @ field rate=50, 60Hz 1920x1080p @ frame rate=24, 25,30Hz 1280x720p @ frame rate=50, 60Hz	-	30	
.ts .m2ts .mts	AVCHD	MPEG-2	1920x1080	25p,30p,50i,60i	30	MPEG-1(L1&L2), MPEG-1,2,2.5 L3, AAC/HE-AAC (v1&v2), AC3,E-AC3, Dolby Pulse
		MPEG-4 ASP	1920x1080	25p,30p,50i,60i	30	
		H.264	1920x1080	25p,30p,50p,60p,60i	30	

APPENDIX

File Extensions	Container	Video codec	Maximum resolution	Max. Frame Rate (fps)	Max. Bit Rate (Mbps)	Audio codec
.ts .m2ts .mts	AVCHD	MVC	1920x1080i@field rate=50, 60Hz 1920x1080p@frame rate=24, 25,30Hz 1280x720p @ frame rate=50, 60Hz	-	30	MPEG-1(L1&L2), MPEG-1,2,2.5 L3, AAC/HE-AAC (v1&v2), AC3,E-AC3, Dolby Pulse
.m4v	M4V	H.264	1920x1080	25p,30p,50p,60p,60i	30	AAC
.ism/ Manifest .mpd	frag MP4	H.264	1920x1080	25p,30p,50p,60p,60i	30	AAC/HE- AAC(v1&v2), AC3,E- AC3,WMA, WMA-PRO
		MVC	1920x1080i@field rate=50, 60Hz 1920x1080p@frame rate=24, 25,30Hz 1280x720p @ frame rate=50, 60Hz	-	30	
.mp4	MP4	MPEG-4 ASP	1920x1080	25p,30p,50i,60i	30	AAC/HE- AAC(v1&v2), AC3,E- AC3,WMA, WMA-PRO
		H.264	1920x1080		30	
		MVC	1920x1080i@field rate=50, 60Hz 1920x1080p@frame rate=24, 25,30Hz 1280x720p @ frame rate=50, 60Hz	-	30	
		WMV9/ VC1	1920x1080	30p,60i	30	
.mkv .mk3d	MKV	MPEG-4 ASP	1920x1080	25p,30p,50i,60i	30	MPEG-1(L1&L2), MPEG-1,2,2.5 L3, AAC/HE-AAC (v1&v2), AC3,E-AC3, WMA, WMA-PRO
		H.264	1920x1080		30	

APPENDIX

USB Multimedia Formats

File Extensions	Container	Video codec	Maximum resolution	Frequency (kHz)	Max. Bit Rate (Mbps)	Audio codec
.mp3	MP3	-	-	48	384	MPEG-1,2,2.5 L3
.wma .asf	WMA (V2 up to V9.2)	-	-	48	192	WMA
.wma	WMA Pro	-	-	96	768	WMA,WMA Pro
.wav(PC)	LPCM	-	-	192	768	LPCM
.aif(mac) .aiff(mac)	LPCM	-	-	192	768	LPCM
.aac .mp4 .m4a	AAC	-	-	48	1024	AAC,HE-AAC(v1&v2)
.pls .m3u	Playlists	-	-	-	-	-
.m4a	M4A	-	-	48	1024	AAC,HE-AAC(v1&v2)

Note:

- ◆ Sound or video may not work if the contents have a standard bit rate/frame rate above the compatible Frame/sec listed in the table above.
- ◆ Video content with a Bit rate or Frame rate larger than the rate specified in the table above can cause choppy video during playback.

APPENDIX

6.3 Supported Resolution

VGA Resolution:

Standard Resolution	Active Resolution		Refresh Rate	Pixel Rate	Aspect Ratio	Stand for Mode
	H Pixels	V Lines				
VGA	640	480	60 Hz	25.175 MHz	4:3	Video Graphic Array
			72 Hz	31.5 MHz		
			75 Hz	31.5 MHz		
WVGA	720	400	70 Hz	33.75 MHz	16:9	Wide Video Graphic Array
SVGA	800	600	60 Hz	40 MHz	4:3	Super VGA
			75 Hz	49.5 MHz		
XGA	1024	768	60 Hz	65 MHz	4:3	Extended Graphic Array
			75 Hz	78.75 MHz		
WXGA	1280	768	60 Hz	79.5 MHz	5:3	Wide XGA
WXGA	1280	800	60 Hz	79.5 MHz	16:10	Wide XGA
SXGA	1280	960	60 Hz	108 MHz	4:3	Super XGA
SXGA	1280	1024	60 Hz	108 MHz	5:4	Super XGA
WXGA	1360	768	60 Hz	85.5 MHz	16:9	Wide XGA
WXGA	1366	768	60 Hz	85.5 MHz	16:9	Wide XGA
UXGA	1600	1200	60 Hz	162 MHz	4:3	Ultra XGA
HD1080	1920	1080	60 Hz	148.5 MHz	16:9	HD1080

SDTV Resolution:

Standard Resolution	Active Resolution		Refresh Rate	Pixel Rate	Aspect Ratio	Stand for Mode
	H Pixels	V Lines				
480i	720	480	29.97 Hz	13.5 MHz	4:3	Modified NTSC Standard
480p			59.94 Hz	27 MHz		
576i	720	576	25 Hz	13.5 MHz	4:3	Modified PAL Standard
576p			50 Hz	27 MHz		

HDTV Resolution:

Standard Resolution	Active Resolution		Refresh Rate	Pixel Rate	Aspect Ratio	Stand for Mode
	H Pixels	V Lines				
720p	1280	720	50 Hz	74.25 MHz	16:9	Normally DVB Mode
			60 Hz			
1080i	1920	1080	25 Hz	74.25 MHz	16:9	Normally ATSC Mode
			30 Hz			
1080p	1920	1080	50 Hz	148.5 MHz	16:9	Normally ATSC Mode
			60 Hz			

APPENDIX

General guidelines:

- The PC text quality is optimum in HD 1080 mode (1920 x 1080, 60Hz).
- Your PC display screen might appear different depending on the manufacturer (and your particular version of Windows).
- Check your PC instruction book for information about connecting your PC to a display.
- If a vertical and horizontal frequency-select mode exists, select 60Hz (vertical) and 31.5KHz (horizontal). In some cases, abnormal signals (such as stripes) might appear on the screen when the PC power is turned off (or if the PC is disconnected). If so, press the [INPUT] button to enter the video mode. Also, make sure that the PC is connected.
- When horizontal synchronous signals seem irregular in RGB mode, check PC power saving mode or cable connections.
- The display settings table complies to the IBM/VESA standards, and based on the analogue input.
- The DVI support mode is regarded as same to the PC support mode.
- The best timing for the vertical frequency to each mode is 60Hz.

6.4 Cleaning

Caution When Using the Display

- Do not bring your hands, face or objects close to the ventilation holes of the display. The top of the display is usually very hot due to the high temperature of exhaust air being released through the ventilation holes. Burns or personal injuries may occur if any body parts are brought too close. Placing any object near the top of the display could also result in heat related damage to the object as well as the display itself.
- Be sure to disconnect all cables before moving the display. Moving the display with its cables attached may damage the cables and thus cause fire or electric shock.
- Disconnect the power plug from the wall outlet as a safety precaution before carrying out any type of cleaning or maintenance procedure.

Front Panel Cleaning Instructions



- The front of the display has been specially treated. Wipe the surface gently using only a cleaning cloth or a soft, lint-free cloth.
- If the surface becomes dirty, soak a soft, lint-free cloth in a mild detergent solution. Wring the cloth to remove excess liquid. Wipe the surface of the display to remove dirt. Then use a dry cloth of the same type to dry.
- Do not scratch or hit the surface of the panel with fingers or hard objects of any kind.
- Do not use volatile substances such as insert sprays, solvents and thinners.

Cabinet Cleaning Instructions

- If the cabinet becomes dirty, wipe the cabinet with a soft, dry cloth.
- If the cabinet is extremely dirty, soak a lint-free cloth in a mild detergent solution. Wring the cloth to remove as much moisture as possible. Wipe the cabinet. Use another dry cloth to wipe over until the surface is dry.
- Do not allow any water or detergent to come into contact with the surface of the display. If water or moisture gets inside the unit, operating problems, electrical and shock hazards may result.
- Do not scratch or hit the cabinet with fingers or hard objects of any kind.
- Do not use volatile substances such as insert sprays, solvents and thinners on the cabinet.
- Do not place anything made from rubber or PVC near the cabinet for any extended periods of time.

APPENDIX

6.5 Troubleshooting

Symptom	Possible Cause	Remedy
No picture is displayed	<ul style="list-style-type: none"> The main power switch on the back of the display is not switched on. The selected input has no connection. The display is in standby mode. 	<ol style="list-style-type: none"> 1 Plug in the power cord. 2 Make sure the power switch is switched on. 3 Connect a signal connection to the display.
Interference displayed on the display or audible noise is heard	Caused by surrounding electrical appliances or fluorescent lights.	Move the display to another location to see if the interference is reduced.
Color is abnormal	The signal cable is not connected properly.	Make sure that the signal cable is attached firmly to the back of the display.
Picture is distorted with abnormal patterns	<ul style="list-style-type: none"> The signal cable is not connected properly. The input signal is beyond the capabilities of the display. 	<ul style="list-style-type: none"> Make sure that the signal cable is attached firmly. Check the video signal source to see if it is beyond the range of the display. Please verify its specifications with this display's specification section.
Display image doesn't fill up the full size of the screen	The picture format is not set correctly.	Press the  button and select Wide Screen .
Can hear sound, but no picture	Improperly connected source signal cable.	Make sure that both video inputs and sound inputs are correctly connected.
Can see picture but no sound is heard	<ul style="list-style-type: none"> Improperly connected source signal cable. Volume is turned all the way down. MUTE function is turned on. No external speaker connected. 	<ul style="list-style-type: none"> Make sure that both video and sound inputs are correctly connected. Press the + or - button to hear the sound. Switch the MUTE function off by using the  button. Connect the external speakers and adjust the volume to a suitable level.
Some picture elements do not light up	Some pixels of the display may not turn on.	This display is manufactured using an extremely high level of precision technology; however, sometimes some pixels of the display may not display. This is not a malfunction.
After-Images can still be seen on the display after the display is powered off. (Examples of still pictures include logos, video games, computer images, and images displayed in 4:3 normal mode)	A still picture is displayed for an over extended period of time.	Do not allow a still image to be displayed for an extended period of time as this can cause a permanent after-image to remain on the display.

APPENDIX

6.6 Transporting the LCD Display

To transport the LCD display for repair or shipment, place the display in its original packaging carton.

RX-32E

- 1 Place the LCD display inside the supplied protective bag.
- 2 Place the lower foam cushion inside the box (a).
- 3 Place the LCD display down in the box (b).
- 4 Place the upper foam cushion on the top of the LCD display (c).
- 5 Place the accessories on the designated area (if necessary).
- 6 Close and tape the box.

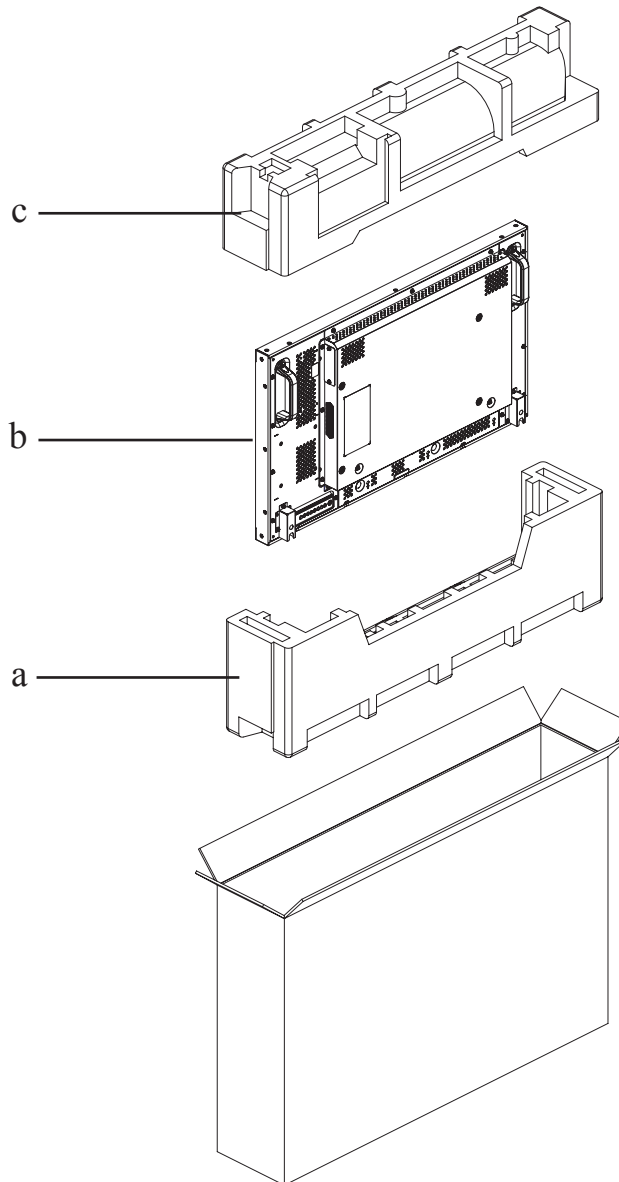

APPENDIX

RX-42E

- 1 Place the LCD display inside the supplied protective bag.
- 2 Place the lower foam cushions inside the box (a).
- 3 Place the LCD display down in the box (b).
- 4 Place the upper foam cushions on the top of the LCD display (c).
- 5 Place the accessories on the designated area (if necessary).
- 6 Close and tape the box.

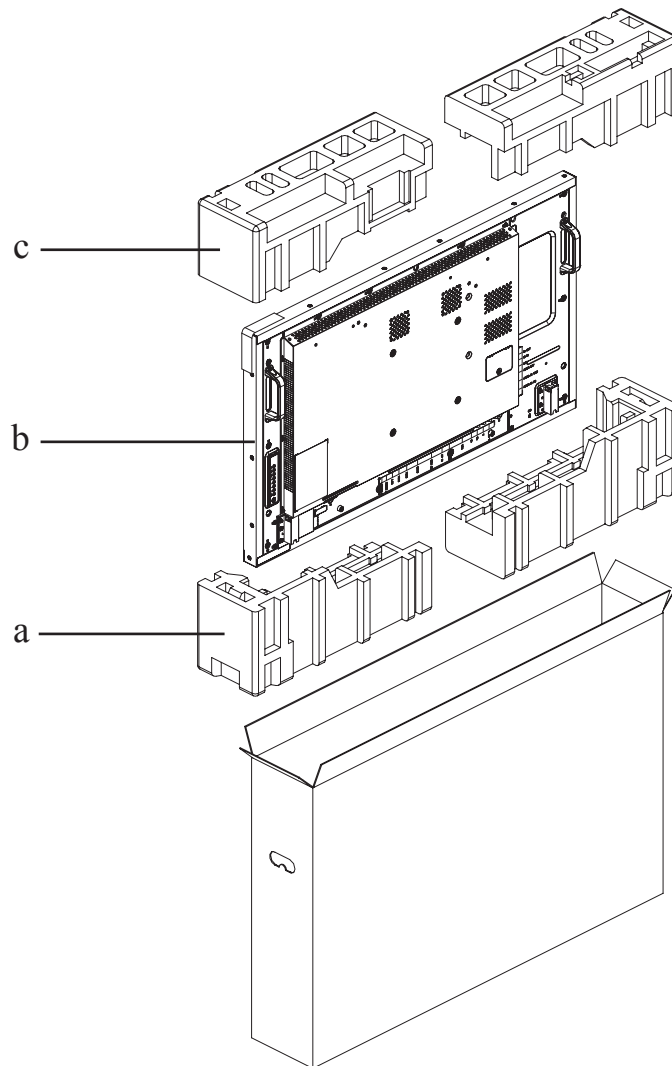

APPENDIX

RX-55E

- 1 Place the LCD display inside the supplied protective bag.
- 2 Place the lower foam cushion inside the lower box (a).
- 3 Place the LCD display down in the lower box (b).
- 4 Place the upper foam cushion on the top of the LCD display (c).
- 5 Place the accessories on the designated area (if necessary).
- 6 Place the upper box on the LCD display.
- 7 Secure the upper box to the lower box with the supplied locks (d).

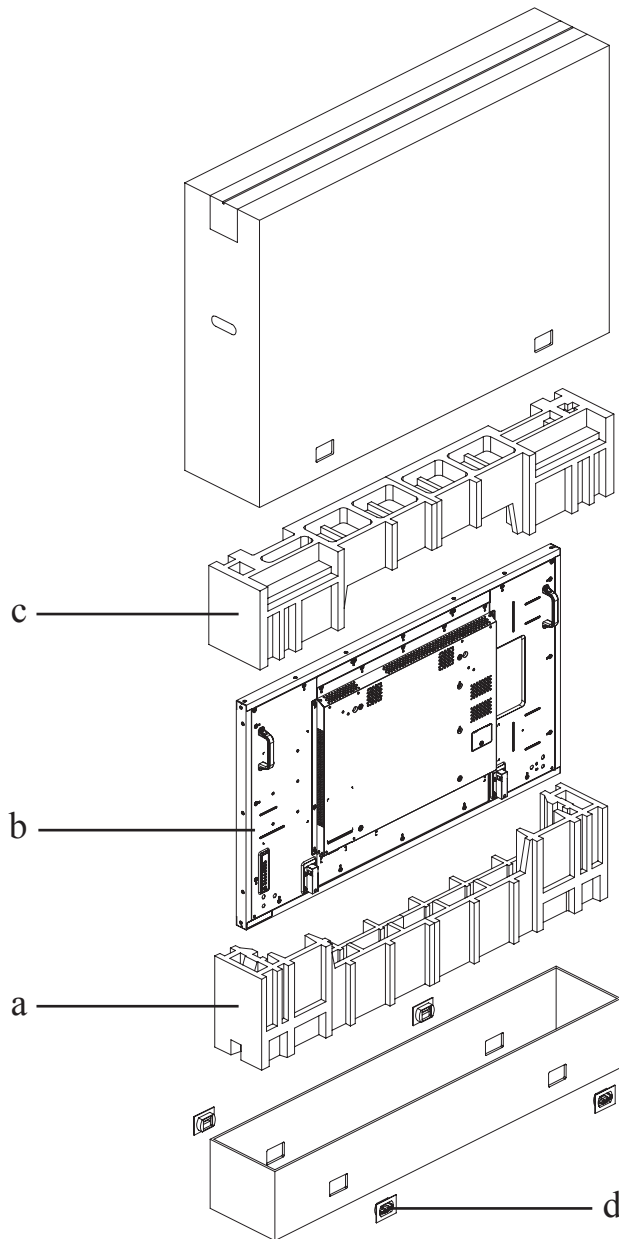

CHAPTER 7: SPECIFICATIONS

7.1 Display Specifications

		RX-32E	RX-42E	RX-55E
Panel	Panel Type	LED-Backlit TFT LCD (VA Technology)	LED-Backlit TFT LCD (IPS Technology)	LED-Backlit TFT LCD (IPS Technology)
	Panel Size	31.5"	41.9"	54.6"
	Max. Resolution	FHD 1920 x 1080	FHD 1920 x 1080	FHD 1920 x 1080
	Pixel Pitch	0.364 mm	0.483 mm	0.630 mm
	Brightness	500 cd/m ²	700 cd/m ²	700 cd/m ²
	Contrast Ratio	3000:1	1300:1	1300:1
	Viewing Angle (H/V)	178°/178°	178°/178°	178°/178°
	Display Colour	16.7M	1.07B	1.07B
	Response Time	5 ms	5 ms	5 ms
Frequency (H/V)	H Freq.	31 kHz-92 kHz	31 kHz-92 kHz	31 kHz-92 kHz
	V Freq.	48 Hz-85 Hz	48 Hz-85 Hz	48 Hz-85 Hz
Input	DisplayPort	1.2 x 1	1.2 x 1	1.2 x 1
	HDMI	1.4 x 2	1.4 x 2	1.4 x 2
	DVI	24-Pin DVI-D	24-Pin DVI-D	24-Pin DVI-D
	VGA	15-Pin D-Sub x 1	15-Pin D-Sub x 1	15-Pin D-Sub x 1
	Component	BNC x 1	BNC x 1	BNC x 1
	Composite	BNC x 1 (Share with Component-Y)	BNC x 1 (Share with Component-Y)	BNC x 1 (Share with Component-Y)
Output	DisplayPort	1.2 x 1	1.2 x 1	1.2 x 1
	DVI	29-Pin DVI-I x 1 (VGA/HDMI)	29-Pin DVI-I x 1 (VGA/HDMI)	29-Pin DVI-I x 1 (VGA/HDMI)
	Composite	BNC x 1	BNC x 1	BNC x 1
External Control	IR In/Out	3.5 mm Phone Jack	3.5 mm Phone Jack	3.5 mm Phone Jack
	RS232 In/Out	2.5 mm Phone Jack	2.5 mm Phone Jack	2.5 mm Phone Jack
	LAN (RJ45)	Yes	Yes	Yes
Other Connectivity	USB	2.0 x 1 (Service Port / Media Playback)	2.0 x 1 (Service Port / Media Playback)	2.0 x 1 (Service Port / Media Playback)
	OPS Slot	-	Yes	Yes
Audio	Audio In	Stereo Audio Jack (3.5 mm) x 1 Stereo Audio Jack (RCA) x 1	Stereo Audio Jack (3.5 mm) x 1 Stereo Audio Jack (RCA) x 1	Stereo Audio Jack (3.5 mm) x 1 Stereo Audio Jack (RCA) x 1
	Audio Out	Stereo Audio Jack (3.5 mm) x 1	Stereo Audio Jack (3.5 mm) x 1	Stereo Audio Jack (3.5 mm) x 1
	Internal Speakers	10W x 2	10W x 2	10W x 2
Power	Power Supply	Internal	Internal	Internal
	Power Requirements	AC 100-240V, 50/60 Hz	AC 100-240V, 50/60 Hz	AC 100-240V, 50/60 Hz
	On Mode	65W (On)	94W (On)	140W (On)
	Stand-by Mode	< 0.5W	< 0.5W	< 0.5W
	Off Mode	< 0.5W	< 0.5W	< 0.5W
Glass	Thickness	4.0 mm (0.16")	4.0 mm (0.16")	4.0 mm (0.16")
	Reflection Rate	< 1%	< 1%	< 1%
	Transmission Rate	> 97%	> 97%	> 97%
	Hardness	> 9H	> 9H	> 9H
Operating Conditions	Temperature	0°C-40°C (32°F-104°F)	0°C-40°C (32°F-104°F)	0°C-40°C (32°F-104°F)
	Humidity	20%-80% (non-condensing)	20%-80% (non-condensing)	20%-80% (non-condensing)
Storage Conditions	Temperature	-20°C-60°C (-4°F-140°F)	-20°C-60°C (-4°F-140°F)	-20°C-60°C (-4°F-140°F)
	Humidity	5%-90% (non-condensing)	5%-90% (non-condensing)	5%-90% (non-condensing)
Mounting	VESA FPM PMI	Yes (400 x 200 mm)	Yes (200 x 200 mm)	Yes (400 x 400 mm)
Security	Kensington Security Slot	Yes	Yes	Yes
Dimensions	Product w/o Base (W x H x D)	757.6 x 452.0 x 75.1 mm (29.8" x 17.8" x 3.0")	987.2 x 581.2 x 83.0 mm (38.9" x 22.9" x 3.3")	1268.8 x 739.6 x 83.0 mm (50.0" x 29.1" x 3.3")
	Packaging (W x H x D)	892.0 x 600.0 x 185.0 mm (35.1" x 23.6" x 7.3")	1161.0 x 759.0 x 203.0 mm (45.7" x 29.9" x 8.0")	1475.0 x 936.0 x 223.0 mm (58.1" x 36.9" x 8.8")

SPECIFICATIONS

		RX-32E	RX-42E	RX-55E
Weight	Product w/o Base	15.0 kg (33.1 lb)	23.1 kg (50.9 lb)	37.0 kg (81.6 lb)
	Packaging	17.6 kg (38.8 lb)	27.1 kg (59.7 lb)	43.7 kg (96.3 lb)

Note:

- ◆ All specifications are subject to change without prior notice.

SPECIFICATIONS

7.2 Display Dimensions

RX-32E

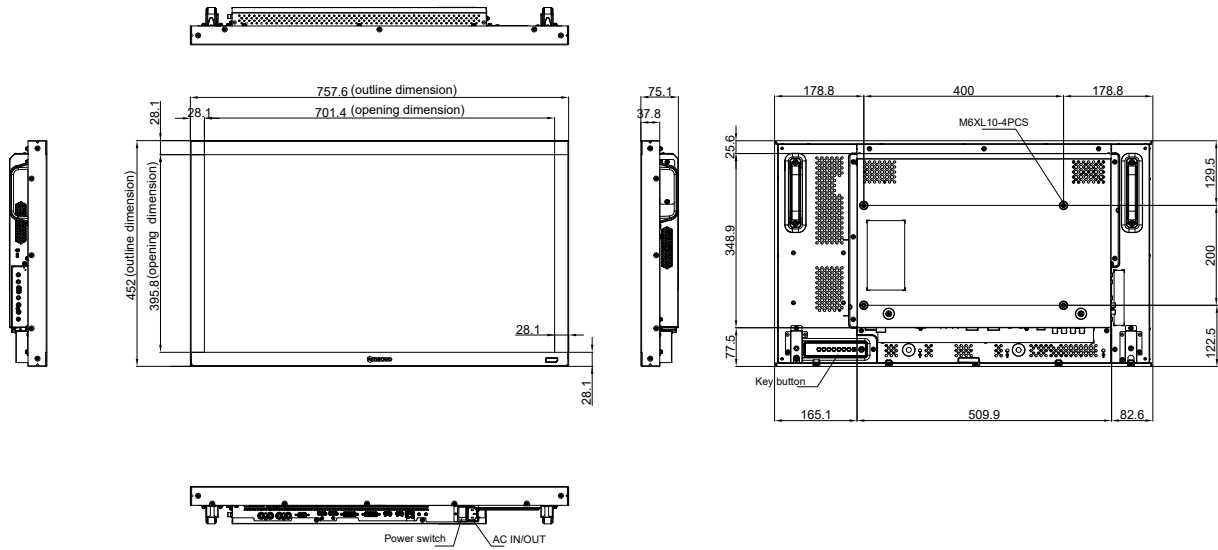

RX-42E

