

Dell EMC PowerEdge R740

Installation and Service Manual

Notes, cautions, and warnings

 **NOTE:** A NOTE indicates important information that helps you make better use of your product.

 **CAUTION:** A CAUTION indicates either potential damage to hardware or loss of data and tells you how to avoid the problem.

 **WARNING:** A WARNING indicates a potential for property damage, personal injury, or death.

© 2018 Dell Inc. or its subsidiaries. All rights reserved. Dell, EMC, and other trademarks are trademarks of Dell Inc. or its subsidiaries. Other trademarks may be trademarks of their respective owners.

Contents

1 PowerEdge R740 system overview.....	8
Supported configurations.....	8
Front view of the system.....	10
Left control panel view.....	12
Right control panel view.....	15
Back view of the system.....	16
NIC indicator codes.....	18
Power supply unit indicator codes.....	18
Drive indicator codes.....	21
LCD panel.....	22
Viewing Home screen.....	23
Setup menu.....	23
View menu.....	23
Locating the Service Tag of your system.....	24
System information label.....	24
PowerEdge R740 – Front system information label.....	24
PowerEdge R740 – Service information.....	26
2 Documentation resources.....	29
3 Technical specifications.....	31
System dimensions.....	31
Chassis weight.....	32
Processor specifications.....	33
Supported operating systems.....	33
PSU specifications.....	33
System battery specifications.....	34
Expansion bus specifications.....	34
Memory specifications.....	36
Storage controller specifications.....	36
Drive specifications.....	37
Drives.....	37
Optical drive.....	37
Ports and connectors specifications.....	37
USB ports.....	37
NIC ports.....	37
VGA ports.....	38
Serial connector.....	38
Internal Dual SD Module or vFlash card.....	38
Video specifications.....	38
Environmental specifications.....	39
Standard operating temperature.....	40

Expanded operating temperature.....	40
Particulate and gaseous contamination specifications.....	42
4 Initial system setup and configuration.....	43
Setting up your system.....	43
iDRAC configuration.....	43
Options to set up iDRAC IP address.....	43
Log in to iDRAC.....	44
Options to install the operating system.....	44
Methods to download firmware and drivers.....	44
Downloading drivers and firmware.....	45
5 Pre-operating system management applications.....	46
Options to manage the pre-operating system applications.....	46
System Setup.....	46
Viewing System Setup.....	46
System Setup details.....	47
System BIOS.....	47
iDRAC Settings utility.....	66
Device Settings.....	67
Dell Lifecycle Controller.....	67
Embedded system management.....	67
Boot Manager.....	67
Viewing Boot Manager.....	67
Boot Manager main menu.....	68
One-shot UEFI boot menu.....	68
System Utilities.....	68
PXE boot.....	68
6 Installing and removing system components.....	69
Safety instructions.....	69
Before working inside your system.....	69
After working inside your system.....	69
Recommended tools.....	70
Optional front bezel.....	70
Front bezel details.....	70
Removing the front bezel.....	70
Installing the front bezel.....	71
System cover.....	72
Removing the system cover.....	72
Installing the system cover.....	73
Backplane cover.....	74
Removing the backplane cover.....	74
Installing the backplane cover.....	75
Inside the system.....	76
Air shroud.....	78

Removing the air shroud.....	78
Installing the air shroud.....	79
Cooling fan assembly.....	80
Removing the cooling fan assembly.....	80
Installing the cooling fan assembly.....	81
Cooling fans.....	82
Cooling fan details.....	82
Removing a cooling fan.....	83
Installing a cooling fan.....	83
Intrusion switch.....	84
Removing an intrusion switch.....	84
Installing an intrusion switch.....	85
NVDIMM-N battery.....	86
NVDIMM-N battery details.....	86
Removing the NVDIMM-N battery from the air shroud.....	86
Installing NVDIMM-N battery into air shroud.....	87
Removing NVDIMM-N battery from mid drive tray.....	88
Installing NVDIMM-N battery into mid drive tray.....	89
Removing NVDIMM-N battery from the bracket.....	90
Installing NVDIMM-N battery into the bracket.....	91
Drives.....	92
Drive guidelines.....	92
Removing a drive blank.....	92
Installing a drive blank.....	93
Removing a drive carrier.....	93
Installing a drive carrier.....	94
Removing a 2.5 inch drive from the 3.5 inch drive adapter.....	95
Installing a 2.5 inch drive into the 3.5 inch drive adapter.....	96
Removing a 3.5 inch adapter from a 3.5 inch drive carrier.....	97
Installing a 3.5 inch adapter into a 3.5 inch drive carrier.....	98
Removing the drive from the drive carrier.....	99
Installing a drive into the drive carrier.....	100
System memory.....	101
System memory guidelines.....	101
General memory module installation guidelines.....	103
NVDIMM-N memory module installation guidelines	104
Mode-specific guidelines.....	105
Removing a memory module.....	108
Installing a memory module.....	109
Processors and heat sinks.....	109
Removing a processor and heat sink module.....	109
Removing the processor from the processor and heat sink module.....	110
Installing the processor into a processor and heat sink module.....	112
Installing a processor and heat sink module.....	114
Expansion cards and expansion card risers.....	115

Expansion card installation guidelines.....	115
Opening and closing the PCIe card holder latch.....	119
Removing expansion card from the expansion card riser.....	120
Installing expansion card into the expansion card riser.....	123
Removing riser 2 and 3 blank.....	125
Installing riser 2 and 3 blank.....	126
Removing riser 3 blank.....	127
Installing riser 3 blank.....	128
Removing expansion card riser 1.....	129
Installing expansion card riser 1.....	130
Removing expansion card riser 2.....	131
Installing expansion card riser 2.....	132
Removing expansion card riser 3.....	134
Installing expansion card riser 3.....	134
GPU card installation guidelines.....	135
Removing a GPU.....	136
Installing a GPU.....	138
M.2 SSD module.....	144
Removing the M.2 SSD module.....	144
Installing the M.2 SSD module.....	145
Optional IDSDM or vFlash module.....	146
Removing the MicroSD card.....	146
Installing the MicroSD card.....	147
Removing the optional IDSDM or vFlash card.....	147
Installing optional IDSDM or vFlash card.....	148
Network daughter card.....	149
Removing the network daughter card.....	149
Installing the network daughter card.....	150
Integrated storage controller card.....	151
Removing integrated storage controller card.....	151
Installing integrated storage controller card.....	152
Backplane.....	154
Backplane details.....	154
Removing the backplane.....	155
Installing the backplane	156
Cable routing.....	157
System battery.....	163
Replacing the system battery.....	163
USB 3.0 module.....	164
USB 3.0 module details.....	164
Removing USB 3.0 module.....	165
Installing USB 3.0 module.....	165
Optional internal USB memory key.....	166
Optional internal USB memory key details.....	166
Replacing the optional internal USB memory key.....	167

Optional optical drive.....	167
Removing the optional optical drive.....	167
Installing the optional optical drive.....	168
Power supply units.....	169
Power supply unit details.....	169
Hot spare feature.....	170
Removing a power supply unit blank.....	170
Installing a power supply unit blank.....	171
Removing a power supply unit.....	171
Installing a power supply unit.....	172
Wiring instructions for a DC power supply unit.....	173
System board.....	175
Removing system board.....	175
Installing system board.....	176
Trusted Platform Module.....	178
Upgrading the Trusted Platform Module.....	179
Initializing TPM for BitLocker users.....	180
Initializing the TPM 1.2 for TXT users.....	180
Initializing the TPM 2.0 for TXT users.....	180
Control panel.....	181
Control panel details.....	181
Removing the left control panel.....	181
Installing the left control panel.....	182
Removing the right control panel.....	183
Installing the right control panel.....	184
7 Using system diagnostics.....	186
Dell Embedded System Diagnostics.....	186
Running the Embedded System Diagnostics from Boot Manager.....	186
Running the Embedded System Diagnostics from the Dell Lifecycle Controller.....	186
System diagnostic controls.....	187
8 Jumpers and connectors	188
System board jumpers and connectors.....	189
System board jumper settings.....	191
Disabling forgotten password.....	191
9 Getting help.....	192
Contacting Dell EMC.....	192
Documentation feedback.....	192
Accessing system information by using QRL.....	192
Quick Resource Locator for PowerEdge R740 and R740xd systems.....	193
Receiving automated support with SupportAssist	193
Recycling or End-of-Life service information.....	193

PowerEdge R740 system overview

The PowerEdge R740 is a 2U rack server that supports up to:

- Two Intel Xeon Scalable Processors
- 24 DIMM slots
- Two AC or DC power supply units
- 16 SAS, SATA, Nearline SAS hard drives or SSDs. For more information about supported drives, see the [Technical specifications](#) section.

NOTE: All instances of SAS, SATA hard drives, NVMe and SSDs are referred to as drives in this document, unless specified otherwise.

Topics:

- [Supported configurations](#)
- [Front view of the system](#)
- [Back view of the system](#)
- [Drive indicator codes](#)
- [LCD panel](#)
- [Locating the Service Tag of your system](#)
- [System information label](#)

Supported configurations

The PowerEdge R740 system supports the following configurations:

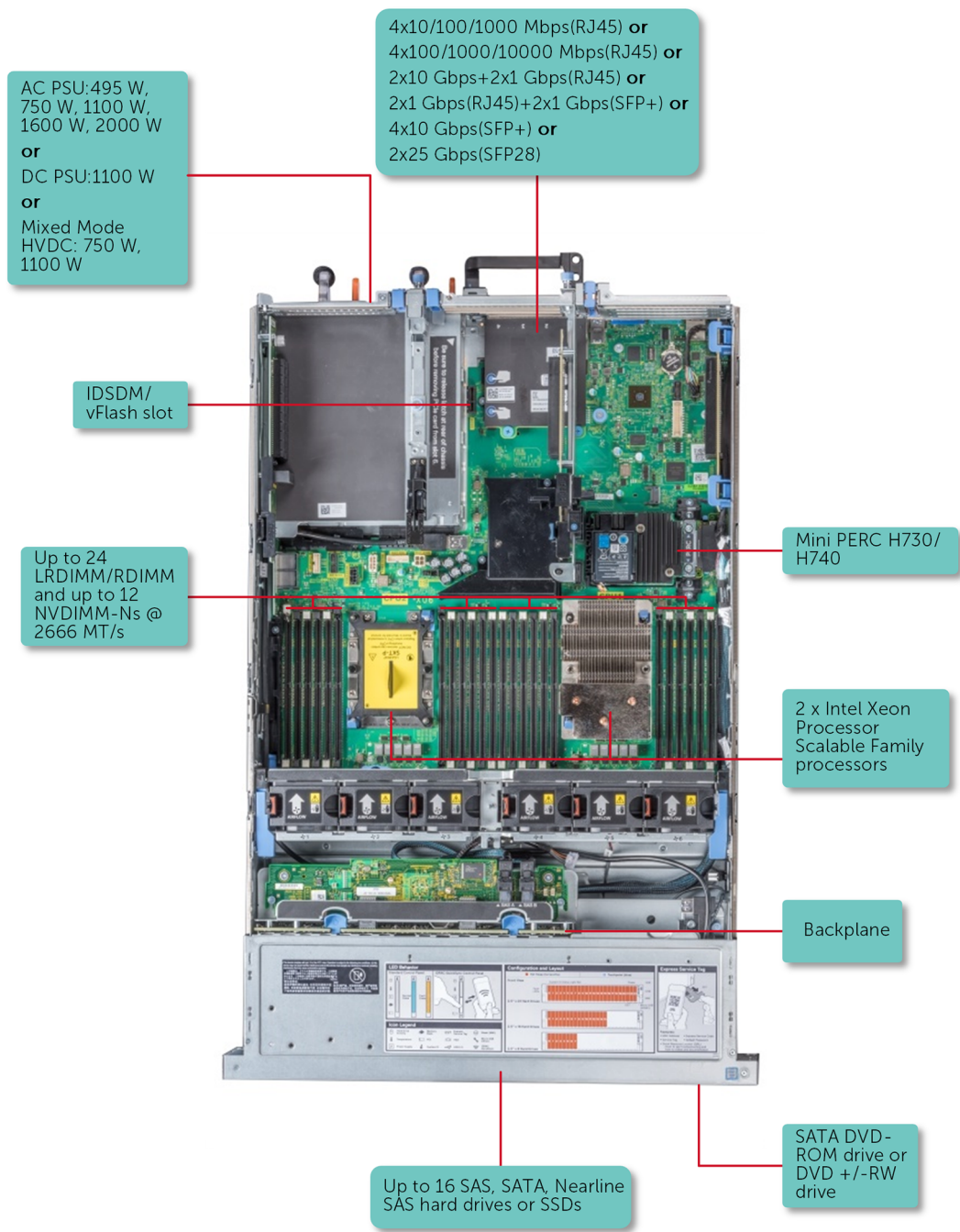

Figure 1. Supported configurations

Front view of the system

The front view displays the features available on the front of the system.



Figure 2. Front view of 16 x 2.5 inch drive system

Table 1. Features available on the front of 16 x 2.5 inch drive system

Item	Ports, panels and slots	Icon	Description
1	Left control panel	N/A	Contains system health and system ID, status LED and optional iDRAC Quick Sync 2 (wireless).
2	Drive slots	N/A	Enable you to install drives that are supported on your system. For more information about drives, see Technical specifications section.
3	Optical drive (optional)	N/A	Enables you to retrieve and store data on optical discs such as compact discs (CD) and digital versatile discs (DVD). For more information, see Technical specifications section.
4	USB 3.0 port (optional)		The USB ports are 9-pin, 3.0-compliant. These ports enable you to connect USB devices to the system.
5	Right control panel	N/A	Contains the power button, VGA port, iDRAC Direct micro USB port, and two USB 2.0 ports.
6	Information tag	N/A	The Information Tag is a slide-out label panel that contains system information such as Service Tag, NIC, MAC address, and so on. If you have opted for the secure default access to iDRAC, the Information tag also contains the iDRAC secure default password.

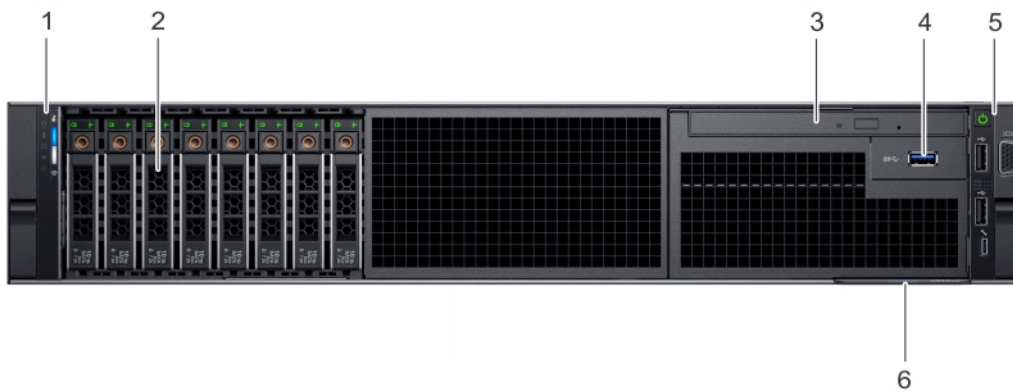



Figure 3. Front view of 8 x 2.5-inch drive system

Table 2. Features available on the front of 8 x 2.5-inch drive system

Item	Ports, panels and slots	Icon	Description
1	Left control panel	N/A	Contains system health and system ID, status LED and optional iDRAC Quick Sync 2 (wireless).
2	Drive slots	N/A	Enable you to install drives that are supported on your system. For more information about drives, see Technical specifications section.
3	Optical drive (optional)	N/A	Enables you to retrieve and store data on optical discs such as compact discs (CD) and digital versatile discs (DVD). For more information, see Technical specifications section.
4	USB 3.0 port (optional)		The USB ports are 9-pin, 3.0-compliant. These ports enable you to connect USB devices to the system.
5	Right control panel	N/A	Contains the power button, VGA port, iDRAC Direct micro USB port, and two USB 2.0 ports.
6	Information tag	N/A	The Information Tag is a slide-out label panel that contains system information such as Service Tag, NIC, MAC address, and so on. If you have opted for the secure default access to iDRAC, the Information tag also contains the iDRAC secure default password.

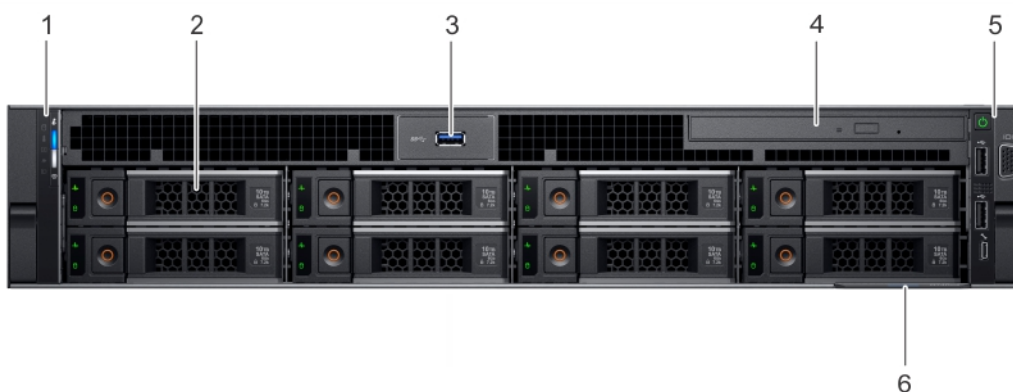



Figure 4. Front view of 8 x 3.5 inch drive system

Table 3. Features available on the front of 8 x 3.5 inch drive system

Item	Ports, panels and slots	Icon	Description
1	Left control panel	N/A	Contains system health and system ID, status LED and optional iDRAC Quick Sync 2 (wireless).
2	Drive slots	N/A	Enable you to install drives that are supported on your system. For more information about drives, see Technical specifications section.
3	USB 3.0 port (optional)		The USB ports are 9-pin, 3.0-compliant. These ports enable you to connect USB devices to the system.
4	Optical drive (optional)	N/A	Enables you to retrieve and store data on optical discs such as compact discs (CD) and digital versatile discs (DVD). For more information, see Technical specifications section.
5	Right control panel	N/A	Contains the power button, VGA port, iDRAC Direct micro USB port, and two USB 2.0 ports.
6	Information tag	N/A	The Information Tag is a slide-out label panel that contains system information such as Service Tag, NIC, MAC address, and so on. If you have opted for the secure default access to iDRAC, the Information tag also contains the iDRAC secure default password.

Left control panel view

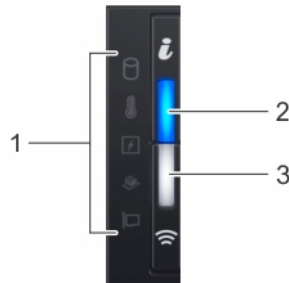



Figure 5. Left control panel with optional iDRAC Quick Sync 2.0 indicator

Table 4. Left control panel

Item	Indicator, button, or connector	Icon	Description
1	Status LED indicators	N/A	Indicate the status of the system. For more information, see the Status LED indicators section.
2	System health and system ID indicator		Indicates the system health. For more information, see the System health and system ID indicator codes section.
3	iDRAC Quick Sync 2 wireless indicator (optional)		Indicates if the iDRAC Quick Sync 2 wireless option is activated. The Quick Sync 2 feature allows management of the system using mobile devices. This feature aggregates hardware/firmware inventory and various system level diagnostic/error information that can be used in troubleshooting the system. You can access system inventory, Dell Lifecycle Controller logs or system logs, system health status, and





Item	Indicator, button, or connector	Icon	Description
------	---------------------------------	------	-------------

also configure iDRAC, BIOS, and networking parameters. You can also launch the virtual Keyboard, Video, and Mouse (KVM) viewer and virtual Kernel based Virtual Machine (KVM), on a supported mobile device. For more information, see the Integrated Dell Remote Access Controller User's Guide at Dell.com/poweredgemanuals.

Status LED indicators

NOTE: The indicators display solid amber if any error occurs.

Table 5. Status LED indicators and descriptions

Icon	Description	Condition	Corrective action
	Drive indicator	The indicator turns solid amber if there is a drive error.	<ul style="list-style-type: none"> Check the System Event Log to determine if the drive has an error. Run the appropriate Online Diagnostics test. Restart the system and run embedded diagnostics (ePSA). If the drives are configured in a RAID array, restart the system, and enter the host adapter configuration utility program.
	Temperature indicator	The indicator turns solid amber if the system experiences a thermal error (for example, the ambient temperature is out of range or there is a fan failure).	<p>Ensure that none of the following conditions exist:</p> <ul style="list-style-type: none"> A cooling fan has been removed or has failed. System cover, air shroud, memory module blank, or back filler bracket is removed. Ambient temperature is too high. External airflow is obstructed. <p>If the problem persists, see Getting help.</p>
	Electrical indicator	The indicator turns solid amber if the system experiences an electrical error (for example, voltage out of range, or a failed power supply unit (PSU) or voltage regulator).	<p>Check the System Event Log or system messages for the specific issue. If it is due to a problem with the PSU, check the LED on the PSU. Reseat the PSU.</p> <p>If the problem persists, see Getting help.</p>
	Memory indicator	The indicator turns solid amber if a memory error occurs.	<p>Check the System Event Log or system messages for the location of the failed memory. Reseat the memory module.</p> <p>If the problem persists, see Getting help.</p>
	PCIe indicator	The indicator turns solid amber if a PCIe card experiences an error.	<p>Restart the system. Update any required drivers for the PCIe card. Reinstall the card.</p> <p>If the problem persists, see Getting help.</p> <p>NOTE: For more information about the supported PCIe cards, see Expansion card installation guidelines.</p>

System health and system ID indicator codes

The system health and system ID indicator is located on the left control panel of your system.



Figure 6. System health and system ID indicators

Table 6. System health and system ID indicator codes

System health and system ID indicator code	Condition
Solid blue	Indicates that the system is turned on, system is healthy, and system ID mode is not active. Press the system health and system ID button to switch to system ID mode.
Blinking blue	Indicates that the system ID mode is active. Press the system health and system ID button to switch to system health mode.
Solid amber	Indicates that the system is in fail-safe mode. If the problem persists, see the Getting help section.
Blinking amber	Indicates that the system is experiencing a fault. Check the System Event Log or the LCD panel, if available on the bezel, for specific error messages. For more information about error messages, see the <i>Event and Error Message Reference Guide for 14th Generation Dell EMC PowerEdge Servers</i> at Dell.com/qrl .

iDRAC Quick Sync 2 indicator codes

iDRAC Quick Sync 2 module (optional) is located on the left control panel of your system.



Figure 7. iDRAC Quick Sync 2 indicators

Table 7. iDRAC Quick Sync 2 indicators and descriptions

iDRAC Quick Sync 2 indicator code	Condition	Corrective action
Off (default state)	Indicates that the iDRAC Quick Sync 2 feature is turned off. Press the iDRAC Quick	If the LED fails to turn on, reseal the left control panel flex cable and check. If the problem persists, see Getting help .

iDRAC Quick Sync 2 indicator code	Condition	Corrective action
	Sync 2 button to turn on the iDRAC Quick Sync 2 feature.	
Solid white	Indicates that iDRAC Quick Sync 2 is ready to communicate. Press the iDRAC Quick Sync 2 button to turn off.	If the LED fails to turn off, restart the system. If the problem persists, see Getting help .
Blinks white rapidly	Indicates data transfer activity.	If the indicator continues to blink indefinitely, see Getting help .
Blinks white slowly	Indicates that firmware update is in progress.	If the indicator continues to blink indefinitely, see Getting help .
Blinks white five times rapidly and then turns off	Indicates that the iDRAC Quick Sync 2 feature is disabled.	Check if iDRAC Quick Sync 2 feature is configured to be disabled by iDRAC. If the problem persists, see the Getting help section. For more information, see <i>Integrated Dell Remote Access Controller User's Guide</i> at Dell.com/poweredgemanuals or <i>Dell OpenManage Server Administrator User's Guide</i> at Dell.com/openmanagemanuals > OpenManage Server Administrator.
Solid amber	Indicates that the system is in fail-safe mode.	Restart the system. If the problem persists, see Getting help .
Blinking amber	Indicates that the iDRAC Quick Sync 2 hardware is not responding properly.	Restart the system. If the problem persists, see Getting help .

Right control panel view

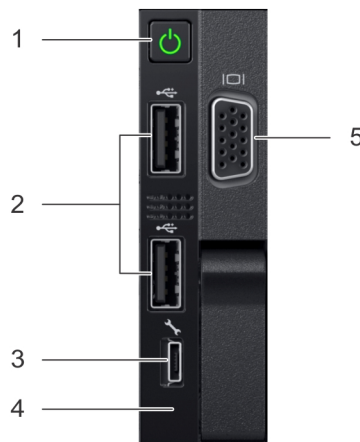





Figure 8. Right control panel view

Table 8. Right control panel features

Item	Indicator, button, or connector	Icon	Description
1	Power button		Indicates if the system is turned on or off. Press the power button to manually turn on or off the system.

Item	Indicator, button, or connector	Icon	Description
<p>NOTE: Press the power button to gracefully shut down an ACPI-compliant operating system.</p>			
2	USB port (2)		The USB ports are 4-pin, 2.0-compliant. These ports enable you to connect USB devices to the system.
3	iDRAC Direct port		The iDRAC Direct port is micro USB 2.0-compliant. This port enables you to access the iDRAC Direct features. For more information, see the iDRAC User's Guide at Dell.com/poweredgemanuals .
4	iDRAC Direct LED	N/A	The iDRAC Direct LED indicator lights up to indicate that the iDRAC Direct port is connected. For more information, see the iDRAC Direct LED indicator codes section.
5	VGA port		Enables you to connect a display device to the system. For more information, see the Technical specification section.

iDRAC Direct LED indicator codes

The iDRAC Direct LED indicator lights up to indicate that the port is connected and is being used as a part of the iDRAC subsystem.

iDRAC Direct LED indicator is located below the iDRAC Direct port on the right control panel.

You can configure iDRAC Direct by using a USB to micro USB (type AB) cable, which you can connect to your laptop or tablet. The following table describes iDRAC Direct activity when the iDRAC Direct port is active:

Table 9. iDRAC Direct LED indicator codes

iDRAC Direct LED indicator code	Condition
Solid green for two seconds	Indicates that the laptop or tablet is connected.
Flashing green (on for two seconds and off for two seconds)	Indicates that the laptop or tablet connected is recognized.
Turns off	Indicates that the laptop or tablet is unplugged.

Back view of the system

The back view of the system provides access to the features available on the back of the server.

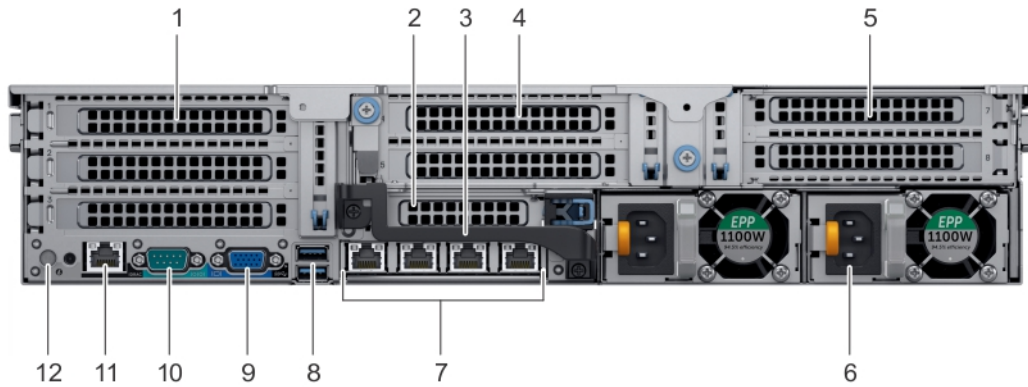







Figure 9. Back view of three riser system

Table 10. Features available on the back view

Item	Panels, ports and slots	Icon	Description
1	Full-height PCIe expansion card slot (3)	N/A	The PCIe expansion card slot (riser 1) connects up to three full-height PCIe expansion cards to the system. For more information, see the Expansion card installation guidelines section.
2	Half-height PCIe expansion card slot	N/A	The PCIe expansion card slot (riser 2) connects one half-height PCIe expansion cards to the system. For more information, see Expansion card installation guidelines section.
3	Rear handle	N/A	The rear handle can be removed to enable any external cabling of PCIe cards that are installed in the PCIe expansion card slot 6.
4	Full-height PCIe expansion card slot (2)	N/A	The PCIe expansion card slot (riser 2) connects up to two full-height PCIe expansion cards to the system. For more information, see Expansion card installation guidelines section.
5	Full-height PCIe expansion card slot (2)	N/A	The PCIe expansion card slot (riser 3) connects up to two full-height PCIe expansion cards to the system. For more information, see Expansion card installation guidelines section.
6	Power supply unit (2)	N/A	For more information, see Technical specifications section.
7	NIC ports		The NIC ports that are integrated on the network daughter card (NDC) provide network connectivity. For more information about the supported configurations, see Technical specifications section.
8	USB port (2)		The USB ports are 9-pin and 3.0-compliant. These ports enable you to connect USB devices to the system.
9	VGA port		Enables you to connect a display device to the system. For more information, see the Technical specifications section.
10	Serial port		Enables you to connect a serial device to the system. For more information, see the Technical specifications section.
11	iDRAC9 dedicated port		Enables you to remotely access iDRAC. For more information, see the iDRAC User's Guide at Dell.com/poweredgemanuals .
12	System identification button		The System Identification (ID) button is available on the front and back of the systems. Press the button to identify a system in a rack by turning on

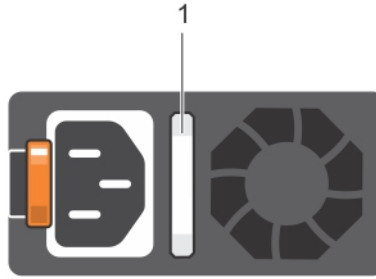

Figure 11. AC PSU status indicator

1 AC PSU status indicator/handle

Table 12. AC PSU status indicator codes

Power indicator codes	Condition
Green	A valid power source is connected to the PSU and the PSU is operational.
Blinking amber	Indicates a problem with the PSU.
Not illuminated	Power is not connected to the PSU.
Blinking green	When the firmware of the PSU is being updated, the PSU handle blinks green. <ul style="list-style-type: none"> △ CAUTION: Do not disconnect the power cord or unplug the PSU when updating firmware. If firmware update is interrupted, the PSUs do not function.
Blinking green and turns off	When hot-plugging a PSU, the PSU handle blinks green five times at a rate of 4 Hz and turns off. This indicates a PSU mismatch with respect to efficiency, feature set, health status, or supported voltage. <ul style="list-style-type: none"> △ CAUTION: If two PSUs are installed, both the PSUs must have the same type of label; for example, Extended Power Performance (EPP) label. Mixing PSUs from previous generations of PowerEdge servers is not supported, even if the PSUs have the same power rating. This results in a PSU mismatch condition or failure to turn the system on. △ CAUTION: When correcting a PSU mismatch, replace only the PSU with the blinking indicator. Swapping the PSU to make a matched pair can result in an error condition and unexpected system shutdown. To change from a high output configuration to a low output configuration or vice versa, you must turn off the system. △ CAUTION: AC PSUs support both 240 V and 120 V input voltages with the exception of Titanium PSUs, which support only 240 V. When two identical PSUs receive different input voltages, they can output different wattages, and trigger a mismatch. △ CAUTION: If two PSUs are used, they must be of the same type and have the same maximum output power. △ CAUTION: Combining AC and DC PSUs is not supported and triggers a mismatch.

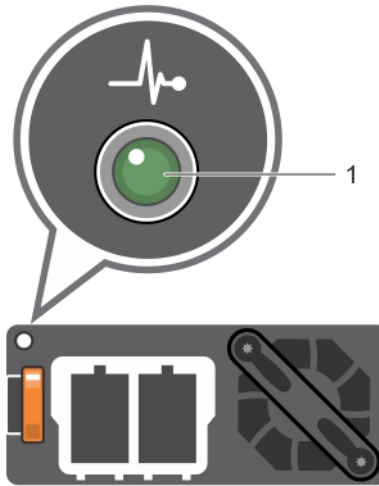

Figure 12. DC PSU status indicator

1 DC PSU status indicator

Table 13. DC PSU status indicator codes

Power indicator codes	Condition
Green	A valid power source is connected to the PSU and the PSU is operational.
Blinking amber	Indicates a problem with the PSU.
Not illuminated	Power is not connected to the PSU.
Blinking green	When hot-plugging a PSU, the PSU indicator blinks green. This indicates that there is a PSU mismatch with respect to efficiency, feature set, health status, or supported voltage.
	<p>△ CAUTION: If two PSUs are installed, both the PSUs must have the same type of label; for example, Extended Power Performance (EPP) label. Mixing PSUs from previous generations of PowerEdge servers is not supported, even if the PSUs have the same power rating. This results in a PSU mismatch condition or failure to turn the system on.</p> <p>△ CAUTION: When correcting a PSU mismatch, replace only the PSU with the blinking indicator. Swapping the PSU to make a matched pair can result in an error condition and unexpected system shutdown. To change from a High Output configuration to a Low Output configuration or vice versa, you must turn off the system.</p> <p>△ CAUTION: If two PSUs are used, they must be of the same type and have the same maximum output power.</p> <p>△ CAUTION: Combining AC and DC PSUs is not supported and triggers a mismatch.</p>

Drive indicator codes

Each drive carrier has an activity LED indicator and a status LED indicator. The indicators provide information about the current status of the drive. The activity LED indicator indicates whether the drive is currently in use or not. The status LED indicator indicates the power condition of the drive.

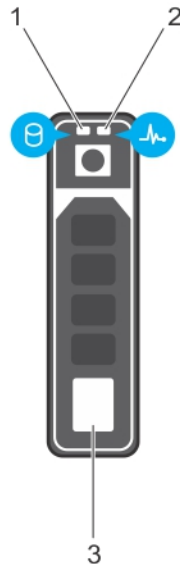

Figure 13. Drive indicators

- 1 Drive activity LED indicator
- 2 Drive status LED indicator
- 3 Drive

NOTE: If the drive is in the Advanced Host Controller Interface (AHCI) mode, the status LED indicator does not turn on.

Table 14. Drive indicator codes

Drive status indicator code	Condition
Flashes green twice per second	Identifying drive or preparing for removal.
Off	Drive ready for removal.
	NOTE: The drive status indicator remains off until all drives are initialized after the system is turned on. Drives are not ready for removal during this time.
Flashes green, amber, and then turns off	Predicted drive failure.
Flashes amber four times per second	Drive failed.
Flashes green slowly	Drive rebuilding.
Solid green	Drive online.
Flashes green for three seconds, amber for three seconds, and then turns off after six seconds	Rebuild stopped.

LCD panel

The LCD panel provides system information, status, and error messages to indicate if the system is functioning correctly or requires attention. The LCD panel can also be used to configure or view the system's iDRAC IP address. For information about the event and error messages generated by the system firmware and agents that monitor system components, see the Error Code Lookup page, at qrl.dell.com.

The LCD panel is available only on the optional front bezel. The optional front bezel is hot pluggable.

The statuses and conditions of the LCD panel are outlined here:

- The LCD backlight is white during normal operating conditions.
- When the system needs attention, the LCD backlight turns amber, and displays an error code followed by descriptive text.
- ① **NOTE: If the system is connected to a power source and an error is detected, the LCD turns amber regardless of whether the system is turned on or off.**
- When the system turns off and there are no errors, LCD enters the standby mode after five minutes of inactivity. Press any button on the LCD to turn it on.
- If the LCD panel stops responding, remove the bezel and reinstall it.
If the problem persists, see [Getting help](#).
- The LCD backlight remains off if LCD messaging is turned off using the iDRAC utility, the LCD panel, or other tools.

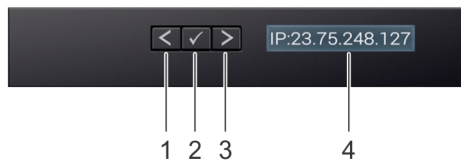





Figure 14. LCD panel features

Table 15. LCD panel features

Item	Button or display	Description
1	Left	Moves the cursor back in one-step increments.
2	Select	Selects the menu item highlighted by the cursor.
3	Right	Moves the cursor forward in one-step increments. During message scrolling: <ul style="list-style-type: none"> • Press and hold the right button to increase scrolling speed. • Release the button to stop. ① NOTE: The display stops scrolling when the button is released. After 45 seconds of inactivity, the display starts scrolling.
4	LCD display	Displays system information, status, and error messages or iDRAC IP address.

Viewing Home screen

The **Home** screen displays user-configurable information about the system. This screen is displayed during normal system operation when there are no status messages or errors. When the system turns off and there are no errors, LCD enters the standby mode after five minutes of inactivity. Press any button on the LCD to turn it on.

- 1 To view the **Home** screen, press one of the three navigation buttons (Select, Left, or Right).
- 2 To navigate to the **Home** screen from another menu, complete the following steps:
 - a Press and hold the navigation button till the up arrow  is displayed.
 - b Navigate to the **Home** icon  using the up arrow .
 - c Select the **Home** icon.
 - d On the **Home** screen, press the **Select** button to enter the main menu.

Setup menu

 **NOTE:** When you select an option in the Setup menu, you must confirm the option before proceeding to the next action.

Option	Description
iDRAC	Select DHCP or Static IP to configure the network mode. If Static IP is selected, the available fields are IP , Subnet (Sub) , and Gateway (Gtw) . Select Setup DNS to enable DNS and to view domain addresses. Two separate DNS entries are available.
Set error	Select SEL to view LCD error messages in a format that matches the IPMI description in the SEL. This enables you to match an LCD message with an SEL entry. Select Simple to view LCD error messages in a simplified user-friendly description. For more information about error messages, see the <i>Event and Error Message Reference Guide for 14th Generation Dell EMC PowerEdge Servers</i> at Dell.com/qr1 .
Set home	Select the default information to be displayed on the Home screen. See View menu section for the options and option items that can be set as the default on the Home screen.

View menu

 **NOTE:** When you select an option in the View menu, you must confirm the option before proceeding to the next action.

Option	Description
iDRAC IP	Displays the IPv4 or IPv6 addresses for iDRAC9. Addresses include DNS (Primary and Secondary) , Gateway , IP , and Subnet (IPv6 does not have Subnet).
MAC	Displays the MAC addresses for iDRAC , iSCSI , or Network devices.
Name	Displays the name of the Host , Model , or User String for the system.
Number	Displays the Asset tag or the Service tag for the system.
Power	Displays the power output of the system in BTU/hr or Watts. The display format can be configured in the Set home submenu of the Setup menu.

Option	Description
Temperature	Displays the temperature of the system in Celsius or Fahrenheit. The display format can be configured in the Set home submenu of the Setup menu.

Locating the Service Tag of your system

You can identify your system using the unique Express Service Code and Service Tag. Pull out the information tag in front of the system to view the Express Service Code and Service Tag. Alternatively, the information may be on a sticker on the chassis of the system. The mini Enterprise Service Tag (EST) is found on the back of the system. This information is used by Dell to route support calls to the appropriate personnel.

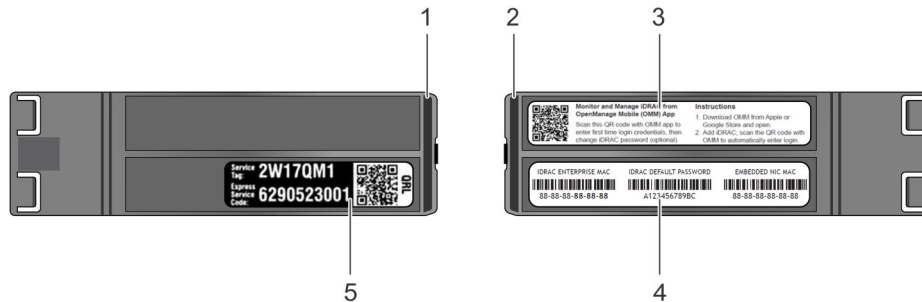

Figure 15. Locating Service Tag of your system

- | | | | |
|---|-------------------------------|---|---|
| 1 | information tag (top view) | 2 | information tag (back view) |
| 3 | OpenManage Mobile (OMM) label | 4 | iDRAC MAC address and iDRAC secure password label |
| 5 | Service Tag | | |

System information label

PowerEdge R740 – Front system information label

LED behavior, express service tag, hard drives configuration and layout

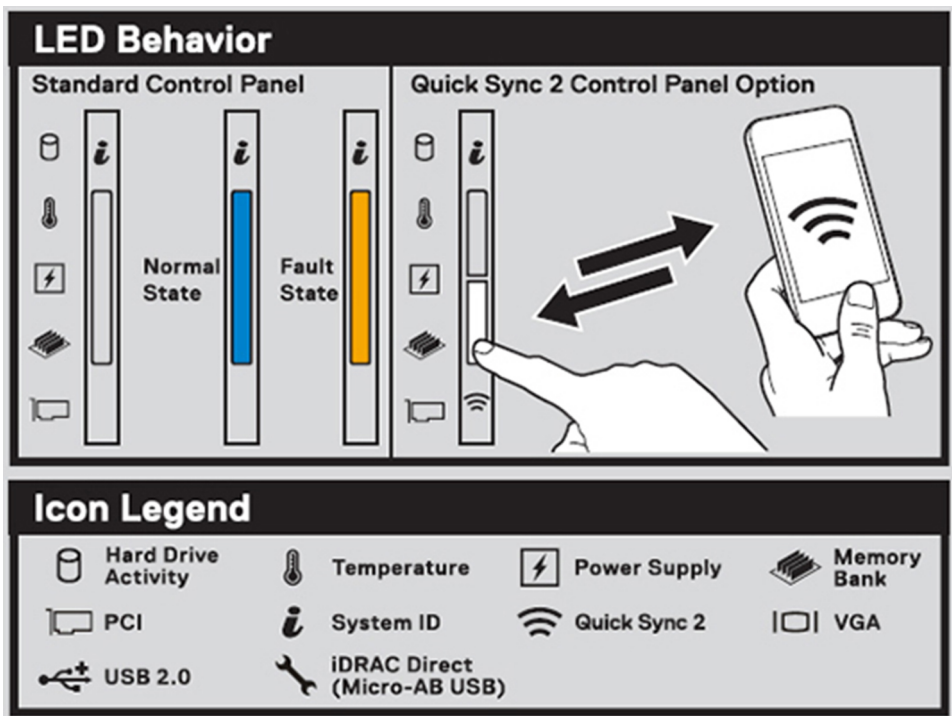

Figure 16. LED behavior

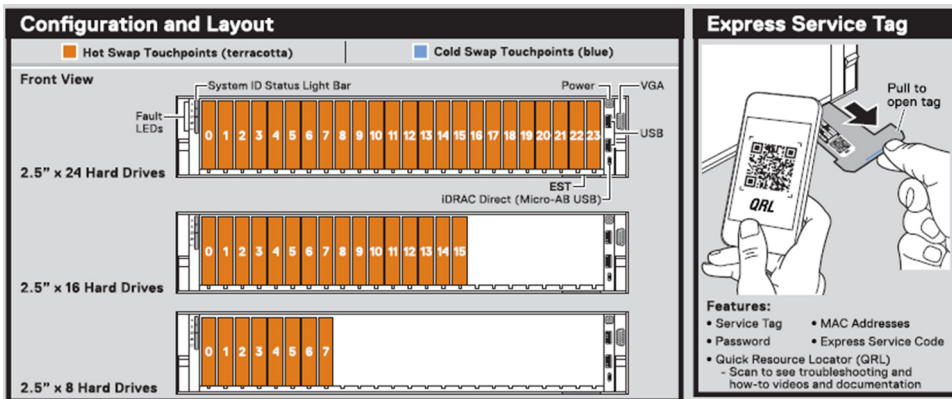

Figure 17. 2.5 inch hard drives configuration and layout

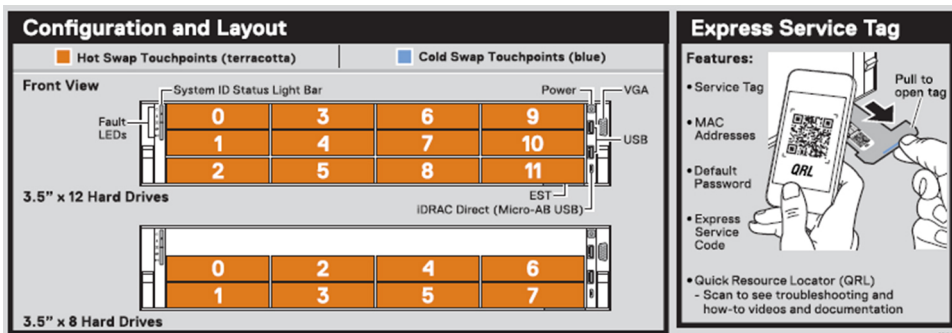

Figure 18. 3.5 inch hard drives configuration and layout

PowerEdge R740 – Service information

System touchpoint, electrical overview, mechanical overview and rear view configurations

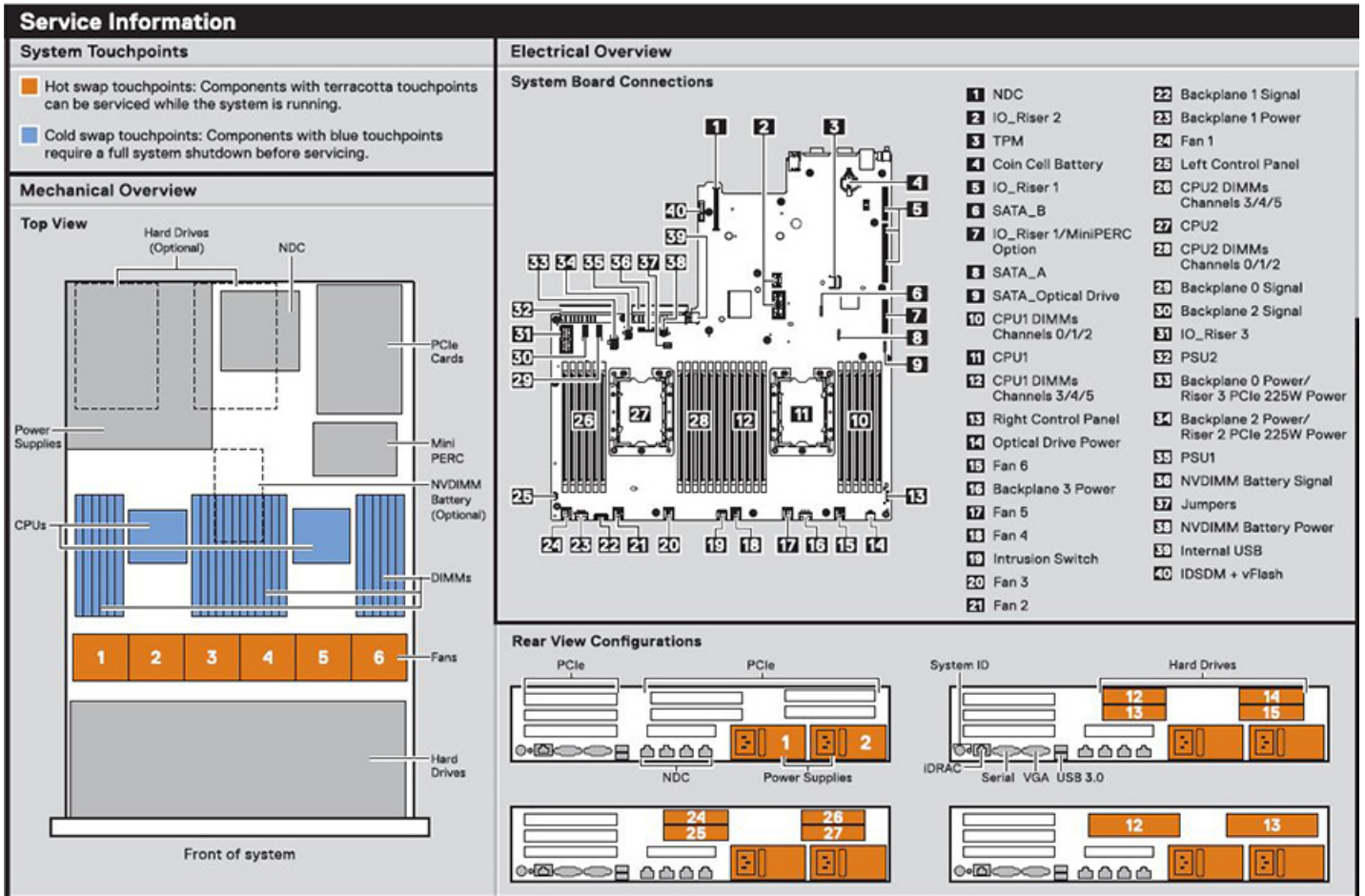









Figure 19. Service Information

Jumper Settings

Jumper	Setting	Description
 PWRD_EN	 (default)	BIOS password is enabled.
		BIOS password is disabled. iDRAC local access unlocked at next AC power cycle. iDRAC password reset is enabled in F2 iDRAC settings menu.
 NVRAM_CLR	 (default)	BIOS configuration settings retained at system boot.
		BIOS configuration settings cleared at system boot.

Scan to see how-to videos, documentation, and troubleshooting solutions.



Quick Resource Locator
Dell.com/QRL/Server/PER740

To learn more about this Dell product or to order additional or replacement parts, go to Dell.com/support

Memory Information

⚠ Caution: Memory (DIMMs) and CPUs may be hot during servicing.

B6 B5 B4
| B12 | B11 | B10



B1 B2 B3 A6 A5 A4
| B7 | B8 | B9 | A12 | A11 | A10

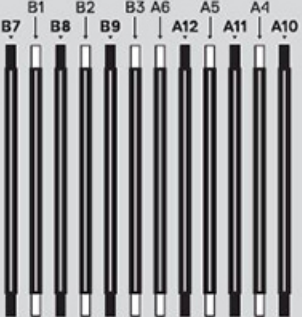

A1 A2 A3
| A7 | A8 | A9



2
1

Memory Population Configuration	Sequence
Memory-Optimized	1, 2, 3, 4, 5, 6, 7, 8, 9, 10, 11, 12
Mirroring	(1,2) (3,4) (5,6) (7,8) (9,10) (11,12)

Memory Sparring details are documented in the *Installation and Service Manual*.

Figure 20. Jumper setting and memory information

MiniPERC

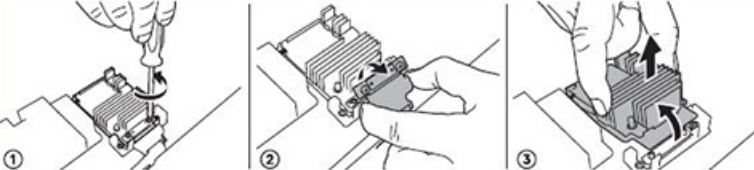

System Tasks

Network Daughter Card Installation

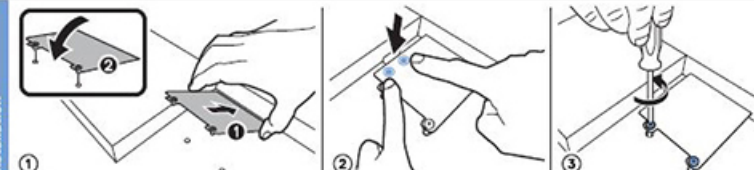

⚠ Caution: Many repairs may only be done by a certified service technician. You should only perform troubleshooting and simple repairs as authorized in your product documentation, or as directed by the online or telephone service and support team. Damage due to servicing that is not authorized by Dell is not covered by your warranty. Read and follow the safety instructions that came with the product.

Copyright © 2017 Dell Inc. or its subsidiaries. All Rights Reserved.
Rev A00-01. Label Part No. 36X2C

Figure 21. system task

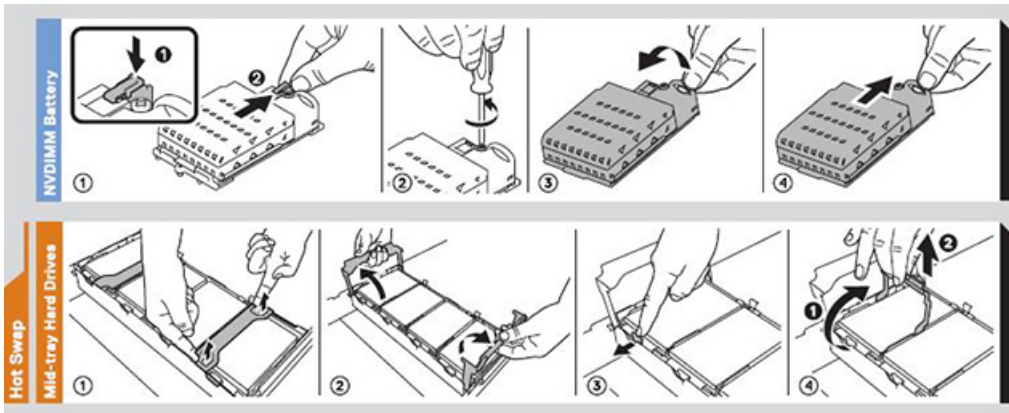

Figure 22. NVDIMM battery and mid-tray hard drives

Documentation resources

This section provides information about the documentation resources for your system.

To view the document that is listed in the documentation resources table:

- From the Dell EMC support site:
 - a Click the documentation link that is provided in the Location column in the table.
 - b Click the required product or product version.

i | NOTE: To locate the product name and model, see the front of your system.

 - c On the Product Support page, click **Manuals & documents**.
- Using search engines:
 - Type the name and version of the document in the search box.

Table 16. Additional documentation resources for your system

Task	Document	Location
Setting up your system	For more information about installing and securing the system into a rack, see the Rail Installation Guide included with your rack solution. For information about setting up your system, see the <i>Getting Started Guide</i> document that is shipped with your system.	Dell.com/poweredgemanuals
Configuring your system	For information about the iDRAC features, configuring and logging in to iDRAC, and managing your system remotely, see the Integrated Dell Remote Access Controller User's Guide. For information about understanding Remote Access Controller Admin (RACADM) subcommands and supported RACADM interfaces, see the RACADM CLI Guide for iDRAC. For information about Redfish and its protocol, supported schema, and Redfish Eventing implemented in iDRAC, see the Redfish API Guide. For information about iDRAC property database group and object descriptions, see the Attribute Registry Guide.	Dell.com/poweredgemanuals
	For information about earlier versions of the iDRAC documents. To identify the version of iDRAC available on your system, on the iDRAC web interface, click ? > About .	Dell.com/idracmanuals
	For information about installing the operating system, see the operating system documentation.	Dell.com/operatingsystemmanuals

Task	Document	Location
	For information about updating drivers and firmware, see the Methods to download firmware and drivers section in this document.	Dell.com/support/drivers
Managing your system	For information about systems management software offered by Dell, see the Dell OpenManage Systems Management Overview Guide.	Dell.com/poweredgemanuals
	For information about setting up, using, and troubleshooting OpenManage, see the Dell OpenManage Server Administrator User's Guide.	Dell.com/openmanagemanuals > OpenManage Server Administrator
	For information about installing, using, and troubleshooting Dell OpenManage Essentials, see the Dell OpenManage Essentials User's Guide.	Dell.com/openmanagemanuals > OpenManage Essentials
	For information about installing and using Dell SupportAssist, see the Dell EMC SupportAssist Enterprise User's Guide.	Dell.com/serviceabilitytools
	For information about partner programs enterprise systems management, see the OpenManage Connections Enterprise Systems Management documents.	Dell.com/openmanagemanuals
Working with the Dell PowerEdge RAID controllers	For information about understanding the features of the Dell PowerEdge RAID controllers (PERC), Software RAID controllers, or BOSS card and deploying the cards, see the Storage controller documentation.	Dell.com/storagecontrollermanuals
Understanding event and error messages	For information about the event and error messages generated by the system firmware and agents that monitor system components, see the Error Code Lookup.	Dell.com/qrl
Troubleshooting your system	For information about identifying and troubleshooting the PowerEdge server issues, see the Server Troubleshooting Guide.	Dell.com/poweredgemanuals

Technical specifications

The technical and environmental specifications of your system are outlined in this section.

Topics:

- System dimensions
- Chassis weight
- Processor specifications
- Supported operating systems
- PSU specifications
- System battery specifications
- Expansion bus specifications
- Memory specifications
- Storage controller specifications
- Drive specifications
- Ports and connectors specifications
- Video specifications
- Environmental specifications

System dimensions

This section describes the physical dimensions of the system.

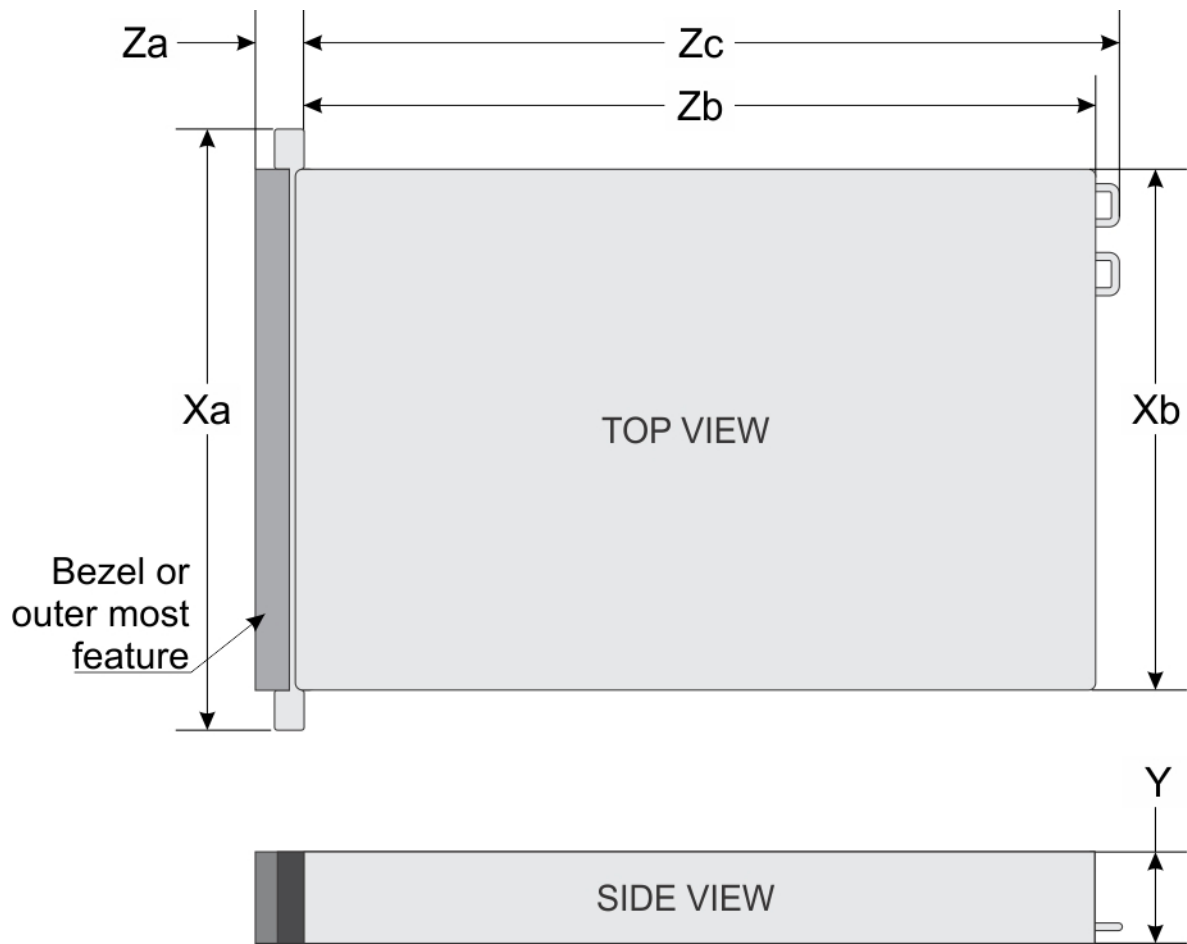

Figure 23. System dimensions of PowerEdge R740 system

Table 17. Dimensions

System	Xa	Xb	Y	Za (with bezel)	Za (without bezel)	Zb	Zc
PowerEdge R740	482.0 mm (18.98 inches)	434.0 mm (17.09 inches)	86.8 mm (3.42 inches)	35.84 mm (1.41 inches)	22.0 mm (0.87 inches)	678.8 mm (26.72 inches)	715.5 mm (28.17 inches)

Chassis weight

Table 18. Chassis weight

System	Maximum weight (with all drives/SSDs)
2.5 inch drive systems	26.3 kg (57.98 lb)
3.5 inch drive systems	28.6 kg (63.05 lb)

Processor specifications

The PowerEdge R740 system supports up to two Intel Xeon Processor Scalable Family processors, up to 28 cores per processor.

Supported operating systems

The PowerEdge R740 supports the following operating systems:

Canonical Ubuntu LTS

Citrix XenServer

Microsoft Windows Server with Hyper-V

Red Hat Enterprise Linux

SUSE Linux Enterprise Server

VMware ESXi

For more information on the specific versions and additions, visit www.dell.com/support/home/Drivers/SupportedOS/poweredge-r740.

PSU specifications

The PowerEdge R740 system supports up to two AC or DC power supply units (PSUs).

Table 19. PSU specifications

PSU	Class	Heat dissipation (maximum)	Frequency	Voltage	High line 200v240 V	Low line 100– 140 V	DC	Current
495 W AC	Platinum	1908 BTU/hr	50/60 Hz	100–240 V AC, autoranging	495 W	495 W		6.5 A–3 A
750 W AC	Platinum	2891 BTU/hr	50/60 Hz	100–240 V AC, autoranging	750 W	750 W		10 A–5 A
750 W AC	Titanium	2843 BTU/hr	50/60 Hz	200–240 V AC, autoranging	750 W			5 A
750 W Mixed Mode HVDC (for China only)	Platinum	2891 BTU/hr	50/60 Hz	100–240 V AC, autoranging	750 W	750 W		10 A–5 A
	N/A	2891 BTU/hr	N/A	240 V DC, autoranging			750W	4.5 A
1100 W AC	Platinum	4100 BTU/hr	50/60 Hz	100–240 V AC, autoranging	1100 W	1050 W		12 A–6.5 A
1100 W DC	N/A	4416 BTU/hr	N/A	–(48–60) V DC, autoranging			1100 W	32 A
1100 W Mixed Mode HVDC (for	Platinum	4100 BTU/hr	50/60 Hz	100–240 V AC, autoranging	1100 W	1050 W		12 A–6.5 A
	N/A	4100 BTU/hr	N/A	200–380 V DC, autoranging			1100 W	6.4 A–3.2 A

PSU	Class	Heat dissipation (maximum)	Frequency	Voltage	High line 200v240 V	Low line 100– 140 V	DC	Current
China and Japan only)								
1600 W AC	Platinum	6000 BTU/hr	50/60 Hz	100–240 V AC, autoranging	1600 W	800 W		10 A
2000 W AC	Platinum	7500 BTU/hr	50/60 Hz	100–240 V AC, autoranging	2000 W	1000 W		11.5 A
2400 W AC	Platinum	9000 BTU/hr	50/60 Hz	100–240 V AC, autoranging	2400 W	1400 W		16 A

NOTE: Heat dissipation is calculated using the PSU wattage rating.

NOTE: This system is also designed to connect to the IT power systems with a phase to phase voltage not exceeding 240 V.

NOTE: PSUs rated for 1100 W Mixed Mode HVDC or 1100 W AC and higher require high-line voltage (200–240 V AC) to supply their rated capacity.

System battery specifications

The PowerEdge R740 system supports CR 2032 3.0-V lithium coin cell system battery.

Expansion bus specifications

The PowerEdge R740 system supports up to eight PCI express (PCIe) generation 3 expansion cards that can be installed on the system board using expansion card risers. The following table provides detailed information about the expansion card riser specifications:

Table 20. Expansion card riser configurations

Expansion card riser	PCIe slots on the riser	Height	Length	Link
Riser 1A	Slot 1	Full Height	Full Length	x16
	Slot 3	Full Height	Half Length	x16
Riser 1B	Slot 1	Full Height	Full Length	x8
	Slot 2	Full Height	Full Length	x8
	Slot 3	Full Height	Half Length	x8
Riser 1D	Slot 1	Full Height	Full Length	x16
	Slot 2	Full Height	Full Length	x8
	Slot 3	Full Height	Half Length	x8
Riser 2A	Slot 4	Full Height	Full Length	x16
	Slot 5	Full Height	Full Length	x8
	Slot 6	Low Profile	Half Length	x8
Riser 2B	Slot 4	Low Profile	Half Length	x8
Riser 2C	Slot 4	Low Profile	Half Length	x16
Riser 3A	Slot 7	Full Height	Full Length	x8

Expansion card riser	PCIe slots on the riser	Height	Length	Link
	Slot 8	Full Height	Full Length	x16

Table 21. Expansion card riser specifications

Riser configuration and supported risers	Slot description	PCIe slots on riser 1 (Height and length)	Processor connection	PCIe slots on riser 2 (Height and length)	Processor connection	PCIe slots on riser 3 (Height and length)	Processor connection
Riser configuration 0 (No riser)	No PCIe slots (only rear storage)	N/A	N/A	N/A	N/A	N/A	N/A
Riser configuration 1 (1B+2B)	Four x8 slots	Slot 1: x8 full-height, full length	Processor 1				
		Slot 2: x8 full-height, full length	Processor 1	Slot 4: x8 low profile, half length	Processor 1	N/A	N/A
		Slot 3: x8 full-height, half length	Processor 1				
Riser configuration 2 (1B+2C)	Three x8 and one x16 slots	Slot 1: x8 full-height, full length	Processor 1				
		Slot 2: x8 full-height, full length	Processor 1	Slot 4: x16 low profile, half length	Processor 2	N/A	N/A
		Slot 3: x8 full-height, half length	Processor 1				
Riser configuration 3 (1A+2A)	Two x8 and three x16 slots	Slot 1: x16 full-height, full length	Processor 1	Slot 4: x16 full-height, full length	Processor 2		
		N/A	N/A	Slot 5: x8 full-height, full length	Processor 2	N/A	N/A
		Slot 3: x16 full-height, half length	Processor 1	Slot 6: x8 low profile, half length	Processor 1		
Riser configuration 4 (1A+2A+3A)	Three x8 and four x16 slots	Slot 1: x16 full-height, full length	Processor 1	Slot 4: x16 full-height, full length	Processor 2	Slot 7: x8 full-height, full length	Processor 2
		N/A	N/A	Slot 5: x8 full-height, full length	Processor 2	Slot 8: x16 full-height, full length	Processor 2
		Slot 3: x16 full-height, half length	Processor 1	Slot 6: x8 low profile, half length	Processor 1		
Riser configuration 5 (1B+2A+3A)	Six x8 and two x16 slots	Slot 1: x8 full-height, full length	Processor 1	Slot 4: x16 full-height, full length	Processor 2	Slot 7: x8 full-height, full length	Processor 2
		Slot 2: x8 full-height, full length	Processor 1	Slot 5: x8 full-height, full length	Processor 2	Slot 8: x16 full-height, full length	Processor 2
		Slot 3: x8 full-height, half length	Processor 1	Slot 6: x8 low profile, half length	Processor 1		
Riser configuration 6 (1D+2A+3A)	Five x8 and three x16 slots	Slot1: x16 full-height, full length	Processor 1	Slot 4: x16 full-height, full length	Processor 2	Slot 7: x8 full-height, full length	Processor 2

Riser configuration and supported risers	Slot description	PCIe slots on riser 1 (Height and length)	Processor connection	PCIe slots on riser 2 (Height and length)	Processor connection	PCIe slots on riser 3 (Height and length)	Processor connection
Riser configuration 9 (1A+2D+3A)	Three x8 and four x16 slots	Slot 2: x8 full-height, full length	Processor 1	Slot 5: x8 full-height, full length	Processor 2	Slot 8: x16 full-height, full length	Processor 2
		Slot 3: x8 full-height, half length	Processor 1	Slot 6: x8 low profile, half length	Processor 1		Processor 2
		Slot 1: x16 full-height, full length	Processor 1	Slot 4: x16 full-height, full length	Processor 2	Slot 7: x8 full-height, full length	Processor 2
		N/A	N/A	Slot 5: x8 full-height, full length	Processor 2	Slot 8: x16 full-height, full length	Processor 2
		Slot 3: x16 full-height, half length	Processor 1	Slot 6: x8 low profile, half length	Processor 1		

Memory specifications

Table 22. Memory specifications

Memory module sockets	DIMM type	DIMM rank	DIMM capacity	Single processor		Dual processors	
				Minimum RAM	Maximum RAM	Minimum RAM	Maximum RAM
Twenty four 288-pins	LRDIMM	Octa rank	128 GB	128 GB	1536 GB	256 GB	3072 GB
	LRDIMM	Quad rank	64 GB	64 GB	768 GB	128 GB	1536 GB
	RDIMM	Single rank	8 GB	8 GB	96 GB	16 GB	192 GB
	RDIMM	Dual rank	16 GB	16 GB	192 GB	32 GB	384 GB
	RDIMM	Dual rank	32 GB	32 GB	384 GB	64 GB	768 GB
	NVDIMM -N	Single rank	16 GB	Not supported with single processor	Not supported with single processor	RDIMM: 192 GB NVDIMM-N: 16 GB	RDIMM: 384 GB NVDIMM-N: 192 GB

① **NOTE: 8 GB RDIMMs and NVDIMM-N must not be mixed.**

① **NOTE: 64 GB LRDIMMs and 128 GB LRDIMMs must not be mixed.**

① **NOTE: Minimum of two CPUs are required for any configurations that support NVDIMM-N.**

Storage controller specifications

The PowerEdge R740 system supports:

- Internal storage controller cards: PowerEdge RAID Controller (PERC) H330, PERC H730P, PERC H740P, HBA330, S140, and Boot Optimized Server Storage (BOSS-S1).
The BOSS card is a simple RAID solution card designed specifically for booting a server's operating system. The card supports up to two 6 Gbps M.2 SATA drives. The BOSS adapter card has a x8 connector using PCIe gen 2.0 x2 lanes, available only in the low-profile and half-height form factor.
- External storage controller cards: PERC H840 and 12Gbps SAS HBA.

Drive specifications

Drives

The PowerEdge R740 system supports SAS, SATA, Nearline SAS hard drives or SSDs.

Table 23. Supported drive options for the PowerEdge R740 system

Drives	Supported configuration
Eight drives system	Up to eight 3.5 inch or 2.5 inch (SAS, SATA or Nearline SAS) front accessible drives in slots 0 through 7
Sixteen drives system	Up to sixteen 2.5 inch (SAS, SATA or Nearline SAS) front accessible drives in slots 0 through 15

Optical drive

The PowerEdge R740 system supports one optional slim SATA DVD-ROM drive or DVD +/-RW drive.

Ports and connectors specifications

USB ports

The PowerEdge R740 system supports:

- Two USB 2.0-compliant ports on the front of the system
- One internal USB 3.0-compliant port
- One optional USB 3.0-compliant port on the front of the system
- One micro USB 2.0-compliant port in the front of the system for iDRAC Direct
- Two USB 3.0-compliant ports on the back of the system

NIC ports

The PowerEdge R740 system supports up to four Network Interface Controller (NIC) ports that are integrated on the network daughter card (NDC), and are available in the following configurations:

- Four RJ-45 ports that support 10, 100 and 1000 Mbps
- Four RJ-45 ports that support 100 M, 1 G and 10 Gbps
- Four RJ-45 ports, where two ports support maximum of 10 G and the other two ports maximum of 1 G
- Two RJ-45 ports that support up to 1 Gbps and 2 SFP+ ports that support up to 10 Gbps
- Four SFP+ ports that support up to 10 Gbps
- Two SFP28 ports that support up to 25 Gbps

NOTE: You can install up to eight PCIe add-on NIC cards.

VGA ports

The Video Graphic Array (VGA) port enables you to connect the system to a VGA display. The PowerEdge R740 system supports two 15-pin VGA ports on the front and back panels.

Serial connector

The PowerEdge R740 system supports one serial connector on the back panel, which is a 9-pin connector, Data Terminal Equipment (DTE), 16550-compliant.

Internal Dual SD Module or vFlash card

The PowerEdge R740 system supports Internal Dual SD module (IDSDM) and vFlash card. In 14th generation of PowerEdge servers, IDSDM and vFlash card are combined into a single card module, and are available in these configurations:

- vFlash or
- IDSDM or
- vFlash and IDSDM

The IDSDM/vFlash card sits in the back of the system, in a Dell-proprietary slot. IDSDM/vFlash card supports three micro SD cards (two cards for IDSDM and one card for vFlash). Micro SD cards capacity for IDSDM are 16/32/64 GB while for vFlash the microSD card capacity is 16 GB.

Video specifications

The PowerEdge R740 system supports integrated Matrox G200eW3 graphics controller with 16 MB of video frame buffer.

Table 24. Supported video resolution options

Resolution	Refresh rate (Hz)	Color depth (bits)
1024 x 768	60	8, 16, 32
1280 x 800	60	8, 16, 32
1280 x 1024	60	8, 16, 32
1360 x 768	60	8, 16, 32
1440 x 900	60	8, 16, 32
1600 x 900	60	8, 16, 32
1600 x 1200	60	8, 16, 32
1680 x 1050	60	8, 16, 32
1920 x 1080	60	8, 16, 32
1920 x 1200	60	8, 16, 32

NOTE: 1920 x 1080 and 1920 x 1200 resolutions are only supported in reduced blanking mode.

Environmental specifications

NOTE: For additional information about environmental certifications, please refer to the Product Environmental Datasheet located with the Manuals & Documents on Dell.com/poweredge/manuals.

Table 25. Temperature specifications

Temperature	Specifications
Storage	-40°C to 65°C (-40°F to 149°F)
Continuous operation (for altitude less than 950 m or 3117 ft)	10°C to 35°C (50°F to 95°F) with no direct sunlight on the equipment.
Maximum temperature gradient (operating and storage)	20°C/h (68°F/h)

Table 26. Relative humidity specifications

Relative humidity	Specifications
Storage	5% to 95% RH with 33°C (91°F) maximum dew point. Atmosphere must be non-condensing at all times.
Operating	10% to 80% relative humidity with 29°C (84.2°F) maximum dew point.

Table 27. Maximum vibration specifications

Maximum vibration	Specifications
Operating	0.26 G _{rms} at 5 Hz to 350 Hz (all three axes).
Storage	1.88 G _{rms} at 10 Hz to 500 Hz for 15 min (all six sides tested).

Table 28. Maximum shock specifications

Maximum shock	Specifications
Operating	Six consecutively executed shock pulses in the positive and negative x, y, and z axes of 6 G for up to 11 ms.
Storage	Six consecutively executed shock pulses in the positive and negative x, y, and z axes (one pulse on each side of the system) of 71 G for up to 2 ms.

Table 29. Maximum altitude specifications

Maximum altitude	Specifications
Operating	3048 m (10,000 ft)
Storage	12,000 m (39,370 ft)

Table 30. Operating temperature de-rating specifications

Operating temperature de-rating	Specifications
Up to 35°C (95°F)	Maximum temperature is reduced by 1°C/300 m (1°F/547 ft) above 950 m (3,117 ft).
35°C to 40°C (95°F to 104°F)	Maximum temperature is reduced by 1°C/175 m (1°F/319 ft) above 950 m (3,117 ft).
40°C to 45°C (104°F to 113°F)	Maximum temperature is reduced by 1°C/125 m (1°F/228 ft) above 950 m (3,117 ft).

Standard operating temperature

Table 31. Standard operating temperature specifications

Standard operating temperature	Specifications
Continuous operation (for altitude less than 950 m or 3117 ft)	10°C to 35°C (50°F to 95°F) with no direct sunlight on the equipment.

Expanded operating temperature

Table 32. Expanded operating temperature specifications

Expanded operating temperature	Specifications
Continuous operation	<p>5°C to 40°C at 5% to 85% RH with 29°C dew point.</p> <p>NOTE: Outside the standard operating temperature (10°C to 35°C), the system can operate continuously in temperatures as low as 5°C and as high as 40°C.</p> <p>For temperatures between 35°C to 40°C, de-rate maximum allowable temperature by 1°C per 175 m above 950 m (1°F per 319 ft).</p>
≤ 1% of annual operating hours	<p>–5°C to 45°C at 5% to 90% RH with 29°C dew point.</p> <p>NOTE: Outside the standard operating temperature (10°C to 35°C), the system can operate down to –5°C or up to 45°C for a maximum of 1% of its annual operating hours.</p> <p>For temperatures between 40°C and 45°C, de-rate maximum allowable temperature by 1°C per 125 m above 950 m (1°F per 228 ft).</p>

NOTE: When operating in the expanded temperature range, system performance may be impacted.

NOTE: When operating in the expanded temperature range, ambient temperature warnings may be reported in the System Event Log.

Expanded operating temperature restrictions

- 128 GB LRDIMM is not supported for FAC.

- Do not perform a cold startup below 5°C.
- The operating temperature specified is for a maximum altitude of 3050 m (10,000 ft).
- 150 W/8 core, 165 W/12 core and higher wattage processor [Thermal Design Power (TDP)>165 W] are not supported.
- Redundant power supply unit is required.
- Non-Dell qualified peripheral cards and/or peripheral cards greater than 25 W are not supported.
- PCIe SSD is not supported.
- NVDIMM-Ns are not supported.
- GPU is not supported.
- Tape backup unit is not supported.

Thermal restrictions

Following table lists the configuration required for efficient cooling.

Table 33. Thermal restrictions configuration

Configuration	Number of processors	Heatsink	Processor/DIMM blank	DIMM blanks	Type of air shroud	Fan
PowerEdge R740	1	One 1U standard heat sink for CPU ≤ 125 W One 2U standard heat sink for CPU > 125 W	Required	Not required	Standard	Four standard fans and one blank to cover two fan slots
PowerEdge R740	2	Two 1U standard heat sink for CPU ≤ 125 W Two 2U standard heat sink for CPU > 125 W	Not required	Not required	Standard	Six standard fans
PowerEdge R740 with GPU	2	Two 1U high performance heat sink	Not required	Not required	GPU air shroud	Six high performance fans

Ambient temperature limitations

The following table lists configurations that require ambient temperature less than 35°C.

NOTE: The ambient temperature limit must be adhered to ensure proper cooling and to avoid excess CPU throttling, which may impact system performance.

Table 34. Configuration based ambient temperature restrictions

System	Front backplane	CPU Thermal Design Power (TDP)	CPU heat sink	Fan type	GPU	Ambient restriction
PowerEdge R740	8 x 3.5 inch SAS/SATA	150 W/8 core, 165 W/12 core, 200 W, 205 W	1U high performance	High performance fan	≥1 double-width/ single-width	30°C
	8 x 2.5 inch SAS/SATA	150 W/8 core, 165 W/12 core, 200 W, 205 W	1U high performance	High performance fan	≥1 double-width/ single-width	30°C

System	Front backplane	CPU Thermal Design Power (TDP)	CPU heat sink	Fan type	GPU	Ambient restriction
	16 x 2.5 inch SAS/SATA	150 W/8 core, 165 W/12 core, 200 W, 205 W	1U high performance	High performance fan	≥1 double-width/single-width	30°C

Particulate and gaseous contamination specifications

The following table defines the limitations that help avoid any equipment damage or failure from particulate and gaseous contamination. If the levels of particulate or gaseous pollution exceed the specified limitations and result in equipment damage or failure, you may need to rectify the environmental conditions. Remediation of environmental conditions is the responsibility of the customer.

Table 35. Particulate contamination specifications

Particulate contamination	Specifications
Air filtration	<p>Data center air filtration as defined by ISO Class 8 per ISO 14644-1 with a 95% upper confidence limit.</p> <p>NOTE: The ISO Class 8 condition applies to data center environments only. This air filtration requirement does not apply to IT equipment designed to be used outside a data center, in environments such as an office or factory floor.</p> <p>NOTE: Air entering the data center must have MERV11 or MERV13 filtration.</p>
Conductive dust	<p>Air must be free of conductive dust, zinc whiskers, or other conductive particles.</p> <p>NOTE: This condition applies to data center and non-data center environments.</p>
Corrosive dust	<ul style="list-style-type: none"> Air must be free of corrosive dust. Residual dust present in the air must have a deliquescent point less than 60% relative humidity. <p>NOTE: This condition applies to data center and non-data center environments.</p>

Table 36. Gaseous contamination specifications

Gaseous contamination	Specifications
Copper coupon corrosion rate	<300 Å/month per Class G1 as defined by ANSI/ISA71.04-2013.
Silver coupon corrosion rate	<200 Å/month as defined by ANSI/ISA71.04-2013.

NOTE: Maximum corrosive contaminant levels measured at ≤50% relative humidity.

Initial system setup and configuration

Setting up your system

Perform the following steps to set up your system:

- 1 Unpack the system.
- 2 Install the system into the rack. For more information about installing the system into the rack, see the *Rail Installation Guide* at Dell.com/poweredgemanuals.
- 3 Connect the peripherals to the system.
- 4 Connect the system to its electrical outlet.
- 5 Power on the system by pressing the power button or by using iDRAC.
- 6 Power on the attached peripherals.

For more information about setting up your system, see the *Getting Started Guide* that shipped with your system.

iDRAC configuration

The Integrated Dell Remote Access Controller (iDRAC) is designed to make system administrators more productive and improve the overall availability of Dell systems. iDRAC alerts administrators about system issues and enables them to perform remote system management. This reduces the need for physical access to the system.

Options to set up iDRAC IP address

To enable communication between your system and iDRAC, you must first configure the network settings based on your network infrastructure.

NOTE: For static IP configuration, you must request for it at the time of purchase.

This option is set to **DHCP** by Default. You can set up the IP address by using one of the following interfaces:

Interfaces	Document/Section
iDRAC Settings utility	<i>Dell Integrated Dell Remote Access Controller User's Guide</i> at Dell.com/poweredgemanuals
Dell Deployment Toolkit	<i>Dell Deployment Toolkit User's Guide</i> at Dell.com/openmanagemanuals > OpenManage Deployment Toolkit
Dell Lifecycle Controller	<i>Dell Lifecycle Controller User's Guide</i> at Dell.com/poweredgemanuals
Server LCD panel	LCD panel section
iDRAC Direct and Quick Sync 2 (optional)	See <i>Dell Integrated Dell Remote Access Controller User's Guide</i> at Dell.com/poweredgemanuals

NOTE: To access iDRAC, ensure that you connect the ethernet cable to the iDRAC9 dedicated network port. You can also access iDRAC through the shared LOM mode, if you have opted for a system that has the shared LOM mode enabled.

Log in to iDRAC

You can log in to iDRAC as:

- iDRAC user
- Microsoft Active Directory user
- Lightweight Directory Access Protocol (LDAP) user

If you have opted for secure default access to iDRAC, you must use the iDRAC secure default password available on the system Information tag. If you have not opted for secure default access to iDRAC, then use the default user name and password `-root` and `calvin`. You can also log in by using your Single Sign-On or Smart Card.

NOTE: You must have the iDRAC credentials to log in to iDRAC.

NOTE: Ensure that you change the default user name and password after setting up the iDRAC IP address.

NOTE: The Intel Quick Assist Technology (QAT) on the Dell EMC PowerEdge R740 is supported with chipset integration and is enabled through an optional license. The license files are enabled on the sleds through iDRAC.

For more information about drivers, documentation, and white papers on the Intel QAT, see <https://01.org/intel-quickassist-technology>.

For more information about logging in to the iDRAC and iDRAC licenses, see the latest *Integrated Dell Remote Access Controller User's Guide* at Dell.com/poweredgemanuals.

You can also access iDRAC by using RACADM. For more information, see the *RACADM Command Line Interface Reference Guide* at Dell.com/poweredgemanuals.

Options to install the operating system

If the system is shipped without an operating system, install a supported operating system by using one of the following resources:

Table 37. Resources to install the operating system

Resources	Location
iDRAC	Dell.com/idracmanuals
Lifecycle Controller	Dell.com/idracmanuals > Lifecycle Controller
OpenManage Deployment Toolkit	Dell.com/openmanagemanuals > OpenManage Deployment Toolkit
Dell certified VMware ESXi	Dell.com/virtualizationsolutions
Installation and How-to videos for supported operating systems on PowerEdge systems	Supported Operating Systems for Dell EMC PowerEdge systems

Methods to download firmware and drivers

You can download the firmware and drivers by using any of the following methods:

Table 38. Firmware and drivers

Methods	Location
From the Dell EMC support site	Dell.com/support/home
Using Dell Remote Access Controller Lifecycle Controller (iDRAC with LC)	Dell.com/idracmanuals
Using Dell Repository Manager (DRM)	Dell.com/openmanagemanuals > Repository Manager
Using Dell OpenManage Essentials (OME)	Dell.com/openmanagemanuals > OpenManage Essentials
Using Dell Server Update Utility (SUU)	Dell.com/openmanagemanuals > Server Update Utility
Using Dell OpenManage Deployment Toolkit (DTK)	Dell.com/openmanagemanuals > OpenManage Deployment Toolkit
Using iDRAC virtual media	Dell.com/idracmanuals

Downloading drivers and firmware

Dell EMC recommends that you download and install the latest BIOS, drivers, and systems management firmware on your system.

Prerequisite

Ensure that you clear the web browser cache before downloading the drivers and firmware.

Steps

- 1 Go to [Dell.com/support/home](https://dell.com/support/home).
- 2 In the **Drivers & Downloads** section, type the Service Tag of your system in the **Enter a Service Tag or product ID** box, and then click **Submit**.

 **NOTE:** If you do not have the Service Tag, select **Detect Product** to allow the system to automatically detect the Service Tag, or click **View products**, and navigate to your product.

- 3 Click **Drivers & Downloads**.
The drivers that are applicable to your system are displayed.
- 4 Download the drivers to a USB drive, CD, or DVD.

Pre-operating system management applications

You can manage basic settings and features of a system without booting to the operating system by using the system firmware.

Topics:

- [Options to manage the pre-operating system applications](#)
- [System Setup](#)
- [Dell Lifecycle Controller](#)
- [Boot Manager](#)
- [PXE boot](#)

Options to manage the pre-operating system applications

Your system has the following options to manage the pre-operating system applications:

- System Setup
- Dell Lifecycle Controller
- Boot Manager
- Preboot Execution Environment (PXE)

System Setup

By using the **System Setup** screen, you can configure the BIOS settings, iDRAC settings, and device settings of your system.

i **NOTE:** Help text for the selected field is displayed in the graphical browser by default. To view the help text in the text browser, press F1.

You can access system setup by one of the following:

- Standard graphical browser—The browser is enabled by default.
- Text browser—The browser is enabled by using Console Redirection.

Viewing System Setup

To view the **System Setup** screen, perform the following steps:

- 1 Power on, or restart your system.
- 2 Press F2 immediately after you see the following message:

```
F2 = System Setup
```

i **NOTE:** If your operating system begins to load before you press F2, wait for the system to finish booting, and then restart your system and try again.

System Setup details

The **System Setup Main Menu** screen details are explained as follows:

Option	Description
System BIOS	Enables you to configure BIOS settings.
iDRAC Settings	Enables you to configure the iDRAC settings. The iDRAC settings utility is an interface to set up and configure the iDRAC parameters by using UEFI (Unified Extensible Firmware Interface). You can enable or disable various iDRAC parameters by using the iDRAC settings utility. For more information about this utility, see <i>Integrated Dell Remote Access Controller User's Guide</i> at Dell.com/poweredgemanuals .
Device Settings	Enables you to configure device settings.

System BIOS

You can use the **System BIOS** screen to edit specific functions such as boot order, system password, and setup password, set the SATA and PCIe NVMe RAID mode, and enable or disable USB ports.

Viewing System BIOS

To view the **System BIOS** screen, perform the following steps:

- 1 Power on, or restart your system.
- 2 Press F2 immediately after you see the following message:

```
F2 = System Setup
```

NOTE: If the operating system begins to load before you press F2, wait for the system to finish booting, and then restart the system and try again.

- 3 On the **System Setup Main Menu** screen, click **System BIOS**.

System BIOS Settings details

The **System BIOS Settings** screen details are explained as follows:

Option	Description
System Information	Provides information about the system such as the system model name, BIOS version, and Service Tag.
Memory Settings	Provides information and options related to the installed memory.
Processor Settings	Provides information and options related to the processor such as speed and cache size.
SATA Settings	Provides options to enable or disable the integrated SATA controller and ports.
NVMe Settings	Provides options to change the NVMe settings. If the system contains the NVMe drives that you want to configure in a RAID array, you must set both this field and the Embedded SATA field on the SATA Settings menu to RAID mode. You might also need to change the Boot Mode setting to UEFI . Otherwise, you should set this field to Non-RAID mode.
Boot Settings	Provides options to specify the Boot mode (BIOS or UEFI). Enables you to modify UEFI and BIOS boot settings.

Option	Description
Network Settings	Provides options to manage the UEFI network settings and boot protocols. Legacy network settings are managed from the Device Settings menu.
Integrated Devices	Provides options to manage integrated device controllers and ports, specifies related features and options.
Serial Communication	Provides options to manage the serial ports, their related features and options.
System Profile Settings	Provides options to change the processor power management settings, and memory frequency.
System Security	Provides options to configure the system security settings, such as system password, setup password, Trusted Platform Module (TPM) security, and UEFI secure boot. It also manages the power button on the system.
Redundant OS Control	Sets the redundant OS information for redundant OS control.
Miscellaneous Settings	Provides options to change the system date and time.

System Information

You can use the **System Information** screen to view system properties such as Service Tag, system model name, and BIOS version.

Viewing System Information

To view the **System Information** screen, perform the following steps:

- 1 Power on, or restart your system.
- 2 Press F2 immediately after you see the following message:

- 3 On the **System Setup Main Menu** screen, click **System BIOS**.
- 4 On the **System BIOS** screen, click **System Information**.

NOTE: If your operating system begins to load before you press F2, wait for the system to finish booting, and then restart your system and try again.

System Information details

The **System Information** screen details are explained as follows:

Option	Description
System Model Name	Specifies the system model name.
System BIOS Version	Specifies the BIOS version installed on the system.
System Management Engine Version	Specifies the current version of the Management Engine firmware.
System Service Tag	Specifies the system Service Tag.

Option	Description
System Manufacturer	Specifies the name of the system manufacturer.
System Manufacturer Contact Information	Specifies the contact information of the system manufacturer.
System CPLD Version	Specifies the current version of the system complex programmable logic device (CPLD) firmware.
UEFI Compliance Version	Specifies the UEFI compliance level of the system firmware.

Memory Settings

You can use the **Memory Settings** screen to view all the memory settings and enable or disable specific memory functions, such as system memory testing and node interleaving.

Viewing Memory Settings

To view the **Memory Settings** screen, perform the following steps:

- 1 Power on, or restart your system.
- 2 Press F2 immediately after you see the following message:

F2 = System Setup

NOTE: If the operating system begins to load before you press F2, wait for the system to finish booting, and then restart the system and try again.

- 3 On the **System Setup Main Menu** screen, click **System BIOS**.
- 4 On the **System BIOS** screen, click **Memory Settings**.

Memory Settings details

The **Memory Settings** screen details are explained as follows:

Option	Description
System Memory Size	Specifies the memory size in the system.
System Memory Type	Specifies the type of memory installed in the system.
System Memory Speed	Specifies the system memory speed.
System Memory Voltage	Specifies the system memory voltage.
Video Memory	Specifies the amount of video memory.
System Memory Testing	Specifies whether the system memory tests are run during system boot. Options are Enabled and Disabled . This option is set to Disabled by default.
Memory Operating Mode	Specifies the memory operating mode. The options available are Optimizer Mode , Single Rank Spare Mode , Multi Rank Spare Mode , Mirror Mode , and Dell Fault Resilient Mode . This option is set to Optimizer Mode by default.

Option	Description
	<p>NOTE: The Memory Operating Mode option can have different default and available options based on the memory configuration of your system.</p> <p>NOTE: The Dell Fault Resilient Mode option establishes an area of memory that is fault resilient. This mode can be used by an operating system that supports the feature to load critical applications or enables the operating system kernel to maximize system availability.</p>
Current State of Memory Operating Mode	Specifies the current state of the memory operating mode.
Node Interleaving	Specifies if Non-Uniform Memory Architecture (NUMA) is supported. If this field is set to Enabled , memory interleaving is supported if a symmetric memory configuration is installed. If this field is set to Disabled , the system supports NUMA (asymmetric) memory configurations. This option is set to Disabled by default.
Opportunistic Self-Refresh	Enables or disables opportunistic self-refresh feature. This option is set to Disabled by default.
Persistent Memory	This field controls Persistent Memory on the system.
Persistent Memory	This field controls Persistent Memory on the system.

Persistent Memory details

The **Persistent Memory** screen details can be found in the *NVDIMM-N User Guide* at For additional information about environmental certifications, please refer to the Product Environmental Datasheet located with the Manuals & Documents on [Dell.com/poweredgemanuals](https://www.dell.com/poweredge/manuals).

Processor Settings

You can use the **Processor Settings** screen to view the processor settings and perform specific functions such as enabling virtualization technology, hardware prefetcher, logical processor idling, and opportunistic self-refresh.

Viewing Processor Settings

To view the **Processor Settings** screen, perform the following steps:



- 1 Power on, or restart your system.
- 2 Press F2 immediately after you see the following message:

```
F2 = System Setup
```

NOTE: If your operating system begins to load before you press F2, wait for the system to finish booting, and then restart your system and try again.
- 3 On the **System Setup Main Menu** screen, click **System BIOS**.
- 4 On the **System BIOS** screen, click **Processor Settings**.

Processor Settings details

The **Processor Settings** screen details are explained as follows:

Option	Description
Logical Processor	Enables or disables the logical processors and displays the number of logical processors. If this option is set to Enabled , the BIOS displays all the logical processors. If this option is set to Disabled , the BIOS displays only one logical processor per core. This option is set to Enabled by default.
CPU Interconnect Speed	<p>Enables you to govern the frequency of the communication links among the processors in the system.</p> <p> NOTE: The standard and basic bin processors support lower link frequencies.</p> <p>The options available are Maximum data rate, 10.4 GT/s, and 9.6 GT/s. This option is set to Maximum data rate by default.</p> <p>Maximum data rate indicates that the BIOS runs the communication links at the maximum frequency supported by the processors. You can also select specific frequencies that the processors support, which can vary.</p> <p>For best performance, you should select Maximum data rate. Any reduction in the communication link frequency affects the performance of non-local memory accesses and cache coherency traffic. In addition, it can slow access to non-local I/O devices from a particular processor.</p> <p>However, if power saving considerations outweigh performance, you might want to reduce the frequency of the processor communication links. If you do this, you should localize memory and I/O accesses to the nearest NUMA node to minimize the impact to system performance.</p>
Virtualization Technology	Enables or disables the virtualization technology for the processor. This option is set to Enabled by default.
Adjacent Cache Line Prefetch	Optimizes the system for applications that need high utilization of sequential memory access. This option is set to Enabled by default. You can disable this option for applications that need high utilization of random memory access.
Hardware Prefetcher	Enables or disables the hardware prefetcher. This option is set to Enabled by default.
DCU Streamer Prefetcher	Enables or disables the Data Cache Unit (DCU) streamer prefetcher. This option is set to Enabled by default.
DCU IP Prefetcher	Enables or disables the Data Cache Unit (DCU) IP prefetcher. This option is set to Enabled by default.
Sub NUMA Cluster	Enables or disables the Sub NUMA Cluster. This option is set to Disabled by default.
Sub NUMA Cluster	Enables or disables the Sub NUMA Cluster. This option is set to Disabled by default.
UPI Prefetch	Enables you to get the memory read started early on DDR bus. The Ultra Path Interconnect (UPI) Rx path will spawn the speculative memory read to Integrated Memory Controller (iMC) directly. This option is set to Enabled by default.
Logical Processor Idling	Enables you to improve the energy efficiency of a system. It uses the operating system core parking algorithm and parks some of the logical processors in the system which in turn allows the corresponding processor cores to transition into a lower power idle state. This option can only be enabled if the operating system supports it. It is set to Disabled by default.
x2APIC Mode	Enables or disables the x2APIC mode. This option is set to Disabled by default.
Dell Controlled Turbo	<p>Controls the turbo engagement. Enable this option only when System Profile is set to Disabled.</p> <p> NOTE: Depending on the number of installed processors, there might be up to four processor listings.</p>
Number of Cores per Processor	Controls the number of enabled cores in each processor. This option is set to All by default.
Processor Core Speed	Specifies the maximum core frequency of the processor.

Option	Description
Processor n	 NOTE: Depending on the number of processors, there might be up to four processors listed.

The following settings are displayed for each processor installed in the system:

Option	Description
Family-Model-Stepping	Specifies the family, model, and stepping of the processor as defined by Intel.
Brand	Specifies the brand name.
Level 2 Cache	Specifies the total L2 cache.
Level 3 Cache	Specifies the total L3 cache.
Number of Cores	Specifies the number of cores per processor.

SATA Settings

You can use the **SATA Settings** screen to view the settings of SATA devices and enable SATA and PCIe NVMe RAID mode on your system.

Viewing SATA Settings

To view the **SATA Settings** screen, perform the following steps:

- 1 Power on, or restart your system.
- 2 Press F2 immediately after you see the following message:

F2 = System Setup

 **NOTE:** If your operating system begins to load before you press F2, wait for the system to finish booting, and then restart your system and try again.

- 3 On the **System Setup Main Menu** screen, click **System BIOS**.
- 4 On the **System BIOS** screen, click **SATA Settings**.

SATA Settings details

The **SATA Settings** screen details are explained as follows:

Option	Description
Embedded SATA	Enables you to set the embedded SATA option to Off , AHCI , or RAID modes. This option is set to AHCI Mode by default.
Security Freeze Lock	Enables you to send Security Freeze Lock command to the embedded SATA drives during POST. This option is applicable only for AHCI mode. This option is set to Enabled by default.
Write Cache	Enables or disables the command for the embedded SATA drives during POST. This option is set to Disabled by default.
Port n	Enables you to set the drive type of the selected device. For AHCI Mode or RAID Mode , BIOS support is always enabled.
Option	Description
Model	Specifies the drive model of the selected device.

Option	Description
Option	Description
Drive Type	Specifies the type of drive attached to the SATA port.
Capacity	Specifies the total capacity of the drive. This field is undefined for removable media devices such as optical drives.

Boot Settings

You can use the **Boot Settings** screen to set the boot mode to either **BIOS** or **UEFI**. It also enables you to specify the boot order.

- **UEFI:** The Unified Extensible Firmware Interface (UEFI) is a new interface between operating systems and platform firmware. The interface consists of data tables with platform related information, boot and runtime service calls that are available to the operating system and its loader. The following benefits are available when the **Boot Mode** is set to **UEFI**:
 - Support for drive partitions larger than 2 TB.
 - Enhanced security (e.g., UEFI Secure Boot).
 - Faster boot time.

NOTE: You must use only the UEFI boot mode in order to boot from NVMe drives.

- **BIOS:** The **BIOS Boot Mode** is the legacy boot mode. It is maintained for backward compatibility.

Viewing Boot Settings

To view the **Boot Settings** screen, perform the following steps:

- 1 Power on, or restart your system.
- 2 Press F2 immediately after you see the following message:

F2 = System Setup



NOTE: If your operating system begins to load before you press F2, wait for the system to finish booting, and then restart your system and try again.

- 3 On the **System Setup Main Menu** screen, click **System BIOS**.
- 4 On the **System BIOS** screen, click **Boot Settings**.

Boot Settings details

The **Boot Settings** screen details are explained as follows:

Option	Description
Boot Mode	<p>Enables you to set the boot mode of the system.</p> <p>CAUTION: Switching the boot mode may prevent the system from booting if the operating system is not installed in the same boot mode.</p> <p>If the operating system supports UEFI, you can set this option to UEFI. Setting this field to BIOS allows compatibility with non-UEFI operating systems. This option is set to UEFI by default.</p> <p>NOTE: Setting this field to UEFI disables the BIOS Boot Settings menu.</p>
Boot Sequence Retry	Enables or disables the Boot Sequence Retry feature. If this option is set to Enabled and the system fails to boot, the system re-attempts the boot sequence after 30 seconds. This option is set to Enabled by default.

Option	Description
Hard-Disk Failover	Specifies the drive that is booted in the event of a drive failure. The devices are selected in the Hard-Disk Drive Sequence on the Boot Option Setting menu. When this option is set to Disabled , only the first drive in the list is attempted to boot. When this option is set to Enabled , all drives are attempted to boot in the order selected in the Hard-Disk Drive Sequence . This option is not enabled for UEFI Boot Mode . This option is set to Disabled by default.
Boot Option Settings	Enables you to configure the boot sequence and the boot devices.
BIOS Boot Settings	Enables or disables BIOS boot options.  NOTE: This option is enabled only if the boot mode is BIOS.
UEFI Boot Settings	Enables or disables UEFI Boot options.  NOTE: This option is enabled only if the boot mode is UEFI.

Choosing system boot mode

System Setup enables you to specify one of the following boot modes for installing your operating system:

- BIOS boot mode is the standard BIOS-level boot interface.
- UEFI boot mode (the default), is an enhanced 64-bit boot interface.

- 1 From the **System Setup Main Menu**, click **Boot Settings**, and select **Boot Mode**.
- 2 Select the UEFI boot mode you want the system to boot into.

 **CAUTION:** Switching the boot mode may prevent the system from booting if the operating system is not installed in the same boot mode.

- 3 After the system boots in the specified boot mode, proceed to install your operating system from that mode.

 **NOTE:** Operating systems must be UEFI-compatible to be installed from the UEFI boot mode. DOS and 32-bit operating systems do not support UEFI and can only be installed from the BIOS boot mode.

 **NOTE:** For the latest information about supported operating systems, go to Dell.com/ossupport

Changing boot order

About this task

You may have to change the boot order if you want to boot from a USB key or an optical drive. The following instructions may vary if you have selected **BIOS** for **Boot Mode**.

Steps

- 1 On the **System Setup Main Menu** screen, click **System BIOS > Boot Settings > UEFI/BIOS Boot Settings > UEFI/BIOS Boot Sequence**.
- 2 Use the arrow keys to select a boot device, and use the plus (+) and minus (-) sign keys to move the device down or up in the order.
- 3 Click **Exit**, and then click **Yes** to save the settings on exit.

Network Settings

You can use the **Network Settings** screen to modify UEFI PXE, iSCSI, and HTTP boot settings. The network settings option is available only in the UEFI mode.

NOTE: BIOS does not control network settings in the BIOS mode. For the BIOS boot mode, the option ROM of the network controllers handles the network settings.

Viewing Network Settings

To view the **Network Settings** screen, perform the following steps:

- 1 Power on, or restart your system.
- 2 Press F2 immediately after you see the following message:
F2 = System Setup

NOTE: If your operating system begins to load before you press F2, wait for the system to finish booting, and then restart your system and try again.

- 3 On the **System Setup Main Menu** screen, click **System BIOS**.
- 4 On the **System BIOS** screen, click **Network Settings**.

Network Settings screen details

The **Network Settings** screen details are explained as follows:

Option	Description
PXE Device n (n = 1 to 4)	Enables or disables the device. When enabled, a UEFI PXE boot option is created for the device.
PXE Device n Settings (n = 1 to 4)	Enables you to control the configuration of the PXE device.
HTTP Device n (n = 1 to 4)	Enables or disables the device. When enabled, a UEFI HTTP boot option is created for the device.
HTTP Device n Settings (n = 1 to 4)	Enables you to control the configuration of the HTTP device.

UEFI iSCSI Settings

You can use the iSCSI Settings screen to modify iSCSI device settings. The iSCSI Settings option is available only in the UEFI boot mode. BIOS does not control network settings in the BIOS boot mode. For the BIOS boot mode, the option ROM of the network controller handles the network settings.

Viewing UEFI iSCSI Settings

To view the **UEFI iSCSI Settings** screen, perform the following steps:

- 1 Power on, or restart your system.
- 2 Press F2 immediately after you see the following message:
F2 = System Setup

NOTE: If your operating system begins to load before you press F2, wait for the system to finish booting, and then restart your system and try again.

- 3 On the **System Setup Main Menu** screen, click **System BIOS**.
- 4 On the **System BIOS** screen, click **Network Settings**.
- 5 On the **Network Settings** screen, click **UEFI iSCSI Settings**.

UEFI iSCSI Settings details

The **UEFI iSCSI Settings** screen details are explained as follows:

Option	Description
iSCSI Initiator Name	Specifies the name of the iSCSI initiator (iqn format).
iSCSI Device1	Enables or disables the iSCSI device. When disabled, a UEFI boot option is created for the iSCSI device automatically.
iSCSI Device1 Settings	Enables you to control the configuration of the iSCSI device.

Integrated Devices

You can use the **Integrated Devices** screen to view and configure the settings of all integrated devices including the video controller, integrated RAID controller, and the USB ports.

Viewing Integrated Devices

To view the **Integrated Devices** screen, perform the following steps:

- 1 Power on, or restart your system.
- 2 Press F2 immediately after you see the following message:

```
F2 = System Setup
```



NOTE: If your operating system begins to load before you press F2, wait for the system to finish booting, and then restart your system and try again.

- 3 On the **System Setup Main Menu** screen, click **System BIOS**.
- 4 On the **System BIOS** screen, click **Integrated Devices**.

Integrated Devices details

The **Integrated Devices** screen details are explained as follows:

Option	Description
User Accessible USB Ports	<p>Configures the user accessible USB ports. Selecting Only Back Ports On disables the front USB ports; selecting All Ports Off disables all front and back USB ports; selecting All Ports Off (Dynamic) All Ports On disables all front and back USB ports during POST and front ports can be enabled or disabled dynamically by an authorized user or authorized users without resetting the system.</p> <p>The USB keyboard and mouse function in certain USB ports during the boot process, depending on the selection. After the boot process is complete, the USB ports will be enabled or disabled as per the setting.</p>
Internal USB Port	Enables or disables the internal USB port. This option is set to Enabled by default.

Option	Description
Integrated RAID Controller	Enables or disables the integrated RAID controller. This option is set to Enabled by default.
Integrated Network Card 1	Enables or disables the integrated network card (NDC). When set to Disabled , the NDC is not available to the operating system (OS). This option is set to Enable by default.  NOTE: If set to Disabled (OS), the Integrated NICs might still be available for shared network access by iDRAC.
I/OAT DMA Engine	Enables or disables the I/O Acceleration Technology (I/OAT) option. I/OAT is a set of DMA features designed to accelerate network traffic and lower CPU utilization. Enable only if the hardware and software support the feature.
Embedded Video Controller	Enables or disables the use of Embedded Video Controller as the primary display. When set to Enabled , the Embedded Video Controller is used as the primary display even if add-in graphic cards are installed. When set to Disabled , an add-in graphics card is used as the primary display. BIOS will output displays to both the primary add-in video and the embedded video during POST and pre-boot environment. The embedded video is disabled before the operating system boots. This option is set to Enabled by default.  NOTE: When there are multiple add-in graphic cards installed in the system, the first card discovered during PCI enumeration is selected as the primary video. You might have to re-arrange the cards in the slots in order to control which card is the primary video.
Current State of Embedded Video Controller	Displays the current state of the embedded video controller. The Current State of Embedded Video Controller option is a read-only field. If the Embedded Video Controller is the only display capability in the system (that is, no add-in graphics card is installed), then the Embedded Video Controller is automatically used as the primary display even if the Embedded Video Controller setting is set to Enabled .
SR-IOV Global Enable	Enables or disables the BIOS configuration of Single Root I/O Virtualization (SR-IOV) devices. This option is set to Disabled by default.
Internal MicroSD Card Port	Enables or disables the internal SD card port of the Internal Dual SD Module (IDSMD). This option is set to On by default.
Internal MicroSD Card Redundancy	Configures the redundancy mode of the Internal Dual SD Module (IDSMD). When set to Mirror Mode , data is written on both SD cards. After failure of either card and replacement of the failed card, the data of the active card is copied to the offline card during the system boot. When Internal SD Card Redundancy is set to Disabled , only the primary SD card is visible to the OS. This option is set to Disabled by default.
Internal microSD Primary Card	When you set Redundancy to Disabled , you can select one of the SD cards as the primary card that functions as a mass storage device. By default, the primary SD card is selected to be SD Card 1. If MicroSD Card 1 is not present, then the controller selects MicroSD Card 2 to be the primary SD card.
OS Watchdog Timer	If your system stops responding, this watchdog timer aids in the recovery of your operating system. When this option is set to Enabled , the operating system initializes the timer. When this option is set to Disabled (the default), the timer does not have any effect on the system.
Memory Mapped I/O above 4 GB	Enables or disables the support for the PCIe devices that need large amounts of memory. Enable this option only for 64-bit operating systems. This option is set to Enabled by default.
Memory Mapped I/O above Base	When set to 12 TB , the system maps the MMIO base to 12 TB. Enable this option for an OS that requires 44 bit PCIe addressing. When set to 512 GB , the system maps the MMIO base to 512 GB, and reduces the maximum support for memory to less than 512 GB. Enable this option only for the 4 GPU DGMA issue. This option is set to 56 TB by default.
Slot Disablement	Enables or disables the available PCIe slots on your system. The slot disablement feature controls the configuration of the PCIe cards installed in the specified slot. Slots must be disabled only when the installed peripheral card prevents booting into the operating system or causes delays in system startup. If the slot is disabled, both the Option ROM and UEFI drivers are disabled. Only slots that are present on the system are available for control.

Option

Description

Table 39. Slot Disablement

Option	Description
Slot 1	Enables or disables the PCIe slot 1. This option is set to Enabled by default.
Slot 3	Enables or disables or only the boot driver is disabled for the PCIe slot 3. This option is set to Enabled by default.
Slot 4	Enables or disables or only the boot driver is disabled for the PCIe slot 4. This option is set to Enabled by default.
Slot 5	Enables or disables or only the boot driver is disabled for the PCIe slot 5. This option is set to Enabled by default.
Slot 6	Enables or disables or only the boot driver is disabled for the PCIe slot 6. This option is set to Enabled by default.

Slot Bifurcation

Allows **Platform Default Bifurcation**, **Auto discovery of Bifurcation** and **Manual bifurcation Control**. The default is set to **Platform Default Bifurcation**. The slot bifurcation field is accessible when set to **Manual bifurcation Control** and is disabled when set to **Platform Default Bifurcation** or **Auto discovery of Bifurcation**.

 **NOTE:** Slot Bifurcation options vary depend on the Riser configurations.

Table 40. Slot Bifurcation

Option	Description
Slot 1 Bifurcation	x16 or x8 or x4 or x4x4x8 or x8x4x4 Bifurcation
Slot 3 Bifurcation	x16 or x8 or x4 or x4x4x8 or x8x4x4 Bifurcation
Slot 4 Bifurcation	x16 or x8 or x4 or x4x4x8 or x8x4x4 Bifurcation
Slot 5 Bifurcation	x4 or x8 Bifurcation
Slot 6 Bifurcation	x8 or x4 Bifurcation

Serial Communication

You can use the **Serial Communication** screen to view the properties of the serial communication port.

Viewing Serial Communication

To view the **Serial Communication** screen, perform the following steps:

- 1 Power on, or restart your system.
- 2 Press F2 immediately after you see the following message:
`F2 = System Setup`
- 3 On the **System Setup Main Menu** screen, click **System BIOS**.
- 4 On the **System BIOS** screen, click **Serial Communication**.

NOTE: If your operating system begins to load before you press F2, wait for the system to finish booting, and then restart your system and try again.

Serial Communication details

The **Serial Communication** screen details are explained as follows:

Option	Description
Serial Communication	Enables you to select serial communication devices (Serial Device 1 and Serial Device 2) in BIOS. BIOS console redirection can also be enabled, and the port address can be specified. This option is set to Auto by default.
Serial Port Address	Enables you to set the port address for serial devices. This field sets the serial port address to either COM1 or COM2 (COM1=0x3F8, COM2=0x2F8). This option is set to Serial Device1=COM2 or Serial Device 2=COM1 by default. NOTE: You can use only Serial Device 2 for the Serial Over LAN (SOL) feature. To use console redirection by SOL, configure the same port address for console redirection and the serial device. NOTE: Every time the system boots, the BIOS syncs the serial MUX setting saved in iDRAC. The serial MUX setting can independently be changed in iDRAC. Loading the BIOS default settings from within the BIOS setup utility may not always revert the serial MUX setting to the default setting of Serial Device 1.
External Serial Connector	Enables you to associate the External Serial Connector to Serial Device 1 , Serial Device 2 , or the Remote Access Device by using this option. This option is set to Serial Device 1 by default. NOTE: Only Serial Device 2 can be used for Serial Over LAN (SOL). To use console redirection by SOL, configure the same port address for console redirection and the serial device. NOTE: Every time the system boots, the BIOS syncs the serial MUX setting saved in iDRAC. The serial MUX setting can independently be changed in iDRAC. Loading the BIOS default settings from within the BIOS setup utility may not always revert this setting to the default setting of Serial Device 1.
Failsafe Baud Rate	Specifies the failsafe baud rate for console redirection. The BIOS attempts to determine the baud rate automatically. This failsafe baud rate is used only if the attempt fails, and the value must not be changed. This option is set to 115200 by default.
Remote Terminal Type	Enables you to set the remote console terminal type. This option is set to VT100/VT220 by default.
Redirection After Boot	Enables or disables the BIOS console redirection when the operating system is loaded. This option is set to Enabled by default.

System Profile Settings

You can use the **System Profile Settings** screen to enable specific system performance settings such as power management.

Viewing System Profile Settings

To view the **System Profile Settings** screen, perform the following steps:

- 1 Power on, or restart your system.
- 2 Press F2 immediately after you see the following message:

F2 = System Setup

NOTE: If your operating system begins to load before you press F2, wait for the system to finish booting, and then restart your system and try again.

- 3 On the **System Setup Main Menu** screen, click **System BIOS**.
- 4 On the **System BIOS** screen, click **System Profile Settings**.

System Profile Settings details

The **System Profile Settings** screen details are explained as follows:

Option	Description
System Profile	Sets the system profile. If you set the System Profile option to a mode other than Custom , the BIOS automatically sets the rest of the options. You can only change the rest of the options if the mode is set to Custom . This option is set to Performance Per Watt Optimized (DAPC) by default. DAPC is Dell Active Power Controller. NOTE: All the parameters on the system profile setting screen are available only when the System Profile option is set to Custom.
CPU Power Management	Sets the CPU power management. This option is set to System DBPM (DAPC) by default. DBPM is Demand-Based Power Management.
Memory Frequency	Sets the speed of the system memory. You can select Maximum Performance , Maximum Reliability , or a specific speed. This option is set to Maximum Performance by default.
Turbo Boost	Enables or disables the processor to operate in the turbo boost mode. This option is set to Enabled by default.
C1E	Enables or disables the processor to switch to a minimum performance state when it is idle. This option is set to Enabled by default.
C States	Enables or disables the processor to operate in all available power states. This option is set to Disabled by default for performance profile and is set to Enabled by default for all other profiles.
Write Data CRC	Enables or disables the Write Data CRC. This option is set to Enabled by default.
Memory Patrol Scrub	Sets the memory patrol scrub frequency. This option is set to Standard by default.
Memory Refresh Rate	Sets the memory refresh rate to either 1x or 2x. This option is set to 1x by default.
Uncore Frequency	Enables you to select the Processor Uncore Frequency option. Dynamic mode enables the processor to optimize power resources across cores and uncores during runtime. The optimization of the uncore frequency to either save power or optimize performance is influenced by the setting of the Energy Efficiency Policy option.

Option	Description
Energy Efficient Policy	Enables you to select the Energy Efficient Policy option. The CPU uses the setting to manipulate the internal behavior of the processor and determines whether to target higher performance or better power savings. This option is set to Balanced Performance by default.
Number of Turbo Boost Enabled Cores for Processor 1	i NOTE: If there are two processors installed in the system, you will see an entry for Number of Turbo Boost Enabled Cores for Processor 2. Controls the number of turbo boost enabled cores for Processor 1. The maximum number of cores is enabled by default.
Monitor/Mwait	Enables the Monitor/Mwait instructions in the processor. This option is set to Enabled for all system profiles, except Custom by default. i NOTE: This option can be disabled only if the C States option in the Custom mode is set to disabled. i NOTE: When C States is set to Enabled in the Custom mode, changing the Monitor/Mwait setting does not impact the system power or performance.
CPU Interconnect Bus Link Power Management	Enables or disables the CPU Interconnect Bus Link Power Management. This option is set to Enabled by default.
PCI ASPM L1 Link Power Management	Enables or disables the PCI ASPM L1 Link Power Management. This option is set to Enabled by default.

System Security

You can use the **System Security** screen to perform specific functions such as setting the system password, setup password and disabling the power button.

Viewing System Security

To view the **System Security** screen, perform the following steps:



- 1 Power on, or restart your system.
- 2 Press F2 immediately after you see the following message:
F2 = System Setup
- 3 On the **System Setup Main Menu** screen, click **System BIOS**.
- 4 On the **System BIOS** screen, click **System Security**.

i **NOTE: If your operating system begins to load before you press F2, wait for the system to finish booting, and then restart your system and try again.**

System Security Settings details

The **System Security Settings** screen details are explained as follows:

Option	Description
In-Band Manageability Interface	When set to Disabled , this setting will hide the Management Engine's (ME), HECI devices, and the system's IPMI devices from the operating system. This prevents the operating system from changing the ME power capping settings, and blocks access to all in-band management tools. All management should be managed through out-of-band. This option is set to Enabled by default.

Option	Description
	<p> NOTE: BIOS update requires HECI devices to be operational and DUP updates require IPMI interface to be operational. This setting needs to be set to Enabled to avoid updating errors.</p>
Intel(R) AES-NI	Improves the speed of applications by performing encryption and decryption by using the Advanced Encryption Standard Instruction Set (AES-NI). This option is set to Enabled by default.
System Password	Enables you to set the system password. This option is set to Enabled by default and is read-only if the password jumper is not installed in the system.
Setup Password	Enables you to set the system setup password. This option is read-only if the password jumper is not installed in the system.
Password Status	Enables you to lock the system password. This option is set to Unlocked by default.
TPM Security	<p> NOTE: The TPM menu is available only when the TPM module is installed.</p> <p>Enables you to control the reporting mode of the TPM. The TPM Security option is set to Off by default. You can only modify the TPM Status TPM Activation, and the Intel TXT fields if the TPM Status field is set to either On with Pre-boot Measurements or On without Pre-boot Measurements.</p> <p>When TPM 1.2 is installed, the TPM Security option is set to Off, On with Pre-boot Measurements, or On without Pre-boot Measurements.</p> <p>When TPM 2.0 is installed, the TPM Security option is set to On or Off. This option is set to Off by default.</p>
TPM Information	Enables you to change the operational state of the TPM. This option is set to No Change by default.
TPM Status	Specifies the TPM status.
TPM Command	<p>Controls the Trusted Platform Module (TPM). When set to None, no command is sent to the TPM. When set to Activate, the TPM is enabled and activated. When set to Deactivate, the TPM is disabled and deactivated. When set to Clear, all the contents of the TPM are cleared. This option is set to None by default.</p> <p> CAUTION: Clearing the TPM results in the loss of all keys in the TPM. The loss of TPM keys may affect booting to the operating system.</p> <p>This field is read-only when TPM Security is set to Off. The action requires an additional reboot before it can take effect.</p>
Intel(R) TXT	<p>Enables you to set the Intel Trusted Execution Technology (TXT) option. To enable the Intel TXT option, virtualization technology and TPM Security must be enabled with Pre-boot measurements. This option is set to Off by default.</p> <p>When TPM 2.0 is installed, TPM 2 Algorithm option is available. It enables you to select a hash algorithm from those supported by the TPM (SHA1, SHA256). TPM 2 Algorithm option must be set to SHA256, to enable TXT.</p>
Power Button	Enables you to set the power button on the front of the system. This option is set to Enabled by default.
AC Power Recovery	Sets how the system behaves after AC power is restored to the system. This option is set to Last by default.
AC Power Recovery Delay	Enables you to set the time that the system should take to power up after AC power is restored to the system. This option is set to Immediate by default.
User Defined Delay (60 s to 240 s)	Enables you to set the User Defined Delay option when the User Defined option for AC Power Recovery Delay is selected.
UEFI Variable Access	Provides varying degrees of securing UEFI variables. When set to Standard (the default), UEFI variables are accessible in the operating system per the UEFI specification. When set to Controlled , selected UEFI variables are protected in the environment, and new UEFI boot entries are forced to be at the end of the current boot order.
Secure Boot	Enables Secure Boot, where the BIOS authenticates each pre-boot image by using the certificates in the Secure Boot Policy. Secure Boot is set to Disabled by default.

Option	Description								
Secure Boot Policy	When Secure Boot policy is set to Standard , the BIOS uses the system manufacturer key and certificates to authenticate pre-boot images. When Secure Boot policy is set to Custom , the BIOS uses the user-defined key and certificates. Secure Boot policy is set to Standard by default.								
Secure Boot Mode	Enables you to configure how the BIOS uses the Secure Boot Policy Objects (PK, KEK, db, dbx). If the current mode is set to Deployed Mode , the available options are User Mode and Deployed Mode . If the current mode is set to User Mode , the available options are User Mode , Audit Mode , and Deployed Mode .								
	<table border="1"> <thead> <tr> <th>Options</th> <th>Description</th> </tr> </thead> <tbody> <tr> <td>User Mode</td> <td>In User Mode, PK must be installed, and BIOS performs signature verification on programmatic attempts to update policy objects. BIOS allows unauthenticated programmatic transitions between modes.</td> </tr> <tr> <td>Audit Mode</td> <td>In Audit mode, PK is not present. BIOS does not authenticate programmatic updates to the policy objects, and transitions between modes. Audit Mode is useful for programmatically determining a working set of policy objects. BIOS performs signature verification on pre-boot images and logs the results in the image Execution Information Table, but approves the images whether they pass or fail verification.</td> </tr> <tr> <td>Deployed Mode</td> <td>Deployed Mode is the most secure mode. In Deployed Mode, PK must be installed and the BIOS performs signature verification on programmatic attempts to update policy objects. Deployed Mode restricts the programmatic mode transitions.</td> </tr> </tbody> </table>	Options	Description	User Mode	In User Mode , PK must be installed, and BIOS performs signature verification on programmatic attempts to update policy objects. BIOS allows unauthenticated programmatic transitions between modes.	Audit Mode	In Audit mode , PK is not present. BIOS does not authenticate programmatic updates to the policy objects, and transitions between modes. Audit Mode is useful for programmatically determining a working set of policy objects. BIOS performs signature verification on pre-boot images and logs the results in the image Execution Information Table, but approves the images whether they pass or fail verification.	Deployed Mode	Deployed Mode is the most secure mode. In Deployed Mode , PK must be installed and the BIOS performs signature verification on programmatic attempts to update policy objects. Deployed Mode restricts the programmatic mode transitions.
Options	Description								
User Mode	In User Mode , PK must be installed, and BIOS performs signature verification on programmatic attempts to update policy objects. BIOS allows unauthenticated programmatic transitions between modes.								
Audit Mode	In Audit mode , PK is not present. BIOS does not authenticate programmatic updates to the policy objects, and transitions between modes. Audit Mode is useful for programmatically determining a working set of policy objects. BIOS performs signature verification on pre-boot images and logs the results in the image Execution Information Table, but approves the images whether they pass or fail verification.								
Deployed Mode	Deployed Mode is the most secure mode. In Deployed Mode , PK must be installed and the BIOS performs signature verification on programmatic attempts to update policy objects. Deployed Mode restricts the programmatic mode transitions.								
Secure Boot Policy Summary	Specifies the list of certificates and hashes that secure boot uses to authenticate images.								
Secure Boot Custom Policy Settings	Configures the Secure Boot Custom Policy. To enable this option, set the Secure Boot Policy to Custom .								

Creating a system and setup password

Prerequisite

Ensure that the password jumper is enabled. The password jumper enables or disables the system password and setup password features. For more information, see the System board jumper settings section.

NOTE: If the password jumper setting is disabled, the existing system password and setup password are deleted and you need not provide the system password to boot the system.

Steps

- To enter System Setup, press F2 immediately after turning on or rebooting your system.
- On the **System Setup Main Menu** screen, click **System BIOS > System Security**.
- On the **System Security** screen, verify that **Password Status** is set to **Unlocked**.
- In the **System Password** field, type your system password, and press Enter or Tab.
A message prompts you to reenter the system password.

- 5 Reenter the system password, and click **OK**.
- 6 In the **Setup Password** field, type your setup password and press Enter or Tab.
A message prompts you to reenter the setup password.
- 7 Reenter the setup password, and click **OK**.
- 8 Press Esc to return to the System BIOS screen. Press Esc again.
A message prompts you to save the changes.

NOTE: Password protection does not take effect until the system reboots.

Using your system password to secure the system

About this task

If you have assigned a setup password, the system accepts your setup password as an alternate system password.

Steps

- 1 Power on or reboot your system.
- 2 Type the system password and press Enter.

Next step

When **Password Status** is set to **Locked**, type the system password and press Enter when prompted at reboot.

NOTE: If an incorrect system password is typed, the system displays a message and prompts you to reenter your password. You have three attempts to type the correct password. After the third unsuccessful attempt, the system displays an error message that the system has stopped functioning and must be turned off. Even after you turn off and restart the system, the error message is displayed until the correct password is entered.

Deleting or changing system and setup password

Prerequisite

NOTE: You cannot delete or change an existing system or setup password if the **Password Status** is set to **Locked**.

Steps

- 1 To enter System Setup, press F2 immediately after turning on or restarting your system.
- 2 On the **System Setup Main Menu** screen, click **System BIOS > System Security**.
- 3 On the **System Security** screen, ensure that **Password Status** is set to **Unlocked**.
- 4 In the **System Password** field, change or delete the existing system password, and then press Enter or Tab.
- 5 In the **Setup Password** field, alter or delete the existing setup password, and then press Enter or Tab.

NOTE: If you change the system password or setup password, a message prompts you to reenter the new password. If you delete the system password or setup password, a message prompts you to confirm the deletion.

- 6 Press Esc to return to the **System BIOS** screen. Press Esc again, and a message prompts you to save the changes.

Operating with setup password enabled

If **Setup Password** is set to **Enabled**, type the correct setup password before modifying the system setup options.

If you do not type the correct password in three attempts, the system displays the following message:

```
Invalid Password! Number of unsuccessful password attempts: <x> System Halted! Must power down.
```

Even after you restart the system, the error message is displayed until the correct password is typed. The following options are exceptions:

- If **System Password** is not set to **Enabled** and is not locked through the **Password Status** option, you can assign a system password. For more information, see the [System Security Settings details](#) section.
- You cannot disable or change an existing system password.

NOTE: You can use the password status option with the setup password option to protect the system password from unauthorized changes.

Redundant OS Control

In the **Redundant OS Control** screen you can set the redundant OS information. This enables you to set up a physical recovery disk on the system.

Viewing Redundant OS Control

To view the **Redundant OS Control** screen, perform the following steps:

- 1 Power on, or restart your system.
- 2 Press F2 immediately after you see the following message:
F2 = System Setup

NOTE: If your operating system begins to load before you press F2, wait for the system to finish booting, and then restart your system and try again.

- 3 On the **System Setup Main Menu** screen, click **System BIOS**.
- 4 On the **System BIOS** screen, click **Redundant OS Control**.

Redundant OS Control screen details

The **Redundant OS Control** screen details are explained as follows:

Option	Description
Redundant OS Location	<p>Enables you to select a backup disk from the following devices:</p> <ul style="list-style-type: none"> • None • IDSDM • SATA Ports in AHCI mode • BOSS PCIe Cards (Internal M.2 Drives) • Internal USB <p>NOTE: RAID configurations and NVMe cards not are included as BIOS does not have the ability to distinguish between individual drives in those configurations.</p>
Redundant OS State	<p>NOTE: This option is disabled if Redundant OS Location is set to None.</p> <p>When set to Visible, the backup disk is visible to the boot list and OS. When set to Hidden, the backup disk is disabled and is not visible to the boot list and OS. This option is set to Visible by default.</p> <p>NOTE: BIOS will disable the device in hardware, so it cannot be accessed by the OS.</p>
Redundant OS Boot	<p>NOTE: This option is disabled if Redundant OS Location is set to None or if Redundant OS State is set to Hidden.</p> <p>When set to Enabled, BIOS boots to the device specified in Redundant OS Location. When set to Disabled, BIOS preserves the current boot list settings. This option is set to Enabled by default.</p>

Miscellaneous Settings

You can use the **Miscellaneous Settings** screen to perform specific functions such as updating the asset tag and changing the system date and time.

Viewing Miscellaneous Settings

To view the **Miscellaneous Settings** screen, perform the following steps:

- 1 Power on, or restart your system.
- 2 Press F2 immediately after you see the following message:

F2 = System Setup

NOTE: If your operating system begins to load before you press F2, wait for the system to finish booting, and then restart your system and try again.

- 3 On the **System Setup Main Menu** screen, click **System BIOS**.
- 4 On the **System BIOS** screen, click **Miscellaneous Settings**.

Miscellaneous Settings details

The **Miscellaneous Settings** screen details are explained as follows:

Option	Description
System Time	Enables you to set the time on the system.
System Date	Enables you to set the date on the system.
Asset Tag	Specifies the asset tag and enables you to modify it for security and tracking purposes.
Keyboard NumLock	Enables you to set whether the system should boot with the NumLock enabled or disabled. This option is set to On by default. NOTE: This option does not apply to 84-key keyboards.
F1/F2 Prompt on Error	Enables or disables the F1/F2 prompt on error. This option is set to Enabled by default. The F1/F2 prompt also includes keyboard errors.
Load Legacy Video Option ROM	Enables you to determine whether the system BIOS loads the legacy video (INT 10H) option ROM from the video controller. Selecting Enabled in the operating system does not support UEFI video output standards. This field is available only for UEFI boot mode. You cannot set the option to Enabled if UEFI Secure Boot mode is enabled. This option is set to Disabled by default.
Dell Wyse P25/P45 BIOS Access	Enables or disables the Dell Wyse P25/P45 BIOS Access. This option is set to Enabled by default.
Power Cycle Request	Enables or disables the Power Cycle Request. This option is set to None by default.

iDRAC Settings utility

The iDRAC settings utility is an interface to set up and configure the iDRAC parameters by using UEFI. You can enable or disable various iDRAC parameters by using the iDRAC settings utility.

NOTE: Accessing some of the features on the iDRAC settings utility needs the iDRAC Enterprise License upgrade.

For more information about using iDRAC, see *Dell Integrated Dell Remote Access Controller User's Guide* at Dell.com/poweredgemanuals.

Device Settings

Device Settings enables you to configure the below device parameters:

- Controller Configuration Utility
- Embedded NIC Port1-X Configuration
- NICs in slotX, Port1-X Configuration
- BOSS Card configuration

Dell Lifecycle Controller

Dell Lifecycle Controller (LC) provides advanced embedded systems management capabilities including system deployment, configuration, update, maintenance, and diagnosis. LC is delivered as part of the iDRAC out-of-band solution and Dell system embedded Unified Extensible Firmware Interface (UEFI) applications.

Embedded system management

The Dell Lifecycle Controller provides advanced embedded system management throughout the lifecycle of the system. The Dell Lifecycle Controller can be started during the boot sequence and can function independently of the operating system.

 **NOTE:** Certain platform configurations may not support the full set of features provided by the Dell Lifecycle Controller.

For more information about setting up the Dell Lifecycle Controller, configuring hardware and firmware, and deploying the operating system, see the Dell Lifecycle Controller documentation at Dell.com/poweredgemanuals.

Boot Manager

The **Boot Manager** screen enables you to select boot options and diagnostic utilities.

Viewing Boot Manager

About this task

To enter Boot Manager:

Steps

- 1 Power on, or restart your system.
- 2 Press F11 when you see the following message:
F11 = Boot Manager

If your operating system begins to load before you press F11, allow the system to complete the booting, and then restart your system and try again.

Boot Manager main menu

Menu item	Description
Continue Normal Boot	The system attempts to boot to devices starting with the first item in the boot order. If the boot attempt fails, the system continues with the next item in the boot order until the boot is successful or no more boot options are found.
One-shot Boot Menu	Enables you to access boot menu, where you can select a one-time boot device to boot from.
Launch System Setup	Enables you to access System Setup.
Launch Lifecycle Controller	Exits the Boot Manager and invokes the Dell Lifecycle Controller program.
System Utilities	Enables you to launch System Utilities menu such as System Diagnostics and UEFI shell.

One-shot UEFI boot menu

One-shot UEFI boot menu enables you to select a boot device to boot from.

System Utilities

System Utilities contains the following utilities that can be launched:

- Launch Diagnostics
- BIOS Update File Explorer
- Reboot System

PXE boot

You can use the Preboot Execution Environment (PXE) option to boot and configure the networked systems, remotely.

To access the **PXE boot** option, boot the system and then press F12 during POST instead of using standard Boot Sequence from BIOS Setup. It does not pull any menu or allows managing of network devices.

Installing and removing system components

Safety instructions

- ⚠ WARNING:** Whenever you need to lift the system, get others to assist you. To avoid injury, do not attempt to lift the system by yourself.
- ⚠ WARNING:** Opening or removing the system cover while the system is powered on may expose you to a risk of electric shock.
- ⚠ CAUTION:** Do not operate the system without the cover for a duration exceeding five minutes. Operating the system without the system cover can result in component damage.
- ⚠ CAUTION:** Many repairs may only be done by a certified service technician. You should only perform troubleshooting and simple repairs as authorized in your product documentation, or as directed by the online or telephone service and support team. Damage due to servicing that is not authorized by Dell is not covered by your warranty. Read and follow the safety instructions that are shipped with your product.
- ℹ NOTE:** It is recommended that you always use an antistatic mat and antistatic strap while working on components inside the system.
- ⚠ CAUTION:** To ensure proper operation and cooling, all bays in the system and system fans must be always populated with a component or a blank.

Before working inside your system

Prerequisite

Follow the safety guidelines listed in [Safety instructions](#).

Steps

- 1 Turn off the system, including all attached peripherals.
- 2 Disconnect the system from the electrical outlet and disconnect the peripherals.
- 3 If applicable, remove the system from the rack.
For more information, see the *Rack Installation Guide* at Dell.com/poweredge manuals.
- 4 [Remove the system cover](#).

After working inside your system

Prerequisite

Follow the safety guidelines listed in [Safety instructions](#).

Steps

- 1 [Install the system cover](#).
- 2 If applicable, install the system into the rack.
For more information, see the *Rack Installation Guide* at www.dell.com/poweredge manuals.
- 3 Reconnect the peripherals and connect the system to the electrical outlet.
- 4 Turn on the attached peripherals and then turn on the system.

Recommended tools

You need the following tools to perform the removal and installation procedures:

- Key to the bezel lock
The key is required only if your system includes a bezel.
- Phillips #1 screwdriver
- Phillips #2 screwdriver
- Torx #T30 screwdriver
- 1/4 inch flat blade screwdriver
- Wrist-grounding strap connected to the ground
- ESD Mat

You need the following tools to assemble the cables for a DC power supply unit:

- AMP 90871-1 hand-crimping tool or equivalent
- Tyco Electronics 58433-3 or equivalent
- Wire-stripper pliers to remove insulation from size 10 AWG solid or stranded, insulated copper wire

① | **NOTE:** Use alpha wire part number 3080 or equivalent (65/30 stranding).

Optional front bezel

Front bezel details

An optional metal bezel is mounted on the front of the system to display system branding. A lock on the bezel is used to protect unauthorized access to the drives. There are two versions of bezel available:

- With LCD panel
- Without LCD panel

For bezels with LCD panel, the system status can be viewed on the LCD panel. For more information, see the [LCD panel](#) section.

The LCD bezel is hot pluggable and can be used in any server of the same branding even if that system was originally not ordered with that LCD bezel.

Removing the front bezel

The procedure to remove the front bezel with and without the LCD panel is the same.

Prerequisite

Follow the safety guidelines listed in [Safety instructions](#).

Steps

- 1 Unlock the bezel by using the bezel key.
- 2 Press the release button, and pull the left end of the bezel.
- 3 Unhook the right end, and remove the bezel.

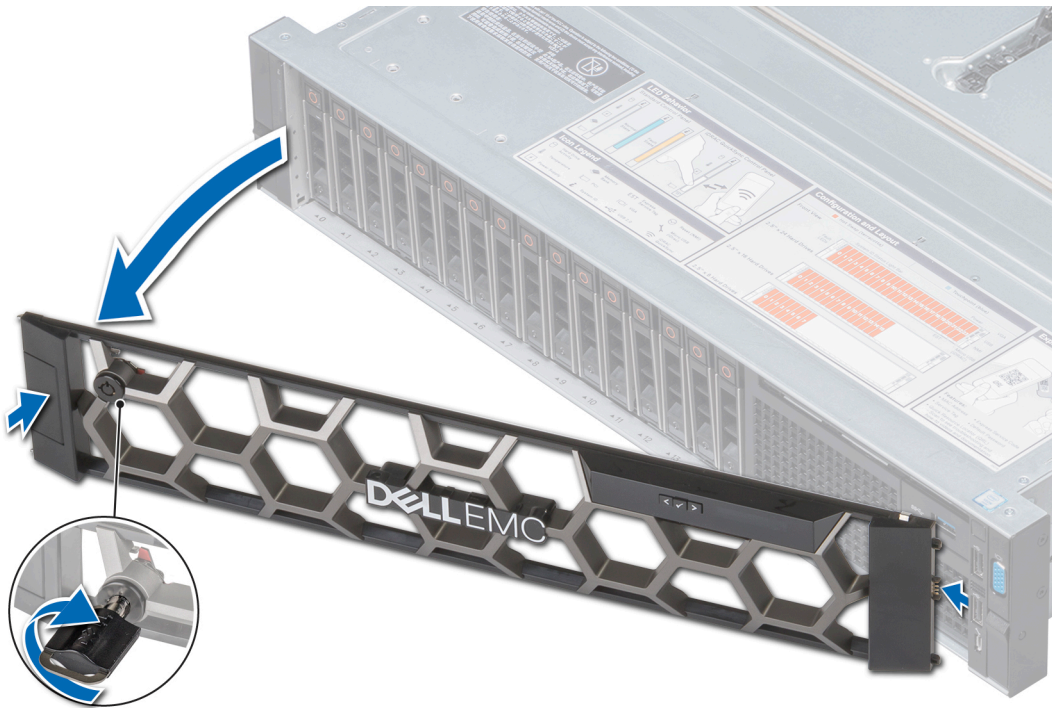

Figure 24. Removing the optional front bezel with the LCD panel

Next step

Install the front bezel.

Installing the front bezel

The procedure to install the front bezel with and without the LCD panel is the same.

Prerequisite

Follow the safety guidelines listed in [Safety instructions](#).

Steps

- 1 Locate and remove the bezel key.

NOTE: The bezel key is part of the LCD bezel package.

- 2 Align and insert the right end of the bezel onto the system.
- 3 Press the bezel until the button clicks in place and fit the left end of the bezel onto the system.
- 4 Lock the bezel by using the key.

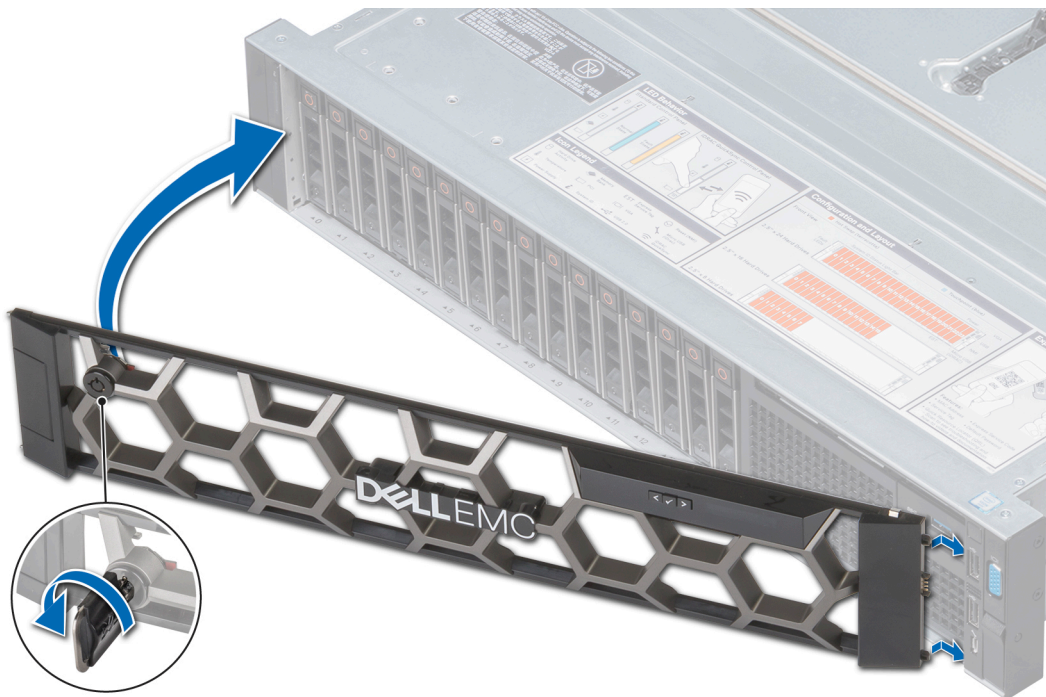

Figure 25. Installing the optional front bezel with the LCD panel

System cover

Removing the system cover

Prerequisites

- 1 Follow the safety guidelines listed in [Safety instructions](#).
- 2 Turn off the system, including any attached peripherals.
- 3 Disconnect the system from the electrical outlet and disconnect the peripherals.

Steps

- 1 Using a 1/4 inch flat head or a Phillips #2 screwdriver, rotate the latch release lock counter clockwise to the unlocked position.
- 2 Lift the latch till the system cover slides back and the tabs on the system cover disengage from the guide slots on the system.
- 3 Hold the cover on both sides, and lift the cover away from the system.



Figure 26. Removing the system cover

Next step

Install the system cover.

Installing the system cover

Prerequisites

- 1 Follow the safety guidelines listed in [Safety instructions](#).
- 2 Ensure that all internal cables are routed correctly and connected, and no tools or extra parts are left inside the system.

Steps

- 1 Align the tabs on the system cover with the guide slots on the system.
- 2 Push the system cover latch down.
The system cover slides forward, the tabs on the system cover engage with the guide slots on the system and the system cover latch locks into place.
- 3 Using a 1/4 inch flat head or Phillips #2 screwdriver, rotate the latch release lock clockwise to the locked position.



Figure 27. Installing system cover

Next steps

- 1 Reconnect the peripherals and connect the system to the electrical outlet.
- 2 Turn on the system, including any attached peripherals.

Backplane cover

Removing the backplane cover

Prerequisites

- 1 Follow the safety guidelines listed in [Safety instructions](#).
- 2 Follow the procedure listed in [Before working inside your system](#).

Steps

- 1 Slide the backplane cover in the direction of the arrows marked on the backplane cover.
- 2 Lift the backplane cover away from the system.

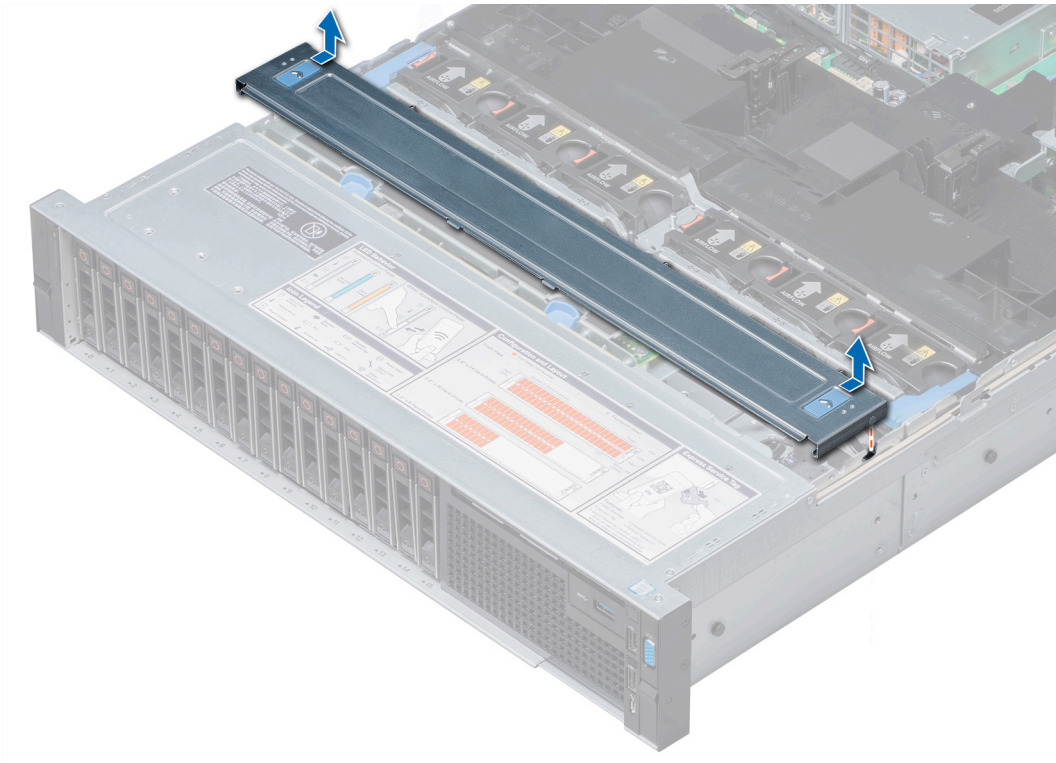

Figure 28. Removing backplane cover

Next step

Install the backplane cover.

Installing the backplane cover

Prerequisite

Follow the safety guidelines listed in [Safety instructions](#).

Steps

- 1 Align the tabs on the backplane cover with the guide slots on the system.
- 2 Slide the backplane cover toward the front of the system until the cover locks into place.

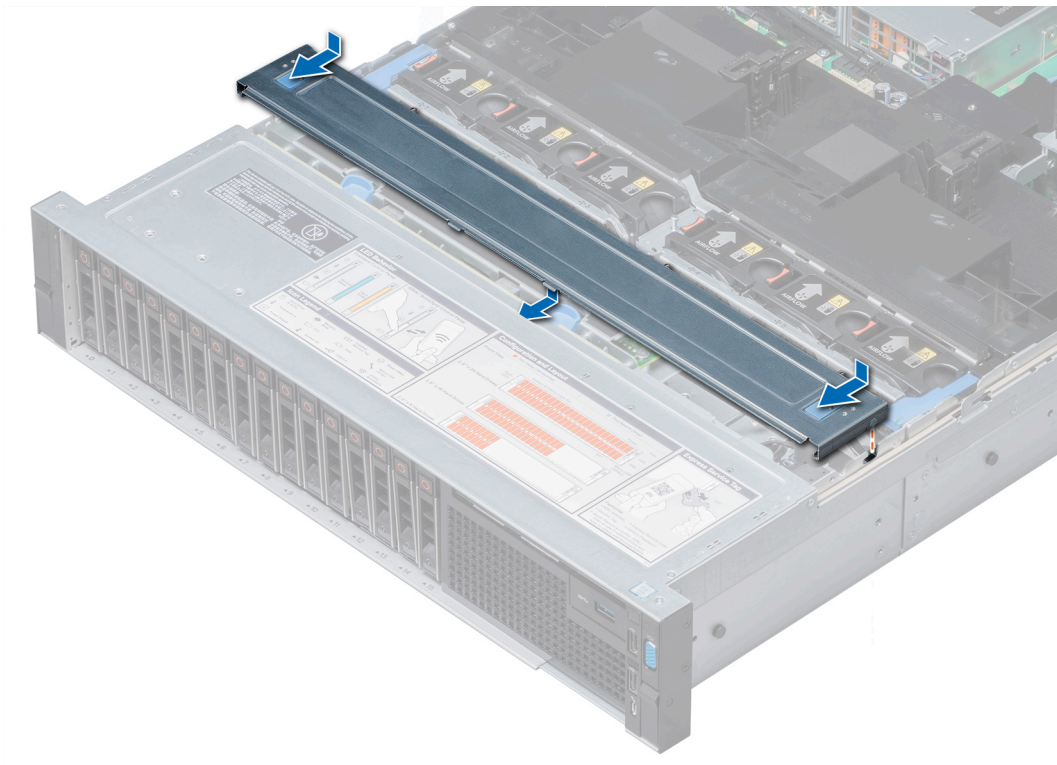

Figure 29. Installing the backplane cover

Next step

Follow the procedure listed in [After working inside your system.](#)

Inside the system

CAUTION: Many repairs may only be done by a certified service technician. You should only perform troubleshooting and simple repairs as authorized in your product documentation, or as directed by the online or telephone service and support team. Damage due to servicing that is not authorized by Dell is not covered by your warranty. Read and follow the safety instructions that are shipped with your product.

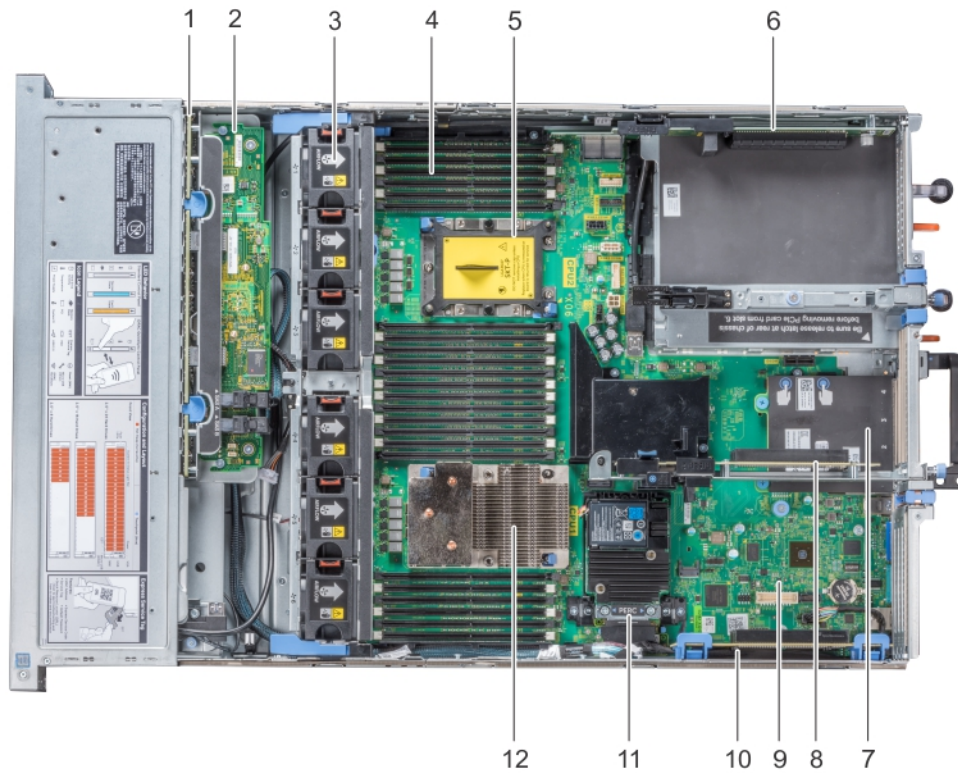

Figure 30. Inside the system

- | | | | |
|----|--|----|-------------------------------------|
| 1 | drive backplane | 2 | backplane expander card |
| 3 | cooling fan in the cooling fan assembly (6) | 4 | memory module |
| 5 | CPU2 processor and heat sink module socket (with dust cover) | 6 | expansion card riser 3 |
| 7 | network daughter card | 8 | expansion card riser 2 |
| 9 | system board | 10 | expansion card riser 1 |
| 11 | integrated storage controller card | 12 | CPU1 processor and heat sink module |

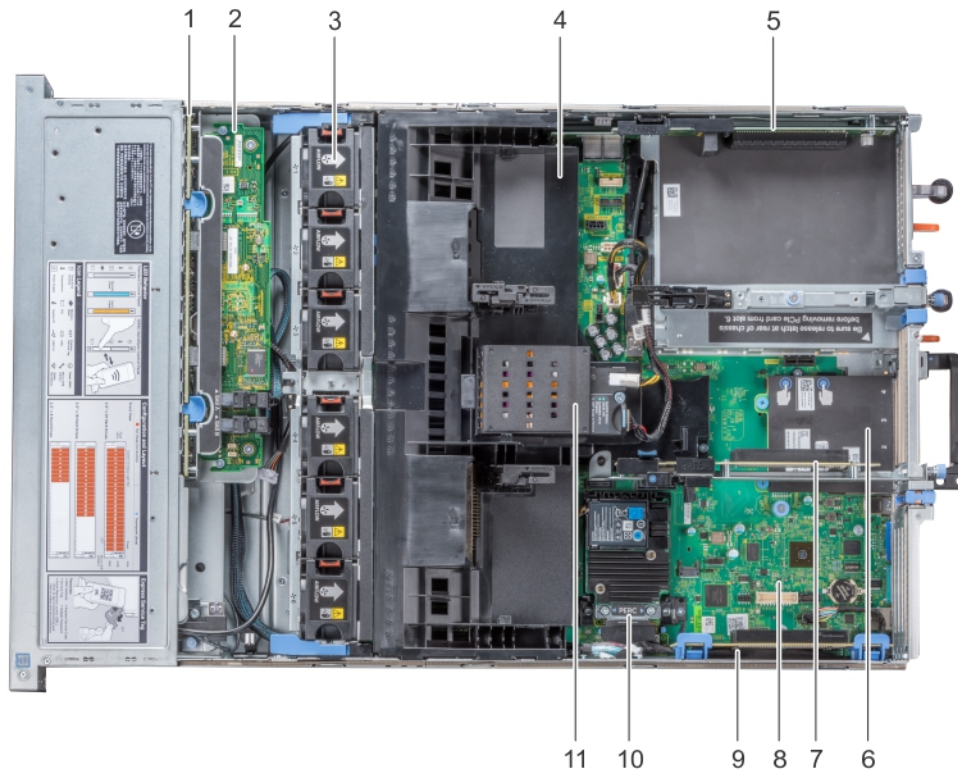

Figure 31. Inside the system – Configuration showing air shroud with optional NVDIMM-N battery

- | | | | |
|----|---|----|------------------------------------|
| 1 | drive backplane | 2 | backplane expander card |
| 3 | cooling fan (6) in the cooling fan assembly | 4 | air shroud |
| 5 | expansion card riser 3 | 6 | network daughter card |
| 7 | expansion card riser 2 | 8 | system board |
| 9 | expansion card riser 1 | 10 | integrated storage controller card |
| 11 | NVDIMM-N battery | | |

Air shroud

Removing the air shroud

Prerequisites

CAUTION: Never operate your system with the air shroud removed. The system may get overheated quickly, resulting in shutdown of the system and loss of data.

- 1 Follow the safety guidelines listed in [Safety instructions](#).
- 2 Follow the procedure listed in [Before working inside your system](#).
- 3 If installed, remove the full length PCIe cards.
- 4 If applicable, [remove the GPU cards](#).
- 5 If NVDIMM-N battery is installed, disconnect the cables from the NVDIMM-N battery.

CAUTION: NVDIMM-N battery is not hot swappable. To prevent data loss and potential damage to your system, ensure that your system, LEDs on system, LEDs on NVDIMM-N and LEDs on NVDIMM-N battery are turned off before disconnecting the NVDIMM-N battery cables.

Step

Hold the air shroud at both ends and lift it away from the system.

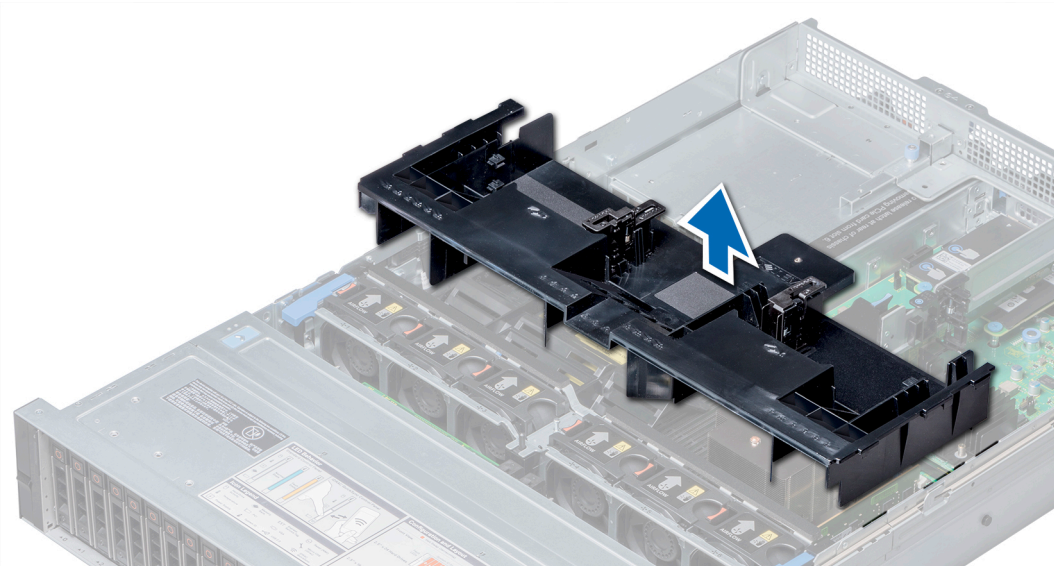

Figure 32. Removing air shroud

Next step

If applicable, [install the air shroud](#).

Installing the air shroud

Prerequisites

- 1 Follow the safety guidelines listed in [Safety instructions](#).
- 2 If applicable, route the cables inside the system along the system wall and secure the cables by using the cable latch.

Steps

- 1 Align the tabs on the air shroud with the slots on the system.
- 2 Lower the air shroud into the system until it is firmly seated.
When firmly seated, the memory socket numbers marked on the air shroud align with the respective memory sockets.

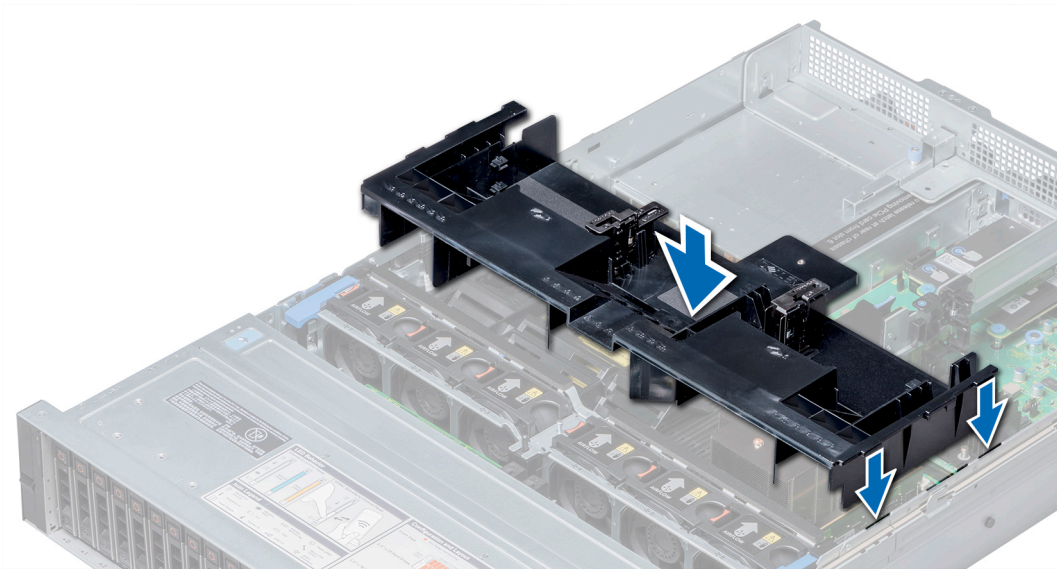

Figure 33. Installing air shroud

Next steps

- 1 If removed, install the full length PCIe cards.
- 2 If applicable, [install the GPU cards](#).
- 3 If applicable, connect the cables to the NVDIMM-N battery.

⚠ CAUTION: NVDIMM-N battery is not hot swappable. To prevent data loss and potential damage to your system, ensure that your system, LEDs on system, LEDs on NVDIMM-N and LEDs on NVDIMM-N battery are turned off before connecting the NVDIMM-N battery cables.

- 4 Follow the procedure listed in [After working inside your system](#).

Cooling fan assembly

Removing the cooling fan assembly

Prerequisites

- 1 Follow the safety guidelines listed in [Safety instructions](#).
- 2 Follow the procedure listed in [Before working inside your system](#).

Steps

- 1 Lift the release levers to unlock the cooling fan assembly from the system.
- 2 Hold the release levers, and lift the cooling fan assembly away from the system.

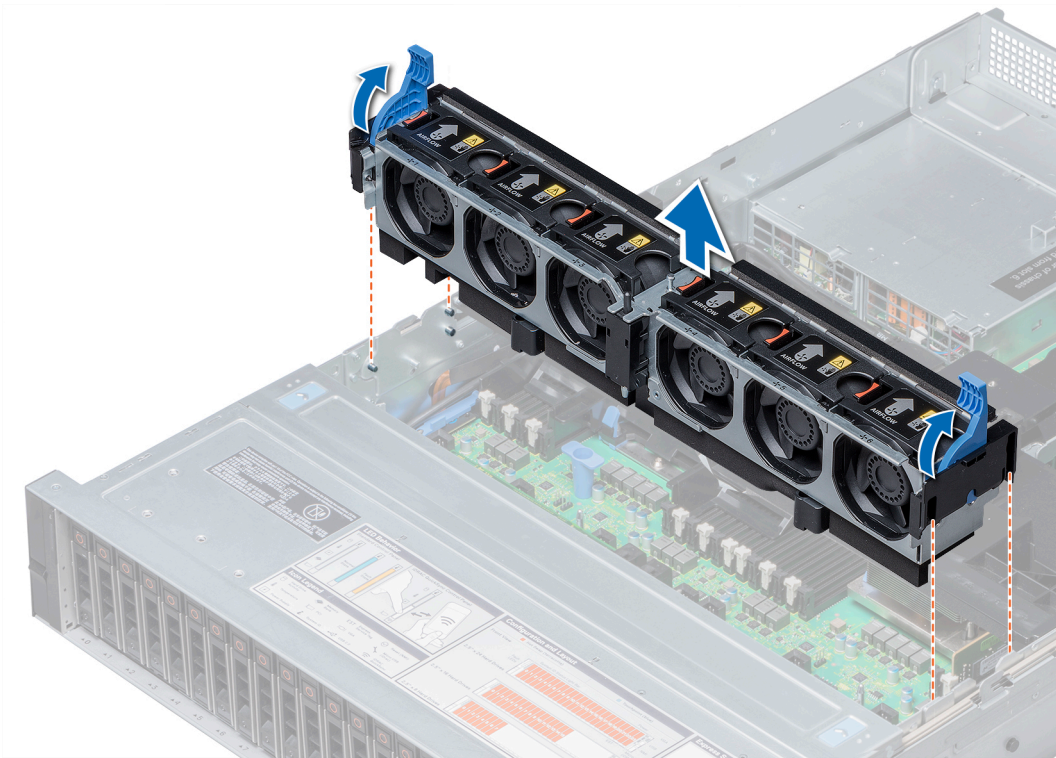

Figure 34. Removing the cooling fan assembly

Next step

Install the cooling fan assembly.

Installing the cooling fan assembly

Prerequisite

Follow the safety guidelines listed in [Safety instructions](#).

⚠ CAUTION: Ensure that the cables inside the system are correctly installed and retained by the cable retention bracket before installing the cooling fan assembly. Incorrectly installed cables may get damaged.

Steps

- 1 Align the guide rails on the cooling fan assembly with the standoffs on the system.
- 2 Lower the cooling fan assembly into the system until the cooling fan connectors engage with the connectors on the system board.
- 3 Press the release levers to lock the cooling fan assembly into the system.



Figure 35. Installing the cooling fan assembly

Next step

Follow the procedure listed in [After working inside your system](#).

Cooling fans

Cooling fan details

The cooling fans are integrated into the system to dissipate the heat generated by the functioning of the system. These fans provide cooling for the processors, expansion cards, and memory modules.

Your system supports up to six standard or high performance hot swappable cooling fans.

For single processor systems, only four standard cooling fans are required. Fan bays one and two are covered by a fan blank.

⚠ CAUTION: Mixing of standard and high performance cooling fans is not supported.

📌 NOTE: Each fan is listed in the systems management software, referenced by the respective fan number. If there is a problem with a particular fan, you can easily identify and replace the proper fan by noting the fan numbers on the cooling fan assembly.

Removing a cooling fan

The procedure for removing standard and high performance fans is identical.

Prerequisites

- ⚠ WARNING:** Opening or removing the system cover when the system is on may expose you to a risk of electric shock. Exercise utmost care while removing or installing cooling fans.
- ⚠ CAUTION:** The cooling fans are hot swappable. To maintain proper cooling while the system is on, replace only one fan at a time.

- 1 Follow the safety guidelines listed in [Safety instructions](#).
- 2 Follow the procedure listed in [Before working inside your system](#).

Step

Press the release tab and lift the cooling fan out of the cooling fan assembly.

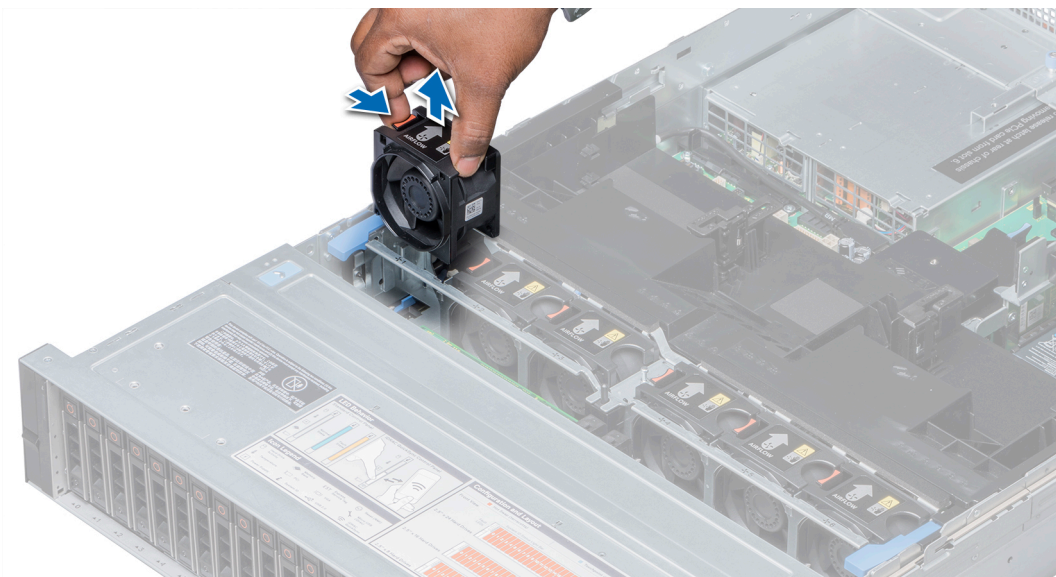

Figure 36. Removing cooling fan

Next step

If applicable, [install the cooling fan](#).

Installing a cooling fan

The procedure for installing standard and high performance fans is identical.

Prerequisites

- ⚠ WARNING:** Opening or removing the system cover when the system is on may expose you to a risk of electric shock. Exercise utmost care while removing or installing cooling fans.
- ⚠ CAUTION:** The cooling fans are hot swappable. To maintain proper cooling while the system is on, replace only one fan at a time.

Follow the safety guidelines listed in [Safety instructions](#).

Steps

- 1 Holding the release tab, align the connector at the base of the cooling fan with the connector on the system board.

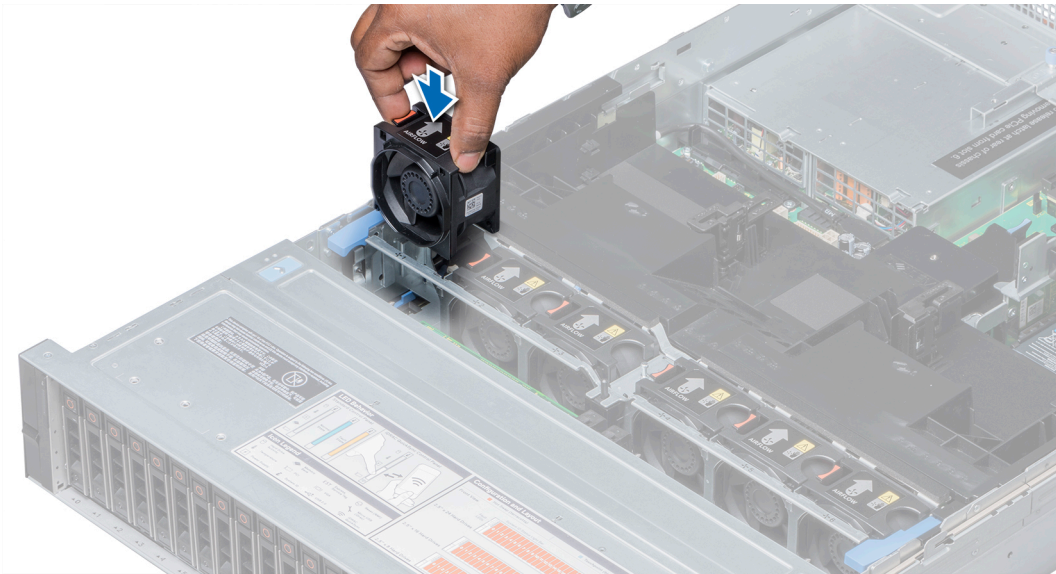

Figure 37. Installing cooling fan

- 2 Slide the cooling fan into the cooling fan assembly until the release tab locks into place.

Next step

Follow the procedure listed in [After working inside your system](#).

Intrusion switch

Removing an intrusion switch

Prerequisites

- 1 Follow the safety guidelines listed in [Safety instructions](#).
- 2 Follow the procedure listed in [Before working inside your system](#).
- 3 [Remove the cooling fan assembly](#).

Step

Press the intrusion switch and slide it out of the intrusion switch slot.

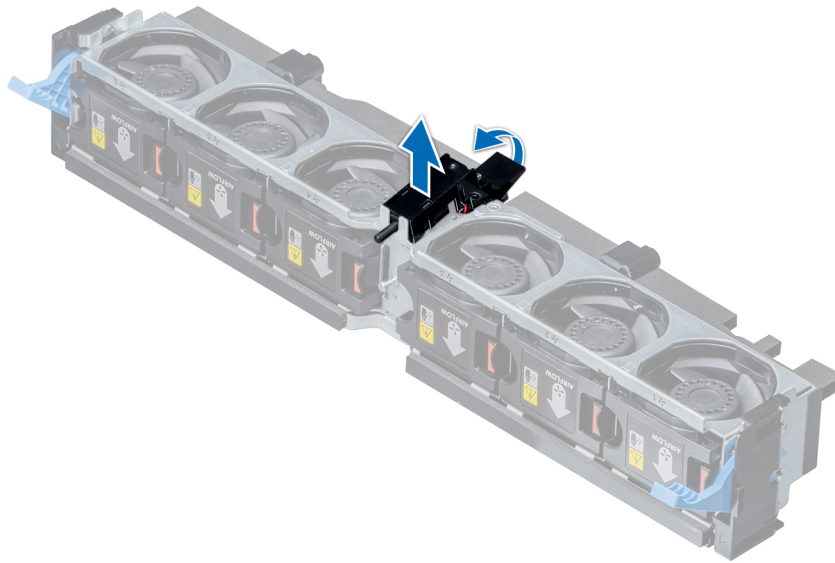

Figure 38. Removing an intrusion switch

Next step

Install an intrusion switch.

Installing an intrusion switch

Prerequisite

Follow the safety guidelines listed in [Safety instructions](#).

Steps

- 1 Align the tabs on the intrusion switch with the slots on the cooling fan assembly.
- 2 Push the intrusion switch until it locks in place.

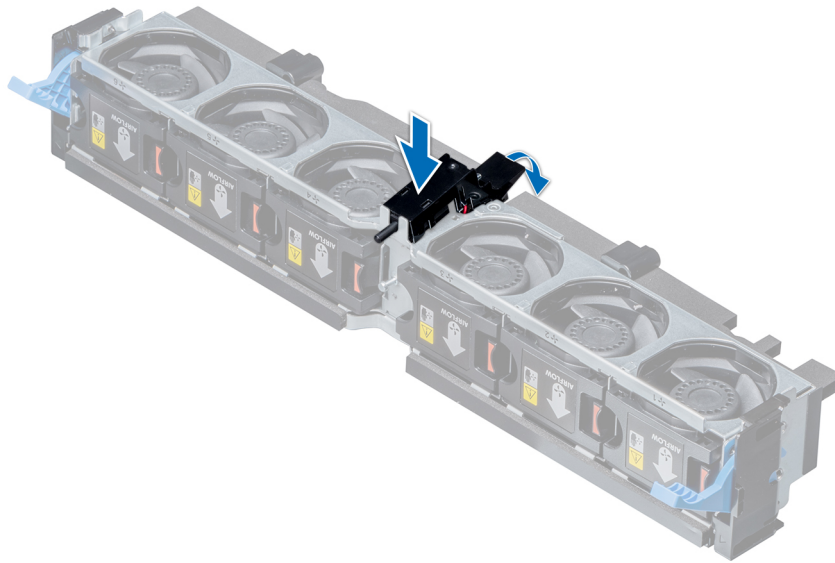

Figure 39. Installing an intrusion switch

Next steps

- 1 [Install the cooling fan assembly.](#)
- 2 Follow the procedure listed in [After working inside your system.](#)

NVDIMM-N battery

NVDIMM-N battery details

NVDIMM-N battery can be installed on both regular and GPU air shrouds.

Removing the NVDIMM-N battery from the air shroud

Prerequisites

- 1 Follow the safety guidelines listed in [Safety instructions.](#)
- 2 Follow the procedure listed in [Before working inside your system.](#)

CAUTION: NVDIMM-N battery is not hot swappable. To prevent data loss and potential damage to your system, ensure that your system, LEDs on system, LEDs on NVDIMM-N and LEDs on NVDIMM-N battery are turned off before removing the NVDIMM-N battery.

CAUTION: To avoid damage to the battery connector, you must firmly support the connector while installing or removing a battery.

Steps

- 1 Disconnect the cables from the NVDIMM-N battery.
- 2 Using Phillips #2 screwdriver, remove the screw securing the NVDIMM-N battery.
- 3 Holding the edges, lift the NVDIMM-N battery at an angle to disengage it from the slot on the air shroud.
- 4 Lift the NVDIMM-N battery away from the system.

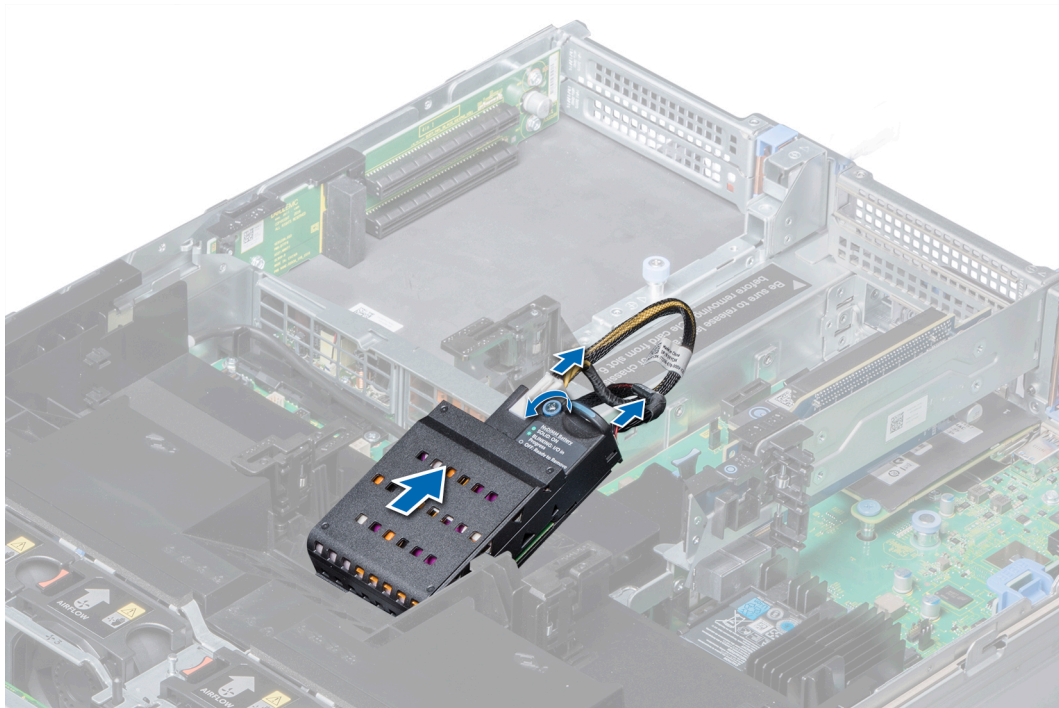

Figure 40. Removing the NVDIMM-N battery from the air shroud

Next step

Install the NVDIMM-N battery into the air shroud.

Installing NVDIMM-N battery into air shroud

Prerequisites

Follow the safety guidelines listed in [Safety instructions](#).

CAUTION: NVDIMM-N battery is not hot swappable. To prevent data loss and potential damage to your system, ensure that your system, LEDs on system, LEDs on NVDIMM-N and LEDs on NVDIMM-N battery are turned off before installing the NVDIMM-N battery.

CAUTION: To avoid damage to the battery connector, you must firmly support the connector while installing or removing a battery.

Steps

- 1 Incline the NVDIMM-N battery at an angle and place the battery on the air shroud slot.
- 2 Using Phillips #2 screwdriver, tighten the screw to secure the NVDIMM-N battery.
- 3 Connect the cables to the NVDIMM-N battery.

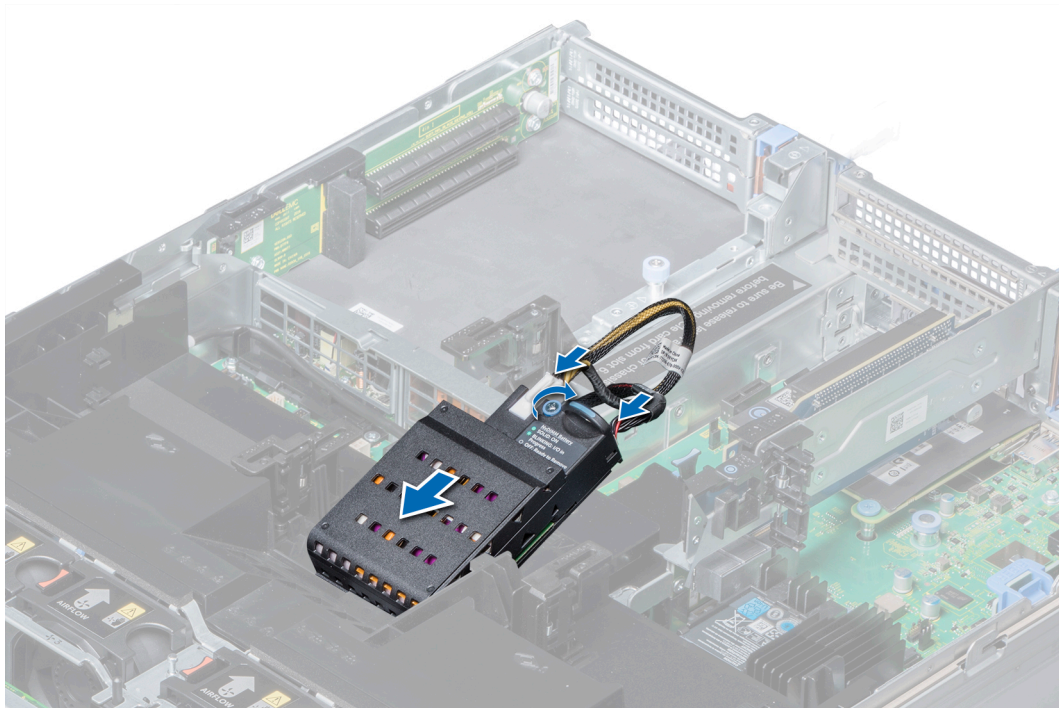

Figure 41. Installing NVDIMM-N battery into air shroud

Next step

Follow the procedure listed in [After working inside your system](#).

Removing NVDIMM-N battery from mid drive tray

Prerequisites

- 1 Follow the safety guidelines listed in [Safety instructions](#).
- 2 Follow the procedure listed in [Before working inside your system](#).

CAUTION: NVDIMM-N battery is not hot swappable. To prevent data loss and potential damage to your system, ensure that your system, LEDs on system, LEDs on NVDIMM-N and LEDs on NVDIMM-N battery are turned off before removing the NVDIMM-N battery.

CAUTION: To avoid damage to the battery connector, you must firmly support the connector while installing or removing a battery.

Steps

- 1 Lift the drive tray handles 90 degrees upward.
- 2 Using Phillips #2 screwdriver, remove the screw securing the NVDIMM-N battery.
- 3 Slide the NVDIMM-N battery to disengage it from the drive tray.
- 4 Disconnect the cables from the NVDIMM-N battery.
- 5 Holding the edges, lift the NVDIMM-N battery away from the system.

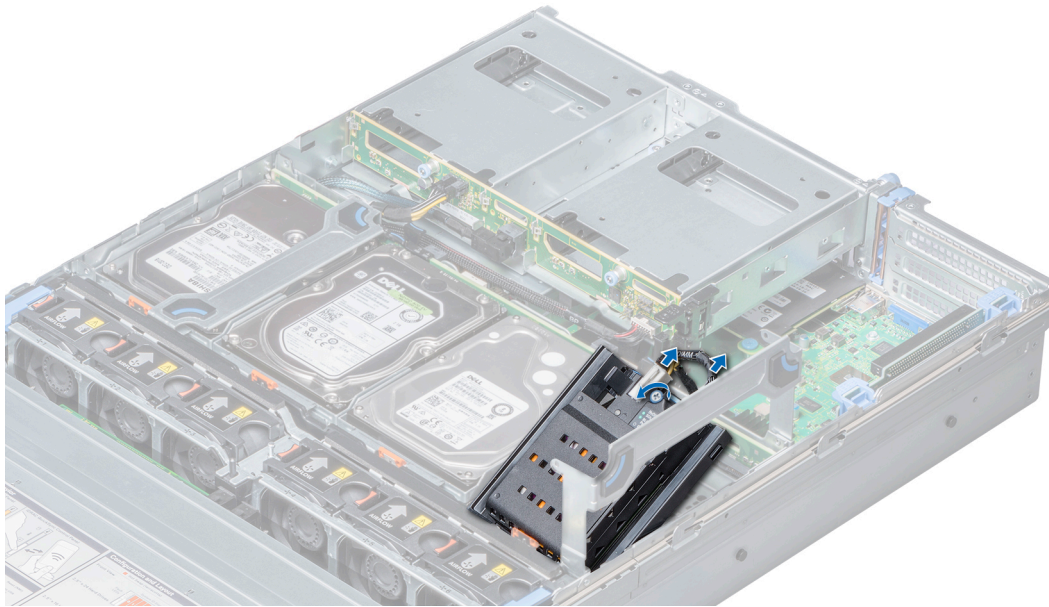

Figure 42. Removing NVDIMM-N battery from mid drive tray

Next step

Install NVDIMM-N battery into mid drive tray.

Installing NVDIMM-N battery into mid drive tray

Prerequisites

Follow the safety guidelines listed in [Safety instructions](#).

- ⚠ CAUTION:** NVDIMM-N battery is not hot swappable. To prevent data loss and potential damage to your system, ensure that your system, LEDs on system, LEDs on NVDIMM-N and LEDs on NVDIMM-N battery are turned off before installing the NVDIMM-N battery.
- ⚠ CAUTION:** To avoid damage to the battery connector, you must firmly support the connector while installing or removing a battery.

Steps

- 1 Connect the cables to the NVDIMM-N battery.
- 2 Slide the NVDIMM-N battery to engage the battery with the drive tray.
- 3 Using Phillips #2 screwdriver, tighten the screw to secure the NVDIMM-N battery.
- 4 Lower the drive tray handle.

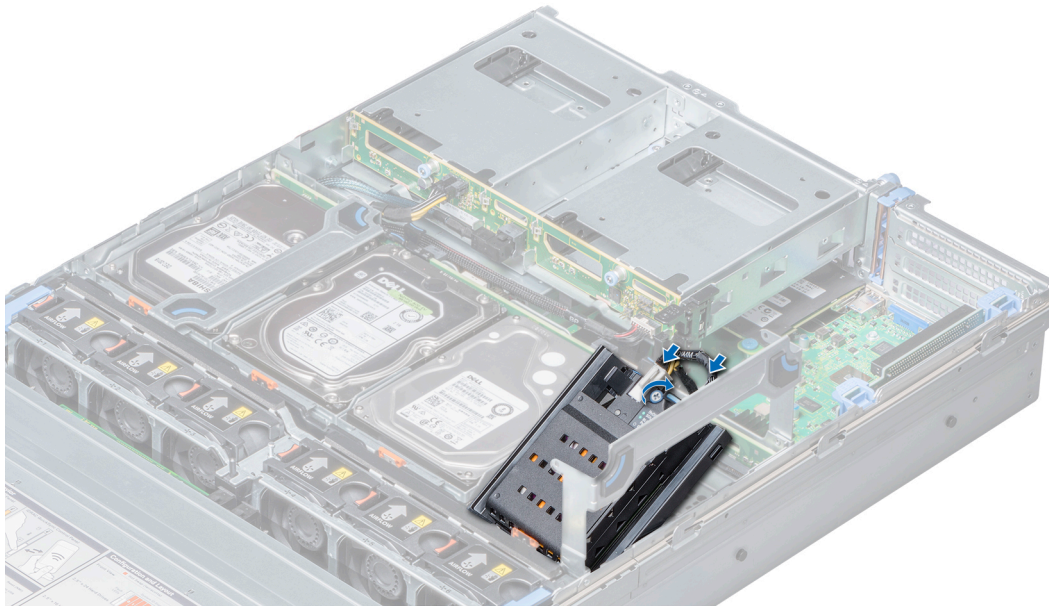

Figure 43. Installing NVDIMM-N battery into mid drive tray

Next step

Follow the procedure listed in [After working inside your system](#).

Removing NVDIMM-N battery from the bracket

Prerequisites

- 1 Follow the safety guidelines listed in [Safety instructions](#).
- 2 Follow the procedure listed in [Before working inside your system](#).

CAUTION: NVDIMM-N battery is not hot swappable. To prevent data loss and potential damage to your system, ensure that your system, LEDs on system, LEDs on NVDIMM-N and LEDs on NVDIMM-N battery are turned off before removing the NVDIMM-N battery.

CAUTION: To avoid damage to the battery connector, you must firmly support the connector while installing or removing a battery.

Step

Press the release tab and slide out the NVDIMM-N battery to disengage the tab on the battery from the slot on the bracket.



Figure 44. Removing NVDIMM-N battery from the bracket

Next step

Install NVDIMM-N battery into the bracket..

Installing NVDIMM-N battery into the bracket

Prerequisites

Follow the safety guidelines listed in [Safety instructions](#).

- ⚠ **CAUTION:** NVDIMM-N battery is not hot swappable. To prevent data loss and potential damage to your system, ensure that your system, LEDs on system, LEDs on NVDIMM-N and LEDs on NVDIMM-N battery are turned off before installing the NVDIMM-N battery.
- ⚠ **CAUTION:** To avoid damage to the battery connector, you must firmly support the connector while installing or removing a battery.

Steps

- 1 Align the tab on the NVDIMM-N battery with the slot on the bracket.
- 2 Insert the battery into the bracket until it is firmly seated.



Figure 45. Installing NVDIMM-N battery into the bracket

Next step

Follow the procedure listed in [After working inside your system](#).

Drives

Drive guidelines

Drives are supplied in hot swappable drive carriers that fit in the drive slots.

CAUTION: Before attempting to remove or install a drive while the system is running, see the documentation for the storage controller card to ensure that the host adapter is configured correctly.

CAUTION: Do not turn off or restart your system while a drive is being formatted. Doing so can cause a drive failure.

When you format a drive, allow enough time for the formatting to complete. Be aware that high-capacity drives can take a long time to format.

Removing a drive blank

The procedure for removing 2.5 inch and 3.5 inch drive blanks is identical.

Prerequisites

- 1 Follow the safety guidelines listed in [Safety instructions](#).
- 2 If installed, [remove the front bezel](#).

CAUTION: To maintain proper system cooling, drive blanks must be installed in all empty drive slots.

CAUTION: Mixing drive blanks from previous generations of PowerEdge servers is not supported.

Step

Press the release button, and slide the drive blank out of the drive slot.

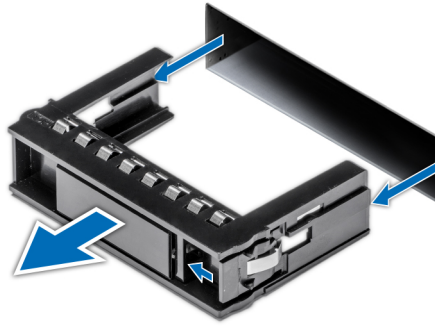

Figure 46. Removing a drive blank

Next step

- 1 Install a drive or a drive blank

Installing a drive blank

The procedure for installing 2.5 inch and 3.5 inch drive blanks is identical.

Prerequisite

Follow the safety guidelines listed in [Safety instructions](#).

⚠ CAUTION: Mixing drive blanks from previous generations of PowerEdge servers is not supported.

Step

Insert the drive blank into the drive slot, and push the blank until the release button clicks into place.

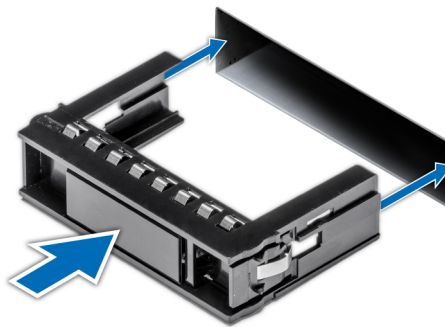

Figure 47. Installing a drive blank

Next step

If removed, [install the front bezel](#).

Removing a drive carrier

Prerequisites

- 1 Follow the safety guidelines listed in [Safety instructions](#).
- 2 If applicable, [remove the front bezel](#).

- Using the management software, prepare the drive for removal.
If the drive is online, the green activity or fault indicator flashes while the drive is turning off. When the drive indicators are off, the drive is ready for removal. For more information, see the documentation for the storage controller.

CAUTION: Before attempting to remove or install a drive while the system is running, see the documentation for the storage controller card to ensure that the host adapter is configured correctly to support drive removal and insertion.

CAUTION: Mixing drives from previous generations of PowerEdge servers is not supported.

CAUTION: To prevent data loss, ensure that your operating system supports drive installation. See the documentation supplied with your operating system.

Steps

- Press the release button to open the drive carrier release handle.
- Holding the handle, slide the drive carrier out of the drive slot.



Figure 48. Removing a drive carrier

Next steps

- Install a drive carrier.
- If you are not replacing the drive immediately, insert a drive blank in the empty drive slot to maintain proper system cooling.

Installing a drive carrier

Prerequisites

CAUTION: Before attempting to remove or install a drive while the system is running, see the documentation for the storage controller card to ensure that the host adapter is configured correctly to support drive removal and insertion.

CAUTION: Mixing drives from previous generations of PowerEdge servers is not supported.

CAUTION: Combining SAS and SATA drives in the same RAID volume is not supported.

CAUTION: When installing a drive, ensure that the adjacent drives are fully installed. Inserting a drive carrier and attempting to lock its handle next to a partially installed carrier can damage the partially installed carrier's shield spring and make it unusable.

CAUTION: To prevent data loss, ensure that your operating system supports hot-swap drive installation. See the documentation supplied with your operating system.

CAUTION: When a replacement hot swappable drive is installed and the system is powered on, the drive automatically begins to rebuild. Ensure that the replacement drive is blank or contains data that you wish to overwrite. Any data on the replacement drive is immediately lost after the drive is installed.

- 1 Follow the safety guidelines listed in [Safety instructions](#).
- 2 If applicable, [remove the drive blank](#).

Steps

- 1 Press the release button on the front of the drive carrier to open the release handle.
- 2 Insert the drive carrier into the drive slot and slide until the drive connects with the backplane.
- 3 Close the drive carrier release handle to lock the drive in place.



Figure 49. Installing a drive carrier

Next step

If removed, [install the front bezel](#).

Removing a 2.5 inch drive from the 3.5 inch drive adapter

Prerequisites

- 1 Follow the safety guidelines listed in [Safety instructions](#).
- 2 Follow the procedure listed in [Before working inside your system](#).
- 3 [Remove 3.5 inch drive adapter from the 3.5 inch drive carrier](#).

NOTE: A 2.5 inch hot swappable drive is installed in a 3.5 inch drive adapter, which is then installed in the 3.5 inch hot swappable drive carrier.

Steps

- 1 Using a Phillips #2 screwdriver, remove the screws from the side of the 3.5 inch drive adapter.
- 2 Remove the drive from the 3.5 inch drive adapter.

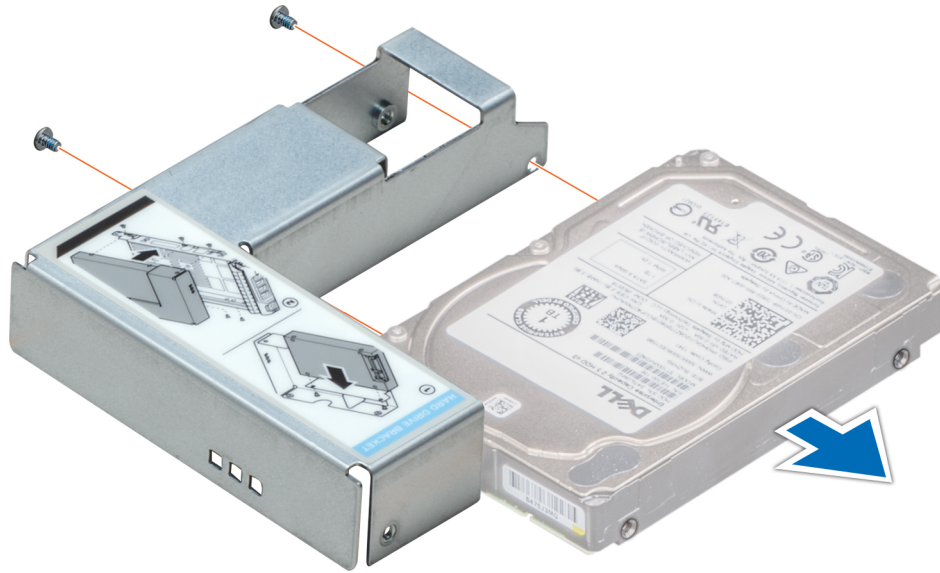

Figure 50. Removing a 2.5 inch drive from the 3.5 inch drive adapter

Next step

Install a 2.5 inch drive into the 3.5 inch drive adapter.

Installing a 2.5 inch drive into the 3.5 inch drive adapter

Prerequisite

Follow the safety guidelines listed in [Safety instructions](#).

Steps

- 1 Align the screw holes on the 2.5 inch drive with the screw holes on the 3.5 inch drive adapter.
- 2 Using a Phillips #2 screwdriver, install the screws to secure the drive to the 3.5 inch drive adapter.

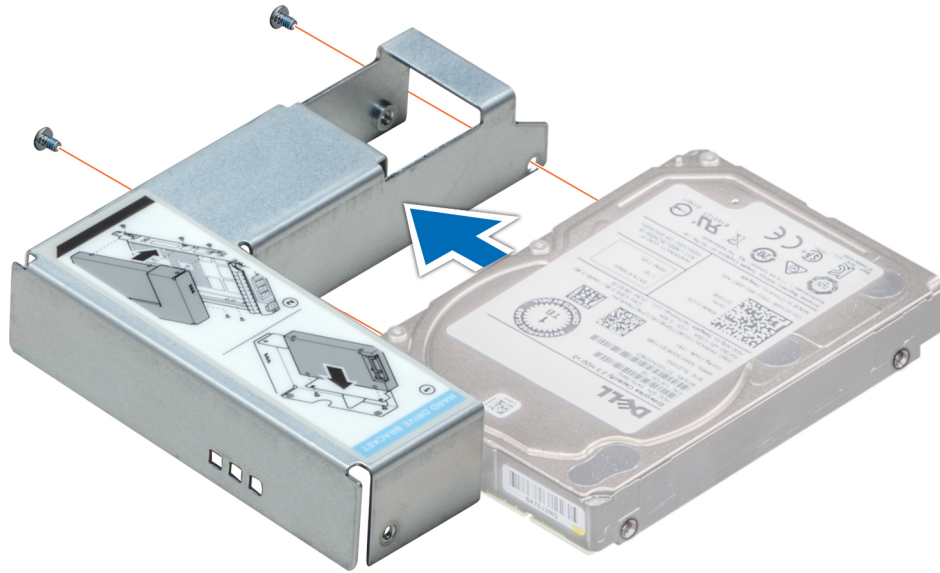

Figure 51. Installing a 2.5 inch drive into the 3.5 inch drive adapter

Next steps

- 1 [Install a 3.5 inch adapter into the 3.5 inch drive carrier.](#)
- 2 Follow the procedure listed in [After working inside your system.](#)

Removing a 3.5 inch adapter from a 3.5 inch drive carrier

Prerequisites

- 1 Follow the safety guidelines listed in [Safety instructions.](#)
- 2 Follow the procedure listed in [Before working inside your system.](#)
- 3 [Remove the 3.5 inch drive carrier from the system.](#)

Steps

- 1 Remove the screws from the rails on the drive carrier.
- 2 Lift the 3.5 inch drive adapter out of the drive carrier.

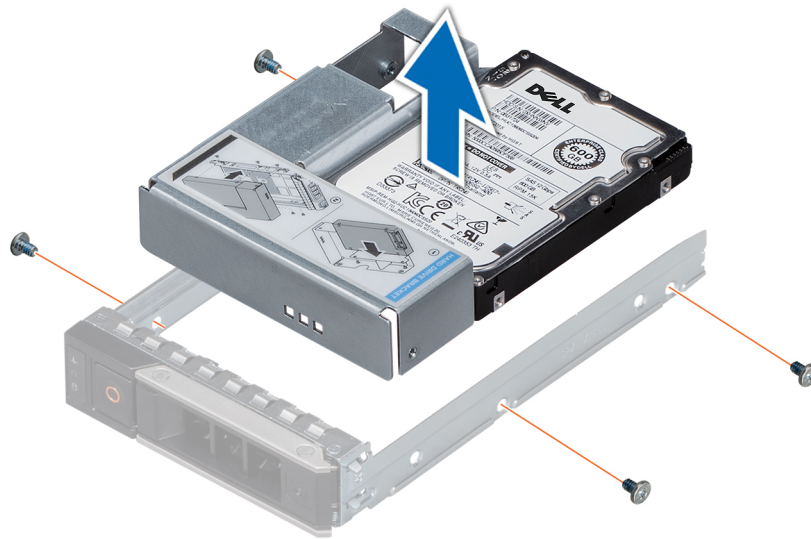

Figure 52. Removing a 3.5 inch adapter from a 3.5 inch drive carrier

Next step

Install a 3.5 inch adapter into a 3.5 inch drive carrier.

Installing a 3.5 inch adapter into a 3.5 inch drive carrier

Prerequisite

Follow the safety guidelines listed in [Safety instructions](#).

Steps

- 1 Insert the 3.5 inch drive adapter into the drive carrier with the connector end of the drive toward the back of the drive carrier.
- 2 Align the screw holes on the drive with the holes on the drive carrier.
- 3 Install the screws to secure the drive to the drive carrier.

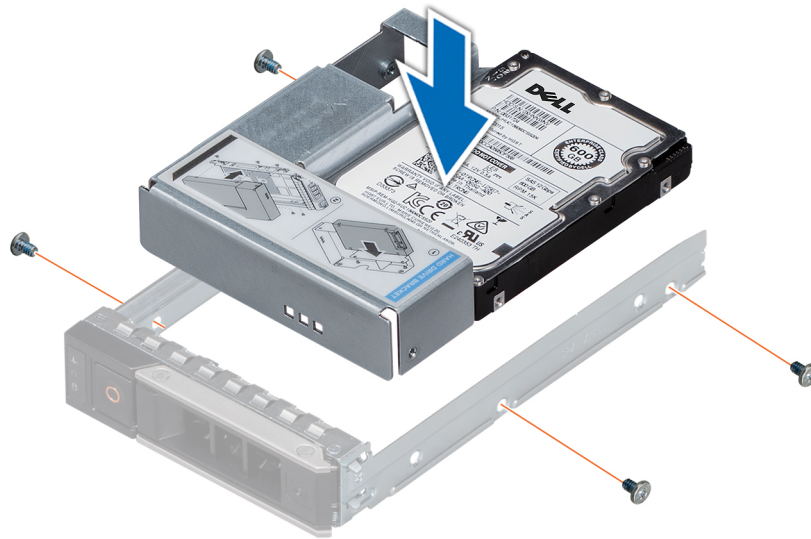

Figure 53. Installing a 3.5 inch adapter into a 3.5 inch drive carrier

Next steps

- 1 Install a 3.5 inch drive carrier into the system.
- 2 Follow the procedure listed in [After working inside your system](#).

Removing the drive from the drive carrier

Prerequisites

- 1 Follow the safety guidelines listed in [Safety instructions](#).
- 2 Follow the safety guidelines listed in [Before working inside your system](#).

⚠ CAUTION: Mixing drives from previous generations of PowerEdge servers is not supported.

Steps

- 1 Using a Phillips #1 screwdriver, remove the screws from the slide rails on the drive carrier.
- 2 Lift the drive out of the drive carrier.

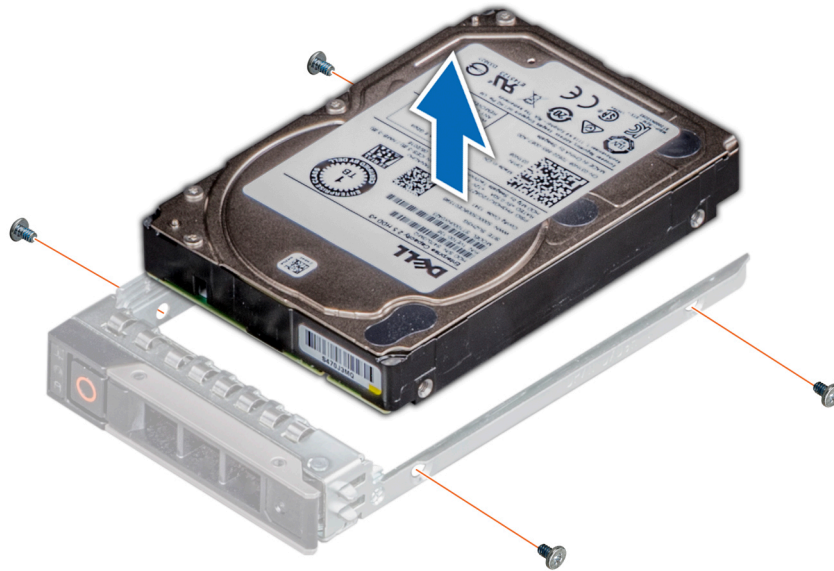

Figure 54. Removing the drive from the drive carrier

Next step

If applicable, [install the drive into the drive carrier](#).

Installing a drive into the drive carrier

Prerequisites

Follow the safety guidelines listed in [Safety instructions](#).

⚠ CAUTION: Mixing drive carriers from other generations of PowerEdge servers is not supported.

📌 NOTE: When installing a drive into the drive carrier, ensure that the screws are torqued to 4 in-lbs.

Steps

- 1 Insert the drive into the drive carrier with the connector end of the drive towards the back of the carrier.
- 2 Align the screw holes on the drive with the screws holes on the drive carrier.
When aligned correctly, the back of the drive is flush with the back of the drive carrier.
- 3 Using a Phillips #1 screwdriver, secure the drive to the drive carrier with screws.



Figure 55. Installing a drive into the drive carrier

System memory

System memory guidelines

The PowerEdge systems support DDR4 Registered DIMMs (RDIMMs), Load Reduced DIMMs (LRDIMMs), and Non-Volatile DIMMs (NVDIMM-Ns). System memory holds the instructions that are executed by the processor.

Your system contains 24 memory sockets split into two sets of 12 sockets, one set per processor. Each 12-socket set is organized into six channels. Six memory channels are allocated to each processor. In each channel, the release tabs of the first socket are marked white, and the second socket black.

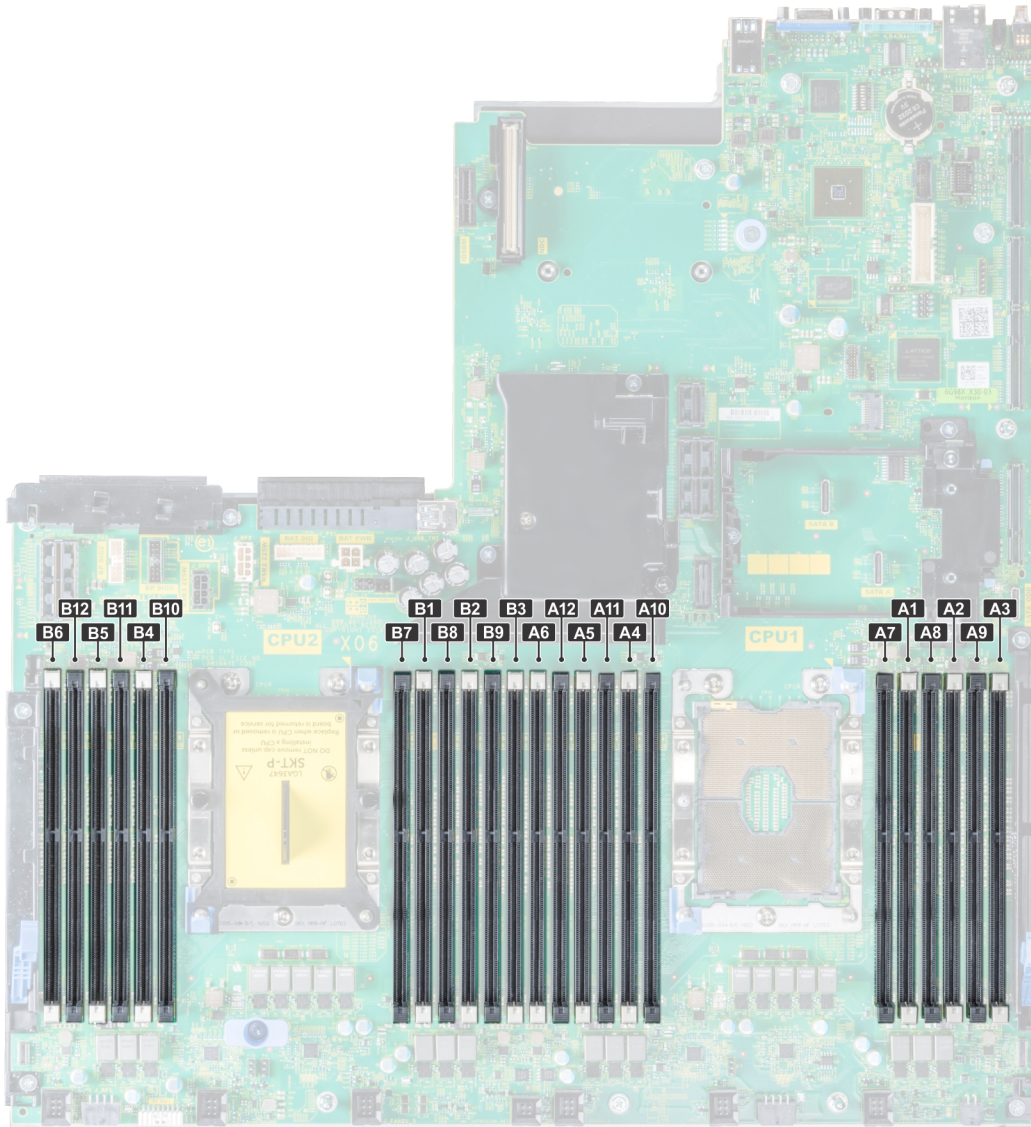

Figure 56. Memory socket locations

Memory channels are organized as follows:

Table 41. Memory channels

Processor	Channel 0	Channel 1	Channel 2	Channel 3	Channel 4	Channel 5
Processor 1	Slots A1 and A7	Slots A2 and A8	Slots A3 and A9	Slots A4 and A10	Slots A5 and A11	Slots A6 and A12
Processor 2	Slots B1 and B7	Slots B2 and B8	Slots B3 and B9	Slots B4 and B10	Slots B5 and B11	Slots B6 and B12

General memory module installation guidelines

To ensure optimal performance of your system, observe the following general guidelines when configuring your system memory. If your system's memory configurations fail to observe these guidelines, your system might not boot, stop responding during memory configuration, or operate with reduced memory.

The memory bus may operate at frequency can be 2666 MT/s, 2400 MT/s, or 2133 MT/s depending on the following factors:

- System profile selected (for example, Performance Optimized, or Custom [can be run at high speed or lower])
- Maximum supported DIMM speed of the processors
- Maximum supported speed of the DIMMs

NOTE: MT/s indicates DIMM speed in MegaTransfers per second.

The system supports Flexible Memory Configuration, enabling the system to be configured and run in any valid chipset architectural configuration. The following are the recommended guidelines for installing memory modules:

- All DIMMs must be DDR4.
- RDIMMs and LRDIMMs must not be mixed.
- NVDIMMs and LRDIMMs must not be mixed.
- NVDIMMs and RDIMMs can be mixed.
- 64 GB LRDIMMs that are DDP (Dual Die Package) LRDIMMs must not be mixed with 128 GB LRDIMMs that are TSV (Through Silicon Via/3DS) LRDIMMs.
- x4 and x8 DRAM based memory modules can be mixed.
- Up to two RDIMMs can be populated per channel regardless of rank count.
- Up to two LRDIMMs can be populated per channel regardless of rank count.
- A maximum of two different ranked DIMMs can be populated in a channel regardless of rank count.
- If memory modules with different speeds are installed, they will operate at the speed of the slowest installed memory module(s).
- Populate memory module sockets only if a processor is installed.
 - For single-processor systems, sockets A1 to A12 are available.
 - For dual-processor systems, sockets A1 to A12 and sockets B1 to B12 are available.
- Populate all the sockets with white release tabs first, followed by the black release tabs.
- When mixing memory modules with different capacities, populate the sockets with memory modules with the highest capacity first. For example, if you want to mix 8 GB and 16 GB memory modules, populate 16 GB memory modules in the sockets with white release tabs and 8 GB memory modules in the sockets with black release tabs.
- Memory modules of different capacities can be mixed provided other memory population rules are followed. For example, 8 GB and 16 GB memory modules can be mixed.
- In a dual-processor configuration, the memory configuration for each processor must be identical. For example, if you populate socket A1 for processor 1, then populate socket B1 for processor 2, and so on.
- Mixing of more than two memory module capacities in a system is not supported.
- Unbalanced memory configurations will result in a performance loss so always populate memory channels identically with identical DIMMs for best performance.
- Populate six identical memory modules per processor (one DIMM per channel) at a time to maximize performance.
- To ensure proper system cooling, memory module blanks must be installed in memory sockets that are not occupied.

DIMM population update for Performance Optimized mode with quantity of 4 and 8 DIMMs per processor.

- When the DIMM quantity is 4 per processor, the population is slot 1, 2, 4, 5.
- When the DIMM quantity is 8 per processor, the population is slot 1, 2, 4, 5, 7, 8, 10, 11.

NVDIMM-N memory module installation guidelines

The following are the recommended guidelines for installing NVDIMM-N memory modules:

- Each system supports memory configurations with 1, 2, 4, 6, or 12 NVDIMM-Ns.
- Supported configurations have dual processors and a minimum of 12x RDIMMs.
- Maximum of 12 NVDIMM-Ns can be installed in a system.
- NVDIMM-Ns or RDIMMs must not be mixed with LRDIMMs.
- DDR4 NVDIMM-Ns must be populated only on the black release tabs on processor 1 and 2.
- All slots on configurations 3, 6, 9, and 12 can be used, but a maximum of 12 NVDIMM-Ns can be installed in a system.

For more information on the supported NVDIMM-N configurations, see the *NVDIMM-N User Guide* at Dell.com/poweredge manuals.

Table 42. Supported NVDIMM-N for dual processor configurations

Configuration	Description	Memory population rules	
		RDIMMs	NVDIMM-N
Configuration 1	12x 16 GB RDIMMs, 1x NVDIMM-N	Processor1 {A1, 2, 3, 4, 5, 6} Processor2 {B1, 2, 3, 4, 5, 6}	Processor1 {A7}
Configuration 2	12x 32 GB RDIMMs, 1x NVDIMM-N	Same for all 12x RDIMM configurations. See Configuration 1.	Processor1 {A7}
Configuration 3	23x 32 GB RDIMMs, 1x NVDIMM-N	Processor1 {A1, 2, 3, 4, 5, 6, 7, 8, 9, 10, 11, 12} Processor2 {B1, 2, 3, 4, 5, 6, 7, 8, 9, 10, 11}	Processor2 {B12}
Configuration 4	12x 16 GB RDIMMs, 2x NVDIMM-Ns	Same for all 12x RDIMM configurations. See Configuration 1.	Processor1 {A7} Processor2 {B7}
Configuration 5	12x 32 GB RDIMMs, 2x NVDIMM-Ns	Same for all 12x RDIMM configurations. See Configuration 1.	Processor1 {A7} Processor2 {B7}
Configuration 6	22x 32 GB RDIMMs, 2x NVDIMM-Ns	Processor1 {A1, 2, 3, 4, 5, 6, 7, 8, 9, 10, 11} Processor2 {B1, 2, 3, 4, 5, 6, 7, 8, 9, 10, 11}	Processor1 {A12} Processor2 {B12}
Configuration 7	12x 16 GB RDIMMs, 4x NVDIMM-Ns	Same for all 12x RDIMM configurations. See Configuration 1.	Processor1 {A7, A8} Processor2 {B7, B8}
Configuration 8	22x 32 GB RDIMMs, 4x NVDIMM-Ns	Same for all 12x RDIMM configurations. See Configuration 1.	Processor1 {A7, A8} Processor2 {B7, B8}

Configuration	Description	Memory population rules	
		RDIMMs	NVDIMM-N
Configuration 9	20x 32 GB RDIMMs, 4x NVDIMM-Ns	Processor1 {A1, 2, 3, 4, 5, 6, 7, 8, 9, 10} Processor2 {B1, 2, 3, 4, 5, 6, 7, 8, 9, 10}	Processor1 {A11, 12} Processor2 {B11, 12}
Configuration 10	12x 16 GB RDIMMs, 6x NVDIMM-Ns	Same for all 12x RDIMM configurations. See Configuration 1.	Processor1 {A7, 8, 9} Processor2 {B7, 8, 9}
Configuration 11	12x 32 GB RDIMMs, 6x NVDIMM-Ns	Same for all 12x RDIMM configurations. See Configuration 1.	Processor1 {A7, 8, 9} Processor2 {B7, 8, 9}
Configuration 12	18x 32 GB RDIMMs, 6x NVDIMM-Ns	Processor1 {1, 2, 3, 4, 5, 6, 7, 8, 9} Processor2 {1, 2, 3, 4, 5, 6, 7, 8, 9}	Processor1 {A10, 11, 12} Processor2 {B10, 11, 12}
Configuration 13	12x 16 GB RDIMMs, 12x NVDIMM-Ns	Same for all 12x RDIMM configurations. See Configuration 1.	Processor1 {A7, 8, 9, 10, 11, 12} Processor2 {B7, 8, 9, 10, 11, 12}
Configuration 14	12x 32 GB RDIMMs, 12x NVDIMM-Ns	Same for all 12x RDIMM configurations. See Configuration 1.	Processor1 {A7, 8, 9, 10, 11, 12} Processor2 {B7, 8, 9, 10, 11, 12}

Mode-specific guidelines

The configurations allowed depend on the memory mode selected in the System BIOS.

Table 43. Memory operating modes

Memory Operating Mode	Description
Optimizer Mode	The Optimizer Mode if enabled, the DRAM controllers operate independently in the 64-bit mode and provide optimized memory performance.
Mirror Mode	The Mirror Mode if enabled, the system maintains two identical copies of data in memory, and the total available system memory is one half of the total installed physical memory. Half of the installed memory is used to mirror the active memory modules. This feature provides maximum reliability and enables the system to continue running even during a catastrophic memory failure by switching over to the mirrored copy. The installation guidelines to enable Mirror Mode require that the memory modules be identical in size, speed, and technology, and they must be populated in sets of 6 per processor.
Single Rank Spare Mode	Single Rank Spare Mode allocates one rank per channel as a spare. If excessive correctable errors occur in a rank or channel, while the operating system is running, they are moved to the spare area to

Memory Operating Mode

Description

Multi Rank Spare Mode

prevent errors from causing an uncorrectable failure. Requires two or more ranks to be populated in each channel.

Multi Rank Spare Mode allocates two ranks per channel as a spare. If excessive correctable errors occur in a rank or channel, while the operating system is running, they are moved to the spare area to prevent errors from causing an uncorrectable failure. Requires three or more ranks to be populated in each channel.

With single rank memory sparing enabled, the system memory available to the operating system is reduced by one rank per channel.

For example, in a dual-processor configuration with 24x 16 GB dual-rank memory modules, the available system memory is: $\frac{3}{4}$ (ranks/channel) \times 24 (memory modules) \times 16 GB = 288 GB, and not 24 (memory modules) \times 16 GB = 384 GB. For multi rank sparing, the multiplier changes to $\frac{1}{2}$ (ranks/channel).

NOTE: To use memory sparing, this feature must be enabled in the BIOS menu of System Setup.

NOTE: Memory sparing does not offer protection against a multi-bit uncorrectable error.

Dell Fault Resilient Mode

The **Dell Fault Resilient Mode** if enabled, the BIOS creates an area of memory that is fault resilient. This mode can be used by an OS that supports the feature to load critical applications or enables the OS kernel to maximize system availability.

Optimizer Mode

This mode supports Single Device Data Correction (SDDC) only for memory modules that use x4 device width. It does not impose any specific slot population requirements.

- Dual processor: Populate the slots in round robin sequence starting with processor 1.

NOTE: Processor 1 and processor 2 population should match.

Table 44. Memory population rules

Processor	Configuration	Memory population	Memory population information
Single processor	Optimizer (Independent channel) population order	1, 2, 3, 4, 5, 6, 7, 8, 9, 10, 11, 12	<ul style="list-style-type: none">• DIMMs must be populated in the order specified.• Odd number of DIMM population is allowed <p>NOTE: Odd number of DIMMs will result in unbalanced memory configurations, which in turn will result in performance loss. It is recommended to populate all memory channels identically with identical DIMMs for best performance.</p> <ul style="list-style-type: none">• Optimizer population order is not traditional for 4 and 8 DIMM installations of single processor.<ul style="list-style-type: none">– For 4 DIMMs: A1, A2, A4, A5

Processor	Configuration	Memory population	Memory population information
			<ul style="list-style-type: none"> For 8 DIMMs: A1, A2, A4, A5, A7, A8, A10, A11
	Mirror population order	{1, 2, 3, 4, 5, 6} {7, 8, 9, 10, 11, 12}	Mirroring is supported with 6 or 12 DIMMs per processor.
	Single rank sparing population order	1, 2, 3, 4, 5, 6, 7, 8, 9, 10, 11, 12	<ul style="list-style-type: none"> DIMMs must be populated in the order specified. Requires two ranks or more per channel.
	Multi rank sparing population order	1, 2, 3, 4, 5, 6, 7, 8, 9, 10, 11, 12	<ul style="list-style-type: none"> DIMMs must be populated in the order specified. Requires three ranks or more per channel.
	Fault resilient population order	{1, 2, 3, 4, 5, 6} {7, 8, 9, 10, 11, 12}	Supported with 6 or 12 DIMMs per processor.
Dual processor (Start with processor1. processor1 and processor 2 population should match)	Optimized (Independent channel) population order	A{1}, B{1}, A{2}, B{2}, A{3}, B{3}, A{4}, B{4}, A{5}, B{5}, A{6}, B{6}	<p>Odd number of DIMM population per processor is allowed.</p> <p>NOTE: Odd number of DIMMs will result in unbalanced memory configurations, which in turn will result in performance loss. It is recommended to populate all memory channels identically with identical DIMMs for best performance.</p> <p>Optimizer population order is not traditional for 8 and 16 DIMMs installations for dual processor.</p> <ul style="list-style-type: none"> For 8 DIMMs: A1, A2, A4, A5, B1, B2, B4, B5 For 16 DIMMs: A1, A2, A4, A5, A7, A8, A10, A11 B1, B2, B4, B5, B7, B8, B10, B11
	Mirroring population order	A{1, 2, 3, 4, 5, 6}, B{1, 2, 3, 4, 5, 6}, A{7, 8, 9, 10, 11, 12}, B{7, 8, 9, 10, 11, 12}	Mirroring is supported with 6 or 12 DIMMs per processor.
	Single rank sparing population order	A{1}, B{1}, A{2}, B{2}, A{3}, B{3}, A{4}, B{4}, A{5}, B{5}, A{6}, B{6}	<ul style="list-style-type: none"> DIMMs must be populated in the order specified. Requires two ranks or more per channel.
	Multi rank sparing population order	A{1}, B{1}, A{2}, B{2}, A{3}, B{3}, A{4}, B{4}, A{5}, B{5}, A{6}, B{6}	<ul style="list-style-type: none"> DIMMs must be populated in the order specified. Requires three ranks or more per channel.

Processor	Configuration	Memory population	Memory population information
	Fault resilient population order	A{1, 2, 3, 4, 5, 6}, B{1, 2, 3, 4, 5, 6}, A{7, 8, 9, 10, 11, 12}, B{7, 8, 9, 10, 11, 12}	Supported with 6 or 12 DIMMs per processor.

Removing a memory module

The procedure for removing a DIMM module and an NVDIMM-N module is identical.

Prerequisites

- 1 Follow the safety guidelines listed in [Safety instructions](#).
- 2 Follow the procedure listed in [Before working inside your system](#).
- 3 If applicable, [remove the air shroud](#)

⚠ WARNING: Allow the memory modules to cool after you power off the system. Handle the memory modules by the card edges and avoid touching the components or metallic contacts on the memory module.

⚠ CAUTION: To ensure proper system cooling in configurations with mid drive tray, memory module blanks must be installed in any memory socket that is not occupied. Remove memory module blanks only if you intend to install memory modules in those sockets.

ⓘ NOTE: You must follow the thermal restriction while using DIMM blank. For information about thermal restriction, see the [Thermal restrictions](#) section.

Steps

- 1 Locate the appropriate memory module socket.

⚠ CAUTION: Handle each memory module only by the card edges, ensuring not to touch the middle of the memory module or metallic contacts.

- 2 Push the ejectors outward on both ends of the memory module socket to release the memory module from the socket.
- 3 Lift and remove the memory module from the system.

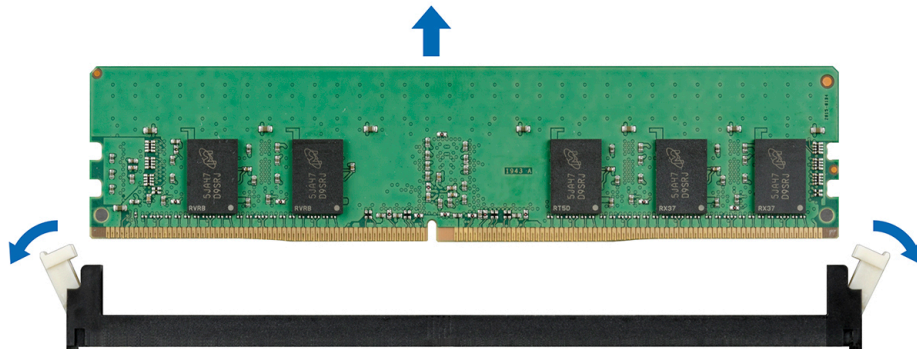

Figure 57. Removing a memory module

Next step

- 1 [Install the memory module](#).

ⓘ NOTE: For single processor systems, install processor/DIMM blank on CPU2 socket.

Installing a memory module

The procedure for installing a DIMM module and an NVDIMM-N module is identical.

Prerequisites

Follow the safety guidelines listed in [Safety instructions](#).

CAUTION: Ensure that you install the NVDIMM-N battery if you are using NVDIMM-N.

CAUTION: To prevent data loss and potential damage to your system, ensure that your system, LEDs on system, LEDs on NVDIMM-N and LEDs on NVDIMM-N battery are turned off before installing the NVDIMM-N battery.

Steps

1 Locate the appropriate memory module socket.

CAUTION: Handle each memory module only by the card edges, ensuring not to touch the middle of the memory module or metallic contacts.

CAUTION: To prevent damage to the memory module or the memory module socket during installation, do not bend or flex the memory module. You must insert both ends of the memory module simultaneously.

2 Open the ejectors on the memory module socket outward to allow the memory module to be inserted into the socket.

3 Align the edge connector of the memory module with the alignment key of the memory module socket, and insert the memory module in the socket.

CAUTION: Do not apply pressure at the center of the memory module; apply pressure at both ends of the memory module evenly.

NOTE: The memory module socket has an alignment key that enables you to install the memory module in the socket in only one orientation.

4 Press the memory module with your thumbs until the socket levers firmly click into place.

Next steps

1 [Install the air shroud](#)

2 Follow the procedure listed in [After working inside your system](#).

3 To verify if the memory module has been installed properly, press F2 and navigate to **System Setup Main Menu > System BIOS > Memory Settings**. In the **Memory Settings** screen, the System Memory Size must reflect the updated capacity of the installed memory.

4 If the value is incorrect, one or more of the memory modules may not be installed properly. Ensure that the memory module is firmly seated in the memory module socket.

5 Run the system memory test in system diagnostics.

Processors and heat sinks

Removing a processor and heat sink module

Prerequisites

WARNING: The heat sink may be hot to touch for some time after the system is powered down. Allow the heat sink to cool before removing it.

1 Follow the safety guidelines listed in [Safety instructions](#).

2 Follow the procedure listed in [Before working inside your system](#).

3 If applicable, [remove the air shroud](#)

4 If applicable, close the PCIe card holder latch on the air shroud to release the full length card.

Steps

- 1 Using a Torx #T30 screwdriver, loosen the screws on the heat sink in the order below:
 - a Loosen the first screw three turns.
 - b Loosen the second screw completely.
 - c Return to the first screw and loosen it completely.

NOTE: It is normal for the heat sink to slip off the blue retention clips when the screws are partially loosened, continue to loosen the screw(s).

- 2 Pushing both blue retention clips simultaneously, lift the processor and heat sink module (PHM) out of the system.
- 3 Set the PHM aside with the processor side facing up.

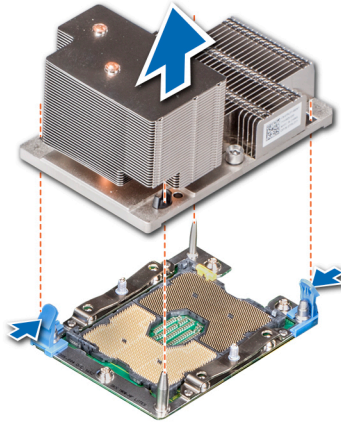

Figure 58. Removing a processor and heat sink module (2U)

Next step

Install the processor and heat sink module.

Removing the processor from the processor and heat sink module

Prerequisites

NOTE: Only remove the processor from the processor and heat sink module if you are replacing the processor or heat sink. This procedure is not required when replacing a system board.

- 1 Follow the safety guidelines listed in [Safety instructions](#).
- 2 Follow the procedure listed in [Before working inside your system](#).
- 3 [Remove the processor and heat sink module](#).

Steps

- 1 Place the heat sink with the processor side facing up.
- 2 Insert a flat blade screwdriver into the release slot marked with a yellow label. Twist (do not pry) the screwdriver to break the thermal paste seal.
- 3 Push the retaining clips on the processor bracket to unlock the bracket from the heat sink.

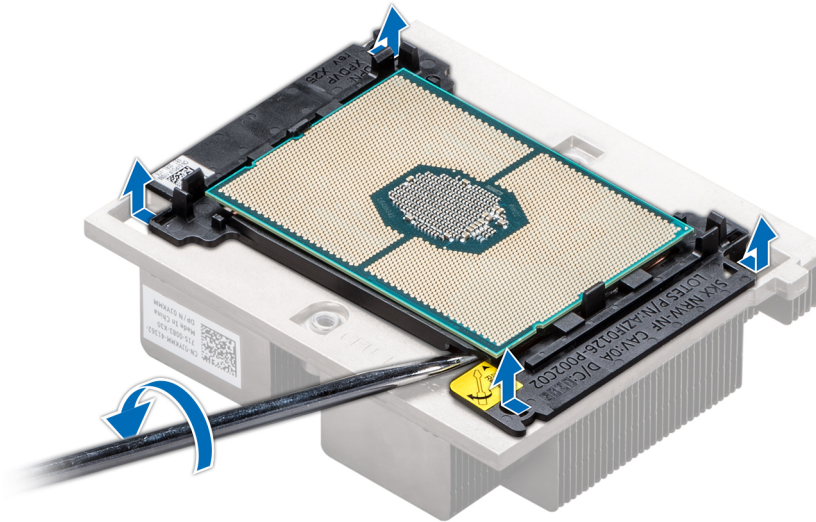

Figure 59. Loosening the processor bracket

- 4 Lift the bracket and the processor away from the heat sink, and place the processor connector side down on the processor tray.
- 5 Flex the outer edges of the bracket to release the bracket from the processor.

NOTE: Ensure that the processor and the bracket are placed in the tray after you remove the heat sink.



Figure 60. Removing the processor bracket

Next step

Install the processor into a processor and heat sink module.

Installing the processor into a processor and heat sink module

Prerequisite

Follow the safety guidelines listed in [Safety instructions](#).

Steps

- 1 Place the processor in the processor tray.
 - ① **NOTE:** Ensure that the pin 1 indicator on the processor tray is aligned with the pin 1 indicator on the processor.
- 2 Flex the outer edges of the bracket around the processor ensuring that the processor is locked into the clips on the bracket.
 - ① **NOTE:** Ensure that the pin 1 indicator on the bracket is aligned with the pin 1 indicator on the processor before placing the bracket on the processor.
 - ① **NOTE:** Ensure that the processor and the bracket are placed in the tray before you install the heat sink.



Figure 61. Installing the processor bracket

- 3 If you are using an existing heat sink, remove the thermal grease from the heat sink by using a clean lint-free cloth.
- 4 Use the thermal grease syringe included with your processor kit to apply the grease in a quadrilateral design on the top of the processor.
 - ⚠ **CAUTION:** Applying too much thermal grease can result in excess grease coming in contact with and contaminating the processor socket.
 - ① **NOTE:** The thermal grease syringe is intended for single use only. Dispose the syringe after you use it.



Figure 62. Applying thermal grease on top of the processor

- 5 Place the heat sink on the processor and push down on the base of the heat sink until the bracket locks onto the heat sink.

NOTE:

- Ensure that the two guide pin holes on the bracket match the guide holes on the heat sink.
- Do not press on the heat sink fins.
- Ensure that the pin 1 indicator on the heat sink is aligned with the pin 1 indicator on the bracket before placing the heat sink onto the processor and bracket.

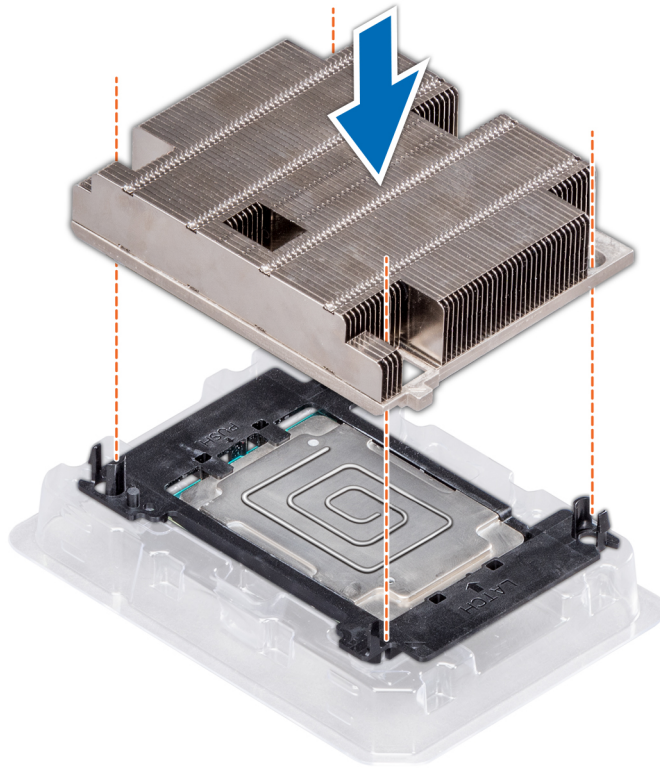

Figure 63. Installing the heat sink onto the processor

Next step

Install the processor and heat sink module.

Installing a processor and heat sink module

Prerequisites

CAUTION: Never remove the heat sink from a processor unless you intend to replace the processor. The heat sink is necessary to maintain proper thermal conditions.

WARNING: The heat sink may be hot to touch for some time after the system has been powered down. Allow the heat sink to cool before removing it.

- 1 Follow the safety guidelines listed in [Safety instructions](#).
- 2 If installed, remove the processor blank and CPU dust cover.
The procedure to remove the processor/DIMM blank is similar to that of the memory module.

Steps

- 1 Align the pin 1 indicator of the heat sink to the system board and then place the processor and heat sink module (PHM) on the processor socket.

CAUTION: To avoid damaging the fins on the heat sink, do not press down on the heat sink fins.

NOTE: Ensure that the PHM is held parallel to the system board to prevent damaging the components.

- 2 Push the blue retention clips inward to allow the heat sink to drop into place.
- 3 Using the Torx #T30 screwdriver, tighten the screws on the heat sink in the order below:

- a Partially tighten the first screw (approximately 3 turns).
- b Tighten the second screw completely.
- c Return to the first screw and tighten it completely.

If the PHM slips off the blue retention clips when the screws are partially tightened, follow these steps to secure the PHM:

- a Loosen both the heat sink screws completely.
- b Lower the PHM on to the blue retention clips, following the procedure described in step 2.
- c Secure the PHM to the system board, following the replacement instructions listed in this step above. 4.

NOTE: The processor and heat sink module retention screws should not be tightened to more than 0.13 kgf-m (1.35 N.m or 12 in-lbf).

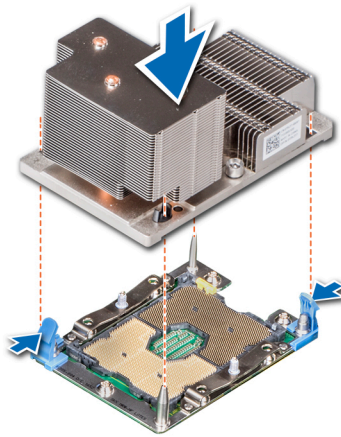

Figure 64. Installing the processor and heat sink module (2U)

Next steps

- 1 If applicable, [install the air shroud](#).

NOTE: If applicable, open the PCIe card holder latch on the air shroud to install the full length card.

- 2 Follow the procedure listed in [After working inside your system](#).

Expansion cards and expansion card risers

Expansion card installation guidelines

NOTE: A System Event Log (SEL) event is logged if an expansion card riser is not supported or missing. It does not prevent your system from turning on. However, if a F1/F2 pause occurs and an error message is displayed.

The PowerEdge R740 system supports up to eight PCI express (PCIe) generation 3 expansion cards, that can be installed on the system board using expansion card risers. The following table provides detailed information about the expansion card riser specifications:

Table 45. Expansion card riser specifications

Riser configuration and supported risers	Slot description	PCIe slots on riser 1 (Height and length)	Processor connection	PCIe slots on riser 2 (Height and length)	Processor connection	PCIe slots on riser 3 (Height and length)	Processor connection
Riser configuration 0 (No riser)	No PCIe slots (only rear storage)	N/A	N/A	N/A	N/A	N/A	N/A
Riser configuration 1 (1B+2B)	Four x8 slots	Slot 1: x8 full-height, full length	Processor 1				
		Slot 2: x8 full-height, full length	Processor 1	Slot 4: x8 low profile, half length	Processor 1	N/A	N/A
		Slot 3: x8 full-height, half length	Processor 1				
Riser configuration 2 (1B+2C)	Three x8 and one x16 slots	Slot 1: x8 full-height, full length	Processor 1				
		Slot 2: x8 full-height, full length	Processor 1	Slot 4: x16 low profile, half length	Processor 2	N/A	N/A
		Slot 3: x8 full-height, half length	Processor 1				
Riser configuration 3 (1A+2A)	Two x8 and three x16 slots	Slot 1: x16 full-height, full length	Processor 1	Slot 4: x16 full-height, full length	Processor 2		
		N/A	N/A	Slot 5: x8 full-height, full length	Processor 2	N/A	N/A
		Slot 3: x16 full-height, half length	Processor 1	Slot 6: x8 low profile, half length	Processor 1		
Riser configuration 4 (1A+2A+3A)	Three x8 and four x16 slots	Slot 1: x16 full-height, full length	Processor 1	Slot 4: x16 full-height, full length	Processor 2	Slot 7: x8 full-height, full length	Processor 2
		N/A	N/A	Slot 5: x8 full-height, full length	Processor 2	Slot 8: x16 full-height, full length	Processor 2
		Slot 3: x16 full-height, half length	Processor 1	Slot 6: x8 low profile, half length	Processor 1		
Riser configuration 5 (1B+2A+3A)	Six x8 and two x16 slots	Slot 1: x8 full-height, full length	Processor 1	Slot 4: x16 full-height, full length	Processor 2	Slot 7: x8 full-height, full length	Processor 2
		Slot 2: x8 full-height, full length	Processor 1	Slot 5: x8 full-height, full length	Processor 2	Slot 8: x16 full-height, full length	Processor 2
		Slot 3: x8 full-height, half length	Processor 1	Slot 6: x8 low profile, half length	Processor 1		
Riser configuration 6 (1D+2A+3A)	Five x8 and three x16 slots	Slot 1: x16 full-height, full length	Processor 1	Slot 4: x16 full-height, full length	Processor 2	Slot 7: x8 full-height, full length	Processor 2
		Slot 2: x8 full-height, full length	Processor 1	Slot 5: x8 full-height, full length	Processor 2	Slot 8: x16 full-height, full length	Processor 2
		Slot 3: x8 full-height, half length	Processor 1	Slot 6: x8 low profile, half length	Processor 1		

Riser configuration and supported risers	Slot description	PCIe slots on riser 1 (Height and length)	Processor connection	PCIe slots on riser 2 (Height and length)	Processor connection	PCIe slots on riser 3 (Height and length)	Processor connection
Riser configuration 9 (1A+2D+3A)	Three x8 and four x16 slots	Slot 1: x16 full-height, full length	Processor 1	Slot 4: x16 full-height, full length	Processor 2	Slot 7: x8 full-height, full length	Processor 2
		N/A	N/A	Slot 5: x8 full-height, full length	Processor 2	Slot 8: x16 full-height, full length	Processor 2
		Slot 3: x16 full-height, half length	Processor 1	Slot 6: x8 low profile, half length	Processor 1		

Table 46. Riser configurations with 4 PCIe slots [Riser configuration 1 (1B+2B) and Riser configuration 2 (1B+2C)]

Card Type	Slot priority	Maximum number of cards
GPU (double width)	N/A	N/A
GPU (single width)	N/A	N/A
PCIe Bridge	4	1
Internal storage adapter	4	1
Express Flash NVMe PCIe SSD adapter	1, 2, 3, 4	4
HCA EDR	4	1
100 GB NIC	4	1
100 G OPA	4	1
HCA FDR	4	1
40 GB NIC	1, 2, 3	3
40 GB NIC	4	1
HBA FC32	1, 2, 3	3
HBA FC32	4	1
25 GB NIC	1, 2, 3	3
25 GB NIC	4	1
HBA FC16	1, 2, 3	3
HBA FC16	4	1
10 GB NIC	1, 2, 3	3
10 GB NIC	4	1
HBA FC8	1, 2, 3	3
HBA FC8	4	1
1 GB NIC	1, 2, 3	3
1 GB NIC	4	1
External storage adapter	1, 2, 3	3
External storage adapter	4	1
BOSS	1, 2, 3	1

Card Type	Slot priority	Maximum number of cards
BOSS	4	1

Table 47. Riser configurations with greater than 4 PCIe slots [Riser configuration 3 (1A+2A), Riser configuration 4 (1A+2A+3A), Riser configuration 5 (1B+2A+3A), Riser configuration 6 (1D+2A+3A) and Riser configuration 9 (1A+2D+3A)]

Card Type	Slot priority	Maximum number of cards
GPU (double width)	1, 8, 4	3
GPU (single width)	1, 8, 4, 7, 2, 5	6
PCIe Bridge	1, 3, 4, 8	3
Internal storage adapter	6, 5	1
Express Flash NVMe PCIe SSD adapter	7, 2, 3, 5, 1, 8, 4, 6	6
HCA EDR	1, 8, 4	3
100 GB NIC	1, 8, 4	3
100 G OPA	1, 8, 4	3
HCA FDR	6	1
40 GB NIC	7, 2, 3, 5, 1, 8, 4	7
40 GB NIC	6	1
HBA FC32	7, 2, 3, 5, 1, 8, 4	7
HBA FC32	6	1
25 GB NIC	7, 2, 3, 5, 1, 8, 4	3
25 GB NIC	6	1
HBA FC16	7, 2, 3, 5, 1, 8, 4	7
HBA FC16	6	1
10 GB NIC	7, 2, 3, 5, 1, 8, 4	7
10 GB NIC	6	1
HBA FC8	7, 2, 3, 5, 1, 8, 4	7
HBA FC8	6	1
1 GB NIC	7, 2, 3, 5, 1, 8, 4	7
1 GB NIC	6	1
External storage adapter	7, 2, 3, 5, 1, 8, 4	7
External storage adapter	6	1
BOSS	7, 2, 3, 5, 1, 8, 4	1
BOSS	6	1
Internal storage	7, 2, 3, 5, 1, 8, 4, 6	6

NOTE: For information about slot form factor, see the Expansion card riser configurations table.

NOTE: The expansion card slots are not hot-swappable.

- ① **NOTE:** Double width GPUs are supported only on riser configuration 4, and single width GPUs are supported only on riser configuration 6.
- ① **NOTE:** Ensure that x16 cards are installed only in x16 slots. Depending on the riser configuration slots 2, 7, or 8 may not be available.
- ① **NOTE:** Only half length PCIe cards are supported on riser 2 when NVDIMM-Ns with NVDIMM-N battery are installed on the air shroud.
- ① **NOTE:** For configurations that support GPU, maximum four single-wide and two double-wide GPUs are supported when NVDIMM-Ns with NVDIMM-N battery are installed. Since NVDIMM-N battery is installed on the GPU shroud, GPUs are not supported on riser 2.

Opening and closing the PCIe card holder latch

Before installing or removing a full length PCIe card, the PCIe card holder latch must be closed. When the full length PCIe card is installed, open the PCIe card holder latch.

Prerequisites

- 1 Follow the safety guidelines listed in [Safety instructions](#).
- 2 Follow the procedure listed in [Before working inside your system](#).

Steps

- 1 To open the PCIe card holder latch, press the release tab.



Figure 65. Opening the PCIe card holder latch

- 2 To close the PCIe card holder latch, push the latch until it locks.



Figure 66. Closing the PCIe card holder latch

Next step

Follow the procedure listed in [After working inside your system.](#)

Removing expansion card from the expansion card riser

Prerequisites

- 1 Follow the safety guidelines listed in [Safety instructions.](#)
- 2 Follow the procedure listed in [Before working inside your system.](#)
- 3 If applicable, [remove the air shroud.](#)
- 4 If applicable, disconnect the cables from the expansion card.
- 5 When removing a card from riser 2 or 3, ensure that the PCIe card holder latch is closed.

Steps

- 1 Pull the expansion card latch out of the slot.
- 2 Hold the expansion card by its edges, and pull the card until the card edge connector disengages from the expansion card connector on the riser.

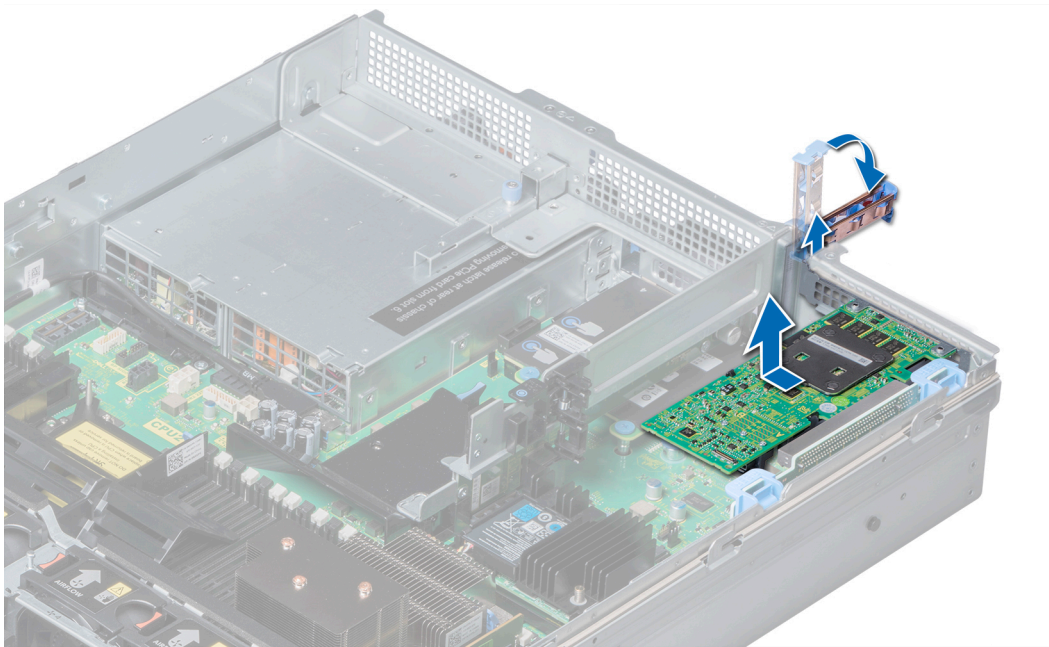

Figure 67. Removing the expansion card from expansion card riser 1

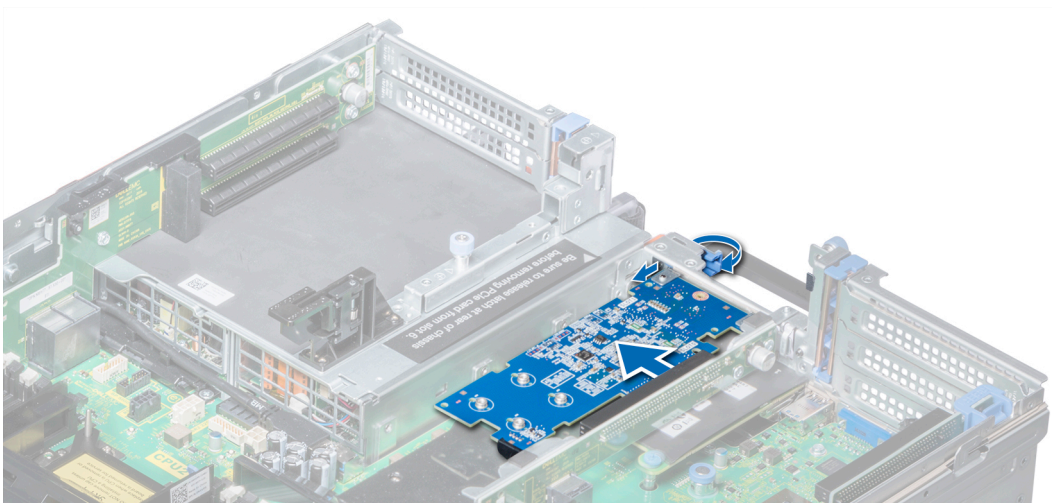

Figure 68. Removing the expansion card from expansion card riser 2B

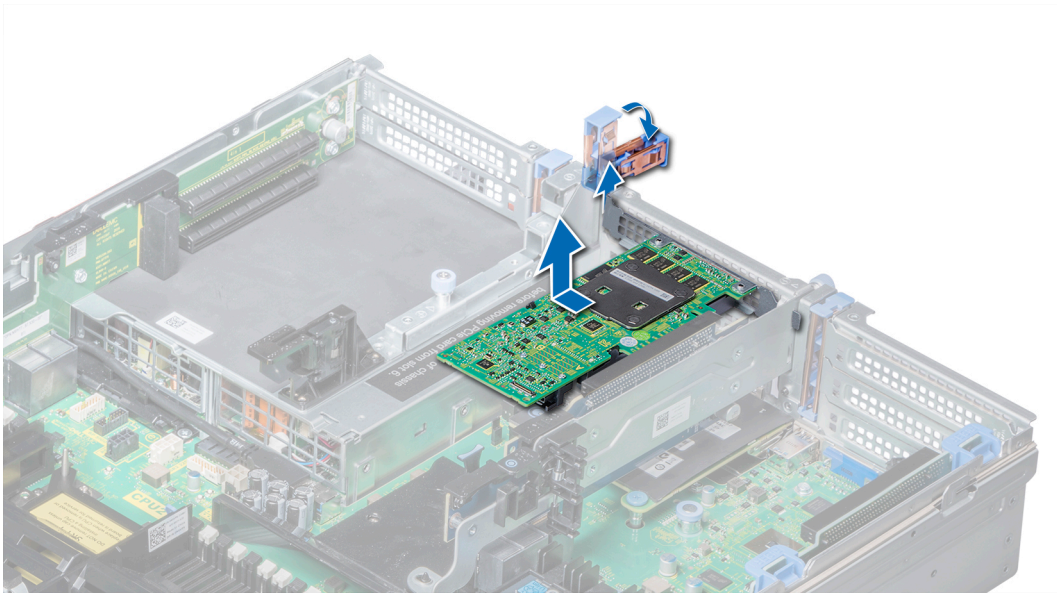

Figure 69. Removing the expansion card from expansion card riser 2

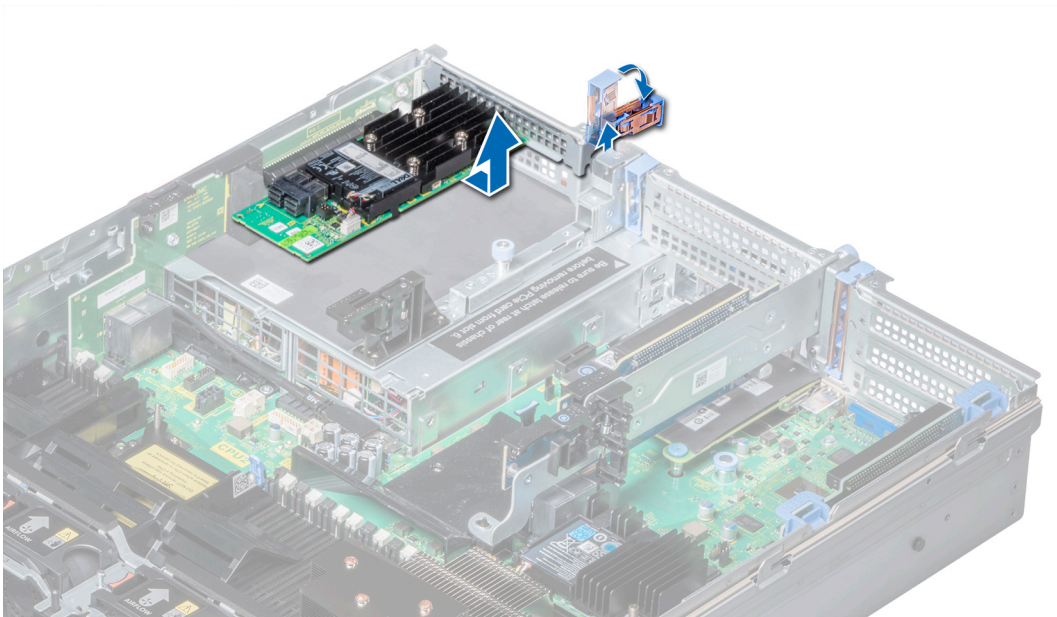

Figure 70. Removing the expansion card from expansion card riser 3

Next steps

- 1 Install the expansion card into the expansion card riser.
- 2 If you are removing the card permanently, install a metal filler bracket over the empty expansion slot opening and push the expansion card latch.

NOTE: You must install a filler bracket over an empty expansion card slot to maintain Federal Communications Commission (FCC) certification of the system. The brackets also keep dust and dirt out of the system and aid in proper cooling and airflow inside the system.

Installing expansion card into the expansion card riser

Prerequisites

- 1 Follow the safety guidelines listed in [Safety instructions](#).
- 2 If installing a new expansion card, unpack it and prepare the card for installation.
NOTE: For instructions, see the documentation accompanying the card.
- 3 When installing a card into riser 2 or 3, open the PCIe card holder latch.

Steps

- 1 Pull the expansion card latch.
- 2 If installed, remove the filler bracket.
NOTE: Store the filler bracket for future use. Filler brackets must be installed in empty expansion card slots to maintain Federal Communications Commission (FCC) certification of the system. The brackets also keep dust and dirt out of the system and aid in proper cooling and airflow inside the system.
- 3 Hold the card by its edges, and align the card edge connector with the expansion card connector on the riser.
- 4 Insert the card edge connector firmly into the expansion card connector until the card is fully seated.
- 5 Push the expansion card latch.

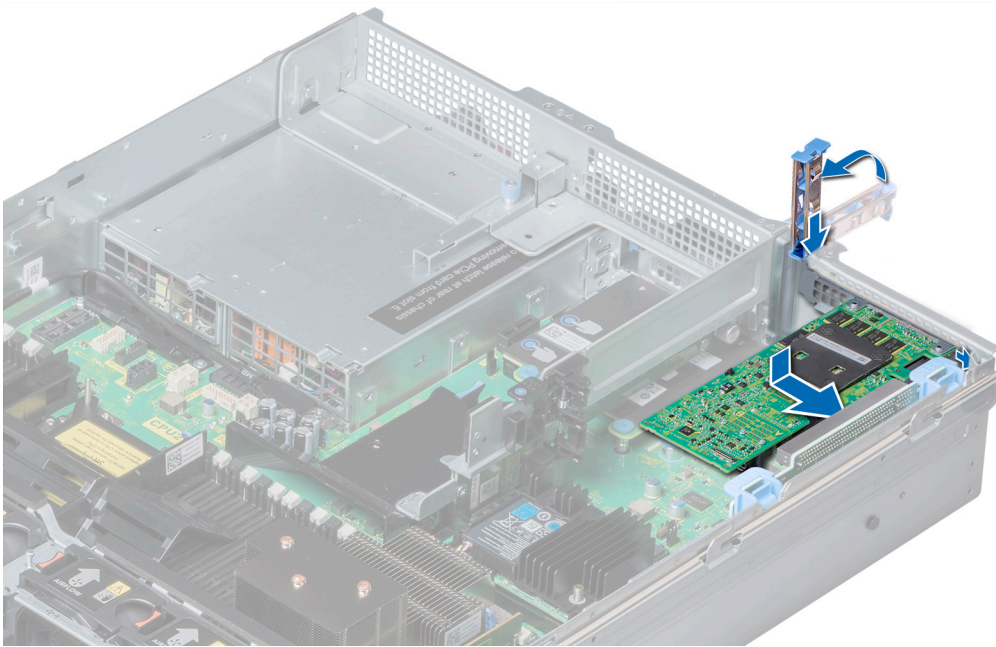

Figure 71. Installing expansion card into expansion card riser 1

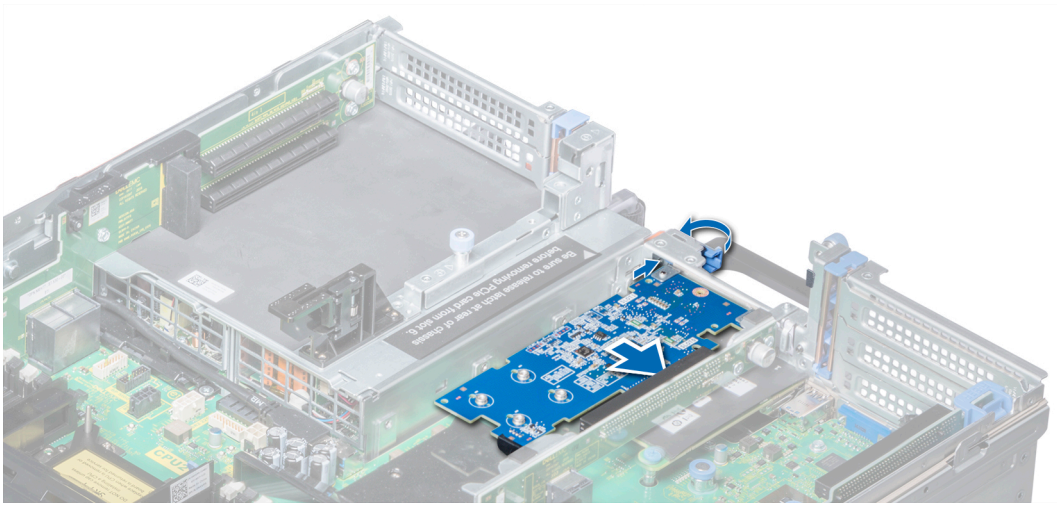

Figure 72. Installing expansion card into expansion card riser 2B

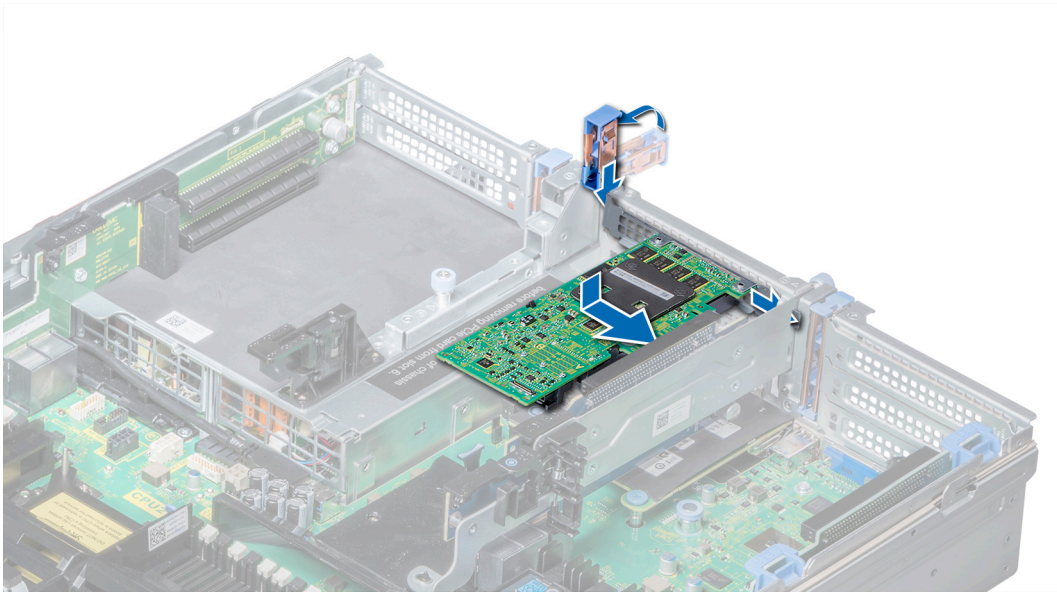

Figure 73. Installing expansion card into expansion card riser 2

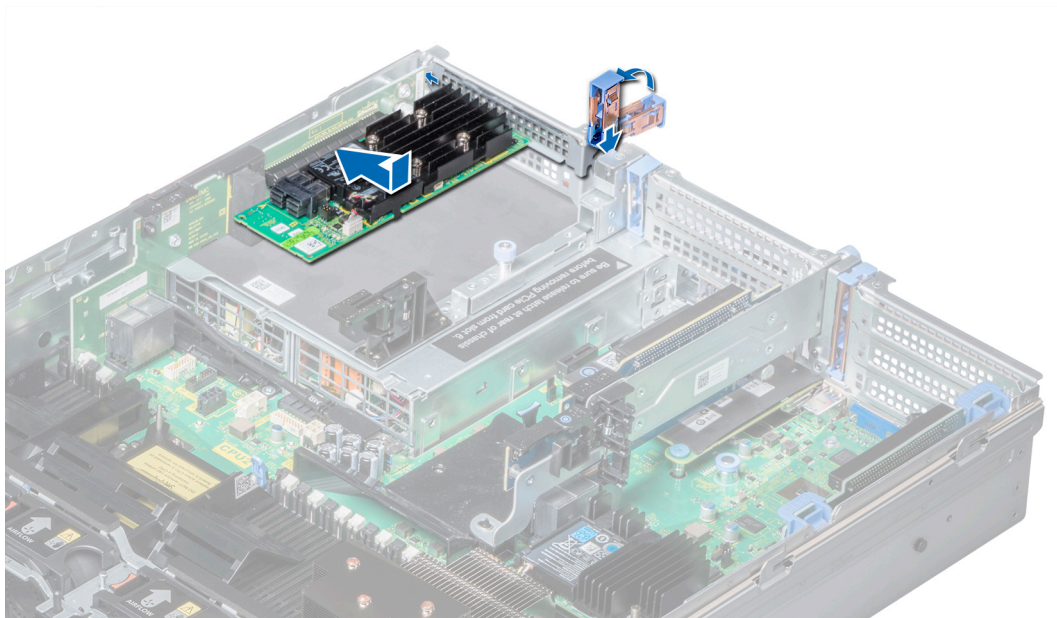

Figure 74. Installing expansion card into expansion card riser 3

Next steps

- 1 If applicable, connect the cables to the expansion card.
- 2 If applicable, [install the air shroud](#).
- 3 Follow the procedure listed in [After working inside your system](#).
- 4 Install any device drivers required for the card as described in the documentation for the card.

Removing riser 2 and 3 blank

Prerequisites

- 1 Follow the safety guidelines listed in [Safety instructions](#).
- 2 Follow the procedure listed in [Before working inside your system](#).
- 3 [Remove the air shroud](#).

Steps

- 1 Using Phillips #2 screwdriver, loosen the screws (3) that secure the blank to the system.
- 2 Press the release tab, and holding the blank by its edges, lift the blank away from the system.

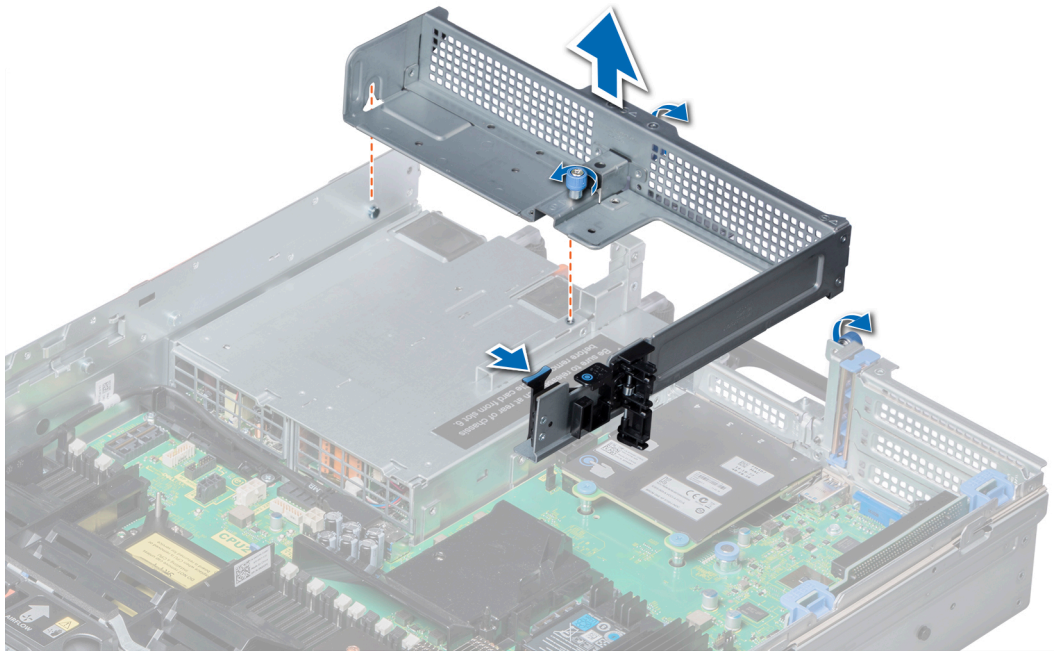

Figure 75. Removing riser 2 and 3 blank

Next step

Install the riser 2 and 3 blank.

Installing riser 2 and 3 blank

Prerequisite

Follow the safety guidelines listed in [Safety instructions](#).

Steps

- 1 Align the screw and guide rail on the riser blank with the screw hole and standoff on the system.
- 2 Lower the blank into the system until the release tab clicks into place.
- 3 Tighten the screws to secure the riser blank to the system.

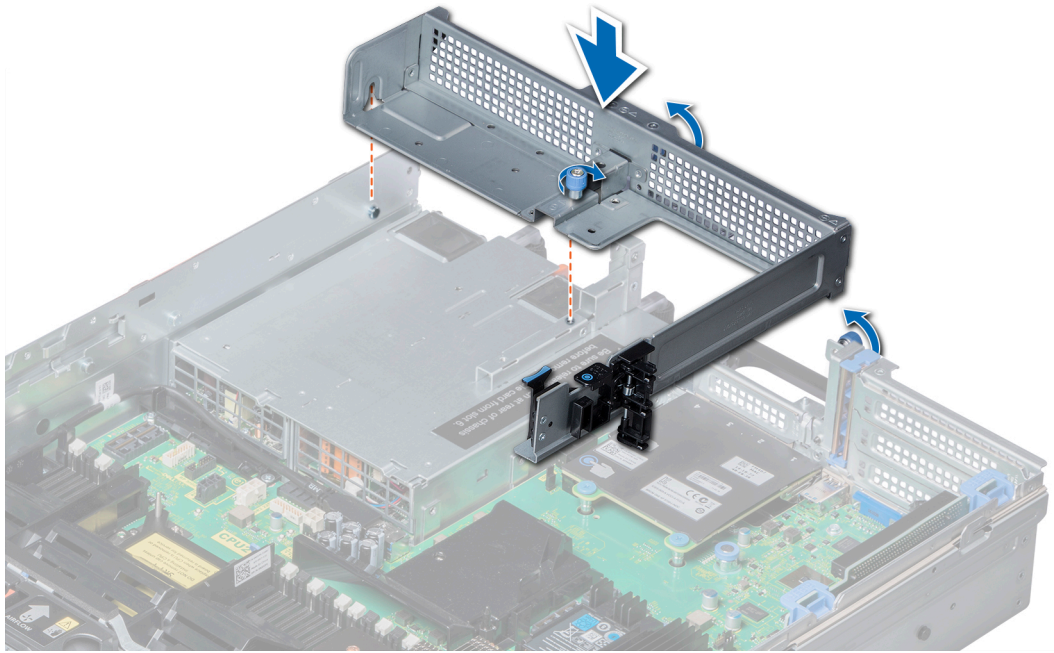

Figure 76. Installing riser 2 and 3 blank

Next steps

- 1 [Install the air shroud.](#)
- 2 Follow the procedure listed in [After working inside your system.](#)

Removing riser 3 blank

Prerequisites

- 1 Follow the safety guidelines listed in [Safety instructions.](#)
- 2 Follow the procedure listed in [Before working inside your system.](#)

Steps

- 1 Using Phillips #2 screwdriver, loosen the screw that secures the blank to the system.
- 2 Lift the blank away from the system.

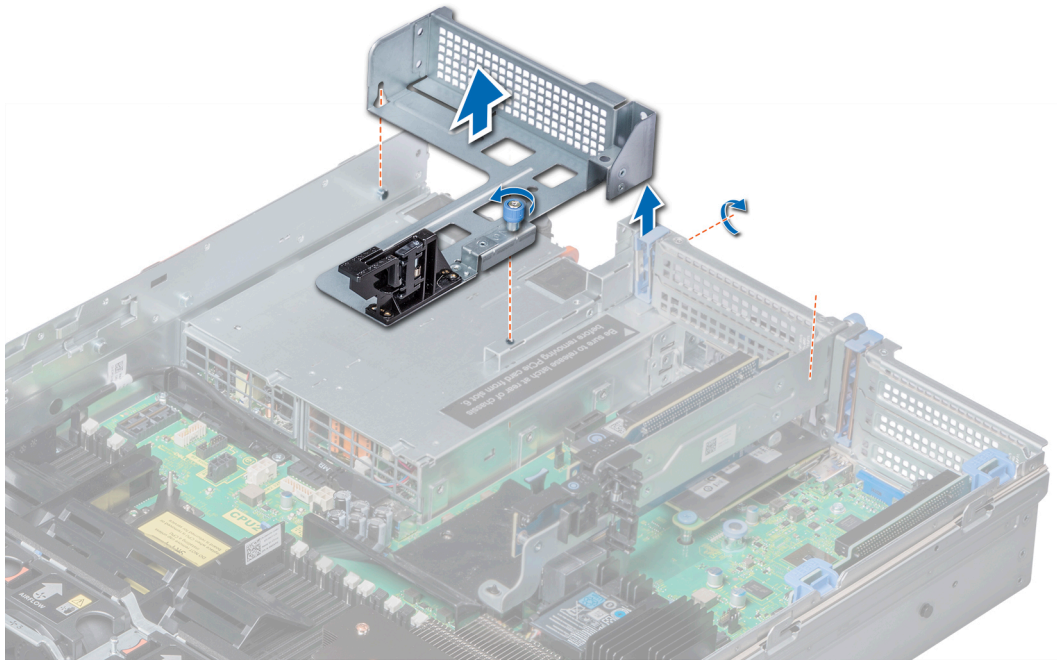

Figure 77. Removing riser 3 blank

Next step

Install the riser 3 blank.

Installing riser 3 blank

Prerequisite

Follow the safety guidelines listed in [Safety instructions](#).

Steps

- 1 Align the screw on the riser with the screw hole on the system.
- 2 Using Phillips #2 screwdriver, tighten the screw to secure the blank to the system.

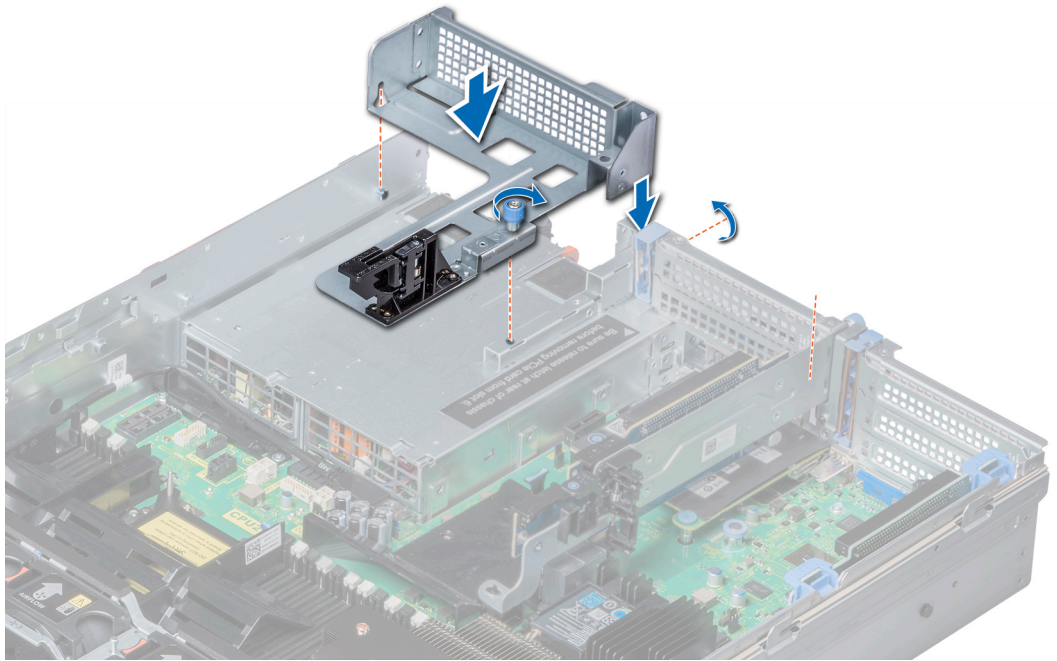

Figure 78. Installing riser 3 blank

Next step

Follow the procedure listed in [After working inside your system](#).

Removing expansion card riser 1

Prerequisites

- 1 Follow the safety guidelines listed in [Safety instructions](#).
- 2 Follow the procedure listed in [Before working inside your system](#).
- 3 If installed, [remove the expansion cards from the riser](#).
- 4 Disconnect any cables connected to the riser.

Step

Press the release latches, and lift the riser from the riser connector on the system board.

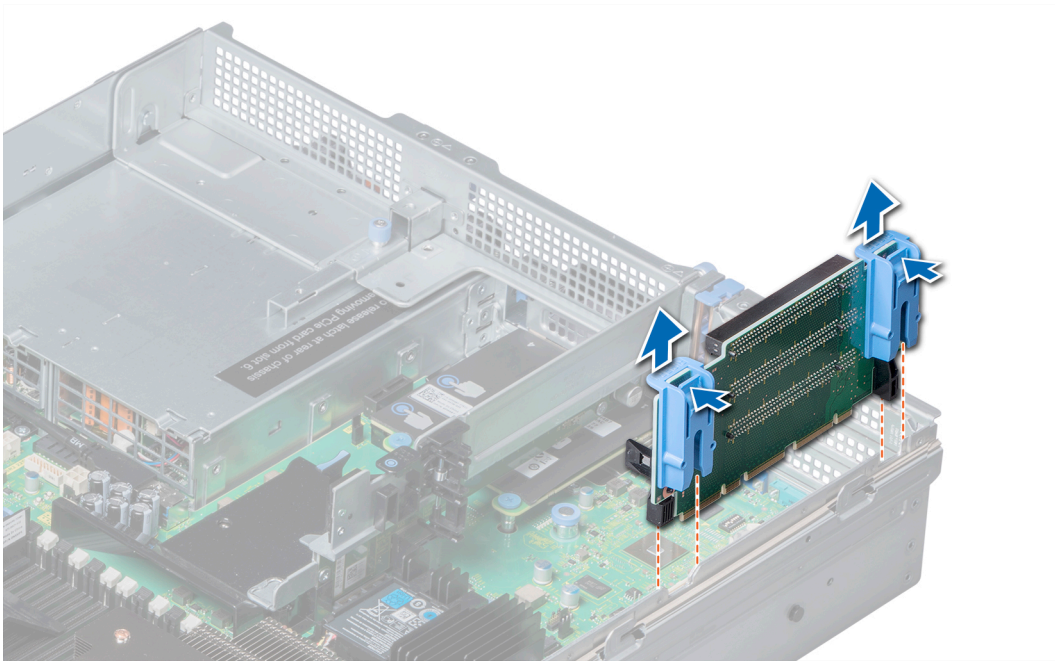

Figure 79. Removing expansion card riser 1

Next step

Install the expansion card riser 1.

Installing expansion card riser 1

Prerequisite

Follow the safety guidelines listed in [Safety instructions](#).

Steps

- 1 Align the guide rails on the riser with the standoffs on the side of the system.
- 2 Lower the riser into the system until the riser connector engages with the connector on the system board.

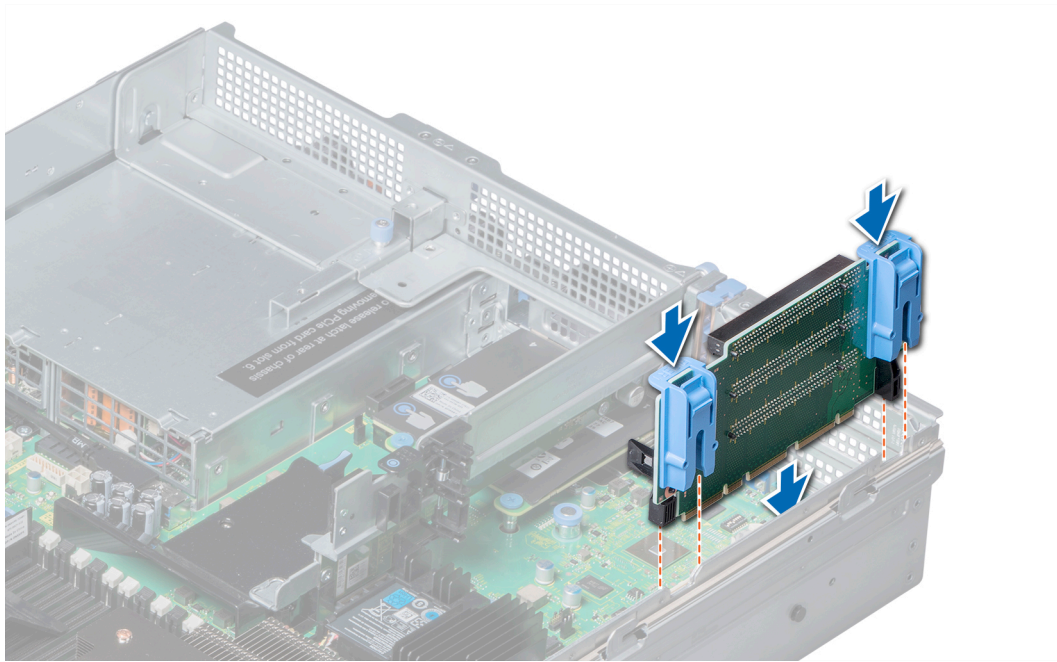

Figure 80. Installing expansion card riser 1

Next steps

- 1 If removed, [install expansion cards into the riser](#).
- 2 Follow the procedure listed in [After working inside your system](#).
- 3 Install any device drivers required for the card as described in the documentation for the card.

Removing expansion card riser 2

Prerequisites

- 1 Follow the safety guidelines listed in [Safety instructions](#).
- 2 Follow the procedure listed in [Before working inside your system](#).
- 3 If applicable, close the PCIe card holder latch on the air shroud to release the full length card.
- 4 If installed, [remove expansion cards installed on the riser](#).
- 5 [Remove the air shroud](#).
- 6 Disconnect any cables connected to the riser.

Steps

- 1 To remove expansion card riser 2A:
 - a Using Phillips #2 screwdriver, loosen the screws that secure the riser to the system.
 - b Press the release tab, and holding the riser by its edges, lift the riser from the riser connector on the system board.

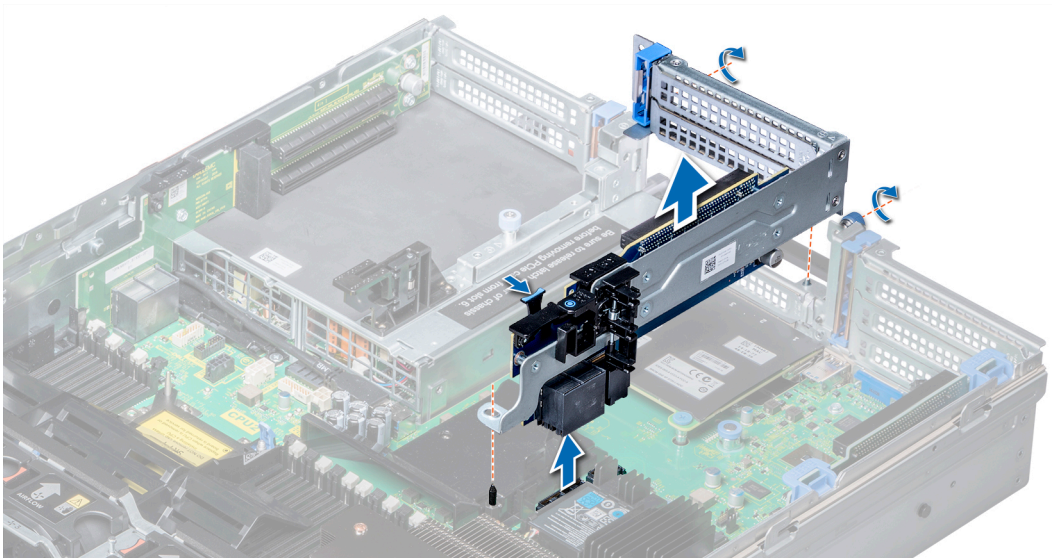

Figure 81. Removing expansion card riser 2A

- 2 To remove expansion card riser 2B or 2C, hold the riser by its edges and lift the riser from the riser connector on the system board.

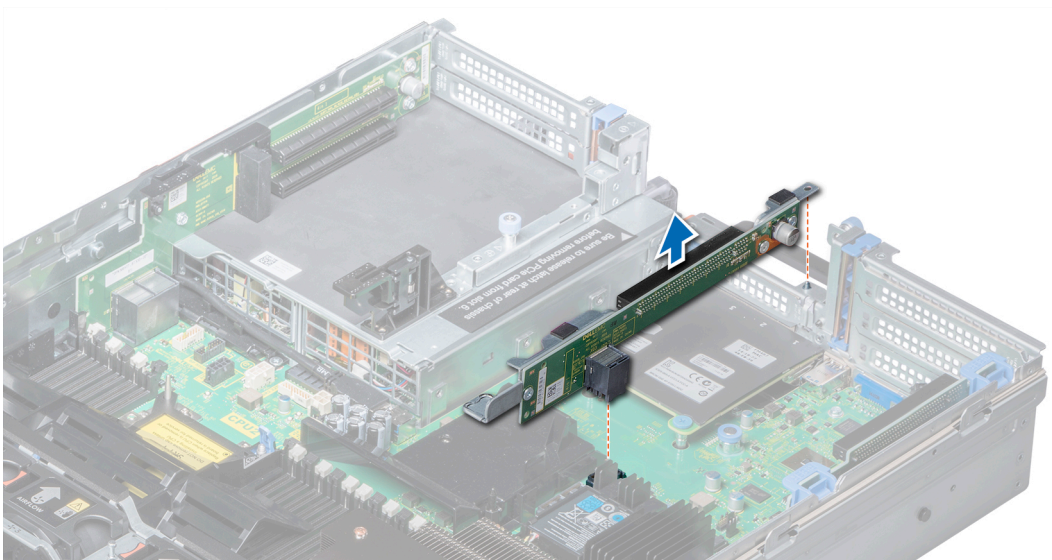

Figure 82. Removing expansion card riser 2

Next step

Install the expansion card riser 2.

Installing expansion card riser 2

Prerequisite

Follow the safety guidelines listed in [Safety instructions](#).

Steps

- 1 To install expansion card riser 2A:
 - a Align the screw and tab on the riser with the screw hole and slot on the system.

- b Lower the riser into the system until the riser connector engages with the connector on the system board.
- c Using Phillips #2 screwdriver, tighten the screws to secure the riser to the system.

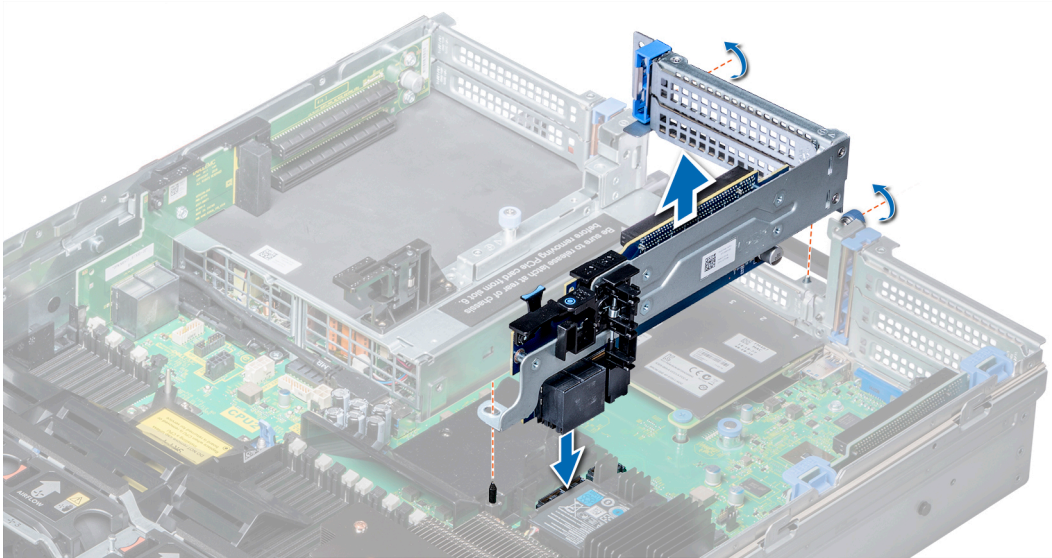

Figure 83. Installing expansion card riser 2A

- 2 To install expansion card riser 2B or 2C:
 - a Align the slot on the riser with the standoff on the system.
 - b Lower the riser into the system until the riser card connector engages with the connector on the system board.

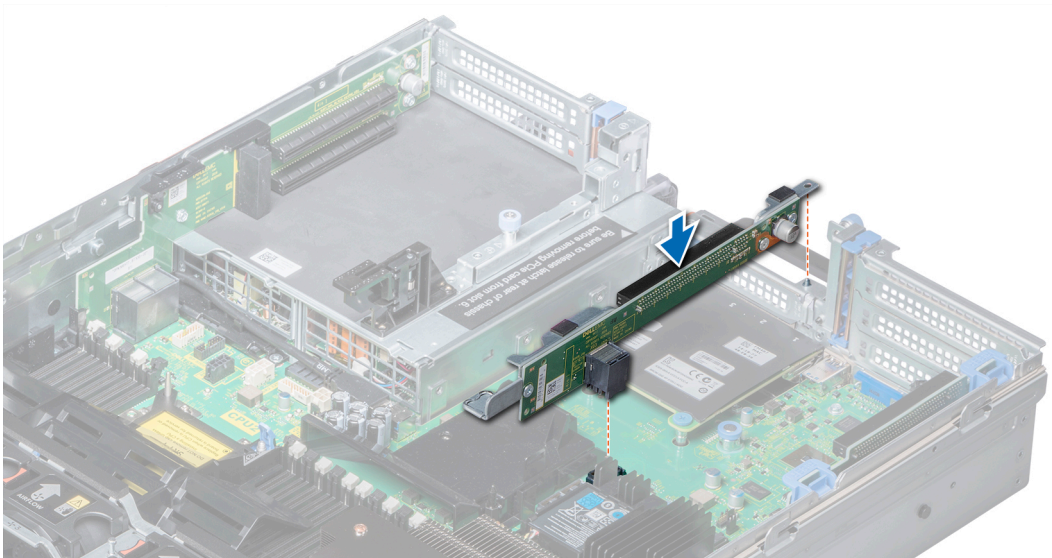

Figure 84. Installing expansion card riser 2

Next steps

- 1 [Install the air shroud.](#)
- 2 If removed, [install expansion cards into the riser.](#)
- 3 If applicable, open the PCIe card holder latch on the air shroud to install the full length card.
- 4 Follow the procedure listed in [After working inside your system.](#)
- 5 Install any device drivers required for the card as described in the documentation for the card.

Removing expansion card riser 3

Prerequisites

- 1 Follow the safety guidelines listed in [Safety instructions](#).
- 2 Follow the procedure listed in [Before working inside your system](#).
- 3 [Remove the air shroud](#).

NOTE: If applicable, close the PCIe card holder latch on the air shroud to release the full length card.

- 4 If installed, remove expansion cards installed on the riser.
- 5 Disconnect any cables connected to the riser card.

Steps

- 1 Using Phillips #2 screwdriver, loosen the screw that secures the riser to the system.
- 2 Press the release tab, and holding the riser by its edges, lift the riser from the riser connector on the system board.

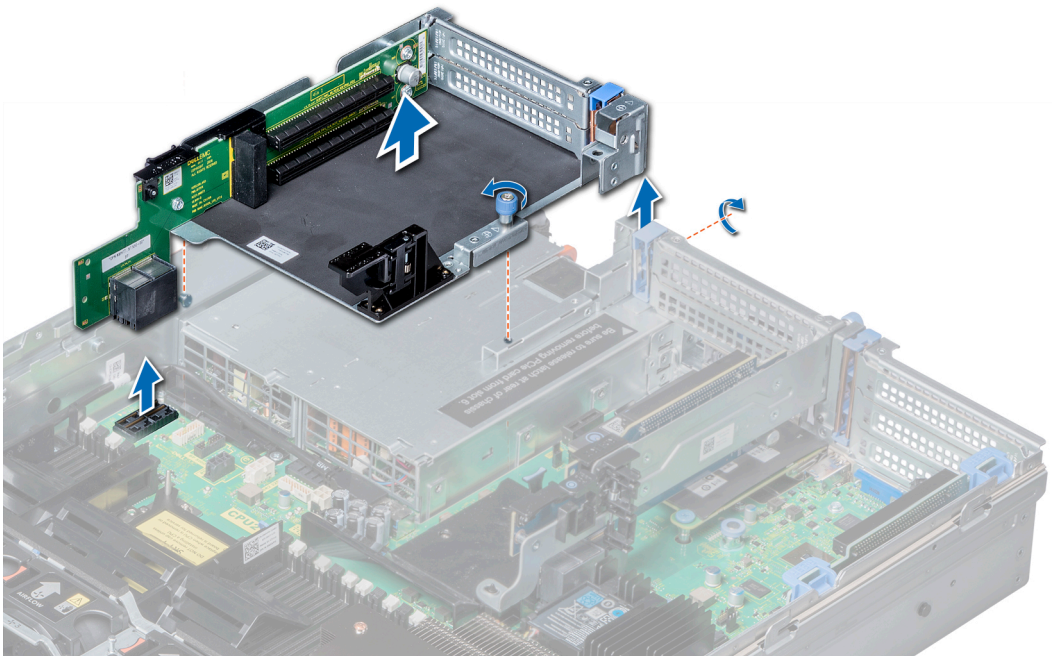

Figure 85. Removing expansion card riser 3

Next step

[Install expansion card riser 3.](#)

Installing expansion card riser 3

Prerequisite

Follow the safety guidelines listed in [Safety instructions](#).

Steps

- 1 Align the tab on the riser with the slot on the system, and guide rails on the riser with the standoffs on the side of the system.
- 2 Lower the riser into the system until the riser edge connector engages with the connector on the system board.
The riser card edge engages with the riser guide on the system.

- Using Phillips #2 screwdriver, tighten the screw to secure the riser to the system.

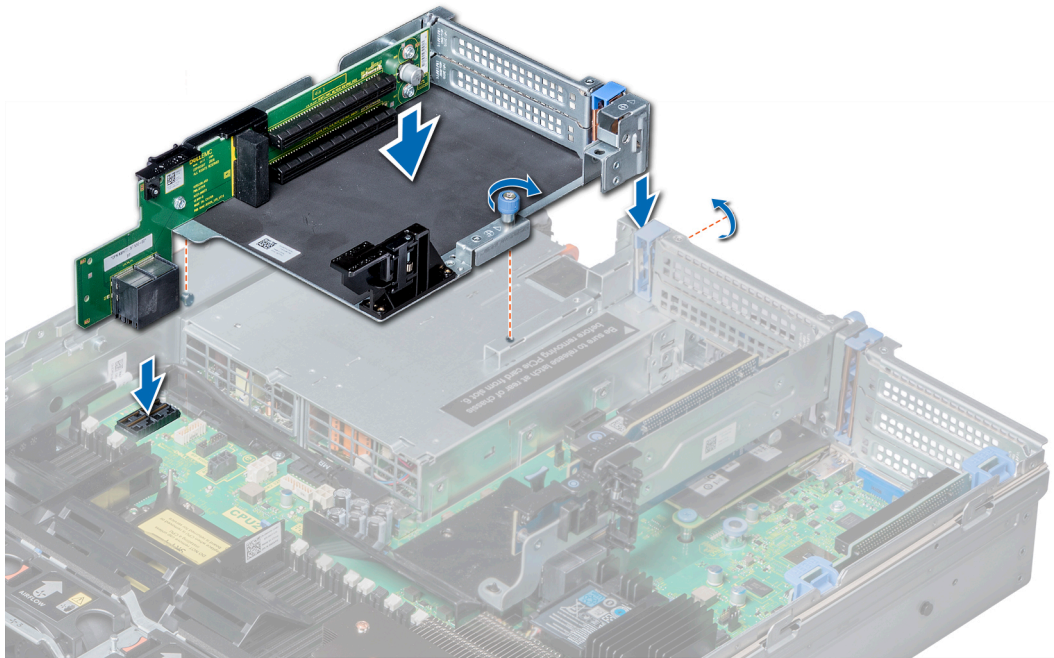

Figure 86. Installing expansion card riser 3

Next steps

- If removed, install expansion cards into the riser.
- Install the air shroud.
 - NOTE:** If applicable, open the PCIe card holder latch on the air shroud to install the full length card.
- Follow the procedure listed in [After working inside your system](#).
- Install any device drivers required for the card as described in the documentation for the card.

GPU card installation guidelines

- Ensure that both the processors are installed.
- The processor must use a GPU kit low-profile processor and heat sink module.
- To ensure adequate cooling when one or more GPUs are installed, the ambient inlet temperature is restricted to 30°C for CPU 150 W/8 C, 165 W/12 C, 200 W, 205 W. For more information, see the [ambient temperature limitations](#) section.
- Ensure that the GPU enablement kit is available.

The GPU enablement kit includes:

- GPU air shroud
- Mylar
- Riser 3A
- GPU cable for riser 3A
- GPU cable for riser 2A
- Riser 2A
- Riser 1A or 1D
- GPU cable for riser 1A or 1D
- Two 1U processor and heat sink modules and two CPU clips

- Six high performance cooling fans
- All GPUs must be of the same type and model.
- You can install up to three double-wide or six single-wide GPUs.
- The filler bracket on the GPU air shroud must be removed before installing the GPU.
- Ensure that high performance fans and GPU air shroud are installed.

① **NOTE:** When using systems with GPU, ensure that you install PSUs with 1100 W or higher, and set the PSU configuration to non-redundant mode.

Removing a GPU

Prerequisites

- 1 Follow the safety guidelines listed in [Safety instructions](#).
- 2 Follow the procedure listed in [Before working inside your system](#).
- 3 Press the blue tabs on either sides of the shroud and remove the top cover of the GPU air shroud.

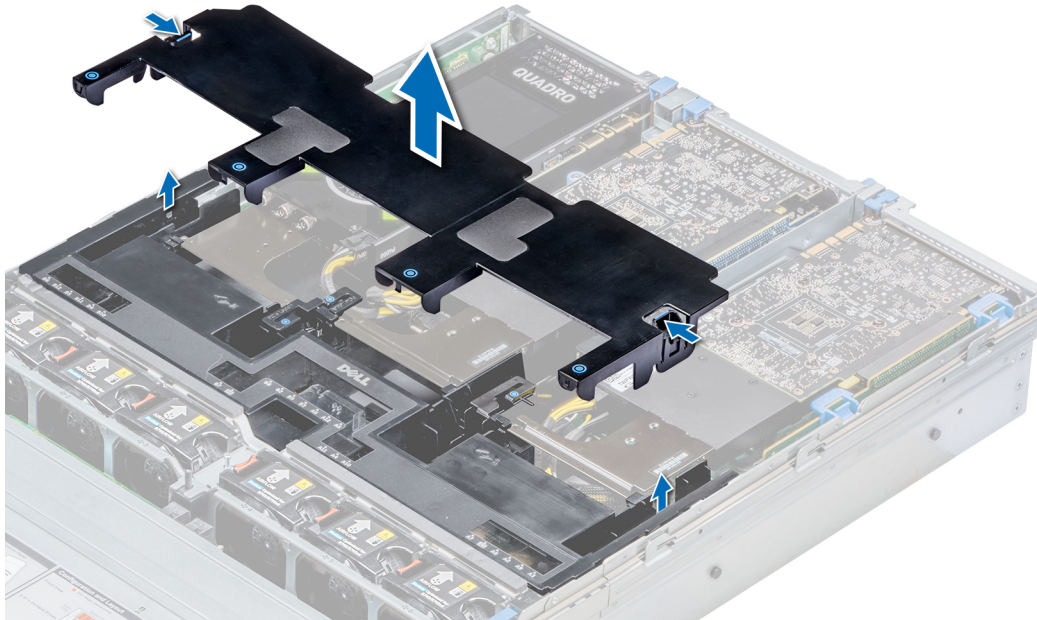

Figure 87. Removing the top cover of GPU air shroud

Steps

- 1 Lift the expansion card latch.
- 2 Close the PCIe card holder latch on the GPU air shroud.
- 3 Hold the GPU by its edges and slide out the GPU at an angle to release it from the connector on the riser.

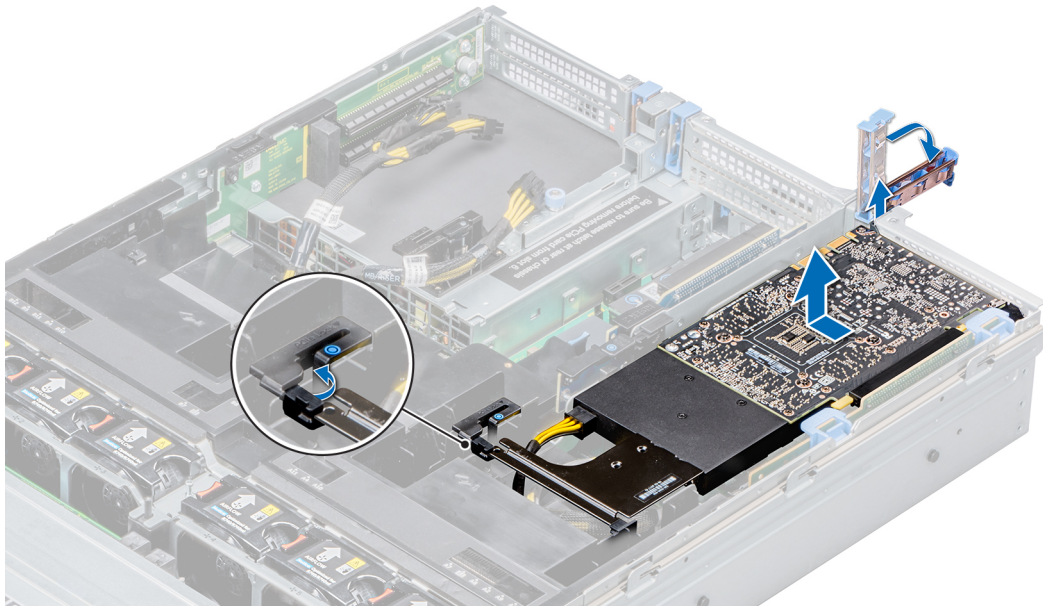

Figure 88. Removing GPU 1

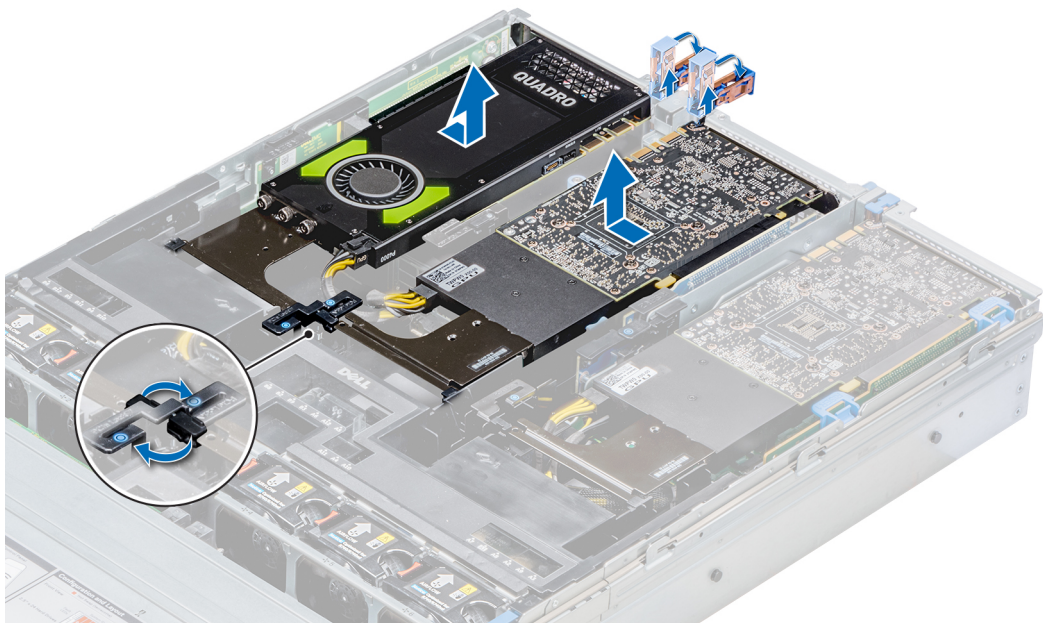

Figure 89. Removing GPU 2 and 3

- 4 Disconnect the GPU power cable from the GPU and system board.
- 5 If you are removing the GPU permanently, install a filler bracket over the empty slot opening, and close the expansion card latch.

NOTE: You must install a filler bracket over an empty expansion card slot to maintain Federal Communications Commission (FCC) certification of the system. The brackets also keep dust and dirt out of the system and aid in proper cooling and airflow inside the system. The filler bracket is necessary to maintain proper thermal conditions.

Next step
Install the GPU card.

Installing a GPU

Prerequisites

- 1 Follow the safety guidelines listed in [Safety instructions](#).
- 2 [Remove the air shroud](#).
- 3 [Remove the heat sink](#).
- 4 [Remove the cooling fans](#) and replace them with [Install the cooling fans](#).
- 5 Unpack the GPU cards and the GPU kit.
- 6 [Install the heat sink](#) from the kit.
- 7 [Install the risers](#).
- 8 Install the GPU air shroud on the system.

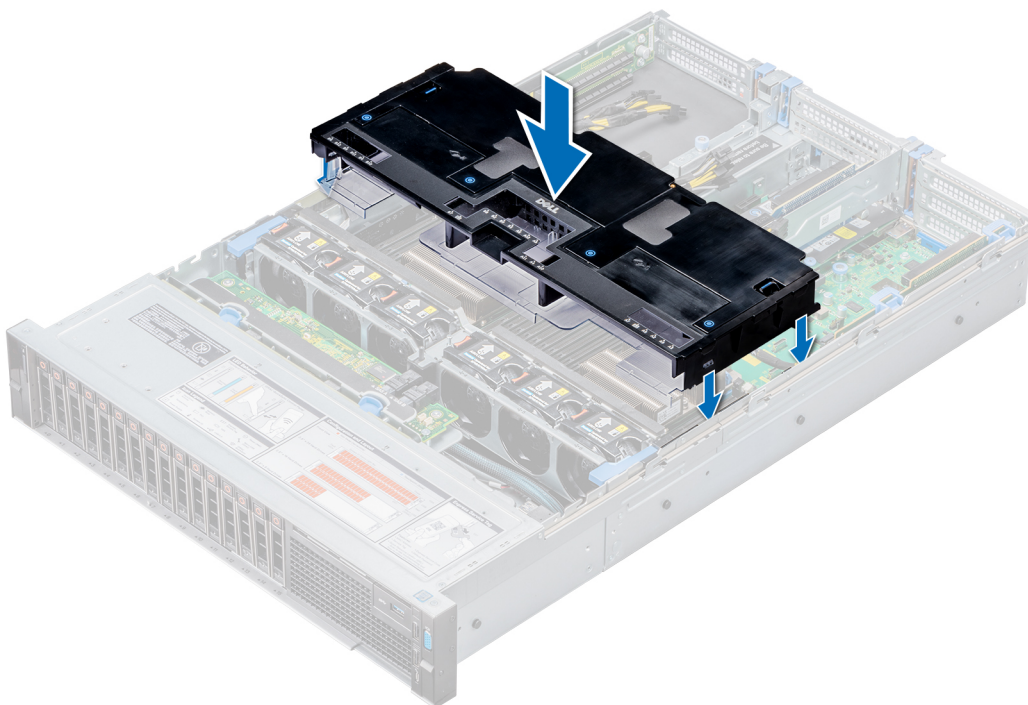

Figure 90. Installing GPU air shroud

- 9 Press the blue tabs on either sides of the shroud and remove the top cover of the shroud.

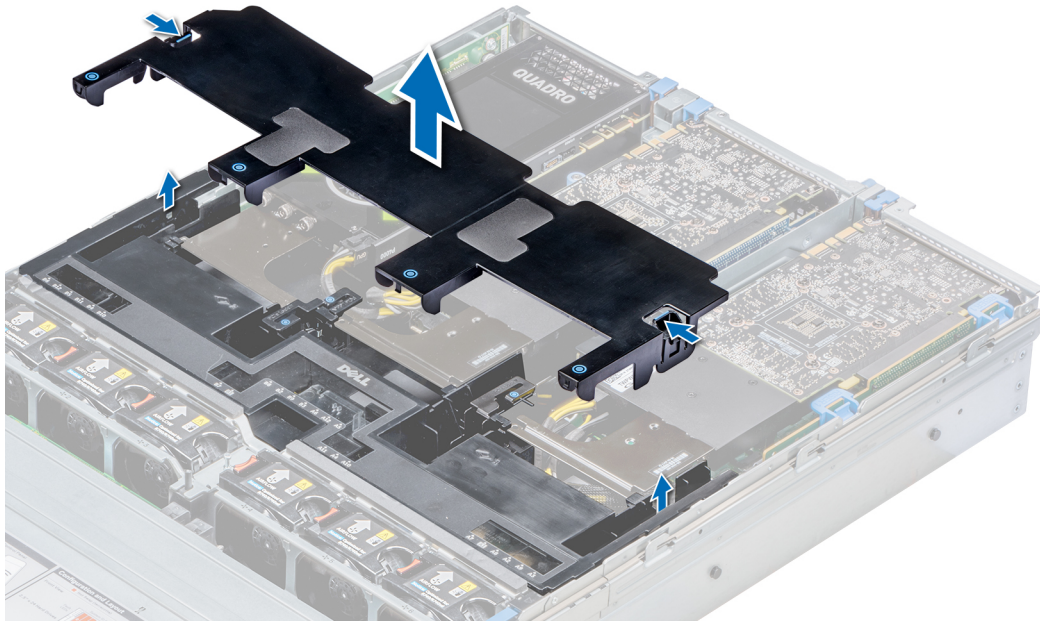

Figure 91. Removing the top cover of the shroud

10 If applicable, remove the shroud filler from the GPU air shroud slots.

NOTE: Shroud fillers are available in the GPU air shroud for GPUs installed on riser 2 and 3.

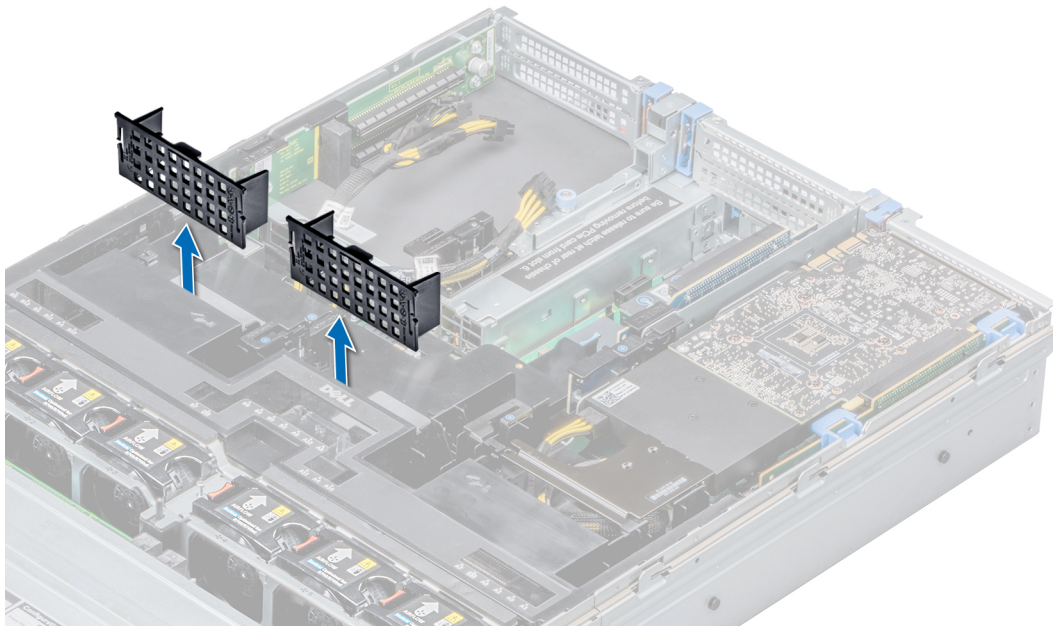

Figure 92. Removing the shroud filler from GPU air shroud slots

NOTE: Shroud fillers are available in the GPU air shroud for GPUs installed only on risers 2 and 3.

NOTE: Ensure that the PCIe card holder latches on GPU air shroud and risers are closed before installing the GPU. Full-length GPU do not require the PCIe card holder latch on the risers to secure the GPU in place.

① **NOTE:** Ensure that you install the first GPU on riser 1.

① **NOTE:** While installing a GPU on riser 3, place the GPU on the system with the GPU label side facing up.

Steps

1 Connect the GPU power cable to the connector on the system board.

① **NOTE:**

While installing a GPU on riser 1, connect the GPU power cable to the connector on riser 1 and route the cable through the slot on the GPU air shroud.

While installing a GPU on risers 2 or riser 3, connect the GPU power cable to the connector on the system board.

2 Connect the other end of the GPU power cable to the GPU.

3 Lift the expansion card latch and remove the filler bracket.

① **NOTE:** You must install a filler bracket over an empty expansion card slot to maintain Federal Communications Commission (FCC) certification of the system. The brackets also keep dust and dirt out of the system and aid in proper cooling and airflow inside the system.

① **NOTE:** The filler bracket is necessary to maintain proper thermal conditions.

4 Align the connector on the GPU with the connector on the riser.

5 Insert the GPU into the riser until it is fully seated.

6 Press the PCIe lock on the GPU air shroud and riser to release the PCIe card holder latch.

① **NOTE:** Ensure that the GPU edges are seated properly in the GPU air shroud slot and PCIe card holder latch to secure the GPU in place.

7 Close the expansion card latch.

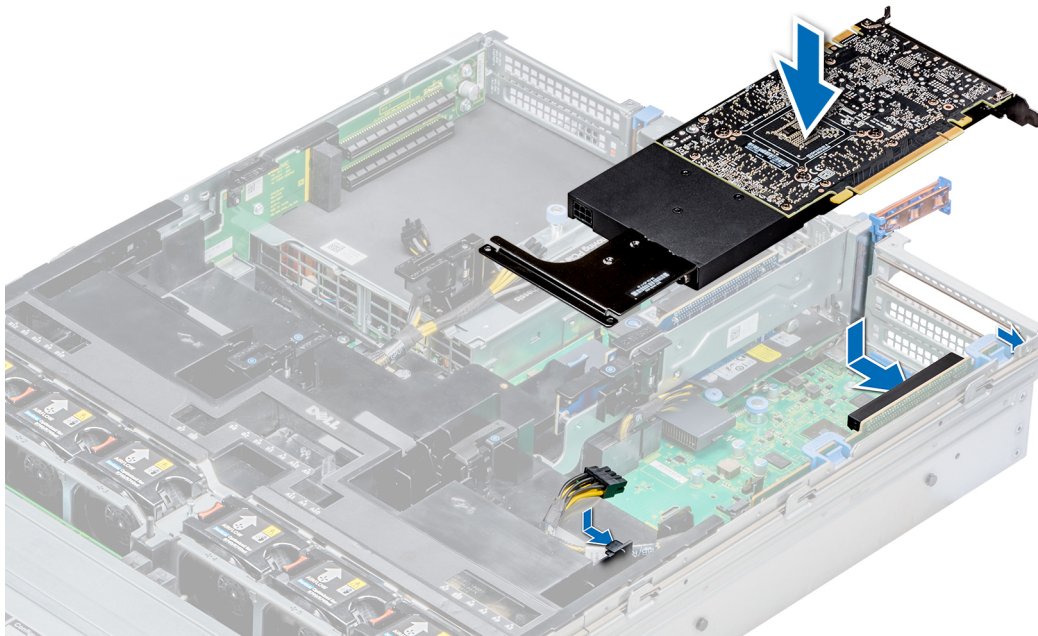

Figure 93. Installing GPU 1

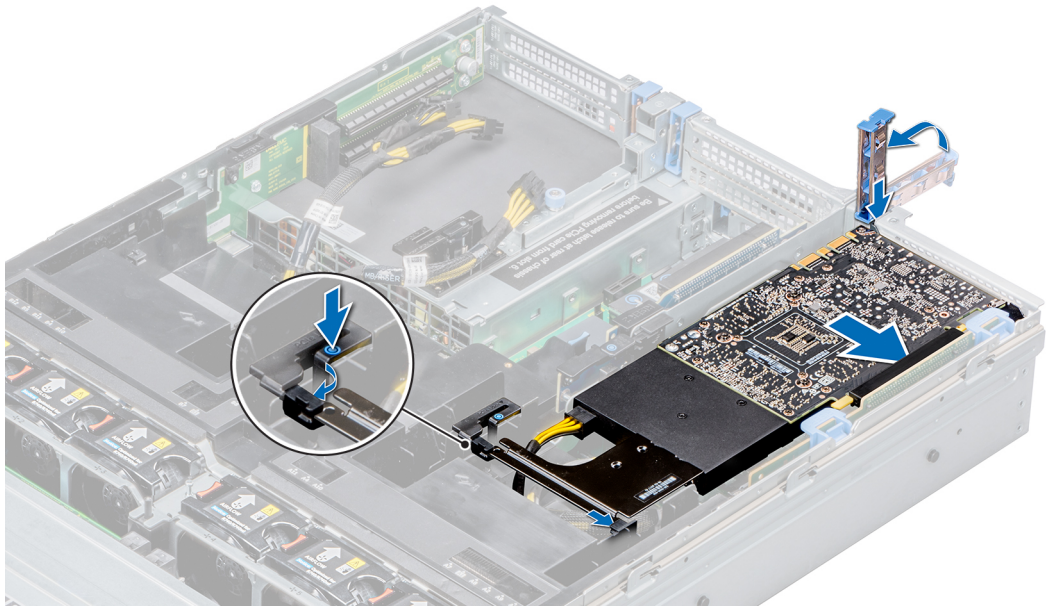

Figure 94. Securing GPU 1

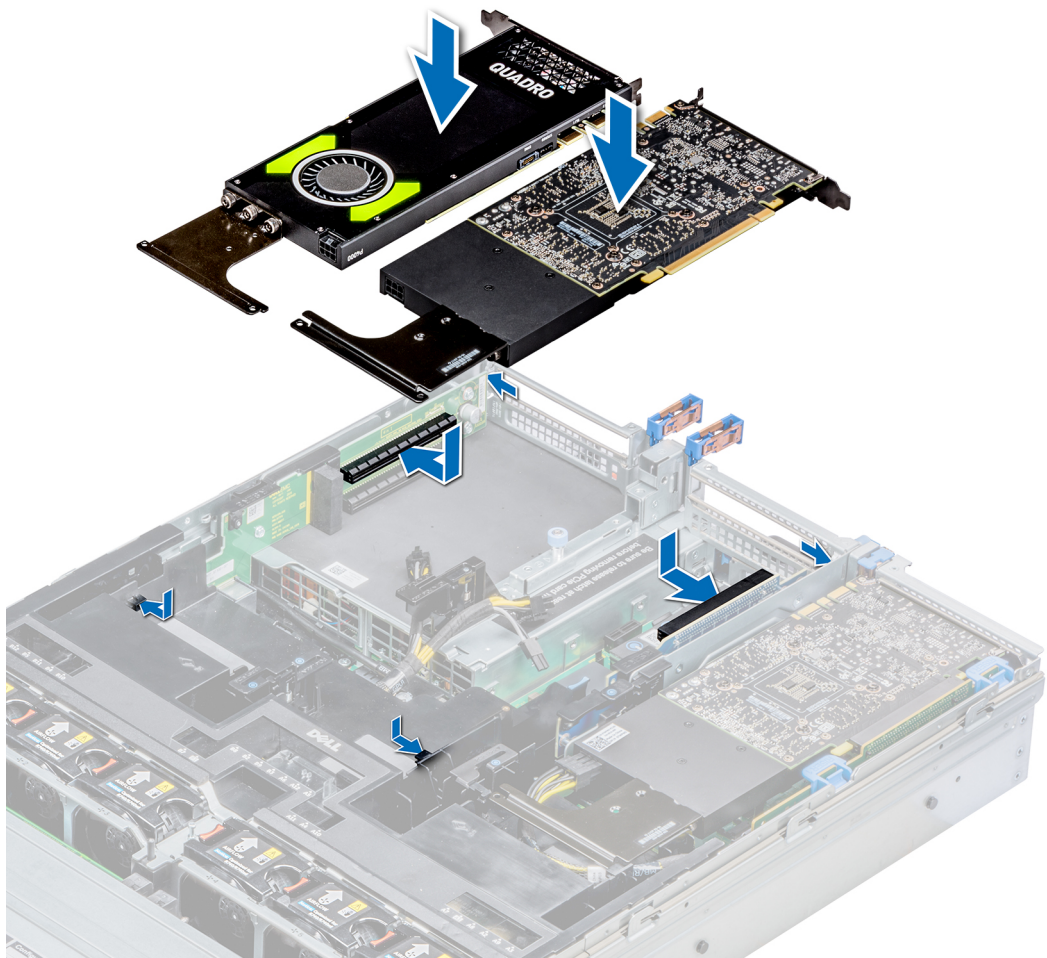

Figure 95. Installing GPU 2 and 3

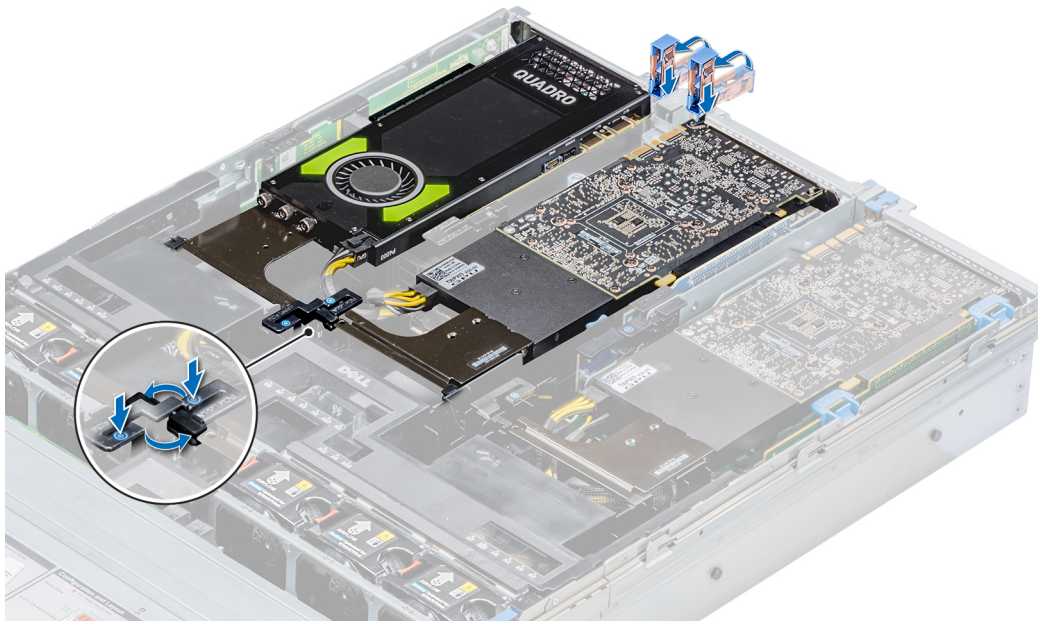

Figure 96. Securing GPU 2 and 3

Next steps

- 1 Install the top cover of the GPU air shroud.
If available, remove the plastic cover fixed on the memory socket numbers marked on the air shroud.

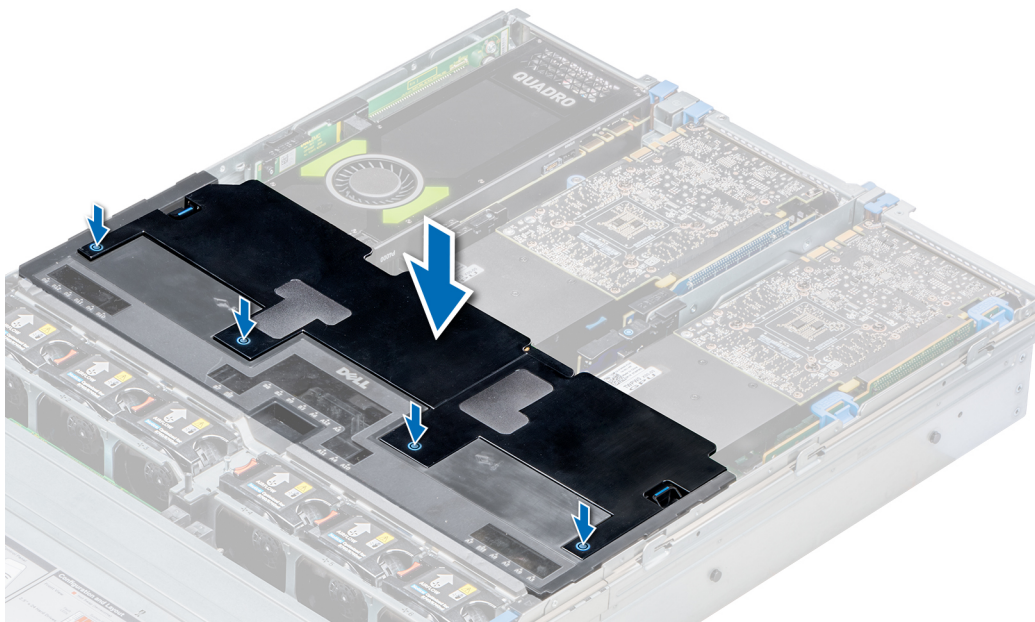

Figure 97. Installing the top cover of GPU air shroud

- 2 To install mylar foam on the system cover:
 - a Place the system cover with the Service Information Label (SIL) side facing up.

- b For easier handling, peel off a small section of the adhesive cover and align the mylar foam with the system cover.
- c Remove rest of the adhesive cover and install mylar foam on the system cover.
- d Press along the length of the mylar foam to ensure that it is firmly affixed to the system cover.



Figure 98. Installing mylar foam on the system cover

- 3 Follow the procedure listed in [After working inside your system](#).

M.2 SSD module

Removing the M.2 SSD module

Prerequisites

- 1 Follow the safety guidelines listed in [Safety instructions](#).
- 2 Follow the procedure listed in [Before working inside your system](#).
- 3 [Remove the air shroud](#).
- 4 Remove the BOSS card.

NOTE: Removing the BOSS card is similar to the procedure for removing an expansion card riser.

Steps

- 1 Loosen the screws and lift the retention straps that secure the M.2 SSD module on the BOSS card.
- 2 Pull the M.2 SSD module away from the BOSS card.

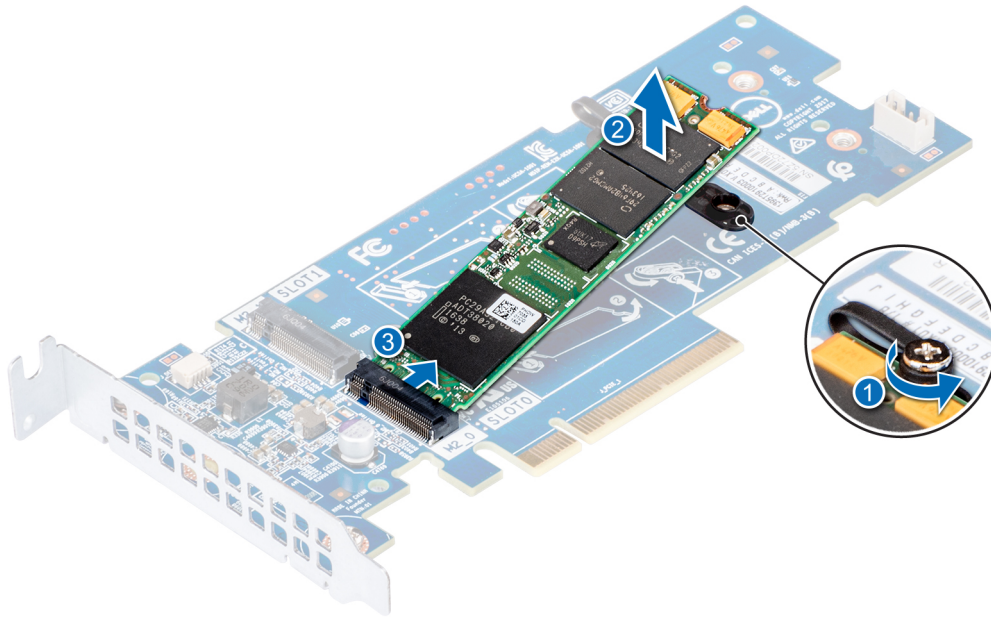

Figure 99. Removing the M.2 SSD module

Next step

Install the M.2 SSD module.

Installing the M.2 SSD module

Prerequisite

- 1 Follow the safety guidelines listed in [Safety instructions](#).

Steps

- 1 Align the M.2 SSD module connectors with the connectors on the BOSS card.
- 2 Push the M.2 SSD module until the module is seated firmly on the BOSS card.
- 3 Secure the M.2 SSD module on the BOSS card with the retention straps and screws.

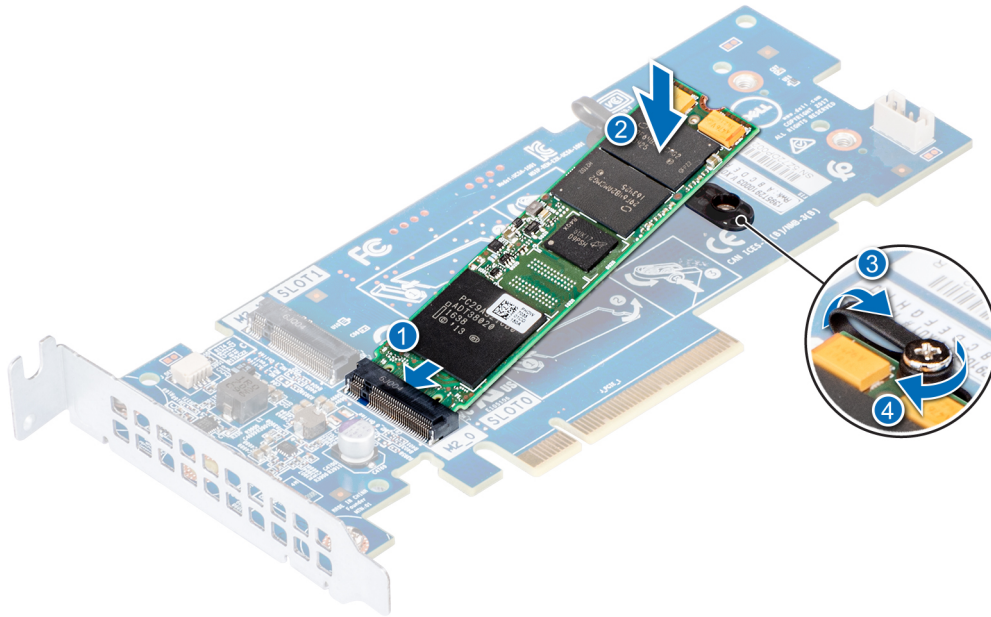

Figure 100. Installing the M.2 SSD module

Next steps

- 1 Install the BOSS card.

NOTE: Installing the BOSS card is similar to installing the expansion card riser.

- 2 Install the air shroud .
- 3 Follow the procedure listed in [After working inside your system](#).

Optional IDSDM or vFlash module

Removing the MicroSD card

Prerequisites

- 1 Follow the safety guidelines listed in [Safety instructions](#).
- 2 Follow the procedure listed in [Before working inside your system](#).

Steps

- 1 Locate the MicroSD card slot on the vFlash/IDSDM module, and press the card to partially release it from the slot. To locate IDSDM/vFlash module, see the [System board jumpers and connectors](#) section.
- 2 Hold the MicroSD card and remove it from the slot.

NOTE: Temporarily label each MicroSD card with its corresponding slot number after removal.

Next step

[Install the MicroSD card](#).

Installing the MicroSD card

Prerequisites

Follow the safety guidelines listed in [Safety instructions](#).

NOTE: To use an MicroSD card with your system, ensure that the Internal SD Card Port is enabled in System Setup.

NOTE: If reinstalling, ensure that you install the MicroSD cards into the same slots based on the labels you had marked on the cards during removal.

Steps

- 1 Locate the MicroSD card connector on the IDSDM/vFlash module. Orient the MicroSD card appropriately and insert the contact-pin end of the card into the slot.

To locate IDSDM/vFlash, see the [System board jumpers and connectors](#) section.

NOTE: The slot is keyed to ensure correct insertion of the card.

- 2 Press the card into the card slot to lock it into place.

Next step

Follow the procedure listed in [After working inside your system](#).

Removing the optional IDSDM or vFlash card

Prerequisites

- 1 Follow the safety guidelines listed in [Safety instructions](#).
- 2 Follow the procedure listed in [Before working inside your system](#).
- 3 If applicable, remove the full-height PCIe cards.
- 4 If you are replacing the IDSDM/vFlash card, remove the MicroSD cards.

NOTE: Temporarily label each MicroSD card with its corresponding slot number after removal.

Steps

- 1 Locate the IDSDM/vFlash connector on the system board.
To locate IDSDM/vFlash connector, see the [System board jumpers and connectors](#) section.
- 2 Holding the pull tab, lift the IDSDM/vFlash card out of the system.

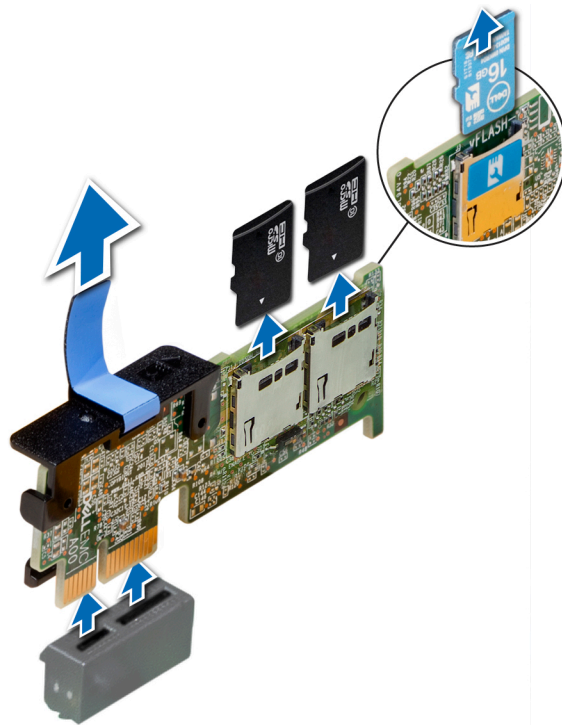

Figure 101. Removing the optional IDSDM/vFlash card

NOTE: There are two dip switches on the IDSDM/vFlash card for write-protection.

Next step

Install the optional IDSDM/vFlash card.

Installing optional IDSDM or vFlash card

Prerequisite

Follow the safety guidelines listed in [Safety instructions](#).

Steps

- 1 Locate the IDSDM/vFlash connector on the system board.
To locate IDSDM/vFlash connector, see the [System board jumpers and connectors](#) section.
- 2 Align the IDSDM/vFlash card with the connector on the system board.
- 3 Push the IDSDM/vFlash card until it is firmly seated on the system board.

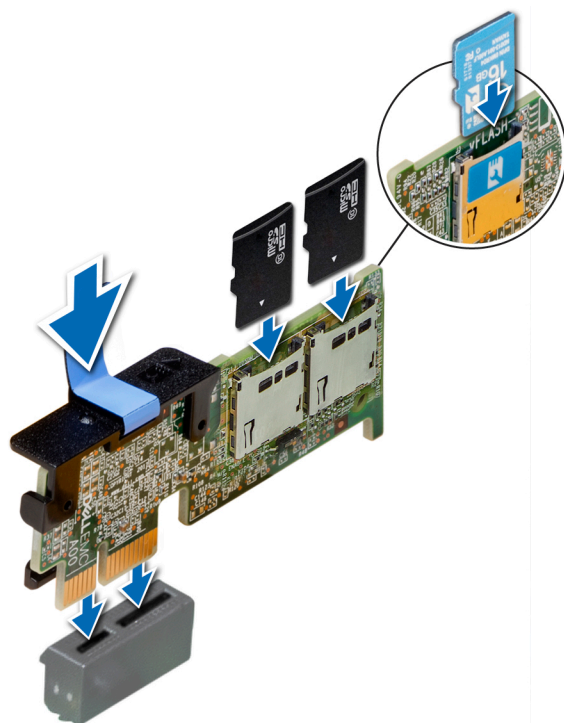

Figure 102. Installing optional IDSDM/vFlash card

Next steps

- 1 Install the MicroSD cards.
NOTE: Reinstall the MicroSD cards into the same slots based on the labels you had marked on the cards during removal.
- 2 If applicable, install the full height PCIe card.
- 3 Follow the procedure listed in [After working inside your system](#).

Network daughter card

Removing the network daughter card

Prerequisites

- 1 Follow the safety guidelines listed in [Safety instructions](#).
- 2 Follow the procedure listed in [Before working inside your system](#).
- 3 If applicable, [remove the expansion card riser 2](#).

Steps

- 1 Using a Phillips #2 screwdriver, loosen the captive screws that secure the network daughter card (NDC) to the system board.
- 2 Hold the NDC by the edges on either side of the touch points, and lift to remove it from the connector on the system board.
- 3 Slide the NDC towards the front of the system until the Ethernet connectors are clear of the slot in the back panel.

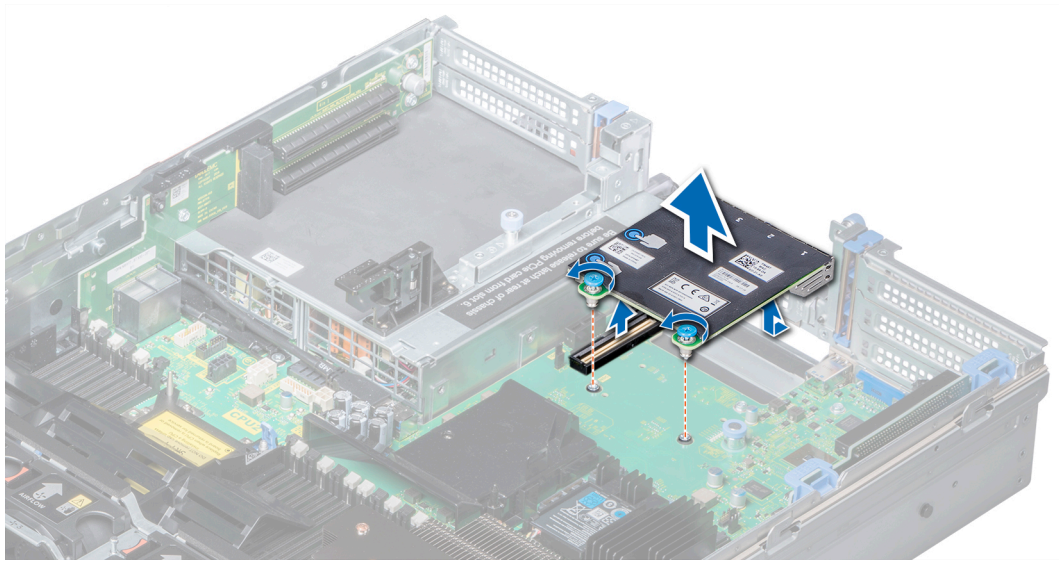

Figure 103. Removing network daughter card

Next step

Install the Network Daughter Card.

Installing the network daughter card

Prerequisite

Follow the safety guidelines listed in [Safety instructions](#).

Steps

- 1 Orient the NDC so that the Ethernet connectors fit through the slot in the chassis.
- 2 Align the captive screws at the back-end of the card with the screw holes on the system board.
- 3 Press the touch points on the card until the card connector is firmly seated on the system board connector.
- 4 Using a Phillips #2 screwdriver, tighten the captive screws to secure the NDC to the system board.

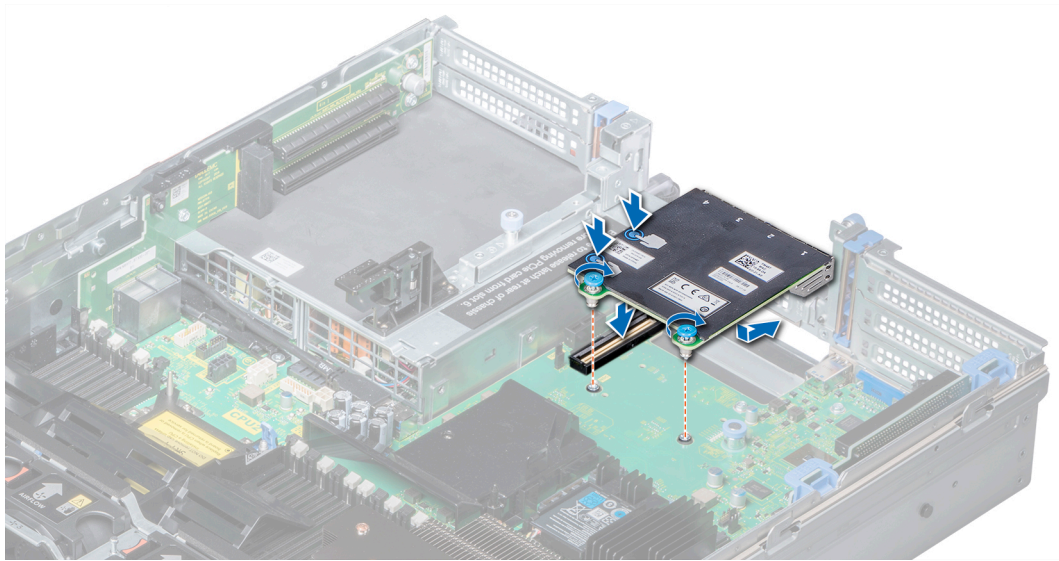

Figure 104. Installing the network daughter card

Next steps

- 1 If applicable, [install the expansion card riser 2](#).
- 2 Follow the procedure listed in [After working inside your system](#).

Integrated storage controller card

Removing integrated storage controller card

Prerequisites

- 1 Follow the safety guidelines listed in [Safety instructions](#).
- 2 Follow the procedure listed in [Before working inside your system](#).
- 3 [Remove the air shroud](#).
- 4 [Remove the expansion card riser 1](#).

Steps

- 1 Using Phillips #2 screwdriver, loosen the screws that secure the integrated storage controller cable to the system board.
- 2 Lift the integrated storage controller cable away from the integrated storage controller.

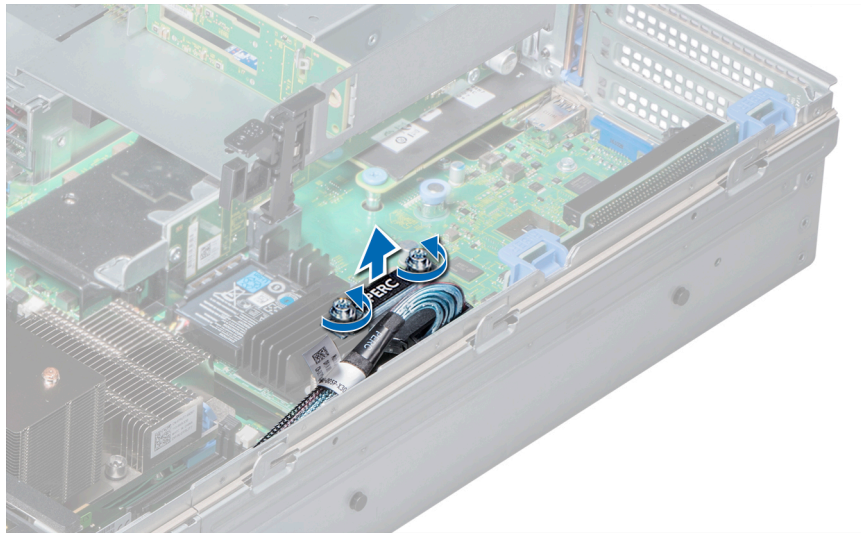

Figure 105. Removing integrated storage controller cable

- 3 Lift one end of the card and angle it to disengage the card from the integrated storage controller card holder on the system board.
- 4 Lift the card out of the system.
- 5 Hold the interposer board by its edges, and pull the board until the connector on the board disengages from the connector on the system board.

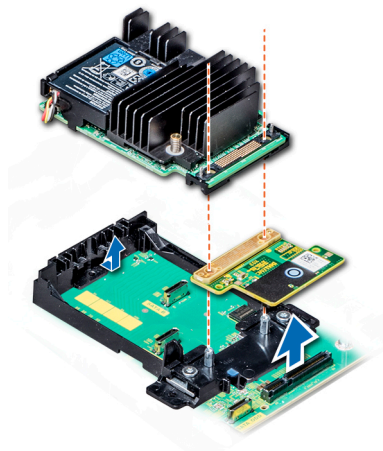

Figure 106. Removing integrated storage controller card

Next step

Install the integrated storage controller card.

Installing integrated storage controller card

Prerequisite

Follow the safety guidelines listed in [Safety instructions](#).

Steps

- 1 Hold the interposer board by its edges, and align the interposer board connector with the connector on the system board.
- 2 Press the touch point on the interposer board until the interposer board connector is firmly seated on the system board connector.
- 3 Angle the card to engage the card with the integrated storage controller card holder on the system board.
- 4 Lower the card into place until the card is fully seated in the integrated storage controller card holder.

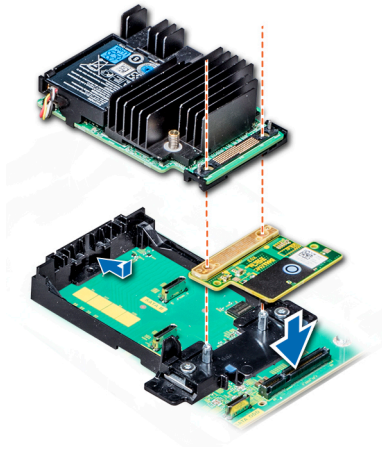

Figure 107. Installing integrated storage controller card

- 5 Align the screws on the integrated storage controller card cable with the screw holes on the system board.
- 6 Using Phillips #2 screwdriver, tighten the screws to secure the integrated storage controller card cable to the system board.

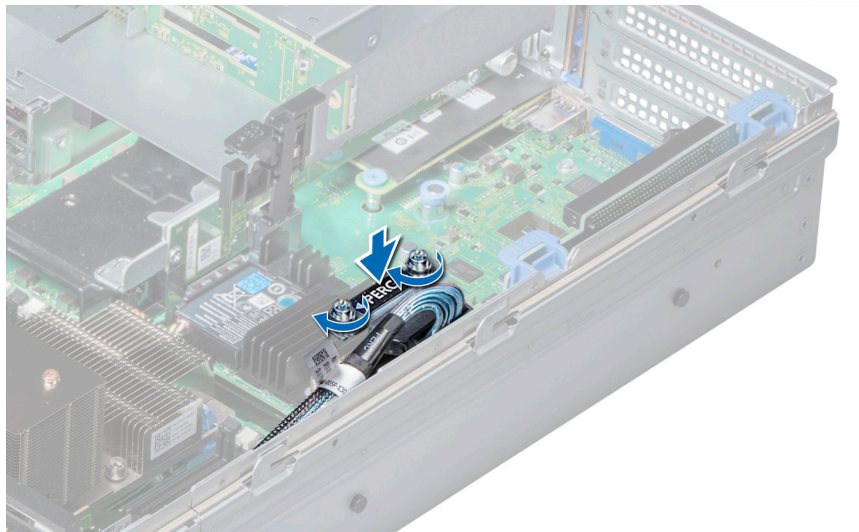

Figure 108. Installing integrated storage controller card cable

Next steps

- 1 [Install the expansion card riser 1.](#)
- 2 [Install the air shroud.](#)
- 3 Follow the procedure listed in [After working inside your system.](#)

Backplane

Backplane details

Depending on your system configuration, the backplanes supported in PowerEdge R740 are listed here:

Table 48. Supported backplane options for PowerEdge R740 systems.

System	Supported backplane options
PowerEdge R740	2.5 inch (x16) SAS/SATA backplane, or 2.5 inch (x8) SAS/SATA backplane, or 3.5 inch (x8) SAS/SATA backplane

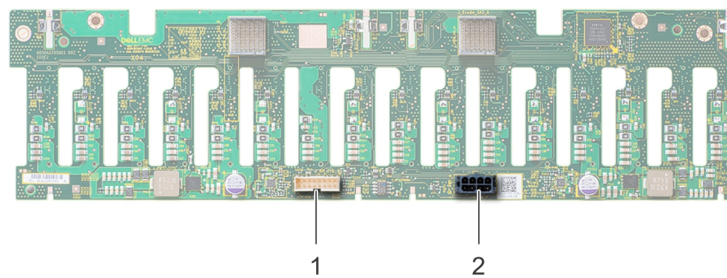

Figure 109. Back view of 16 x 2.5 inch drive backplane

- 1 signal connector (J_BP_SIG)
- 2 power connector (J_BP_PWR)

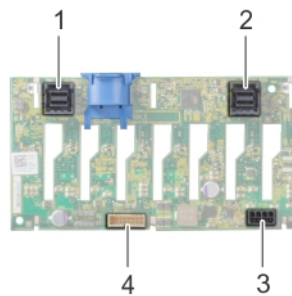

Figure 110. Back view of 8 x 2.5 inch drive backplane

- 1 SAS connector (BP SAS B)
- 2 SAS connector (BP SAS A)
- 3 power connector (J_BP_PWR)
- 4 signal connector (J_BP_SIG)

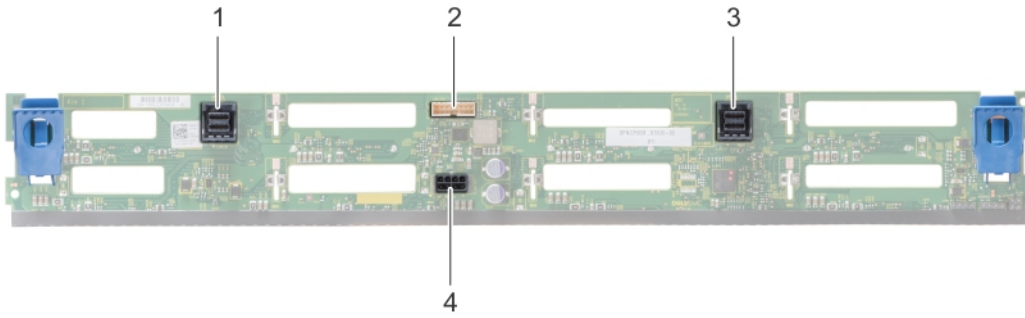

Figure 111. Back view of 8 x 3.5 inch drive backplane

- | | | | |
|---|--------------------------|---|------------------------------|
| 1 | SAS connector (BP SAS B) | 2 | signal connector (J_BP_SIG) |
| 3 | SAS connector (BP SAS A) | 4 | power connector (J_BP_PWR_A) |

Removing the backplane

The procedure to remove the backplane is identical for all backplane configurations.

Prerequisites

⚠ CAUTION: To prevent damage to the drives and backplane, remove the drives from the system before removing the backplane.

⚠ CAUTION: Note the number of each drive and temporarily label them before you remove the drive so that you can replace them in the same locations.

- 1 Follow the safety guidelines listed in [Safety instructions](#).
- 2 Follow the procedure listed in [Before working inside your system](#).
- 3 [Remove the air shroud](#).
- 4 [Remove the cooling fan assembly](#).
- 5 [Remove the backplane cover](#).
- 6 [Remove all drives](#).
- 7 Disconnect all the cables from the backplane.

Step

Press the release tabs and lift the backplane to disengage the backplane from the hooks on the system.

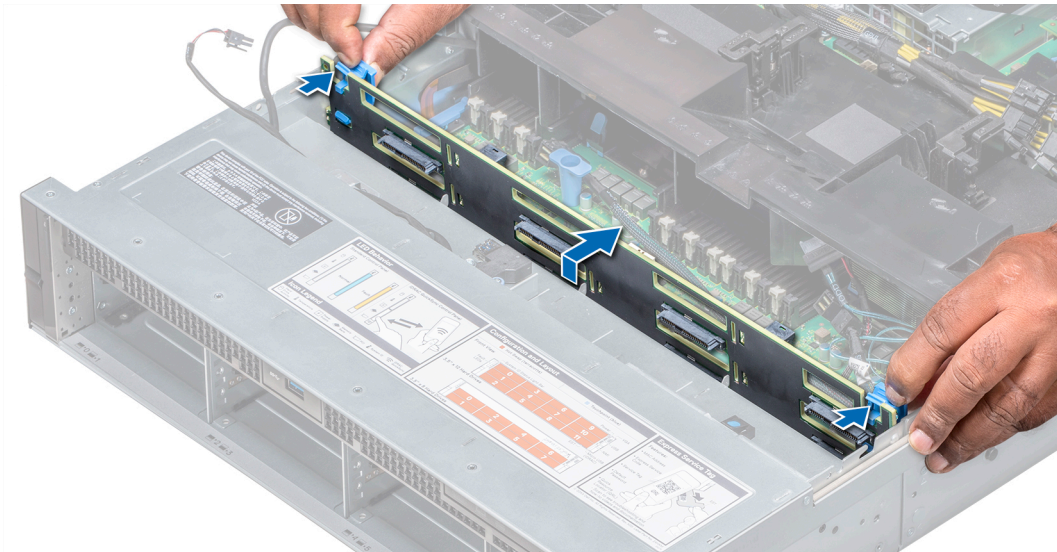

Figure 112. Removing the backplane

Next step

Install the backplane.

Installing the backplane

The procedure to install the backplane is identical for all backplane configurations.

Prerequisite

Follow the safety guidelines listed in [Safety instructions](#).

Steps

- 1 Use the hooks on the system as guides to align the backplane.
- 2 Lower the backplane until the release tabs snap into place.

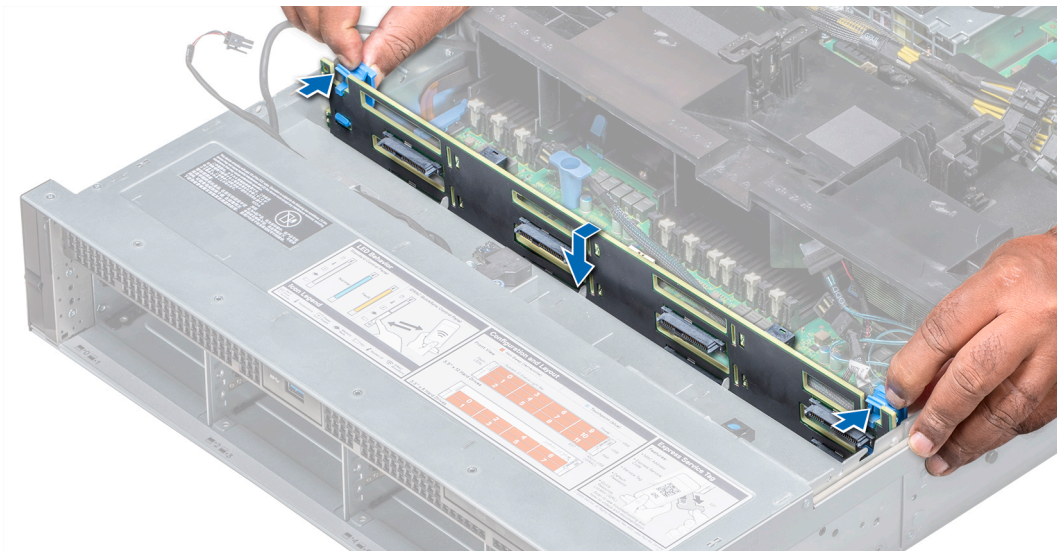

Figure 113. Installing the backplane

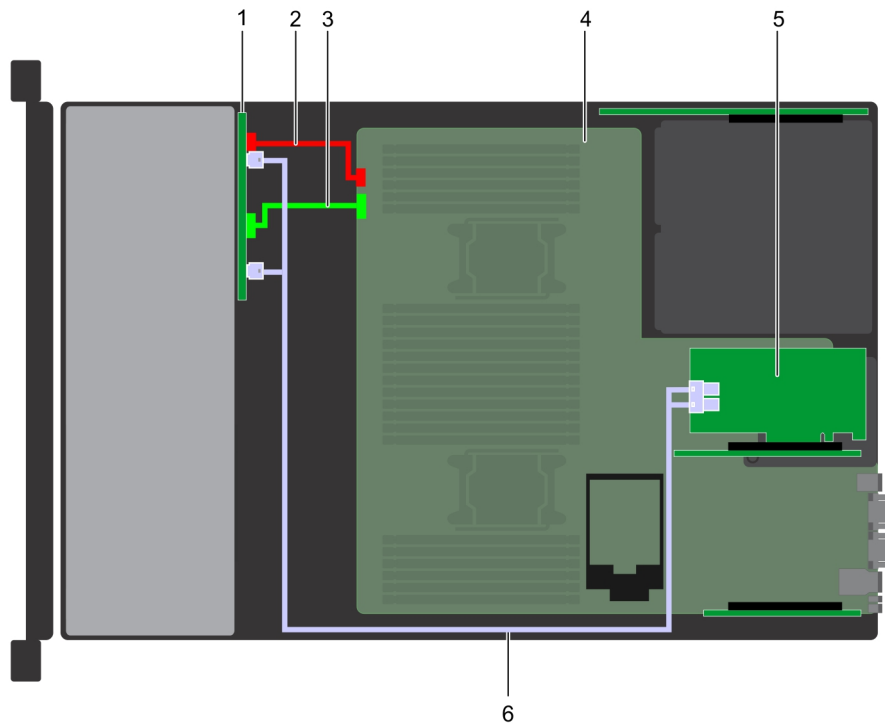

Figure 115. Cable routing – 8 x 2.5 inch drive backplane with adapter PERC

- | | |
|---|--|
| <ul style="list-style-type: none"> 1 backplane 3 backplane power cable (BP: BP1 to MB: BP1) 5 adapter PERC | <ul style="list-style-type: none"> 2 backplane signal cable (BP: BPSIG1 to MB: BPSIG1) 4 system board 6 SAS cable (BP: BP SAS A, BP SAS B to MB: RISER 2) |
|---|--|

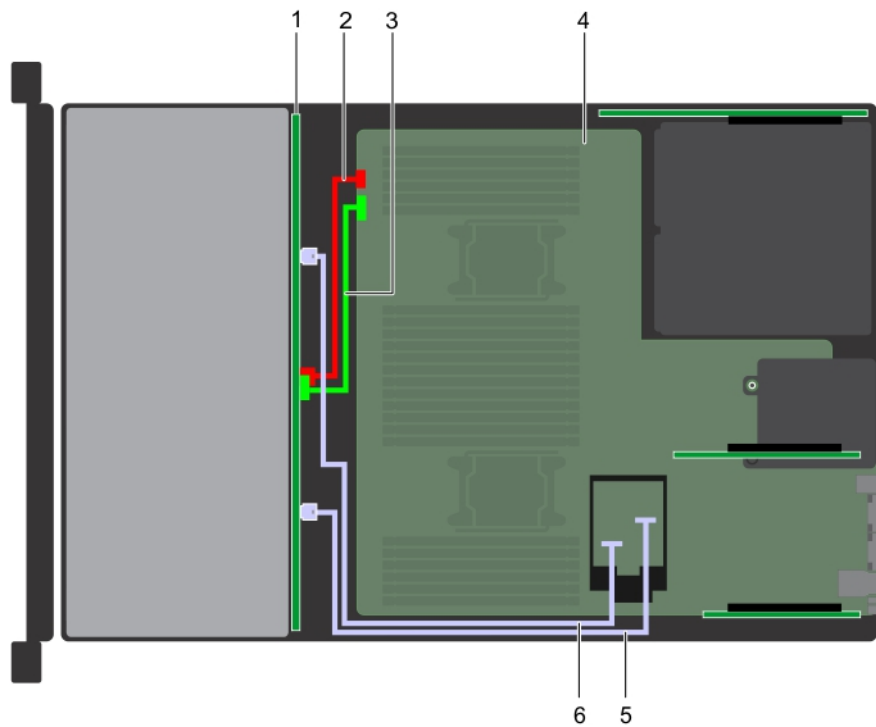

Figure 116. Cable routing – 8 x 3.5 inch drive backplane with on board SATA

- | | | | |
|---|---|---|---|
| 1 | backplane | 2 | backplane power cable (BP: BP1 to MB: BP1) |
| 3 | backplane signal cable (BP: BPSIG1 to MB: BPSIG1) | 4 | system board |
| 5 | SATA B cable (BP: BP SAS B to MB: J_BP_SIG1) | 6 | SATA A cable (BP: BP SAS A to MB: BP 12C RVYPM) |

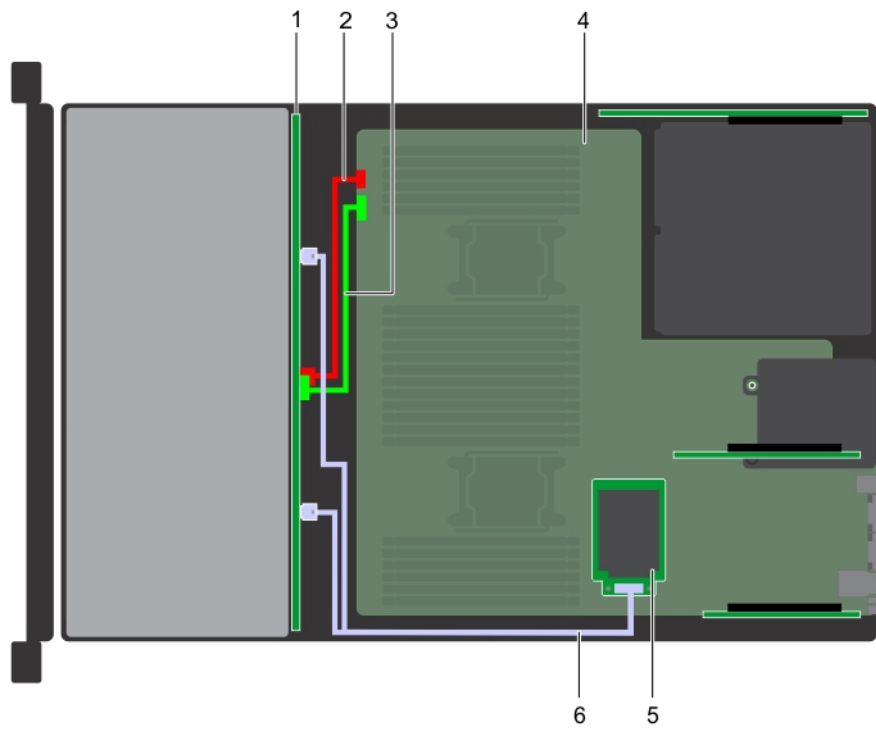

Figure 117. Cable routing – 8 x 3.5 inch drive backplane with mini PERC

- | | | | |
|---|---|---|--|
| 1 | backplane | 2 | backplane power cable (BP: BP to MB: BP1) |
| 3 | backplane signal cable (BP: BPSIG1 to MB: BPSIG1) | 4 | system board |
| 5 | mini PERC | 6 | SAS cable (BP: BP SAS A0, BP SAS B0 to MB: J_STORAGE1) |

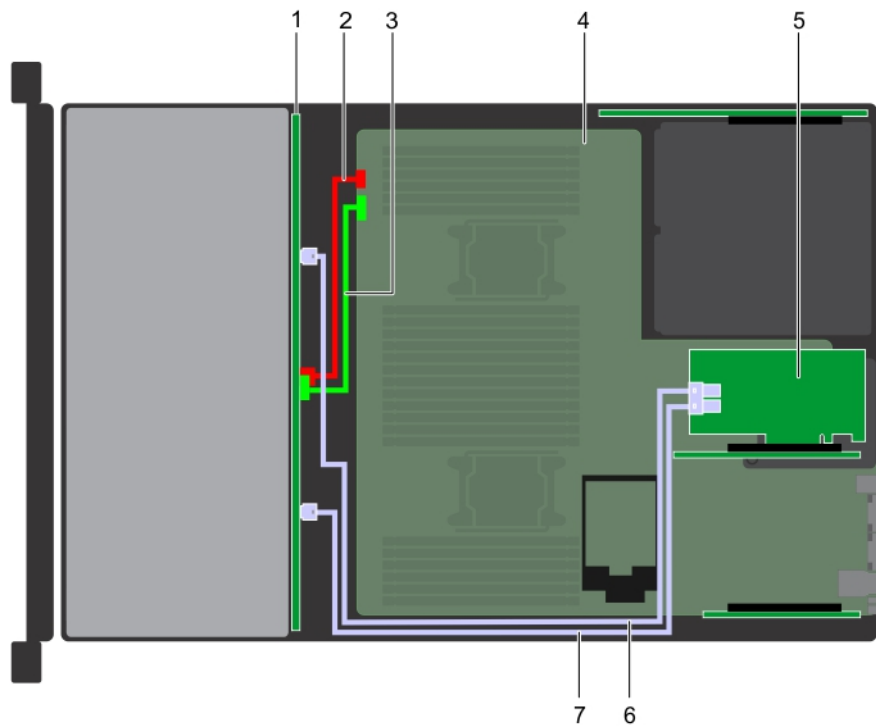

Figure 118. Cable routing – 8 x 3.5 inch drive backplane with adapter PERC

- | | | | |
|---|---|---|--|
| 1 | backplane | 2 | backplane power cable (BP: BP1 to MB: BP1) |
| 3 | backplane signal cable (BP: BPSIG1 to MB: BPSIG1) | 4 | system board |
| 5 | adapter PERC | 6 | SAS A cable (BP: BP SAS A0 to MB: J_BP_PWR_A1) |
| 7 | SAS B cable (BP: BP SAS B0 to MB: J_BP_SIG1) | | |

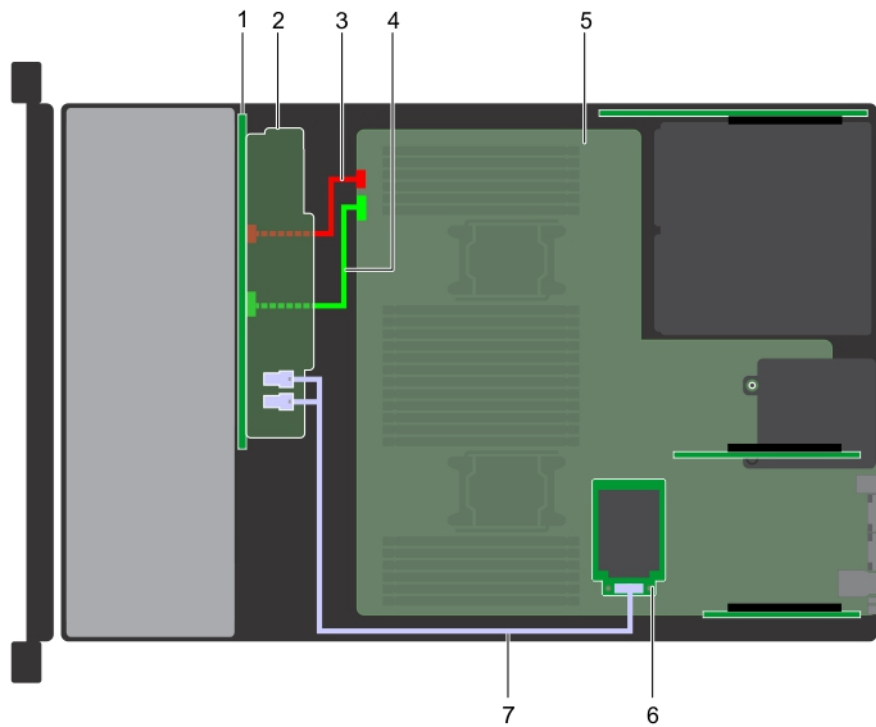

Figure 119. Cable routing – 16 x 2.5 inch drive backplane with mini PERC

- | | | | |
|---|--|---|---|
| 1 | backplane | 2 | backplane expander |
| 3 | backplane power cable (BP: BP1 to MB: BP1) | 4 | backplane signal cable (BP: BPSIG1 to MB: BPSIG1) |
| 5 | system board | 6 | mini PERC |
| 7 | SAS cable (BP: BP SAS A0, BP SAS B0 to MB: J_STORAGE1) | | |

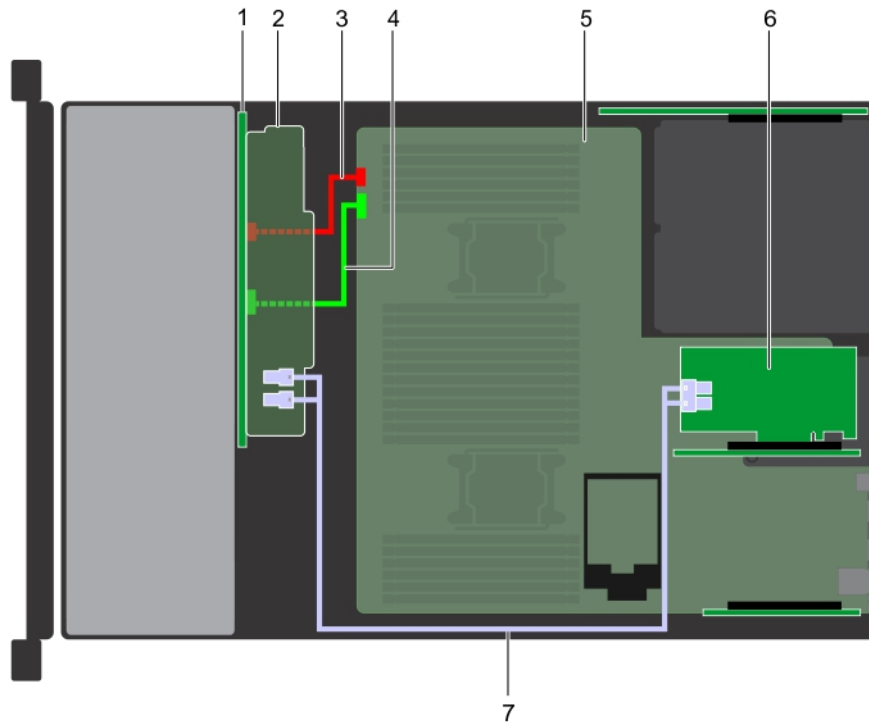

Figure 120. Cable routing – 16 x 2.5 inch drive backplane with adapter PERC

- | | | | |
|---|--|---|---|
| 1 | backplane | 2 | backplane expander |
| 3 | backplane power cable (BP: BP1 to MB: BP1) | 4 | backplane signal cable (BP: BPSIG1 to MB: BPSIG1) |
| 5 | system board | 6 | adapter PERC |
| 7 | SAS cable (BP: J_SAS_BO, J_SAS_A0 to MB: J_STORAGE1) | | |

System battery

Replacing the system battery

Prerequisites

⚠ WARNING: There is a danger of a new battery exploding if it is incorrectly installed. Replace the battery only with the same or equivalent type recommended by the manufacturer. For more information, see the safety information that shipped with your system.

- 1 Follow the safety guidelines listed in [Safety instructions](#).
- 2 Follow the procedure listed in [Before working inside your system](#).
- 3 If applicable, close the PCIe card holder latch on the air shroud to release the full length card.
- 4 If applicable, disconnect the power or data cables from expansion card(s).
- 5 [Remove the expansion card riser 1A](#).

Steps

- 1 Locate the battery socket. For more information, see the [System board jumpers and connectors](#) section.

CAUTION: To avoid damage to the battery connector, you must firmly support the connector while installing or removing a battery.

- 2 Use a plastic scribe to pry out the system battery.



Figure 121. Removing the system battery

- 3 To install a new system battery, hold the battery with the positive side facing up and slide it under the securing tabs.
- 4 Press the battery into the connector until it snaps into place.

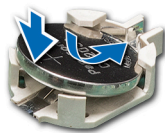

Figure 122. Installing the system battery

Next steps

- 1 [Install the expansion card riser 1A.](#)
- 2 If applicable, connect the cables to the expansion card(s).
- 3 If applicable, open the PCIe card holder latch on the air shroud to secure the full length expansion card.
- 4 Follow the procedure listed in [After working inside your system.](#)
- 5 While booting, press F2 to enter the System Setup and ensure that the battery is operating properly.
- 6 Enter the correct time and date in the System Setup **Time** and **Date** fields.
- 7 Exit the System Setup.

USB 3.0 module

USB 3.0 module details

An additional USB 3.0 port can be added to the front of the system. The USB 3.0 module cable connects to the internal USB port on the system board. In this scenario, the default internal USB port is available under the backplane cover.

NOTE: The position of the USB 3.0 module and default internal USB port may vary depending on the configuration of your system.

Removing USB 3.0 module

Prerequisites

- 1 Follow the safety guidelines listed in [Safety instructions](#).
- 2 Follow the procedure listed in [Before working inside your system](#).
- 3 [Remove the backplane cover](#).
- 4 [Remove the cooling fan assembly](#).
- 5 [Remove the air shroud](#).
- 6 [Remove the internal USB memory key](#).

NOTE: The position of the USB 3.0 module may vary depending on the configuration of your system.

NOTE: Ensure that you note the routing of the cables as you remove them from the system board. Route these cables properly when you replace them to prevent them from being pinched or crimped.

Steps

- 1 Disconnect the cables from the system board.
- 2 Using Phillips #2 screwdriver, loosen the screw on the USB 3.0 module.
- 3 Slide the USB 3.0 module out of the system.

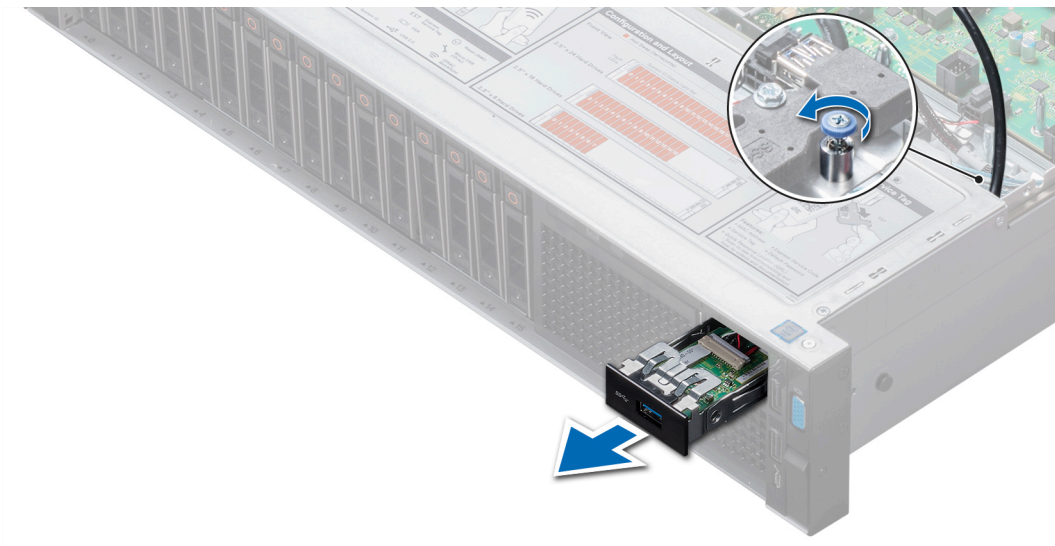

Figure 123. Removing USB 3.0 module

Next step

Install the USB 3.0 module.

Installing USB 3.0 module

Prerequisite

Follow the safety guidelines listed in [Safety instructions](#).

NOTE: The position of the USB 3.0 module may vary depending on the configuration of your system.

Steps

- 1 Route the power and the USB cables on the USB 3.0 module through the USB 3.0 module slot on the front panel.
- 2 Insert the USB 3.0 module into the slot on the front panel.
- 3 Align the screws on the module with the screw holes on the system.
- 4 Using the Phillips #2 screwdriver, tighten the screw to secure the module to the system.
- 5 Route and connect the USB cable to internal USB port and power cable to the backplane 3 power connector on the system board.
To locate the connector, see the [System board jumpers and connectors](#) section.

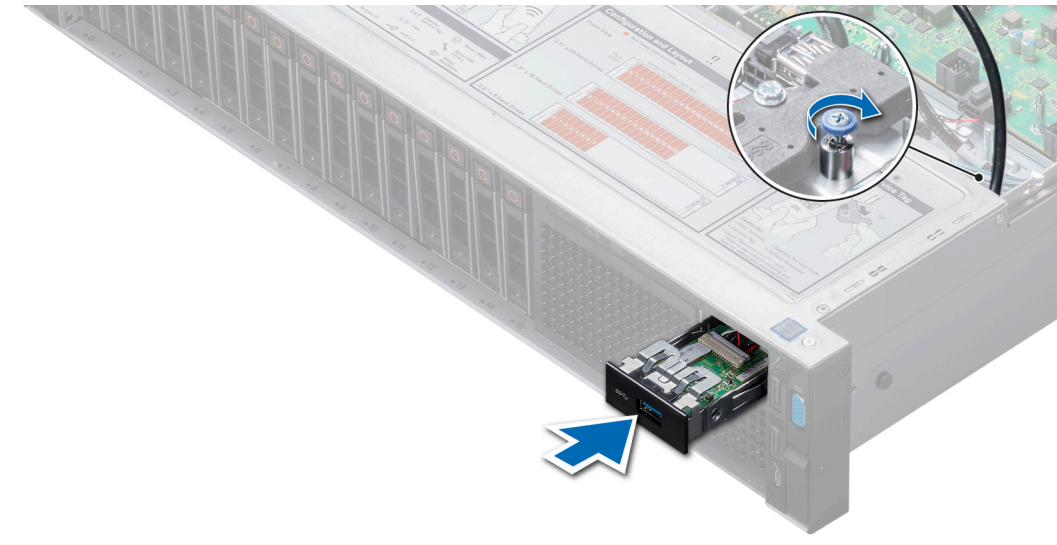

Figure 124. Installing USB 3.0 module

Next steps

- 1 [Install the internal USB memory key.](#)
- 2 [Install the air shroud.](#)
- 3 [Install the cooling fan assembly.](#)
- 4 [Install the backplane cover.](#)
- 5 Follow the procedure listed in [After working inside your system.](#)

Optional internal USB memory key

Optional internal USB memory key details

An optional USB memory key can be installed in the internal USB 3.0 port.

NOTE: To locate the internal USB port on the system board, see the [System board jumpers and connectors](#) section.

For configurations that support USB 3.0 module, the USB 3.0 module cable connects to the internal USB port on the system board. In this scenario, the default internal USB port is available under the backplane cover. The position of the default internal USB port may vary depending on the configuration of your system.

Replacing the optional internal USB memory key

Prerequisites

⚠ CAUTION: To avoid interference with other components in the server, the maximum permissible dimensions of the USB memory key are 15.9 mm wide x 57.15 mm long x 7.9 mm high.

- 1 Follow the safety guidelines listed in [Safety instructions](#).
- 2 Follow the procedure listed in [Before working inside your system](#).

Steps

- 1 Locate the USB port or USB memory key on the system board.
To locate the USB port, see the [internal USB memory key details](#) section.
- 2 If installed, remove the USB memory key from the USB port.
- 3 Insert the replacement USB memory key into the USB port.

Next steps

- 1 Follow the procedure listed in [After working inside your system](#).
- 2 While booting, press F2 to enter **System Setup** and verify that the system detects the USB memory key.

Optional optical drive

Removing the optional optical drive

Prerequisites

- 1 Follow the safety guidelines listed in [Safety instructions](#).
- 2 Follow the procedure listed in [Before working inside your system](#).
- 3 [Remove the backplane cover](#).
- 4 [Remove the air shroud](#).
- 5 Disconnect the power and data cables from the back of the drive.

ⓘ NOTE: Ensure that you note the routing of the power and data cable on the side of the system as you remove them from the system board and drive. Route these cables properly when you replace them to prevent them from being pinched or crimped.

Steps

- 1 Press the release tab to release the optical drive.
- 2 Slide the optical drive out of the system.

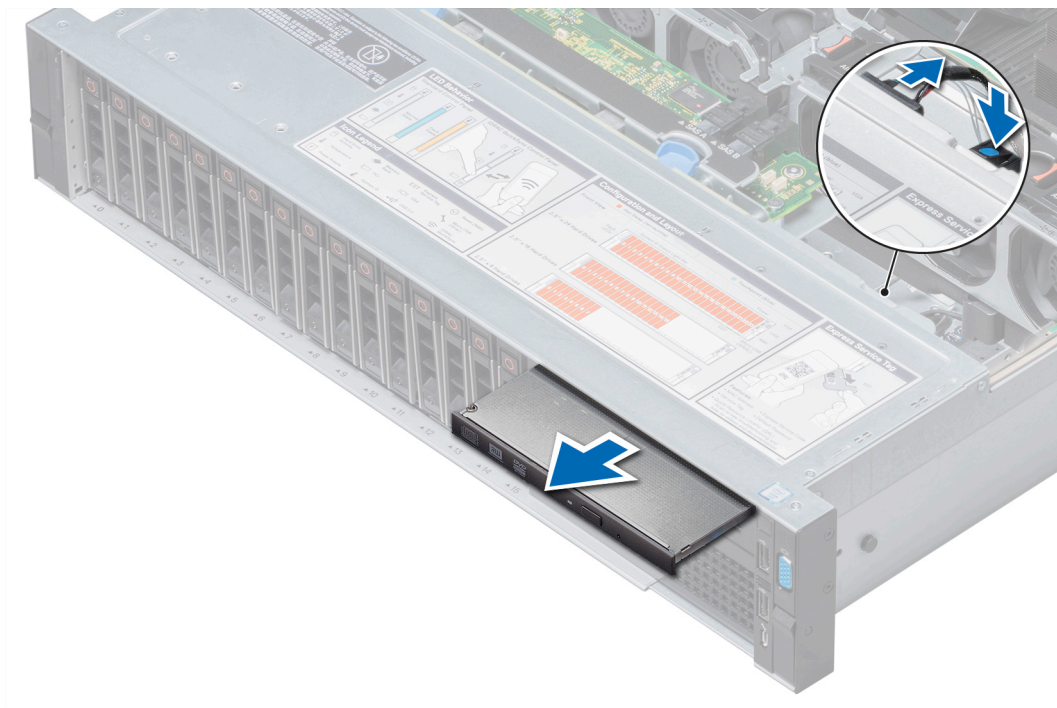

Figure 125. Removing the optional optical drive

Next steps

- 1 If you are not adding a new optical drive, install the optical drive blank.
The procedure to install the optical drive blank is the same as the optical drive.
- 2 [Install the optional optical drive.](#)

Installing the optional optical drive

Prerequisite

Follow the safety guidelines listed in [Safety instructions](#).

Steps

- 1 Align the optical drive with the optical drive slot on the front of the system.
- 2 Slide in the optical drive until the release tab snaps into place.

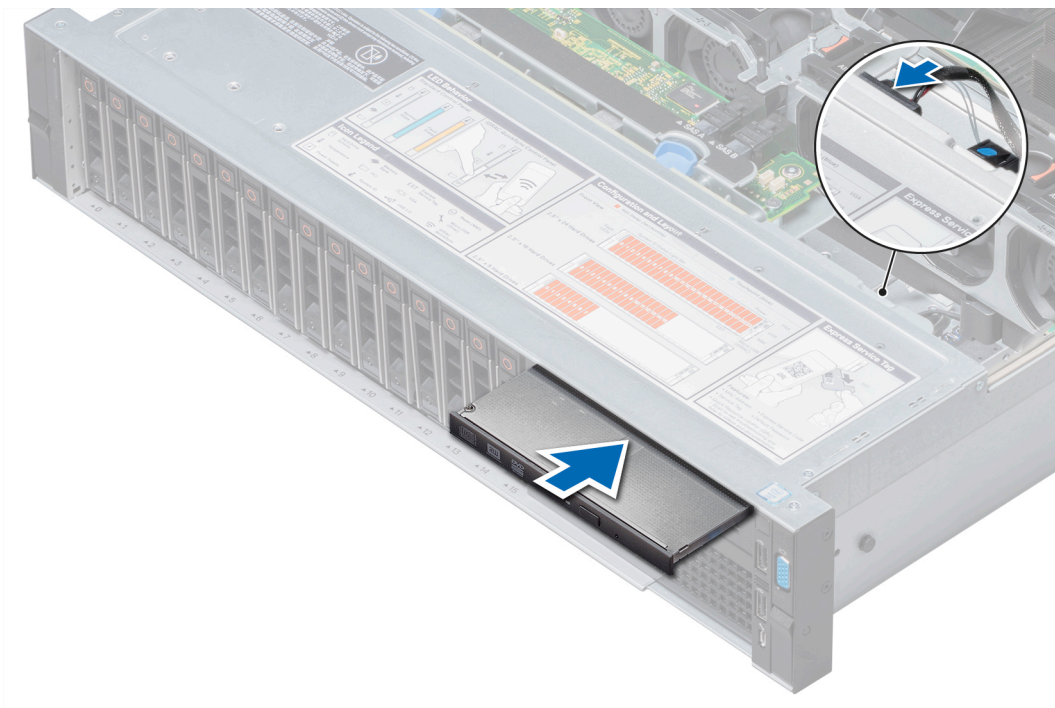

Figure 126. Installing the optional optical drive

Next steps

- 1 Connect the power and data cables to the optical drive and system board.

① **NOTE:** Route the cable properly on the side of the system to prevent it from being pinched or crimped.

- 2 Install the air shroud.
- 3 Install the backplane cover.
- 4 Follow the procedure listed in [After working inside your system](#).

Power supply units

Power supply unit details

Your system supports one of the following:

- Two 2400 W, 2000 W, 1600 W, 1100 W, 750 W, or 495 W AC PSUs
- Two 1100 W DC PSUs
- Two 1100 W or 750 W Mixed Mode HVDC PSUs

① **NOTE:** For more information, see the [Technical specifications](#) section.

⚠ **CAUTION:** If two PSUs are installed, both the PSUs must have the same type of label. For example, Extended Power Performance (EPP) label. Mixing PSUs from previous generations of PowerEdge servers is not supported, even if the PSUs have the same power rating. Mixing PSUs will result in mismatch condition or failure to turn the system on.

① **NOTE:** Titanium PSU is nominally rated for 200 V AC to 240 V AC input only.

NOTE: When two identical PSUs are installed, power supply redundancy (1+1 – with redundancy or 2+0 – without redundancy) is configured in system BIOS. In redundant mode, power is supplied to the system equally from both PSUs when Hot Spare is disabled. When Hot Spare is enabled, one of the PSUs is put into the sleep mode when system utilization is low in order to maximize efficiency.

NOTE: If two PSUs are used, they must be of the same maximum output power.

Hot spare feature

Your system supports the hot spare feature that significantly reduces the power overhead associated with power supply unit (PSU) redundancy.

When the hot spare feature is enabled, one of the redundant PSUs is switched to the sleep state. The active PSU supports 100 percent of the system load, thus operating at higher efficiency. The PSU in the sleep state monitors output voltage of the active PSU. If the output voltage of the active PSU drops, the PSU in the sleep state returns to an active output state.

If having both PSUs active is more efficient than having one PSU in the sleep state, the active PSU can also activate the sleeping PSU.

The default PSU settings are as follows:

- If the load on the active PSU is more than 50 percent of PSU rated power wattage, then the redundant PSU is switched to the active state.
- If the load on the active PSU falls below 20 percent of PSU rated power wattage, then the redundant PSU is switched to the sleep state.

You can configure the hot spare feature by using the iDRAC settings. For more information, see the iDRAC User's Guide available at Dell.com/poweredgemanuals.

Removing a power supply unit blank

Prerequisite

Follow the safety guidelines listed in [Safety instructions](#).

Step

If you are installing a second power supply unit (PSU), remove the PSU blank in the bay by pulling the blank outward.

CAUTION: To ensure proper system cooling, the PSU blank must be installed in the second PSU bay in a non-redundant configuration. Remove the PSU blank only if you are installing a second PSU.

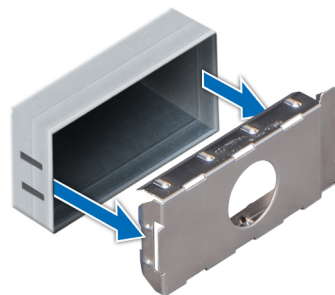

Figure 127. Removing a power supply unit blank

Next step

[Install the PSU blank.](#)

Installing a power supply unit blank

Prerequisite

- 1 Follow the safety guidelines listed in [Safety instructions](#).

NOTE: Install the power supply unit (PSU) blank only in the second PSU bay.

Step

Align the PSU blank with the PSU slot and push it into the PSU slot until it clicks into place.

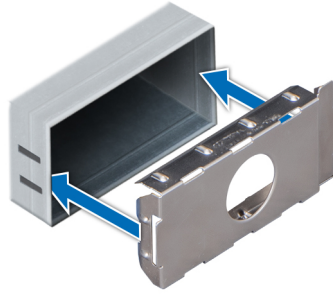

Figure 128. Installing a power supply unit blank

Removing a power supply unit

The procedure for removing AC and DC PSUs is identical.

Prerequisites

CAUTION: The system needs one power supply unit (PSU) for normal operation. On power-redundant systems, remove and replace only one PSU at a time in a system that is powered on.

- 1 Follow the safety guidelines listed in [Safety instructions](#).
- 2 Disconnect the power cable from the power source and from the PSU you intend to remove, and then remove the cable from the strap on the PSU handle.
- 3 Unlatch and lift the optional cable management arm if it interferes with the PSU removal.
For information about the cable management arm, see the system's rack documentation at Dell.com/poweredgemanuals.

Step

Press the orange release latch and slide the PSU out of the system by using the PSU handle.

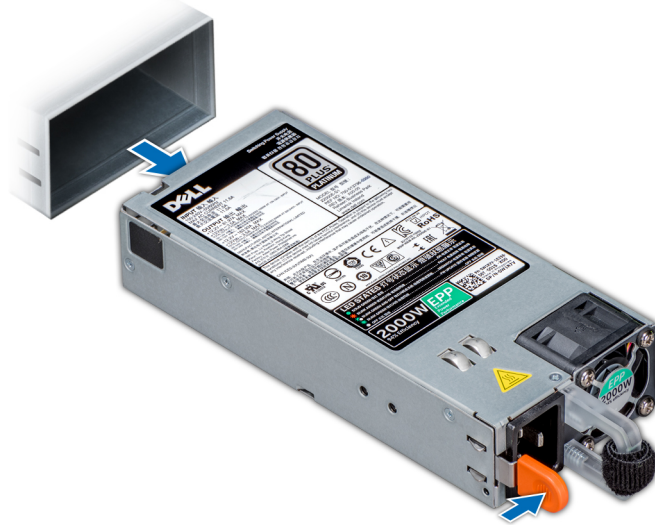

Figure 129. Removing a power supply unit

Next step

Install the PSU or PSU blank.

Installing a power supply unit

The procedure for installing AC and DC PSUs is identical.

Prerequisites

- 1 Follow the safety guidelines listed in [Safety instructions](#).
- 2 For systems that support redundant PSU, ensure that both the PSUs are of the same type and have the same maximum output power.

NOTE: The maximum output power (shown in watts) is listed on the PSU label.

Step

Slide the PSU into the system until the PSU is fully seated and the release latch snaps into place.

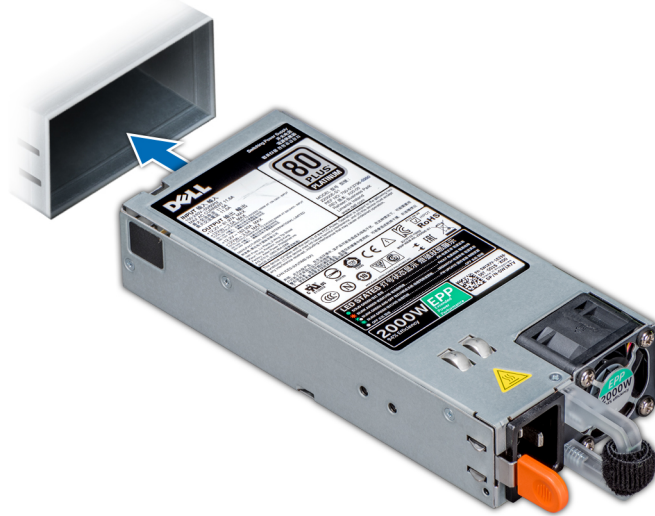

Figure 130. Installing a power supply unit

Next steps

- 1 If you have unlatched the cable management arm, relatch it. For information about the cable management arm, see the system's rack documentation at Dell.com/poweredgemanuals.
- 2 Connect the power cable to the PSU, and plug the cable into a power outlet.

⚠ **CAUTION:** When connecting the power cable to the PSU, secure the cable to the PSU with the strap.

ℹ **NOTE:** When installing, hot swapping, or hot adding a new PSU, wait for 15 seconds for the system to recognize the PSU and determine its status. The PSU redundancy may not occur until discovery is complete. Wait until the new PSU is discovered and enabled before you remove the other PSU. The PSU status indicator turns green to signify that the PSU is functioning properly.

Wiring instructions for a DC power supply unit

Your system supports up to two $-(48-60)$ V DC power supply units (PSUs).

⚠ **WARNING:** For equipment using $-(48-60)$ V DC power supply units (PSUs), a qualified electrician must perform all connections to DC power and to safety grounds. Do not attempt connecting to DC power or installing grounds yourself. All electrical wiring must comply with applicable local or national codes and practices. Damage due to servicing that is not authorized by Dell is not covered by your warranty. Read and follow all safety instructions that came with the product.

⚠ **CAUTION:** Wire the unit with copper only, unless otherwise specified, use only 10 American Wire Gauge (AWG) wire rated minimum 90°C for source and return. Protect the $-(48-60)$ V DC (1 wire) with a branch circuit over-current protection rated 50 A for DC with a high interrupt current rating.

⚠ **CAUTION:** Connect the equipment to a $-(48-60)$ V DC supply source that is electrically isolated from the AC source (reliably grounded $-(48-60)$ V DC SELV source). Ensure that the $-(48-60)$ V DC source is efficiently secured to earth (ground).

ℹ **NOTE:** A readily accessible disconnect device that is suitably approved and rated shall be incorporated in the field wiring.

Input requirements

- Supply voltage: $-(48-60)$ V DC

- Current consumption: 32 A (maximum)

Kit contents

- Dell part number 6RYJ9 terminal block or equivalent (1)
- #6-32 nut equipped with lock washer (1)

Required tools

Wire-stripper pliers capable of removing insulation from size 10 AWG solid or stranded, insulated copper wire.

 **NOTE:** Use alpha wire part number 3080 or equivalent (65/30 stranding).

Required wires

- One UL 10 AWG, 2 m maximum (stranded) black wire [–(48–60) V DC].
- One UL 10 AWG, 2 m maximum (stranded) red wire (V DC return).
- One UL 10 AWG, 2 m maximum, green with a yellow stripe, stranded wire (safety ground).

Assembling and connecting safety ground wire

Prerequisite

 **WARNING:** For equipment using –(48–60) V DC power supply units (PSUs), a qualified electrician must perform all connections to DC power and to safety grounds. Do not attempt connecting to DC power or installing grounds yourself. All electrical wiring must comply with applicable local or national codes and practices. Damage due to servicing that is not authorized by Dell is not covered by your warranty. Read and follow all safety instructions that came with the product.

Steps



- 1 Strip the insulation from the end of the green or yellow wire, exposing approximately 4.5 mm (0.175 inch) of copper wire.
- 2 Using a hand-crimping tool (Tyco Electronics, 58433-3 or equivalent), crimp the ring-tongue terminal (Jeeson Terminals Inc., R5-4SA or equivalent) to the green and yellow wire (safety ground wire).
- 3 Connect the safety ground wire to the grounding post on the back of the system by using a #6-32 nut equipped with a locking washer.

Assembling DC input power wires

Prerequisite

 **WARNING:** For equipment using –(48–60) V DC power supply units (PSUs), a qualified electrician must perform all connections to DC power and to safety grounds. Do not attempt connecting to DC power or installing grounds yourself. All electrical wiring must comply with applicable local or national codes and practices. Damage due to servicing that is not authorized by Dell is not covered by your warranty. Read and follow all safety instructions that came with the product.

Steps

- 1 Strip the insulation from the ends of the DC power wires, exposing approximately 13 mm (0.5 inch) of copper wire.
 **WARNING:** Reversing polarity when connecting DC power wires can permanently damage the power supply or the system.
- 2 Insert the copper ends into the mating connectors and tighten the captive screws at the top of the mating connector using a Phillips #2 screwdriver.
 **WARNING:** To protect the power supply from electrostatic discharge, the captive screws must be covered with the rubber cap before inserting the mating connector into the power supply.

- 3 Rotate the rubber cap clockwise to fix it over the captive screws.
- 4 Insert the mating connector into the power supply.

System board

Removing system board

Prerequisites

- △ **CAUTION:** If you are using the Trusted Platform Module (TPM) with an encryption key, you may be prompted to create a recovery key during program or System Setup. Be sure to create and safely store this recovery key. If you replace this system board, you must supply the recovery key when you restart your system or program before you can access the encrypted data on your drives.
- △ **CAUTION:** Do not attempt to remove the TPM plug-in module from the system board. Once the TPM plug-in module is installed, it is cryptographically bound to that specific system board. Any attempt to remove an installed TPM plug-in module breaks the cryptographic binding, and it cannot be re-installed or installed on another system board.

- 1 Follow the safety guidelines listed in [Safety instructions](#).
- 2 Follow the procedure listed in [Before working inside your system](#).
- 3 Remove the following:
 - a [Air shroud](#)
 - b [Cooling fan assembly](#)
 - c [Power supply units](#)
 - d [Expansion cards and expansion card risers](#)
 - e [Integrated storage controller card](#)
 - f [Optional IDSDM or vFlash card](#)
 - g [Optional internal USB memory key](#) (if installed)
 - h [USB 3.0 module](#) (if installed)
 - i [Processor and heat sink module](#)
 - j [Processor blank](#) (if installed)

△ **CAUTION:** To prevent damage to the processor socket when replacing a faulty system board, ensure that you cover the processor socket with the processor dust cover.

- k [Memory modules](#) and memory module blanks
- l [Network daughter card](#)

Steps

- 1 Disconnect all cables from the system board.
 - △ **CAUTION:** Take care not to damage the system identification button while removing the system board from the system.
 - △ **CAUTION:** Do not lift the system board by holding a memory module, processor, or other components.
- 2 Holding the system board holder, pull the blue release pin, and slide the system board toward the front of the system to disengage the connectors from the slots on the system.
- 3 Incline the system board at an angle, and lift the system board out of the system.

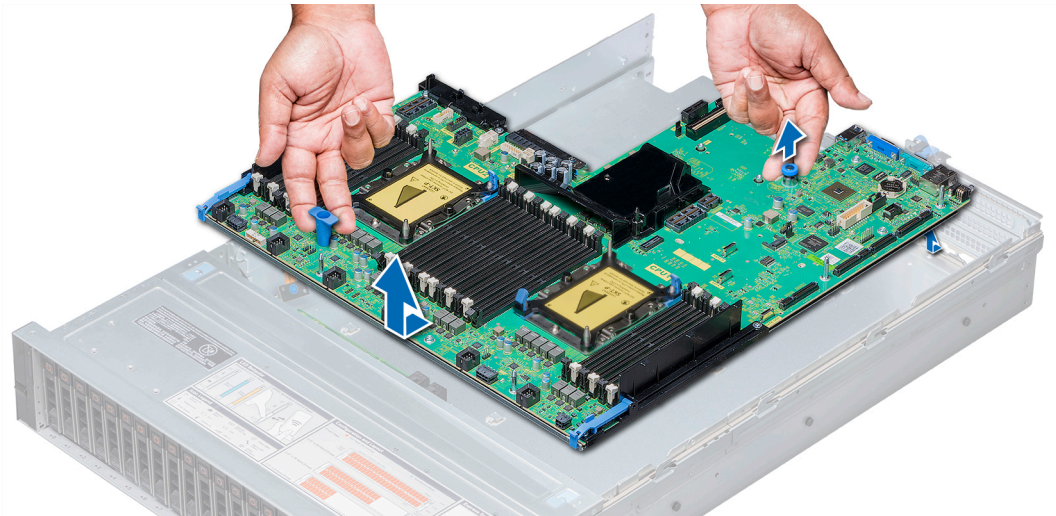

Figure 131. Removing system board

Next step

Install the system board.

Installing system board

Prerequisite

Follow the safety guidelines listed in [Safety instructions](#).

Steps

- 1 Unpack the replacement system board assembly.

⚠ CAUTION: Do not lift the system board by holding a memory module, processor, or other components.

⚠ CAUTION: Take care not to damage the system identification button while placing the system board into the system.

- 2 Holding the system board holder and blue release pin, incline the system board, and lower the system board into the system.
- 3 Slide the system board toward the back of the system until the release pin clicks into place.

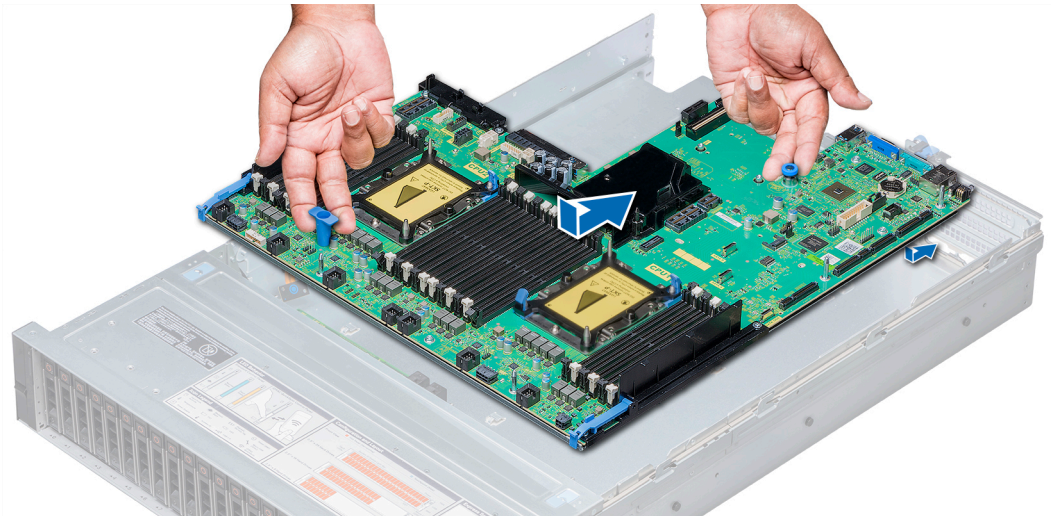

Figure 132. Installing system board

Next steps

1 Replace the following:

a [Trusted Platform Module](#)

NOTE: The TPM plug-in module is attached to the system board and cannot be removed. A replacement TPM plug-in module will be provided for all system board replacements where a TPM plug-in module was installed.

b [Integrated storage controller card](#)

c [Optional internal USB memory key](#) (if applicable)

d [USB 3.0 module](#) (if applicable)

e [Optional IDSDM or vFlash module](#)

f [Expansion cards and expansion card risers](#)

g [Processor and heat sink module](#)

h [Processor blank](#) (if applicable)

i [Memory modules](#) and memory module blanks

j [Network daughter card](#)

k [Cooling fan assembly](#)

l [Air shroud](#)

m [Power supply units](#)

2 Reconnect all cables to the system board.

NOTE: Ensure that the cables inside the system are routed along the chassis wall and secured using the cable securing bracket.

3 Follow the procedure listed in [After working inside your system](#).

4 Ensure that you:

a Use the Easy Restore feature to restore the Service Tag. For more information, see [Restoring the Service Tag using Easy Restore](#).

b If the Service Tag is not backed up in the backup flash device, enter the Service Tag manually. For more information, see [Entering the system Service Tag by using System Setup](#).

c Update the BIOS and iDRAC versions.

d Re-enable the Trusted Platform Module (TPM). For more information, see [Upgrading the Trusted Platform Module](#).

5 Import your new or existing iDRAC Enterprise license.

For more information, see Integrated Dell Remote Access Controller User's Guide, at Dell.com/poweredge/manuals.

Restoring the Service Tag using Easy Restore

The easy restore feature allows you to restore your service tag, license, UEFI configuration, and the system configuration data after replacing the system board. All data is backed up in a backup flash device automatically. If BIOS detects a new system board, and the service tag in the backup flash device, BIOS prompts the user to restore the backup information.

Below is a list of options available:

- Restore the service tag, license, and diagnostics information, press **Y**
- Navigate to the Lifecycle Controller based restore options, press **N**.
- Restore data from a previously created **Hardware Server Profile**, press **F10**

NOTE: When the restore process is complete, BIOS prompts to restore the system configuration data.

- To restore the system configuration data, press **Y**
- To use the default configuration settings, press **N**

NOTE: After the restore process is complete, system reboots.

Manually update the Service Tag

After replacing a system board, if Easy Restore fails, follow this process to manually enter the Service Tag, using **System Setup**.

About this task

If you know the system service tag, use the **System Setup** menu to enter the service tag.

Steps

- 1 Turn on the system.
- 2 To enter the **System Setup**, press **F2**.
- 3 Click **Service Tag Settings**.
- 4 Enter the service tag.

NOTE: You can enter the service tag only when the Service Tag field is empty. Ensure that you enter the correct service tag. Once the service tag is entered, it cannot be updated or changed.

- 5 Click **OK**.

Entering the system Service Tag by using System Setup

If Easy Restore fails to restore the Service Tag, use System Setup to enter the Service Tag.

- 1 Turn on the system.
- 2 Press F2 to enter System Setup.
- 3 Click **Service Tag Settings**.
- 4 Enter the Service Tag.

NOTE: You can enter the Service Tag only when the Service Tag field is empty. Ensure that you enter the correct Service Tag. After the Service Tag is entered, it cannot be updated or changed.

- 5 Click **OK**.
- 6 Import your new or existing iDRAC Enterprise license.

For more information, see the *Integrated Dell Remote Access Controller User's Guide* at Dell.com/poweredge/manuals.

Trusted Platform Module

Upgrading the Trusted Platform Module

Prerequisites

- 1 Follow the safety guidelines listed in [Safety instructions](#).
- 2 Follow the procedure listed in [Before working inside your system](#).

NOTE:

- Ensure that your operating system supports the version of the TPM module being installed.
- Ensure that you download and install the latest BIOS firmware on your system.
- Ensure that the BIOS is configured to enable UEFI boot mode.

About this task

CAUTION: If you are using the Trusted Platform Module (TPM) with an encryption key, you may be prompted to create a recovery key during program or System Setup. Work with the customer to create and safely store this recovery key. When replacing this system board, you must supply the recovery key when you restart your system or program before you can access the encrypted data on your hard drives.

CAUTION: Once the TPM plug-in module is installed, it is cryptographically bound to that specific system board. Any attempt to remove an installed TPM plug-in module breaks the cryptographic binding, the removed TPM cannot be reinstalled or installed on another system board.

Removing the TPM

- 1 Locate the TPM connector on the system board.
- 2 Press to hold the module down and remove the screw using the security Torx 8-bit shipped with the TPM module.
- 3 Slide the TPM module out from its connector.
- 4 Push the plastic rivet away from the TPM connector and rotate it 90° counterclockwise to release it from the system board.
- 5 Pull the plastic rivet out of its slot on the system board.

Installing the TPM

Steps

- 1 To install the TPM, align the edge connectors on the TPM with the slot on the TPM connector.
- 2 Insert the TPM into the TPM connector such that the plastic rivet aligns with the slot on the system board.
- 3 Press the plastic rivet until the rivet snaps into place.

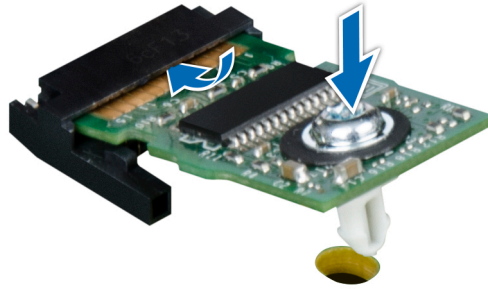

Figure 133. Installing the TPM

- 4 Replace the screw that secures the TPM to the system board.

Next steps

- 1 [Install the system board.](#)
- 2 Follow the procedure listed in [After working inside your system.](#)

Initializing TPM for BitLocker users

Initialize the TPM.

For more information, see .

The **TPM Status** changes to **Enabled, Activated**.

Initializing the TPM 1.2 for TXT users

- 1 While booting your system, press F2 to enter System Setup.
- 2 On the **System Setup Main Menu** screen, click **System BIOS > System Security Settings**.
- 3 From the **TPM Security** option, select **On with Pre-boot Measurements**.
- 4 From the **TPM Command** option, select **Activate**.
- 5 Save the settings.
- 6 Restart your system.
- 7 Enter **System Setup** again.
- 8 On the **System Setup Main Menu** screen, click **System BIOS > System Security Settings**.
- 9 From the **Intel TXT** option, select **On**.

Initializing the TPM 2.0 for TXT users

- 1 While booting your system, press F2 to enter System Setup.
- 2 On the **System Setup Main Menu** screen, click **System BIOS > System Security Settings**.
- 3 From the **TPM Security** option, select **On**.
- 4 Save the settings.
- 5 Restart your system.
- 6 Enter **System Setup** again.

- 7 On the **System Setup Main Menu** screen, click **System BIOS > System Security Settings**.
- 8 Select the **TPM Advanced Settings** option.
- 9 From the **TPM2 Algorithm Selection** option, select **SHA256**, then go back to **System Security Settings** screen.
- 10 On the **System Security Settings** screen, from the **Intel TXT** option, select **On**.
- 11 Save the settings.
- 12 Restart your system.

Control panel

Control panel details

Your system supports:

- Left control panel: Contains status LEDs, system ID button, and iDRAC Quick Sync 2 (optional).
- Right control panel: Contains power button, USB 2.0 port, VGA port micro USB for iDRAC Direct, and status LED for iDRAC Direct.

Removing the left control panel

Prerequisites

- 1 Follow the safety guidelines listed in [Safety instructions](#).
- 2 Follow the procedure listed in [Before working inside your system](#).
- 3 [Remove the cooling fan assembly](#).
- 4 [Remove the air shroud](#)

Steps

- 1 Pull the cable latch and disconnect the control panel cable from the system board connector.
- 2 Using a Phillips #1 screwdriver, remove the screws to remove the cable cover, which secure the left control panel and cable tube to the system.
- 3 Holding the control panel and cable tube by its sides, remove the control panel and cable tube away from the system.

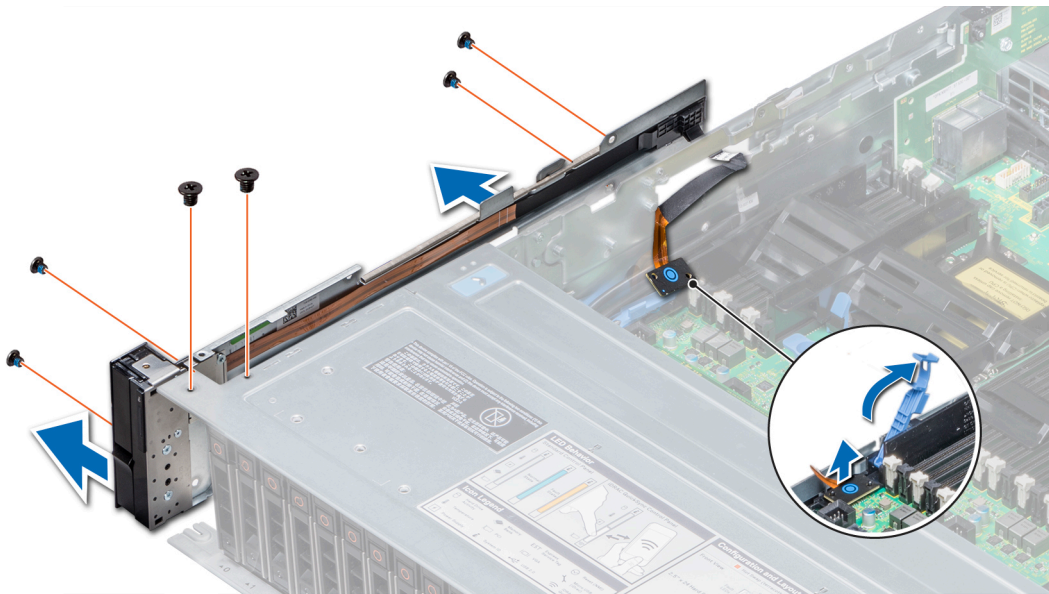

Figure 134. Removing left control panel

Next step

Install the left control panel.

Installing the left control panel

Prerequisite

Follow the safety guidelines listed in [Safety instructions](#).

Steps

- 1 Route the control panel cable through the side wall of the system.
- 2 Align the left control panel assembly with the control panel slot on the system and place the assembly in the slot on the system.
- 3 Connect the control panel cable to the system board connector and secure it using cable latch.
- 4 Using a Phillips #1 screwdriver, install the screws that secure the control panel and cable tube to the system.

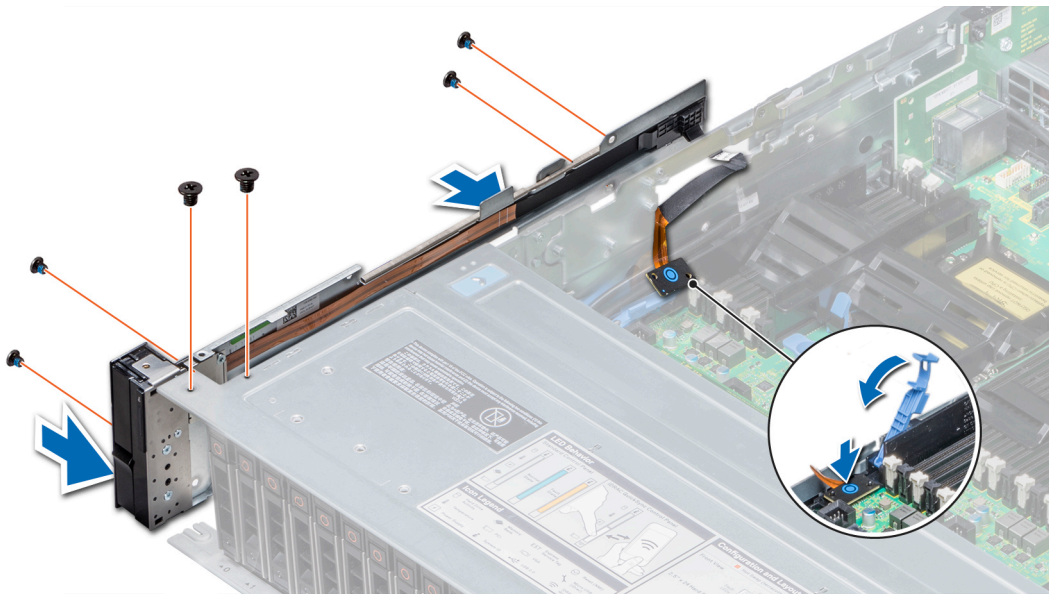

Figure 135. Installing left control panel

Next steps

- 1 [Install the air shroud.](#)
- 2 [Install the cooling fan assembly.](#)
- 3 Follow the procedure listed in [After working inside your system.](#)

Removing the right control panel

Prerequisites

- 1 Follow the safety guidelines listed in [Safety instructions.](#)
- 2 Follow the procedure listed in [Before working inside your system.](#)
- 3 [Remove the air shroud.](#)
- 4 [Remove the cooling fan assembly.](#)

Steps

- 1 Disconnect the VGA cable from the system board.
- 2 Pull the cable latch and disconnect the control panel cable from the system board connector.
- 3 Using Phillips #1 screwdriver, remove the screws that secure the control panel and cable tube to the system.
- 4 Holding the control panel and cable tube by its sides, remove the control panel and cable tube away from the system.

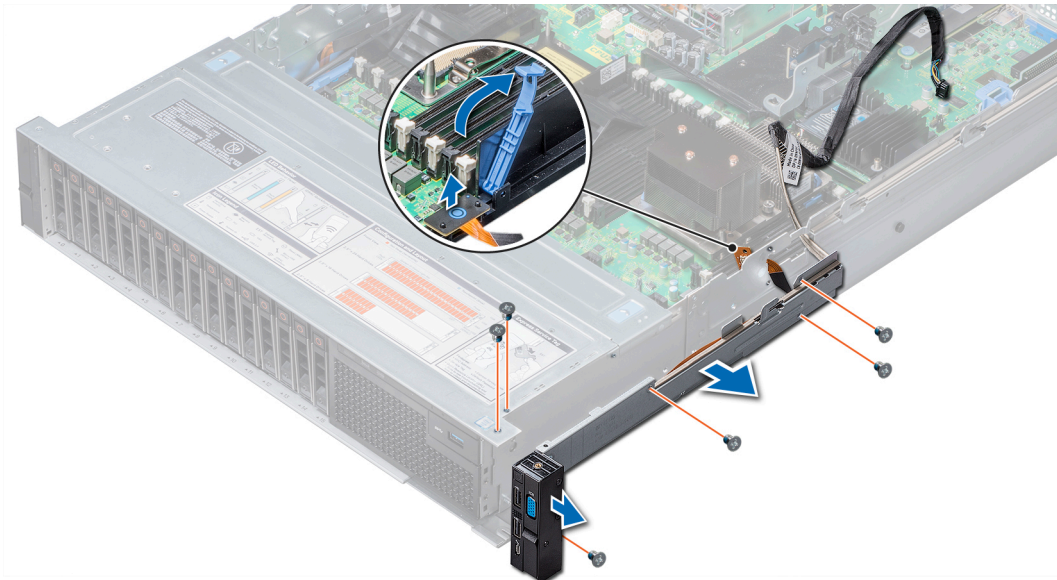

Figure 136. Removing right control panel

Next step

Install the right control panel.

Installing the right control panel

Prerequisite

Follow the safety guidelines listed in [Safety instructions](#).

Steps

- 1 Route the control panel cable and VGA cable through the side wall of the system.
- 2 Align the control panel with the control panel slot on the system and attach the control panel to the system.
- 3 Connect the VGA cable to the system board.
- 4 Connect the control panel cable to the connector on the system board and lower the cable latch to secure the cable in place.
- 5 Using a Phillips #1 screwdriver, install the screw that secures the control panel and cable tube to the system.

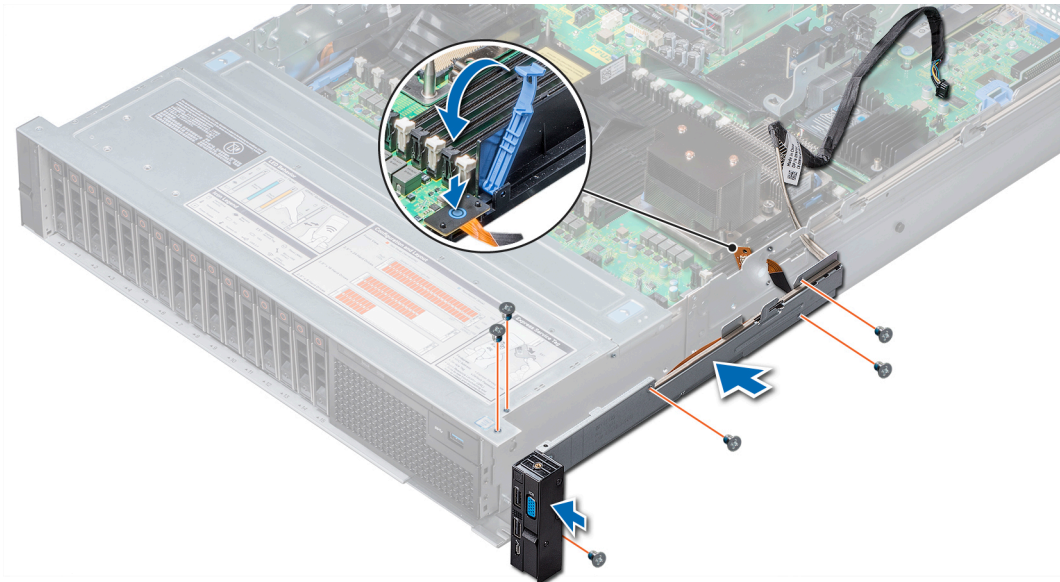

Figure 137. Installing right control panel

Next steps

- 1 [Install the cooling fan assembly.](#)
- 2 [Install the air shroud.](#)
- 3 Follow the procedure listed in [After working inside your system.](#)

Using system diagnostics

If you experience a problem with your system, run the system diagnostics before contacting Dell for technical assistance. The purpose of running system diagnostics is to test your system hardware without using additional equipment or risking data loss. If you are unable to fix the problem yourself, service and support personnel can use the diagnostics results to help you solve the problem.

Dell Embedded System Diagnostics

NOTE: The Dell Embedded System Diagnostics is also known as Enhanced Pre-boot System Assessment (ePSA) diagnostics.

The Embedded System Diagnostics provides a set of options for particular device groups or devices allowing you to:

- Run tests automatically or in an interactive mode
- Repeat tests
- Display or save test results
- Run thorough tests to introduce additional test options to provide extra information about the failed device(s)
- View status messages that inform you if tests are completed successfully
- View error messages that inform you of problems encountered during testing

Running the Embedded System Diagnostics from Boot Manager

Run the Embedded System Diagnostics (ePSA) if your system does not boot.

- 1 When the system is booting, press F11.
- 2 Use the up arrow and down arrow keys to select **System Utilities > Launch Diagnostics**.
- 3 Alternatively, when the system is booting, press F10, select **Hardware Diagnostics > Run Hardware Diagnostics**.
The **ePSA Pre-boot System Assessment** window is displayed, listing all devices detected in the system. The diagnostics starts executing the tests on all the detected devices.

Running the Embedded System Diagnostics from the Dell Lifecycle Controller

- 1 As the system boots, press F10.
- 2 Select **Hardware Diagnostics → Run Hardware Diagnostics**.
The **ePSA Pre-boot System Assessment** window is displayed, listing all devices detected in the system. The diagnostics starts executing the tests on all the detected devices.

System diagnostic controls

Menu	Description
Configuration	Displays the configuration and status information of all detected devices.
Results	Displays the results of all tests that are run.
System health	Provides the current overview of the system performance.
Event log	Displays a time-stamped log of the results of all tests run on the system. This is displayed if at least one event description is recorded.

Jumpers and connectors

This topic provides specific information about the jumpers. It also provides some basic information about jumpers and switches and describes the connectors on the various boards in the system. Jumpers on the system board help to disable the system and setup passwords. You must know the connectors on the system board to install components and cables correctly.

Topics:

- [System board jumpers and connectors](#)
- [System board jumper settings](#)
- [Disabling forgotten password](#)

System board jumpers and connectors

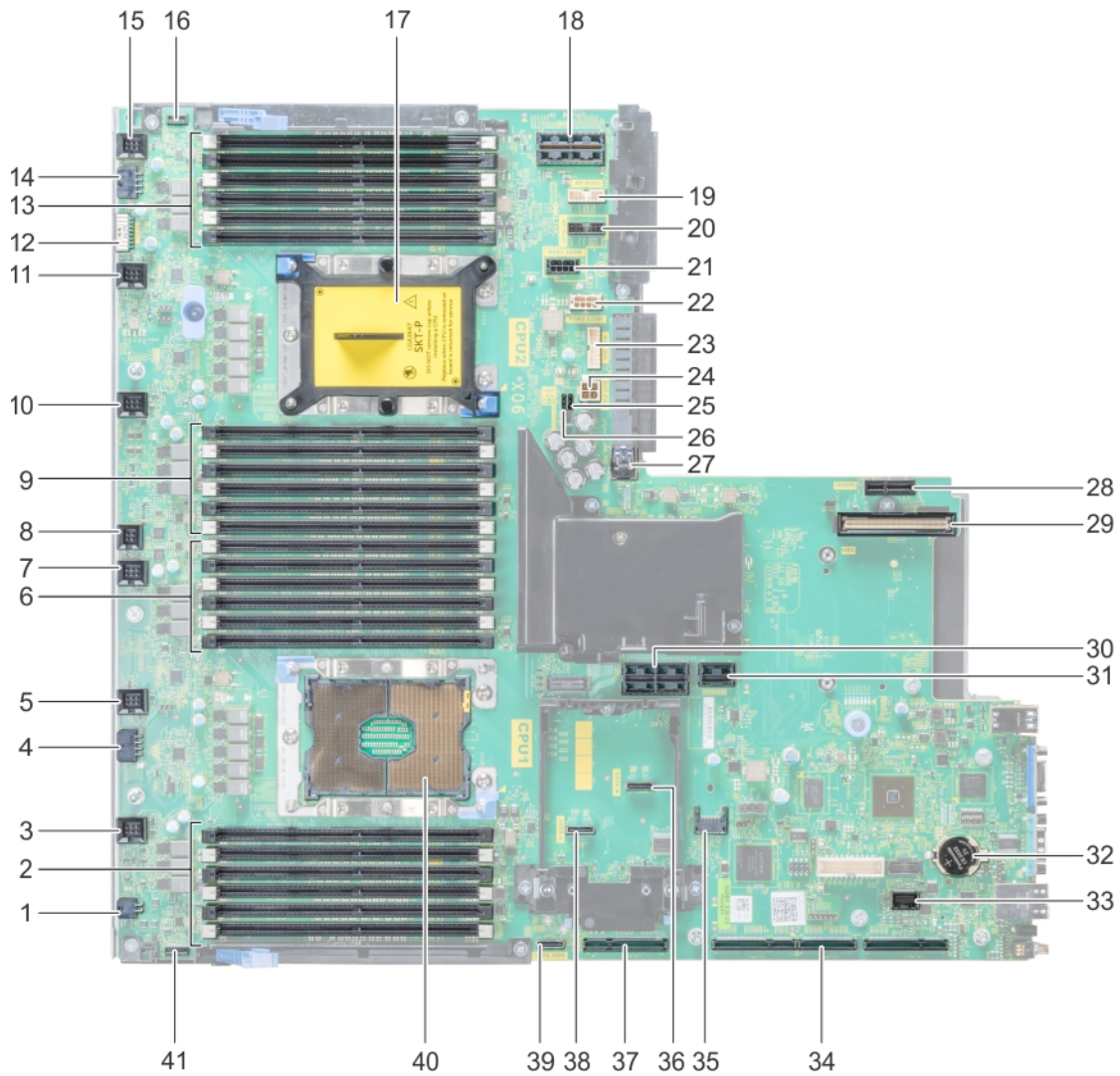

Figure 138. System board jumpers and connectors

Table 49. System board jumpers and connectors





Item	Connector	Description
1	J_ODD	Optical drive power connector
2	A7, A1, A8, A2, A9, A3	Memory module sockets
3	J_FAN2U_6	Cooling fan 6 connector
4	J_BP3	Backplane 3 power connector
5	J_FAN2U_5	Cooling fan 5 connector
6	A6, A12, A5, A11, A4, A10	Memory module sockets
7	J_FAN2U_4	Cooling fan 4 connector

Item	Connector	Description
8	INTRUSION_DET	Intrusion switch connector
9	B7, B1, B8, B2, B9, B3	Memory module sockets
10	J_FAN2U_3	Cooling fan 3 connector
11	J_FAN2U_2	Cooling fan 2 connector
12	J_BP_SIG1	Backplane 1 signal connector
13	B6, B12, B5, B11, B4, B10	Memory module sockets
14	J_BP1	Backplane 1 power connector
15	J_FAN2U_1	Cooling fan 1 connector
16	P_LFT_CP	Left control panel connector
17	CPU2	CPU2 processor and heat sink module socket (with dust cover)
18	J_R3_X24	Riser 3 connector
19	J_BP_SIG2	Backplane 2 signal connector
20	J_BP_SIG0	Backplane 0 signal connector
21	J_BP0 (RSR3_225W)	Backplane 0 power connector (Riser 3 PCIe 225 W power)
22	J_BP2 (RSR2_225W)	Backplane 2 power connector (Riser 2 PCIe 225 W power)
23	J_BATT_SIG	NVDIMM-N battery signal connector
24	J_BATT_PWR	NVDIMM-N battery power connector
25	PWRD_EN	Reset BIOS password
26	NVRAM_CLR	Clear NVRAM
27	J_USB_INT	Internal USB connector
28	J_IDSDM	IDS DM/vFlash connector
29	J_NDC	NDC connector
30	J_R2_X24_IT9	Riser 2 connector
31	J_R2_3R_X8_IT9	Riser 2 connector
32	BATTERY	Battery connector
33	J_FRONT_VIDEO	Video connector
34	J_R1_SS82_3 and J_R1_SS60_1	Riser 1 connector
35	J_TPM_MODULE	TPM connector
36	J_SATA_B	SATA B connector
37	J_R1_SS82_1	Riser 1 connector (Mini PERC option)
38	J_SATA_A	SATA A connector
39	J_SATA_C	SATA C connector (Optical drive SATA connector)
40	CPU1	CPU1 processor and heat sink module
41	P_RGT_CP	Right control panel connector

System board jumper settings

For information on resetting the password jumper to disable a password, see the [Disabling a forgotten password](#) section.

Table 50. System board jumper settings

Jumper	Setting	Description
PWRD_EN	 (default)	The BIOS password feature is enabled.
		The BIOS password feature is disabled. iDRAC local access is unlocked at next AC power cycle. iDRAC password reset is enabled in F2 iDRAC settings menu.
NVRAM_CLR	 (default)	The BIOS configuration settings are retained at system boot.
		The BIOS configuration settings are cleared at system boot.

Disabling forgotten password

The software security features of the system include a system password and a setup password. The password jumper enables or disables password features and clears any password(s) currently in use.

Prerequisite

⚠ CAUTION: Many repairs may only be done by a certified service technician. You should only perform troubleshooting and simple repairs as authorized in your product documentation, or as directed by the online or telephone service and support team. Damage due to servicing that is not authorized by Dell is not covered by your warranty. Read and follow the safety instructions that are shipped with your product.

Steps

- 1 Power off the system, including any attached peripherals, and disconnect the system from the electrical outlet.
 - 2 Remove the system cover.
 - 3 Move the jumper on the system board jumper from pins 2 and 4 to pins 4 and 6.
 - 4 Install the system cover.

The existing passwords are not disabled (erased) until the system boots with the jumper on pins 4 and 6. However, before you assign a new system and/or setup password, you must move the jumper back to pins 2 and 4.
- ⓘ NOTE:** If you assign a new system and/or setup password with the jumper on pins 4 and 6, the system disables the new password(s) the next time it boots.
- 5 Reconnect the system to its electrical outlet and power on the system, including any attached peripherals.
 - 6 Power off the system, including any attached peripherals, and disconnect the system from the electrical outlet.
 - 7 Remove the system cover.
 - 8 Move the jumper on the system board jumper from pins 4 and 6 to pins 2 and 4.
 - 9 Install the system cover.
 - 10 Reconnect the system to its electrical outlet and power on the system, including any attached peripherals.
 - 11 Assign a new system and/or setup password.

Getting help

Topics:

- [Contacting Dell EMC](#)
- [Documentation feedback](#)
- [Accessing system information by using QRL](#)
- [Receiving automated support with SupportAssist](#)
- [Recycling or End-of-Life service information](#)

Contacting Dell EMC

Dell EMC provides several online and telephone based support and service options. If you do not have an active internet connection, you can find contact information about your purchase invoice, packing slip, bill, or Dell EMC product catalog. Availability varies by country and product, and some services may not be available in your area. To contact Dell EMC for sales, technical assistance, or customer service issues:

- 1 Go to Dell.com/support/home.
- 2 Select your country from the drop-down menu on the lower right corner of the page.
- 3 For customized support:
 - a Enter your system Service Tag in the **Enter your Service Tag** field.
 - b Click **Submit**.The support page that lists the various support categories is displayed.
- 4 For general support:
 - a Select your product category.
 - b Select your product segment.
 - c Select your product.The support page that lists the various support categories is displayed.
- 5 For contact details of Dell EMC Global Technical Support:
 - a Click [Global Technical Support](#).
 - b The **Contact Technical Support** page is displayed with details to call, chat, or e-mail the Dell EMC Global Technical Support team.

Documentation feedback

You can rate the documentation or write your feedback on any of our Dell EMC documentation pages and click **Send Feedback** to send your feedback.

Accessing system information by using QRL

You can use the Quick Resource Locator (QRL) located on the information tag in the front of the R740, to access the information about the Dell EMC PowerEdge R740.

Prerequisites

Ensure that your smartphone or tablet has the QR code scanner installed.

The QRL includes the following information about your system:

- How-to videos
- Reference materials, including the Installation and Service Manual, LCD diagnostics, and mechanical overview
- Your system service tag to quickly access your specific hardware configuration and warranty information
- A direct link to Dell to contact technical assistance and sales teams

Steps

- 1 Go to Dell.com/qrl and navigate to your specific product or
- 2 Use your smartphone or tablet to scan the model-specific Quick Resource (QR) code on your system or in the Quick Resource Locator section.

Quick Resource Locator for PowerEdge R740 and R740xd systems



Figure 139. Quick Resource Locator for PowerEdge R740 and R740xd systems

Receiving automated support with SupportAssist

Dell EMC SupportAssist is an optional Dell EMC Services offering that automates technical support for your Dell EMC server, storage, and networking devices. By installing and setting up a SupportAssist application in your IT environment, you can receive the following benefits:

- **Automated issue detection** — SupportAssist monitors your Dell EMC devices and automatically detects hardware issues, both proactively and predictively.
- **Automated case creation** — When an issue is detected, SupportAssist automatically opens a support case with Dell EMC Technical Support.
- **Automated diagnostic collection** — SupportAssist automatically collects system state information from your devices and uploads it securely to Dell EMC. This information is used by Dell EMC Technical Support to troubleshoot the issue.
- **Proactive contact** — A Dell EMC Technical Support agent contacts you about the support case and helps you resolve the issue.

The available benefits vary depending on the Dell EMC Service entitlement purchased for your device. For more information about SupportAssist, go to Dell.com/supportassist.

Recycling or End-of-Life service information

Take back and recycling services are offered for this product in certain countries. If you want to dispose of system components, visit Dell.com/recyclingworldwide and select the relevant country.