

Optix Series

LCD Monitor

Optix MAG271CQR (3FA75)

Contents

Copyright and Trademarks Notice	iii
Revision	iii
Technical Support	iii
Safety Instructions.....	iv
CE Conformity.....	vi
FCC-B Radio Frequency Interference Statement	vi
WEEE Statement	vii
Chemical Substances Information	vii
RoHS Statement	vii

Getting Started.....1-1

Package Contents.....	1-2
Installing the Monitor Stand.....	1-3
Adjusting the Monitor	1-4
Monitor Overview	1-5
Connecting the Monitor to PC	1-7
Wall Mounting (Optional).....	1-8

OSD Setup.....2-1

Navi Key.....	2-2
OSD Setup via Navi Key.....	2-5

AppendixA-1

Specifications	A-2
Preset Display Modes	A-4
Troubleshooting	A-5

Copyright and Trademarks Notice

Copyright © Micro-Star Int'l Co., Ltd. All rights reserved. The MSI logo used is a registered trademark of Micro-Star Int'l Co., Ltd. All other marks and names mentioned may be trademarks of their respective owners. No warranty as to accuracy or completeness is expressed or implied. MSI reserves the right to make changes to this document without prior notice.

Revision

Revision	Date
V1.0	2018/10

Technical Support

If a problem arises with your product and no solution can be obtained from the user's manual, please contact your place of purchase or local distributor. Alternatively, please visit <https://www.msi.com/support/> for further guidance.

Safety Instructions



- ☑ Read the safety instructions carefully and thoroughly.
- ☑ All cautions and warnings on the device or user's manual should be noted.
- ☑ Refer servicing to qualified personnel only.



Keep the User's Guide that comes with the package for future reference.



To prevent fire or shock hazard, keep this device away from humidity and high temperature.



Lay this device on a reliable flat surface before setting it up.



- ☑ Make sure that the power voltage is within its safety range and has been adjusted properly to the value of 100~240V before connecting the device to the power outlet. Do not disable the protective earth pin from the plug. The device must be connected to an earthed mains socket-outlet.
- ☑ Always disconnect the power cord or switch the wall socket off if the device would be left unused for a certain time to achieve zero energy consumption.



The ventilator on the device is used for air convection and to prevent the device from overheating. Do not cover the ventilator.



Do not leave the device in an unconditioned environment with a storage temperature above 60°C or below -20°C, which may damage the device.

NOTE: The maximum operating temperature is around 40°C.



When cleaning the device, be sure to remove the power plug. Use a piece of soft cloth rather than industrial chemical to clean the device. Never pour any liquid into the opening; that could damage the device or cause electric shock.



Place the power cord in a way that people are unlikely to step on it. Do not place anything on the power cord.



Always keep strong magnetic or electrical objects away from the device.



If any of the following situations arises, get the device checked by service personnel:

- ☑ The power cord or plug is damaged.
- ☑ Liquid has penetrated into the device.
- ☑ The device has been exposed to moisture.
- ☑ The device does not work well or you can not get it work according to user's manual.
- ☑ The device has dropped and damaged.
- ☑ The device has obvious sign of breakage.

Green Product Features

- ☑ Reduced energy consumption during use and stand-by
- ☑ Limited use of substances harmful to the environment and health
- ☑ Easily dismantled and recycled
- ☑ Reduced use of natural resources by encouraging recycling
- ☑ Extended product lifetime through easy upgrades
- ☑ Reduced solid waste production through take-back policy



Environmental Policy

- ☑ The product has been designed to enable proper reuse of parts and recycling and should not be thrown away at its end of life.
- ☑ Users should contact the local authorized point of collection for recycling and disposing of their end-of-life products.
- ☑ Visit the MSI website and locate a nearby distributor for further recycling information.
- ☑ Users may also reach us at gpcontdev@msi.com for information regarding proper disposal, take-back, recycling, and disassembly of MSI products.

★ Warning! Overuse of screens is likely to affect eyesight.

★ Recommendations:

1. Take a 10-minute break for every 30 minutes of screen time.
2. Children under 2 years of age should have no screen time. For children aged 2 years and over, screen time should be limited to less than one hour per day.

CE Conformity

This device complies with the requirements set out in the Council Directive on the Approximation of the Laws of the Member States relating to Electromagnetic Compatibility (2014/30/EU), Low-voltage Directive (2014/35/EU), ErP Directive (2009/125/EC) and RoHS directive (2011/65/EU).



This product has been tested and found to comply with the harmonized standards for Information Technology Equipment published under Directives of Official Journal of the European Union.

FCC-B Radio Frequency Interference Statement



This equipment has been tested and found to comply with the limits for a Class B digital device, pursuant to Part 15 of the FCC Rules. These limits are designed to provide reasonable protection against harmful interference in a residential installation. This equipment generates, uses and can radiate radio frequency energy and, if not installed and used in accordance with the instruction manual, may cause harmful interference to radio communications. However, there is no guarantee that interference will not occur in a particular installation. If this equipment does cause harmful interference to radio or television reception, which can be determined by turning the equipment off and on, the user is encouraged to try to correct the interference by one or more of the measures listed below:

- Reorient or relocate the receiving antenna.
- Increase the separation between the equipment and receiver.
- Connect the equipment into an outlet on a circuit different from that to which the receiver is connected.
- Consult the dealer or an experienced radio/television technician for help.

Notice 1

The changes or modifications not expressly approved by the party responsible for compliance could void the user's authority to operate the equipment.

Notice 2

Shielded interface cables and AC power cord, if any, must be used in order to comply with the emission limits.

This device complies with Part 15 of the FCC Rules. Operation is subject to the following two conditions:

1. this device may not cause harmful interference, and
2. this device must accept any interference received, including interference that may cause undesired operation.

MSI Computer Corp.

901 Canada Court, City of Industry, CA 91748, USA

(626)913-0828

www.msi.com

WEEE Statement

Under the European Union (“EU”) Directive on Waste Electrical and Electronic Equipment, Directive 2012/19/EU, which takes effect on August 13, 2005, products of “electrical and electronic equipment” cannot be discarded as municipal waste anymore and manufacturers of covered electronic equipment will be obligated to take back such products at the end of their useful life.



Chemical Substances Information

In compliance with chemical substances regulations, such as the EU REACH Regulation (Regulation EC No. 1907/2006 of the European Parliament and the Council), MSI provides the information of chemical substances in products at:

https://www.msi.com/html/popup/csr/evmtprrt_pcm.html

RoHS Statement

Japan JIS C 0950 Material Declaration

A Japanese regulatory requirement, defined by specification JIS C 0950, mandates that manufacturers provide material declarations for certain categories of electronic products offered for sale after July 1, 2006.

https://www.msi.com/html/popup/csr/cemm_jp.html

https://tw.msi.com/html/popup/csr_tw/cemm_jp.html

India RoHS

This product complies with the "India E-waste (Management and Handling) Rule 2016" and prohibits use of lead, mercury, hexavalent chromium, polybrominated biphenyls or polybrominated diphenyl ethers in concentrations exceeding 0.1 weight % and 0.01 weight % for cadmium, except for the exemptions set in Schedule 2 of the Rule.

Turkey EEE Regulation

Conforms to the EEE Regulations of the Republic Of Turkey

Ukraine Restriction of Hazardous Substances

The equipment complies with requirements of the Technical Regulation, approved by the Resolution of Cabinet of Ministry of Ukraine as of December 3, 2008 № 1057, in terms of restrictions for the use of certain dangerous substances in electrical and electronic equipment.

Vietnam RoHS

As from December 1, 2012, all products manufactured by MSI comply with Circular 30/2011/TT-BCT temporarily regulating the permitted limits for a number of hazardous substances in electronic and electric products.



1

Getting Started

This chapter provides you with the information on hardware setup procedures. While connecting devices, be careful in holding the devices and use a grounded wrist strap to avoid static electricity.

IMPORTANT

- *The illustrations are for reference only. Your monitor may vary in appearance.*
- *Do not use any sharp objects on the monitor.*

Package Contents

1. Monitor
2. Stand
3. Stand Base with Screw
4. Power Cord
5. HDMI Cable
6. DisplayPort Cable
7. USB Upstream Cable (to enable the USB ports on the monitor)
8. Quick Start Guide
9. Warranty Card
10. User Manual
11. VESA Cover Screws

* Contact your place of purchase or local distributor if any of the items is damaged or missing.

* Package contents may vary by country.

Installing the Monitor Stand

1. Fit the stand to the monitor.
2. Connect the base to the stand.
3. Tighten the base screw to secure the base.

IMPORTANT

1. Place the monitor on a soft, protected surface to avoid scratching the display panel.
2. The holes for installing the stand can be also used for wall mount. Please contact your dealer for proper wall mount kit.

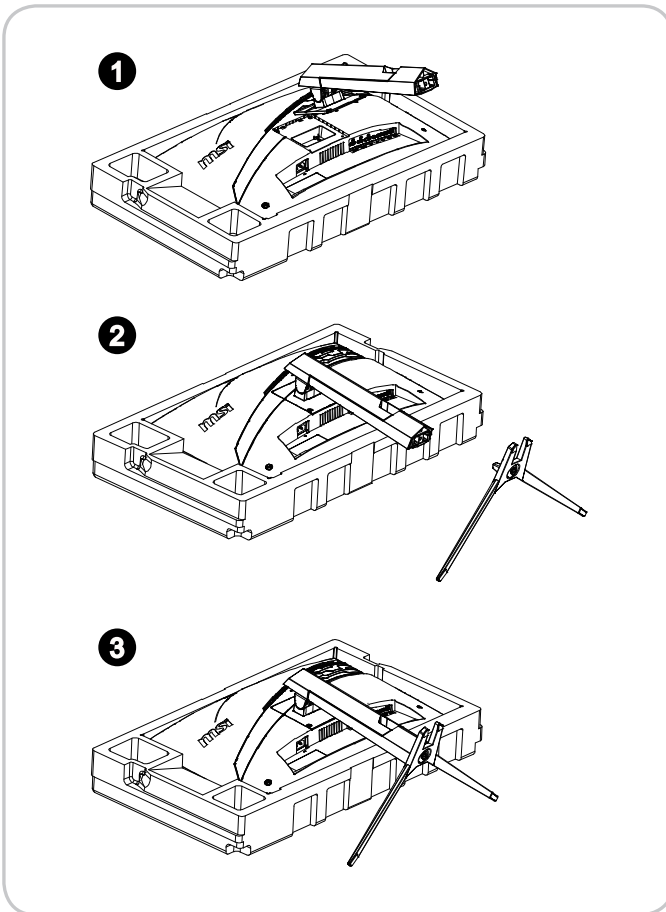

Adjusting the Monitor

This monitor is designed to maximize your viewing comfort with its adjustment capabilities such as tilt and lift.

IMPORTANT

Avoid touching the display panel when adjusting the monitor.

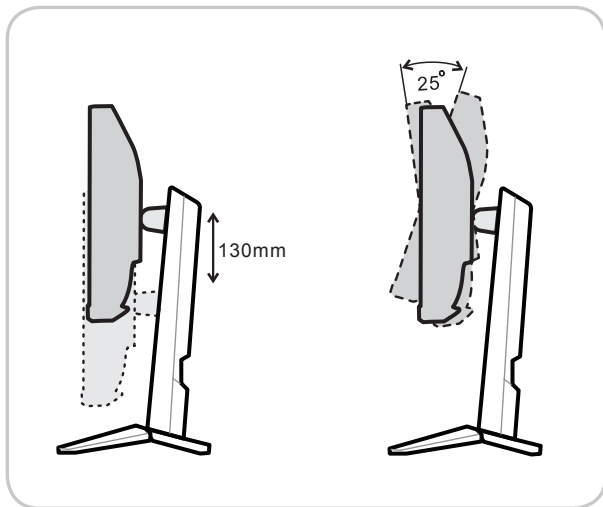

Monitor Overview

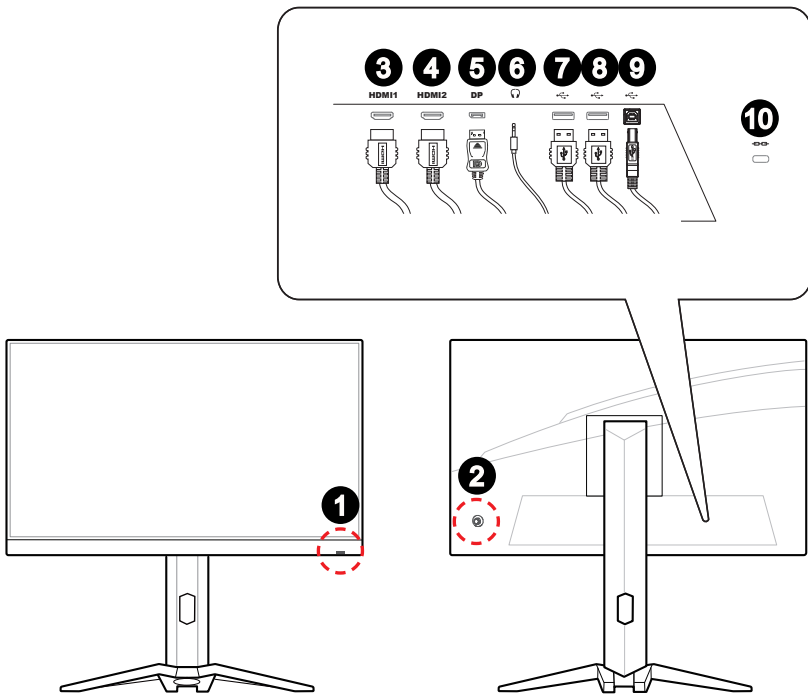

1 Power Button

2 Navi Key

3 HDMI Port **HDMI**[™]
HIGH-DEFINITION MULTIMEDIA INTERFACE

4 HDMI Port **HDMI**[™]
HIGH-DEFINITION MULTIMEDIA INTERFACE

5 DisplayPort

6 Headphone Jack

7 USB 2.0 Type A Downstream Port

8 USB 2.0 Type A Downstream Port

9 USB 2.0 Type B Upstream Port

For USB Upstream Cable.

IMPORTANT

Check the package for USB Upstream Cable and connect it to the PC and monitor. Once this cable is connected, the USB Type A Downstream Ports on the monitor will be ready for use.



10 Kensington Lock

Connecting the Monitor to PC

1. Turn off your computer.
2. Connect the HDMI/DisplayPort cable from the monitor to your computer.
3. Connect the power cord to the monitor power jack. (Figure A)
4. Plug the power cord into the electrical outlet. (Figure B)
5. Turn on the monitor. (Figure C)
6. Select your Input Source at OSD menu and power on the computer.

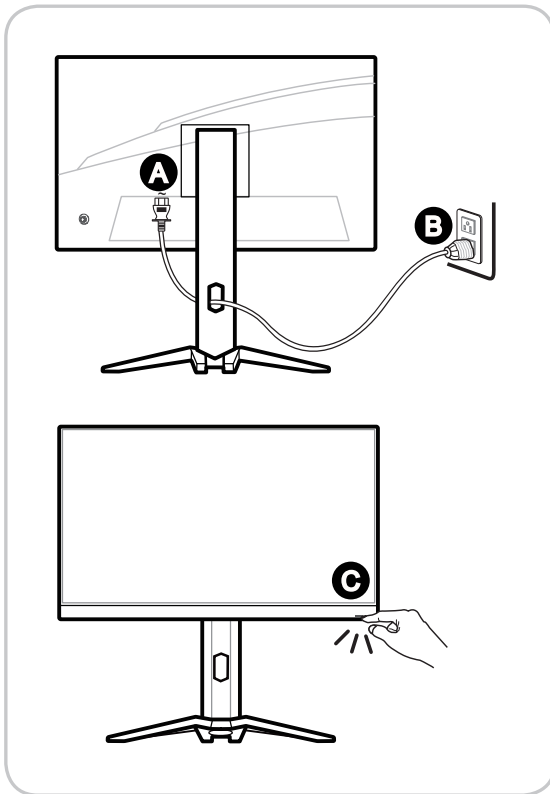



2

OSD Setup

This chapter provides you with essential information on OSD Setup.

IMPORTANT

All information is subject to change without prior notice.

Navi Key



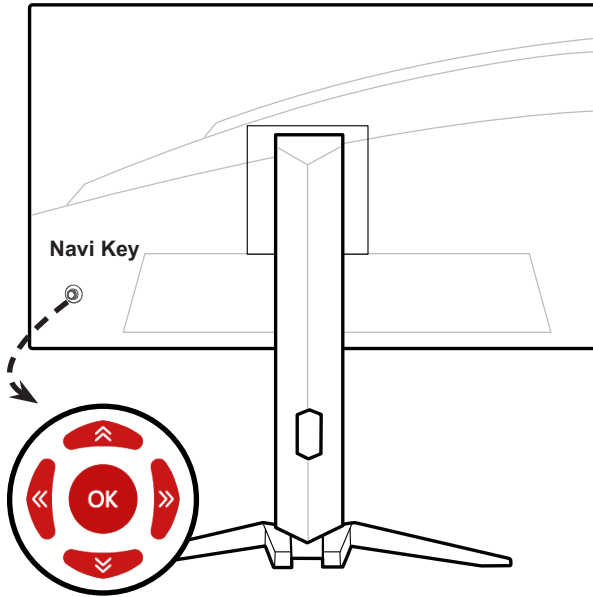



The monitor comes with a Navi Key, a multi-directional control that helps navigate the On-Screen Display (OSD) menu.

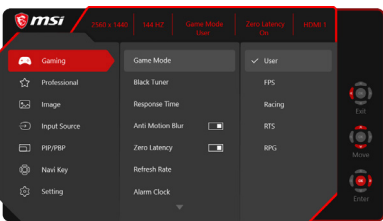

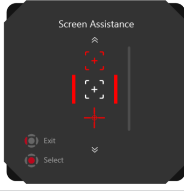

2-2

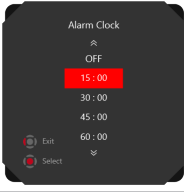
The Navi Key default settings are as follows.

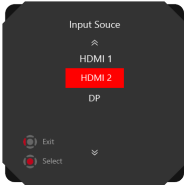
Navi Key	Hot Key (When OSD menu is OFF)	Basic Operations (When OSD menu is ON)
Middle Button 	OSD Main Menu 	<ul style="list-style-type: none"> ■ Entering submenus ■ Confirming a selection or setting

Navi Key	Hot Key (When OSD menu is OFF)	Basic Operations (When OSD menu is ON)
<p>Up</p> 	<p>Game Mode</p> 	<ul style="list-style-type: none"> ■ Press Middle Button to confirm selection and exit. ■ Press Up and Down Buttons to adjust. ■ Press Left Button to cancel preview and exit without applying mode effect.
<p>Down</p> 	<p>Screen Assistance</p> 	<ul style="list-style-type: none"> ■ Press Middle Button to confirm selection and exit. ■ Press Up and Down Buttons to adjust. ■ Press Left Button to cancel preview and exit.
<p>Left</p> 	<p>Alarm Clock</p> 	<ul style="list-style-type: none"> ■ Press Middle Button to confirm selection and exit. ■ Press Up and Down Buttons to select. ■ Press Left Button to cancel preview and exit.
<p>Right</p> 	<p>Input Source</p> 	<ul style="list-style-type: none"> ■ Press Middle Button to confirm selection and exit. ■ Press Up and Down Buttons to select. ■ Press Left Button to exit.

Users may enter the OSD Menu to customize their own Navi Key Hot Keys.
 More Hot Key options are as below.

Navi Key Hot Key Options	Operations
Brightness 	<ul style="list-style-type: none"> ■ Press Middle Button to save value and exit. ■ Press Up and Down Buttons to adjust. ■ Press Left Button to cancel preview and exit. ■ Brightness default for QHD is 80.
PIP/PBP 	<ul style="list-style-type: none"> ■ Press Middle Button to confirm selection and exit. ■ Press Up and Down Buttons to adjust. ■ Press Left Button to cancel preview and exit.
Refresh Rate 	<ul style="list-style-type: none"> ■ Press Middle Button to confirm selection and exit. ■ Press Right Button to turn on and Left Button to turn off the Refresh Rate.

OSD Setup via Navi Key

Press the Middle button of Navi Key to launch the On-Screen Display (OSD) main menu. Use the Up, Down, Left, Right buttons to tune the desired function menus to suit your personal preferences.

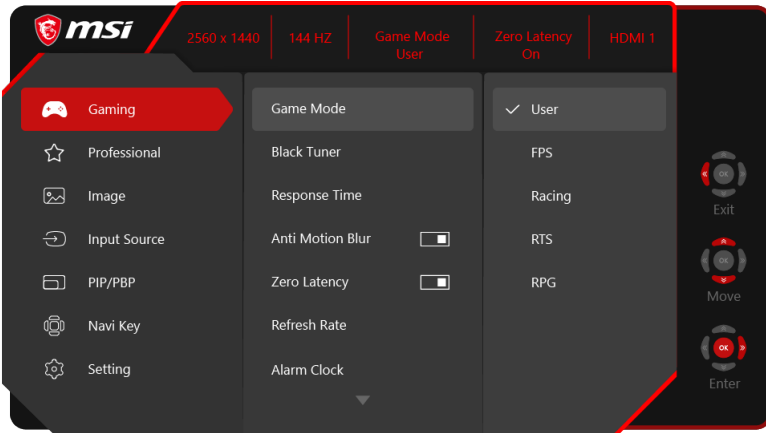

► GAMING

1st Level Menu	2nd/3rd Level Menu	Description
Game Mode	User	Default mode. All items can be adjusted by users.
	FPS	All items can be adjusted, except for Black Tuner, Image Enhancement, Brightness and Contrast.
	Racing	All items can be adjusted, except for Brightness, Contrast and Image Enhancement.
	RTS	All items can be adjusted, except for Brightness, Contrast and Image Enhancement.
	RPG	All items can be adjusted, except for Brightness, Contrast, Black Tuner and Image Enhancement.
	<ul style="list-style-type: none"> ■ Use Up or Down Button to select and preview mode effects. ■ Press the Middle Button to confirm and apply your mode type. 	
Black Tuner	0-20	<ul style="list-style-type: none"> ■ Use Up or Down Button to adjust the value. ■ This function improves background brightness and is recommended for FPS games.
Response Time	Normal	<ul style="list-style-type: none"> ■ Users can adjust Response Time in any Mode. ■ When Response Time is set to Fastest with at least 75Hz Screen Refresh Rate, Anti Motion Blur will be automatically enabled. ■ When Screen Refresh Rate is lower than 75HZ, "Fastest" will be grayed out. ■ This function is recommended for FPS and Racing games.
	Fast	
	Fastest	

1st Level Menu	2nd/3rd Level Menu	Description				
Anti Motion Blur	<input checked="" type="checkbox"/> (OFF) <input type="checkbox"/> (ON)	<ul style="list-style-type: none"> Brightness cannot be adjusted when Anti Motion Blur is set to ON. When Response Time is set to Fastest with at least 75Hz Screen Refresh Rate, Anti Motion Blur will be automatically enabled. When Screen Refresh Rate is lower than 75HZ, Anti Motion Blur cannot be enabled and Response Time cannot be set to Fastest. When Anti Motion Blur is enabled, HDCR cannot be enabled and will be grayed out. This function is recommended for cinema, FPS and Racing games. When FreeSync is enabled, Anti Motion Blur will be grayed out. 				
Zero Latency	<input checked="" type="checkbox"/> (OFF) <input type="checkbox"/> (ON)	<ul style="list-style-type: none"> Zero Latency default is ON. Zero Latency helps to reduce the signal throughput timing and supports QHD only. 				
Refresh Rate	Location <table border="1" style="display: inline-table; vertical-align: top;"> <tr><td>Left Top</td></tr> <tr><td>Right Top</td></tr> <tr><td>Left Bottom</td></tr> <tr><td>Right Bottom</td></tr> </table> OFF ON	Left Top	Right Top	Left Bottom	Right Bottom	<ul style="list-style-type: none"> Users can adjust Refresh Rate in any Mode. Default Refresh Rate Location is Left Bottom. Location is adjustable in OSD Menu. Press the Middle Button to confirm and apply your Refresh Rate Location. This monitor follows and works at the Operating System's preset Screen Refresh Rate.
Left Top						
Right Top						
Left Bottom						
Right Bottom						
Alarm Clock	Location <table border="1" style="display: inline-table; vertical-align: top;"> <tr><td>Left Top</td></tr> <tr><td>Right Top</td></tr> <tr><td>Left Bottom</td></tr> <tr><td>Right Bottom</td></tr> </table> OFF 15:00 00:01~99:59 30:00 45:00 60:00	Left Top	Right Top	Left Bottom	Right Bottom	<ul style="list-style-type: none"> Users can adjust Alarm Clock in any Mode. After setting the time, press the Middle Button to activate the timer. Default Alarm Clock Location is Left Top. Users can select their own location.
Left Top						
Right Top						
Left Bottom						
Right Bottom						
Screen Assistance	None 	<ul style="list-style-type: none"> Users can adjust Screen Assistance in any Mode. Screen Assistance default is None. 				
FreeSync	<input checked="" type="checkbox"/> (OFF) <input type="checkbox"/> (ON)	<ul style="list-style-type: none"> FreeSync prevents screen tearing. HDMI default is ON but grayed out (cannot be changed). DisplayPort default is ON and can be adjusted ON/OFF in any mode, any resolution, any input source and any screen refresh rate. When FreeSync is enabled, Anti Motion Blur will be grayed out. 				

► Professional

1st Level Menu	2nd Level Menu	Description
Pro Mode	User	Default mode. All items can be adjusted by users.
	Reader	All items can be adjusted, except for Brightness, Contrast and Eye Saver.
	Cinema	All items can be adjusted, except for Brightness, Contrast and Image Enhancement.
	Designer	All items can be adjusted, except for Black Tuner, Brightness and Contrast.
		<ul style="list-style-type: none"> ■ Use Up or Down Button to select and preview mode effects. ■ Press the Middle Button to confirm and apply your mode type.
Eye Saver	<input checked="" type="checkbox"/> (OFF)	<ul style="list-style-type: none"> ■ Eye Saver protects your eyes against blue light. When enabled, Eye Saver adjusts the screen color temperature to a more yellow glow. ■ Users can adjust Eye Saver in any Mode. ■ When Pro Mode is set to Reader, it is mandatory to enable Eye Saver.
	<input type="checkbox"/> (ON)	
HDCR	<input checked="" type="checkbox"/> (OFF)	<ul style="list-style-type: none"> ■ HDCR default is OFF. Users can adjust HDCR in any Mode. ■ HDCR enhances image quality by increasing the contrast of images. ■ When HDCR is set to ON, Brightness will be grayed out. ■ HDCR and Anti Motion Blur cannot be enabled simultaneously. ■ When HDCR is enabled, Anti Motion Blur cannot be enabled and Response Time cannot be set to Fastest.
	<input type="checkbox"/> (ON)	
Anti Motion Blur	<input checked="" type="checkbox"/> (OFF)	<ul style="list-style-type: none"> ■ Brightness cannot be adjusted when Anti Motion Blur is set to ON. ■ When Response Time is set to Fastest with at least 75Hz Screen Refresh Rate, Anti Motion Blur will be automatically enabled. ■ When Screen Refresh Rate is lower than 75HZ, Anti Motion Blur cannot be enabled and Response Time cannot be set to Fastest. ■ When Anti Motion Blur is enabled, HDCR cannot be enabled and will be grayed out. ■ This function is recommended for cinema, FPS and Racing games. ■ When FreeSync is enabled, Anti Motion Blur will be grayed out.
	<input type="checkbox"/> (ON)	
Image Enhancement	OFF	<ul style="list-style-type: none"> ■ Image Enhancement enhances image edges to improve their acutance. ■ Users can adjust Image Enhancement in any Mode.
	Weak	
	Medium	
	Strongest	

➤ Image

1st Level Menu	2nd/3rd Level Menu	Description
Brightness	0-100	<ul style="list-style-type: none"> ■ Brightness default is 80. ■ Users can adjust Brightness in User, RTS, RPG and Reader mode. ■ Brightness will be grayed out when Anti Motion Blur and HDCR are enabled.
Contrast	0-100	<ul style="list-style-type: none"> ■ Contrast default of MAG271CQR is 50. ■ Users can adjust Contrast in any Mode.
Sharpness	0-5	<ul style="list-style-type: none"> ■ Sharpness default is 0. Users can adjust Sharpness in any Mode. ■ Sharpness improves clarity and details of images.
Color Temperature	Cool	<ul style="list-style-type: none"> ■ Color Temperature default is Normal. ■ Use Up or Down Button to select and preview mode effects. ■ Press the Middle Button to confirm and apply your mode type. ■ Users can adjust Color Temperature in Customization mode. ■ Customization mode default is 50/50/50.
	Normal	
	Warm	
	Customization	
Screen Size	19"	<ul style="list-style-type: none"> ■ Screen Size default is 16:9. ■ Users can adjust Screen Size in any mode, any resolution and any screen refresh rate.
	24"	
	4:3	
	16:9	

2-8

➤ Input Source

1st Level Menu	Description
HDMI1	Users can adjust Input Source in any Mode.
HDMI2	
DP	

➤ PIP/PBP

1st Level Menu	2nd/3rd Level Menu		Description
OFF			<ul style="list-style-type: none"> ■ PIP (Picture in Picture) allows users to simultaneously display multiple video sources on one screen. One program is displayed on the full screen at the same time as one or more other programs are displayed in inset windows. ■ PBP (Picture by Picture) is a similar feature that displays two input sources side-by-side on the screen. ■ PIP/PBP default is OFF. ■ Display Switch allows users to switch between primary and secondary input sources. ■ Audio Switch allows users to switch between primary and secondary digital audio sources.
PIP	Source	HDMI1	
		HDMI2	
		DP	
	PIP Size	Small	
		Medium	
		Large	
	Location	Left Top	
		Right Top	
		Left Bottom	
		Right Bottom	
Display Switch			
Audio Switch			
PBP	Source	HDMI1	
		HDMI2	
		DP	
	Display Switch		
	Audio Switch		

➤ Navi Key



1st Level Menu	2nd Level Menu	Description
Up	OFF	<ul style="list-style-type: none"> ■ Up Button default is Game Mode. ■ Down Button default is Screen Assistance. ■ Left Button default is Alarm Clock. ■ Right Button default is Input Source. ■ All Navi Key items can be adjusted via OSD Menu.
	Brightness	
	Game Mode	
	Screen Assistance	
	Alarm Clock	
	Input Source	
	PIP/PBP Mode	
	Refresh Rate	
Down	OFF	
	Brightness	
	Game Mode	
	Screen Assistance	
	Alarm Clock	
	Input Source	
	PIP/PBP Mode	
	Refresh Rate	
Left	OFF	
	Brightness	
	Game Mode	
	Screen Assistance	
	Alarm Clock	
	Input Source	
	PIP/PBP Mode	
	Refresh Rate	
Right	OFF	
	Brightness	
	Game Mode	
	Screen Assistance	
	Alarm Clock	
	Input Source	
	PIP/PBP Mode	
	Refresh Rate	

➤ Setting

1st Level Menu	2nd Level Menu	Description
Language	繁體中文	<ul style="list-style-type: none"> ■ Language factory default is English. ■ Users have to press the Middle Button to confirm and apply the Language setting. ■ Language is an independent setting. Users' own language setting will override the factory default. When users set Reset to Yes, Language will not be changed.
	English	
	Français	
	Deutsch	
	Italiano	
	Español	
	한국어	
	日本語	
	Русский	
	Português	
	简体中文	
	ไทย	
	Bahasa Indonesia	
	हिन्दी	
	Türkçe	
	فارسی	
	Tiếng Việt	
תירבע		
বাংলা		
عَرَبِيّ		
(More languages coming soon)		
Transparency	0~5	Transparency default is 0. Users can adjust Transparency in any Mode.
OSD Time Out	5-30s	OSD Time Out default is 20s. Users can adjust OSD Time Out in any Mode.
RGB LED	OFF	RGB LED default is On. Users can adjust RGB LED to On or Off.
	ON	
Reset	YES	Users can Reset and restore settings to original OSD Default in any Mode.
	NO	

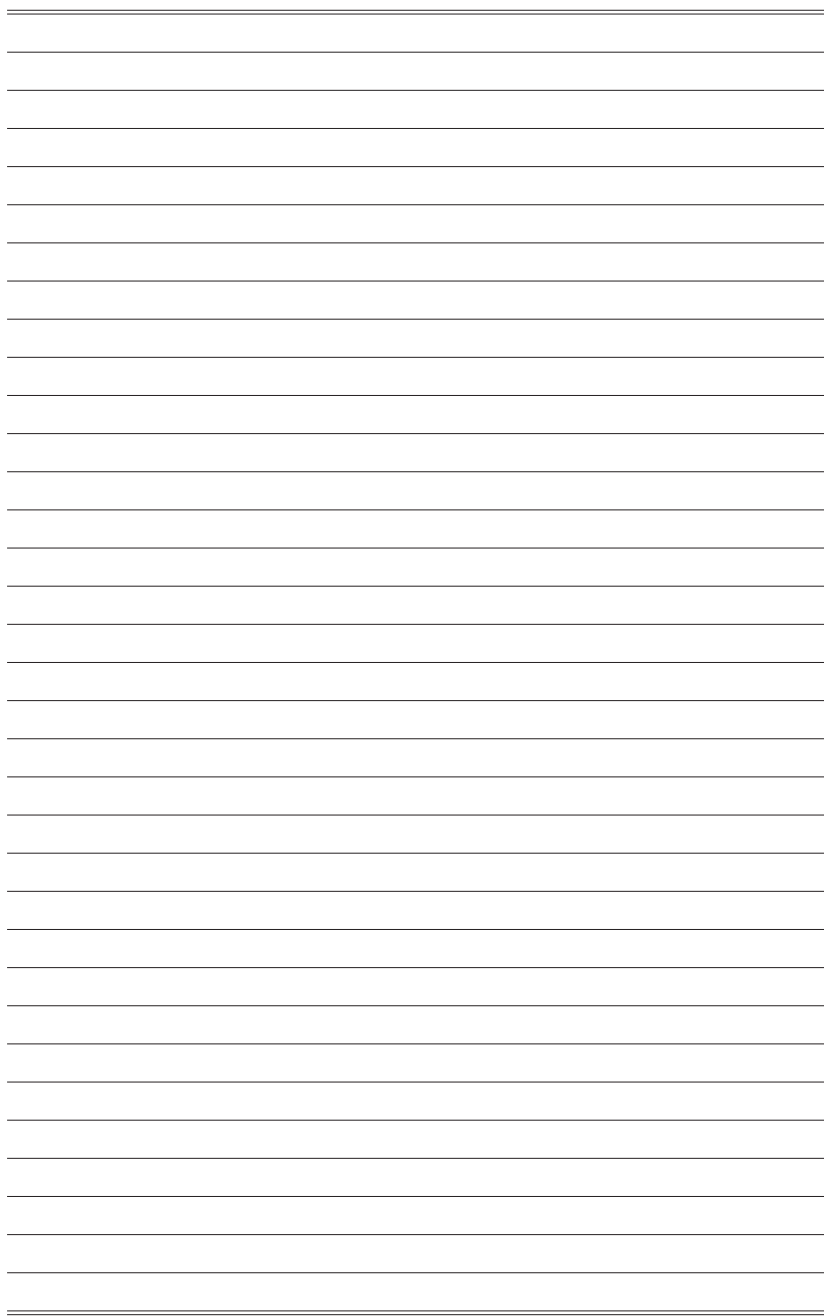



Appendix

IMPORTANT

All information is subject to change without prior notice.

Specifications

Size		27 inch
Curvature		1800R
Panel Type		VA
Resolution		2560 x 1440@144Hz
Aspect Ratio		16:9
Brightness (nits)		400 (typical)
Contrast Ratio		3000:1
Refresh Rate		144Hz
Response Time		1ms (MPRT)
Input Interface		HDMI x2, DP x1
I/O		<ul style="list-style-type: none"> ■ HDMI x2 ■ Display Port x1 ■ USB 2.0 Type A x2 (Rear side) ■ USB 2.0 Type B x1 (Rear side for PC to Monitor) ■ Digital Audio Output x1
View Angles		178°(H) , 178°(V)
DCI-P3/ sRGB		90%/ 115%
Surface Treatment		Anti-glare
Display Colors		16.7M
Power Type		Internal Power
Power Consumption (Typical)		57W
Power Input		100~240Vac, 50~60Hz, 1.5A
Adjustment (Tilt)		-5° ~ 20°
Adjustment (Height)		0 ~ 130mm
Kensington Lock		Yes
VESA Mounting		<ul style="list-style-type: none"> ■ Plate Type: 100 x 100 mm ■ Screw Type: M4x10 mm <ul style="list-style-type: none"> ▶ Thread Diameter: 4 mm ▶ Thread Pitch: 0.7 mm ▶ Thread Length: 10 mm
Dimension (W x H x D)		612.0 x 560.0 x 266.5 mm (max)
Net Weight		6.2 kg (net), 9.1 kg (gross)
Environment	Operating	Temperature: 0°C to 40°C Humidity: 20% to 90%, non-condensing Altitude: 0 ~ 5000m
	Storage	Temperature: -20°C to 60°C Humidity: 10% to 90%, non-condensing
LED Control		Mystic light LED support (RGB LED)

Preset Display Modes

Standard	Resolution	HDMI / DP
VGA	640x480 @60Hz	V
	640x480 @67Hz	V
	640x480 @72Hz	V
	640x480 @75Hz	V
Dos-Mode	720x400@70Hz	V
SVGA	800x600 @56Hz	V
	800x600 @60Hz	V
	800x600 @72Hz	V
	800x600 @75Hz	V
XGA	1024x768 @60Hz	V
	1024x768 @70Hz	V
	1024x768 @75Hz	V
XGA+	1152x864 @75Hz	V
SXGA	1280x1024 @60Hz	V
	1280x1024 @75Hz	V
WXGA	1280x720 @60Hz	V
VESA	1280x960 @60Hz	V
SDTV	640x480P @60Hz	V
	720x480P @60Hz	V
	720x576P @50Hz	V
	1440x480P @60HZ	V
	1440x576P @50HZ	V
HDTV	1280x720P @50Hz	V
	1280x720P @60Hz	V
	1920x1080P @50Hz	V
	1920x1080P @60HZ	V
	1920x1080I @50HZ	V
	1920x1080I @60HZ	V
WXGA+	1440x900 @60Hz	V
WSXGA+	1680x1050 @60Hz	V
Full HD	1920x1080 @60Hz	V
	1920x1080 @120Hz	V
	1920x1080 @144Hz	V
WQHD	2560x1440 @60Hz	V
	2560x1440 @85Hz	V
	2560x1440 @120Hz	V
	2560x1440 @144Hz	V

Troubleshooting

The power LED is off.

- Press the monitor power button again.
- Check if the monitor power cable is properly connected.

No image.

- Check if the computer graphics card is properly installed.
- Check if the computer and monitor are connected to electrical outlets and are turned on.
- Check if the monitor signal cable is properly connected.
- The computer may be in Standby mode. Press any key to activate the monitor.

The screen image is not properly sized or centered.

Refer to Preset Display Modes to set the computer to a setting suitable for the monitor to display.

No Plug & Play.

- Check if the monitor power cable is properly connected.
- Check if the monitor signal cable is properly connected.
- Check if the computer and graphics card are Plug & Play compatible.

The icons, font or screen are fuzzy, blurry or have color problems.

- Avoid using any video extension cables.
- Adjust brightness and contrast.
- Adjust RGB color or tune color temperature.
- Check if the monitor signal cable is properly connected.
- Check for bent pins on the signal cable connector.

The monitor starts flickering or shows waves.

- Change the refresh rate to match the capabilities of your monitor.
- Update your graphics card drivers.
- Keep the monitor away from electrical devices that may cause electromagnetic interference (EMI).