



THE DISPLAY CHOICE
OF PROFESSIONALS™

SC-19E, SC-22E, SC-24E & SC-27E LED-Backlit Display

displays.agneovo.com

User Manual

TABLE OF CONTENTS

SAFETY INFORMATION

Federal Communications Commission (FCC) Notice (U.S. Only).....	1
WEEE.....	2

PRECAUTIONS

Notice	3
Cautions When Setting Up	3
Cautions When Using.....	4
Cleaning and Maintenance.....	4
Notice for the LCD Display	5

CHAPTER 1: PRODUCT DESCRIPTION

1.1 Package Contents	6
1.2 Installation	7
1.2.1 Installing the Stand.....	7
1.2.2 Adjusting the Viewing Angle	8
1.2.3 Wall Mounting.....	8
1.3 Control Buttons.....	10
1.4 Overview	11
1.4.1 Front View	11
1.4.2 Rear View.....	12

CHAPTER 2: MAKING CONNECTIONS

2.1 Connecting the AC Power	13
2.2 Connecting Input Source Signals	14
2.2.1 Connecting an Audio Device	15
2.3 Connecting a Video Device	16
2.4 Connecting a USB Storage Device (for firmware upgrade).....	16
2.5 Connecting an External Audio Device	17

CHAPTER 3: USING THE LCD DISPLAY

3.1 Turning on the Power	18
3.2 Using FREEZE Function	18
3.3 Adjusting the Volume.....	19
3.4 Muting Audio.....	20
3.5 Locking the Control Buttons	20

CHAPTER 4: ON SCREEN DISPLAY MENU

4.1 Using the OSD Menu	22
4.2 OSD Menu Tree	23

CHAPTER 5: ADJUSTING THE LCD DISPLAY

5.1 Image Setting	26
5.2 Audio Setting	30
5.3 System	31
5.4 Input Select	33

TABLE OF CONTENTS

CHAPTER 6: APPENDIX

6.1 Warning Messages.....	34
6.2 Troubleshooting.....	35
6.3 Transporting the LCD Display	36

CHAPTER 7: SPECIFICATIONS

7.1 Display Specifications	38
7.2 Display Dimensions.....	39

SAFETY INFORMATION

Federal Communications Commission (FCC) Notice (U.S. Only)



This equipment has been tested and found to comply with the limits for a Class B digital device, pursuant to part 15 of the FCC Rules. These limits are designed to provide reasonable protection against harmful interference in a residential installation. This equipment generates, uses and can radiate radio frequency energy and, if not installed and used in accordance with the instructions, may cause harmful interference to radio communications. However, there is no guarantee that interference will not occur in a particular installation. If this equipment does cause harmful interference to radio or television reception, which can be determined by turning the equipment off and on, the user is encouraged to try to correct the interference by one or more of the following measures:

- Reorient or relocate the receiving antenna.
- Increase the separation between the equipment and receiver.
- Connect the equipment into an outlet on a circuit different from that to which the receiver is connected.
- Consult the dealer or an experienced radio/TV technician for help.



Changes or modifications not expressly approved by the party responsible for compliance could void the user's authority to operate the equipment.

Use only an RF shielded cable that was supplied with the display when connecting this display to a computer device.

To prevent damage which may result in fire or shock hazard, do not expose this appliance to rain or excessive moisture.

THIS CLASS B DIGITAL APPARATUS MEETS ALL REQUIREMENTS OF THE CANADIAN INTERFERENCE-CAUSING EQUIPMENT REGULATIONS.



This device complies with Part 15 of the FCC Rules. Operation is subject to the following two conditions: (1) this device may not cause harmful interference, and (2) this device must accept any interference received, including interference that may cause undesired operation.

SAFETY INFORMATION

WEEE

Information for users applicable in European Union countries.

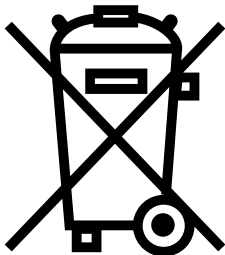

The symbol on the product or its packaging signifies that this product has to be disposed separately from ordinary household wastes at its end of life. Please kindly be aware that this is your responsibility to dispose electronic equipment at recycling centers so as to help conserve natural resources. Each country in the European Union should have its collection centers for electrical and electronic equipment recycling. For information about your recycling drop off area, please contact your local related electrical and electronic equipment waste management authority or the retailer where you bought the product.

PRECAUTIONS

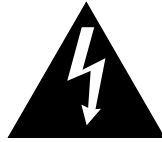

CAUTION
RISK OF ELECTRIC SHOCK
DO NOT OPEN



Symbols used in this manual

	This icon indicates the existence of a potential hazard that could result in personal injury or damage to the product.
	This icon indicates important operating and servicing information.

Notice

- Read this User Manual carefully before using the LCD display and keep it for future reference.
- The product specifications and other information provided in this User Manual are for reference only. All information is subject to change without notice. Updated content can be downloaded from our web site at displays.agneovo.com.
- To register online, go to displays.agneovo.com.
- To protect your rights as a consumer, do not remove any stickers from the LCD display. Doing so may affect the determination of the warranty period.

Cautions When Setting Up



Do not place the LCD display near heat sources, such as a heater, exhaust vent, or in direct sunlight.



Do not cover or block the ventilation holes in the housing.



Place the LCD display on a stable area. Do not place the LCD display where it may be subject to vibration or shock.



Place the LCD display in a well-ventilated area.



Do not place the LCD display outdoors.



Do not place the LCD display in a dusty or humid environment.



Do not spill liquid or insert sharp objects into the LCD display through the ventilation holes. Doing so may cause accidental fire, electric shock or damage the LCD display.

PRECAUTIONS

Cautions When Using



Use only the power cord supplied with the LCD display.



The power outlet should be installed near the LCD display and be easily accessible.



If an extension cord is used with the LCD display, ensure that the total current consumption plugged into the power outlet does not exceed the ampere rating.



Do not allow anything to rest on the power cord. Do not place the LCD display where the power cord may be stepped on.



If the LCD display will not be used for an indefinite period of time, unplug the power cord from the power outlet.



To disconnect the power cord, grasp and pull by the plug head. Do not tug on the cord; doing so may cause fire or electric shock.



Do not unplug or touch the power cord with wet hands.

Cleaning and Maintenance



Use a soft cloth lightly moistened with a mild detergent solution to clean the screen surface and the housing.



Do not rub or tap the surface of the screen with sharp or abrasive items such as a pen or screwdriver. This may result in scratching the surface of the screen.



Do not attempt to service the LCD display yourself, refer to qualified service personnel. Opening or removing the covers may expose you to dangerous voltage or other risks.



Warning:



Unplug the power cord from the power outlet and refer to qualified service personnel under the following conditions:

- ◆ When the power cord is damaged.
- ◆ If the LCD display has been dropped or the housing has been damaged.
- ◆ If the LCD display emits smoke or a distinct odor.



Warning:



Ceiling mount or mount on any other horizontal surface overhead are not advisable.

Installation in contravention of the instructions may result in undesirable consequences, particularly hurting people and damaging property. Users who have already mounted the display on the ceiling or any other horizontal surface overhead are strongly advised to contact AG Neovo for consultations and solutions to help ensure a most pleasurable and fulfilling display experience.

PRECAUTIONS

Notice for the LCD Display

In order to maintain the stable luminous performance, it is recommended to use low brightness setting.

Due to the lifespan of the lamp, it is normal that the brightness quality of the LCD display may decrease with time.

When static images are displayed for long periods of time, the image may cause an imprint on the LCD display. This is called image retention or burn-in.

To prevent image retention, do any of the following:

- Set the LCD display to turn off after a few minutes of being idle.
- Use a screen saver that has moving graphics or a blank white image.
- Execute the Anti-Burn-in™ function of the LCD display. Refer to page 31.
- Switch desktop backgrounds regularly.
- Adjust the LCD display to low brightness settings.
- Turn off the LCD display when the system is not in use.

Things to do when the LCD display shows image retention:

- Turn off the LCD display for extended periods of time. It can be several hours or several days.
 - Use a screen saver and run it for extended periods of time.
 - Use a black and white image and run it for extended periods of time.
-

When the LCD display is moved from one room to another or there is a sudden change from low to high ambient temperature, dew condensation may form on or inside the screen surface. When this happens, do not turn on the LCD display until the dew disappears.

Due to humid weather conditions, it is normal for mist to form inside the screen surface of the LCD display. The mist will disappear after a few days or as soon as the weather stabilizes.

There are millions of micro transistors inside the LCD display. It is normal for a few transistors to be damaged and to produce spots. This is acceptable and is not considered a failure.

CHAPTER 1: PRODUCT DESCRIPTION

1.1 Package Contents

When unpacking, check if the following items are included in the package. If any of them is missing or damaged, contact your dealer.

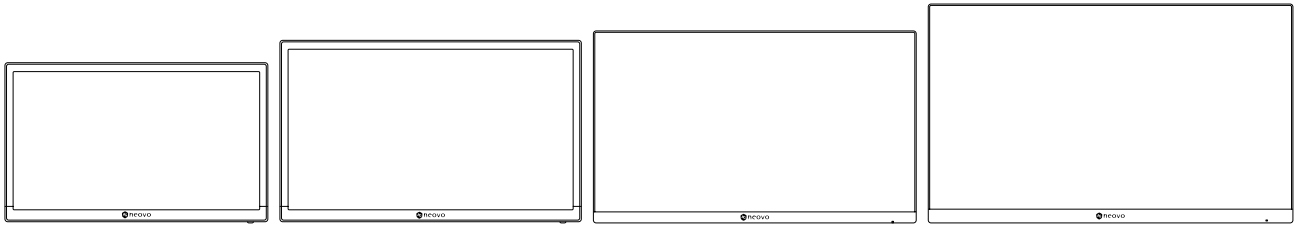

SC-19E

SC-22E

SC-24E

SC-27E

LCD display

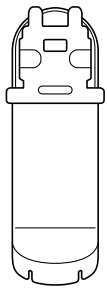

Stand for SC-19E/22E/24E

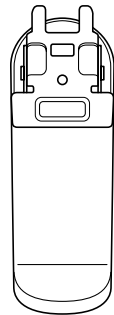

Stand for SC-27E

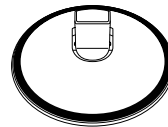

Base for SC-19E/22E/24E

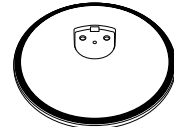

Base for SC-27E

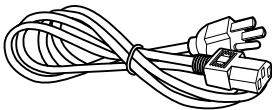

Power Cord

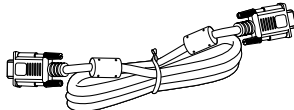

D-Sub Cable

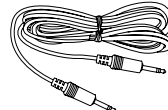

Audio Cable



Warranty Card

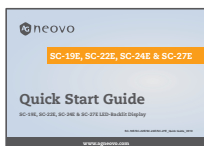

Quick Start Guide

Note:

- Use only the supplied power cord.
- The above pictures are for reference only. Actual items may vary upon shipment.

PRODUCT DESCRIPTION

1.2 Installation

1.2.1 Installing the Stand

1. Place the LCD display with the screen side down on a cushioned surface.

2. Attach the base to the stand.

-**SC-19E/22E/24E models:** Press firmly on the base to secure the latches on the base into the slots on the stand.

-**SC-27E model:** Attach the base to the stand and fix with the screw to join them tightly.

3. Attach the stand to the display.

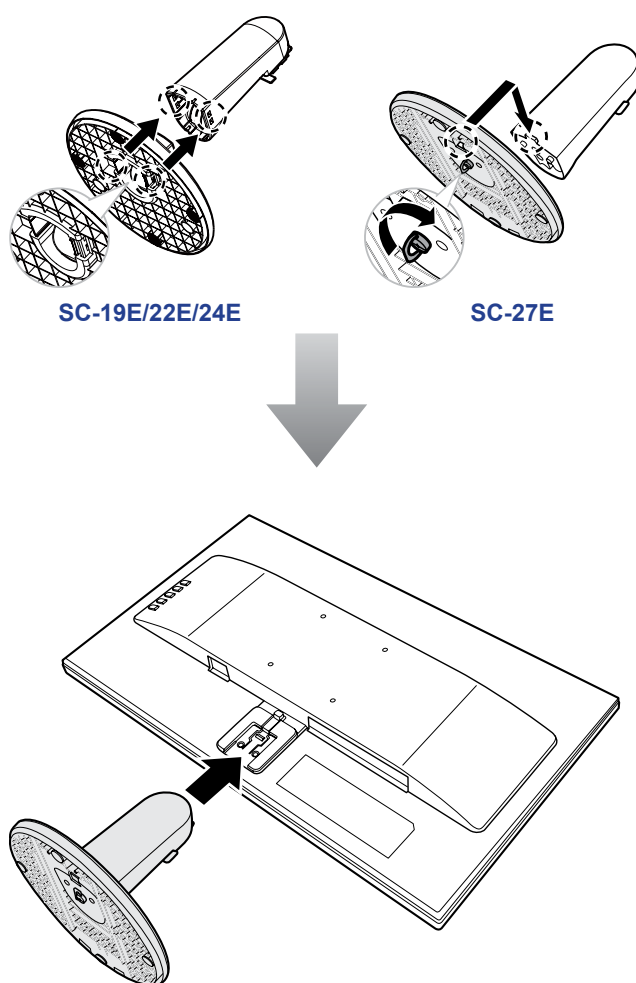

PRODUCT DESCRIPTION

1.2.2 Adjusting the Viewing Angle

For optimal viewing, it is recommended to look at the full face of the screen, then adjust the screen of the LCD display angle according to your preference.

Hold the stand so that the screen does not topple when you make the adjustment.

You are able to adjust the screen angle as illustrated below:

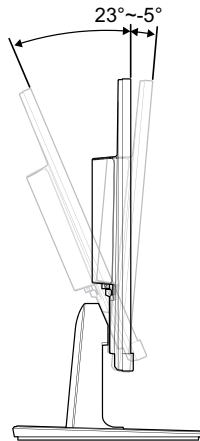

1.2.3 Wall Mounting

To wall mount the LCD display, do the following steps:

1. Remove the stand.

Please refer to page 36.

PRODUCT DESCRIPTION

2. Wall mount the LCD display.

Screw the mounting bracket to the VESA holes at the rear of the LCD display.

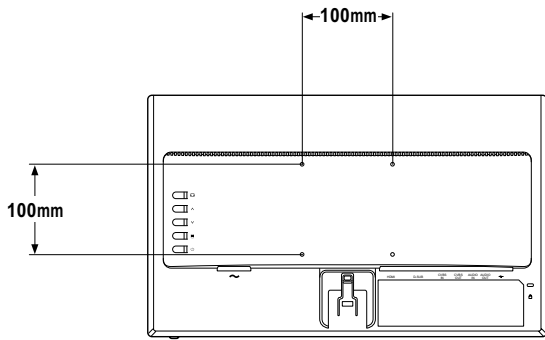

SC-19E

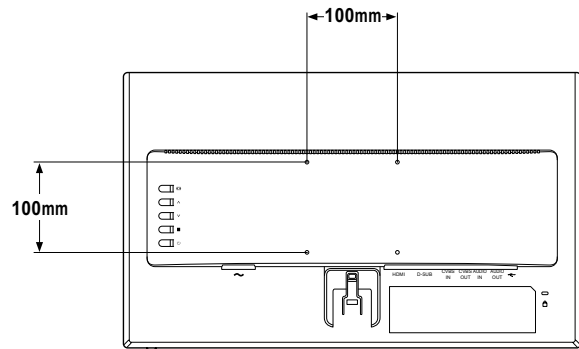

SC-22E

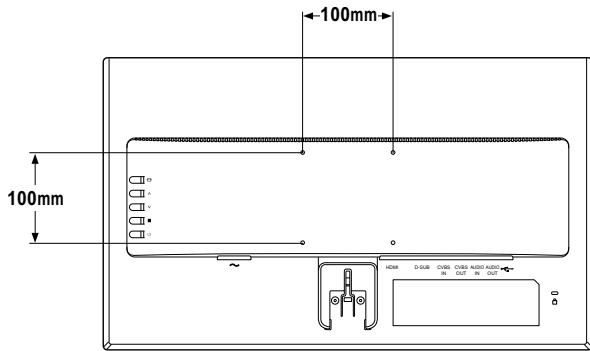

SC-24E

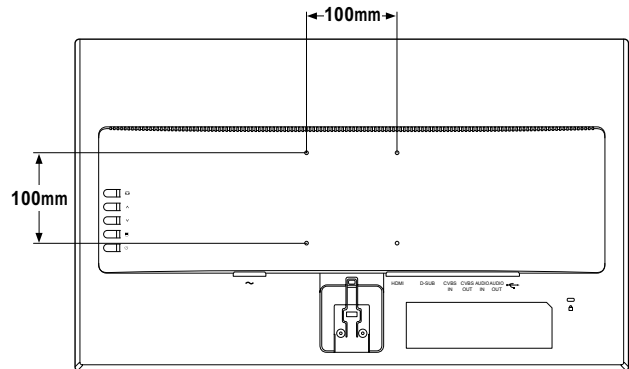

SC-27E

Note: Take measures to prevent the LCD display from falling down and lessen possible injury and damage to the display in case of earthquakes or other disasters.



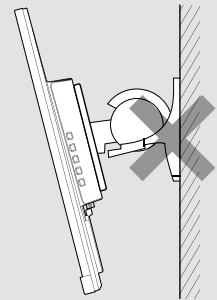



- Use only the 100 x 100 mm wall mount kit recommended by AG Neovo. All AG Neovo wall mount kits comply with VESA standard.
- Secure the LCD display on a solid wall strong enough to bear its weight.
- It is suggested to wall mount the LCD display without tilting it facing downward.

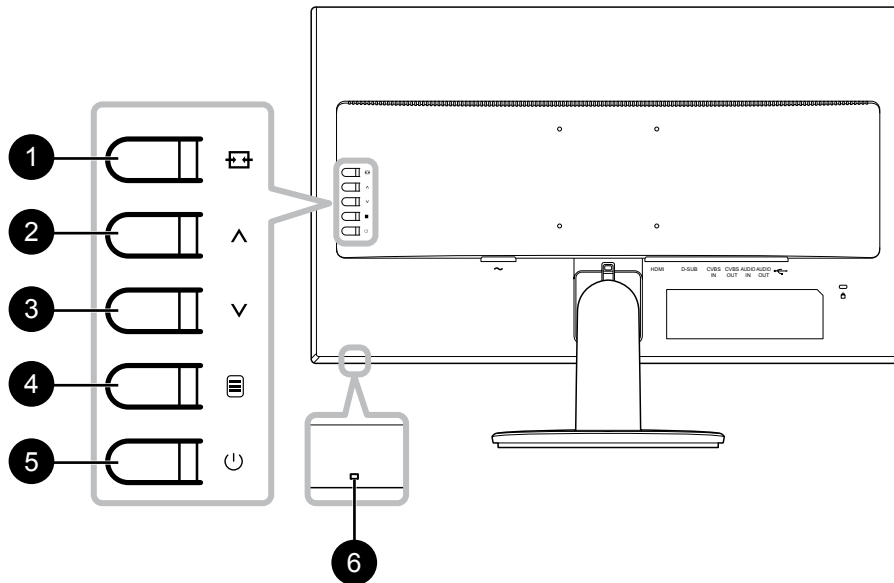

PRODUCT DESCRIPTION

1.3 Control Buttons



- 1** **[Source/Exit]** **Source/Exit**
 - Call out the **Source** quick menu. Press the  button repeatedly to switch the input source. Then press the  button to confirm.
 - Press and hold the  button to freeze/unfreeze the screen. Refer to page 18.
 - During OSD menu, close the OSD menu or exit a submenu.
 - During volume adjustment, close the quick menu.
- 2** **[Up]** **Up**
 - Call out the **Volume** quick menu. Then press the  button to adjust the volume level. Refer to page 19.
 - During OSD menu, scroll through the menu options, select an option, and adjust the settings.
- 3** **[Down]** **Down**
 - Call out the **Volume** quick menu. Then press the  button to adjust the volume level. Refer to page 19.
 - During OSD menu, scroll through the menu options, select an option, and adjust the settings.
- 4** **[Menu/Enter]** **Menu/Enter**
 - Call out the OSD menu when OSD menu is off.
 - During OSD menu, confirm the selection or enter a submenu.
 - Press and hold the  button to mute/unmute audio. Refer to page 20.
- 5** **[Power]** **Power**

Turn the LCD display on. Press it again to turn the LCD display off. Refer to page 18.
- 6** **Power indicator**

Indicate the operating status of the LCD display:

 - Lights blue when the LCD display is turned on.
 - Lights amber when the LCD display is in standby mode.
 - Lights off when the LCD display is turned off.

PRODUCT DESCRIPTION

1.4 Overview

1.4.1 Front View

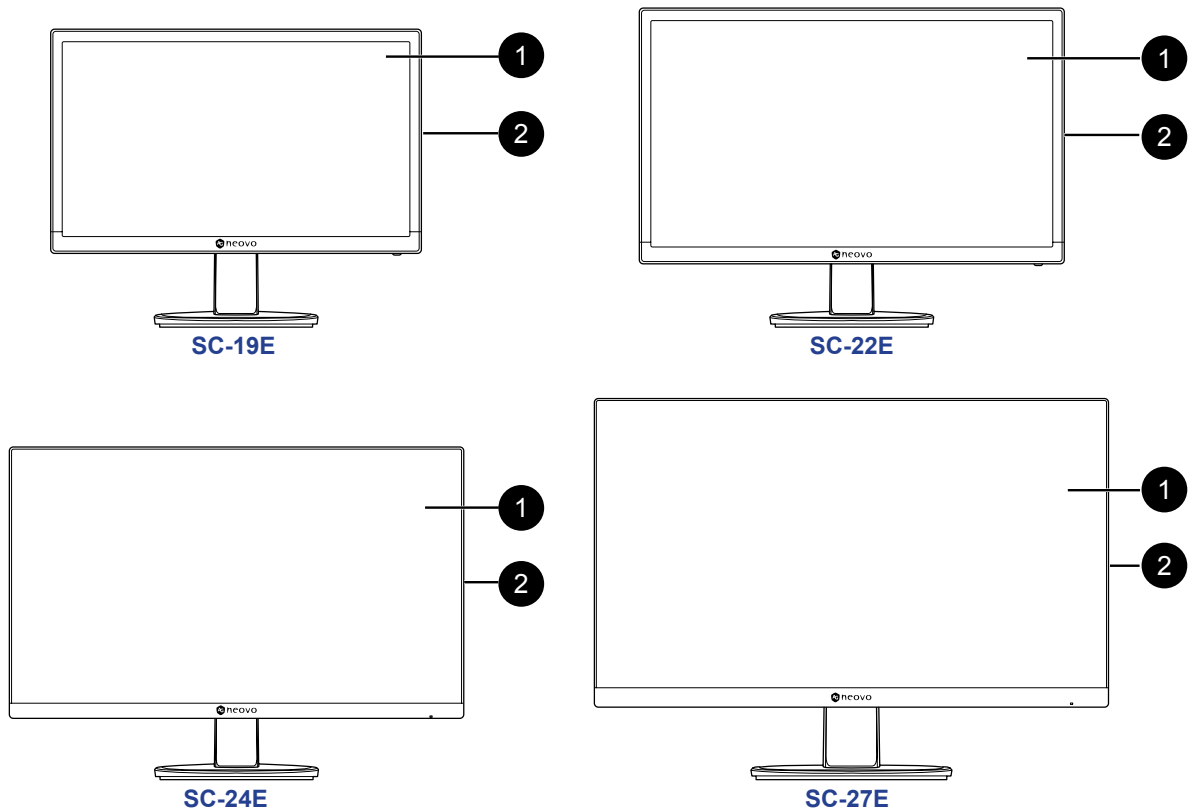

1 Display screen

2 Control buttons

Press the button to perform its function. For more information about each button, refer to page 10.

PRODUCT DESCRIPTION

1.4.2 Rear View

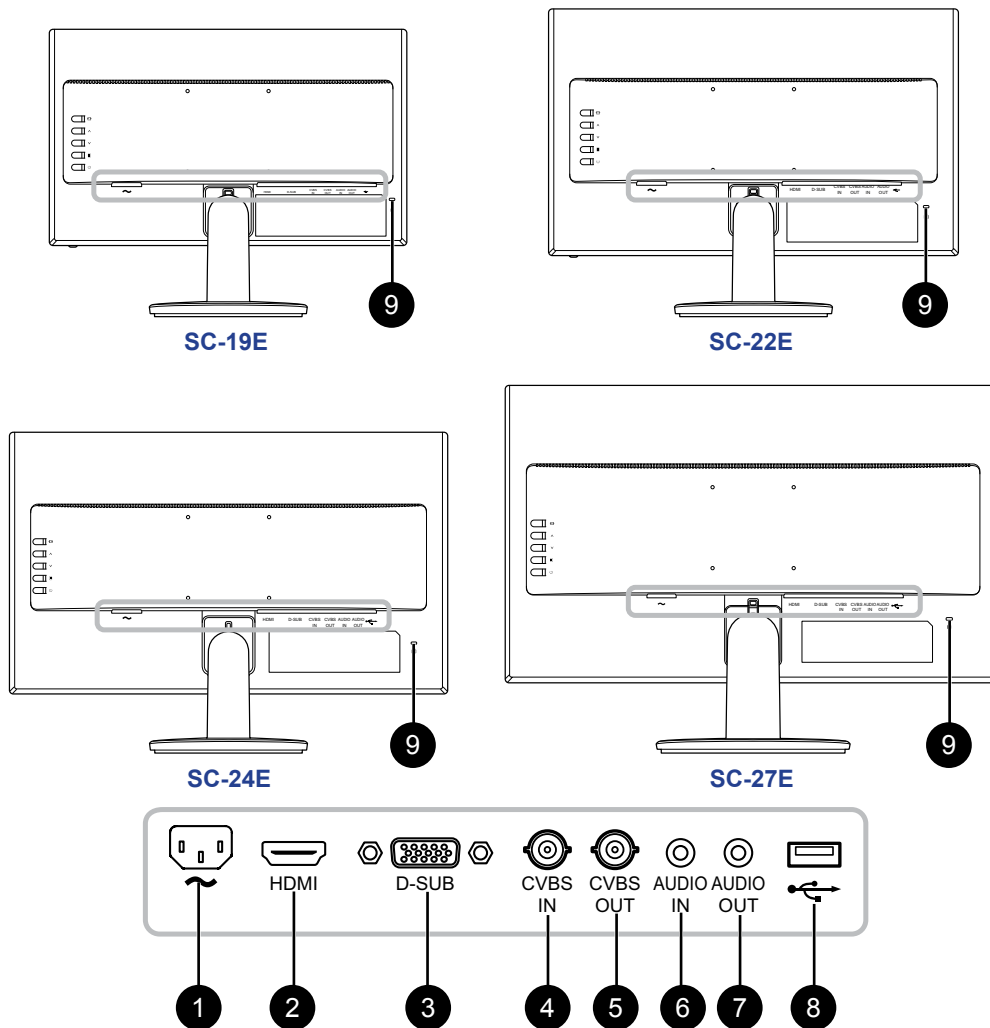

- 1 AC Power input**
Use to connect the power cord.
- 2 HDMI connector**
Use to connect an HDMI cable for digital input signal.
- 3 D-SUB (VGA) connector**
Use to connect a D-SUB (VGA) cable for analogue input signal.
- 4 CVBS IN connector**
Use to connect a composite cable for CVBS input signal from a video device.
- 5 CVBS OUT connector**
Use to connect a composite cable for CVBS output signal to a video device.
- 6 AUDIO IN connector**
Use to connect an audio cable for audio input.
- 7 AUDIO OUT connector**
Use to connect an audio cable for audio output signal to an external audio device.
- 8 USB connector**
Use to connect a flash disk for firmware upgrade.
- 9 Kensington security slot**
Used for security and theft prevention.

CHAPTER 2: MAKING CONNECTIONS



CAUTION:

Make sure that the LCD display is not connected to the power outlet before making any connections. Connecting cables while the power is ON may cause possible electric shock or personal injury.

2.1 Connecting the AC Power

1. Connect the power cord to the AC power input at the rear of the LCD display.
2. Connect the power cord plug to a power outlet or a power supply.

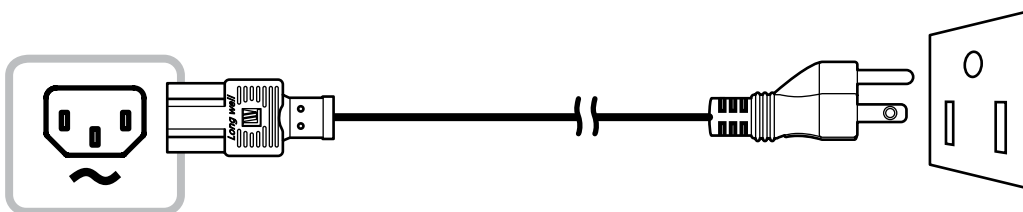

CAUTION:

When unplugging the power cord, hold the power cord by the plug head. Never pull by the cord.

MAKING CONNECTIONS

2.2 Connecting Input Source Signals

Input source signals can be connected with either of the following cables:

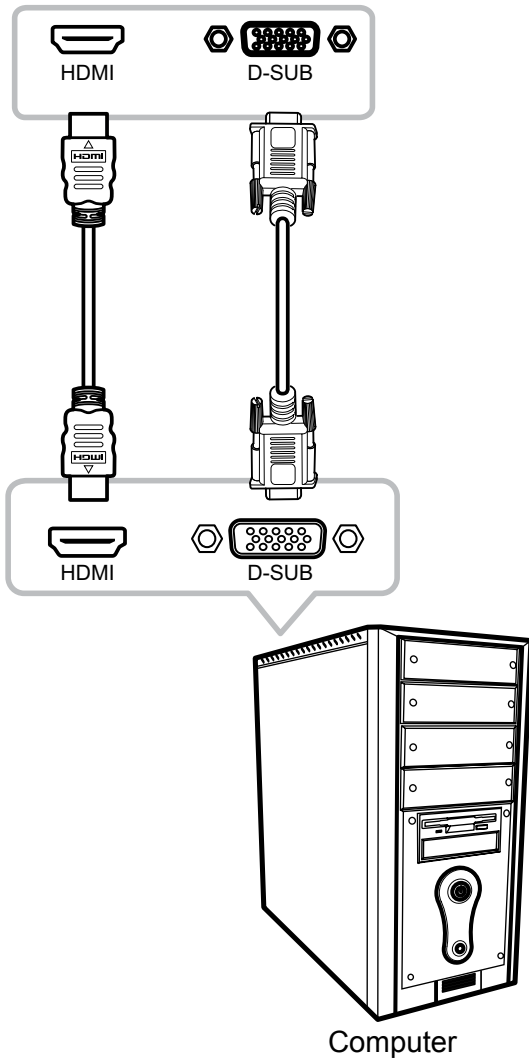

- **VGA**

Connect one end of a D-SUB (VGA) cable to the D-SUB (VGA) connector of the LCD display and the other end to the D-SUB (VGA) connector of the computer.

- **HDMI**

Connect one end of an HDMI cable to the HDMI connector of the LCD display and the other end to the HDMI connector of the computer.

MAKING CONNECTIONS

2.2.1 Connecting an Audio Device

1. Connect one end of an audio cable to the AUDIO IN connector at the rear of the LCD display.
2. Connect the other end of an audio cable to the AUDIO OUT connector of the computer.

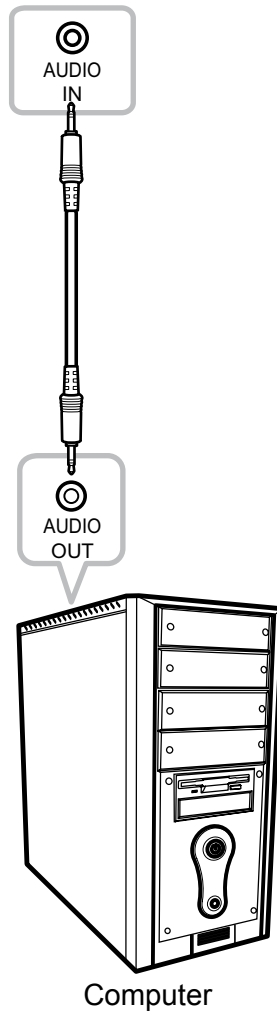

MAKING CONNECTIONS

2.3 Connecting a Video Device

1. Connect one end of a composite cable to the CVBS IN connector at the rear of the LCD display.
2. Connect the other end of a composite cable to the CVBS OUT connector of your device.

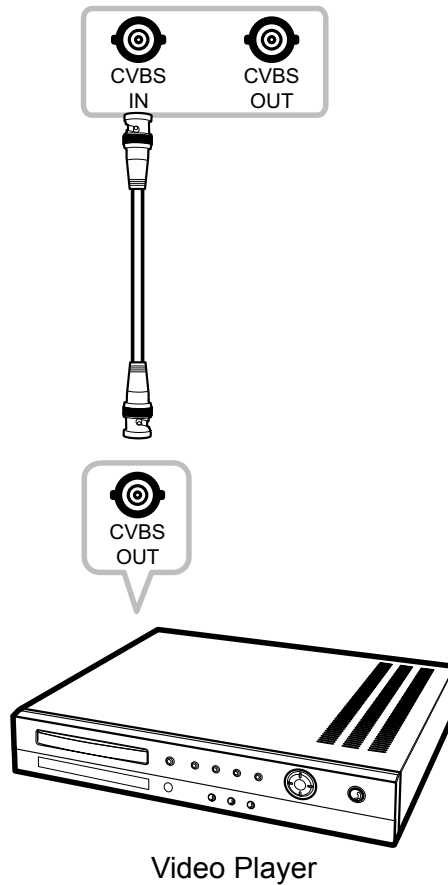

2.4 Connecting a USB Storage Device (for firmware upgrade)

Connect a USB storage device to the USB port of the LCD display for firmware upgrade.

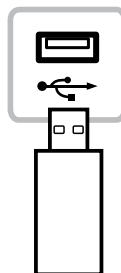

MAKING CONNECTIONS

2.5 Connecting an External Audio Device

1. Connect one end of an audio cable to the AUDIO OUT connector at the rear of the LCD display.
2. Connect the other end of an audio cable to the AUDIO IN connector of the external audio device.

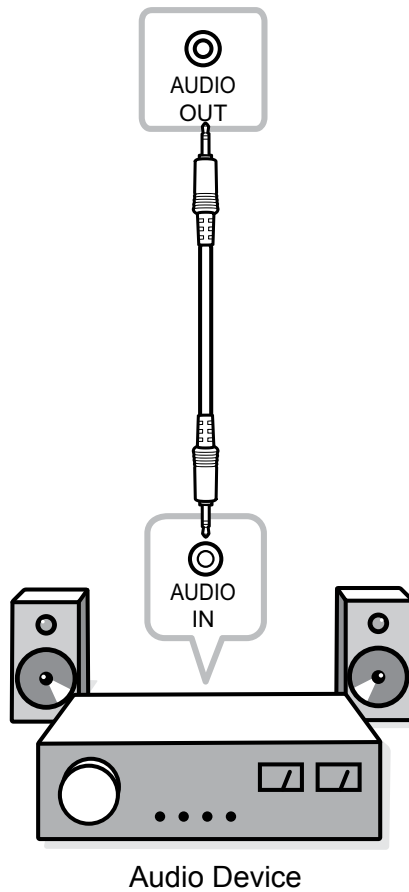

CHAPTER 3: USING THE LCD DISPLAY

3.1 Turning on the Power

1. Plug the power cord to a power outlet or power supply.
2. Press the  button to turn the LCD display on.

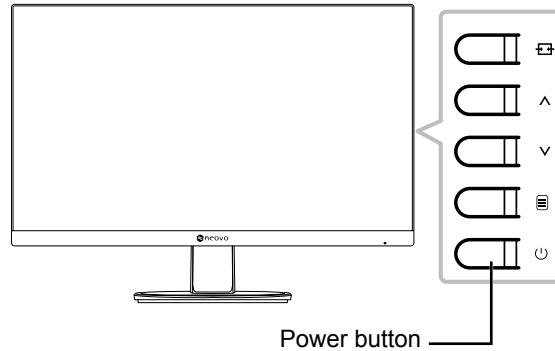

When the LCD display is turned on, press the  button to turn off the LCD display.

Note: The LCD display still consumes power as long as the power cord is connected to the power outlet. Disconnect the power cord to completely cut off power.

3.2 Using FREEZE Function

The FREEZE function allows you to freeze the screen image but still continues real-time playback until the image is unfreeze.

Press and hold the  button for 3 seconds to activate screen freeze, the screen freeze message is displayed on the screen.

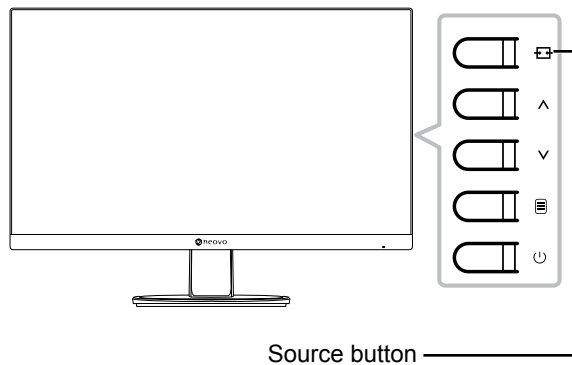

SCREEN FREEZE : ON

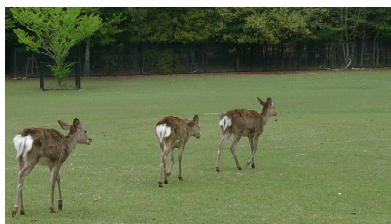

USING THE LCD DISPLAY

Press and hold the  button for 3 seconds again to deactivate screen freeze the screen freeze message is displayed on the screen.

SCREEN FREEZE : OFF

The screen image displays the elapsed real-time playback image when screen freeze is deactivated.



3.3 Adjusting the Volume

1. Press the \wedge or \vee button to call out the *Volume* quick menu.

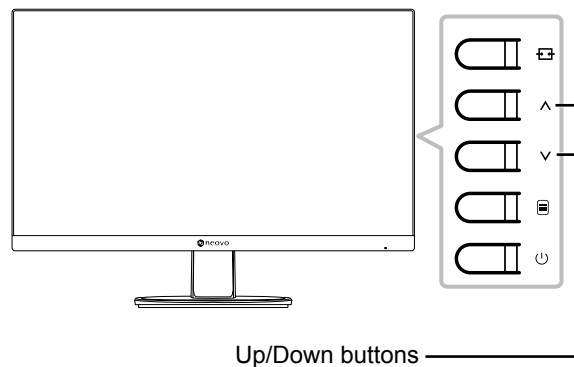

51

2. Press the \wedge or \vee button to adjust the volume.

Note: During volume or menu setting adjustment, press and hold the $\wedge\vee$ button to change the values continuously.

USING THE LCD DISPLAY

3.4 Muting Audio

Press and hold the  button for 3 seconds to mute audio, the audio mute message is displayed on the screen.

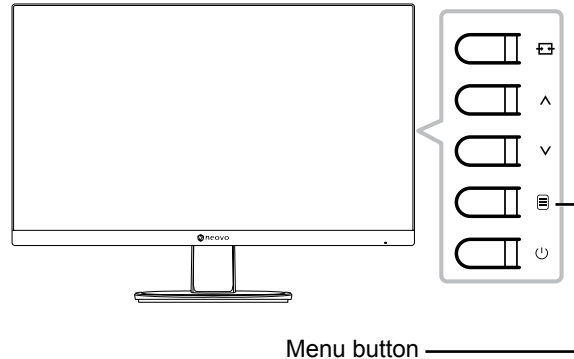

Press and hold the  button for 3 seconds again to unmute.

Note: You can also disable the mute function by pressing the **^** and **v** buttons simultaneously.



3.5 Locking the Control Buttons

There are two options to lock the control buttons: lock all the buttons or lock all but **Power** button.

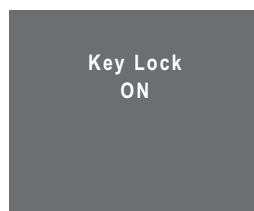
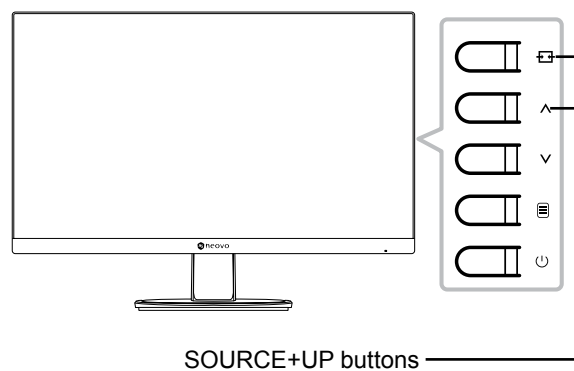

- To lock all the control buttons, press and hold the  + **^** buttons for 3 seconds, the key lock message is displayed on the screen.



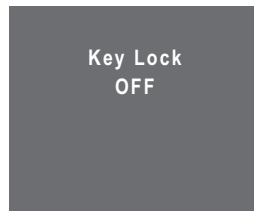

USING THE LCD DISPLAY

To unlock the control buttons, press and hold the  +  buttons for 3 seconds again, the key unlock message is displayed on the screen.

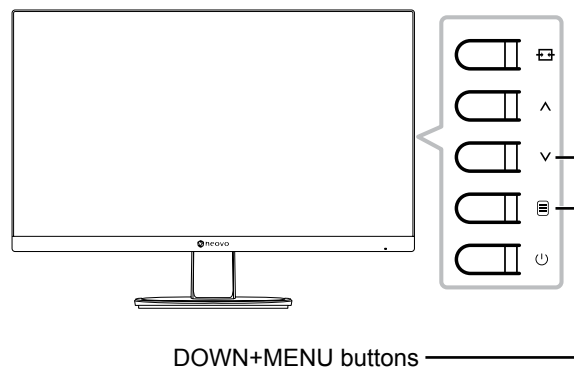

- To lock all the control buttons except for the **Power** button, press and hold the  +  buttons for 3 seconds, the key lock message is displayed on the screen.



To unlock the control buttons, press and hold the  +  buttons for 3 seconds again, the key unlock message is displayed on the screen.

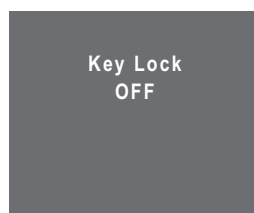

CHAPTER 4: ON SCREEN DISPLAY MENU

4.1 Using the OSD Menu

1. Press the  button to call out the OSD window.

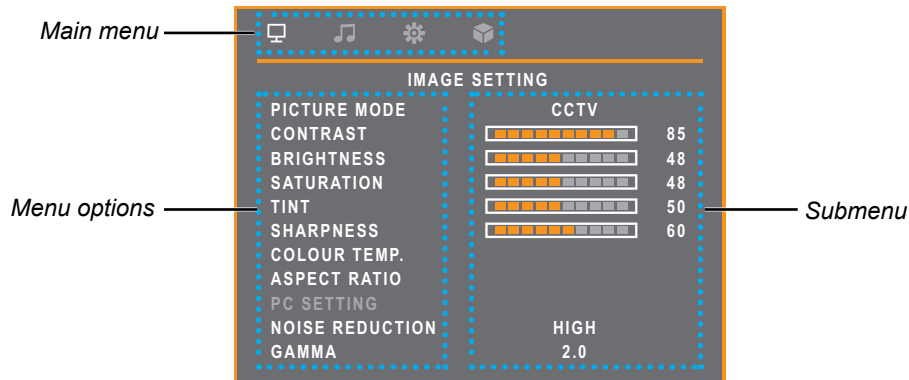

2. Press the \wedge or \vee button to select a menu and press the  button to enter the selected menu.

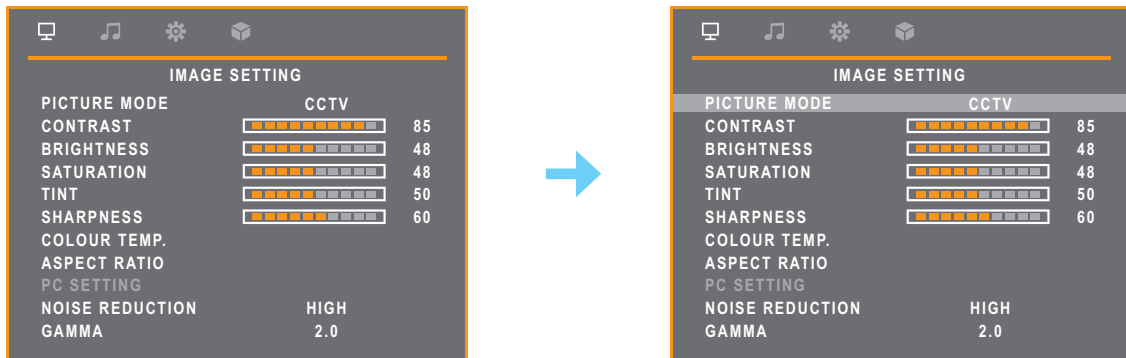

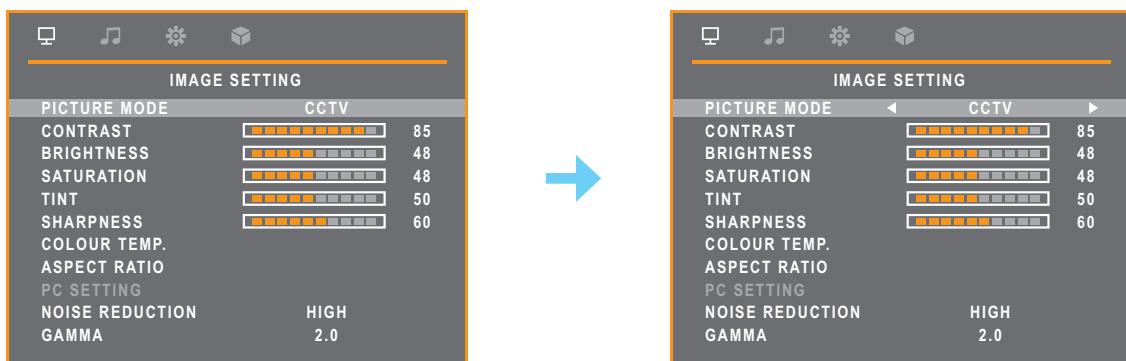

The selected menu option is highlighted in gray.

3. Press the \wedge or \vee button to select an option and press the  button to enter its submenu.



The menu option then appears between the two arrows ($\leftarrow\triangleright$).

4. Press the \wedge or \vee button to adjust the settings.
5. To exit the submenu, press the  button.
6. To close the OSD window, press the  button repeatedly.

Note: When settings are modified, all changes are saved when the user does the following:



- Proceeds to another menu
- Exits the OSD menu
- Waits for the OSD menu to disappear

ON SCREEN DISPLAY MENU

4.2 OSD Menu Tree

Main Menu	Submenu	Reference
Image Settings ()	Picture Mode	Standard
		CCTV
		Video
	Contrast	
	Brightness	
	Saturation	
	Tint	
	Sharpness	
	Colour Temp.	Cool
		Neutral
		Warm
		User
	Aspect Ratio (Full, Native, Real, Zoom)	H. Zoom
		V. Zoom
		Overscan
	PC Setting	Auto adjust
		H. Position
		V. Position
		Phase
		Clock
	Noise Reduction	Off
		Low
		Mid
		High
	Gamma	1.8
		2.0
		2.2
2.4		
S		
Backlight		
Black Level		
DCR	On	
	Off	
		Refer to pages 26-29.

ON SCREEN DISPLAY MENU

Main Menu	Submenu		Reference
Image Settings ()	Color Range	Auto	Refer to pages 26-29.
		Full	
		Limit	
Audio Setting ()	Volume		Refer to page 30.
	Mute	On	
		Off	
	Source	PC	
Video			
System ()	Language	English	Refer to pages 31-33.
		Français	
		Deutsch	
		Italiano	
		Español	
		Nederlands	
		Română	
		Česky	
		Polski	
		Русский	
		简中	
	繁中		
	Recall		
	F/W Update		
	Information	Input Select:	
		Resolution:	
		Horizontal Freq.:	
		Vertical Freq.:	
		Timing Mode:	
	F/W Version:		
Anti-Burn-In	Enable (On/Off)		
	Interval (hours) (4, 5, 6, 8)		
	Mode (A, B, C)		
Alink	On		
	Off		



ON SCREEN DISPLAY MENU

Main Menu	Submenu		Reference
System (⚙️)	Power Saving	On	Refer to pages 31-33.
		Off	
	Source Detect	Auto	
		Manual	
	Blue Screen	On	
		Off	
	Signal Info	On	
		Off	
	Logo	On	
		Off	
	LED	On	
Off			
Low Power	On		
	Off		
OSD Transparency			
OSD Timer			
Input Select (📺)		VGA	Refer to page 33.
		HDMI	
		CVBS	

Note: Availability of some menu items depend on the input source signal and current setting. If the menu is not available, it is disabled and grayed out.



CHAPTER 5: ADJUSTING THE LCD DISPLAY

5.1 Image Setting

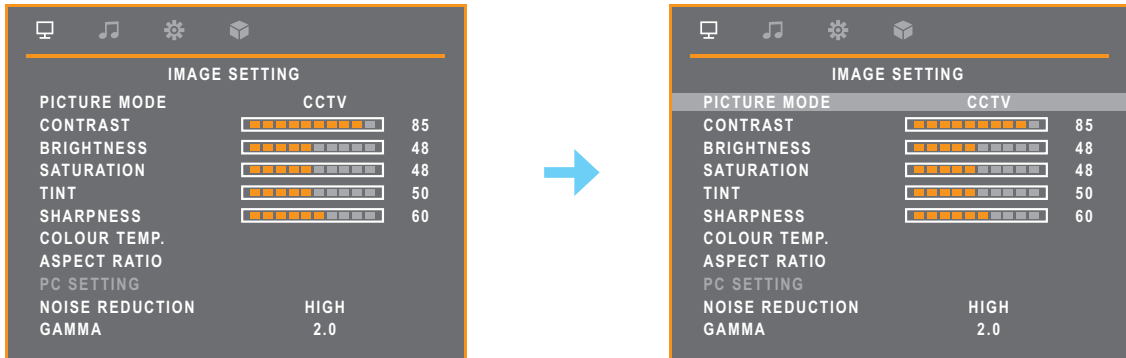

1. Press the  button to call out the OSD window.
2. Press the \wedge or \vee button to select  and press the  button to enter the Image Setting menu.

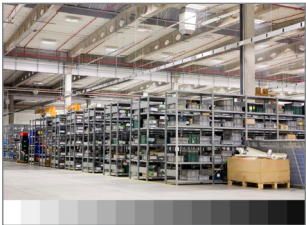
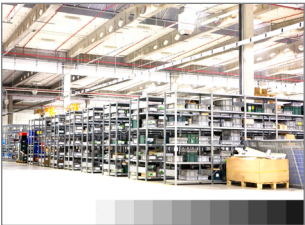
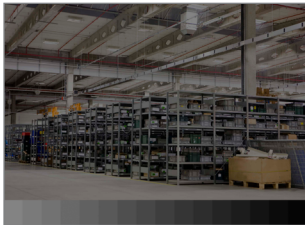
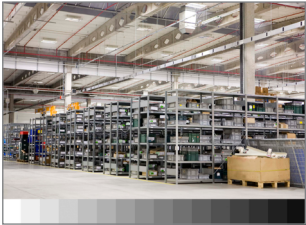

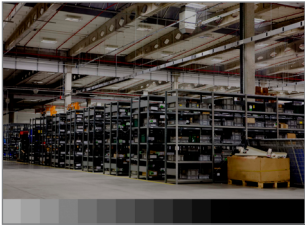
3. Press the \wedge or \vee button to select an option and press the  button to enter its submenu.

Item	Function	Operation	Range
Picture Mode	Chooses a predefined picture setting. Note: Select the suggested colour space to match the corresponding picture mode for optimal results.	Press the \wedge or \vee button to select the setting.	Standard (RGB) CCTV (YUV) Video (YUV)
Contrast	Adjusts the difference between the black level and the white level.	Press the \wedge or \vee button to adjust the value.	0 to 100
	<div style="display: flex; justify-content: space-around; text-align: center;"> <div> <p><i>Original Setting</i></p>  </div> <div> <p><i>High Setting</i></p>  </div> <div> <p><i>Low Setting</i></p>  </div> </div>		
Brightness	Adjusts the luminance of the screen image.	Press the \wedge or \vee button to adjust the value.	0 to 100
	<div style="display: flex; justify-content: space-around; text-align: center;"> <div> <p><i>Original Setting</i></p>  </div> <div> <p><i>High Setting</i></p>  </div> <div> <p><i>Low Setting</i></p>  </div> </div>		
Saturation	Adjusts the colour saturation of the screen image. Note: This menu option is only available if the input source is CVBS or HDMI.	Press the \wedge or \vee button to adjust the value.	0 to 100

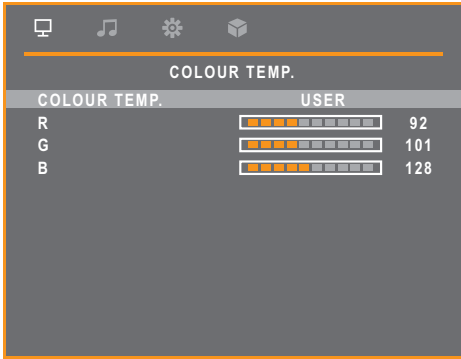

ADJUSTING THE LCD DISPLAY

Item	Function	Operation	Range
Tint	Adjusts the colour tint. Note: <i>This menu option is only available if the input source is CVBS or HDMI.</i>	Press the ▲ or ▼ button to adjust the value.	0 to 100
Sharpness	Adjust the clarity and focus of the screen image. Note: <i>This menu option is only available if the input source is CVBS or HDMI.</i>		
Colour Temp. (Colour Temperature)	Provides several colour adjustment settings.	Press the ▲ or ▼ button to select the setting.	Cool Neutral Warm User
	<p>If the Colour Temp. setting is set to User, you can customize the colour temperature by adjusting the red, green, or blue setting according to your preference.</p>  <p>The screenshot shows the 'COLOUR TEMP. USER' menu. It has three rows: 'R' with a slider at 92, 'G' with a slider at 101, and 'B' with a slider at 128. Each slider is represented by a horizontal bar with orange and grey segments.</p>		
<p>a. Select User and press the  button.</p> <p>b. Press the ▲ or ▼ button to select the colour you want to adjust. Then press the  button to enter its submenu.</p> <p>c. Press the ▲ or ▼ button to adjust the value (0~255).</p>			

ADJUSTING THE LCD DISPLAY



Item	Function	Operation	Range
Aspect Ratio	Adjusts the aspect ratio of the screen image.	Press the ▲ or ▼ button to select the setting.	Full Native Real Zoom
	<ul style="list-style-type: none"> If the Aspect Ratio setting is set to Zoom, you can customize the aspect ratio by adjusting the horizontal zoom (H. Zoom) and/or vertical zoom (V. Zoom) according to your preference. <div data-bbox="667 571 1129 929" data-label="Image"> <p>The screenshot shows the 'ASPECT RATIO' menu with a 'ZOOM' sub-menu selected. The 'ZOOM' sub-menu contains three items: 'H. ZOOM', 'V. ZOOM', and 'OVERSCAN', each with a horizontal bar graph and a numerical value of 0.</p> </div> <ul style="list-style-type: none"> a. Select Zoom and press the ≡ button. b. Press the ▲ or ▼ button to select the zoom parameter that you want to adjust. Then press the ≡ button to enter its submenu. c. Press the ▲ or ▼ button to adjust the value (0 ~ 100). 		
	<ul style="list-style-type: none"> If the Aspect Ratio setting is set to Full, Native, or Zoom, you can fix the cut-off screen edges by adjusting the Overscan parameter. <ul style="list-style-type: none"> a. Select Full, Native, or Zoom and press the ≡ button. b. Press the ▲ or ▼ button to select Overscan. Then press the ≡ button to enter its submenu. c. Press the ▲ or ▼ button to adjust the value (0 ~ 100). 		
PC Setting	Auto Adjust: Automatically optimizes the display of VGA input image.		
Note: This menu option is only available if the input source is VGA.	H. Position (Horizontal Position): Moves the OSD window to the left or right of the screen.	Press the ▲ or ▼ button to adjust the value.	0 to 100
	V. Position (Vertical Position): Moves the OSD window up or down the screen.		
	Clock: Adjusts the frequency timing to synchronize with the video signal.		
	Phase: Adjusts the phase timing to synchronize with the video signal.		

ADJUSTING THE LCD DISPLAY

Item	Function	Operation	Range
Noise Reduction	Adjusts the noise reduction to help remove noise from images. This helps produce clearer and crisper images. Note: <i>This menu option is only available if the input source is CVBS or HDMI.</i>	Press the ▲ or ▼ button to select the setting.	Off Low Mid High
	<p style="text-align: center;">Noise Reduction Off</p>  <p style="text-align: center;">Noise Reduction On</p> 		
Gamma	Adjusts the non-linear setting for picture luminance and contrast.	Press the ▲ or ▼ button to select the setting.	1.8 2.0 2.2 2.4 S
Backlight	Adjusts the luminance of the screen image.	Press the ▲ or ▼ button to adjust the value.	0 to 100
Black Level	Adjusts the black level of the screen image. Low brightness setting makes black colour darker.		
DCR (Dynamic Contrast Ratio)	Activates DCR. This feature provides automatic adjustment of dynamic luminance (Backlight) range, such as when watching movies. DCR is suitable for indoor viewing.	Press the ▲ or ▼ button to select the setting.	On Off
Color Range	Adjusts black and white levels for video. Note: <i>This menu option is only available if the input source is HDMI.</i>		Auto Full Limit



ADJUSTING THE LCD DISPLAY

5.2 Audio Setting

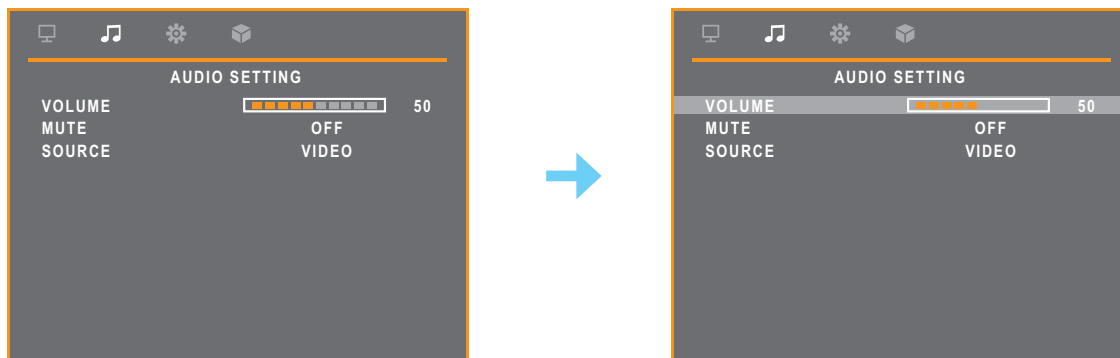
1. Press the  button to call out the Audio Setting menu.
2. Press the \wedge or \vee button to select  and press the  button to enter the Audio Setting menu.







3. Press the \wedge or \vee button to select an option and press the  button to enter its submenu.

Item	Function	Operation	Range
Volume	Adjusts the volume level of the built-in speaker.	Press the \wedge or \vee button to adjust the value.	0 to 100
Mute	Turns the audio speaker on or off. While off, a screen message is displayed as follows:  Note: You can also mute/unmute audio by pressing and holding the  button for 3 seconds. Refer to page 20.	Press the \wedge or \vee button to select the setting.	On Off
Source	Selects the audio source for the PC or Video input signal. Note: This menu option is only available if the input source is HDMI.		PC Video



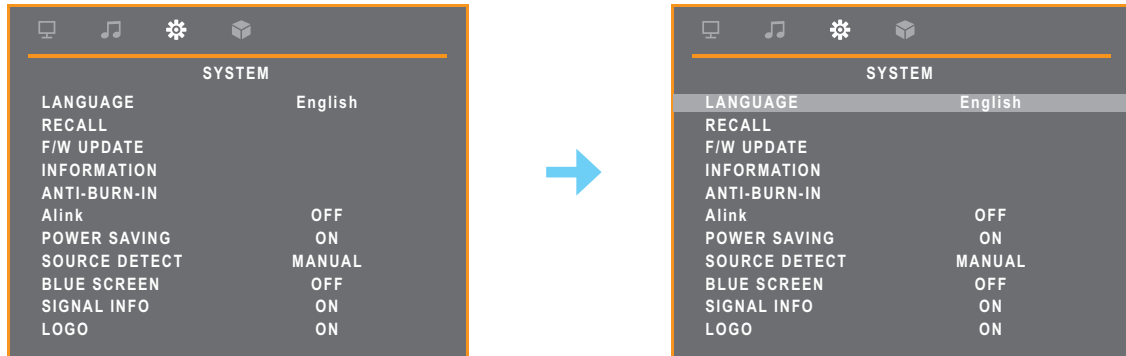

ADJUSTING THE LCD DISPLAY

5.3 System

1. Press the  button to call out the OSD window.
2. Press the  or  button to select  and press the  button to enter the System menu.



3. Press the  or  button to select an option and press the  button to enter its submenu.

Item	Function	Operation	Range
Language	Select the OSD language.	Press the  or  button to select the setting.	English Français Deutsch Italiano Español Nederlands Română Česky Polski Русский 簡中 繁中
Recall	Use to recall all to default settings, except Language. Select Yes when you are prompted to confirm resetting all the setting.	Press the  button to reset all the setting to the factory defaults.	Yes No
F/W Update	Connect a USB storage device to the USB port of the LCD display for firmware upgrade. For more information on connecting a USB device, please refer to page 16.		
Information	Displays settings information such as Input Select, Resolution, Horizontal and Vertical Frequency, Timing mode, and Firmware version. Note: Information on horizontal frequency, vertical frequency, and time mode is only available if the input source is VGA.		
Anti-Burn-In	Enable: Enables or disables Anti-Burn-in™ function.	Press the  or  button to select the setting.	On Off
	Interval (Hours): Sets the interval time (hour) between activating the Anti-Burn-in™ function.		4 5 6 8

ADJUSTING THE LCD DISPLAY



Item	Function	Operation	Range
Anti-Burn-In	<p>Mode: Selects the “Anti-Burn-In” mode:</p> <ul style="list-style-type: none"> • A - Executes fast. • B - Slower but more precise than mode A. • C - Slowest but the most precise Anti-Burn-in™ mode. 	Press the ▲ or ▼ button to select the setting.	A B C
Alink	<p>Synchronizes powering on/off via HDMI.</p> <p>Note: <i>This menu option is only available if the input source is HDMI.</i></p>		On Off
Power Saving	<p>Enables or disables power saving mode. When the LCD display turns into power saving mode, the screen turns black and the LED indicator lights amber.</p> <p>Note: <i>The amount of time for the display to enter power saving varies depending on the Source Detect setting. If the Source Detect is set to Auto, the display checks all input source signals before entering power saving mode if no signal is detected; this takes up more time. If the Source Detect is set to Manual, the display enters power saving mode right away.</i></p>		
Source Detect	Sets the display to automatically or manually detect the input source signal.		Auto Manual
Blue Screen	Enables or disables the blue screen feature. If the setting is set to On , it displays a blue screen when no signal is available.		On Off
Signal Info	Enables or disables the signal information to be displayed on the screen.		
Logo	Enables or disables the logo feature. If the setting is set to On , the AG Neovo logo is briefly displayed after the display is powered on.		
LED	Turns the LED indicator on or off while using the LCD monitor.		
Low Power *	To unlock backlight before any customisation settings.		

* Product features may vary by models

ADJUSTING THE LCD DISPLAY

Item	Function	Operation	Range
OSD Transparency	Sets the transparency of the OSD menu.	Press the \wedge or \vee button to adjust the value.	0 to 100
OSD Timer	Sets the length of time (in seconds) the OSD screen is displayed. When the time elapses, the OSD screen is automatically inactivated		

5.4 Input Select

1. Press the  button to call out the OSD window.
2. Press the \wedge or \vee button to select  and press the  button to enter the Input Select menu.

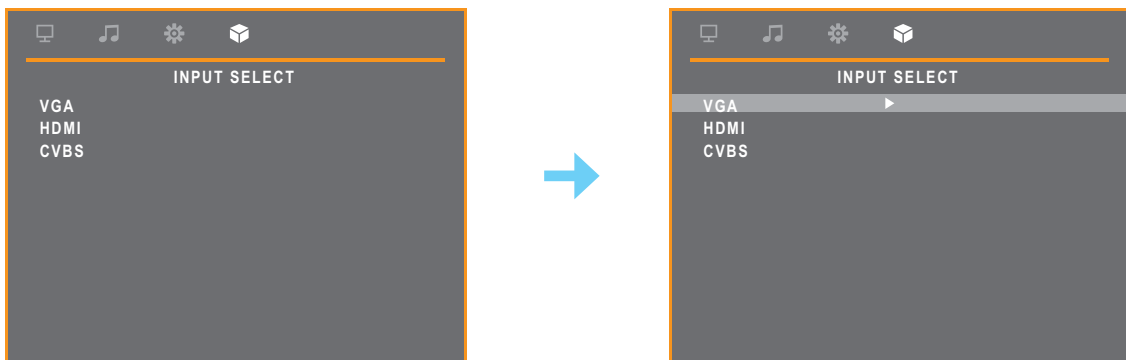













3. Press the \wedge or \vee button to select an input source and press the  button to set the input source.

Item	Function
VGA	Sets VGA as the input source signal.
HDMI	Sets HDMI as the input source signal.
CVBS	Sets CVBS as the input source signal.

CHAPTER 6: APPENDIX



6.1 Warning Messages

When any of these warning messages appear, check the following items.

Warning Message	Cause	Solution
	The resolution or the refresh rate of the graphics card of the computer is set too high.	√ Change the resolution or the refresh rate of the graphics card.
	The LCD display cannot detect the input source signal.	<ul style="list-style-type: none"> √ Check if the input source is turned ON. √ Check if the signal cable is properly connected. √ Check if any pin inside the cable connector is twisted or broken.
	The OSD has been locked by the user.	√ Press and hold the  +  buttons for 3 seconds to unlock the control buttons.
	The Anti-Burn-in™ function has been enabled by the user.	√ Set the “ Anti-Burn-In ” > Enable setting to Off in System () menu (refer to page 31).
	The FREEZE has been activated.	√ Press and the hold the  button to unfreeze the screen.
	The Mute function is enabled.	<ul style="list-style-type: none"> √ Press and hold the  button for 3 seconds to disable the mute function. √ Press the  and  buttons simultaneously to disable the mute function.

APPENDIX

6.2 Troubleshooting

Problems	Possible Cause and Solution
No picture. • LED indicator is OFF.	<ul style="list-style-type: none"> • Check if the LCD display is turned ON. • Check if the power cord is plugged into the power outlet.
• LED indicator is amber.	<ul style="list-style-type: none"> • Check if the computer is turned ON. • Check if the computer is in standby mode, move the mouse or press any key to wake up the computer.
Image position is incorrect.	<ul style="list-style-type: none"> • For VGA input, adjust the H. Position and V. Position settings in Image Setting () menu (refer to page 28).
The displayed texts are blurry.	<ul style="list-style-type: none"> • For VGA input, do the following: <ul style="list-style-type: none"> √ Auto-adjust the display (refer to page 28). √ Adjust the Clock and Phase settings in Image Setting () menu (refer to page 28).
Red, blue, green, white dots appear on the screen.	<ul style="list-style-type: none"> • There are millions of micro transistors inside the LCD display. It is normal for a few transistors to be damaged and to produce spots. This is acceptable and is not considered a failure.
No audio output.	<ul style="list-style-type: none"> • Check if the volume is set to 0 or the Mute function is enabled (refer to pages 19-20). • For VGA input, check the audio setting of the computer.
Dew formed on the LCD display.	<ul style="list-style-type: none"> • This normally happens when the LCD display is moved from a cold room to a hot room temperature. Do not turn ON the LCD display, wait for the dew condensation to disappear.
Faint shadows from a static image appear on the screen.	<ul style="list-style-type: none"> • Turn off the LCD display for extended periods of time. • Use a screen saver or a black and white image and run it for extended periods of time.

APPENDIX

6.3 Transporting the LCD Display

To transport the LCD display for repair or shipment, place the display in its original packaging box.

Note:

- *When repacking, carefully place the LCD display in its box and protect the screen surface from touching any object.*

1. Remove the stand.

- Place the LCD display with the screen side down on a cushioned surface.
- Press down on the release latch to unlock the stand and then slide the stand out of the recess on the display.

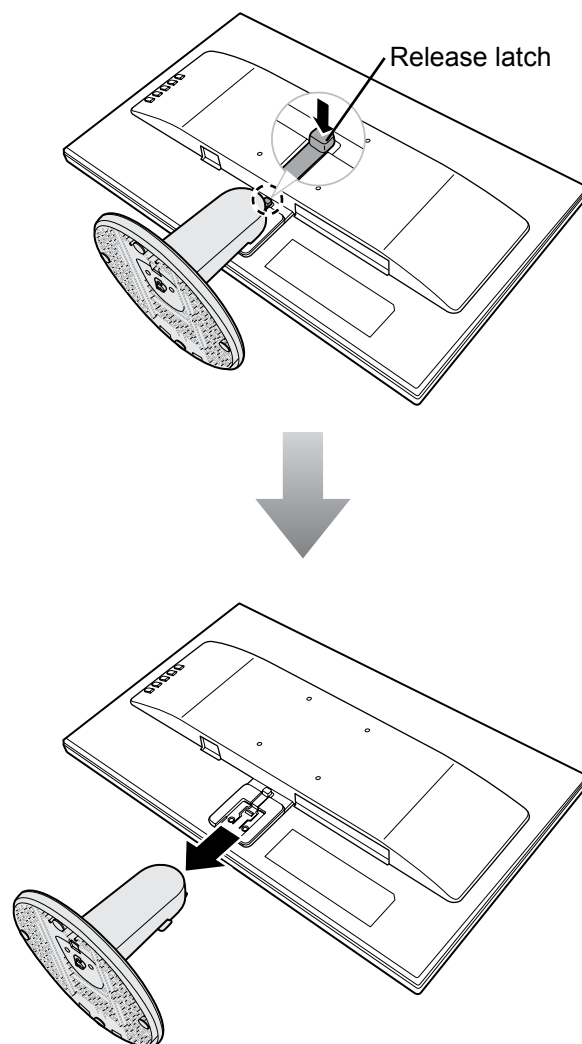

APPENDIX

2. Detach the base from the stand.

-**SC-19E/22E/24E models:** Pinch the latches to unlock the base and then remove the base from the stand.

-**SC-27E model:** Unscrew the base and then remove the base from the stand.

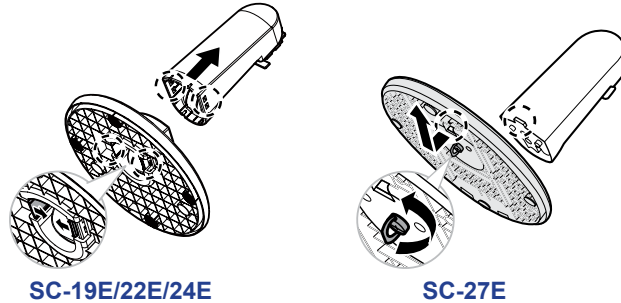

3. Put the LCD display inside its original plastic. Then place the LCD display with the screen side down on the foam cushion.

4. Put all other contents on their designated area (if necessary).

5. Close and tape the box.

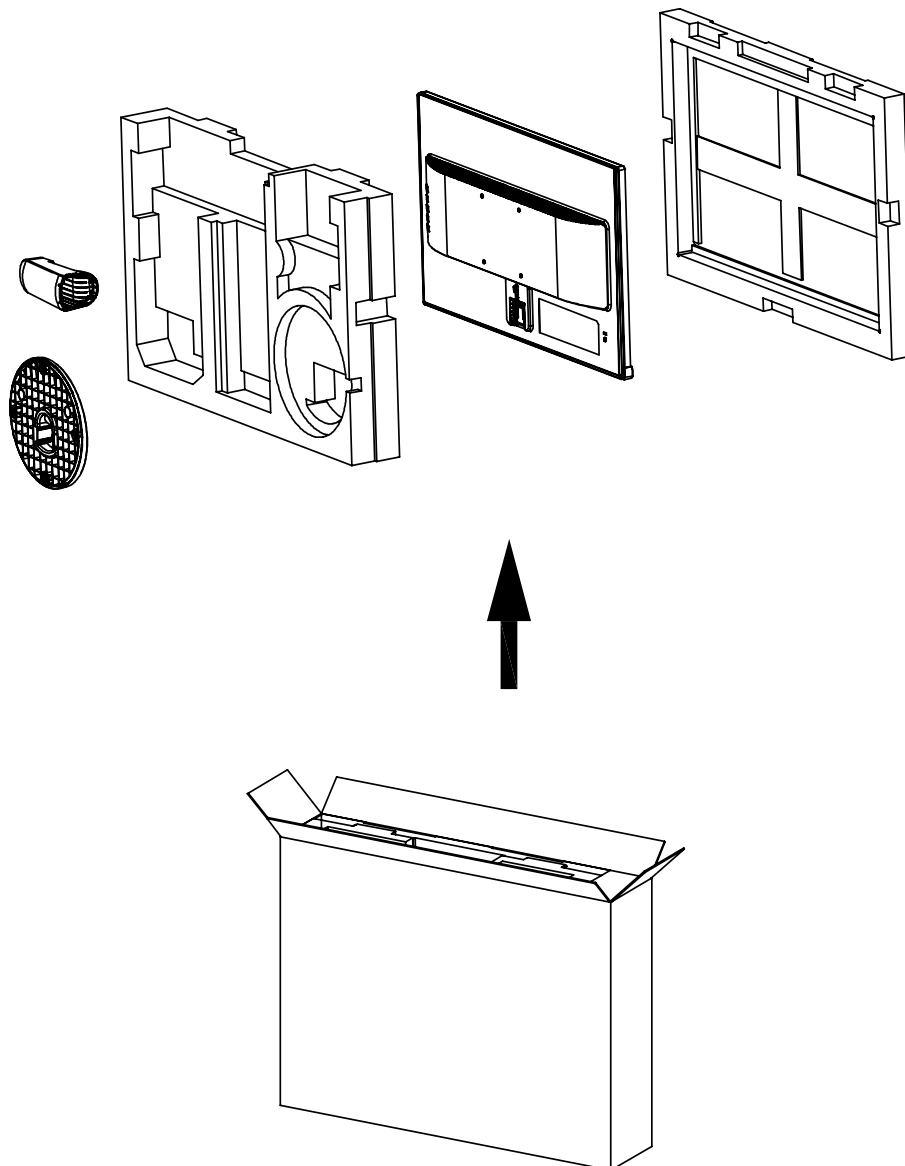

CHAPTER 7: SPECIFICATIONS

7.1 Display Specifications

		SC-19E	SC-22E	SC-24E	SC-27E
Panel	Panel Type	LED-Backlit TFT LCD (TN Technology)	LED-Backlit TFT LCD (TN Technology)	LED-Backlit TFT LCD (IPS Technology)	LED-Backlit TFT LCD (VA Technology)
	Panel Size	18.5	21.5	23.8	27.0
	Max. Resolution	1366 x 768	FHD 1920 x 1080	FHD 1920 x 1080	FHD 1920 x 1080
	Pixel Pitch	0.300 mm	0.248 mm	0.275 mm	0.311mm
	Brightness	250 cd/m ²	250 cd/m ²	250 cd/m ²	300 cd/m ²
	Contrast Ratio	20,000,000:1 (DCR)	20,000,000:1 (DCR)	20,000,000:1 (DCR)	20,000,000:1 (DCR)
	Viewing Angle (H/V)	170°/160°	170°/160°	178°/178°	178°/178°
	Display Colour	16.7M	16.7M	16.7M	16.7M
	Response Time	3 ms	3 ms	5 ms	5 ms
Horizontal Resolution	TV Lines	600TVL (NTSC), 625TVL (PAL)	600TVL (NTSC), 625TVL (PAL)	600TVL (NTSC), 625TVL (PAL)	600TVL (NTSC), 625TVL (PAL)
Frequency (H/V)	H Freq.	24 kHz-83 kHz	24 kHz-83 kHz	24 kHz-83 kHz	24 kHz-83 kHz
	V Freq.	50 Hz-75 Hz	50 Hz-75 Hz	50 Hz-75 Hz	50 Hz-75 Hz
Input	HDMI	1.4 x 1	1.4 x 1	1.4 x 1	1.4 x 1
	VGA	15-Pin D-Sub x 1	15-Pin D-Sub x 1	15-Pin D-Sub x 1	15-Pin D-Sub x 1
	Composite	BNC x 1	BNC x 1	BNC x 1	BNC x 1
Output	Composite	BNC x 1	BNC x 1	BNC x 1	BNC x 1
Audio	Audio In	Stereo Audio Jack (3.5 mm)	Stereo Audio Jack (3.5 mm)	Stereo Audio Jack (3.5 mm)	Stereo Audio Jack (3.5 mm)
	Audio Out	Stereo Audio Jack (3.5 mm)	Stereo Audio Jack (3.5 mm)	Stereo Audio Jack (3.5 mm)	Stereo Audio Jack (3.5 mm)
	Internal Speakers	2W x 2	2W x 2	2W x 2	2W x 2
Power	Power Supply	Internal	Internal	Internal	Internal
	Power Requirements	AC 100-240V, 50/60 Hz	AC 100-240V, 50/60 Hz	AC 100-240V, 50/60 Hz	AC 100-240V, 50/60 Hz
	On Mode	16W (On)	21W (On)	22W (On)	23W (On)
	Stand-by Mode	< 0.5W	< 0.5W	< 0.5W	< 0.5W
	Off Mode	< 0.5W	< 0.5W	< 0.5W	< 0.5W
Operating Conditions	Temperature	0°C-40°C (32°F-104°F)	0°C-40°C (32°F-104°F)	0°C-40°C (32°F-104°F)	0°C-40°C (32°F-104°F)
	Humidity	10%-80% (non-condensing)	10%-80% (non-condensing)	10%-80% (non-condensing)	10%-90% (non-condensing)
Storage Conditions	Temperature	-20°C-55°C (-4°F-131°F)	-20°C-55°C (-4°F-131°F)	-20°C-55°C (-4°F-131°F)	-20°C-60°C (-4°F-140°F)
	Humidity	5%-93% (non-condensing)	5%-93% (non-condensing)	5%-93% (non-condensing)	5%-90% (non-condensing)
Mounting	VESA FPM PMI	Yes (100 x 100 mm)	Yes (100 x 100 mm)	Yes (100 x 100 mm)	Yes (100 x 100 mm)
Stand	Tilt	-5° to 23°	-5° to 23°	-5° to 23°	-5° to 23°
Security	Kensington Security Slot	Yes	Yes	Yes	Yes
Dimensions	Product with Base (W x H x D)	441.9 x 356.2 x 194.0 mm (17.4" x 14.0" x 7.6")	505.2 x 380.8 x 194.0 mm (19.9" x 15.0" x 7.6")	540.6 x 396.1 x 194.0 mm (21.3" x 15.6" x 7.6")	611.9 x 454.7 x 238.7 mm (24.1" x 17.9" x 9.4")
	Packaging (W x H x D)	492.0 x 360.0 x 123.0 mm (19.4" x 14.2" x 4.8")	557.0 x 387.0 x 117.0 mm (21.9" x 15.2" x 4.6")	620.0 x 420.0 x 122.0 mm (24.4" x 16.5" x 4.8")	704.0 x 460.0 x 140.0 mm (27.7" x 18.11" x 5.5")
Weight	Product with Base	2.3 kg (5.1 lb)	2.8 kg (6.2 lb)	3.8 kg (8.2 lb)	5.3 kg (11.7 lb)
	Packaging	3.6 kg (7.9 lb)	4.2 kg (9.3 lb)	5.4 kg (11.9 lb)	7.3 kg (16.1 lb)

Note: All specifications are subject to change without prior notice.

SPECIFICATIONS

7.2 Display Dimensions

SC-19E

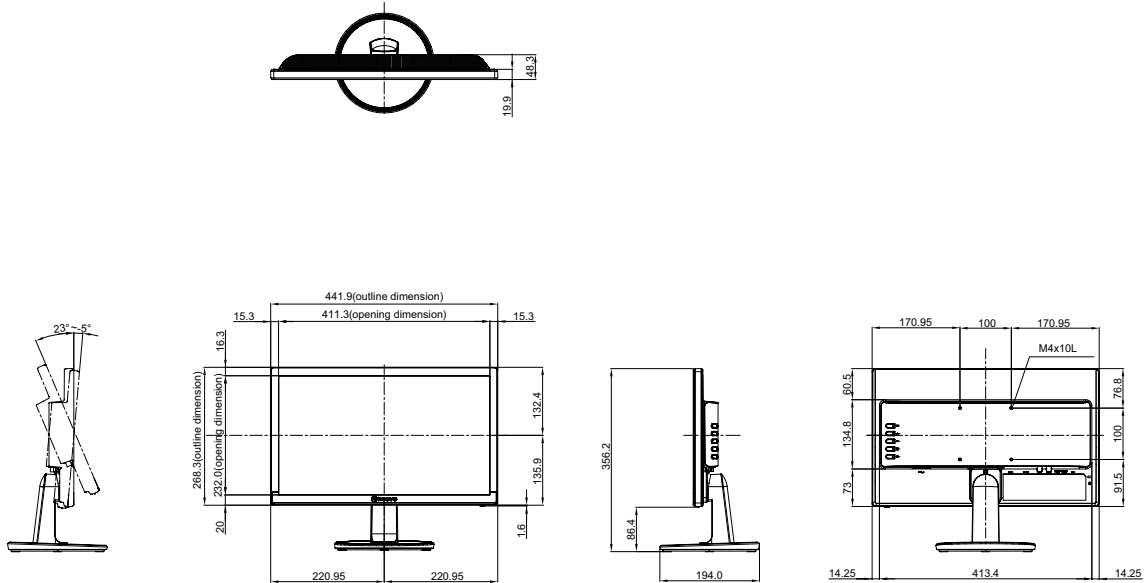

SC-22E

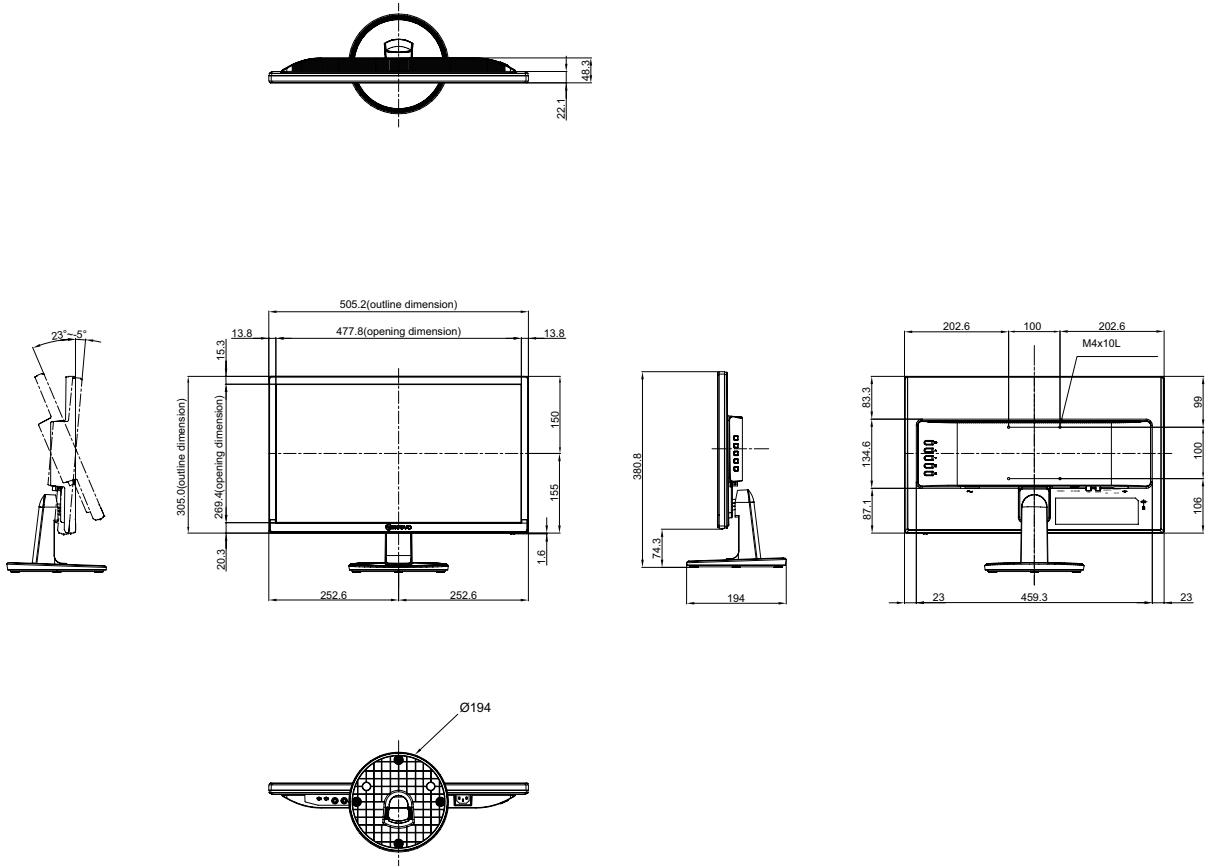

SPECIFICATIONS

SC-24E

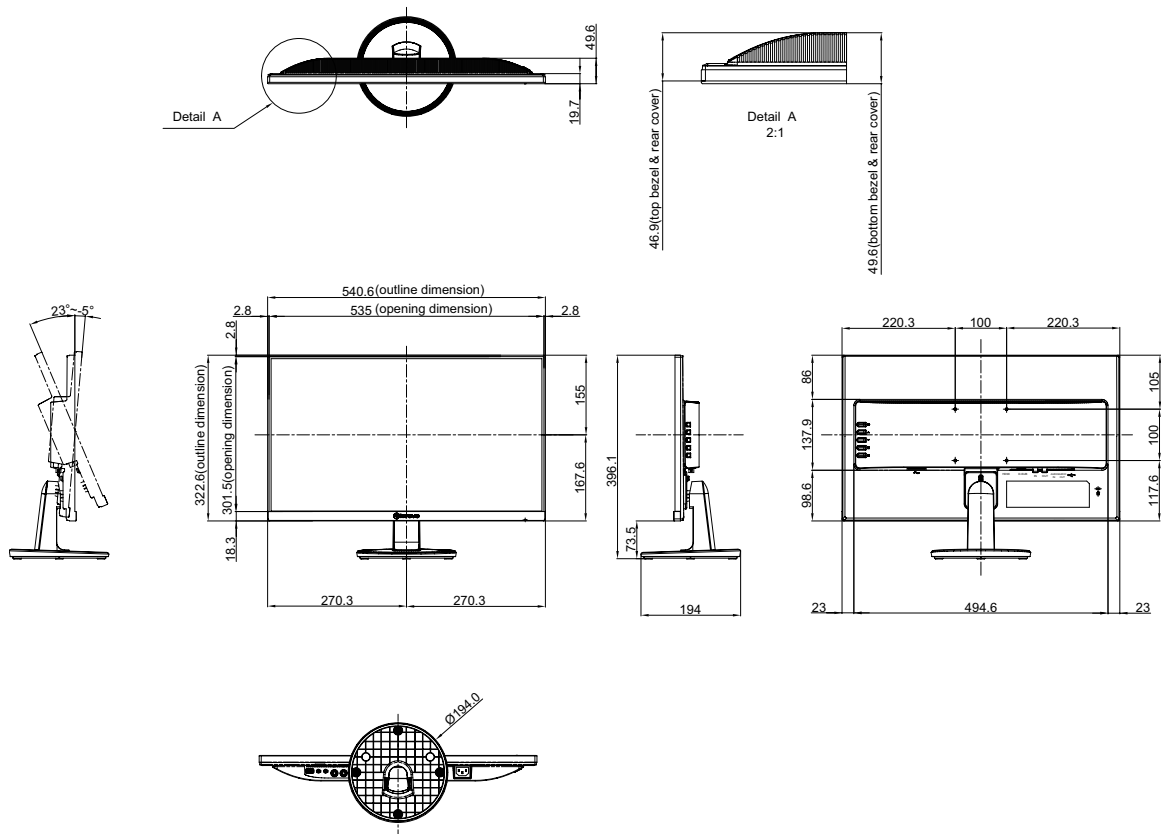

SC-27E

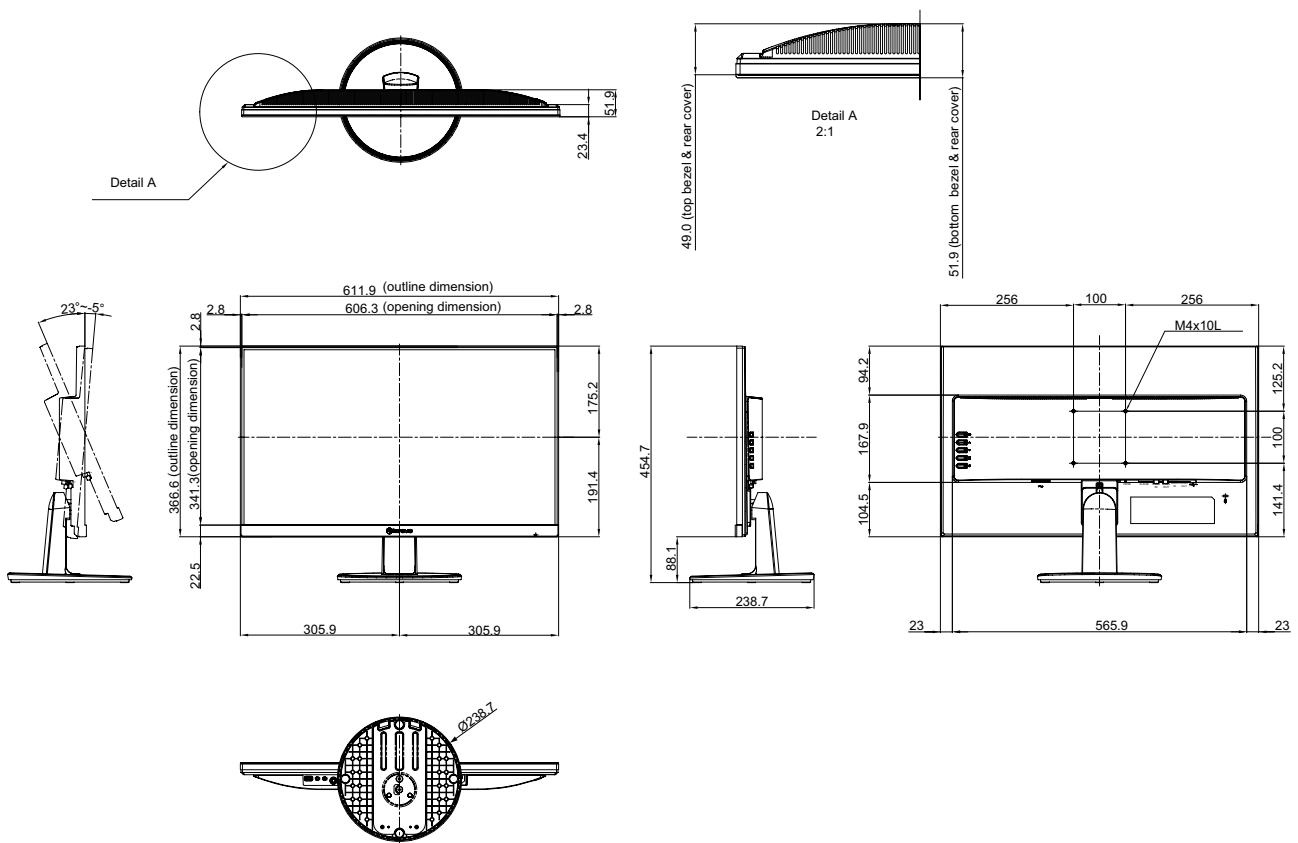

AG Neovo

Company Address: 5F-1, No. 3-1, Park Street, Nangang District, Taipei, 11503, Taiwan.

Copyright © 2019 AG Neovo. All Rights Reserved.

S27E00/S24E00/S22E00/S19E00_UM_V011