



# TV

## USER MANUAL

43 VLE 4820

EN

[www.grundig.com](http://www.grundig.com)

**GRUNDIG**

# CONTENTS

---

- 4 SETUP AND SAFETY**
- 7 GENERAL INFORMATION**
- 7 Special features of your television
- 7 Receiving digital channels
- 8 Important notes on environmental protection
- 8 Notes on still pictures
- 9 PACKAGING CONTENTS**
- 9 Standard accessories
- 10 CONNECTION/  
PREPARATION**
- 10 Setting up with stand
- 10 Preparing for mounting on the VESA installation kit
- 11 Connecting the air and the mains cable
- 12 Inserting batteries in the remote control
- 13 OVERVIEW**
- 13 Connections of the television set
- 14 Buttons of the remote control
- 14 Turning on the television and switching it to standby mode
- 14 Adjusting the volume
- 14 Changing the channel
- 15 Remote control - main functions
- 16 Remote control - all functions
- 17 SETTINGS**
- 17 First time installation and channel search...
- 17 Selecting language, country and operation mode
- 18 Searching television channels with satellite signal
- 19 Searching terrestrial digital television channels
- 19 Searching cable digital television channels
- 21 Changing stored channels for digital stations
- 23 PICTURE AND VOLUME SETTINGS**
- 23 Picture settings
- 23 Sound settings
- 25 FUNCTIONING OF THE TV - BASIC FUNCTIONS**
- 25 Basic functions
- 26 Changing the picture format
- 27 ELECTRONIC TV GUIDE**
- 27 Electronic TV guide
- 28 TELETEXT MODE**
- 28 Text mode
- 28 Additional functions
- 29 USB MODE**
- 29 The file formats
- 30 Connecting external data media
- 31 The file browser
- 31 Playback - Basic functions
- 32 Additional playback functions
- 33 LANGUAGE SETTINGS**
- 33 Changing the menu language
- 33 Changing the Teletext language
- 33 Changing the audio language
- 33 Changing the subtitle language
- 34 TIME SETTINGS**
- 34 Time
- 34 Time Zone
- 34 Sleep timer
- 34 Auto standby
- 34 Sleep timer for OSD menu
- 35 LOCK SETTINGS**
- 35 Menu Lock
- 35 Changing the PIN code
- 35 Blocking a television channel
- 36 Watching a blocked television channel
- 36 Parental Guidance
- 36 Locking the control panel (parental control)
- 37 OTHER SETTINGS**
- 37 Software update (USB)
- 37 Resetting the television to its original state

# CONTENTS

---

- 38 USING EXTERNAL DEVICES**
  - 38 HDMI CEC
  - 38 HDMI CEC connection functions of the television
  - 39 High definition - HD ready
  - 39 Connection options
  - 40 Connecting an external device
  - 40 Headphones
  - 40 Hi-fi system
  
- 41 PC MONITOR MODE**
  - 41 Connecting a PC
  - 41 Selecting the channel position for the PC
  
- 42 OPERATION WITH COMMON INTERFACE**
  - 42 What is Common Interface?
  - 42 Inserting the CA module
  - 42 Access control for CA module and smart cards
  
- 43 DETAILED CHANNEL SETTINGS**
  - 43 Searching for all digital television channels from a satellite automatically
  - 44 Searching for digital television channels from a satellite manually
  - 45 LNB Settings
  - 46 Motorized antenna setup (DiSEqC 1.2)
  - 47 Searching for digital television channels through cable automatically
  - 48 Searching for digital television channels through cable manually
  - 48 Searching for digital television channels through aerial automatically
  - 49 Manual searching for digital television channels with aerial connection
  - 50 Tuning analogue television channels
  - 51 Displaying signal information
  
- 52 INFORMATION**
  - 52 Service information for dealers
  - 52 Environmental warning
  - 52 Cleaning the TV set
  - 52 Disposing of the packaging
  - 53 Troubleshooting
  
- 54 GLOSSARY**
  
- 55 INDEX**

## About your TV set

- In addition to DVB-S, DVB-T and DVB-C digital TV programmes, you can also watch analogue TV broadcasts with your TV set.

## Intended use

- The TV set is designed for use in dry rooms.
- Use the TV set with the supplied stand or a suitable VESA bracket.
- The TV set is primarily intended for the playback of TV programmes, streaming content and music/video material from external devices. Any other use is strictly prohibited.  
It is not intended as an information display or for predominant use as a computer monitor. If a still image or a non-full-format image is displayed for an extended period, visible traces may remain on the screen for some time.  
This is not a defect that can be used in warranty request.

## Moving the product

Unplug the product before moving it. Disconnect antenna cable and other external devices connected to the TV set. If you have kept the original product box, use it to pack the product. If you have not kept the original product box, wrap the product in bubble wrap or a thick cardboard. Pay attention to avoid damages during moving.

## Safety

### ▲ WARNING

### Risk of electrical accident

- Do not dismantle the TV set. Safety risk may arise and also the guarantee of the product can be void if the television set is opened.
- The TV set can only be operated with the power cable or the AC/DC adaptor supplied with the product.
- Do not operate the TV set with a damaged power cable/AC/DC adaptor (if supplied).
- If the plug on the TV set has an earthing contact, only insert the plug into a socket with an earthing contact.
- Plug the TV set into the mains socket only after you have connected the external devices and the antenna.
- Protect the TV set from moisture. Do not place any vessels filled with water (such as vases) on the TV.

### Fire hazard

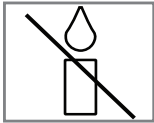
-  To prevent the spread of fire, keep candles or other open flames away from this product at all times.
  - Do not cover the ventilation slots on the TV set.
- Always unplug the power plug and antenna plug during a thunderstorm.
- Keep candles or other open flames away from the TV set.
- Do not expose the batteries to extreme heat such as sunshine, fire or the like.
- Only use batteries of the same type (brand, size, properties). Do not use used and new batteries together.

## **▲ WARNING**

### **Injuries caused by falling TV set**

Never place the TV set on an unstable surface. The TV set may fall, causing serious injury, possibly leading to death in isolated cases. Observe the following precautions especially to protect the children from such negative incidents:

- Only use furniture that can safely support the TV set.
- Make sure that the TV set does not protrude beyond the dimensions of the furniture on which it is resting.
- Do not place the TV set on tall furniture that has the risk of tipping over such as cabinets, sideboards or bookcases. If you have no other choice, fix the furniture and the TV set to the wall to prevent them from tipping over.
- Do not place the TV set on fabric or other materials located between the TV set and furniture.
- Instruct children that there is danger associated with climbing on furniture when the TV set is to be reached.
- Consider the above mentioned warnings whenever you change the location of the TV set.

## **CAUTION**

### **Shortened service life due to high operating temperature**

- Do not place the TV set next to heating units or in direct sunlight.
- To ensure adequate ventilation, maintain clearance of at least 10 cm around the TV set.



### **Disposing the packaging**

- The packaging materials are dangerous for children. Keep the packaging materials out of the reach of children.
- The packaging of the product is manufactured from recyclable materials. Dispose of by classifying in accordance with waste regulations. Do not dispose along with normal household waste.

### **Discoloration of furniture due to rubber feet**

- Some furniture surfaces may discolor when they come in contact with rubber. To protect furniture, you can place a sheet made of glass or plastic under the stand. Do not use textile underlays or mats such as doilies.

## Environmental information

-  Do not dispose of batteries in the household waste. Used batteries must be returned to retail stores or public collection points. You help protect the environment in this way.
- Be sure to dispose of packaging materials for your product separately according to the guidelines of local authorities so that they can be recycled in an environmentally safe manner.
-  Do not dispose of the product along with normal household waste at the end of its service life. Take it to a recycling center for electrical and electronic equipment.

## Tips for power saving

- Switch the TV set to stand-by if you will not use it for a while. In standby mode, the TV set uses very little energy ( $\leq 0.5$  W). If you do not use the TV set for an extended period, turn it off with the power switch or unplug the power cord from the socket. If you turn off the device or disconnect it from the power supply, the switch-on timer and programmed recordings will not work.
- Select a location so that no direct sunlight falls on the screen. Thus, you can select a lower backlight and provide power saving.

## Special features of your television

- With your TV set, you can receive and watch digital TV programmes including the High Resolution (HD) ones over DVB-S/S2, DVB-T and DVB-C.  
At present, reception for these digital television channels in High Definition is only possible in some countries in Europe.
- Although this TV set meets the current DVB-S/S2, DVB-T and DVB-C standards as of April 2013, its compatibility with future DVB-S/S2 digital satellite broadcasts, DVB-T digital terrestrial broadcasts and DVB-C digital cable broadcasts is not guaranteed.
- This television can receive and process all analogue and all unencrypted digital stations. This television set has an integrated digital and analogue receiver. The digital receiver unit converts the signals from digital stations to provide outstanding audio and picture quality.
- The TV guide (only for digital stations) tells you of any schedule changes at short notice, and provides an overview of all the channels' schedules for the next few days.  
Detailed information on the individual channels – if it is provided by the broadcaster – is also available in the electronic 7 Day TV Guide.
- You can connect various data media such as an external hard disk, a USB memory stick or a digital camera to the USB socket. Using the file browser, you can then select and play the file formats you want (for example, MP4, MP3 or JPEG data).

## Receiving digital channels

- To receive digital satellite channels (DVB-S/S2) you need a satellite antenna.  
To receive digital channels (DVB-T) you need a digital rooftop or indoor antenna (passive or active indoor antenna with its own power supply).  
The antenna cable of the cable TV network that broadcast in DVB-C must be plugged into TV in order to receive the DVB-C broadcasts.
- Unlike analogue broadcasting, not every channel has its own transmission frequency. Instead, several channels are grouped into what are known as bouquets on a regional or national level.
- You can find the current transmission information on teletext from various channels, or look at the TV guide.
- Various digital television stations from private broadcasters are scrambled (DVB-S/S2, DVB-T and DVB-C). Watching these stations and the recording and playback functions are only possible with the appropriate CI module and a SmartCard. Ask your specialist dealer.

# GENERAL INFORMATION

---

## Important notes on environmental protection

- Those items mentioned below will help you reduce the consumption of natural resources as well as save your money by reducing electricity bills.
- If you will not be using the TV set for several days, it should be disconnected from the mains for environmental and safety reasons. TV will not consume energy in this condition.
- If the TV set has main switch, it will be enough to turn the TV off via main switch. TV will reduce energy consumption almost to Zero Watt.
- TV consumes less energy on stand-by mode. However, some TV sets may have features such as on timer, that require the TV set to be left in standby to work correctly.
- TV consumes less energy when brightness is reduced.

## Notes on still pictures

- Watching the same picture for a long time on the screen may cause a still image remains feebly on the background. Feeble picture(s) on the background is originated from LCD/LED technology and does not require any action under guarantee. To avoid such cases and/or minimize the impact, you may observe the tips below.
- Do not allow the same TV channel to stay on the screen for a very long time. Channel logos may cause this situation.
- Do not allow the images, which are not full screen, to constantly stay on the screen; if not streamed in full screen format by the broadcaster, you can convert the images to full screen by changing image formats.
- Higher brightness and/or contrast values will lead this impact to appear faster; therefore, you are recommended to watch your TV in the lowest brightness and contrast levels that would satisfy you.



# PACKAGING CONTENTS

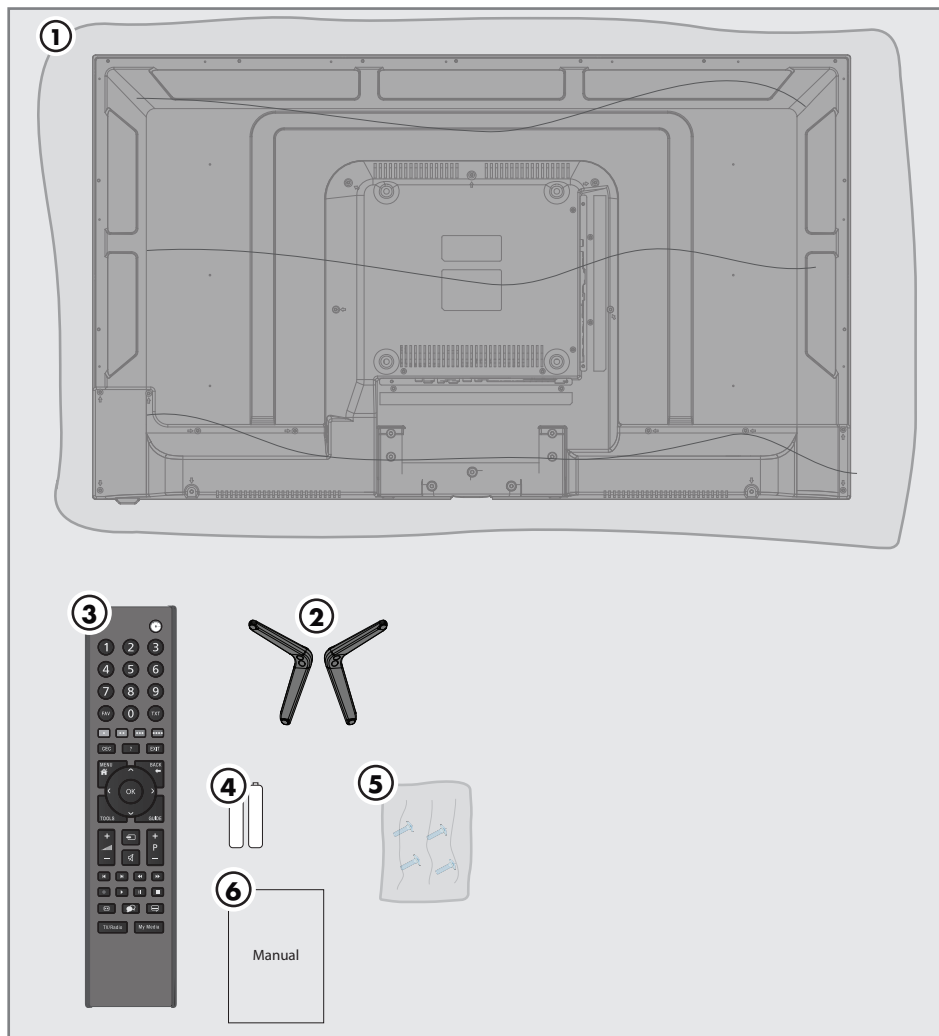

## Standard accessories

- 1 TV
- 2 Stand
- 3 Remote control
- 4 Battery for remote control
- 5 Screws and mounting instructions for stand
- 6 Quick Instruction Manual

# CONNECTION/PREPARATION

---

## Setting up or hanging

- Select a location so that no direct sunlight falls on the screen.

## Setting up with stand

- To mount the stand, refer to the installation instructions included.
- Place the TV set on a hard, level surface.

## Preparing for mounting on the VESA installation kit

Contact authorised dealer to purchase the bracket.

You will need the following:

- A pair of scissors,
- A cross-tip screwdriver.

Follow the installation instructions for the VESA installation kit.

- 1 Place the TV set in the film on a smooth surface with the screen facing down.
- 2 Cut open the film on the back side using the scissors.
- 3 Connect the required cables to the connectors of television. Refer to "Connections" section in this manual.
- 4 Tie the cables so they do not hang down onto the floor.
- 5 Screw the VESA bracket onto the TV set and mount it according to its installation instructions.

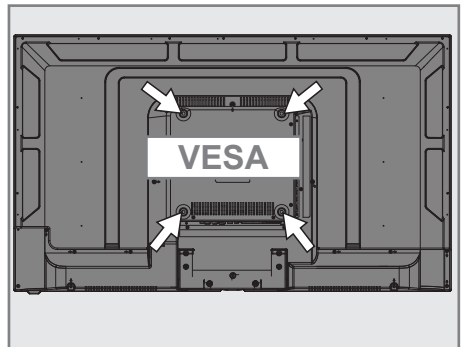

# CONNECTION/PREPARATION

## Connecting the air and the mains cable

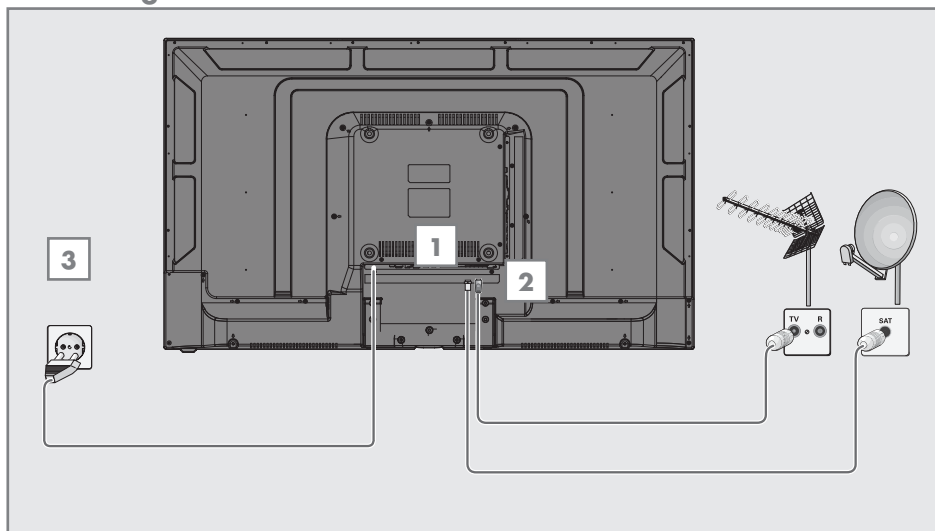

**1** For digital satellite stations (DVB-S/S2) plug the cable of satellite antenna into the antenna socket **RF IN-S2** on the television set;

and / or

**2a** For terrestrial digital stations (DVB-T) plug the cable of the rooftop, indoor antenna (active or passive indoor antenna with its own power supply) into the antenna socket **RF IN-T2** on the television set;

or

**2b** For digital stations of the cable TV network (DVB-C), plug the antenna cable into the antenna socket **RF IN-T2** on the television set;

or

**2c** For analogue stations plug the antenna cable into the antenna socket **RF IN-T2** on the television set.

### Note:

- When connecting an indoor antenna you may have to try it out at different positions until you get the best reception.

**3** Plug the mains cable into the wall socket.

### Notes:

- Make sure that the adaptor is connected to the TV before plugging in the power cable
- Only plug the device into the mains socket after you have connected the external devices and the antenna.
- Do not use an adapter plug or extension cable which does not meet the applicable safety standards. Do not tamper with the power cable.

# CONNECTION/PREPARATION

---

## Inserting batteries in the remote control

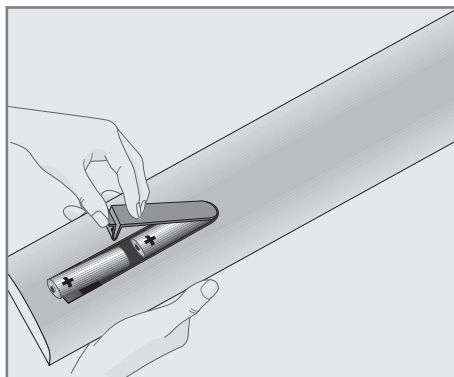

- 1 Open the battery compartment by removing the lid.
- 2 Insert the batteries (2 x 1.5 V micro; for example R03 or AAA). Observe the polarity (marked on the base of the battery compartment).
- 3 Close the battery compartment.

### Note:

- If the television no longer reacts properly to remote control commands, the batteries may be flat. Be sure to remove used batteries.
- The manufacturer accepts no liability for damage resulting from used batteries

## Environmental note



- Make sure that the exhausted batteries are disposed in accordance with the local laws and regulations. The symbol on the battery and package states that the battery supplied with this product should not be considered as a household waste. In some cases, this symbol might be used together with a chemical symbol. If the batteries contain mercury more than 0.0005% or lead more than 0.004%, a chemical symbol -Hg for mercury and Pb for lead- will be placed under the symbol. By ensuring proper disposal of these batteries, you will have contributed in prevention of potential hazards on the environment and human health that may arise from inappropriate disposal of the batteries.

# OVERVIEW

## Connections of the television set

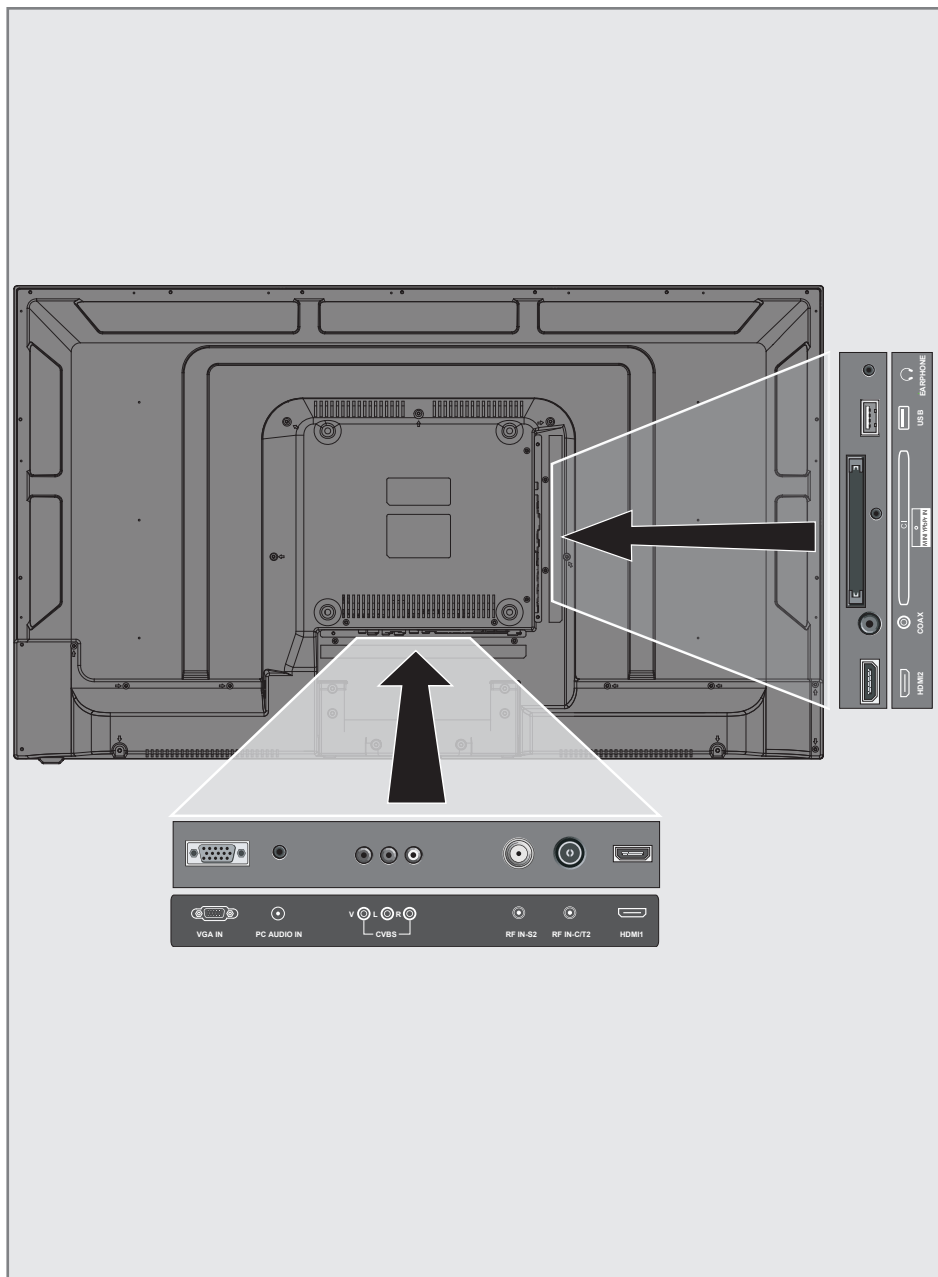

# OVERVIEW

- **Ω**: Headphone jack or external audio output.
- **USB**: USB socket for data media.
- **CI**: For CA modules for receiving scramble channels.
- **MINI YPbPr IN**: Component, audio/video inlet and outlet (3.5mm jack - with YPbPr converter cable).
- **COAX**: Coaxial audio output.
- **HDMI2**: Input for digital audio and image data.
- **HDMI1**: Input for digital audio and image data.
- **RF IN-C/T2**: For antenna cable (terrestrial antenna or cable connection).
- **RF IN-S2**: Satellite antenna input.
- **CVBS (V/L/R)**: Audio/video input for camera.
- **PC AUDIO IN**: Audio signal input for PC.
- **VGA IN**: Image signal input for PC.

## Buttons of the remote control

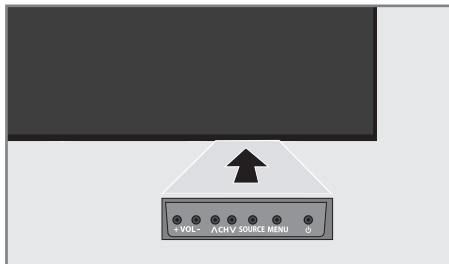

- **VOL+**: Volume up.
- **VOL-**: Volume down.
- **CH ▲**: Channel up.
- **CH ▼**: Channel down.
- **⏻**: Turns on the television in the stand-by mode and switches it to the stand-by mode.

## Turning on the television and switching it to standby mode

- 1 Press "⏻" to turn on the television in the stand-by mode.
- 2 Press "⏻" to switch the television to stand-by mode.

## Adjusting the volume

- 1 Use "VOL+" to increase the volume.
- 2 Use "VOL-" to decrease the volume.

## Changing the channel

- 1 Press "CH ▲" to go to the next channel.
- 2 Press "CH ▼" to go down to the previous channel.

# OVERVIEW

## Remote control - main functions

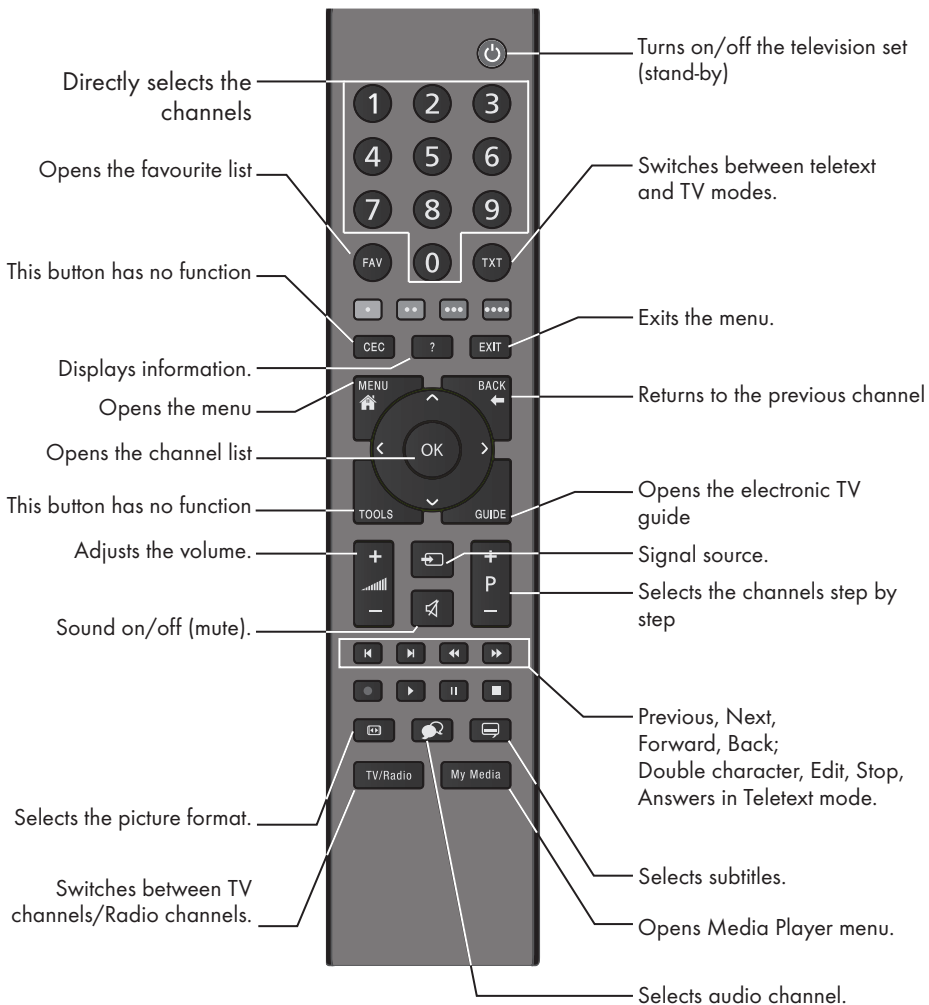

## Cursor Control

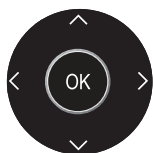

Moves the cursor up and down in the menus.

Moves the cursor left/right in menus.

Opens channel list; activates various functions.

## Remote control - all functions

- ◀ Selects the previous track/previous picture in the file browser.
- ▶ Selects the next track/next picture in the file browser
- ◀◀ Starts the backwards picture search in the file browser.
- ▶▶ Starts the forward picture search in the file browser.
- ▶ Starts playback in the file browser;
- ▮▮ Pauses playback in the file browser.
- Ends playback in the file browser;



## First time installation and channel search...

This TV is equipped with a function that searches the Satellite (DVB-S/S2), Terrestrial (DVB-T), Cable (DVB-C) and analog channels automatically.

After you start searching and search for TV channels, the channels are saved in the Programme Edit and you can sort them as you wish in the Programme Edit.

### Various settings

You can decide which channel type to search for depending on the antenna type connected to your TV.

- See page 18 for searching DVB-S/S2 – digital satellite TV channels.
- For setting up DVB-T – digital terrestrial channels see page 19.
- Setting up DVB-C – digital cable TV channels see page 19.
- See "Detailed Channel Settings" section on page 50 for setting the analogue TV channels.
- See "Detailed Channel Settings" section starting from page 43 for more information on digital television channel settings.

#### Note:

- Select language and country and keep on reading the relevant section.

## Selecting language, country and operation mode

- 1 Press  to switch on the television in standby mode.
  - The »First Time Installation« menu is displayed when the TV is turned on for the first time.

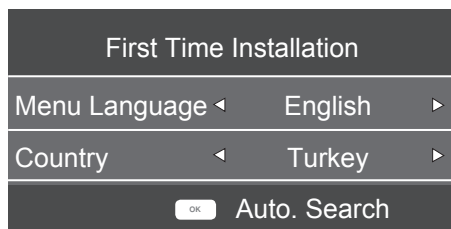

- 2 Select your language using »<<« or »>>«, press »▼« to select the next option.
- 3 Press »<<« or »>>« to select the country and press »▼« to select the next option.

#### Note:

- Following section contains information on how to setup the channels according to the antenna system connected.

## Searching television channels with satellite signal

- 1 In the »Tuning Setup« menu, select »Satellite« from »Scan Type« using »◀« or »▶«.

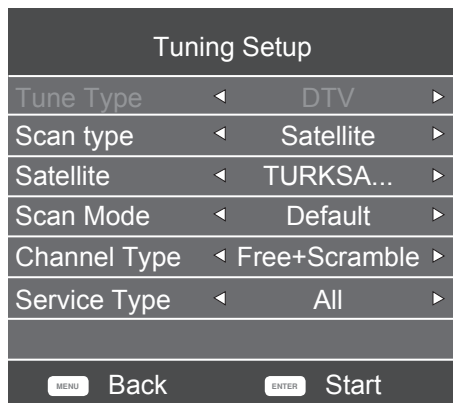

- 2 Select the »Satellite« option using »▼« or »▲« and select the satellite you want to search with »◀« or »▶«.
- 3 Select »Channel Type« using »▼« or »▲«. Press »◀« or »▶« to select whether you want to search for only free digital television channels (Free), only scrambled digital television channels (Scramble) or the both (Free+Scramble).

### Note:

- If some of the frequencies are not stored completely due the changes in satellite parameters made by the broadcaster, it is recommended to set the »Network Settings« option to »Network«.
- 4 Select »Service Type« using »▼« or »▲«. Press »◀« or »▶« to select whether you want to search for only television channels (DTV), only radio (Radio) or the both (All).

- 5 Press »OK« to start the search.
  - The »Channel Tuning« menu will be displayed and the search for TV channels will start.
  - Search may take several minutes depending on the number of television channels received.

### Note:

- The search can be aborted with »EXIT«.
- 6 Press »EXIT« to end searching.

# SETTINGS

## Searching terrestrial digital television channels

- 1 In the »Tuning Setup« menu, select »DVB-T« from »Scan Type« using »◀« or »▶«.

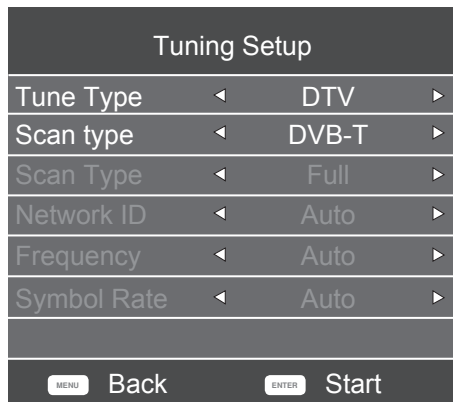

- 2 Select »Tune Type« using »▼« or »▲«. Select the tune type with »◀« or »▶«.
  - »DTV« only searches for digital television channels.
  - »ATV« only searches for analogue television channels.
  - »DTV + ATV« searches for both analogue and digital television channels.
- 3 Press »OK« to start the search.
  - The »Channel Tuning« menu will be displayed and the search for TV channels will start.
  - Search may take several minutes depending on the number of television channels received.

### Note:

- The search can be aborted with »EXIT«.

- 4 Press »EXIT« to end searching.

## Searching cable digital television channels

- 1 In the »Tuning Setup« menu, select »DVB-C« from »Scan Type« using »◀« or »▶«.

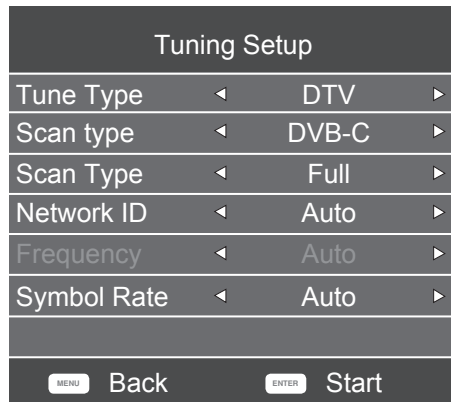

- 2 Select »Tune Type« using »▼« or »▲«. Select the tune type with »◀« or »▶«.
  - »DTV« only searches for digital television channels.
  - »ATV« only searches for analogue television channels.
  - »DTV & ATV« searches for both analogue and digital television channels.
- 3 Select »Scan Type« with »▼« or »▲« and select (»Full«, »Speed« or »Blind Scan«) with »◀« or »▶«.

### Note:

- You can speed up the search. To do this, frequency and network ID information are required. You can obtain such information from your cable provider or find them in Internet forums.

# SETTINGS

---

- 4 Press »**OK**« to start the search.
  - The »Channel Tuning« menu will be displayed and the search for TV channels will start.
  - Search may take several minutes depending on the number of television channels received.

**Note:**

- The search can be aborted with »**EXIT**«.
- 5 Press »**EXIT**« to end searching.

# SETTINGS

## Changing stored channels for digital stations

Channels found at the end of the search are stored in »Programme Edit«.

You can add the channels to your favourite list, change the order of the channels added to the Programme Edit, delete the channels that you do not need and skip certain preset channels.

In Programme Edit, press »CH-« to switch the channel list to the next page, press »CH+« to switch it back to the previous page.

### Opening the Programme Edit

- 1 Press »MENU« to open the menu.
- 2 Press »◀« or »▶« to select the »Channel« menu and press »OK« to confirm.  
- »CHANNEL« menu is now enabled.
- 3 Use »▼« to select the »Programme Edit« and confirm your selection with »OK«.  
- The »Programme Edit« menu is displayed.

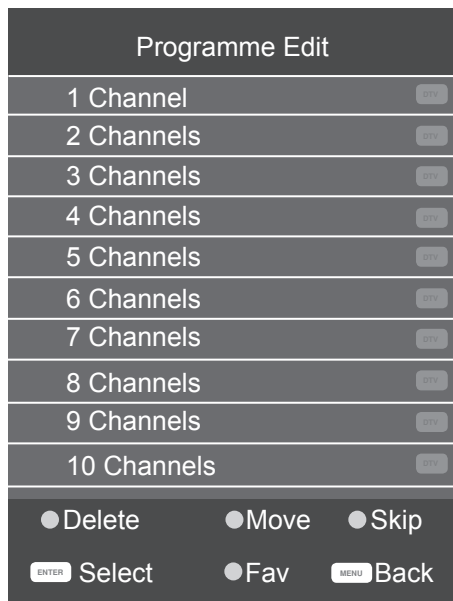

## Deleting channels from the programme edit

- 1 In the »Programme Edit« menu, use »▼« or »▲« to select the channel to be deleted and confirm with »••« (Red).
- 2 Press »EXIT« to quit the »Programme Edit«.

## Moving the channels in the programme edit to a different position

(Satellite, Cable and Terrestrial channels except from those disabled by the broadcaster)

- 1 In the »Programme Edit« menu, use »▼« or »▲« to select the channel to be moved and confirm with »•••« (Yellow).
- 2 Use »▼« or »▲« to move the channel to its new position and confirm with »•••« (Yellow).

### Note:

- Repeat steps 2 and 3 to move other channels.
- 3 Press »EXIT« to quit the »Programme Edit«.

## Skipping television channels

You can determine the television channels to be skipped while selecting channels with »P+« or »P-«. It is still possible to select using the number buttons.

- 1 In the »Programme Edit« menu, use »▼« or »▲« to select the channel to be skipped and confirm with »••••« (Blue).  
- The channel will be marked with »⊙«.
- 2 Press »EXIT« to end searching.

### Notes:

- Channels can be enabled again. Press »▼« or »▲« to select the channel, press »••••« (Blue) to enable the channel again.

# SETTINGS

---

## ***Creating a favourite List***

You can select your favourite channels and save them as a list.

### **Note:**

- Press »**FAV**« to select the favourite list.

- 1 In the »Programme Edit« menu, press »**V**« or »**A**« to select the channel to be added to the favourite list and then confirm with »**FAV**«.  
-The channel will be marked with »**♥**«.

- 2 Press »**EXIT**« to end searching.

### **Note:**

- You can delete channels from the favourite list. In the »Programme Edit« menu, press »**V**« or »**A**« to select the channel and confirm with »**FAV**«.

# PICTURE AND VOLUME SETTINGS

## Picture settings

- 1 Press »MENU« to open the menu.
- 2 Select the »PICTURE« menu using »◀« or »▶« and confirm your selection with »OK«.  
- The »PICTURE« menu is now enabled.

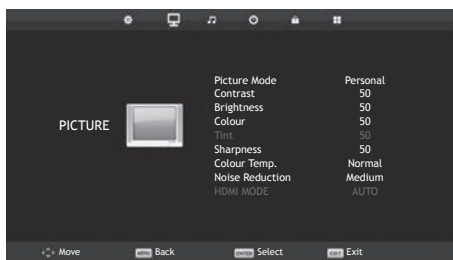

- 3 Use »▼« or »▲« to select »Picture Mode«, »Contrast«, »Brightness«, »Colour«, »Sharpness«, »Colour Temp.« or »Noise Reduction«. Select the value using »◀« or »▶« and confirm your selection with »OK«.

### Notes:

- In the Picture Settings menu, »Contrast«, »Brightness«, »Colour«, »Sharpness« are active when »Picture Mode« and »Personal« are selected.
- 4 Press »EXIT« to finish the setting.

## Sound settings

- 1 Press »MENU« to open the menu.
- 2 Select the »SOUND« menu using »◀« or »▶« and confirm your selection with »OK«.  
- The »SOUND« menu is enabled.

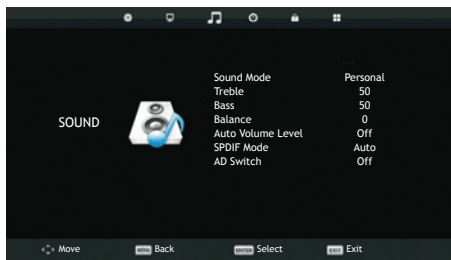

### Note:

- Additional operations are explained in the following sections.

### Treble

- 1 Select »Treble« with »▼« or »▲« and adjust with »◀« or »▶«.

### Note:

- »Treble« is active in the menu when the »Personal« option is selected from »Sound Mode«.

### Bass

- 1 Select »Bass« with »▼« or »▲« and adjust with »◀« or »▶«.

### Note:

- »Bass« is active in the menu when the »Personal« option is selected from »Sound Mode«.

### Balance

- 1 Select »Balance« with »▼« or »▲« and adjust with »◀« or »▶«.

# PICTURE AND VOLUME SETTINGS

---

## **Automatic volume**

The television channels broadcast at different volumes. The Auto Volume Level (AVL) Limiting function means the volume is kept the same when you switch between channels.

- 1 Select »Auto Volume Level« with »▼« or »▲« and select »On« with »◀« or »▶«.

## **AD Switch (audio subtitles)**

AD Switch is an additional audio channel for people who are visually impaired. The activities, surroundings, scene changes or the appearance, the gestures and facial expressions of the actors are described.

This sound is transmitted at the same time as the normal sound with digital television stations. This depends on the programme being broadcast.

- 1 Select »AD Switch« with »▼« or »▲« and select »On« with »◀« or »▶«.
- 2 Select »AD Switch Volume« with »▼« or »▲« and adjust with »◀« or »▶«.

## **Concluding the settings**



- 1 Press »EXIT« to finish the settings.



# FUNCTIONING OF THE TV - BASIC FUNCTIONS

## Basic functions

### Switching on and off

- 1 Press »« to switch on the television in standby mode.
- 2 Press »« to switch on the television in standby mode.

### Selecting channels

- 1 Use »1...0« to select channels directly.
- 2 Press »P+« or »P-« to select up and down channels.
- 3 Open the channels list using »OK«, select the channel using »V« or »^« and confirm with »OK«.

### Selecting channels from the favourite list

- 1 Press »FAV« to recall the favourite list menu.  
– »Favourite List« menu will be displayed.
- 2 Select the channel using »V« or »^« and confirm with »OK«.

### Selecting AV channels

- 1 Open the »Input Source« menu with »«.
- 2 Select the desired AV channel position using »V« or »^« and confirm with »OK«.

### Adjusting the volume

- 1 Adjust the volume with »-  +«.

### Muting

- 1 Use »« to switch the sound off (mute) and to switch it on again.

### Displaying information

- 1 Press »?« to display the information.  
– The menu on the screen disappears automatically after a short while.

### Audio language

You can select various languages when watching digital channels. This depends on the programme being broadcast.

- 1 Press »« to open the selection menu.
- 2 Select your language using »V« or »^« and confirm with »OK«.

### Subtitles

You can select various subtitles when watching digital channels. This depends on the programme being broadcast.

- 1 Press »« to open the selection menu.
- 2 Select your language using »V« or »^« and confirm with »OK«.

### SWAP function

This function allows you to switch between the TV channel you are currently watching and the one you have watched before that.

- 1 Use »1...0« or »P+«, »P-« to select the desired channel.
- 2 Use »1...0« or »P+«, »P-« to change the channels.
- 3 Press »BACK « to return to the previous channel.

# FUNCTIONING OF THE TV - BASIC FUNCTIONS\_\_

## Changing the picture format

The television automatically switches to the 16:9 format if this format is detected via the Euro-AV socket.

- 1 Select the picture format with »«. The selected picture format, for example »16:9«, appears on the screen.
  - You can choose between the following picture formats:

### »Auto« format

The picture format is automatically switched to »16:9« for 16:9 programmes.

The picture format is automatically switched to »4:3« for 4:3 programmes.

### »16:9« format

During programmes in 4:3 format, the picture is stretched horizontally if »16:9« is selected.

The picture geometry is stretched horizontally.

With actual 16:9 signal sources (from a set-top box on the Euro-AV socket) the picture fills the screen completely and with the correct geometry.

### »4:3« format

The picture is shown in 4:3 format.

### »Zoom1« format

Enlarges the picture once, being focused on the centre.

### »Zoom2« format

Enlarges the picture twice, being focused on the centre.

## Electronic TV guide

The electronic 7 Day TV Guide offers an overview of all programmes that will be broadcasted in the next week (for digital channels only).

- 1 Press »**GUIDE**« to see programme information.

### Notes:

- Not all channels provide a detailed TV guide.
  - Many broadcasters supply the daily programme but no detailed descriptions.
  - There are broadcasters which do not provide any information at all.
- 2 Select the television channel with »**V**« or »**^**«.  
- The daily broadcast of the selected channel is displayed.
  - 3 Press »**>**« to switch to today's broadcasts.

### Notes:

- You can open and close the detailed programme information with »**?**«.
  - Press »**•••**« (green) to add a reminder for the selected programme. Press »**•••**« (green) consecutively to select the reminder period.
- 4 Press »**V**« to select information on the next broadcasts and press »**^**« to return to the information for the current broadcasts.
  - 5 Press »**•••••**« (blue) to select the next days and press »**•••••**« (yellow) to return to today.
  - 6 Switch back to the channel selection by pressing »**<**«.
  - 7 Press »**MENU**« to quit the electronic 7 Day TV Guide.

# TELETEXT MODE

---

## Text mode

- 1 Press »**TXT**« to switch to the Teletext mode.
- 2 You can select teletext pages directly with »**1...0**«. To return to page 100, press »**?**«.
- 2 Press »**▼**« to scroll back one page.
- 3 Press »**▲**« to scroll forward one page.

### Note:

- At the bottom of the screen, you will see an information line consisting of a red, green and, depending on the channel, yellow and blue text field. Your remote control has buttons with the corresponding colours. Select the pages directly using these buttons.
- 4 Press »**TXT**« to exit the Teletext mode.

## Additional functions

### Enlarging character size

If you have difficulty reading the text on the screen, you can double the character size.

- 1 To enlarge the character size of a teletext page, press »**|◀**« repeatedly.

### Page stop

A multiple page may contain several sub-pages, which are automatically scrolled by the transmitting station.

- 1 Stop the sub-pages with »**◀◀**«.
- 2 Press »**◀◀**« to quit the function.

### Calling up the next sub-page directly

If the selected teletext page contains further pages, the number of the current sub-page as well as the total number of pages is displayed.

- 1 Press »**◀**« or »**▶**« to select a subpage.

### Reveal answer

Certain teletext pages contain "hidden answers" or information which can be called up.

- 1 Press »**▶▶**« to display the information.
- 2 Press »**▶▶**« to hide the information.

## The file formats

Your television can be operated via the USB input with the following file formats:

### **Video data**

Video compression / decompression (codec) is intended for decreasing the storage area without sacrificing the picture quality.

Your TV supports video data compressed with XVID, H.264/MPEG-4 AVC(L4.1, Ref. Frames:4), MPEG-4, MPEG-2, MPEG-1, MJPEG, MOV standards.

File extensions that the device supports: ".avi", ".mkv", ".mp4", ".ts", ".mov", ".mpg", ".dat", ".vob". Format (codec) information is embedded within the file content and may differ depending on the file extension. ".avi", ".mkv" or ".divx" files containing divx codec within are not played.

In addition to video data, these files also contain audio data compressed and "packaged" by using MP3.

### **Audio data**

Your television can play audio data coded with MP3 standards.

MP3 stands for MPEG-1 Volume Level 3 and is based on the MPEG-1 standard developed by MPEG (Motion Picture Expert Group).

These formats enable audio files to be saved on storage devices with a sound quality similar to that of a CD.

File extensions supported by the device: ".mp3", ".m4a", ".m4a"

MP3 files can be organised into folders and subfolders similar to the files on a computer.

### **Picture data**

Your television can display picture data in JPEG, PNG and BMP formats.

JPEG stands for Joint Picture Experts Group. This process is intended to compress picture files.

PNG and BMP standards are designed to compress picture data without any losses.

Picture files can be saved onto a data medium along with other file types.

Such files can be organised as folders and subfolders.

## Connecting external data media

It is advised to put the television on stand-by mode before connecting the External Data medium. Connect the device and then switch the television on again.

Before disconnecting the data medium, the television must first be switched to standby, otherwise files can be damaged.

### Note:

- If you are using a power cable for the external hard disk that you have connected to the »USB« interface, then the power cable of the external hard disk must also be unplugged when the TV is turned off.
- You must not disconnect the USB Device from the TV while a file on the USB Device is being read by the TV.
- A bi-directional data transfer as defined for ITE (Information Technology Equipment) devices in EN 55022/EN 55024 is not possible.
- USB transfer is not an operating mode in itself. It is only an additional function.

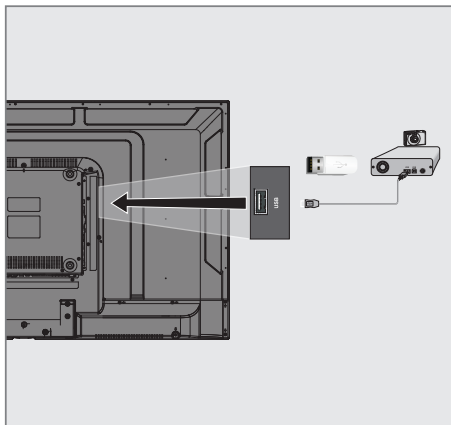

- 1 Connect the »USB« interface of the television and the corresponding socket on the data device (external hard disk, digital camera, card reader or MP3 player) using a USB cable.

or

plug the memory stick into the »USB« USB interface of the television.

## The file browser

The file browser displays the video, audio and picture data that the external data medium provides.

If a data medium contains different file formats, you can deactivate data (Video file, Audio file, Picture file) you do not need for the playback using a filter function.

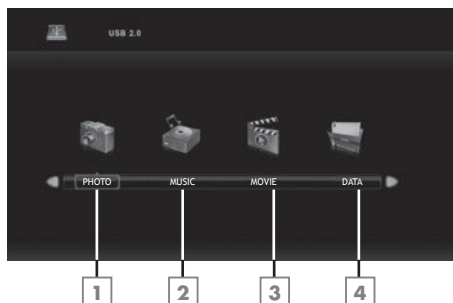

### The main menu of the file browser

- 1 Photo data format.
- 2 Music data format.
- 3 Movie data format.
- 4 Text data format.

## Playback – Basic functions

- 1 Press **»[ ]«** to select the data media and select **»USB«** with **»V«** or **»^«** and select **»OK«** to confirm.
  - The data media file browser will be displayed on the screen.
- 2 Select the format (Video file, Audio file, Image file, Text file) with **»<«** or **»>«**.
- 3 Select file overview with **»OK«**.
- 1 Select the external data media using **»<«** or **»>«** and confirm your selection with **»OK«**.
  - Data media index list appears.
- 2 Press **»V«**, **»^«**, **»<«** or **»>«** to select the desired file and press **»▶«** to start playing.
- 3 Press **»||«** to pause playback.
- 4 Press **»▶«** to resume playback.
- 5 Press **»■«** to end playback.
  - The file browser appears.

### Notes:

- Press **»EXIT«** if you want to return to the upper folder.
- It is possible that some files that are supported in USB mode do not operate due to some problems that may arise depending on how such files are created (compression) although they contain the supported file extension.
- If there are more than one audio sources (audio stream) in the video files that are being played, then you can switch between the audio sources with **»[ ]«** while the file is played in full screen mode.

## Additional playback functions

Depending on the file formats used, the following additional functions are possible.

### Selecting a track or picture in steps (SKIP)

- 1 During playback, select the next track/picture you want with »►|«.
- 2 Select the previous track/picture with »|◄«.
  - Playback begins with the track or picture you selected.

### Searching forward

(only video and audio files)

You can select different speeds (2x, 4x, 8x and 16x forwards or backwards).

- 1 Select the playback speed during playback by pressing »◄◄« or »►►« buttons.
- 2 Press »►|« to resume playback.

### Move to desired time

(only video files)

- 1 Press »?« during playback.
  - The control buttons will be displayed.
- 2 Press »◄« or »►« to select »Goto Time« and press »OK«.
- 3 Enter the time with »1...0« buttons and press »OK«.

### Selecting aspect ratio

(only video files)

- 1 Press »?« during playback.
  - The control buttons will be displayed.
- 2 Press »◄« or »►« to select the »Aspect Ratio« and then press »OK« repeatedly, set the picture ratio as »4:3«, »16:9«, »Zoom1«, »Zoom2« or »Auto«.

### Turn the picture display

(only picture files)

The pictures can be rotated by 90°.

- 1 During playback, press »?« to rotate the pictures by 90°.
  - The control buttons will be displayed.
- 2 Press »◄« or »►« to select »Rotate« and then press »OK« repeatedly, the picture will rotate by 90° each time you press.

### Repeat functions

Options:

- »Repeat 1«, the selected track is repeated once;
- »Repeat All«, all tracks are played repeatedly.
- »RepeatNone«, tracks are not repeated.

- 1 Press »DISPLAY« during playback.
  - The control buttons will be displayed.
- 2 Press »◄« or »►« to select »Repeat« and then press »OK« repeatedly to change the function again.



# LANGUAGE SETTINGS

- 1 Press »MENU« to open the menu.
- 2 Select the »SETUP« menu using »◀« or »▶« and confirm your selection with »OK«.  
– The »SETUP« menu is now enabled.

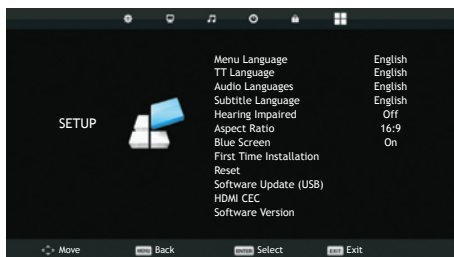

## Note:

- Additional operations are explained in the following sections.

## Changing the menu language

- 1 Press »▼« or »▲« to select the »Menu Language« and confirm with »OK«.  
– The Language selection menu is displayed.
- 2 Select the language with »▼«, »▲«, »◀« or »▶« and confirm your selection with »OK«.
- 3 Press »EXIT« to finish setting.

## Changing the Teletext language

- 1 Press »▼« or »▲« to select the »TT Language« and confirm with »OK«.  
– TT Language selection menu will be displayed.
- 2 Select the language with »▼« or »▲« and confirm your selection with »OK«.
- 3 Press »EXIT« to finish setting.

## Changing the audio language

(only for digital television channels)

You can assign primary and secondary audio languages.

- 1 Press »▼« or »▲« to select the »Audio Language« and confirm with »OK«.  
– The Audio Languages selection menu will be displayed.
- 2 From »Audio Languages«, select »Primary« with »◀« or »▶« and select the primary audio language with »▼«, »▲« or »◀«, »▶«.
- 3 Select »Audio Languages« with »MENU« and select »Secondary« with »◀« or »▶«.
- 4 Select the secondary audio language using »▼«, »▲« or »◀«, »▶« and confirm your selection with »OK«.
- 5 Press »EXIT« to finish the setting.

## Changing the subtitle language

(only for digital television channels)

You can disable subtitles, select subtitle language and assign a secondary subtitle language.

- 1 Press »▼« or »▲« to select the »Subtitle Language« and confirm with »OK«.  
– The Subtitle Language selection menu will be displayed.
- 2 From »Subtitle Language«, select »Primary« with »◀« or »▶« and select the primary audio language with »▼«, »▲« or »◀«, »▶«.
- 3 Select »Subtitle Language« with »MENU« and select »Secondary« with »◀« or »▶«.
- 4 Select the secondary subtitle language using »▼«, »▲« or »◀«, »▶« and confirm your selection with »OK«.
- 5 Press »EXIT« to finish the setting.

# TIME SETTINGS

- 1 Press »MENU« to open the menu.
- 2 Select the »TIME« menu using »◀« or »▶« and confirm your selection with »OK«.  
- The »TIME« menu is now enabled.



## Note:

- Additional operations are explained in the following sections.

## Time

Current time and date information is retrieved automatically from the broadcast.

## Time Zone

- 1 Select »Time Zone« using »▼« or »▲« and confirm with »OK«.
- 2 Select the time zone using »▼«, »▲«, »◀« or »▶« and confirm your selection with »OK«.
- 3 Press »EXIT« to finish setting.

## Sleep timer

You can enter an off time for the television to switch off. After this time has elapsed, the television switches to standby mode.

- 1 Select »Sleep Timer« using »▼« or »▲« and confirm with »OK«.
- 2 Select the sleep timer using »▼« or »▲« and confirm with »OK«.

## Note:

- Disable the function with »▼« or »▲« by switching it to »Off« position.
- 3 Press »EXIT« to finish the setting.

## Auto standby

This function will switch the television to standby mode in 4 hours if the television does not receive any picture signals for 5 minutes or according to European regulations, if no key on the keyboard of the TV or the remote control is pressed.

- 1 Select »Auto Standby« using »▼« or »▲« and confirm with »OK«.
- 2 Select the sleep timer using »▼« or »▲« and confirm with »OK«.

## Note:

- You can disable the function with »▼« or »▲« by switching it to »Off« position.
- 3 Press »EXIT« to finish the setting.

## Sleep timer for OSD menu

This function allows you to specify the time during which the OSD menu will remain on the screen.

- 1 Select »Sleep timer for OSD menu« using »▼« or »▲« and confirm with »OK«.
- 2 Select the sleep timer using »▼« or »▲« and confirm with »OK«.
- 3 Press »EXIT« to finish the setting.

# LOCK SETTINGS

- 1 Press »MENU« to open the menu.
- 2 Select the »LOCK« menu using »◀« or »▶« and confirm your selection with »OK«.
  - The »LOCK« menu is now enabled.



## Note:

- Additional operations are explained in the following sections.

## Menu Lock

Using this function, you can lock »Auto. Tuning«, »Programme Edit« and »Dish Antenna Setup« so that they can only be accessed by entering a PIN code.

- 1 In the »LOCK« menu, press »OK« and enter the PIN code »0000« using »1...0« buttons on the displayed password screen.
  - The menu options are now enabled.
- 2 Select »System Lock« with »▼« or »▲« and confirm with »◀« or »▶«.
- 3 Activate the lock with »◀« or »▶«.

## Note:

- Select »Off« with »◀« or »▶« to disable the menu lock.
- 4 Press »EXIT« to finish the setting.

## Changing the PIN code

Instead of the default code »0000«, you can enter a personal code.

Please take note of your personal code.

Press »▼« or »▲« to select the »Set Password« and confirm with »OK«.

- 5 Use »1...0« to enter your current four-digit PIN code.
  - »Enter New Password« is now enabled.
- 6 Use »1...0« to enter your new four-digit personal PIN code.
- 7 Use »1...0« to enter your personal PIN code again.
- 8 Press »EXIT« to finish the setting.

## Blocking a television channel

You can block individual television channels which are not suitable for children using a personal PIN code.

## Note:

- The »Menu Lock« must be »On« for the programme lock to function.
- 1 In the »LOCK« menu, press »OK« and enter the PIN code »0000« using »1...0« buttons on the displayed password screen.
    - The menu options are now enabled.
  - 2 Select »Channel Lock« with »▼« or »▲« and confirm with »OK«.
    - »Channel Lock« menu will be displayed.
  - 3 Select the channel you want to block with »▲« or »▼« and press »••« (green).
    - The channel will be marked.
  - 4 Press »EXIT« to finish the setting.

# LOCK SETTINGS

---

## Watching a blocked television channel

You can watch a TV channel blocked with PIN code by selecting the TV channel and entering the PIN code.

- 1 Select the blocked channel with »1...0« or »P+«, »P-«.
- 2 Enter the PIN code »0000« using »1...0« buttons on the displayed password screen.  
- Blocked channel can be viewed.

### Note:

- Channel will be blocked again when you change the channel.

## Parental Guidance

There are movies which contain contents or scenes which are not suitable for children.

Certain programmes contain information which identifies these contents or scenes and have been given an access level from 3 to 18. You can select one of the access levels and thus authorise the playback.

- 1 In the »LOCK« menu, press »OK« and enter the PIN code »0000« using »1...0« buttons on the displayed password screen.  
- The menu options are now enabled.
- 2 Select »Parental Guidance« with »V« or »^« and confirm with »<« or »>«.
- 3 Select the access level with »V« or »^«.
- 4 Press »EXIT« to finish the setting.

## Locking the control panel (parental control)

If the control panel lock is activated, the buttons on the television do not work.

- 1 In the »LOCK« menu, press »OK« and enter the PIN code »0000« using »1...0« buttons on the displayed password screen.
- 2 Use »V« or »^« to select »Key Lock« and use »<« or »>« to enable (On) or disable (Off) the key lock.
- 3 Press »EXIT« to finish the setting.

# OTHER SETTINGS

- 1 Press »MENU« to open the menu.
- 2 Select the »SETUP« menu using »◀« or »▶« and confirm your selection with »OK«.
  - The »SETUP« menu is now enabled.



## Note:

- Additional operations are explained in the following sections.

## Software update (USB)

- 1 Insert the memory stick in the **USB** socket at the side of the TV.
- 2 From the »Setup« menu, select »Software Update (USB)« with »▼« or »▲« and confirm with »OK«. Press »◀« on the displayed warning screen.
  - The software in the USB memory stick is installed.

## Resetting the television to its original state

This function enables you to delete the channel lists and all custom settings.

- 1 From the »Setup« menu, select »Reset« line with »▼« or »▲« and confirm with »OK«.
- 2 Press »◀« on the warning screen.
  - The »First Time Installation« menu will be displayed after a short while.

# USING EXTERNAL DEVICES

## HDMI CEC

Your television is equipped with HDMI CEC feature. This feature utilizes CEC (Consumer Electronics Control) protocol. CEC allows you to make an HDMI connection between your TV and DVD player, STB or video recorder and control such equipment with the remote control of the television. This feature must be supported by the device you connect as well.

Your television supports the following functions. For detailed information about this function, read the user manual of the external device.

## HDMI CEC connection functions of the television

### Switching on the external device from standby mode

If you switch on your external device (e.g. DVD player) from standby mode, your television will also be switched on from standby and switch to the HDMI source that your television is connected to.

Depending on the features of the external device (e.g. AV receiver) can start and your television can stay on stand-by mode.

### Selecting the HDMI source from the television

When you switch on your external device (e.g. DVD player), your television will switch to the HDMI source that the external device is connected to (your television must be on).

### Selecting the menu language

When you select the menu language from your television menu language of the external device will change as well. (If your DVD player supports)

### Switching off the device from standby mode

After switching your television to standby, your external device (e.g. DVD player) will also switch to standby if it is on.

HDMI CEC is always active on your television.

Refer to the user manual of your external device to learn how to activate this feature on it.

### Searching and selecting the active external device

- 1 Press **»MENU«** to open the menu.
- 2 Select the **»SETUP«** menu using **»◀«** or **»▶«** and confirm your selection with **»OK«**.
  - The **»SETUP«** menu is now enabled.

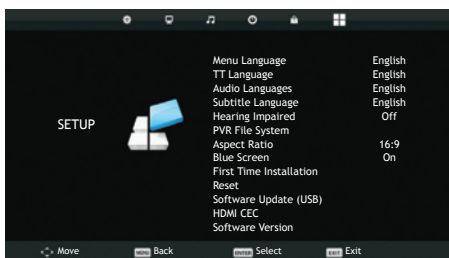

- 3 Press **»▼«** or **»▲«** to select **»HDMI CEC«** and press **»OK«** to confirm.
- 4 Use **»◀«** or **»▶«** to switch **»CEC Control«** to **»On«** position.
  - The **»HDMI CEC«** menu is now enabled.
- 5 Press **»▼«** or **»▲«** to select the **»Device List«** and press **»OK«** to confirm.
  - Existing devices will be searched and displayed in the menu
- 6 Press **»▼«** or **»▲«** to select the device you want to control and press **»OK«** to confirm.
- 7 Press **»EXIT«** to end searching.

# USING EXTERNAL DEVICES

## HDMI™

**HIGH-DEFINITION MULTIMEDIA INTERFACE**  
HDMI, the HDMI logo and High-Definition Multimedia Interface are trademarks or registered trademarks of HDMI Licensing LLC.

### High definition – HD ready

Your television can playback high-definition television signals (HDTV).

You can connect the input sources (HDTV set-top box or High Definition DVD player) to the »HDMI« socket (digital HDTV signal).

This ensures that you can view digital HDTV programmes, even if they are copy-protected (HDCP High Bandwidth Digital Content Protection).

### Connection options

- Which television socket(s) you connect your external devices to depends on the sockets the external device is equipped with and the signals which are available.
- Note that with many external devices the resolution of the video signal must be adapted to the input sockets on the television (check the external device's instruction manual). You can find out which values you need to set by referring to the guidelines in the section about connection options.
- Do not connect any other equipment while the device is switched on. Switch off the other equipment as well before connecting it.
- Only plug the device into the mains socket after you have connected external devices.

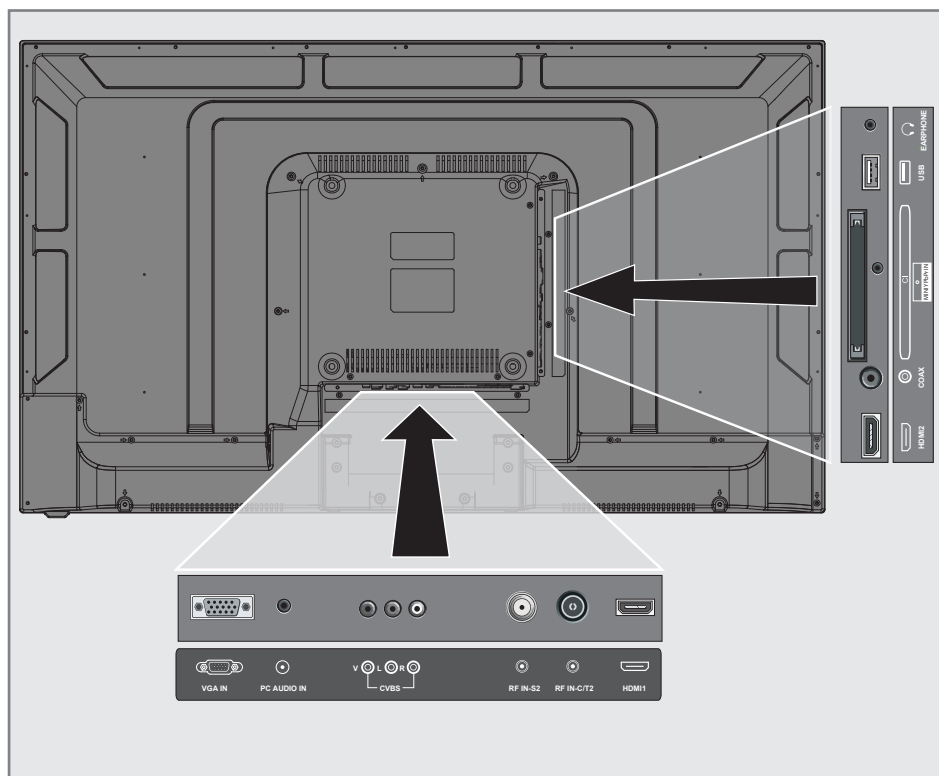

# USING EXTERNAL DEVICES

## Connecting an external device

### With a digital audio/video signal

- Suitable devices: Digital satellite receiver, Playstation, BluRay player, DVD player/recorder, set-top box, notebook, PCs.
  - Video signal: digital image; definition: standard 576p; HDTV 720p, 1080i, 1080p.
  - Audio signal: digital audio (stereo, multi-channel compression, uncompressed).
  - »HDMI1« or »HDMI2« channel position.
- 1 Connect the »HDMI1« or »HDMI2« socket on the television and the corresponding HDMI socket on the external device using a standard HDMI cable (digital video and audio signal).

### With an analogue video signal (progressive)

- Suitable devices: DVD player/recorder, games console.
  - Video signal: YUV; resolution: standard 576p; HDTV 720p, 1080i, 1080p.
  - Audio signal: stereo, analog.
  - »Component« channel position.
- 1 Connect the »MINI YPbPr IN« sockets on the television and the corresponding sockets on the external device (with the converter cable) using cinch cables (video signal).
  - 2 Connect the »MINI YPbPr IN« sockets on the television and the corresponding sockets on the external device (with the converter cable) using cinch cables (audio signal).

### Using the Euro/AV socket

- Suitable devices: Digital satellite receiver, DVD player/recorder, set-top box, games console, video recorder, decoder.
  - Video signal: RGB.
  - Audio signal: stereo, analog.
  - »AV« channel position.
- 1 Connect the »CVBS V/L/R« inlet on the television with the corresponding outlet on the external device using the EURO/AV cable (video and audio signal).

### Connecting a DVD recorder, DVD player, video recorder or set-top box

- 1 Switch on the video recorder, DVD player or set-top box and select the function you wish to use.
- 2 Press »«, use »**▲**« or »**▼**« to select the input signal »AV«, »Component«, »PC«, »HDMI1« and »HDMI2« confirm with »**OK**«.

## Headphones

### Connecting headphones

- 1 Plug the headphone jack (3.5 mm jack plug) into the headphone socket of the television.

#### Note:

- Prolonged listening at loud volumes with the headphones can damage your hearing.

## Hi-fi system

### Connecting digital multi-channel amplifier/AV receiver

- 1 Connect the »**COAXIAL OUT**« socket on the television to the corresponding socket on the AV receiver using a standard coaxial cable (digital audio signal).

### Adjusting the audio format

You can select whether the audio signal emitted from the »**COAX**« socket is in PCM data format or in AC3 format.

- 1 Press »**MENU**« to open the menu.
- 2 Select the »**SOUND**« menu using »**◀**« or »**▶**« and confirm your selection with »**OK**«. – The »**SOUND**« menu is not enabled.
- 3 Select »**SPDIF Mode**« with »**▼**« and select the signal type (»**PCM**« or »**Auto**«) with »**◀**« or »**▶**«.
- 4 Press »**EXIT**« to finish the setting.

Dolby, Dolby Audio double D symbol are trademarks of Dolby Laboratories.



# PC MONITOR MODE

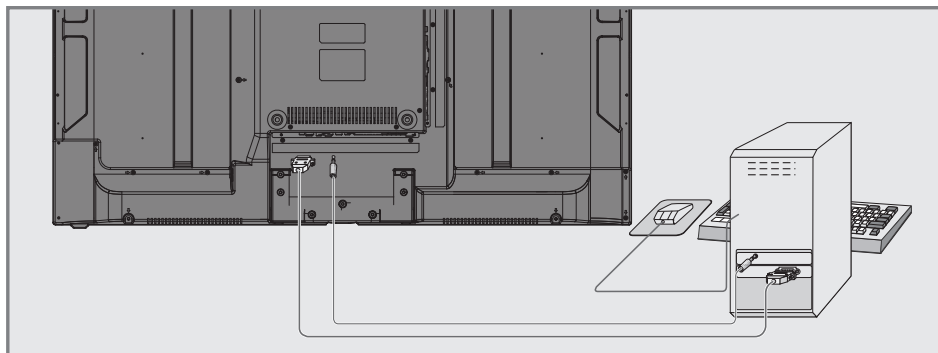

## Connecting a PC

- 1 Connect the socket »**VGA IN**« on the television to the corresponding socket on the PC using a VGA cable.
- 2 Connect the socket »**AUDIO PC IN**« on the television to the corresponding socket on the PC using a cinch cable (audio signal).

### Note:

- Adjust your PC to the monitor (for example, picture resolution 1280 x 768, picture frequency 60 Hz).

## Selecting the channel position for the PC

Press »**INPUT**«, select »PC« with »**V**«, »**A**« or »**◀**«, »**▶**« and confirm with »**OK**«.

# OPERATION WITH COMMON INTERFACE

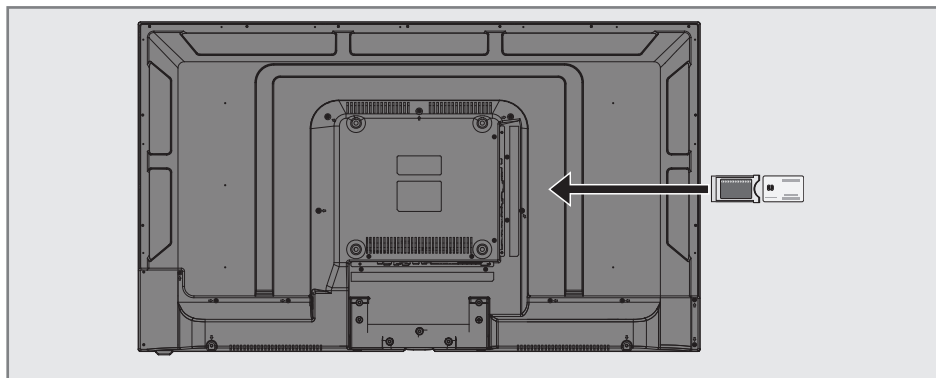

## What is Common Interface?

- Common Interface (CI) is an interface for DVB receivers.
- Scrambled channels can only be viewed with a CA module suitable for the encoding system and the corresponding smart card.
- The television set is equipped with a Common Interface slot into which CA modules from various providers can be inserted.
- You can insert the provider's smart card into the CA module in order to enable the scramble channels you want to see.

## Inserting the CA module

### Note:

- Switch off the appliance before inserting the CA module in the »CI« slot.
- 1 Insert the smart card into the CA module.
  - 2 Insert the CA module with the smart card into the »CI« slot on the television.

### Note:

- When you insert a CA module into the CI slot on the television for the first time, wait a few moments until the television has registered the CA module.

## Access control for CA module and smart cards

- 1 Press »MENU« to open the menu.
- 2 Press »◀« or »▶« to select the »Channel« menu and press »OK« to confirm.  
– »CHANNEL« menu is now enabled.
- 3 Press »▼« or »▲« to select »CI Information« and confirm with »OK«.

### Notes:







- This menu give operating instructions and – after you enter your PIN code – access to channels of the PAY-TV provider.
  - Other settings are described in the manuals for your CA module and smart card.
  - CAM is not supported in some countries and regions. Please consult your authorised dealer.
- 4 Press »EXIT« to finish the settings.



# DETAILED CHANNEL SETTINGS







## Searching for all digital television channels from a satellite automatically





New satellite channels are added or satellite data is changed frequently. Therefore, we recommend you to run auto search function from time to time.

All transponders are scanned for new channels.





- 1 Open the »Input Source« menu with »«.
- 2 Select »SATELLITE« using »« or »« and confirm with »OK«.
- 3 Press »MENU« to open the menu.
- 4 Press »« or »« to select the »CHANNEL« menu and press »OK« to confirm.  
- »CHANNEL« menu is now enabled.
- 5 Select »Auto Tuning« with »« or »« and confirm with »OK«.  
- »Tuning Setup« menu will be displayed.

Tuning Setup	
Country	◀ Turkey ▶
Satellite	◀ TURKSA... ▶
Scan Mode	◀ Default ▶
Channel Type	◀ Free+Scramble ▶
Service Type	◀ All ▶
 Back	 Start

- 6 In the »Tuning Setup« menu, select the country from »Country« using »« or »«.
- 7 Select the »Satellite« option using »« or »« and select the satellite you want to search with »« or »«.

- 8 Select »Channel Type« using »« or »«. Press »« or »« to select whether you want to search for only free digital television channels (Free), only scrambled digital television channels (Scramble) or the both (Free+Scramble).

### Note:

- If some of the frequencies are not stored completely due the changes in satellite parameters made by the broadcaster, it is recommended to set the »Network Settings« option to »Network«.
- 9 Select »Service Type« using »« or »«. Press »« or »« to select whether you want to search for only television channels (DTV), only radio (Radio) or the both (All).
  - 10 Press »OK« to start the search.
    - The »Channel Tuning« menu will be displayed and the search for TV channels will start.
    - Search may take several minutes depending on the number of television channels received.

### Note:

- The search can be ended prematurely with »MENU«.
- 11 Press »MENU« to end the setting.

# DETAILED CHANNEL SETTINGS

## Searching for digital television channels from a satellite manually

If a certain channel cannot be found with automatic search, you can search it manually by manual search function. You must enter all parameters of the channel correctly. You can obtain the current transponder information from teletext page, satellite TV magazines or Internet or you can search by selecting from the transponder list that already exists in the TV.

- 1 Press **»MENU«** to open the menu.
- 2 Press **»◀«** or **»▶«** to select the **»CHANNEL«** menu and press **»OK«** to confirm.  
- **»CHANNEL«** menu is now enabled.
- 3 Select **»Dish Antenna Setup«** using **»▼«** or **»▲«** and confirm with **»OK«**.  
- **»Dish Antenna Setup«** menu will be displayed.
- 4 Display the transponder list with **»GUIDE«**.
- 5 Press **»♦♦♦«** (yellow) to add the transponder in which you want to search manually.
- 6 Press **»▼«** or **»▲«** to select the required items and press **»OK«** to confirm.

### Frequency

Enter the 5-digit channel frequency using **»1...0«**.

### Symbol Rate (Ks/s)

Enter the channel's symbol rate in 5 digits using **»1...0«** buttons.

### Polarity

Use **»◀«** or **»▶«** to select the channel polarity as **»V«** or **»H«**.

- 7 Select the transponder you have added using **»▼«** or **»▲«** and confirm with **»OK«**.  
- Transponder is marked with **»✓«**
- 8 Press **»♦♦♦♦«** (blue).  
- **»Channel Search«** menu will be displayed.

- 9 Select **»Channel Type«** using **»▼«** or **»▲«**. Press **»◀«** or **»▶«** to select whether you want to search for only free digital television channels (Free), only scrambled digital television channels (Scramble) or the both (Free+Scramble).

### Note:

- If some of the frequencies are not stored completely due the changes in satellite parameters made by the broadcaster, it is recommended to set the **»Network Settings«** option to **»Network«**.

- 10 Select **»Service Type«** using **»▼«** or **»▲«**. Press **»◀«** or **»▶«** to select whether you want to search for only television channels (DTV), only radio (Radio) or the both (All).
- 11 Press **»OK«** to start the search.
  - The **»Channel Tuning«** menu will be displayed and the search for TV channels will start.
  - Search may take several minutes depending on the number of television channels received.

### Note:

- The search can be ended prematurely with **»MENU«**.

- 12 Press **»MENU«** to end the setting.

# DETAILED CHANNEL SETTINGS

## LNB Settings

- 1 Press »MENU« to open the menu.
- 2 Press »◀« or »▶« to select the »CHANNEL« menu and press »OK« to confirm.  
- »CHANNEL« menu is now enabled.
- 3 Select »Dish Antenna Setup« using »▼« or »▲« and confirm with »OK«.  
- »Dish Antenna Setup« menu will be displayed.
- 4 Select the required items with »▼«, »▲«, »◀«, »▶« or »OK«.

### Satellite

Select the satellite from which you want to receive digital stations from the list with »▼« or »▲« and confirm with »OK«.

### Transponder

Press »GUIDE« to switch to the transponder list. You can select a transponder from the list, change or delete the current transponder or add a new transponder.

### LNB Type

Select the LNB type with »▼« or »▲« and confirm with »OK«.

#### Note:

- Select 09750/10600 from the list if you use universal LNB.

### LNB Power

Select the LNB power as »Off« or as »13/18V«, »13V«, »18V« according to the LNB type with »◀« or »▶«.

### DiSEqC 1.0

DiSEqC 1.0 switch allows for receiving from maximum 4 satellites at the same time. In »LNB selection«, select »LNB1«, »LNB2«, »LNB3« or »LNB4« for the satellite that corresponds to the relevant DiSEqC positions with »◀« or »▶«.

### DiSEqC 1.1

DiSEqC 1.1 switch allows for receiving from maximum sixteen satellites at the same time. In »LNB Selection«, make selections between »LNB1« and »LNB16« for the satellite that corresponds to the relevant DiSEqC position with »◀« or »▶«.

### Motor

Your television supports DiSEqC 1.2 motorized satellite systems. This feature allows to control the satellite through your television.

In »Motor«, make the selections for the relevant motorized satellite system selections with »◀« or »▶«.

#### Note:

- Information about motorized satellite antenna settings are given under the title "Motorized Antenna Settings (DiSEqC 1.2)".

- 5 Press »EXIT« to end setting.

# DETAILED CHANNEL SETTINGS

---

## Motorized antenna setup (DiSEqC 1.2)

### Note:

- The LNB settings explained in the section below requires expertise in satellite systems. Contact your authorized dealer about this matter.

Your television supports DiSEqC 1.2 motorized satellite systems. This feature allows to control the satellite through your television.

Adjust the satellite antenna position according to each satellite. These settings can be stored and the antenna can be moved to a preset position.

- 1 Press **»MENU«** to open the menu.
- 2 Press **»◀«** or **»▶«** to select the **»CHANNEL«** menu and press **»OK«** to confirm.
  - **»CHANNEL«** menu is now enabled.
- 3 Select **»Dish Antenna Setup«** using **»▼«** or **»▲«** and confirm with **»OK«**.
  - **»Dish Antenna Setup«** menu will be displayed.
- 4 Press **»▶«** and then press **»▼«** or **»▲«** to select **»Motor«**.
- 5 Select **»DiSEqC 1.2«** with **»◀«** or **»▶«**.
- 6 Press **»•«** (red) for Limit Settings and press **»••«** (yellow) for Position Settings.

## Limit Setting







- **»Move Motor«**: Move the antenna in the east or west direction with **»◀«** or **»▶«**.
- **»Move Step«**: Move the antenna in the east or west direction step by step with **»◀«** or **»▶«**.
- **»Set West Limit«**: Sets the limit that the antenna can move at most in the west direction.
- **»Set East Limit«**: Sets the limit that the antenna can move at most in the east direction.
- **»Goto Reference«**: Rotates the antenna to the set reference point.
- **»Disable Limit«**: Disables the set east and west limits.



## Set Position

- **»Move Motor«**: Move the antenna in the east or west direction with **»◀«** or **»▶«**.
  - **»Move Step«**: Move the antenna in the east or west direction step by step with **»◀«** or **»▶«**.
  - **»Store Position«**: Stores the position of the antenna.
  - **»Goto Position«**: Rotates the antenna to the stored position.
  - **»Goto Reference«**: Rotates the antenna to the set reference point.
- 7 Press **»EXIT«** to finish the setting.









# DETAILED CHANNEL SETTINGS

## Searching for digital television channels through cable automatically

- 1 Open the »Input Source« menu with »«.
- 2 Select »DTV« using »« or »« and confirm with »OK«.
- 3 Press »MENU« to open the menu.
- 4 Press »« or »« to select the »CHANNEL« menu and press »OK« to confirm.
  - »CHANNEL« menu is now enabled.
- 5 Select »Auto Tuning« with »« or »« and confirm with »OK«.
  - »Tuning Setup« menu will be displayed.

Tuning Setup	
Country	Turkey
Tune Type	DTV
Scan type	DVB-C
Scan Type	Full
Network ID	Auto
Frequency	Auto
Symbol Rate	Auto
 Back	 Start

- 6 Go to »Scan Type« with »« or »« and select »DVB-C« with »« or »«.
- 7 Go to »Country« with »« or »« and select the country with »« or »«.

- 8 Select »Tune Type« with »« or »« and select »DTV« with »« or »«.
- 9 Select »Scan Type« using »« or »« and select (»Network Scan« or »Full«) with »« or »«.
  - »Network Scan« scanning function sets the channels according to the cable operator information in the broadcasting signal.
  - »Full« scan function scans the entire frequency range selected. With this search option, search can take a long time. This search type is recommended. Some cable providers do not support »Quick« scan.

### Note:

- You can speed up the search. To do this, frequency and network ID information are required. You can obtain such information from your cable provider or find them in Internet forums.

- 10 Press »OK« to start the search.
  - The »Channel Tuning« menu will be displayed and the search for TV channels will start.
  - Search may take several minutes depending on the number of television channels received.







### Note:

- The search can be aborted with »EXIT«.









- 11 Press »EXIT« to end searching.

# DETAILED CHANNEL SETTINGS







## Searching for digital television channels through cable manually

















- 1 Open the »Input Source« menu with »«.
- 2 Select »DTV« using »« or »« and confirm with »**OK**«.
- 3 Press »**MENU**« to open the menu.
- 4 Press »« or »« to select the »CHANNEL« menu and press »**OK**« to confirm.  
- »CHANNEL« menu is now enabled.
- 5 Select »DTV Manual Tuning« using »« or »« and confirm with »**OK**«.  
- »DTV Manual Tuning« menu will be displayed.







DTV Manual Tuning		
Frequency	770000 KHZ	
Symbol (ks/s)	6900	
QAM Type	QAM 16	
Bad	Normal	Good
=====		

- 6 Select »Frequency« using »« or »« and enter the frequency with »1...0«.
- 7 Select »Symbol (ks/s)« using »« or »« and enter the symbol rate with »1...0«.
- 8 Select »QAM Type« with »« or »« and select the QAM type with »« or »«.
- 9 Press »**OK**« to start the search.

## Searching for digital television channels through aerial automatically

- 1 Open the »Input Source« menu with »«.
- 2 Select »DTV« using »« or »« and confirm with »**OK**«.
- 3 Press »**MENU**« to open the menu.
- 4 Press »« or »« to select the »CHANNEL« menu and press »**OK**« to confirm.  
- »CHANNEL« menu is now enabled.
- 5 Select »Auto Tuning« with »« or »« and confirm with »**OK**«.  
- »Tuning Setup« menu will be displayed.

Tuning Setup		
Country		Turkey 
Tune Type		DTV 
Scan type		DVB-T 
Scan Type		Full 
Network ID		Auto 
Frequency		Auto 
Symbol Rate		Auto 
	Back	 Start

- 6 Go to »Scan Type« with »« or »« and select »DVB-T« with »« or »«.
- 7 Go to »Country« with »« or »« and select the country with »« or »«.



# DETAILED CHANNEL SETTINGS

- 8 Select »Tune Type« with »V« or »^« and select »DTV« with »<« or »>«.
  - 9 Press »OK« to start the search.
    - The »Channel Tuning« menu will be displayed and the search for TV channels will start.
    - Search may take several minutes depending on the number of television channels received.
- Note:**
- The search can be aborted with »EXIT«.
- 10 Press »EXIT« to end searching.

## Manual searching for digital television channels with aerial connection

- 1 Open the »Input Source« menu with »>[ ]«.
- 2 Select »DTV« using »V« or »^« and confirm with »OK«.
- 3 Press »MENU« to open the menu.
- 4 Press »<« or »>« to select the »CHANNEL« menu and press »OK« to confirm.
  - »CHANNEL« menu is now enabled.
- 5 Press »V« or »^« to select »DTV Manual Tuning« and press »OK« to confirm.
  - »DTV Manual Tuning« menu will be displayed.

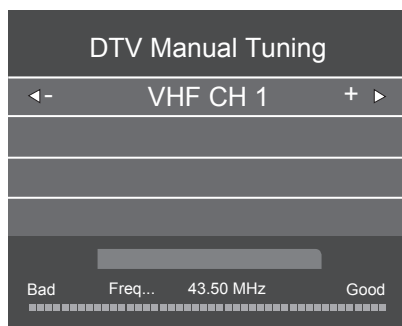

- 6 Select a channel with »<« or »>«.
- 7 Press »OK« to start the search.

# DETAILED CHANNEL SETTINGS

## Tuning analogue television channels

This setting is only necessary if you have not carried out an analogue search during the first time installation.

The television channel can be set directly or using the search.

### Switching the television to analogue channels

#### Note:

- Analog channels can only be selected while »Air« or »Cable« sources are active.

- 1 Open the »Input Source« menu with »«.
- 2 Select »ATV« using »« or »« and confirm with »OK«.





#### Note:

- Additional operations are explained in the following sections.









### Re-tuning all analogue television channels

#### Note:

- Plug the rooftop antenna cable (for analogue television stations) into the **RF IN T2** socket on the television.

- 1 Press »MENU« to open the menu.
- 2 Press »« or »« to select the »CHANNEL« menu and press »OK« to confirm.
  - »CHANNEL« menu is now enabled.
- 3 Select »Auto Tuning« with »« or »« and confirm with »OK«.
  - »Tuning Setup« menu will be displayed.

Tuning Setup		
Country	◀	Turkey ▶
Tune Type	◀	ATV ▶
Scan type	◀	DVB-T ▶
Scan Type	◀	Full ▶
Network ID	◀	Auto ▶
Frequency	◀	Auto ▶
Symbol Rate	◀	Auto ▶
MENU Back ENTER Start		

- 4 Select »Tune Type« with »« or »« and select »ATV« with »« or »«.
- 5 Go to »Country« with »« or »« and select the country with »« or »«.
- 6 Press »OK« to start the search.
  - The »Channel Tuning« menu will be displayed and the search for TV channels will start.
  - Search may take several minutes depending on the number of television channels received.

#### Note:

- The search can be aborted with »EXIT«.
- 7 Press »EXIT« to end searching.

# DETAILED CHANNEL SETTINGS

## Tuning the analogue television channels by entering the channel numbers

- 1 Press »MENU« to open the menu.
- 2 Press »◀« or »▶« to select the »CHANNEL« menu and press »OK« to confirm.  
– »CHANNEL« menu is now enabled.
- 3 Press »▼« or »▲« to select »ATV Manual Tuning« and press »OK« to confirm.  
– »ATV Manual Tuning« menu will be displayed.

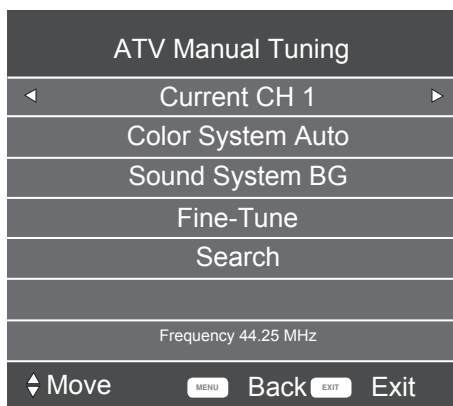

- 4 Select »Current CH« with »▼« or »▲« and press »◀« or »▶« to select preset.
- 5 Select »Color System« with »▼« or »▲«. Press »◀« or »▶« to select »AUTO«, »PAL« or »SECAM«.
- 6 Select »Sound System« with »▼« or »▲«. Press »◀« or »▶« to select »BG«, »I«, »DK« or »L«.
- 7 Select »Search« with »▼« or »▲« and press »◀« or »▶« to start searching.

### Note:

- When fine tuning is required, select »Fine-Tune« with »▼« or »▲« and tune with »◀« or »▶«.

### Note:

- To set other television channels, repeat steps from 4 to 7.

- 8 Press »EXIT« to finish setting.

## Displaying signal information

(only for digital television channels)

- 1 Press »MENU« to open the menu.
- 2 Press »◀« or »▶« to select the »CHANNEL« menu and press »OK« to confirm.  
– »CHANNEL« menu is now enabled.
- 3 Select »Signal Information« using »▼« or »▲« and confirm with »OK«.  
– »SIGNAL INFORMATION« menu will be displayed.

### Notes:

- Signal information changes depending on the current source.
  - The signal level not only depends on your receiver system, but also on the channel which is currently active. Remember this when aligning your antenna using the signal level display.
- 4 Press »EXIT« to finish the screen display.

## Service information for dealers



This product complies with the following European directives and regulations: 2006/95/EC: Electrical equipment directive for use within a certain voltage

range.

2004/108/EC: Directive on electromagnetic suitability.

2009/125/EC: Directive relevant for eco-design for energy using product and related; 278/2009: Regulation regarding eco friendly design requirements regarding energy consumption of uncharged external power sources and average active efficiency (for models with AC/DC adapters); 642/2009 Regulation regarding environmentally-conscious design requirements for TVs.

2010/30/EU: Directive on energy labeling of the products that work on energy and the following; 1062/2010: Regulation on energy labeling of TVs.

2011/65/EU: Directive on limitations on use of certain hazardous materials on electric, electronic domestic and office equipment.

## Environmental warning



This product has been made from high-quality parts and materials which can be re-used and recycled.

Therefore, do not throw the product away with normal household waste at the end of its life. Take it to a collection point for recycling electrical and electronic devices. This is indicated by this symbol on the product, in the operating manual and on the packaging.

Please find out about collection points operated by your local.

Help protect the environment by recycling used products.

## Cleaning the TV set

Pull the power cord out of the mains socket. Clean the appliance with a damp cloth and a mild detergent. Do not use any detergents containing alcohol, spirit, ammonia or scouring agent.

Use a damp, soft cloth to clean the screen. Do not use water with soap or detergent.

## Disposing of the packaging

The packaging materials are dangerous for children. Keep the packaging materials out of the reach of children.

The packaging of the product is manufactured from recyclable materials. Dispose of by classifying in accordance with waste regulations. Do not dispose along with normal household waste.

Maintenance

## Conformity with WEEE Regulations and Disposing of Waste Product

This product does not contain hazardous and prohibited substances specified in the "Regulations for Supervision of Waste Electrical and Electronic Equipment" Published by Turkish Ministry of Environment and Urban Planning. Conforms to the WEEE Regulation. This product has been made from high-quality parts and materials which can be recycled and re-used. Therefore, do not throw the product away with household and other waste at the end of its life. Take it to a collection point for recycling electrical and electronic devices. Contact your local authority for the collection points in your region. Help preserve the nature and natural resources by recycling used products. For the safety of children, cut the power cord before disposal.

## PCB Conformity:

"Does not contain PCB (Poly-chlorinated Biphenyl)."

## Explanation of the symbols which may be present on back side of the television set



Double insulation. Television set doesn't require connection to electrical earth (ground).



Alternating current. The set works only with AC line voltage in your household electricity.



Direct current. The set works only with AC/DC adapter.

# INFORMATION

## Troubleshooting

If the remedies given below do not work, please consult an authorised service. Please bear in mind that malfunctions can also be caused by external devices such as video recorders or satellite receivers.

Problem	Possible cause	Remedy
Screen lit (snow), but no channels	Antenna cable	Is the antenna cable connected?
	No TV channel programmed	Start the channel search
Low picture contrast	Picture settings incorrectly set	Adjust the brightness, contrast or colour setting
	Problem at channel	Test with a different channel
Interference to picture and/or sound	Interference from other devices	Change the position of the device
	Channel tuning	Automatic or manual channel tuning/fine-tune
No colour	Antenna	Have antenna cable or system checked
	Colour intensity at maximum	Turn up the colour
	TV standard setting (if setting option is available)	Select the correct colour standard
	Problem at channel	Test with a different channel
Picture but no sound	Volume set to minimum	Turn up or switch on the volume
	Problem at channel	Test with a different channel
No Teletext or faulty teletext	Television station ( has no teletext) or antenna system	Test another channel for fine-tune and ghosts
	Station signal too weak	Check the antenna system
	No optical connection	Point the remote control at the television set
Remote control does not work	Remote control batteries	Check the batteries, change if necessary
	Operating condition undefined	Switch off the television with the main power button for approximately 2 minutes

### Note:

- This is a Class A product. During operation the device can cause radio interference. In this case the user may have to remedy this. Please contact your specialist dealer.

# GLOSSARY

---

The television may not have all of the specifications below. It may vary by the model of the television.

## **Common Interface**

It is an interface used in DVB receivers. Scrambled channels can only be viewed with a CA module suitable for the encoding system and the corresponding smart card.

## **CEC**

This feature utilizes CEC (Consumer Electronics Control) protocol.

CEC enables external devices that are connected to the HDMI socket with the HDMI cable to be controlled via the remote control.

## **DiSEqC**

DiSEqC (Digital Satellite Equipment Control) is a digital system that ensures that the motorized multiple-LNB satellite systems are controlled.

DiSEqC is required when two or more satellite locations need to be controlled.

## **DVB-C**

DVB-C (Digital Video Broadcasting - Cable) is a type of DVB used for the transmission of radio and television signals through a cable connection.

## **DVB-S/S2**

DVB-S/S2 (Digital Video Broadcasting - Satellite) broadcasts the DVB signals through the satellite.

## **DVB-T/T2**

DVB-T/T2 (Digital Video Broadcasting - Terrestrial) is a type of DVB used for the transmission of radio and television signals through terrestrial channels.

## **HD/Full HD/UHD**

High Definition (HD) TV is a general name for the television standard that has increased vertical, horizontal and timewise definition.

Full HD is a feature of devices with HDTV that can output or record 1920x1080 pixels of definition.

HD is 3840 x 2160 for UHD.

## **JPEG**

JPEG stands for Joint Picture Experts Group. It is the process where the picture data are compressed.

## **LNB**

The Low Noise Block resides at the center of parabolic antenna.

For example: It implements the satellite frequencies that are between 10.7 - 11.75 or 11.8 - 12.75 GHz in 950 to 2150 MHz and ensures cable transmission with coaxial cables (and with fiber-optic cables recently) and reception with satellite receivers.

## **MP3**

Compressed audio file format.

## **Noise Reduction**

Reduces the "snow" areas by displaying the picture a bit sharper and creating a slight blur. Thus, it must be used as little as possible with good picture material.

## **Symbol rate**

It is the amount of the symbols transmitted in a unit of time in the digital transmission technology.

## **TransPonder**

It is a cluster of various transmitters in a frequency.

## **Vibrant Colour**

Improves colour contrast and contrast setting. This setting is highly powerful for use in normal pictures and it should be used only when necessary (low or off). Otherwise, slight details in the image may be repressed.

## **WMA**

These formats enable audio files that occupy a very small place (even if they have a CD quality) to be recorded and played.

## Numbers

- »4:3« format.....26
- »16:9« format.....26

## A

- Access control for CA module and smart cards.....42
- Additional functions.....28
- Additional playback functions.....32
- Adjusting the audio format.....40
- Adjusting the volume.....25
- Adjusting the volume or changing the channel.....14
- AD Switch (audio subtitles).....24
- Audio data.....29
- Audio language.....25
  - »Auto« format.....26
- Automatic volume.....24
- Auto standby.....34

## B

- Balance.....23
- Basic functions.....25
- Bass.....23
- Blocking a television channel.....35
- Buttons of the remote control.....13, 14

## C

- Calling up the next sub-page directly.....28
- Changing stored channels for digital stations.....21
- Changing the audio language.....33
- Changing the menu language.....33
- Changing the PIN code.....35
- Changing the subtitle language.....33
- Changing the Teletext language.....33
- Cleaning the TV set.....52
- Concluding the settings.....24
- Conformity with WEEE Regulations and Disposing of Waste Product.....52
- CONNECTION/PREPARATION.....10, 11
  - Connecting a DVD recorder, DVD player, video recorder or set-top box.....40
  - Connecting an external device.....40
  - Connecting a PC.....41
  - Connecting digital multi-channel amplifier/AV receiver.....40

- Connecting external data media.....30
- Connecting headphones.....40
- Connecting the air and the mains cable.....11
- Connection options.....39
- Connections of the television set.....13
- Creating a favourite list.....22

## D

- Deleting channels from the programme edit.....21
- Digi Link connection functions of TV.....38
- Displaying information.....25
- Displaying signal information.....51
- Disposing of the packaging.....52

## E

- ELECTRONIC TV GUIDE.....27
- Electronic TV guide.....27
- Enlarging character size.....28
- Environmental warning.....52
- Explanation of the symbols which may be present on back side of the television set.....52

## F

- First time installation and channel search.....17

## G

- GENERAL INFORMATION.....7

## H

- HDMI CEC.....38
- Headphones.....40
- Hi-fi system.....40
- High definition - HD ready.....39

## I

- Important notes on environmental protection.....8
- Inserting batteries in the remote control.....12
- Inserting the CA module.....42

## L

- LANGUAGE SETTINGS.....33
- LNB Settings.....45
- Locking the control panel (parental control).....36
- Locking the menus.....35

# INDEX

---

## M

- Manual searching for digital television channels with aerial connection.....49
- Motorized antenna settings (DiSEqC 1.2).....46
- Move to desired time.....32
- Moving the channels in the programme edit to a different position.....21
- Muting.....25

## N

- Notes on still pictures.....8

## O

- Opening the Programme Edit.....21
- OPERATION WITH COMMON INTERFACE.....42

## P

- PACKAGING CONTENTS.....9
- Page stop.....28
- Parental Guidance.....35, 36
- PCB Conformity:.....52
- PC MONITOR MODE.....41
- PICTURE AND VOLUME SETTINGS.....23
- Picture data.....29
- Picture settings.....23
- Playback - Basic functions.....31

## R

- Receiving digital channels.....7
- Remote control - all functions.....16
- Remote control - main functions.....15
- Repeat functions.....32
- Resetting the television to its original state.....37
- Re-tuning all analogue television channels.....50
- Reveal answer.....28

## S

- Searching and selecting the active external device.....38
- Searching cable digital television channels.....19
- Searching for all digital television channels from a satellite automatically.....43
- Searching for digital television channels from a satellite manually.....44

- Searching for digital television channels through aerial automatically.....48
- Searching for digital television channels through cable automatically.....47
- Searching for digital television channels through cable manually.....48
- Searching forward.....32
- Searching television channels with satellite signal.....18
- Searching terrestrial digital television channels.....19
- Selecting aspect ratio.....32
- Selecting a track or picture in steps (SKIP).....32
- Selecting AV channels.....25
- Selecting channels.....25
- Selecting channels from lists.....25
- Selecting language, country and operation mode.....17
- Selecting the channel position for the PC.....41
- Selecting the HDMI source from the television.....38
- Selecting the menu language.....38
- Service information for dealers.....52
- SETTINGS.....17
- Setting up or hanging.....10
- SETUP AND SAFETY.....4
- Skipping television channels.....21
- Sleep timer.....34
- Sleep timer for OSD menu.....34
- Software update (USB).....37
- Sound settings.....23
- Special features of your television.....7
- Subtitles.....25
- SWAP function.....25
- Switching off the device from standby mode.....38
- Switching on and off.....25
- Switching on the external device from standby mode.....38



# INDEX

---

## T

- TELETEXT MODE.....28
- Text mode.....28
- The file browser.....31
- The file formats.....29
- The main menu of the file browser.....31
- Time Zone.....34
- Treble.....23
- Troubleshooting.....53
- Tuning analogue television channels.....50
- Tuning the analogue television channels by entering the channel numbers.....51
- Turning on the television and switching it to standby mode.....14
- Turn the picture display.....32

## U

- USB MODE.....29
- USING EXTERNAL DEVICES.....38
- Using the Euro/AV socket.....40

## V

- Video data.....29

## W

- Watching a blocked television channel.....36
- What is Common Interface?.....42
- With a digital audio/video signal.....40
- With an analogue video signal (progressive).....40

Grundig Intermedia GmbH • Thomas-Edison-Platz 3 • D-63263 Neu-Isenburg

**GRUNDIG**

[www.grundig.com](http://www.grundig.com)