



B-TECH AV MOUNTS™

QUICK & EASY SERVICE ACCESS

BT8341

UNIVERSAL POP-IN, POP-OUT VIDEO WALL MOUNTING SYSTEM



The BT8341 is a modular wall mounting system for video wall installations of any size and features pop-in, pop-out interface arms designed to aid installation and allow access to the rear of the screens for servicing and maintenance. As part of the System X range, the BT8341 features a contemporary, lightweight yet incredibly strong design with a high-end aesthetic quality and 8-point micro-adjustment for seamless screen alignment.

SPECIFICATION

Recommended screen size	39" - 65"
Max load	50kg (per screen)
Depth (with micro-adjustment)	119mm to 133mm
Depth (popped out with micro-adjustment)	298mm to 313mm
VESA® & non-VESA fixings	(max vertical dimension) 400mm*
Colour (VESA arms)	Black
Colour (horizontal rail)	Silver

*The VESA specification of the BT8341 refers to the vertical dimension only. All System X interface arms can be positioned as far along the rail as necessary. It is also possible to increase the maximum vertical fixing to 600mm by using BT7564 interface adaptor arms (available separately). Please note that using these adaptors will increase the total depth on the install by 20mm.

FEATURES

- Universal design suitable for all sized screens up to 50kg (per screen)
- Features pop-in, pop-out function to allow access to the rear of screens for servicing and maintenance and to aid installation
- Can be used in an endless variety of configurations
- Tool-less micro-adjustments at 8 points for seamless display alignment
- Suitable for landscape or portrait mounting
- High-end aesthetic quality
- Safety screws help prevent unauthorised removal of screens
- Ideal for recess mounting video walls
- Arms include locking screw to prevent accidental pop-out of screens
- Cable management included for a neat and tidy installation
- Multiple rail lengths available (rails can also be joined to create larger installs)
- Can be combined with System 2 poles and collars for floor-to-ceiling installations**

**Pop-in, pop-out solutions that are mounted from the ceiling should also be fixed to the floor to prevent poles flexing when pushing screens in and out. For more information contact your local sales representative



* VESA 400 PER SCREEN

50KG

RAILS

OTHER COMPONENTS

CREATE YOUR MOUNTING SYSTEM ONLINE

SPECIFY YOUR VIDEO WALL & MENU BOARD REQUIREMENTS ONLINE AND OUR SYSTEM X CONFIGURATION TOOL WILL CREATE A MOUNTING KIT TO SUIT YOUR NEEDS

There are thousands of System X configurations available! Visit our online configuration tool to specify setups, number of screens, number of rows and orientation.

Try now at www.btechavmounts.com/systemx-configurator



Tool-less micro-adjustment at 8 points for seamless display alignment

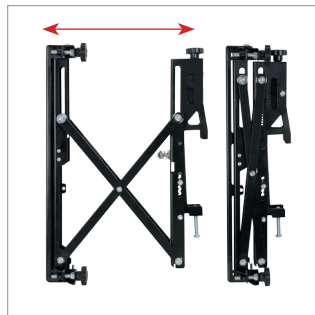

Push to open / push to close system provides quick and easy service access



Suitable for landscape or portrait mounting, screens can also be recess mounted



Compatible with System 2 poles and collars to create floor-to-ceiling installations



INAVATION AWARDS 2016
TECHNOLOGY FINALIST





BT8341 configurations are made to your exact requirements and, as a result, utilise a varying combination of System X components in order to create the perfect solution. Below are technical drawings for the standard components used in every BT8341 configuration: **BT8390-VESA400MAP** Pop-Out Interface Arms, **BT8390-WFK2** Wall Fixing Kit and **BT8390** Mounting Rails (available in the lengths shown). Please visit our System X online configuration tool at www.btechavmounts.com/systemx-configurator to specify your requirements. All dimensions will be automatically calculated and a complete mounting solution with all required parts will be created for you.

BT8390-VESA400MAP INTERFACE ARMS

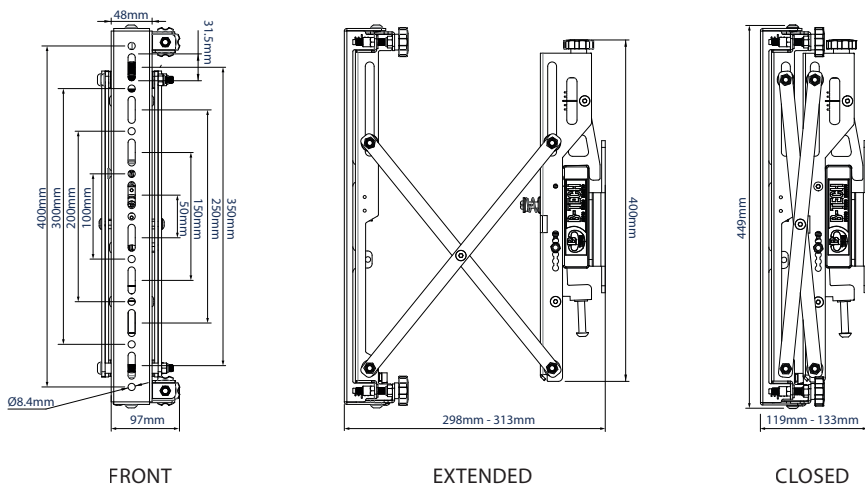

BT8390-WFK2 WALL FIXING KIT

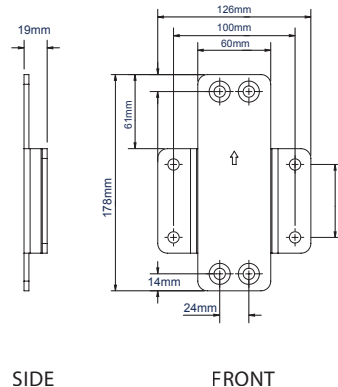

BT8390 MOUNTING RAIL LENGTHS

BT8390-200

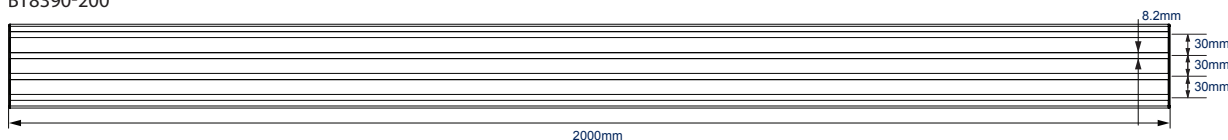

BT8390-175

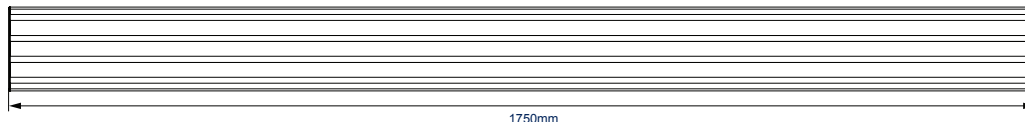

BT8390-150

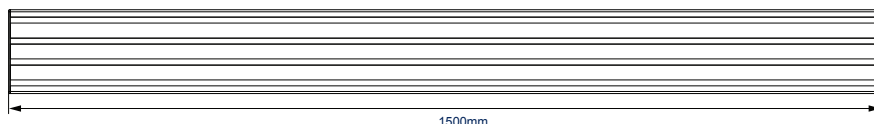

BT8390-070

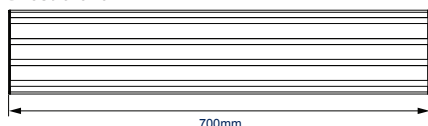

BT8390-050

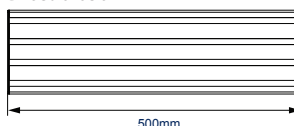

BT8390-030

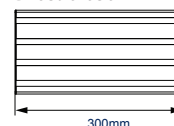

ACCESSORIES AND RELATED PRODUCTS

BT8340

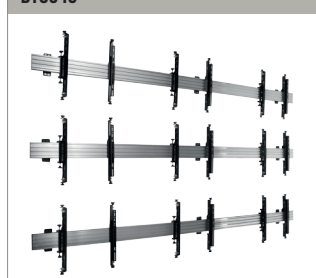

Universal Video Wall Mounting System for video wall configurations

BT8342

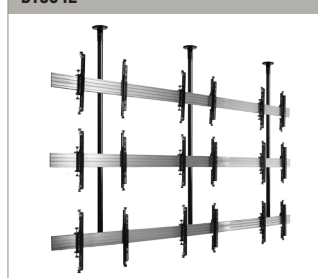

Universal Ceiling Mounted Video Wall System for video wall configurations

BT8330



Universal Menu Board Mounting System for wall mounted menu board configurations

BT8331

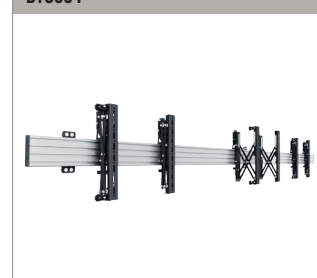

Universal Pop-In, Pop-Out Menu Board System for menu board configurations

© 2016 B-Tech Av Mounts. All rights reserved. The information in this specification is subject to change without notice. B-Tech Av Mounts and the B-Tech logo are registered trademarks of B-Tech International Design & Manufacturing Ltd. B-Tech Av Mounts is a registered trademark of B-Tech International Design & Manufacturing Ltd. B-Tech Av Mounts is not liable for loss or damage caused by improper installation or mounting on unsuitable structures. Any reproduction or transmission or publication of any part of this specification is expressly prohibited unless prior written permission has been granted by B-Tech International Design & Manufacturing Ltd. (B-Tech).
 SS-BT8341-VZ-1-151116