

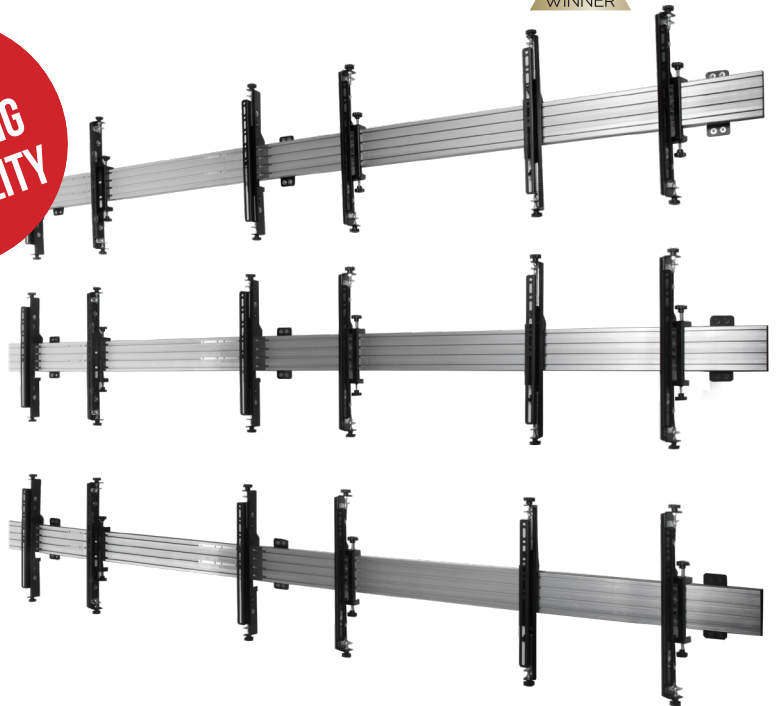

ENDLESS MOUNTING CAPABILITY

BT8340

UNIVERSAL VIDEO WALL MOUNTING SYSTEM



The BT8340 is a modular wall mounting system for video wall installations of any size. The BT8340 can mount screens in landscape or portrait orientations - perfect for digital signage that needs to stand out. As part of the System X range, the BT8340 can be used in thousands of different configurations and is ordered according to your requirements using B-Tech's online configuration tool (see below, right).

SPECIFICATION

Recommended screen size	32" - 47"
Max load	50kg (per screen)
VESA® & non-VESA fixings	(max vertical dimension) 400mm*
Colour (VESA arms)	Black
Colour (Horizontal Rail)	Silver

*The VESA specification of the BT8340 refers to the vertical dimension only. All System X interface arms can be positioned as far along the rail as necessary. It is also possible to increase the maximum vertical fixing to 600mm by using BT7564 interface adaptor arms (available separately). Please note that using these adaptors will increase the total depth on the install by 20mm.

FEATURES

- Universal design suitable for all sized screens up to 50kg (per screen)
- Can be used in an endless variety of configurations
- High-end aesthetic quality
- Tool-less micro-adjustments at 8 points for seamless display alignment
- Suitable for landscape or portrait mounting
- Can be used to create eye-catching, mosaic style installs (please contact your sales representative for more details)
- Multiple rail lengths available (rails can also be joined to create larger installs)
- Safety screws help prevent unauthorised removal of screens

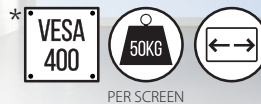

CREATE YOUR MOUNTING SYSTEM ONLINE

SPECIFY YOUR VIDEO WALL & MENU BOARD REQUIREMENTS ONLINE AND OUR SYSTEM X CONFIGURATION TOOL WILL CREATE A MOUNTING KIT TO SUIT YOUR NEEDS

There are thousands of System X configurations available! Visit our online configuration tool to specify setups, number of screens, number of rows and orientation.

Try now at www.btechavmounts.com/systemx-configurator

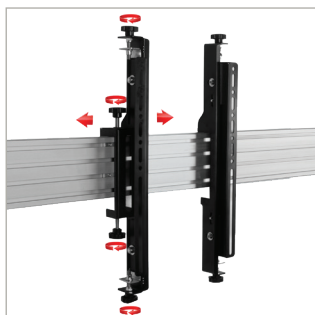

Tool-less micro-adjustment at 8 points for seamless screen alignment

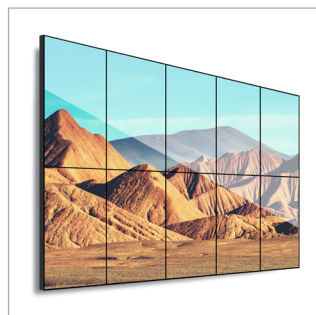

Suitable for landscape or portrait mounting

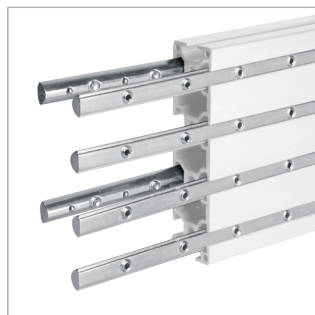

Multiple rail lengths available (rails can also be joined to create larger installs)

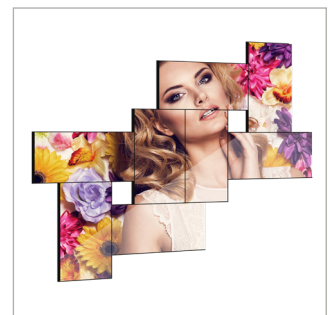

Can be used to create eye-catching, mosaic style installs



BT8340 configurations are made to your exact requirements and, as a result, utilise a varying combination of System X components in order to create the perfect solution. Below are technical drawings for the standard components used in every BT8340 configuration: **BT8390-VESA400MAF** Micro-Adjustment Interface Arms, **BT8390-WFK1 & 2** Wall Fixing Kits and **BT8390** Mounting Rails (available in the lengths shown). Please visit our System X online configuration tool at www.btechavmounts.com/system-x-configurator to specify your requirements. All dimensions will be automatically calculated and a complete mounting solution with all required parts will be created for you.

BT8390-VESA400MAF INTERFACE ARMS

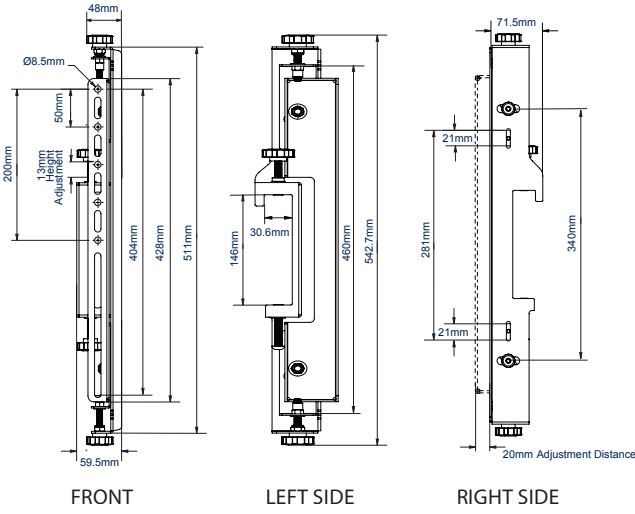

BT8390-WFK2 WALL FIXING KIT

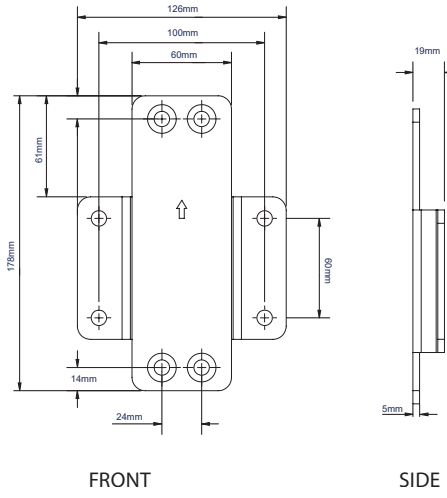

BT8390 MOUNTING RAIL LENGTHS

BT8390-200

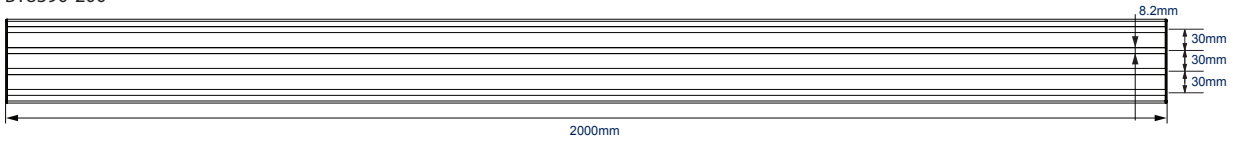

BT8390-175

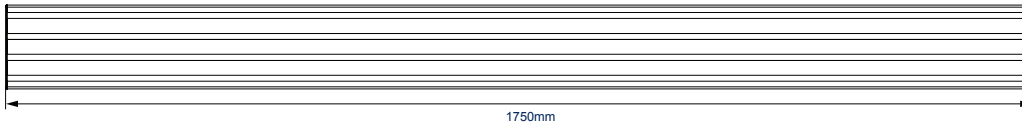

BT8390-150

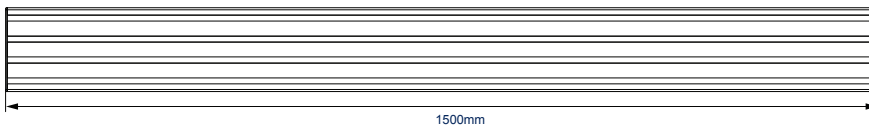

BT8390-070

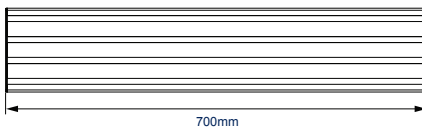

BT8390-050

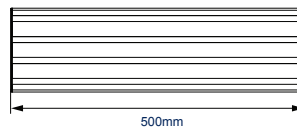

BT8390-030

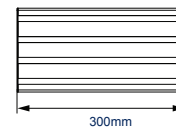

ACCESSORIES AND RELATED PRODUCTS

BT8341

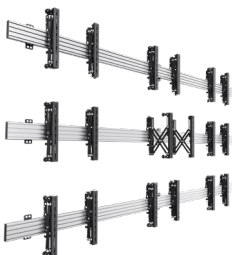

Universal Pop-In, Pop-Out Video Wall System for video wall configurations

BT8342

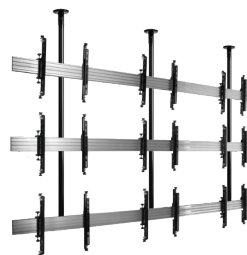

Universal Ceiling Mounted Video Wall System for video wall configurations

BT8330



Universal Menu Board Mounting System for wall mounted menu board configurations

BT8331

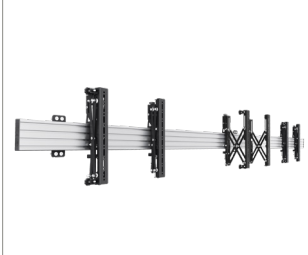

Universal Pop-In, Pop-Out Menu Board System for menu board configurations

© 2016 B-Tech Av Mounts. All rights reserved. The information in this specification is for reference only. B-Tech Av Mounts and B-Tech Technology are registered trademarks of B-Tech International Design & Manufacturing Ltd. We reserve the right to change the technical or physical specifications without prior notice. This B-Tech Av Mounts specification is not intended to be used as a basis for liability for loss or damage caused by improper installation or mounting or use of the product. Any reproduction or transmission or replication of any part of this specification is expressly prohibited, unless prior written permission has been granted by B-Tech International Design & Manufacturing Ltd. (B-Tech).

SS-BT8340-VZ-1-140918