



**THE DISPLAY CHOICE
OF PROFESSIONALS™**

SC-32E, SC-42E & SC-55E LED-Backlit Display

displays.agneovo.com

User Manual

TABLE OF CONTENTS

SAFETY INFORMATION

Federal Communications Commission (FCC) Notice (U.S. Only).....	4
CE	4
WEEE.....	5

PRECAUTIONS

Notice	6
Cautions When Setting Up	6
Cautions When Using.....	7
Cleaning and Maintenance.....	8
Notice for the LCD Display	8

CHAPTER 1: PRODUCT DESCRIPTION

1.1 Package Contents	9
1.2 Installation	10
1.2.1 Installing the Stand (for SC-32E/SC-42E).....	10
1.2.2 Adjusting the Tilt (for SC-32E/SC-42E)	11
1.2.3 Wall Mounting.....	11
1.3 Overview	12
1.3.1 Front View	12
1.3.2 Control Buttons.....	13
1.3.3 Rear View.....	14
1.4 Remote Control	15
1.4.1 Inserting the Batteries in the Remote Control	16
1.4.2 Handling the Remote Control	16
1.4.3 Operating Range of the Remote Control.....	17

CHAPTER 2: MAKING CONNECTIONS

2.1 Connecting the AC Power	18
2.2 Connecting Input Source Signals	19
2.3 Connecting Audio Devices	20
2.4 Connecting a Video Device	21
2.5 Connecting a USB Storage Device	21

CHAPTER 3: USING THE LCD DISPLAY

3.1 Turning on the Power	22
3.2 Using FREEZE Function	22
3.3 Adjusting the Volume.....	23
3.3.1 Muting Audio.....	23
3.4 Selecting a Source	24
3.5 Locking the Control Buttons	24
3.6 Selecting a Picture Mode	25
3.7 Setting Sleep Time	26

TABLE OF CONTENTS

3.8 Viewing Source Information	26
3.9 Using the Multimedia Functions	27
3.9.1 Navigating the Main Multimedia Menu	27
3.9.2 Viewing Photos.....	28
3.9.3 Listening to the Music.....	30
3.9.4 Watching Movie.....	32
3.9.5 Viewing Text Files.....	35
3.10 Upgrading Firmware.....	36
CHAPTER 4: ON SCREEN DISPLAY MENU	
4.1 Using the OSD Menu	37
4.2 OSD Menu Tree	38
CHAPTER 5: ADJUSTING THE LCD DISPLAY	
5.1 VIDEO Menu	39
5.2 AUDIO Menu	44
5.3 SETTING Menu.....	45
5.4 INFO Menu.....	47
CHAPTER 6: APPENDIX	
6.1 Warning Messages.....	48
6.2 USB Multimedia Formats and Resolutions.....	49
6.3 Timing.....	51
6.4 Troubleshooting.....	52
6.5 Transporting the LCD Display	53
CHAPTER 7: SPECIFICATIONS	
7.1 Display Specifications	55
7.2 Display Dimensions.....	56

SAFETY INFORMATION

Federal Communications Commission (FCC) Notice (U.S. Only)

SC-32E / SC-42E



This equipment has been tested and found to comply with the limits for a Class B digital device, pursuant to part 15 of the FCC Rules. These limits are designed to provide reasonable protection against harmful interference in a residential installation. This equipment generates, uses and can radiate radio frequency energy and, if not installed and used in accordance with the instructions, may cause harmful interference to radio communications. However, there is no guarantee that interference will not occur in a particular installation. If this equipment does cause harmful interference to radio or television reception, which can be determined by turning the equipment off and on, the user is encouraged to try to correct the interference by one or more of the following measures:

- Reorient or relocate the receiving antenna.
- Increase the separation between the equipment and receiver.
- Connect the equipment into an outlet on a circuit different from that to which the receiver is connected.
- Consult the dealer or an experienced radio/TV technician for help.



Changes or modifications not expressly approved by the party responsible for compliance could void the user's authority to operate the equipment.

Use only an RF shielded cable that was supplied with the display when connecting this display to a computer device.

To prevent damage which may result in fire or shock hazard, do not expose this appliance to rain or excessive moisture.

THIS CLASS B DIGITAL APPARATUS MEETS ALL REQUIREMENTS OF THE CANADIAN INTERFERENCE-CAUSING EQUIPMENT REGULATIONS.



This device complies with Part 15 of the FCC Rules. Operation is subject to the following two conditions: (1) this device may not cause harmful interference, and (2) this device must accept any interference received, including interference that may cause undesired operation.

CE

SC-55E



WARNING: This equipment is compliant with Class A of EN55032/CISPR 32. In a residential environment this equipment may cause radio interference.

SAFETY INFORMATION

WEEE

Information for users applicable in European Union countries



The symbol on the product or its packaging signifies that this product has to be disposed separately from ordinary household wastes at its end of life. Please kindly be aware that this is your responsibility to dispose electronic equipment at recycling centers so as to help conserve natural resources. Each country in the European Union should have its collection centers for electrical and electronic equipment recycling. For information about your recycling drop off area, please contact your local related electrical and electronic equipment waste management authority or the retailer where you bought the product.

PRECAUTIONS

PRECAUTIONS

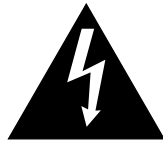

CAUTION
RISK OF ELECTRIC SHOCK
DO NOT OPEN



Symbols used in this manual



This icon indicates the existence of a potential hazard that could result in personal injury or damage to the product.



This icon indicates important operating and servicing information.

Notice

- Read this User Manual carefully before using the LCD display and keep it for future reference.
- The product specifications and other information provided in this User Manual are for reference only. All information is subject to change without notice. Updated content can be downloaded from our web site at displays.agneovo.com.
- To register online, go to displays.agneovo.com.
- To protect your rights as a consumer, do not remove any stickers from the LCD display. Doing so may affect the determination of the warranty period.

Cautions When Setting Up



Do not place the LCD display near heat sources, such as a heater, exhaust vent, or in direct sunlight.



Do not cover or block the ventilation holes in the housing.



Place the LCD display on a stable area. Do not place the LCD display where it may be subject to vibration or shock.



Place the LCD display in a well-ventilated area.



Do not place the LCD display outdoors.



Do not place the LCD display in a dusty or humid environment.



Do not spill liquid or insert sharp objects into the LCD display through the ventilation holes. Doing so may cause accidental fire, electric shock or damage the LCD display.

PRECAUTIONS

Cautions When Using



Use only the power cord supplied with the LCD display.



The power outlet should be installed near the LCD display and be easily accessible.



If an extension cord is used with the LCD display, ensure that the total current consumption plugged into the power outlet does not exceed the ampere rating.



Do not allow anything to rest on the power cord. Do not place the LCD display where the power cord may be stepped on.



If the LCD display will not be used for an indefinite period of time, unplug the power cord from the power outlet.



To disconnect the power cord, grasp and pull by the plug head. Do not tug on the cord; doing so may cause fire or electric shock.



Do not unplug or touch the power cord with wet hands.



WARNING:

Unplug the power cord from the power outlet and refer to qualified service personnel under the following conditions:



- When the power cord is damaged.
- If the LCD display has been dropped or the housing has been damaged.
- If the LCD display emits smoke or a distinct odor.



Ceiling mount or mount on any other horizontal surface overhead are not advisable.



WARNING:

Installation in contravention of the instructions may result in undesirable consequences, particularly hurting people and damaging property. Users who have already mounted the display on the ceiling or any other horizontal surface overhead are strongly advised to contact AG Neovo for consultations and solutions to help ensure a most pleasurable and fulfilling display experience.

PRECAUTIONS

Cleaning and Maintenance



Do not attempt to service the LCD display yourself, refer to qualified service personnel.

Opening or removing the covers may expose you to dangerous voltage or other risks.

Notice for the LCD Display

In order to maintain the stable luminous performance, it is recommended to use low brightness setting.

Due to the lifespan of the lamp, it is normal that the brightness quality of the LCD display may decrease with time.

When static images are displayed for long periods of time, the image may cause an imprint on the LCD display. This is called image retention or burn-in.

To prevent image retention, do any of the following:

- Set the LCD display to turn off after a few minutes of being idle.
- Use a screen saver that has moving graphics or a blank white image.
- Switch desktop backgrounds regularly.
- Adjust the LCD display to low brightness settings.
- Turn off the LCD display when the system is not in use.

Things to do when the LCD display shows image retention:

- Turn off the LCD display for extended periods of time. It can be several hours or several days.
 - Use a screen saver and run it for extended periods of time.
 - Use a black and white image and run it for extended periods of time.
-

There are millions of micro transistors inside the LCD display. It is normal for a few transistors to be damaged and to produce spots. This is acceptable and is not considered a failure.

CHAPTER 1: PRODUCT DESCRIPTION

1.1 Package Contents

When unpacking, check if the following items are included in the package. If any of them is missing or damaged, contact your dealer.

LCD Display

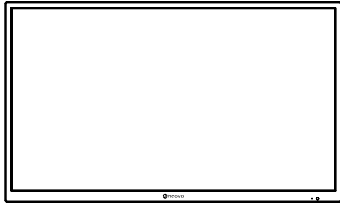

Base

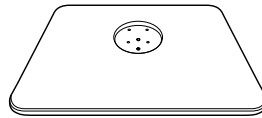

SC-32E/SC-42E

Stand

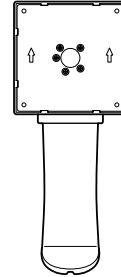

SC-32E/SC-42E

Quick Start Guide

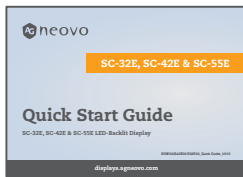

Remote Control

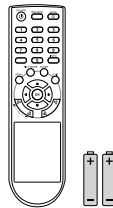

VGA Cable

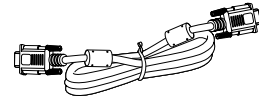

Power Cord

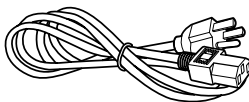

Audio Cable

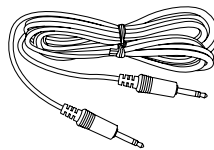

Screws

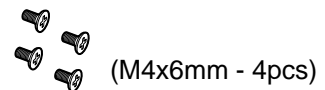

(M4x6mm - 4pcs)

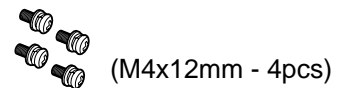

(M4x12mm - 4pcs)

SC-32E/SC-42E

Note:

- Use only the supplied power cord.
- The above pictures are for reference only. Actual items may vary upon shipment.

PRODUCT DESCRIPTION

1.2 Installation

1.2.1 Installing the Stand (for SC-32E/SC-42E)

1. Place the LCD display with the screen side down on a cushioned surface.
2. Attach the base to the stand and fix with the screws to join them tightly.
3. Attach the base stand to the LCD display and fix with the screws to join them tightly.

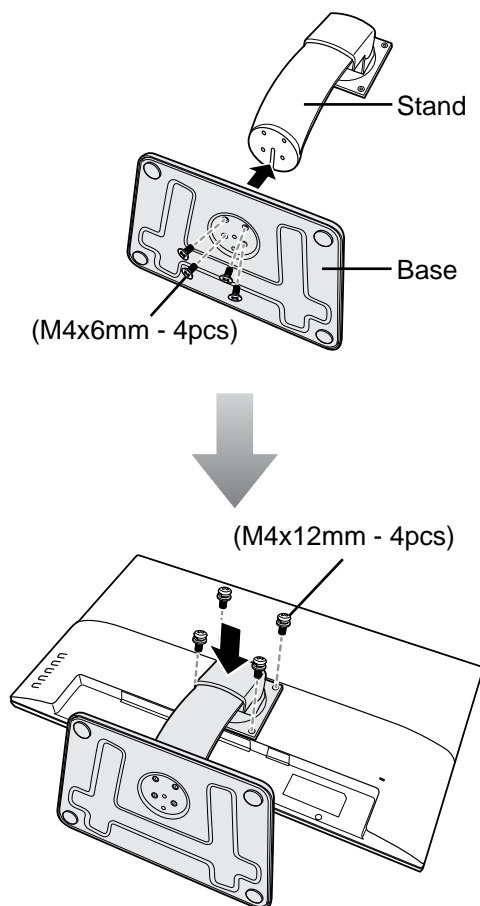

PRODUCT DESCRIPTION

1.2.2 Adjusting the Tilt (for SC-32E/SC-42E)

For comfort viewing, tilt the LCD display up to an angle of -7° to 17° . Hold the stand with one hand and use the other to adjust the LCD display to the desired angle.

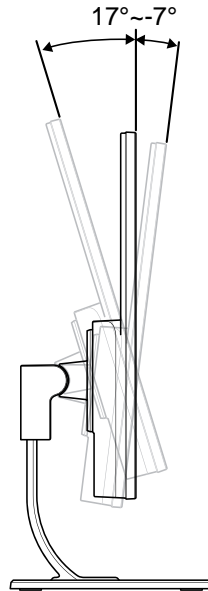

1.2.3 Wall Mounting

To wall mount the LCD display, do the following steps:

1. Remove the base stand.

Refer to page 53.

2. Wall mount the LCD display.

Screw the mounting bracket to the VESA holes at the rear of the LCD display.

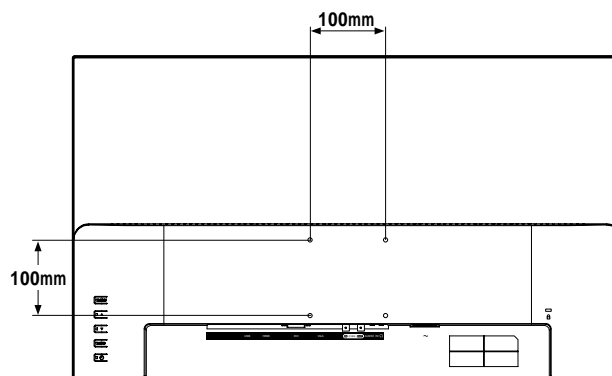

Note: Take measures to prevent the LCD display from falling down and lessen possible injury and damage to the display in case of earthquakes or other disasters.

- Use only the 100 x 100 mm wall mount kit recommended by AG Neovo. All AG Neovo wall mount kits comply with VESA standard.
- Secure the LCD display on a solid wall strong enough to bear its weight.
- It is suggested to wall mount the LCD display without tilting it facing downward.

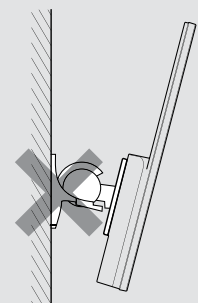

PRODUCT DESCRIPTION

1.3 Overview

1.3.1 Front View

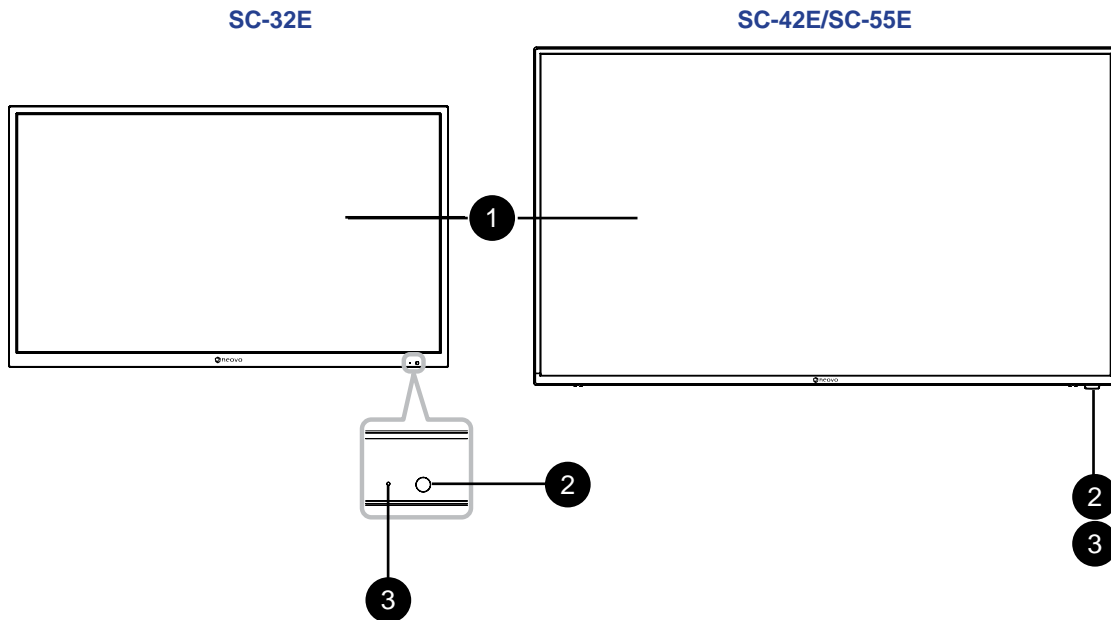

1

Display screen

2

Remote control sensor:

Receives command signals from the remote control.

3

Power status indicator: Indicates the operating status of the display:

- Lights green when the display is turned on.
- Lights amber when the display is in standby mode.
- Lights off when the main power of the display is turned off.

PRODUCT DESCRIPTION

1.3.2 Control Buttons

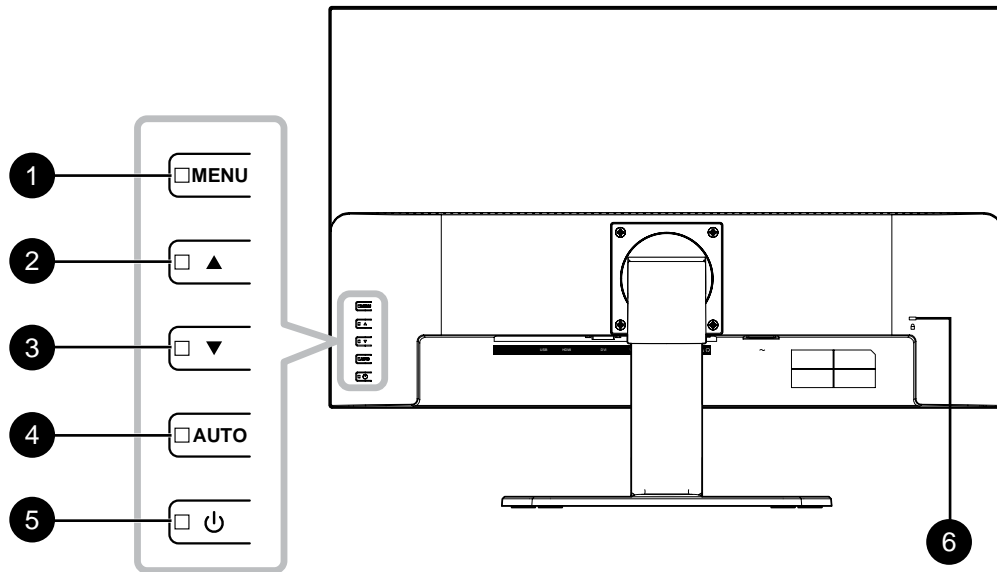



- 1 MENU:**
OSD menu ON/OFF.
- 2 UP (▲):** Hot Key: Source Key
When OSD menu is ON, navigate through adjustment icons or adjust a function.
- 3 DOWN (▼):** Hot Key: Volume Key
 - When OSD menu is ON, navigate through adjustment icons or adjust a function.
 - When the ▼ button is pressed, the volume can be adjusted. The ▲/▼ buttons can be used for the volume adjustment.
- 4 AUTO:** Hot Key: Freeze On/Off
When OSD menu is ON, the key is used for function adjust confirm.
- 5 POWER:**
Press to turn the display on or off.
- 6 Kensington security slot:**
Used for security and theft prevention.

PRODUCT DESCRIPTION

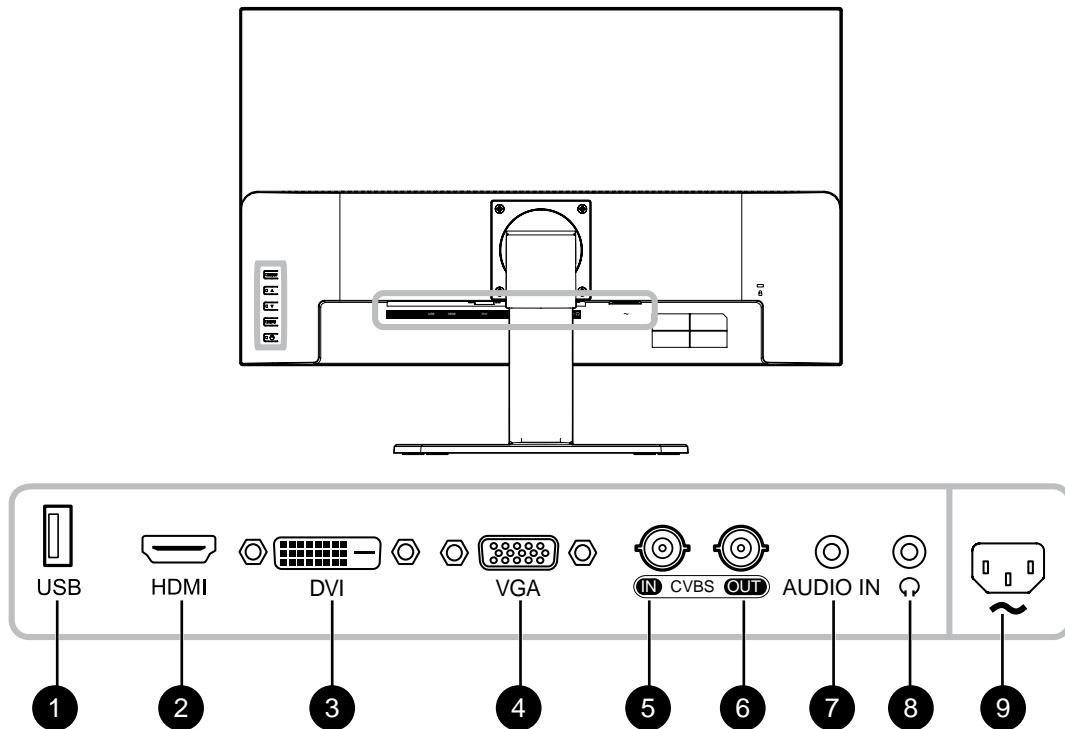
1.3.3 Rear View



- 1 USB (FW / Multi Media Function):**
Connect USB storage for FW update / Media playback.
- 2 HDMI input:**
Connect HDMI video / audio input source.
- 3 DVI IN:**
Connect DVI-D video input source.
- 4 VGA input (D-Sub):**
Connect VGA video input source.
- 5 CVBS IN:**
Connect to CVBS video input source (BNC connector).
- 6 CVBS OUT:**
Connect to CVBS for video source output (BNC connector).
- 7 AUDIO IN:**
Connect to audio input source (3.5 mm Stereo Audio Jack).
- 8 :**
Connect to a headphone (3.5 mm Stereo Audio Jack).
- 9 :**
Connect the power cord to the display and insert the plug into the power outlet socket.

Note: Press the  button or the SOURCE button of remote control to select the video input source when necessary.

PRODUCT DESCRIPTION

1.4 Remote Control

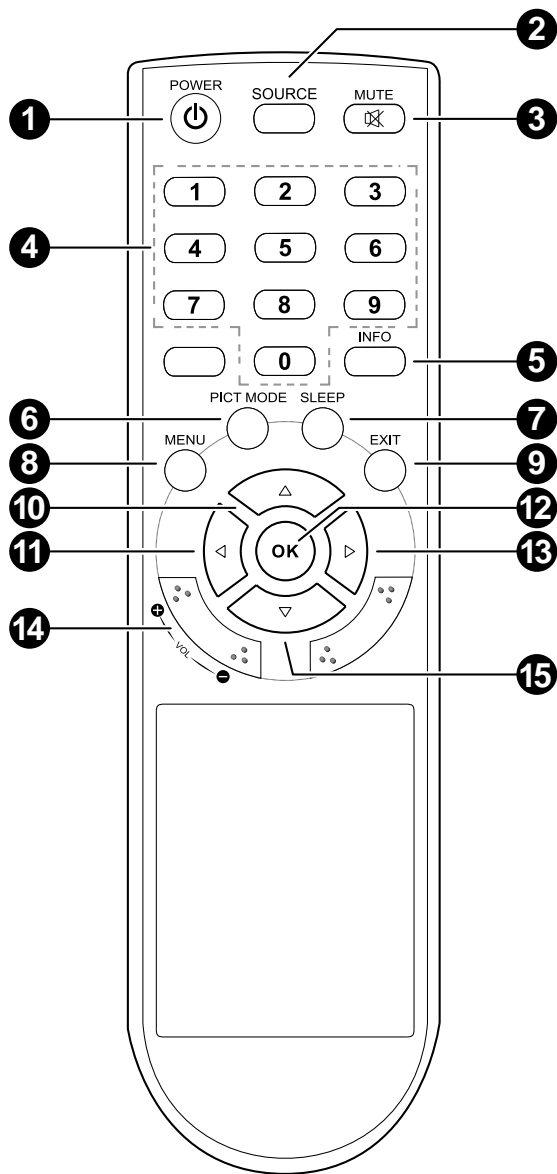

- ① **(⏻) POWER:**
Turn the monitor on or off.
- ② **SOURCE (input source):**
Select the signal source from multiple input sources.
- ③ **(🔇) MUTE:**
Turn the audio on and off.
- ④ **Number Buttons**
- ⑤ **INFO:**
Information display.
- ⑥ **PICT MODE:**
Select preferred picture settings.
- ⑦ **SLEEP:**
Set the sleep timer.
- ⑧ **MENU:**
Display a main menu.
- ⑨ **EXIT:**
Turn the main menu off.
- ⑩ **(▲) UP / ⑮ (▼) DOWN / ⑪ (◀) LEFT / ⑬ (▶) RIGHT Buttons:**
Navigate through menus and choose items.
- ⑫ **OK:**
Select menu items.
- ⑭ **VOL +/-:**
Adjust the volume level.

PRODUCT DESCRIPTION

1.4.1 Inserting the Batteries in the Remote Control

The remote control is powered by two 1.5V AAA batteries.

To install or replace batteries:

1. Press and then slide the cover to open it.
2. Align the batteries according to the (+) and (-) indications inside the battery compartment.
3. Replace the cover.

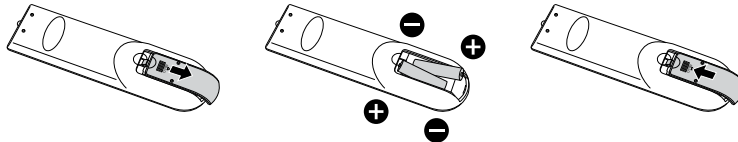

CAUTION:

The incorrect use of batteries can result in leaks or bursting. Be sure to follow these instructions:

- Place “AAA” batteries matching the (+) and (-) signs on each battery to the (+) and (-) signs of the battery compartment.
- Do not mix battery types.
- Do not combine new batteries with used ones. It causes shorter life or leakage of batteries.
- Remove the dead batteries immediately to prevent them from liquid leaking in the battery compartment. Don't touch exposed battery acid, as it can damage your skin.

Note:

- *If you do not intend to use the remote control for a long period, remove the batteries.*
- *The remote control may not function properly when the remote control sensor on this display is under direct sunlight or strong illumination, or when there is an obstacle in the path of signal transmission.*

1.4.2 Handling the Remote Control

- Do not subject to strong shock.
- Do not allow water or other liquid to splash the remote control. If the remote control gets wet, wipe it dry immediately.
- Avoid exposure to heat and steam.
- Other than to install the batteries, do not open the remote control.

PRODUCT DESCRIPTION

1.4.3 Operating Range of the Remote Control

Point the top of the remote control toward the display's remote control sensor (front side) when pressing a button.

Use the remote control within the range which is shown in the following table.

Operation Angle	RC operational distance
$\theta = 0^\circ$ (for H & V)	$\geq 8\text{m}$
$\theta = 20^\circ$ (for H & V)	$\geq 5\text{m}$
$\theta = 45^\circ$ (for H only)	$\geq 2\text{m}$

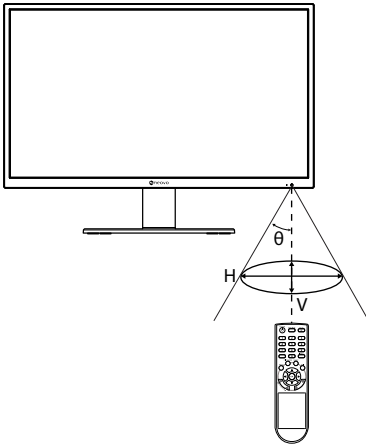

CHAPTER 2: MAKING CONNECTIONS



CAUTION:

Make sure that the LCD display is not connected to the power outlet before making any connections. Connecting cables while the power is ON may cause possible electric shock or personal injury.

2.1 Connecting the AC Power

1. Connect the power cord to the AC power input at the rear of the LCD display.
2. Connect the power cord plug to a power outlet or a power supply.

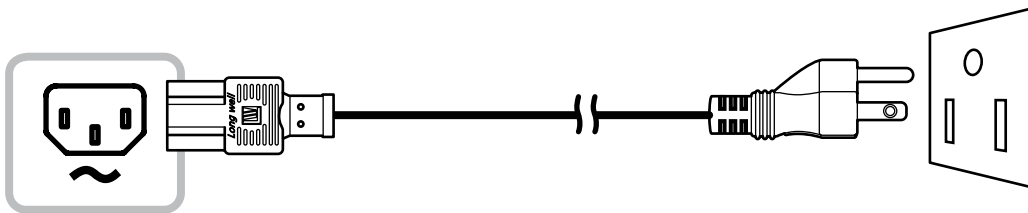

CAUTION:

When unplugging the power cord, hold the power cord by the plug head. Never pull by the cord.

MAKING CONNECTIONS

2.2 Connecting Input Source Signals

Input source signals can be connected with either of the following cables:

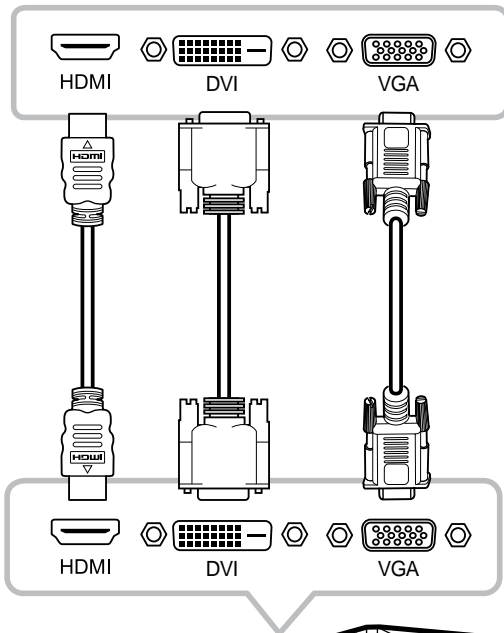

- **HDMI**

Connect one end of an HDMI cable to the HDMI connector of the LCD display and the other end to the HDMI connector of the computer.

- **DVI**

Connect one end of a DVI cable to the DVI connector of the LCD display and the other end to the DVI connector of the computer.

- **VGA**

Connect one end of a D-Sub (VGA) cable to the D-Sub (VGA) connector of the LCD display and the other end to the D-Sub (VGA) connector of the computer.

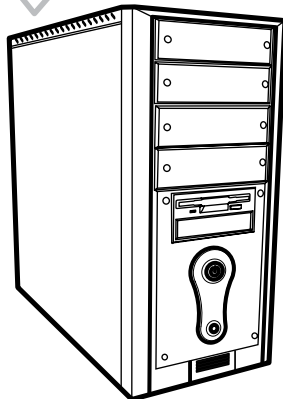

MAKING CONNECTIONS

2.3 Connecting Audio Devices

- **Audio Input**

Connect one end of an audio cable to the AUDIO IN port of the LCD display and the other end to the AUDIO OUT port of the computer.

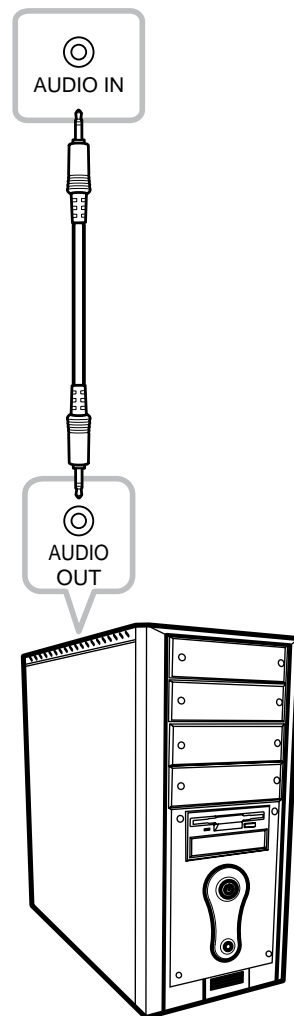

- **Audio Output**

Connect a headphone to the headphone jack (🎧) of the LCD display.

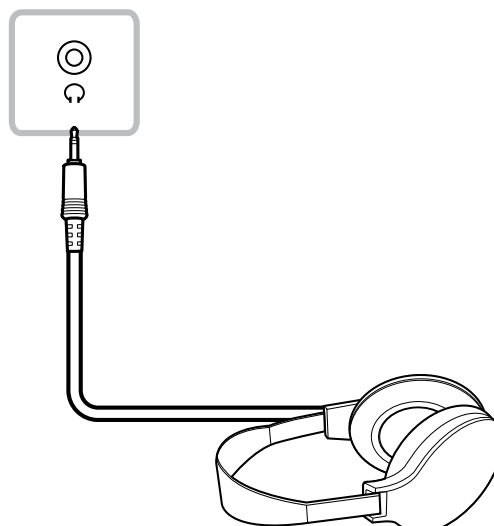

MAKING CONNECTIONS

2.4 Connecting a Video Device

- **CVBS IN**

Connect one end of a composite cable to the CVBS port of the LCD display and the other end to the CVBS port of the video device.

- **CVBS OUT**

Connect one end of a composite cable to the CVBS port of the LCD display and the other end to the CVBS port of the external display.

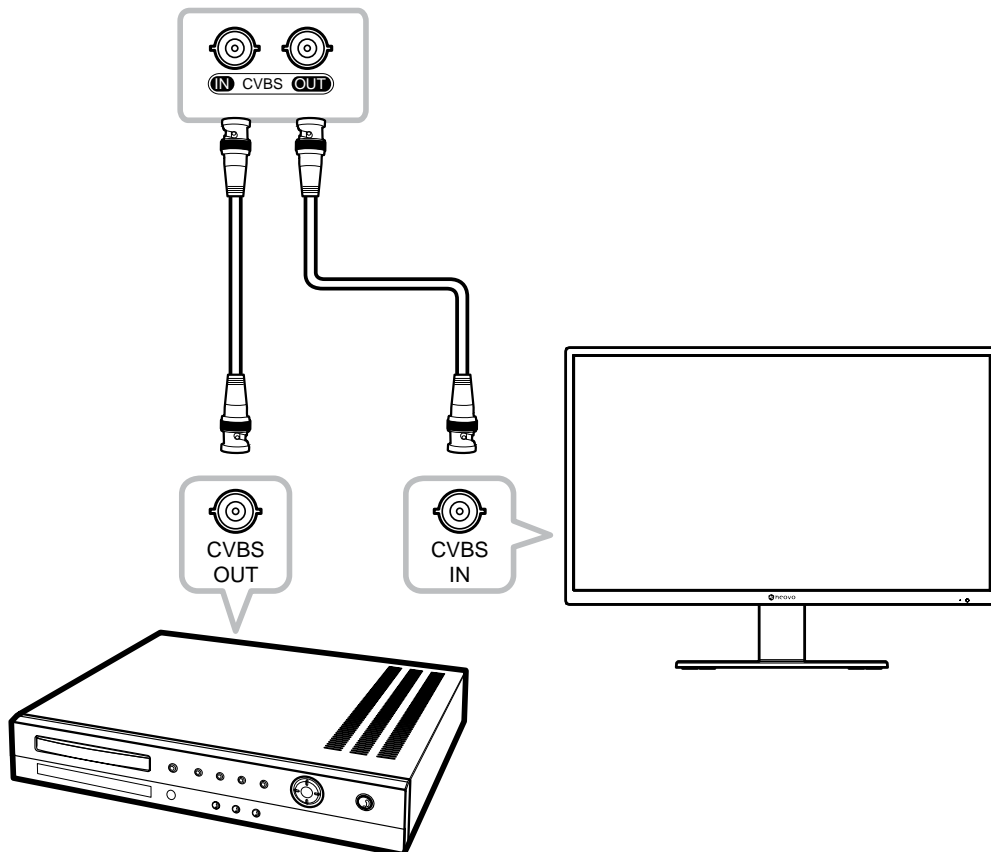

2.5 Connecting a USB Storage Device

Connect a USB storage device to the USB port of the LCD display for firmware upgrade or multimedia function.

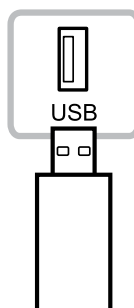

CHAPTER 3: USING THE LCD DISPLAY

3.1 Turning on the Power

1. Plug the power cord to a power outlet or power supply.
2. Press the  button on the control panel or on the remote control to turn the LCD display on.

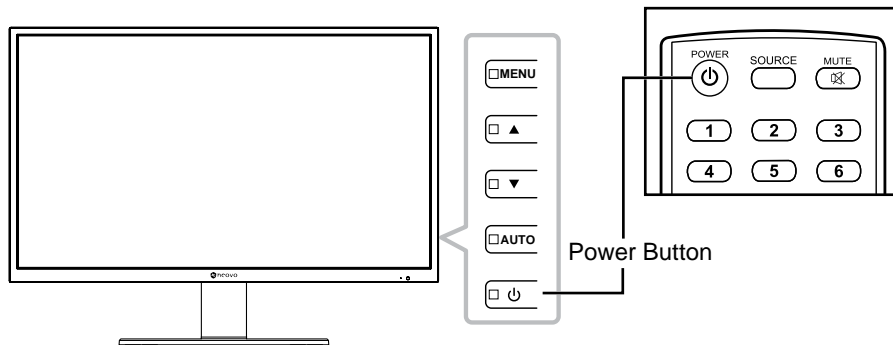

When the LCD display is turned on, press the  button to turn off the LCD display.

Note: The LCD display still consumes power as long as the power cord is connected to the power outlet. Disconnect the power cord to completely cut off power.

3.2 Using FREEZE Function

The FREEZE function allows you to freeze the screen image but still continues real-time playback until the image is unfreeze.

Press the AUTO button on the LCD display control panel to activate screen freeze, the screen freeze message is displayed on the screen.

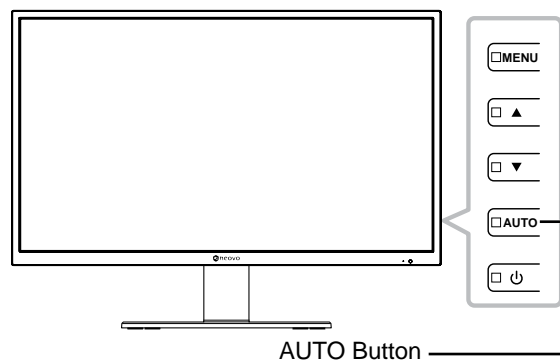

FREEZE:ON



Note: The FREEZE function is available only during video input signals but not available when the input source is USB.

USING THE LCD DISPLAY

Press the AUTO button again to deactivate screen freeze. The screen freeze off message is displayed on the screen.

FREEZE:OFF

The screen image displays the elapsed real-time playback image when screen freeze is deactivated.



3.3 Adjusting the Volume

Press the ▼ button on the control panel or either of the VOL +/- buttons on the remote control to call out the volume adjustment menu.

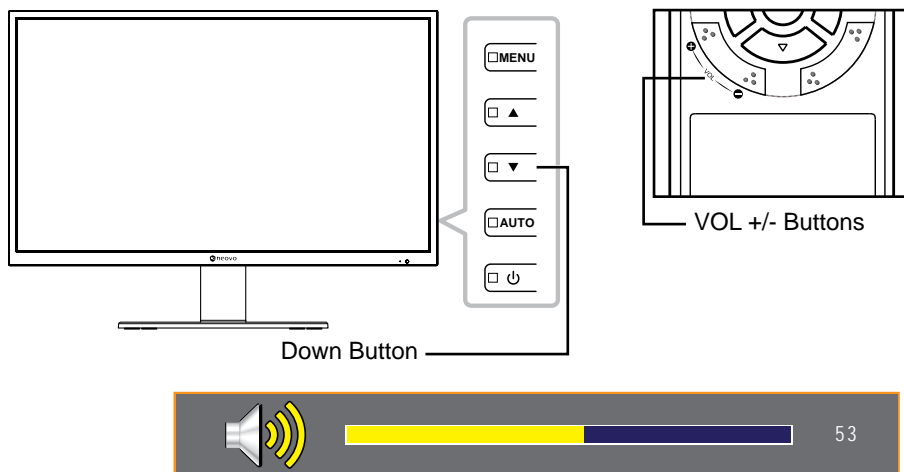

Press the ▲/▼ button on the control panel or either of the VOL +/- buttons on the remote control to adjust volume.

Note: During volume or menu setting adjustment, press and hold the ▲ or ▼ button on the control panel or either of the VOL +/- buttons on the remote control to change the values continuously.

3.3.1 Muting Audio

Press the MUTE  button on the remote control to mute audio. The mute icon is displayed on the screen.



Press the MUTE  button on the remote control again to unmute audio.

USING THE LCD DISPLAY

3.4 Selecting a Source

Press the ▲ button on the control panel or the SOURCE button on the remote control to call out the source selection menu.

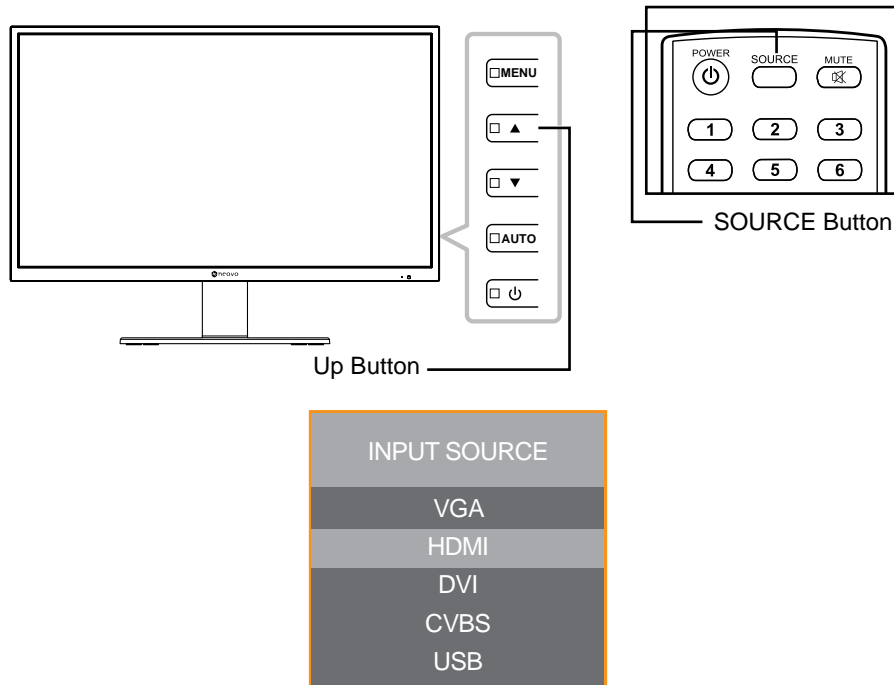

Press the ▲/▼ button on the LCD control panel or on the remote control to select the input source. Then press the OK button on the remote control to confirm or wait until the source menu disappears from the screen automatically. The available input options include “VGA”, “HDMI”, “DVI”, “CVBS”, and “USB”.

Note: Every time you switch to the VGA source, the LCD display performs screen adjustment automatically.

3.5 Locking the Control Buttons

Note: Locking the control buttons is not available when the input source is USB.

There are two options to lock the control buttons: lock all the buttons or lock all but Power button.

- KEY LOCK (ALL): Press MENU button for 5 seconds to enable/disable the KEY LOCK (ALL) function.

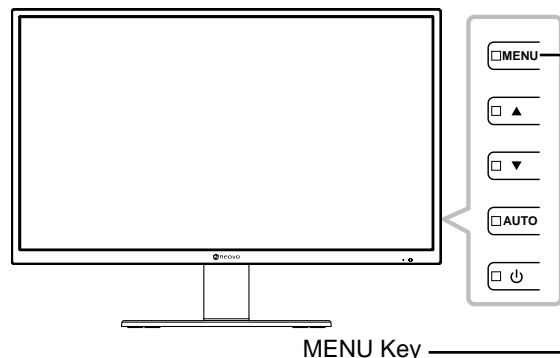

USING THE LCD DISPLAY

The key lock message is displayed on the screen.



- KEY LOCK (w/o POWER): Press the AUTO button for 5 seconds to enable/disable the KEY LOCK (w/o POWER) function.

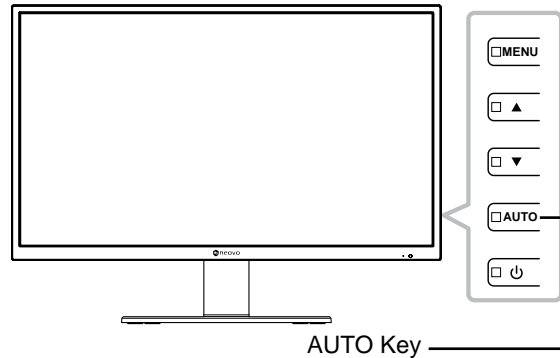

The key lock message is displayed on the screen.



3.6 Selecting a Picture Mode

Note: *Selecting the picture mode is not available when the input source is USB.*

Press the PICT MODE button on the remote control repeatedly to toggle between different picture modes. The available options include “STANDARD”, “VIDEO”, and “CCTV”.

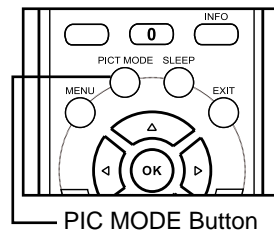

The current picture mode is displayed on the screen. For example, standard as illustrated below.



Note: *You can also change the picture mode in OSD menu. Refer to page 39.*

USING THE LCD DISPLAY

3.7 Setting Sleep Time

Note: *Setting the sleep time is not available when the input source is USB.*

Press the SLEEP button on the remote control repeatedly to toggle between different sleep time intervals. The available options include “OFF”, “10MINUTES”, “20MINUTES”, “30MINUTES”, “60MINUTES”, “90MINUTES”, “120MINUTES”, “180MINUTES”, and “240MINUTES”.

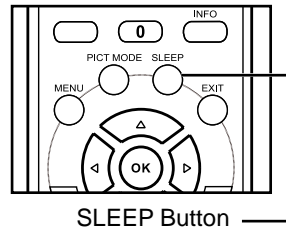

The current sleep time setting is displayed on the screen. For example, 10 minutes as illustrated below.



3.8 Viewing Source Information

Note: *The source information function is not available when the input source is USB.*

Press the INFO button on the remote control to view the source information.

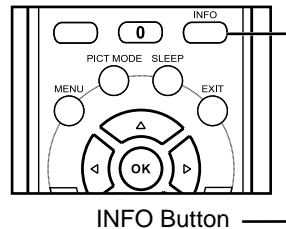

USING THE LCD DISPLAY

3.9 Using the Multimedia Functions

In multimedia mode, you can view photos, listen to the music, watch films, and display text files from an external USB storage.

3.9.1 Navigating the Main Multimedia Menu

To switch the LCD display to the multimedia mode, do the following:

1. Turn on the LCD display. Refer to page 22.
2. Connect the USB storage with multimedia content to the USB port on the LCD display.
3. Set the input source to USB. Refer to page 24.

The main multimedia menu opens.

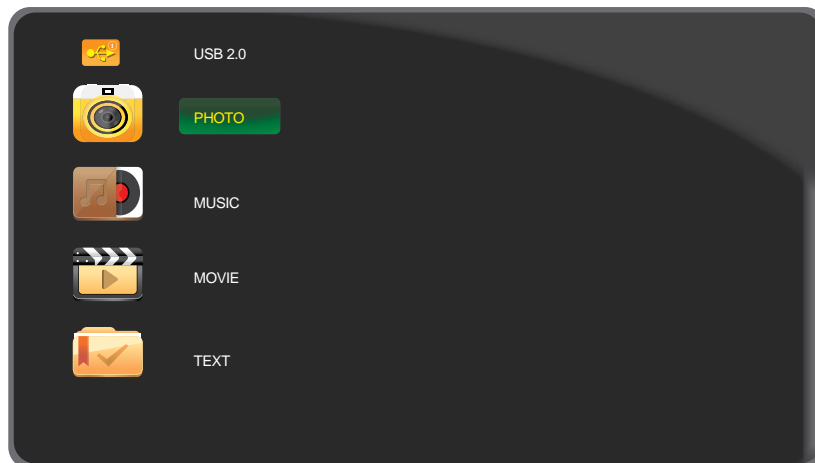

Note: The folders in multimedia menu can be opened only if you have connected a USB storage to the LCD display.

4. Press the ▲/▼ button on the control panel or the remote control to select the folder with the media content that you want to play.
 - For viewing photos, select “PHOTO” folder.
 - For playing music, select “MUSIC” folder.
 - For watching films, select “MOVIE” folder.
 - For displaying a text file, select “TEXT” folder.

USING THE LCD DISPLAY

5. After making the selection, press the **AUTO** button on the control panel or the **OK** button on the remote control to open the folder.

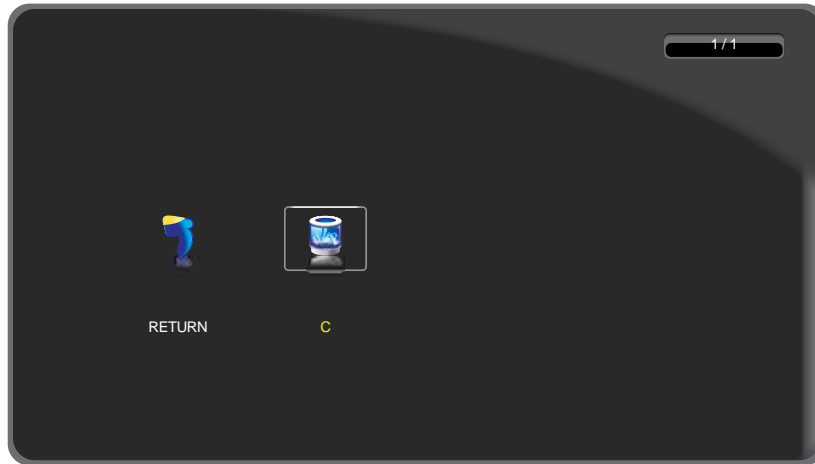

6. Press the **AUTO** button on the control panel or the **OK** button on the remote control to browse the content of the folder.
 - Press the ▼ button on the control panel or the ◀ button on the remote control and then press the **AUTO** button on the control panel or the **OK** button on the remote control to return to the main multimedia menu.

3.9.2 Viewing Photos

1. Press the ▲/▼ button on the control panel or the remote control to select your favorite photo.

Note: After you select the photo, a preview of it with details will open on the left side of the browser. Details include information on resolution (“RES.”), file size (“SIZE”), date (“DATE”), and time (“TIME”) when the photo was captured.

2. Press the **AUTO** button on the control panel or the **OK** button on the remote control to open the photo.
 - Press the ▲/▼ button (repeatedly if necessary) on the control panel or the ▲/▼/◀/▶ button (repeatedly if necessary) on the remote control to select “RETURN”. Then press the **AUTO** button on the control panel or the **OK** button on the remote control to return to the previous menu.

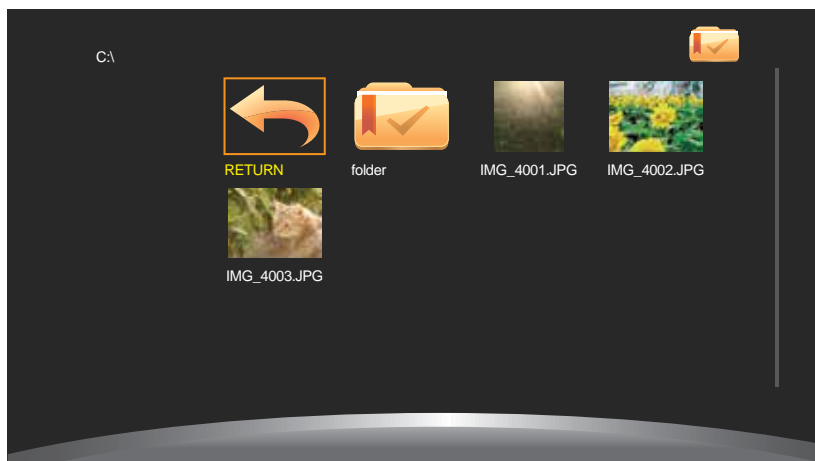

USING THE LCD DISPLAY

Note: If you receive an error message while trying to open a photo, probably the file format is not supported. Refer to page 49.

3. By default, all available photos that are saved in the same folder on the USB storage are displayed in a playlist. To control the slideshow, press the ▲/▼ button on the control panel or the remote control to select the control button. Then press the AUTO button on the control panel or the OK button on the remote control to perform the function.

Note: If you cannot see the control bar, press the AUTO button on the control panel or the OK button on the remote control. To hide the control bar, press the MENU button on the control panel or the ▼ or the EXIT button on the remote control.

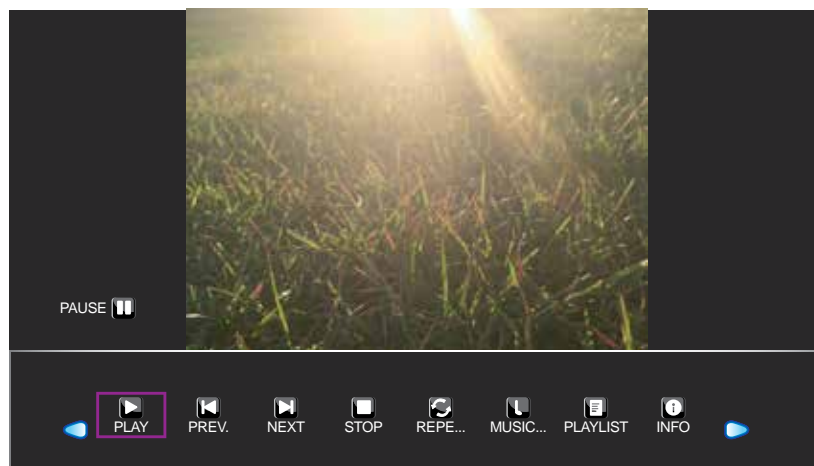





- ◀▶: Move to the left or to the right to select control bar buttons.
- ▶ "PLAY" / ⏸ "PAUSE": The slideshow starts automatically after you choose a photo. Select "▶" to pause the slideshow. Select "⏸" to resume the slideshow.
- ◀ "PREV.": Display the previous photo.
- ▶ "NEXT": Display the next photo.
- ⏹ "STOP": Stop the slideshow and return to the browser view.
- 🔄 "REPEAT.. / REPEAT 1 / REPEAT ALL": Select "REPEAT..." to play the slideshow once and return to the browser view. Select "REPEAT 1" to repeat one and the same photo continuously. Select "REPEAT ALL" to repeat the slideshow continuously. After setting the repeat option, select "▶".
- 🔊 "MUSIC ON/OFF": Select "MUSIC ON" to play music during the slideshow (if applicable). Select "MUSIC OFF" to mute audio. The music file needs to be placed in the same folder of the PHOTO file.

Note: To adjust the volume during the slideshow, refer to page 23.

- 📄 "PLAYLIST": List all image files in the slideshow. To open a specific file, select it. To exit the playlist, select "CANCEL".
- ⓘ "INFO": Display the current image file details. Select "CLOSE" to exit the information menu.

USING THE LCD DISPLAY

-  "ROTATE" (clockwise): Rotate the current photo clockwise.
-  "ROTATE" (counterclockwise): Rotate the current photo counterclockwise.
-  "ZOOM IN": Zoom in on the current photo 1/4x, 1/2x, 1x, 2x, 4x, or 8x. The zoom ratio is displayed on the screen.
-  "ZOOM OUT": Zoom out on the current photo 8x, 4x, 2x, 1x, 1/2x, or 1/4x. The zoom ratio is displayed on the screen.
-  "Move...": After you have zoomed in on the photo, press the ▲/▼ button on the control panel or the ▲/▼/◀/▶ button on the remote control to move any location on the photo.

The navigation directions (green arrows) and the navigation map are displayed on the screen. The position of the zoomed area is indicated by yellow rectangle on the navigation map.

Navigation Directions



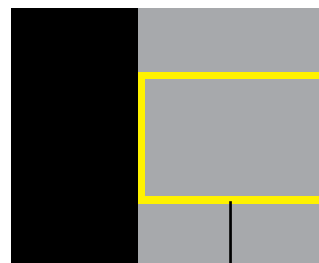

Navigation Map



Position of the zoomed area

Press the AUTO button on the control panel or the OK button on the remote control to resume with the slideshow.

-  "ASPECT": Select the suitable aspect ratio among "4:3", "NATIVE", and "16:9". While changing the aspect ratio, the currently selected ratio is displayed on the screen for reference.

4. Select the  ("STOP") button on the control bar to return to the browser view. You can also press the MENU button (repeatedly if necessary) on the LCD display or the MENU or EXIT button (repeatedly if necessary) on the remote control to end the slideshow and return to the browser view.

3.9.3 Listening to the Music

1. Press the ▲/▼ button on the control panel or the remote control to select your favorite music file.

Note: After you select a music file, a preview of it with details will open on the left side of the browser. Details include information on album name ("ALBUM"), title ("TITLE"), bit rate ("BIT RATE"), artist ("ARTIST"), and file size ("SIZE").

USING THE LCD DISPLAY

2. Press the **AUTO** button on the control panel or the **OK** button on the remote control to playback the music file.

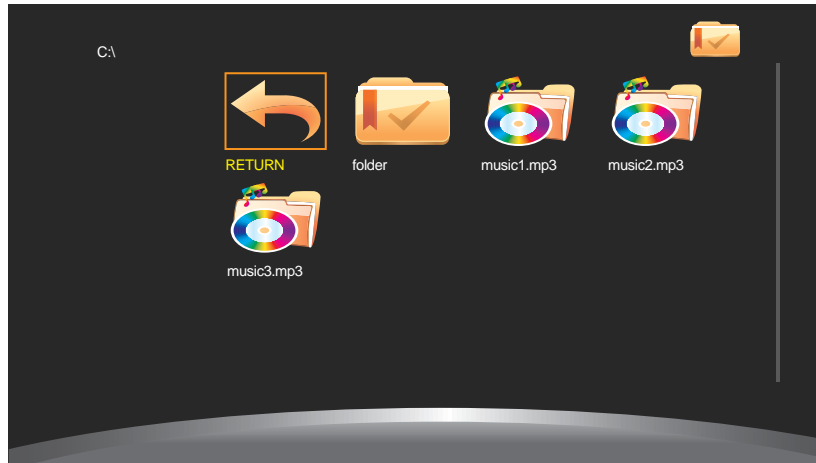

Note: If you receive an error message while trying to open the music file, probably the file format is not supported. Refer to page 49.





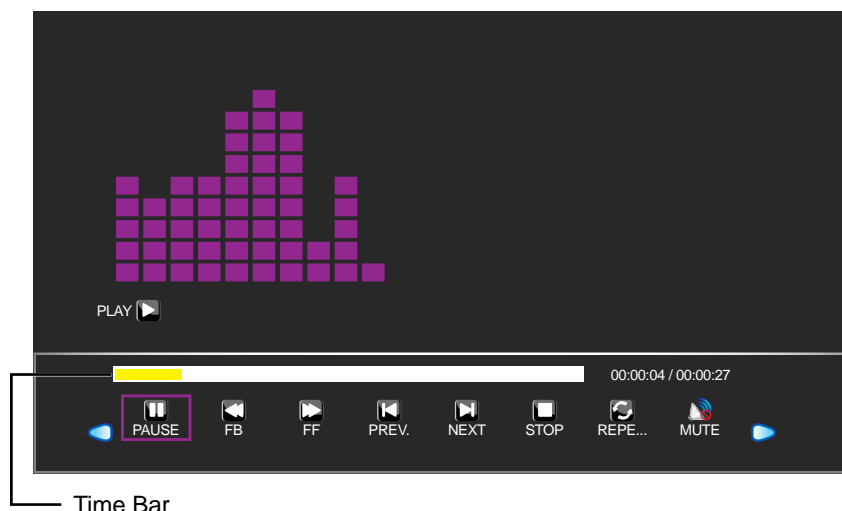



3. By default, all available music files that are saved in the same folder on the USB storage are included in the playlist. To control the playback, press the **▲/▼** button on the control panel or the remote control to select the control button. Then press the **AUTO** button on the control panel or the **OK** button on the remote control to perform the function.

Note: If you cannot see the control bar, press the **AUTO** button on the control panel or the **OK** button on the remote control. To hide the control bar, press the **MENU** button on the control panel or the **▼** or the **EXIT** button on the remote control.





- : Move to the left or to the right to select control bar buttons.
- "PLAY" / "PAUSE": The music playback starts automatically after you choose a music file. Select to pause the playback. Select to resume the playback.
- "FB.": Press repeatedly to fast-reverse the track 2x, 4x, 8x, or 16x.
- "FF": Press repeatedly to fast-forward the track 2x, 4x, 8x, or 16x.

USING THE LCD DISPLAY

-  “PREV.”: Play the previous track.
-  “NEXT”: Play the next track.
-  “STOP”: Stop the playback and return to the browser view.
-  “REPEAT.. / REPEAT 1 / REPEAT ALL”: Select “REPEAT...” to play the track once and return to the browser view. Select “REPEAT 1” to repeat one and the same track continuously. Select “REPEAT ALL” to repeat the entire playback continuously.
-  “MUTE”: Mute audio. Select  again to unmute.
-  “PLAYLIST”: List all music files in the playback. To open a specific file, select it. To exit the playlist, select “CANCEL”.
-  “INFO”: Display the current music file details. Select “CLOSE” to exit the information menu.
-  “Goto Time”: Go to a certain time in music playback. Press the number buttons on the remote control to input the search time to the “INPUT SEARCH TIME:” window. After done, press OK.

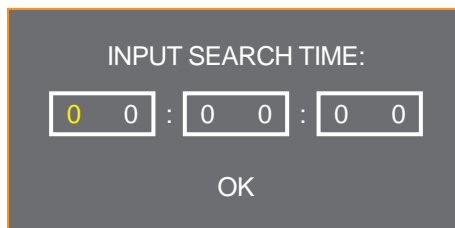
Note: The search time can be entered only by using the remote control.



4. Select the  (“STOP”) button on the control bar to return to the browser view. You can also press the MENU button (repeatedly if necessary) on the LCD display or the MENU or EXIT button (repeatedly if necessary) on the remote control to end the playback and return to the browser view.

3.9.4 Watching Movie

1. Press the  button on the control panel or the remote control to select your favorite movie file.

Note: After you select a film file, a preview of it with details will open on the left side of the browser. Details include information on resolution (“RES.”), audio (“AUDIO...”), subtitle (“Subtitle”), program (“PROGRAM”), and file size (“SIZE”).

2. Press the AUTO button on the control panel or the OK button on the remote control to open the video playback.

USING THE LCD DISPLAY



Note: If you receive an error message while trying to open the video file, probably the file format is not supported. Refer to page 49.

3. By default, all available video files that are saved in the same folder on the USB storage are included in the playlist. To control the playback, press the ▲/▼ button on the control panel or the remote control to select the control button. Then press the AUTO button on the control panel or the OK button on the remote control to perform the function.









Note: If you cannot see the control bar, press the AUTO button on the control panel or the OK button on the remote control. To hide the control bar, press the MENU button on the control panel or the ▼ or the EXIT button on the remote control.



Time Bar





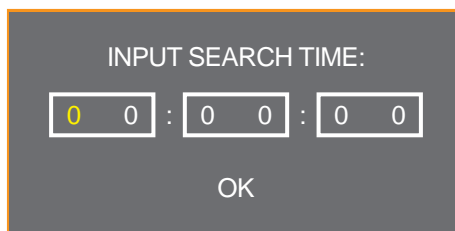

- ◀▶: Move to the left or right to select control bar buttons.
- ▶ "PLAY" / ⏸ "PAUSE": The film playback starts automatically after you choose a video file. Select "▶" to pause the playback. Select "⏸" to resume the playback.
- ◀ "FB.": Press repeatedly to fast-reverse the film 2x, 4x, 8x, 16x, or 32x.
- ▶ "FF": Press repeatedly to fast-forward the film 2x, 4x, 8x, 16x, or 32x.
- ◀ "PREV.": Play the previous movie.

USING THE LCD DISPLAY

-  “NEXT”: Play the next movie.
-  “STOP”: Stop the playback and return to the browser view.
-  “REPEAT.. / REPEAT 1 / REPEAT ALL”: Select “REPEAT...” to play the film once and return to the browser view. Select “REPEAT 1” to repeat one and the same film continuously. Select “REPEAT ALL” to repeat the entire playback continuously.
-  “SET A / SET B / NONE”: Save settings for “SET A” and “SET B”. Select “NONE” to use the default settings.
-  “PLAYLIST”: List all film files in the playback. To open a specific file, select it. To exit the playlist, select “CANCEL”.
-  “INFO”: Display the current music file details. Select “CLOSE” to exit the information menu.
-  “Slow FW”: Press repeatedly to slow-forward the film 2x, 4x, 8x, or 16x.
-  “Step FW”: Press repeatedly to move forward frame by frame.
-  “Goto Time”: Go to a certain time in film playback. Press the number buttons on the remote control to input the search time to the “INPUT SEARCH TIME:” window. After done, press OK.

Note: The search time can be entered only using the remote control.



-  “ZOOM IN”: Pause the film first then zoom in on the current frame 1/4x, 1/2x, 1x, 2x, 4x, or 8x. The zoom ratio is displayed on the screen.
-  “ZOOM OUT”: Zoom out on the current frame 8x, 4x, 2x, 1x, 1/2x, or 1/4x. The zoom ratio is displayed on the screen.
-  “ASPECT”: Select the suitable aspect ratio among “4:3”, “NATIVE”, and “16:9”. While changing the aspect ratio, the currently selected ratio is displayed on the screen for reference.
-  “Move...”: After you have zoomed in on the frame, press the  button on the control panel or the  button on the remote control to move any location on the frame.
The navigation directions (green arrows) icon is displayed on the screen.

Navigation Directions



Press the AUTO button on the control panel or the OK button on the remote control to return to the control bar and select  to resume the movie.

USING THE LCD DISPLAY

4. Select the “ (STOP)” button on the control bar to return to the browser view. You can also press the MENU button (repeatedly if necessary) on the LCD display or the MENU or EXIT button (repeatedly if necessary) on the remote control to end the playback and return to the browser view.

3.9.5 Viewing Text Files

1. Press the ▲/▼ button on the control panel or the remote control to select your favorite text file.

Note: After you select a text file, a preview of it with file size will open on the left side of the browser.

2. Press the AUTO button on the control panel or the OK button on the remote control to open the text file on the screen.







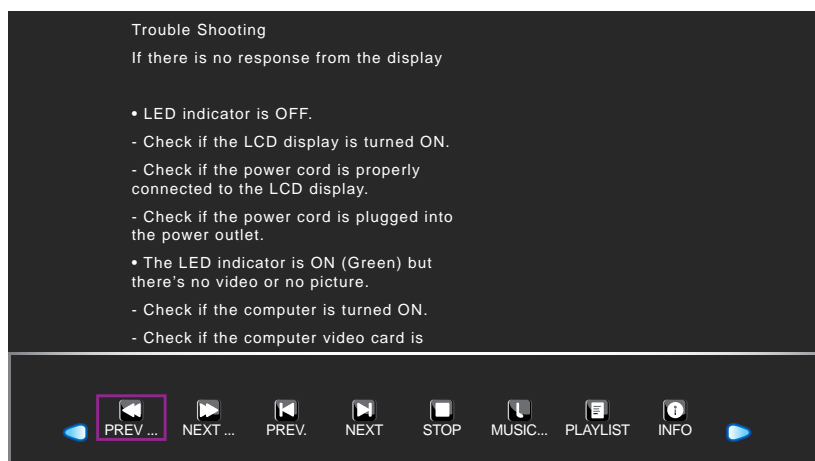

3. By default, all text files that are saved in the same folder on the USB storage are included in the playlist. To control displaying text files on the screen, press the ▲/▼ button on the control panel or the remote control to select the control button. Then press the AUTO button on the control panel or the OK button on the remote control to perform the function.



Note: If you cannot see the control bar, press the AUTO button on the control panel or the OK button on the remote control. To hide the control bar, press the MENU button on the control panel or the ▼ or the EXIT button on the remote control.



USING THE LCD DISPLAY

- : Move to the left or to the right to select control bar buttons.
-  “PREV ...”: Move to the previous page in the document.
-  “NEXT ...”: Move to the next page in the document.
-  “PREV.”: Open the previous document in the playlist.
-  “NEXT”: Open the next document in the playlist.
-  “STOP”: Stop displaying the document and return to the browser view.
-  “MUSIC ON/OFF”: Select “MUSIC ON” to play music while viewing the document. Select “MUSIC OFF” to mute audio. The music file needs to be placed in the same folder of the PHOTO file.

Note: To adjust volume during the slideshow, refer to page 23.

-  “PLAYLIST”: List all document files in the playback. To open a specific file, select it. To exit the playlist, select “CANCEL”.
 -  “INFO”: Display the current music file details. Select “CLOSE” to exit the information menu.
4. Select the “ (STOP)” button on the control bar to return to the browser view. You can also press the MENU button (repeatedly if necessary) on the LCD display or the MENU or EXIT button (repeatedly if necessary) on the remote control to end the playback and return to the browser view.

3.10 Upgrading Firmware



To upgrade firmware, do the following:

1. Save the upgrade file to the root directory of the USB storage.
2. Connect the USB storage to the USB port on the LCD display. Refer to page 21.
3. After the power cord is plugged in, the LCD display will be updated automatically. After the front panel indicator flashes, the system will start upgrading the firmware automatically when the LCD display is powered on.

Wait until the firmware upgrade is complete.

CHAPTER 4: ON SCREEN DISPLAY MENU

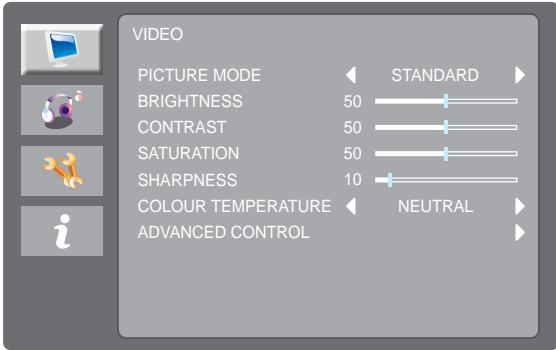
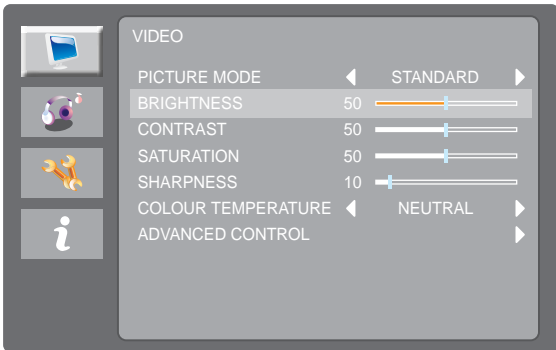
4.1 Using the OSD Menu

#	Menu Navigation	Operation	
		Control Panel	Remote Control
1	<p>Display the main menu screen.</p> 	Press MENU.	Press MENU.
2	<p>Enter the submenu.</p>  <p>The highlighted item (light grey bar) indicates the active submenu item.</p>	<ol style="list-style-type: none"> 1 Press ▲/▼ to select the main menu item. 2 Press AUTO to enter the submenu. 3 Press ▲/▼ to select the submenu item. 4 Press AUTO to enter adjustment mode. 	<ol style="list-style-type: none"> 1 Press ▲/▼ to select the main menu item. 2 Press OK or ► to enter the submenu. 3 Press ▲/▼ to select the submenu item. 4 Press OK to enter adjustment mode.
3	<p>Adjust the settings.</p> <p>For example:</p> 	Press AUTO (repeatedly) to change the setting or press ▲/▼ to adjust the value.	Press OK (repeatedly) to change the setting or press ◀/▶ to adjust the value.
4	<p>Return to the previous menu and/or close the OSD window.</p>	Press MENU once to return to the previous menu. Press MENU repeatedly to close the OSD window.	Press MENU to move to the previous menu. Press MENU repeatedly or press EXIT to close the OSD window.

Note: When settings are modified, all changes are saved when the user does the following:

- Proceeds to another menu
- Exits the OSD menu
- Waits for the OSD menu to disappear

ON SCREEN DISPLAY MENU

4.2 OSD Menu Tree

Main Menu	Submenu	Reference
VIDEO	PICTURE MODE	Refer to page 39.
	BRIGHTNESS	
	CONTRAST	
	SATURATION	
	TINT	
	SHARPNESS	
	COLOUR TEMPERATURE	
	ADVANCED CONTROL	
AUDIO	SOUND MODE	Refer to page 44.
	BALANCE	
	BASS	
	TREBLE	
	VIRTUAL SURROUND	
	AUTO VOLUME	
SETTING	LANGUAGE	Refer to page 45.
	BACKLIGHT	
	OSD TIMER	
	OSD TRANSPARENCY	
	POWER SAVING	
	SOURCE DETECT	
	BLUE SCREEN	
	COLOUR SYSTEM	
	ANTI-BUTN-IN	
	RESET DEFAULT	
INFORMATION	INPUT:	Refer to page 47.
	F/W VERSION:	

Note: Availability of some menu items depend on the input source signal. If the menu is not available, it is disabled and greyed out.



CHAPTER 5: ADJUSTING THE LCD DISPLAY

5.1 VIDEO Menu

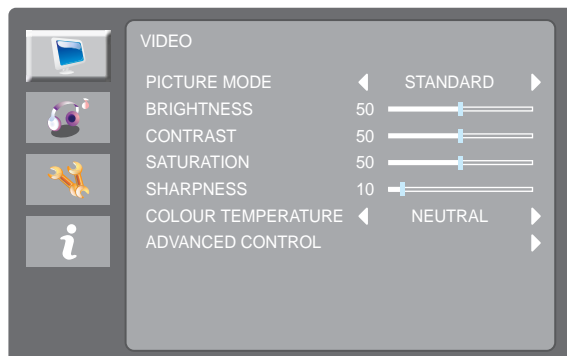
1. Press **MENU** on the control panel or on the remote control to call out the OSD window.
2. Press **▲/▼** on the control panel or the remote control to select  and then press **AUTO** on the control panel or **OK/▶** on the remote control to enter the **AUDIO** menu.



3. Press **▲/▼** on the control panel or the remote control to select an option and press **AUTO** on the control panel or **OK** on the remote control to enter its submenu.

Item	Function	Operation	Range
PICTURE MODE	Selects a predefined picture mode setting. Note: The recommended PICTURE MODE for optimised PC source is STANDARD and ASPECT RATIO is 16:9. In optimised mode, SATURATION, SHARPNESS, COLOUR RANGE, and CONTRAST ENHANCER parameters cannot be modified.	Press AUTO on the control panel or OK on the remote control repeatedly.	STANDARD VIDEO CCTV
BRIGHTNESS	Adjusts the luminance of the screen image.	<ol style="list-style-type: none"> 1 Press AUTO on the control panel or OK on the remote control. 2 Press ▲/▼ on the control panel or ◀▶ on the remote control to adjust the value. 	0 to 100
<div style="display: flex; justify-content: space-around;"> <div style="text-align: center;"> <p><i>Original Setting</i></p>  </div> <div style="text-align: center;"> <p><i>High Setting</i></p>  </div> <div style="text-align: center;"> <p><i>Low Setting</i></p>  </div> </div>			

ADJUSTING THE LCD DISPLAY

Item	Function	Operation	Range
CONTRAST	Adjusts the difference between the black level and the white level.	<ol style="list-style-type: none"> 1 Press AUTO on the control panel or OK on the remote control. 2 Press ▲/▼ on the control panel or on the remote control to adjust the value. 	0 to 100
SATURATION	Adjusts the colour saturation. Note: This menu item is only available if the input source is HDMI, DVI, or CVBS.	<ol style="list-style-type: none"> 1 Press AUTO on the control panel or OK on the remote control. 2 Press ▲/▼ on the control panel or on the remote control to adjust the value. 	0 to 100
TINT	Adjusts the colour tint. Note: This menu item is only available if the input source is CVBS (NTSC format).		0 to 100
SHARPNESS	Adjusts the clarity and focus of the screen image. Note: This menu item is only available if the input source is HDMI, DVI, or CVBS.		0 to 100

ADJUSTING THE LCD DISPLAY

Item	Function	Operation	Range
COLOUR TEMPERATURE	Provides several colour adjustment settings. <div style="border: 1px solid orange; padding: 5px; margin: 10px 0;"> COLOUR TEMPERATURE NEUTRAL RED129 GREEN119 BLUE115 </div>	Press AUTO on the control panel or OK on the remote control repeatedly.	COOL NEUTRAL WARM USER
	Colour temperature can be set to: <ul style="list-style-type: none"> • “COOL” - Applies a bluish tint for cooler colours. • “NEUTRAL” - This is the default colour temperature commonly used for normal lighting conditions. • “WARM” - Applies a reddish tint for warmer colours. • “USER” - This allows users to set the colour temperature by adjusting the red, green, or blue setting according to one’s preference. <ol style="list-style-type: none"> a. Select “USER” and press ▼ on the control panel or remote control. b. Press AUTO on the control panel or OK on the remote control to enter “RED” settings. c. Press ▲/▼ on the control panel or ◀▶ on the remote control to adjust the value (0 to 255). d. When done, press MENU on the control panel or remote control to return to the previous menu. e. Repeat steps “b” to “d” for adjusting green and blue colour. 		
ADVANCED CONTROL	Configures advanced control settings.	Press AUTO on the control panel or OK on the remote control.	-
	<ul style="list-style-type: none"> • “NOISE REDUCTION” - Reduces the noise in the picture due to poor reception or poor picture quality. 	<ol style="list-style-type: none"> 1 Press AUTO on the control panel or OK on the remote control. 	OFF LOW MIDDLE HIGH
	<ul style="list-style-type: none"> • “COLOR RANGE” - Adjusts black and white levels for video. Note: This menu item is only available if the input source is HDMI. 	<ol style="list-style-type: none"> 2 Press ▲/▼ on the control panel or on the remote control to select an item. 3 Press AUTO on the control panel or OK on the remote control to enter adjustment mode. 4 Press AUTO on the control panel or OK on the remote control repeatedly. 	FULL LIMIT

ADJUSTING THE LCD DISPLAY

Item	Function	Operation	Range
ADVANCED CONTROL	<ul style="list-style-type: none"> • “DCR (Dynamic Contrast Ratio)” - Automatically adjust the backlight range according to the display screen, such as when watching movies. DCR is suitable for indoor viewing. Note: This menu item is only available if the input source is HDMI. 	<ol style="list-style-type: none"> 1 Press AUTO on the control panel or OK on the remote control. 2 Press ▲/▼ on the control panel or on the remote control to select an item. 	OFF ON
	<ul style="list-style-type: none"> • “CONTRAST ENHANCER” - Automatic adjustment of picture brightness and contrast at high speed and dynamic contrast range, such as when watching movies. Note: This menu item is only available if the input source is HDMI. 	<ol style="list-style-type: none"> 3 Press AUTO on the control panel or OK on the remote control to enter adjustment mode. 4 Press AUTO on the control panel or OK on the remote control repeatedly. 	OFF ON
	<ul style="list-style-type: none"> • “ASPECT RATIO” - Adjusts the aspect ratio of the screen image. Note: The ZOOM1 and ZOOM2 options are only available if the input source is CVBS. 		16:9 4:3 NATIVE ZOOM1 ZOOM2
AUTO ADJUST	Configures auto adjustment settings. Note: This menu item is only available if the input source is VGA.	Press AUTO on the control panel or OK on the remote control.	-
	<ul style="list-style-type: none"> • “AUTO ADJUST” - Automatically tunes the LCD display to its optimal setting, including horizontal position, vertical position, clock, and phase. 	<ol style="list-style-type: none"> 1 Press ▲/▼ on the control panel or on the remote control to select an item. 2 Press AUTO on the control panel or OK on the remote control to execute automatic adjustment. 	-

ADJUSTING THE LCD DISPLAY

Item	Function	Operation	Range
AUTO ADJUST	<ul style="list-style-type: none"> • “H.POSITION (Horizontal Position)” - Moves the screen image to the left or right. 	<ol style="list-style-type: none"> 1 Press ▲/▼ on the control panel or on the remote control to select an item. 2 Press AUTO on the control panel or OK on the remote control to execute automatic adjustment. 3 Press ▲/▼ on the control panel or ◀▶ on the remote control to adjust the value. 	0 to 100
	<ul style="list-style-type: none"> • “V.POSITION (Vertical Position)” - Moves the screen image up or down. 		0 to 100
	<ul style="list-style-type: none"> • “PHASE” - Adjusts the phase timing to synchronise with the video signal. 		0 to 100
	<ul style="list-style-type: none"> • “CLOCK” - Adjusts the frequency timing to synchronise with the video signal. 		0 to 100
AUTO COLOUR	<p>Operates the white balance and automatically adjusts the colour settings.</p>  <p>Note: This menu item is only available if the input source is VGA.</p>	Press AUTO on the control panel or OK on the remote control.	-

ADJUSTING THE LCD DISPLAY

5.2 AUDIO Menu

1. Press MENU on the control panel or on the remote control to call out the OSD window.
2. Press ▲/▼ on the control panel or the remote control to select  and then press AUTO on the control panel or OK/▶ on the remote control to enter the AUDIO menu.

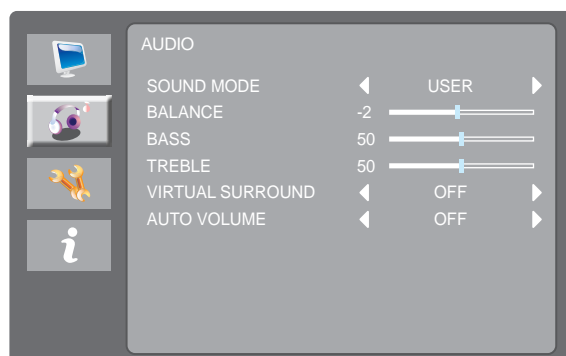

3. Press ▲/▼ on the control panel or the remote control to select an option and press AUTO on the control panel or OK on the remote control to enter its submenu.

Item	Function	Operation	Range
SOUND MODE	<p>Selects a predefined sound mode setting.</p> <ul style="list-style-type: none"> • “USER” - This allows users to configure balance, bass, and treble settings according to one’s preference. <ol style="list-style-type: none"> a. Select “USER” and press ▼ on the control panel or remote control. b. Press AUTO on the control panel or OK on the remote control to enter “BALANCE” adjustment. c. Press ▲/▼ on the control panel or ◀▶ on the remote control to adjust the value (-50 to 50). d. When done, press MENU on the control panel or remote control to return to the previous menu. <p>Note: Press ▲/▼ on the control panel or ◀▶ on the remote control to adjust the bass (0 to 100) and treble (0 to 100) settings.</p>	Press AUTO on the control panel or OK on the remote control repeatedly.	STANDARD MUSIC MOVIE SPORTS USER
VIRTUAL SURROUND	Provides an enhanced listening experience.		OFF ON
AUTO VOLUME	Automatically remains at the same volume level if you change the program.		OFF ON

ADJUSTING THE LCD DISPLAY

5.3 SETTING Menu

1. Press **MENU** on the control panel or on the remote control to call out the OSD window.
2. Press **▲/▼** on the control panel or the remote control to select  and then press **AUTO** on the control panel or **OK/▶** on the remote control to enter the **SETTING** menu.

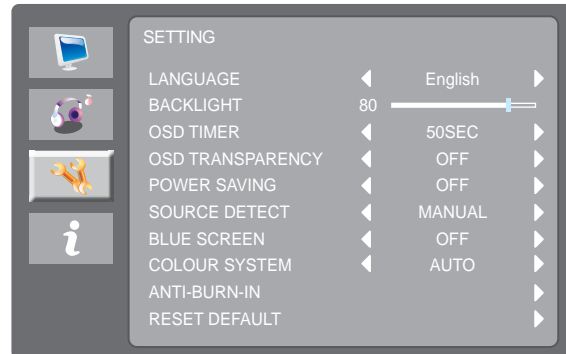

3. Press **▲/▼** on the control panel or the remote control to select an option and press **AUTO** on the control panel or **OK** on the remote control to enter its submenu.

Item	Function	Operation	Range
LANGUAGE	Choose the language used for OSD menus.	Press AUTO on the control panel or OK on the remote control repeatedly.	English Español Français Deutsch 简体中文 繁體中文
BACKLIGHT	Adjusts the luminance of the screen image.	<ol style="list-style-type: none"> 1 Press AUTO on the control panel or OK on the remote control. 2 Press ▲/▼ on the control panel or ◀▶ on the remote control to adjust the value. 	0 to 100
OSD TIMER	Sets the length of time (in seconds) the OSD screen is displayed. When the time elapses, the OSD screen is automatically inactivated.	Press AUTO on the control panel or OK on the remote control repeatedly.	OFF 10SEC 20SEC 30SEC 40SEC 50SEC 60SEC
OSD TRANSPARENCY	Adjusts the OSD transparency.		OFF LOW MIDDLE HIGH

ADJUSTING THE LCD DISPLAY

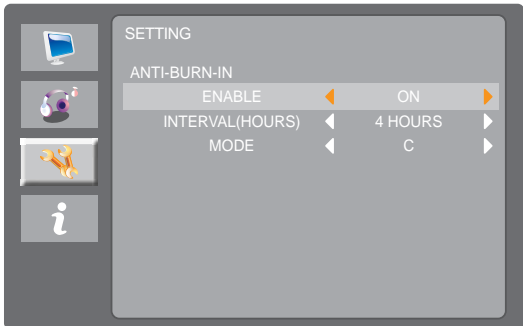
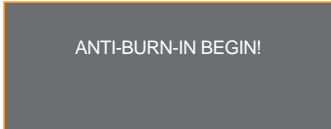
Item	Function	Operation	Range
POWER SAVING	Enables or disables power saving mode. Note: The amount of time for the display to enter power saving varies depending on the "SOURCE DETECT" setting. If the "SOURCE DETECT" is set to "AUTO", the display checks all input source signals before entering power saving mode if no signal is detected; this takes up more time. If the "SOURCE DETECT" is set to "MANUAL", the display enters power saving mode right away	Press AUTO on the control panel or OK on the remote control repeatedly.	OFF ON
SOURCE DETECT	Sets the display to automatically or manually detect the input source signal.		MANUAL AUTO
BLUE SCREEN	If no input signal is available, the background of the screen is blue.		OFF ON
COLOUR SYSTEM	Select the input signal system. Note: This menu item is only available if the input source is CVBS.	Press AUTO on the control panel or OK on the remote control repeatedly.	AUTO PAL PAL 60 NTSC NTSC 443 SECAM
ANTI-BURN-IN	Protects the display from "burn-in" or "afterimage" symptoms when the display has not being used for a period of time.  Note: When Anti-Burn-in™ starts, you will see the following notification: 	Press AUTO on the control panel or OK on the remote control.	-

ADJUSTING THE LCD DISPLAY

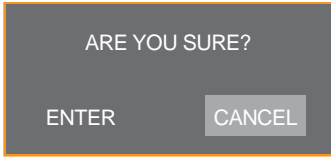
Item	Function	Operation	Range
ANTI-BURN-IN	<ul style="list-style-type: none"> • “ENABLE” - Enables or disables Anti-Burn-in™ function. 	Press AUTO on the control panel or OK on the remote control repeatedly.	OFF ON
	<ul style="list-style-type: none"> • “INTERVAL(HOURS)” - Selects the interval time (hour) between activating the Anti-Burn-in™ function. 		4 HOURS 5 HOURS 6 HOURS 8 HOURS
	<ul style="list-style-type: none"> • “MODE” - Set the Anti-Burn-in™ mode to “A” (execute fast), “B” (slower but more precise than mode “A”), or C (slowest but the most precise mode). 		A B C
RESET DEFAULT	Resets all settings to the factory defaults. 	<ol style="list-style-type: none"> 1 Press AUTO on the control panel or OK on the remote control. 2 Press ▲/▼ on the control panel or ◀▶ on the remote control to select “ENTER” or “CANCEL”. 3 Press AUTO on the control panel or OK on the remote control. 	ENTER CANCEL

5.4 INFO Menu

1. Press MENU on the control panel or on the remote control to call out the OSD window.
2. Press ▲/▼ on the control panel or the remote control to select  and then press AUTO on the control panel or OK/▶ on the remote control to enter the INFO menu.

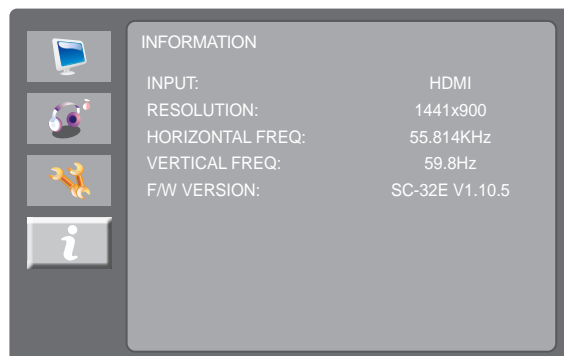



3. Review current input source, resolution, horizontal and vertical frequencies, and firmware version.

CHAPTER 6: APPENDIX

6.1 Warning Messages

When any of these warning messages appear, check the following items.

Warning Message	Cause	Solution
INVALID FORMAT	The resolution or the refresh rate of the graphics card of the computer is set too high.	√ Change the resolution or the refresh rate of the graphics card.
NO SIGNAL	The LCD display cannot detect the input source signal.	<ul style="list-style-type: none"> √ Check if the input source is turned ON. √ Check if the signal cable is properly connected. √ Check if any pin inside the cable connector is twisted or broken.
KEYPAD LOCK	Keypad has been locked.	<ul style="list-style-type: none"> √ Press the AUTO key for 5 seconds to enable/disable the KEY LOCK (w/o POWER) function. √ Press MENU button for 5 seconds to enable/disable the KEY LOCK (ALL) function.
 INVALID OPERATION	Playback control function is not supported in multimedia mode.	√ Use other control functions to control playback.
NOT AVAILABLE	The function that the specific remote control button should perform is not supported.	√ Use other remote control functions.
 UNSUPPORTED FILE	The file you want to play in multimedia mode is not supported.	√ Convert the file to the supported format.

CHAPTER 6: APPENDIX

6.2 USB Multimedia Formats and Resolutions

Note:

- ◆ The multimedia formats and resolutions in this section apply to the multimedia content on USB 2.0 compatible USB storage device.

Picture

Picture		
JPG	3840 x 2160	640 x 480
	2400 x 1800	320 x 240
	1024 x 768	176 x 144

Video

Video		
AVI	AVC	720p
		480p
		360p
	DIVX	720p
		480p
		360p
	MJPEG PCM	320 x 240
	XVID	720p
		480p
		360p
FLV	FLV	1080p
		720p
		480p
		360p
	AVC	1080p
		720p
		480p
		360p
MKV	AVC	1080p
		720p
		480p
		360p
	HEVC	1080p
		720p
		480p
		360p

CHAPTER 6: APPENDIX

Video		
MOV	AVC	720p
		480p
		360p
		240p
	DIVX	720p
		480p
		360p
		240p
MOV	HEVC	1080p
		720p
		480p
		360p
MP4	AVC	1080p
		720p
		480p
		360p
	DIVX	1080p
		720p
		480p
		360p
	HEVC	1080p
		720p
		480p
		360p
MPG	SVCD NTSC	
	SVCD PAL	
	VCD NTSC	
	VCD PAL	

Audio

Audio	
AAC	MP3 VBR
M4a	OGG
MP3	

Text

Text
TXT

Note:

- ◆ Audio or video may not work if the contents have a standard bit rate/frame rate above the compatible Frame/sec listed in the table above.
- ◆ Video content with a Bit rate or Frame rate larger than the rate specified in the table above can cause choppy video during playback.



CHAPTER 6: APPENDIX

6.3 Timing

VGA	DVI	HDMI
720 x 400p @ 70 Hz	720 x 400p @ 70 Hz	1920 x 1080p at 50 Hz
640 x 480p @ 60 Hz	640 x 480p @ 60 Hz	1920 x 1080p at 60 Hz
640 x 480p @ 72 Hz	640 x 480p @ 72 Hz	1920 x 1080i at 50 Hz
640 x 480p @ 75 Hz	640 x 480p @ 75 Hz	1280 x 720p at 50 Hz
800 x 600p @ 56 Hz	800 x 600p @ 56 Hz	720 x 576p at 50 Hz
800 x 600p @ 60 Hz	800 x 600p @ 60 Hz	720 x 576i at 50 Hz
800 x 600p @ 72 Hz	800 x 600p @ 72 Hz	640 x 480p at 60 Hz
800 x 600p @ 75 Hz	800 x 600p @ 75 Hz	1280 x 720p at 60 Hz
1024 x 768p @ 60 Hz	1024 x 768p @ 60 Hz	1920 x 1080i at 60 Hz
1024 x 768p @ 70 Hz	1024 x 768p @ 70 Hz	720 x 480i at 60 Hz
1024 x 768p @ 75 Hz	1024 x 768p @ 75 Hz	720 x 480p at 60 Hz
1280 x 1024p @ 60 Hz	1280 x 1024p @ 60 Hz	1920 x 1080p at 24 Hz
1366 x 768p @ 60 Hz	1366 x 768p @ 60 Hz	1920 x 1080p at 25 Hz
1600 x 900p @ 60 Hz	1600 x 900p @ 60 Hz	1920 x 1080p at 30 Hz
1440 x 900p @ 60 Hz	1440 x 900p @ 60 Hz	
1280 x 720p @ 60 Hz	1280 x 720p @ 60 Hz	
1152 x 864p @ 75 Hz	1152 x 864p @ 75 Hz	
1920 x 1080p @ 60 Hz	1920 x 1080p @ 60 Hz	

APPENDIX

6.4 Troubleshooting

Problems	Possible Cause and Solution
<p>No picture.</p> <ul style="list-style-type: none"> LED indicator is OFF. 	<ul style="list-style-type: none"> Check if the LCD display is turned ON. Check if the power cord is properly connected to the LCD display. Check if the power cord is plugged into the power outlet.
<ul style="list-style-type: none"> LED indicator is green. 	<ul style="list-style-type: none"> Check if the computer is turned ON. Check if the computer is in standby mode, move the mouse or press any button to wake up the computer.
Image position is incorrect.	<ul style="list-style-type: none"> For VGA input, adjust the "H. POSITION" and "V. POSITION" settings in "VIDEO () > AUTO ADJUST" menu (refer to page page 43).
The displayed texts are blurry.	<ul style="list-style-type: none"> For VGA input, adjust the "CLOCK" and "PHASE" settings in "VIDEO () > AUTO ADJUST" menu (refer to page page 43).
Red, blue, green, white dots appear on the screen.	<ul style="list-style-type: none"> There are millions of micro transistors inside the LCD display. It is normal for a few transistors to be damaged and to produce spots. This is acceptable and is not considered a failure.
No audio output.	<ul style="list-style-type: none"> Check if the volume is set to 0 (refer to page 23) or mute is on. For VGA input, check the audio setting of the computer.
Dew formed on the LCD display.	<ul style="list-style-type: none"> This normally happens when the LCD display is moved from a cold room to a hot room temperature. Do not turn ON the LCD display, wait for the dew condensation to disappear.
Faint shadows from a static image appear on the screen.	<ul style="list-style-type: none"> Turn off the LCD display for extended periods of time. Use a screen saver or a black and white image and run it for extended periods of time.
In multimedia mode, your image, music, video, or text file is not visible in browser view.	<ul style="list-style-type: none"> Make sure you opened the image file in "PHOTO" folder, music file in "MUSIC" folder, video file in "MOVIE" folder, and text file in "TEXT" folder. Make sure the format of your file is supported. Refer to page 49.

6.5 Transporting the LCD Display

To transport the LCD display for repair or shipment, place the display in its original packaging box.

1. Remove the base stand (for SC-32E/SC-42E).

- a. Remove the screws securing the base stand to the base mount on the LCD display.
- b. Detach the base stand from the base mount.

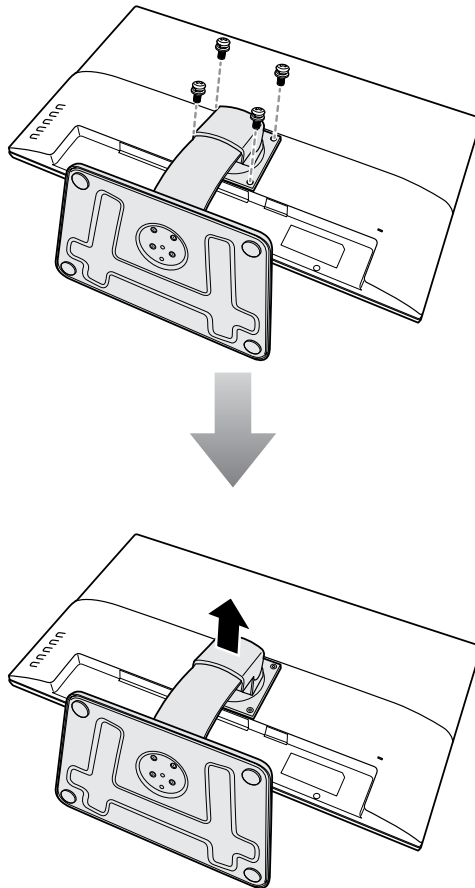

2. Remove the base (for SC-32E/SC-42E).

- a. Remove the screws securing the base to the stand.
- b. Detach the base from the stand.

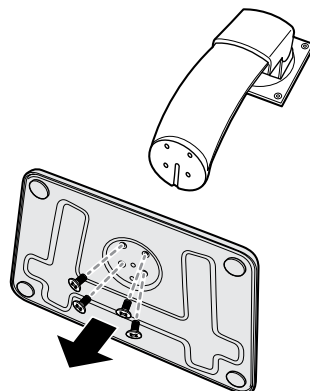

APPENDIX

3. Place the LCD display inside the supplied protective bag.
4. Place the lower foam cushions inside the box.
5. Place the LCD display down in the box.
6. Place the upper foam cushions on the top of the LCD display.
7. Place the accessories on the designated area (if necessary).
8. Close and tape the box.

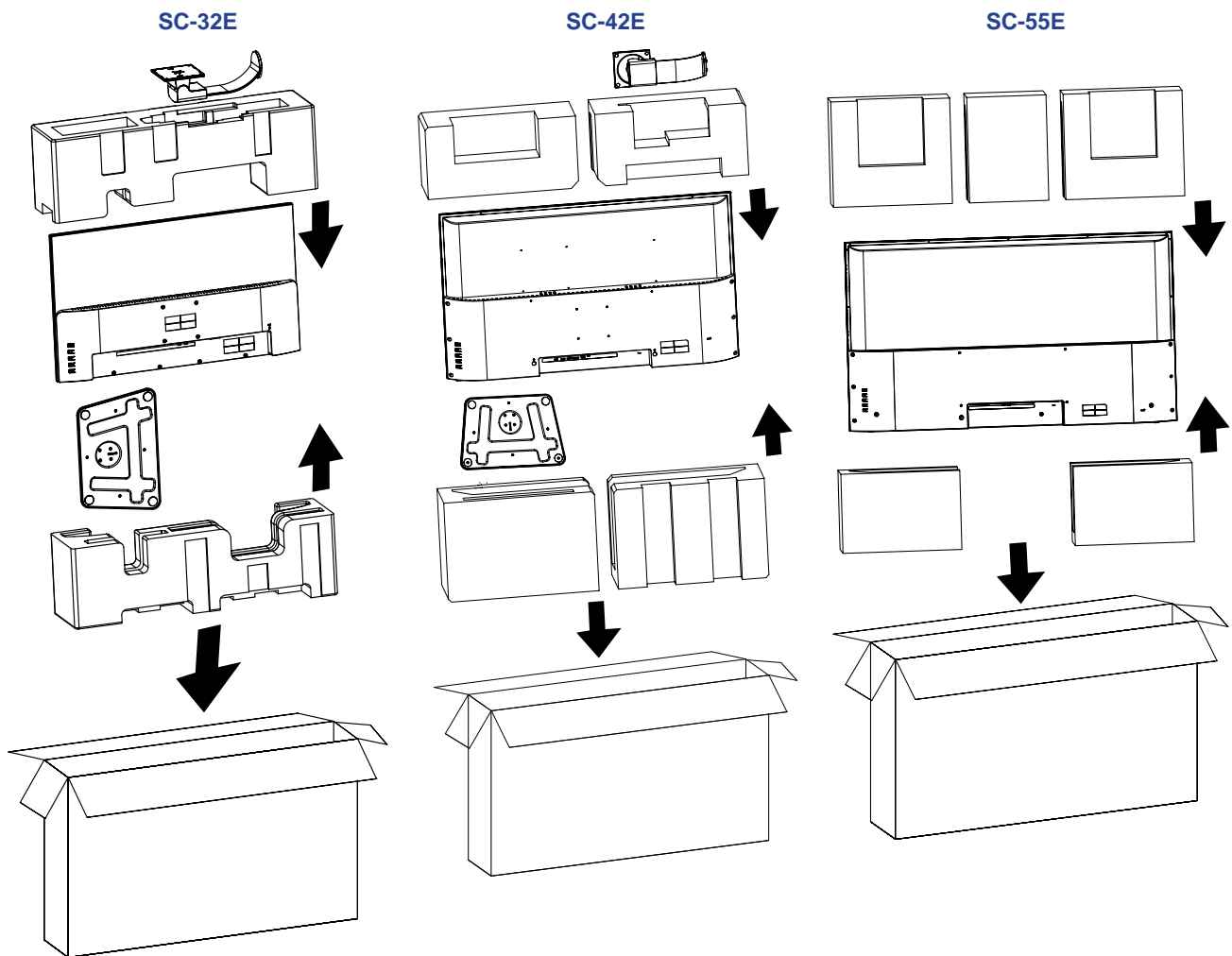

Note:

- It is recommended to use the original packaging box.
- When repacking, carefully place the LCD display in its box and protect the glass panel from touching any object.

CHAPTER 7: SPECIFICATIONS

7.1 Display Specifications

		SC-32E	SC-42E	SC-55E
Panel	Panel Type	LED-Backlit TFT LCD (VA Technology)	LED-Backlit TFT LCD (IPS Technology)	LED-Backlit TFT LCD (VA Technology)
	Panel Size	31.5"	42.5"	55"
	Max. Resolution	FHD 1920 x 1080	FHD 1920 x 1080	FHD 1920 x 1080
	Pixel Pitch	0.364 mm	0.490 mm	0.630 mm
	Brightness	300 cd/m ²	300 cd/m ²	350 cd/m ²
	Contrast Ratio	20,000,000:1 (DCR)	20,000,000:1 (DCR)	20,000,000:1 (DCR)
	Viewing Angle (H/V)	178°/178°	178°/178°	178°/178°
	Display Colour	16.7M	16.7M	16.7M
	Response Time	5 ms	5 ms	5 ms
	Surface Treatment	Anti-Glare Treatment (Haze 25%), 2H Hard Coating	Anti-Glare Treatment (Haze 1%), 3H Hard Coating	Anti-Glare Treatment (Haze 2%), 3H Hard Coating
	Frequency (H/V)	H Freq.	30 kHz-85 KHz	30 kHz-85 KHz
V Freq.		48 Hz-75 Hz	48 Hz-75 Hz	48 Hz-75 Hz
Input	HDMI	1.4 x 1	1.4 x 1	1.4 x 1
	DVI	24-Pin DVI-D x 1	24-Pin DVI-D x 1	24-Pin DVI-D x 1
	VGA	15-Pin D-Sub x 1	15-Pin D-Sub x 1	15-Pin D-Sub x 1
	Composite	BNC x 1	BNC x 1	BNC x 1
Output	Composite	BNC x 1	BNC x 1	BNC x 1
Other Connectivity	USB	2.0 x 1 (Service port / Media playback)	2.0 x 1 (Service port / Media playback)	2.0 x 1 (Service port / Media playback)
Audio	Audio In	Stereo Audio Jack (3.5 mm)	Stereo Audio Jack (3.5 mm)	Stereo Audio Jack (3.5 mm)
	Audio Out	Stereo Audio Jack (3.5 mm)	Stereo Audio Jack (3.5 mm)	Stereo Audio Jack (3.5 mm)
	Internal Speakers	3W x 2	3W x 2	3W x 2
Power	Power Supply	Internal	Internal	Internal
	Power Requirements	AC 100-240V, 50/60 Hz	AC 100-240V, 50/60 Hz	AC 100-240V, 50/60 Hz
	On Mode	46W (On)	61W (On)	84W (On)
	Stand-by Mode	< 0.5W	< 0.5W	< 0.5W
	Off Mode	< 0.5W	< 0.5W	< 0.5W
Operating Conditions	Temperature	5°C-35°C (41°F-95°F)	5°C-35°C (41°F-95°F)	5°C-35°C (41°F-95°F)
	Humidity	20%-85% (non-condensing)	20%-85% (non-condensing)	20%-85% (non-condensing)
Storage Conditions	Temperature	-20°C-60°C (-4°F-140°F)	-20°C-60°C (-4°F-140°F)	-20°C-60°C (-4°F-140°F)
	Humidity	5%-85% (non-condensing)	5%-85% (non-condensing)	5%-85% (non-condensing)
Mounting	VESA FPMPMI	Yes (100 x 100 mm)	Yes (400 x 200 mm & 100 x 100 mm)	Yes (400 x 200 mm)
Stand	Tilt	-7° to 17°	-7° to 17°	0
Security	Kensington Security Slot	Yes	Yes	Yes
Dimensions	Product w/Base (W x H x D)	728.8 x 540.3 x 236.8 mm (28.7" x 21.3" x 9.3")	967.0 x 638.7 x 236.8 mm (38.1" x 25.1" x 9.3")	1240.0 x 717.0 x 83.0 mm (48.8" x 28.2" x 3.3") (w/o Base)
	Packaging (W x H x D)	810.0 x 528.0 x 210.0 mm (31.9" x 20.9" x 8.3")	1078.0 x 668.0 x 200.0 mm (42.4" x 26.3" x 7.9")	1340 x 833.0 x 180.0 mm (52.8" x 28.4" x 7.1")
Weight	Product w/Base	8.7 kg (19.2 lb)	10.8 kg (23.8 lb)	13.8 kg (30.4 lb) (w/o Base)
	Packaging	10.5 kg (23.1 lb)	14.5 kg (32.0 lb)	19.0 kg (41.9 lb)

Note: All specifications are subject to change without prior notice.

SPECIFICATIONS

7.2 Display Dimensions

SC-32E

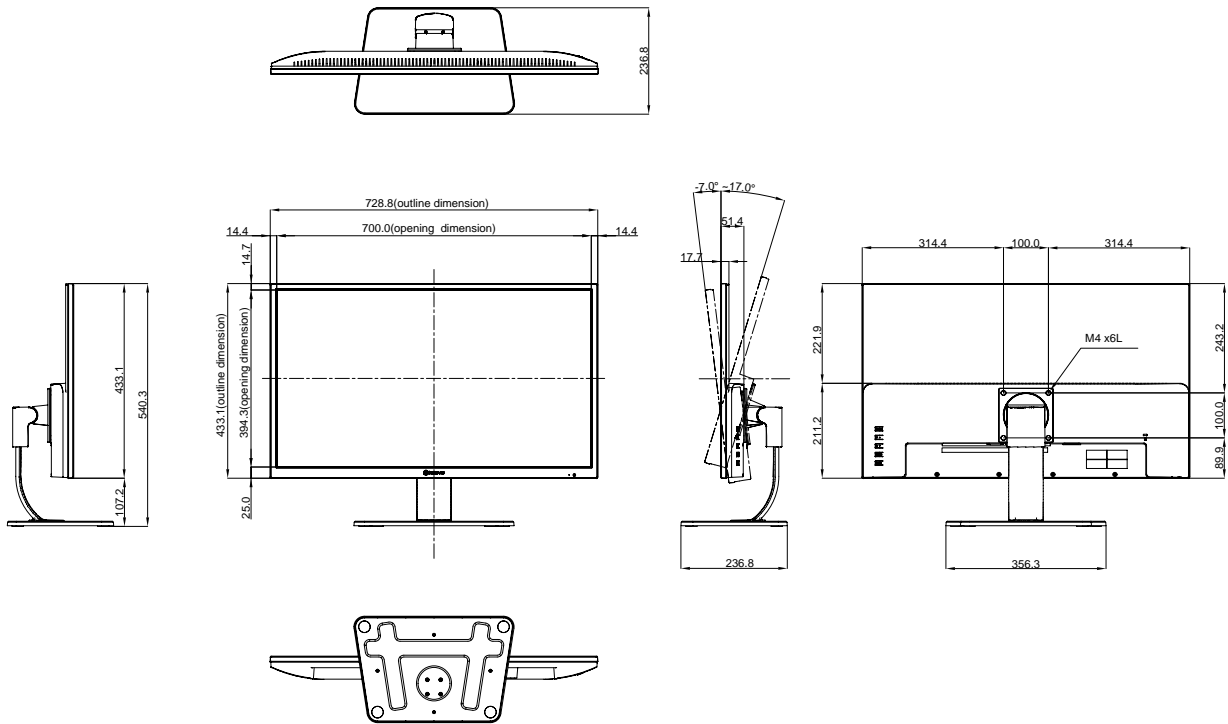

SC-42E

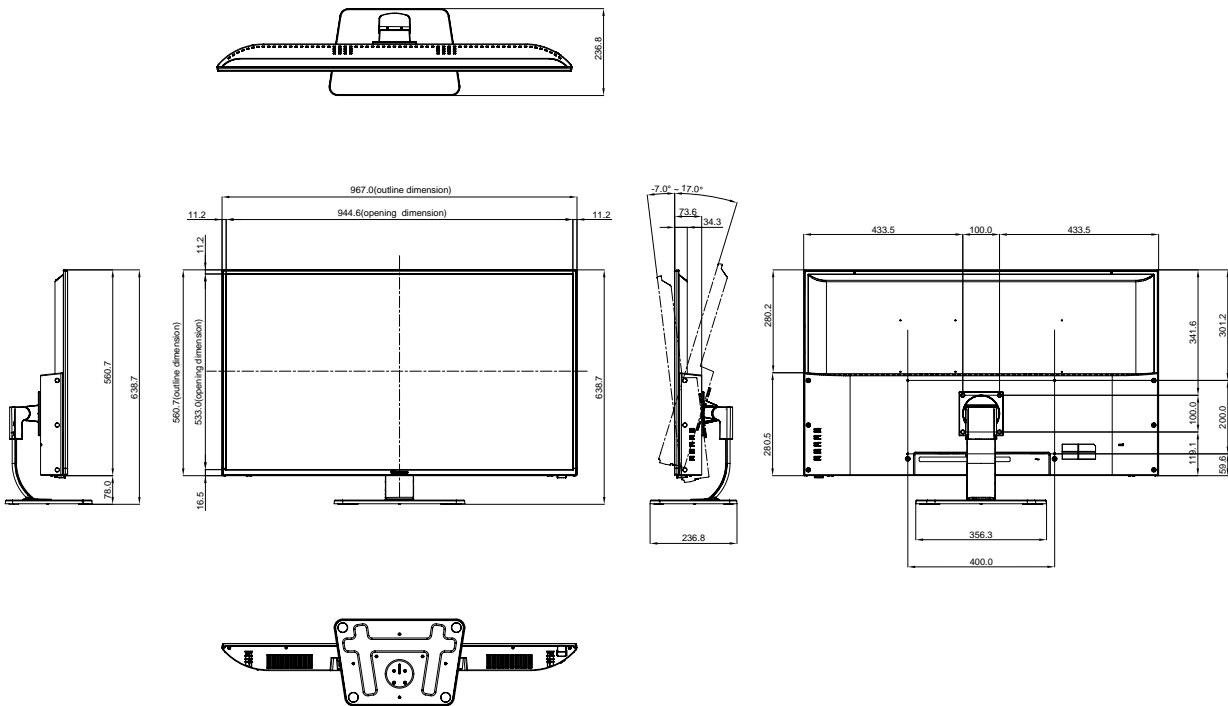

SPECIFICATIONS

SC-55E

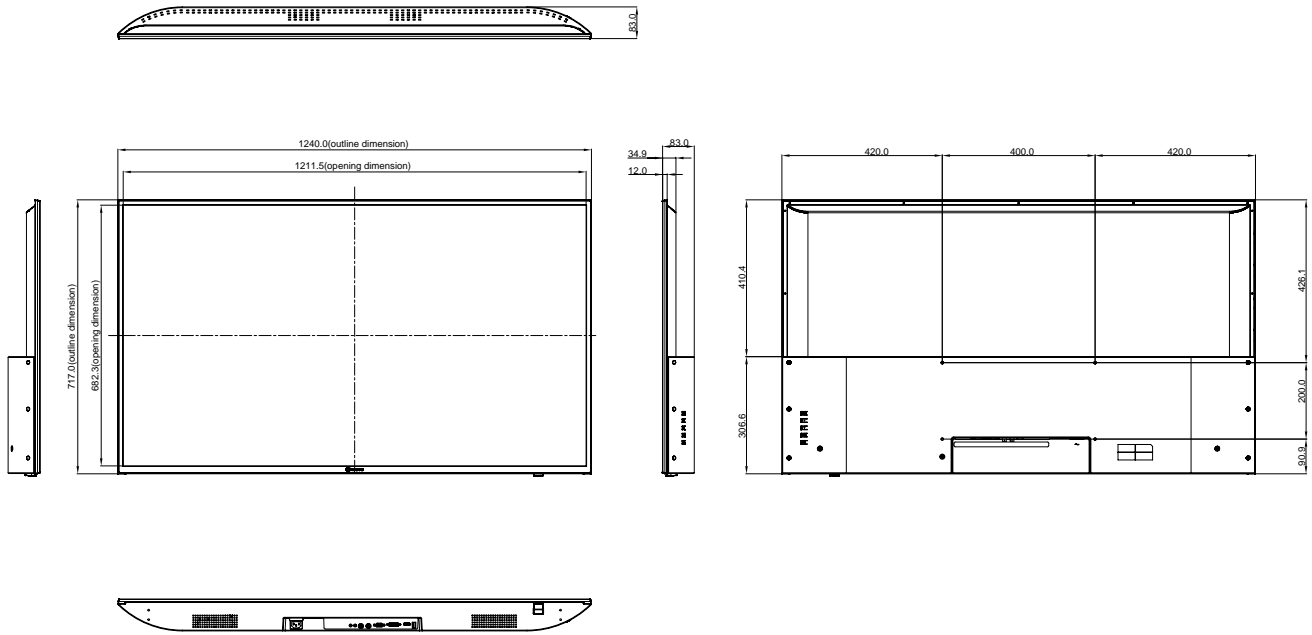

AG Neovo

Company Address: 5F-1, No. 3-1, Park Street, Nangang District, Taipei, 11503, Taiwan.

Copyright © 2019 AG Neovo. All rights reserved.

S55E00/S42E00/S32E00_UM_V010