

XPS 15

Service Manual



Identifier	GUID-5B8DE7B7-879F-45A4-88E0-732155904029
Status	Released

Notes, cautions, and warnings

 | **NOTE:** A NOTE indicates important information that helps you make better use of your product.

 | **CAUTION:** A CAUTION indicates either potential damage to hardware or loss of data and tells you how to avoid the problem.

 | **WARNING:** A WARNING indicates a potential for property damage, personal injury, or death.

Identifier	GUID-089FFA4B-3A62-4B51-BDE1-309C58A451D9
Status	Released

© 2019 Dell Inc. or its subsidiaries. All rights reserved. Dell, EMC, and other trademarks are trademarks of Dell Inc. or its subsidiaries. Other trademarks may be trademarks of their respective owners.

Contents

1 Before working inside your computer	8
Before you begin	8
Safety instructions.....	8
Recommended tools.....	9
Screw list.....	9
2 After working inside your computer	11
3 Removing the base cover	12
Procedure.....	12
4 Replacing the base cover	14
Procedure.....	14
5 Removing the battery (half-length)	15
Lithium-ion battery precautions.....	15
Prerequisites.....	15
Procedure.....	16
6 Replacing the battery (half-length)	17
Lithium-ion battery precautions.....	17
Procedure.....	17
Post-requisites.....	18
7 Removing the battery (full-length)	19
Lithium-ion battery precautions.....	19
Prerequisites.....	19
Procedure.....	20
8 Replacing the battery (full-length)	21
Lithium-ion battery precautions.....	21
Procedure.....	21
Post-requisites.....	22
9 Removing the memory modules	23
Prerequisites.....	23
Procedure.....	23
10 Replacing the memory modules	25
Procedure.....	25
Post-requisites.....	26
11 Removing the hard drive	27
Prerequisites.....	27

Procedure.....	27
12 Replacing the hard drive.....	30
Procedure.....	30
Post-requisites.....	30
13 Removing the solid-state drive (half-length).....	31
Prerequisites.....	31
Procedure.....	31
14 Replacing the solid-state drive (half-length).....	33
Procedure.....	33
Post-requisites.....	33
15 Removing the solid-state drive (full-length).....	34
Prerequisites.....	34
Procedure.....	34
16 Replacing the solid-state drive (full-length).....	36
Procedure.....	36
Post-requisites.....	36
17 Removing the speakers.....	37
Prerequisites.....	37
Procedure.....	37
18 Replacing the speakers.....	39
Procedure.....	39
Post-requisites.....	39
19 Removing the wireless card.....	40
Prerequisites.....	40
Procedure.....	40
20 Replacing the wireless card.....	42
Procedure.....	42
Post-requisites.....	43
21 Removing the fans.....	44
Prerequisites.....	44
Procedure.....	44
22 Replacing the fans.....	47
Procedure.....	47
Post-requisites.....	47
23 Removing the heat sink.....	48
Prerequisites.....	48

Procedure.....	48
24 Replacing the heat sink.....	50
Procedure.....	50
Post-requisites.....	50
25 Removing the system-board assembly.....	51
Prerequisites.....	51
Procedure.....	51
26 Replacing the system-board assembly.....	54
Procedure.....	54
Post-requisites.....	54
27 Removing the audio daughter-board.....	55
Prerequisites.....	55
Procedure.....	55
28 Replacing the audio daughter-board.....	57
Procedure.....	57
Post-requisites.....	57
29 Removing the coin-cell battery.....	58
Prerequisites.....	58
Procedure.....	58
30 Replacing the coin-cell battery.....	60
Procedure.....	60
Post-requisites.....	60
31 Removing the keyboard.....	61
Prerequisites.....	61
Procedure.....	61
32 Replacing the keyboard.....	64
Procedure.....	64
Post-requisites.....	64
33 Removing the power-button module.....	65
Prerequisites.....	65
Procedure.....	65
34 Replacing the power-button module.....	67
Procedure.....	67
Post-requisites.....	67
35 Removing the fingerprint reader daughter-board (optional).....	68
Prerequisites.....	68

Procedure.....	68
36 Replacing the fingerprint reader daughter board (optional).....	70
Procedure.....	70
Post-requisites.....	70
37 Removing the display assembly.....	71
Prerequisites.....	71
Procedure.....	71
38 Replacing the display assembly.....	74
Procedure.....	74
Post-requisites.....	74
39 Removing the power-adapter port.....	75
Prerequisites.....	75
Procedure.....	75
40 Replacing the power-adapter port.....	77
Procedure.....	77
Post-requisites.....	77
41 Removing the antenna cover.....	78
Prerequisites.....	78
Procedure.....	78
42 Replacing the antenna cover.....	80
Procedure.....	80
Post-requisites.....	80
43 Removing the antenna module.....	81
Prerequisites.....	81
Procedure.....	81
44 Replacing the antenna module.....	83
Procedure.....	83
Post-requisites.....	83
45 Removing the palm-rest assembly.....	84
Prerequisites.....	84
Procedure.....	84
46 Replacing the palm-rest assembly.....	86
Procedure.....	86
Post-requisites.....	86
47 Downloading drivers.....	87
Downloading the audio driver.....	87

Downloading the graphics driver.....	88
Downloading the chipset driver.....	88
Downloading the USB driver.....	89
Downloading the chipset driver.....	90
Downloading the network driver.....	90
Downloading the fingerprint reader driver.....	91
48 System setup.....	93
Boot Sequence.....	93
Navigation keys.....	93
System setup.....	94
Entering BIOS setup program.....	94
Enabling or disabling the USB in BIOS setup program.....	94
Identifying the hard drive in BIOS setup program.....	95
Checking the system memory in BIOS setup program.....	95
System setup options.....	95
49 System and setup password.....	101
Assigning a system setup password.....	101
Deleting or changing an existing system setup password.....	102
Clearing BIOS (System Setup) and System passwords.....	102
Clearing CMOS settings.....	102
Real Time Clock (RTC) battery reset.....	102
Flashing BIOS (USB key).....	103
50 Troubleshooting.....	104
Flashing the BIOS.....	104
Reinstall Windows using a USB recovery drive.....	104
Fixing a no-boot issue caused by USB-boot support.....	105
Enhanced Pre-Boot System Assessment (ePSA) diagnostics.....	105
Running the ePSA Diagnostics.....	106
Diagnostics.....	106
Flea power release.....	107
Wi-Fi power cycle.....	107
51 Getting help and contacting Dell.....	109
Self-help resources.....	109
Contacting Dell.....	109

Identifier	GUID-5D3B1051-9384-409A-8D5B-
Status	Released

Before working inside your computer

 **NOTE:** The images in this document may differ from your computer depending on the configuration you ordered.

Identifier	GUID-B2521C24-A407-4ABB-8022-6D88B53F0B94
Status	Released

Before you begin

- 1 Save and close all open files and exit all open applications.
- 2 Shut down your computer. Click **Start** >  **Power** > **Shut down**.







 **NOTE:** If you are using a different operating system, see the documentation of your operating system for shut-down instructions.

- 3 Disconnect your computer and all attached devices from their electrical outlets.
- 4 Disconnect all attached network devices and peripherals, such as keyboard, mouse, and monitor from your computer.
- 5 Remove any media card and optical disc from your computer, if applicable.

Identifier	GUID-71128823-CE64-4E17-9439-DEE95AF668C4
Status	Released

Safety instructions

Use the following safety guidelines to protect your computer from potential damage and ensure your personal safety.

-  **WARNING:** Before working inside your computer, read the safety information that shipped with your computer. For more safety best practices, see the Regulatory Compliance home page at www.dell.com/regulatory_compliance.
-  **WARNING:** Disconnect all power sources before opening the computer cover or panels. After you finish working inside the computer, replace all covers, panels, and screws before connecting to the electrical outlet.
-  **CAUTION:** To avoid damaging the computer, ensure that the work surface is flat and clean.
-  **CAUTION:** To avoid damaging the components and cards, handle them by their edges, and avoid touching pins and contacts.
-  **CAUTION:** You should only perform troubleshooting and repairs as authorized or directed by the Dell technical assistance team. Damage due to servicing that is not authorized by Dell is not covered by your warranty. See the safety instructions that shipped with the product or at www.dell.com/regulatory_compliance.
-  **CAUTION:** Before touching anything inside your computer, ground yourself by touching an unpainted metal surface, such as the metal at the back of the computer. While you work, periodically touch an unpainted metal surface to dissipate static electricity, which could harm internal components.

CAUTION: When you disconnect a cable, pull on its connector or on its pull tab, not on the cable itself. Some cables have connectors with locking tabs or thumb-screws that you must disengage before disconnecting the cable. When disconnecting cables, keep them evenly aligned to avoid bending any connector pins. When connecting cables, ensure that the ports and connectors are correctly oriented and aligned.

CAUTION: Press and eject any installed card from the media-card reader.

Identifier	GUID-1DA44488-D101-4AAE-BADD-2C0771F1C35F
Status	Released

Recommended tools

The procedures in this document may require the following tools:



- Phillips screwdriver #0
- Phillips screwdriver #1
- Torx #5 (T5) screwdriver
- Plastic scribe











Identifier	GUID-328DCC55-D98F-4173-A3DD-26BE2F041BF7
Status	Released

Screw list

The following table provides the list of screws that are used for securing different components to the computer.

Table 1. Screw list

Component	Secured to	Screw type	Quantity	Screw image
Base cover	Palm-rest assembly	M2x3 T5	10	
Base cover	Palm-rest assembly	M2x8.5	2	
Battery (half-length)	Palm-rest assembly	M2x4	4	
Battery (full-length)	Palm-rest assembly	M2x4	7	
Hard-drive cage	Hard-drive assembly	M2x4	4	
Solid-state drive (half-length)	System board	M2x3	1	
Solid-state drive	Solid-state drive bracket	M2x2	1	
Solid-state drive (full-length)	System board	M2x3	1	
Speakers	Palm-rest assembly	M2x2	4	

Component	Secured to	Screw type	Quantity	Screw image
Fan	System board	M2x4	4	
Heat-sink assembly	System board	M2x3	5/4	
Display-cable bracket	System board	M2x2	1	
System board	Palm-rest assembly	M2x4	5	
Audio daughter-board	System board	M2x3	2	
Keyboard	Palm-rest assembly	M1.6x1.5	31	
Power-button module	Palm-rest assembly	M1.6x3	2	
Fingerprint-reader board	Palm-rest assembly	M1.6x1.5	1	
Display hinges	Palm-rest assembly	M2.5x5	6	
Power-adapter port	Palm-rest assembly	M2x3	1	
Antenna module	Display assembly	M2x4	4	

Identifier	GUID-06588814-2678-4667-9FF9-C
Status	Released

After working inside your computer

 **CAUTION:** Leaving stray or loose screws inside your computer may severely damage your computer.

- 1 Replace all screws and ensure that no stray screws remain inside your computer.
- 2 Connect any external devices, peripherals, or cables you removed before working on your computer.
- 3 Replace any media cards, discs, or any other parts that you removed before working on your computer.
- 4 Connect your computer and all attached devices to their electrical outlets.
- 5 Turn on your computer.

Identifier	GUID-98068FC2-1C1C-46DE-B3FA
Status	Released

Removing the base cover

⚠ WARNING: Before working inside your computer, read the safety information that shipped with your computer and follow the steps in [Before working inside your computer](#). After working inside your computer, follow the instructions in [After working inside your computer](#). For more safety best practices, see the Regulatory Compliance home page at www.dell.com/regulatory_compliance.

Identifier	GUID-FE52208C-5EFA-4569-A90D-E459B9E17E37
Status	Released

Procedure

- 1 Close the display, and turn the computer over.
- 2 Turn the system badge over and remove the two screws (M2x8.5) that secure the base cover to the palm-rest assembly.
- 3 Remove the 10 screws (M2x3 T5) that secure the base cover to the palm-rest assembly.

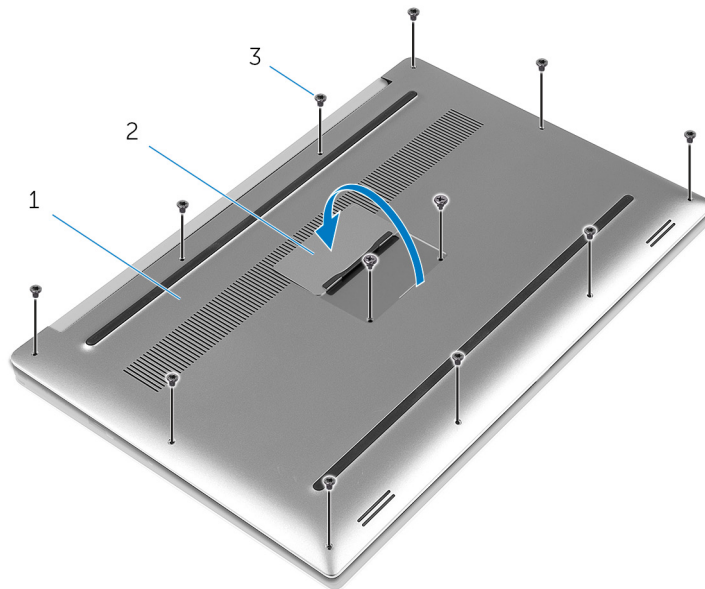

Figure 1. Removing the base cover

- | | | | |
|---|-------------|---|--------------|
| 1 | base cover | 2 | system badge |
| 3 | screws (12) | | |
- 4 Using a plastic scribe, gently pry the base cover off the palm-rest assembly.

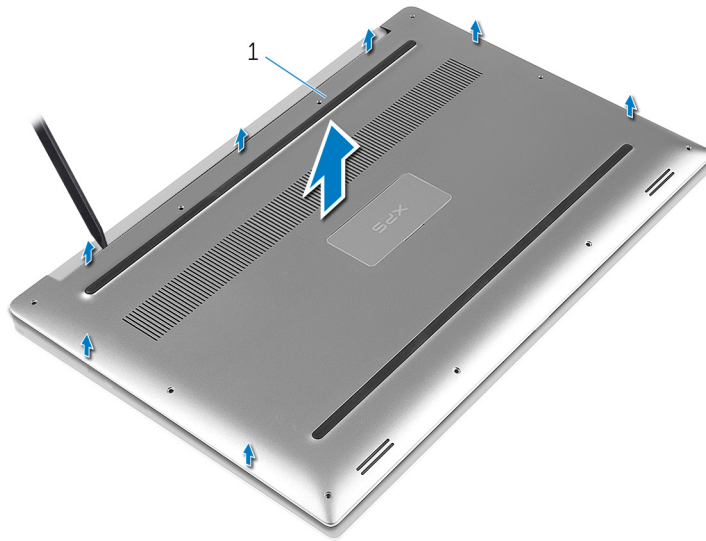

Figure 2. Prying the base cover off the computer base

- 1 base cover

Identifier	GUID-27446428-82D7-4881-9220-9
Status	Released

Replacing the base cover

⚠ WARNING: Before working inside your computer, read the safety information that shipped with your computer and follow the steps in [Before working inside your computer](#). After working inside your computer, follow the instructions in [After working inside your computer](#). For more safety best practices, see the Regulatory Compliance home page at www.dell.com/regulatory_compliance.

Identifier	GUID-F113D502-95A9-448F-AB1C-F07A96526541
Status	Released

Procedure

- 1 Place the base cover on the palm-rest assembly and snap it into place.
- 2 Replace the 10 screws (M2x3 T5) that secure the base cover to the palm-rest assembly.
- 3 Replace the two screws (M2x8.5) that secure the base cover to the palm-rest assembly.
- 4 Turn the system badge over, and snap it into place.
- 5 Turn the computer over.

Identifier	GUID-FA3B2FD2-52E7-43FD-8566-
Status	Released

Removing the battery (half-length)

⚠ WARNING: Before working inside your computer, read the safety information that shipped with your computer and follow the steps in [Before working inside your computer](#). After working inside your computer, follow the instructions in [After working inside your computer](#). For more safety best practices, see the Regulatory Compliance home page at www.dell.com/regulatory_compliance.

Identifier	GUID-22C7DCB3-8D29-41D7-8D51-D90ABC7C2D63
Status	Released

Lithium-ion battery precautions

⚠ CAUTION:

- Exercise caution when handling Lithium-ion batteries.
- Discharge the battery as much as possible before removing it from the system. This can be done by disconnecting the AC adapter from the system to allow the battery to drain.
- Do not crush, drop, mutilate, or penetrate the battery with foreign objects.
- Do not expose the battery to high temperatures, or disassemble battery packs and cells.
- Do not apply pressure to the surface of the battery.
- Do not bend the battery.
- Do not use tools of any kind to pry on or against the battery.
- Ensure any screws during the servicing of this product are not lost or misplaced, to prevent accidental puncture or damage to the battery and other system components.
- If a battery gets stuck in a device as a result of swelling, do not try to free it as puncturing, bending, or crushing a Lithium-ion battery can be dangerous. In such an instance, contact for assistance and further instructions.
- If the battery gets stuck inside your computer as a result of swelling, do not try to release it as puncturing, bending, or crushing a lithium-ion battery can be dangerous. In such an instance, contact Dell technical support for assistance. See www.dell.com/contactdell.
- Always purchase genuine batteries from www.dell.com or authorized Dell partners and resellers.

Identifier	GUID-ADE0B0E5-2130-4FC4-8553-96D2D5460E56
Status	Released

Prerequisites

Remove the [base cover](#).

Identifier

GUID-FCDEA56B-004E-44A7-A6A0-7C50399AF6E1

Status

Released

Procedure

- 1 Remove the four screws (M2x4) that secure the battery to the palm-rest assembly.
- 2 Disconnect the battery cable from the system board.
- 3 Lift the battery off the palm-rest assembly.

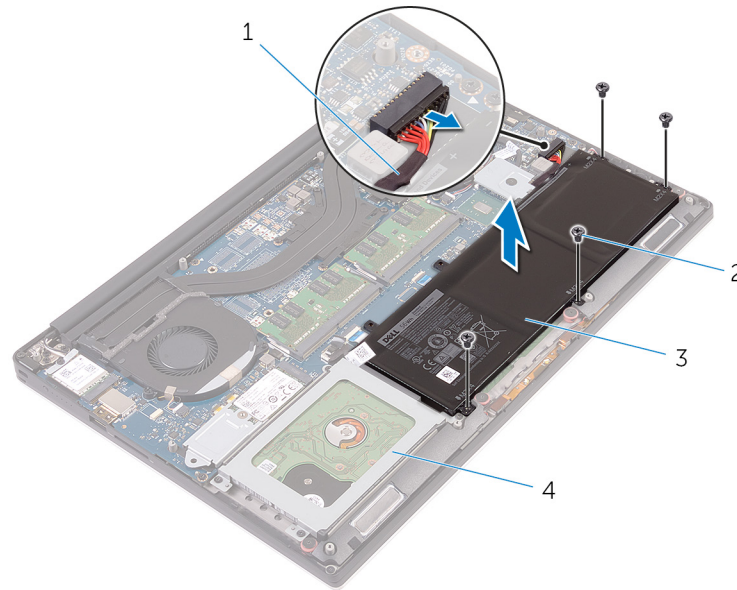

Figure 3. Removing the battery

- | | | | |
|---|---------------|---|--------------------|
| 1 | battery cable | 2 | screws (4) |
| 3 | battery | 4 | palm-rest assembly |
- 4 Turn the computer over, open the display, and press the power button for five seconds to ground the system board.

Identifier	GUID-E50A81D7-E412-49DE-BEB1
Status	Released

Replacing the battery (half-length)

⚠ WARNING: Before working inside your computer, read the safety information that shipped with your computer and follow the steps in [Before working inside your computer](#). After working inside your computer, follow the instructions in [After working inside your computer](#). For more safety best practices, see the Regulatory Compliance home page at www.dell.com/regulatory_compliance.

Identifier	GUID-22C7DCB3-8D29-41D7-8D51-D90ABC7C2D63
Status	Released

Lithium-ion battery precautions

⚠ CAUTION:

- Exercise caution when handling Lithium-ion batteries.
- Discharge the battery as much as possible before removing it from the system. This can be done by disconnecting the AC adapter from the system to allow the battery to drain.
- Do not crush, drop, mutilate, or penetrate the battery with foreign objects.
- Do not expose the battery to high temperatures, or disassemble battery packs and cells.
- Do not apply pressure to the surface of the battery.
- Do not bend the battery.
- Do not use tools of any kind to pry on or against the battery.
- Ensure any screws during the servicing of this product are not lost or misplaced, to prevent accidental puncture or damage to the battery and other system components.
- If a battery gets stuck in a device as a result of swelling, do not try to free it as puncturing, bending, or crushing a Lithium-ion battery can be dangerous. In such an instance, contact for assistance and further instructions.
- If the battery gets stuck inside your computer as a result of swelling, do not try to release it as puncturing, bending, or crushing a lithium-ion battery can be dangerous. In such an instance, contact Dell technical support for assistance. See www.dell.com/contactdell.
- Always purchase genuine batteries from www.dell.com or authorized Dell partners and resellers.

Identifier	GUID-B0DA0B2B-67A5-4E8B-9FA0-7C2DEB75C5DE
Status	Released

Procedure

- 1 Align the screw holes on the battery with the screw holes on the palm-rest assembly.
- 2 Replace the four screws (M2x4) that secure the battery to the palm-rest assembly.
- 3 Connect the battery cable to the system board.

Identifier	GUID-A5E4D6EB-7F3C-40E5-A565-D1CF58021412
Status	Released

Post-requisites

Replace the [base cover](#).

Identifier	GUID-355FFABD-659C-4427-88AA-
Status	Released

Removing the battery (full-length)

⚠ WARNING: Before working inside your computer, read the safety information that shipped with your computer and follow the steps in [Before working inside your computer](#). After working inside your computer, follow the instructions in [After working inside your computer](#). For more safety best practices, see the Regulatory Compliance home page at www.dell.com/regulatory_compliance.

Identifier	GUID-22C7DCB3-8D29-41D7-8D51-D90ABC7C2D63
Status	Released

Lithium-ion battery precautions

⚠ CAUTION:

- Exercise caution when handling Lithium-ion batteries.
- Discharge the battery as much as possible before removing it from the system. This can be done by disconnecting the AC adapter from the system to allow the battery to drain.
- Do not crush, drop, mutilate, or penetrate the battery with foreign objects.
- Do not expose the battery to high temperatures, or disassemble battery packs and cells.
- Do not apply pressure to the surface of the battery.
- Do not bend the battery.
- Do not use tools of any kind to pry on or against the battery.
- Ensure any screws during the servicing of this product are not lost or misplaced, to prevent accidental puncture or damage to the battery and other system components.
- If a battery gets stuck in a device as a result of swelling, do not try to free it as puncturing, bending, or crushing a Lithium-ion battery can be dangerous. In such an instance, contact for assistance and further instructions.
- If the battery gets stuck inside your computer as a result of swelling, do not try to release it as puncturing, bending, or crushing a lithium-ion battery can be dangerous. In such an instance, contact Dell technical support for assistance. See www.dell.com/contactdell.
- Always purchase genuine batteries from www.dell.com or authorized Dell partners and resellers.

Identifier	GUID-ADE0B0E5-2130-4FC4-8553-96D2D5460E56
Status	Released

Prerequisites

Remove the [base cover](#).

Identifier

GUID-CBCA961F-7C16-4C3F-AD46-FA737221CE41

Status

Released

Procedure

NOTE: The hard drive is not available on systems shipped with 6-cell (full-length) battery.

- 1 Remove the seven screws (M2x4) that secure the battery to the palm-rest assembly.
- 2 Disconnect the battery cable from the system board.
- 3 Lift the battery off the palm-rest assembly.

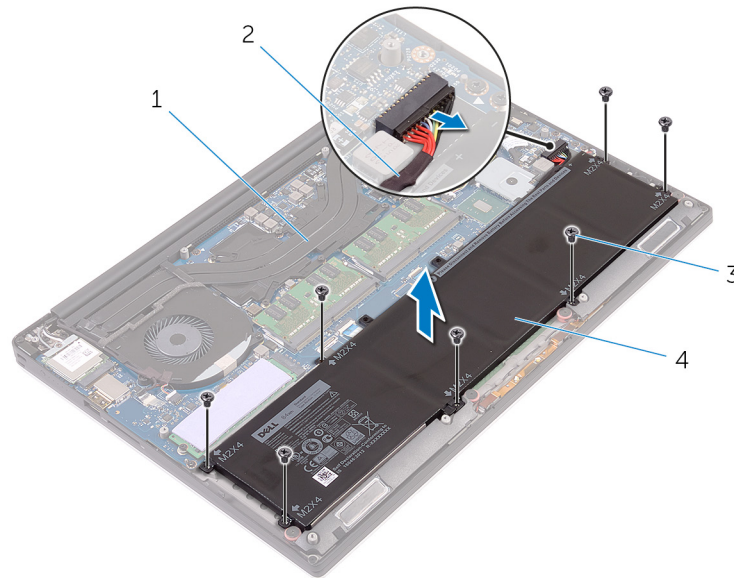

Figure 4. Removing the battery

- | | | | |
|---|--------------------|---|---------------|
| 1 | palm-rest assembly | 2 | battery cable |
| 3 | screws (7) | 4 | battery |
- 4 Turn the computer over, open the display, and press the power button for five seconds to ground the system board.

Identifier	GUID-DF0226C1-346A-4344-98C0-0
Status	Released

Replacing the battery (full-length)

⚠ WARNING: Before working inside your computer, read the safety information that shipped with your computer and follow the steps in [Before working inside your computer](#). After working inside your computer, follow the instructions in [After working inside your computer](#). For more safety best practices, see the Regulatory Compliance home page at www.dell.com/regulatory_compliance.

Identifier	GUID-22C7DCB3-8D29-41D7-8D51-D90ABC7C2D63
Status	Released

Lithium-ion battery precautions

⚠ CAUTION:

- Exercise caution when handling Lithium-ion batteries.
- Discharge the battery as much as possible before removing it from the system. This can be done by disconnecting the AC adapter from the system to allow the battery to drain.
- Do not crush, drop, mutilate, or penetrate the battery with foreign objects.
- Do not expose the battery to high temperatures, or disassemble battery packs and cells.
- Do not apply pressure to the surface of the battery.
- Do not bend the battery.
- Do not use tools of any kind to pry on or against the battery.
- Ensure any screws during the servicing of this product are not lost or misplaced, to prevent accidental puncture or damage to the battery and other system components.
- If a battery gets stuck in a device as a result of swelling, do not try to free it as puncturing, bending, or crushing a Lithium-ion battery can be dangerous. In such an instance, contact for assistance and further instructions.
- If the battery gets stuck inside your computer as a result of swelling, do not try to release it as puncturing, bending, or crushing a lithium-ion battery can be dangerous. In such an instance, contact Dell technical support for assistance. See www.dell.com/contactdell.
- Always purchase genuine batteries from www.dell.com or authorized Dell partners and resellers.

Identifier	GUID-4E17BC0B-6366-46F3-8FEE-0F9AD2A039F1
Status	Released

Procedure

ⓘ NOTE: The hard drive is not available on systems shipped with 6-cell (full-length) battery.

- 1 Align the screw holes on the battery with the screw holes on the palm-rest assembly.
- 2 Replace the seven screws (M2x4) that secure the battery to the palm-rest assembly.
- 3 Connect the battery cable to the system board.

Identifier	GUID-A5E4D6EB-7F3C-40E5-A565-D1CF58021412
Status	Released

Post-requisites

Replace the [base cover](#).

Identifier	GUID-AAC0DC5A-1680-492D-804F
Status	Released

Removing the memory modules

⚠ WARNING: Before working inside your computer, read the safety information that shipped with your computer and follow the steps in [Before working inside your computer](#). After working inside your computer, follow the instructions in [After working inside your computer](#). For more safety best practices, see the Regulatory Compliance home page at www.dell.com/regulatory_compliance.

Identifier	GUID-28F89DF8-99BB-4B9C-88D1-6DB4494163CF
Status	Released

Prerequisites

- 1 Remove the [base cover](#).
- 2 Remove the [battery \(half-length\)](#) or the [battery \(full-length\)](#).

Identifier	GUID-E7CC2856-2069-4D93-BA85-9326C079A4BB
Status	Released

Procedure

- 1 Using your fingertips, spread the securing clips apart on each end of the memory-module slot until the memory module pops up.
- 2 Slide and remove the memory module from the memory-module slot.

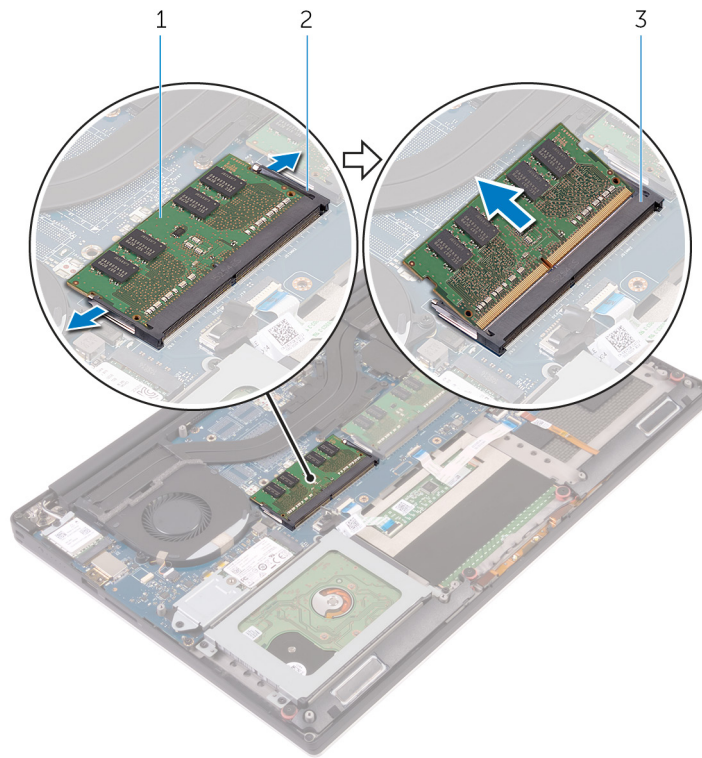

Figure 5. Removing the memory modules

- 1 memory module
- 3 memory-module slot

- 2 securing clips (2)

Identifier	GUID-1F5023F5-9868-4AAF-A9F5-1
Status	Released

Replacing the memory modules

⚠ WARNING: Before working inside your computer, read the safety information that shipped with your computer and follow the steps in [Before working inside your computer](#). After working inside your computer, follow the instructions in [After working inside your computer](#). For more safety best practices, see the Regulatory Compliance home page at www.dell.com/regulatory_compliance.

Identifier	GUID-01D31343-9248-4391-A6FC-1C2FE832C508
Status	Released

Procedure

- 1 Align the notch on the memory module with the tab on the memory-module slot.
- 2 Slide the memory module firmly into the slot at an angle and gently press the memory module down until it clicks into place.

① NOTE: If you do not hear the click, remove the memory module and reinstall it.

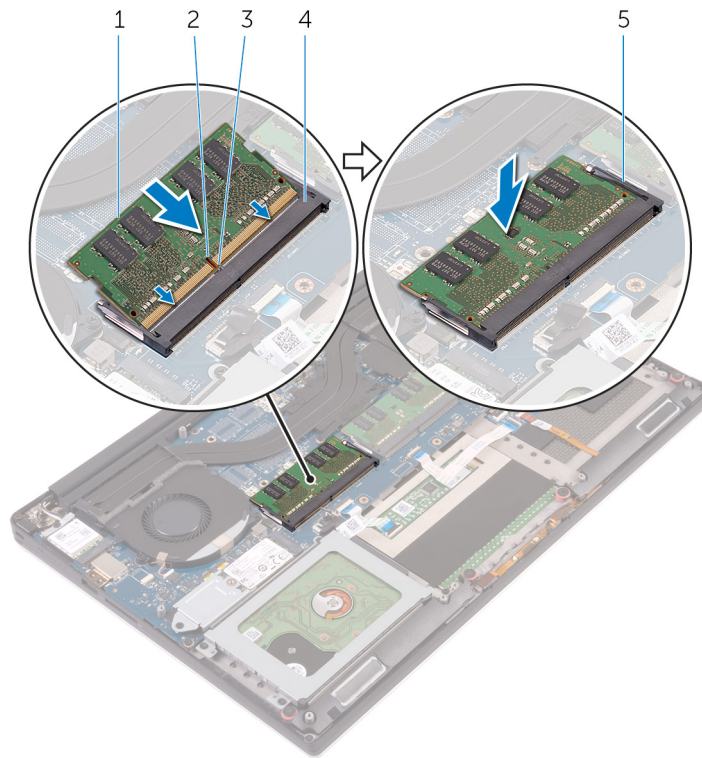

Figure 6. Replacing the memory modules

- | | | | |
|---|----------------|---|--------------------|
| 1 | memory module | 2 | notch |
| 3 | tab | 4 | memory-module slot |
| 5 | securing clips | | |

Identifier	GUID-D6D9C7FD-F5F2-4841-BED9-C4F8672A8F1D
Status	Released

Post-requisites

- 1 Replace the [battery \(half-length\)](#) or the [battery \(full-length\)](#).
- 2 Replace the [base cover](#).

Identifier	GUID-5DE1E07B-4633-4536-ACBF
Status	Released

Removing the hard drive

⚠ WARNING: Before working inside your computer, read the safety information that shipped with your computer and follow the steps in [Before working inside your computer](#). After working inside your computer, follow the instructions in [After working inside your computer](#). For more safety best practices, see the Regulatory Compliance home page at www.dell.com/regulatory_compliance.

⚠ CAUTION: Hard drives are fragile. Exercise care when handling the hard drive.

⚠ CAUTION: To avoid data loss, do not remove the hard drive while the computer is in sleep or on state.

Identifier	GUID-C7C10D90-ADC9-4C77-887A-AF3EE25E9BDA
Status	Released

Prerequisites

- 1 Remove the [base cover](#).
- 2 Remove the [battery \(half-length\)](#).

Identifier	GUID-D6DE55CD-9F65-40DC-8643-7C6D95509DA6
Status	Released

Procedure

ⓘ NOTE: The hard drive is not available on systems shipped with 6-cell (full-length) battery.

- 1 Remove the four screws (M2x4) that secure the hard-drive cage to the palm-rest assembly.
- 2 Lift the hard-drive cage off the hard-drive assembly.

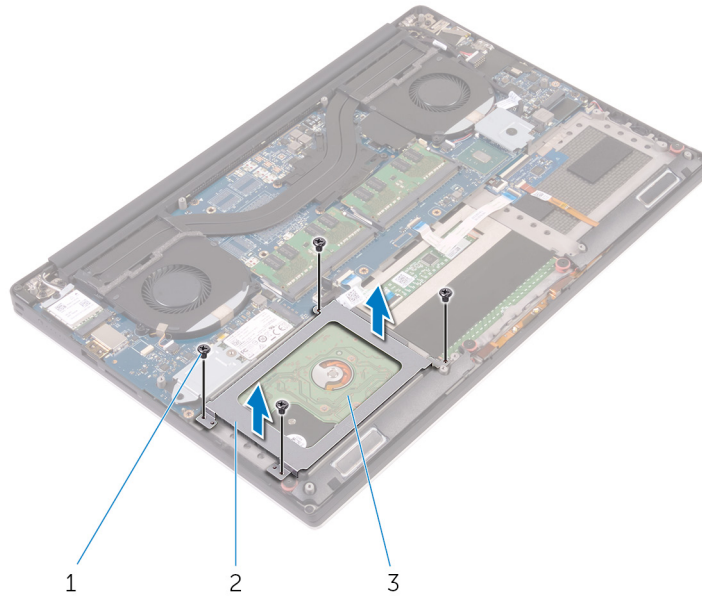

Figure 7. Removing the hard-drive cage

- 1 screws (4)
- 2 hard-drive cage
- 3 hard-drive assembly

- 3 Using the pull tab, disconnect the hard-drive cable from the system board.
- 4 Lift the hard-drive assembly off the palm-rest assembly.

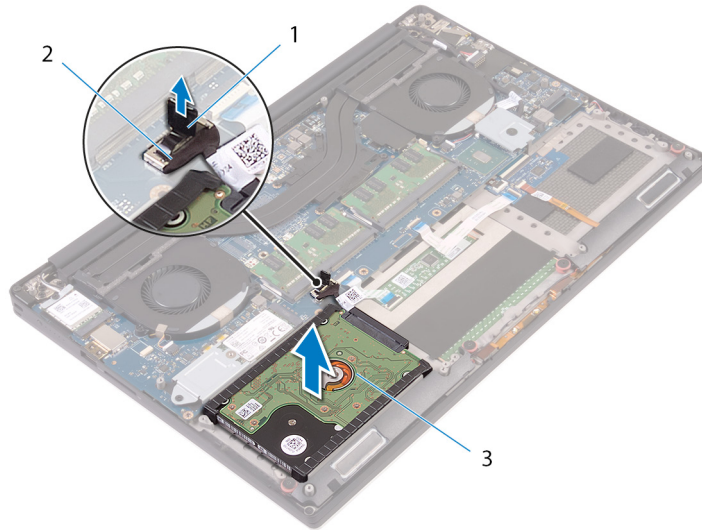

Figure 8. Disconnecting the hard-drive cable from the system board

- 1 pull tab
- 2 hard-drive cable
- 3 hard-drive assembly

- 5 Disconnect the hard-drive interposer from the hard-drive assembly.

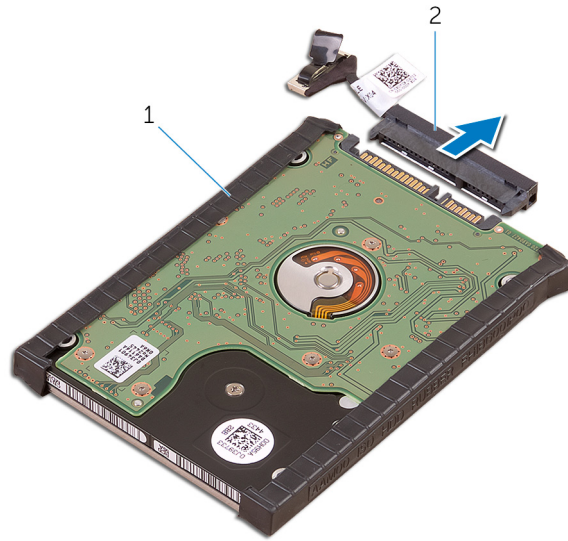

Figure 9. Disconnecting the hard-drive interposer from the hard-drive assembly

1 hard-drive assembly

2 hard-drive interposer

6 Remove the hard-drive covers away from the hard drive.

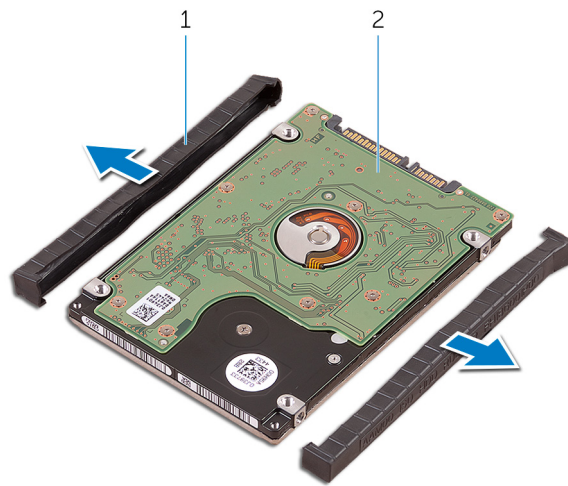

Figure 10. Removing the hard-drive cover

1 hard-drive covers (2)

2 hard drive

Identifier	GUID-8D72BB77-0F8B-428E-A98E
Status	Released

Replacing the hard drive

⚠ WARNING: Before working inside your computer, read the safety information that shipped with your computer and follow the steps in [Before working inside your computer](#). After working inside your computer, follow the instructions in [After working inside your computer](#). For more safety best practices, see the Regulatory Compliance home page at www.dell.com/regulatory_compliance.

⚠ CAUTION: Hard drives are fragile. Exercise care when handling the hard drive.

Identifier	GUID-84AE5B77-A0DE-461A-BF43-D8853194B570
Status	Released

Procedure

① NOTE: The hard drive is not available on systems shipped with 6-cell (full-length) battery.

- 1 Replace the hard-drive covers on the hard drive.
- 2 Connect the hard-drive interposer to the hard-drive assembly.
- 3 Place the hard-drive assembly on the palm-rest assembly.
- 4 Connect the hard-drive cable to the system board.
- 5 Align the screw holes on the hard-drive cage with the screw holes on the hard-drive assembly.
- 6 Replace the four screws (M2x4) screws that secure the hard-drive cage to the palm-rest assembly.

Identifier	GUID-D58061A8-62F0-4304-AC8D-80A1C0DDF696
Status	Released

Post-requisites

- 1 Replace the [battery \(half-length\)](#).
- 2 Replace the [base cover](#).

Identifier	GUID-8B732F56-051E-43E5-BD12-
Status	Released

Removing the solid-state drive (half-length)

⚠ WARNING: Before working inside your computer, read the safety information that shipped with your computer and follow the steps in [Before working inside your computer](#). After working inside your computer, follow the instructions in [After working inside your computer](#). For more safety best practices, see the Regulatory Compliance home page at www.dell.com/regulatory_compliance.

Identifier	GUID-28F89DF8-99BB-4B9C-88D1-6DB4494163CF
Status	Released

Prerequisites

- 1 Remove the [base cover](#).
- 2 Remove the [battery \(half-length\)](#) or the [battery \(full-length\)](#).

Identifier	GUID-1DE68481-5A48-4382-8E64-7D4508ABEAB0
Status	Released

Procedure

- 1 Remove the screw (M2x3) that secures the solid-state drive assembly to the system board.
- 2 Lift and slide the solid-state drive assembly from the system board.

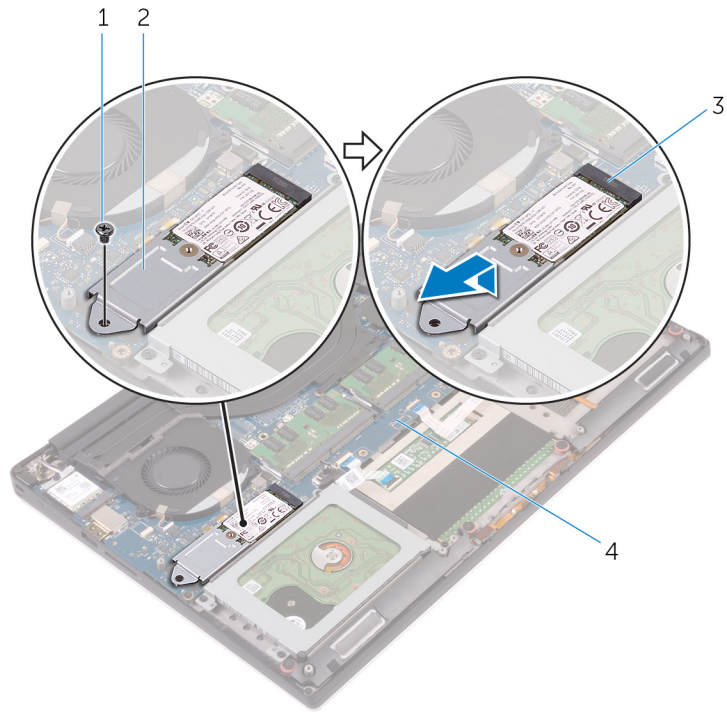

Figure 11. Removing the solid-state drive assembly

- | | | | |
|---|------------------------|---|----------------------------|
| 1 | screw | 2 | solid-state drive assembly |
| 3 | solid-state drive slot | 4 | system board |

3 Turn the solid-state drive assembly over, and then remove the screw (M2x2) that secures the solid-state drive to the solid-state drive bracket.

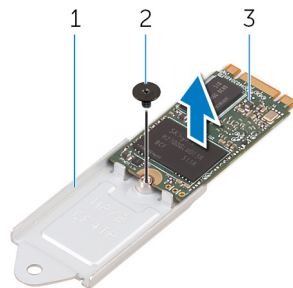

Figure 12. Removing the solid-state drive bracket

- | | | | |
|---|---------------------------|---|-------|
| 1 | solid-state drive bracket | 2 | screw |
| 3 | solid-state drive | | |

4 Lift the solid-state drive off the solid-state drive bracket.

Identifier	GUID-D3CEABFD-629C-4387-BE70
Status	Released

Replacing the solid-state drive (half-length)

⚠ WARNING: Before working inside your computer, read the safety information that shipped with your computer and follow the steps in [Before working inside your computer](#). After working inside your computer, follow the instructions in [After working inside your computer](#). For more safety best practices, see the Regulatory Compliance home page at www.dell.com/regulatory_compliance.

Identifier	GUID-0B4DFA25-CDC9-407D-A65A-234FFD38CFA5
Status	Released

Procedure

- 1 Align the screw hole on the solid-state drive bracket with the screw hole on the solid-state drive.
- 2 Replace the screw (M2x2) that secures the solid-state drive to the solid-state drive bracket.
- 3 Align the notches on the solid-state drive assembly with the tabs in the solid-state drive slot.
- 4 Slide the solid-state drive assembly at an angle into the solid-state drive slot.
- 5 Press the other end of the solid-state drive down and replace the screw (M2x3) that secures the solid-state drive to the system board.

Identifier	GUID-D6D9C7FD-F5F2-4841-BED9-C4F8672A8F1D
Status	Released

Post-requisites

- 1 Replace the [battery \(half-length\)](#) or the [battery \(full-length\)](#).
- 2 Replace the [base cover](#).

Identifier	GUID-CA63CF9E-83FD-4B12-9A33
Status	Released

Removing the solid-state drive (full-length)

⚠ WARNING: Before working inside your computer, read the safety information that shipped with your computer and follow the steps in [Before working inside your computer](#). After working inside your computer, follow the instructions in [After working inside your computer](#). For more safety best practices, see the Regulatory Compliance home page at www.dell.com/regulatory_compliance.

Identifier	GUID-28F89DF8-99BB-4B9C-88D1-6DB4494163CF
Status	Released

Prerequisites

- 1 Remove the [base cover](#).
- 2 Remove the [battery \(half-length\)](#) or the [battery \(full-length\)](#).

Identifier	GUID-7B2E5A47-FAA4-4AA9-B3F5-2284E315C53B
Status	Released

Procedure

- 1 Remove the screw (M2x3) that secures the solid-state drive to the system board.
- 2 Lift and slide the solid-state drive assembly from the system board.

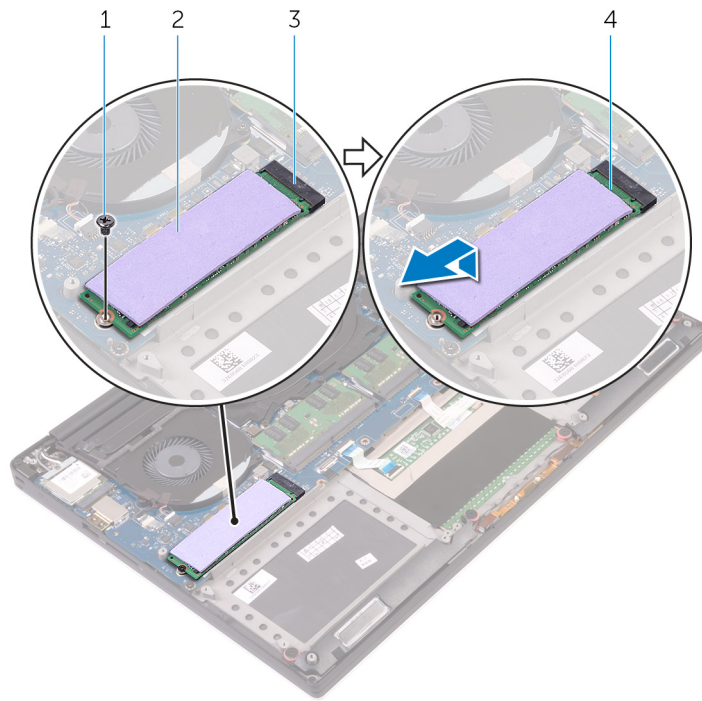

Figure 13. Removing the solid-state drive

- 1 screw
 - 2 thermal pad
 - 3 solid-state drive slot
 - 4 solid-state drive
- 3 Peel the thermal pad off the solid-state drive.

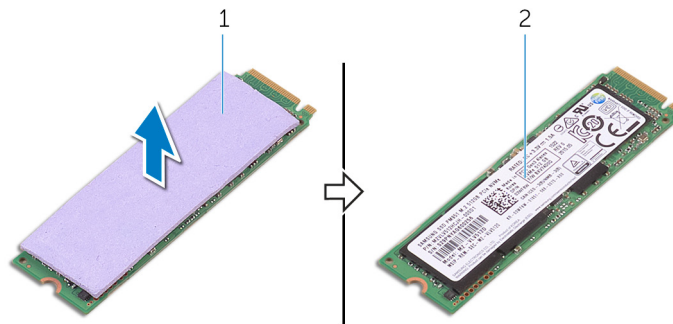

Figure 14. Removing the thermal pad

- 1 thermal pad
- 2 solid-state drive

Identifier	GUID-47BC7D1D-16F9-431C-B5A1
Status	Released

Replacing the solid-state drive (full-length)

⚠ WARNING: Before working inside your computer, read the safety information that shipped with your computer and follow the steps in [Before working inside your computer](#). After working inside your computer, follow the instructions in [After working inside your computer](#). For more safety best practices, see the Regulatory Compliance home page at www.dell.com/regulatory_compliance.

Identifier	GUID-2E45853F-15D0-4E23-99A9-F91D4DCDF447
Status	Released

Procedure

- 1 Adhere the thermal pad to the solid-state drive.
- 2 Slide the solid-state drive assembly at an angle into the solid-state drive slot.
- 3 Press the other end of the solid-state drive down and replace the screw (M2x3) that secures the solid-state drive to the system board.

Identifier	GUID-D6D9C7FD-F5F2-4841-BED9-C4F8672A8F1D
Status	Released

Post-requisites

- 1 Replace the [battery \(half-length\)](#) or the [battery \(full-length\)](#).
- 2 Replace the [base cover](#).

Identifier	GUID-BF7F1ECA-BC62-4949-B1BE
Status	Released

Removing the speakers

⚠ WARNING: Before working inside your computer, read the safety information that shipped with your computer and follow the steps in [Before working inside your computer](#). After working inside your computer, follow the instructions in [After working inside your computer](#). For more safety best practices, see the Regulatory Compliance home page at www.dell.com/regulatory_compliance.

Identifier	GUID-28F89DF8-99BB-4B9C-88D1-6DB4494163CF
Status	Released

Prerequisites

- 1 Remove the [base cover](#).
- 2 Remove the [battery \(half-length\)](#) or the [battery \(full-length\)](#).

Identifier	GUID-5146EAB7-980D-425D-B274-7DB1561C06D3
Status	Released

Procedure

- 1 Disconnect the speaker cable from the audio daughter-board.
- 2 Note the speaker-cable routing and remove the cable from the routing guides.
- 3 Remove the four screws (M2x2) that secure the speakers to the palm-rest assembly.
- 4 Lift the speakers, along with the speaker cable, off the palm-rest assembly.

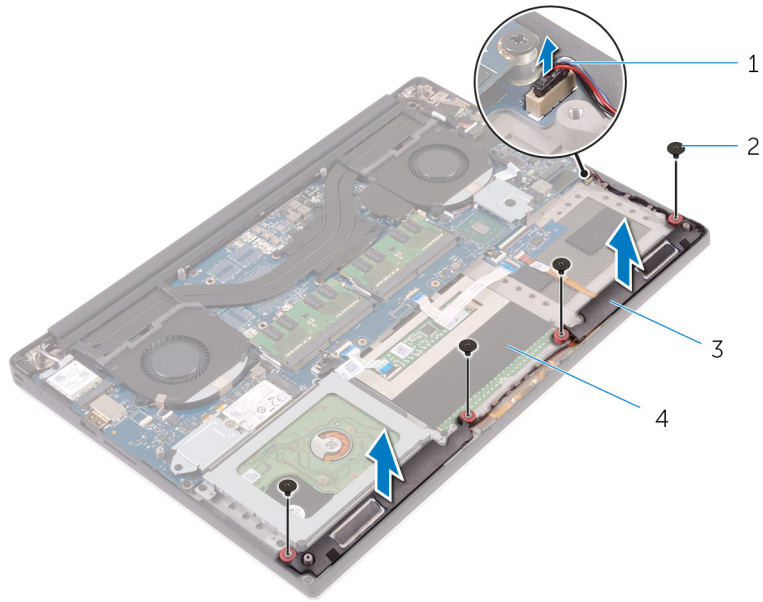

Figure 15. Removing the speakers

- 1 speaker cable
- 3 speakers (2)

- 2 screws (4)
- 4 palm-rest assembly

Identifier	GUID-40DC76F7-B3EC-450A-848E
Status	Released

Replacing the speakers

⚠ WARNING: Before working inside your computer, read the safety information that shipped with your computer and follow the steps in [Before working inside your computer](#). After working inside your computer, follow the instructions in [After working inside your computer](#). For more safety best practices, see the Regulatory Compliance home page at www.dell.com/regulatory_compliance.

Identifier	GUID-AC4AADA4-AE75-4834-B2D7-49DA6C0A92EC
Status	Released

Procedure

- 1 Using the alignment posts, place the speakers on the palm-rest assembly.
- 2 Replace the four screws (M2x2) that secure the speakers to the palm-rest assembly.
- 3 Route the speaker cables through the routing guides on the palm-rest assembly.
- 4 Connect the speaker cable to the audio daughter-board.

Identifier	GUID-D6D9C7FD-F5F2-4841-BED9-C4F8672A8F1D
Status	Released

Post-requisites

- 1 Replace the [battery \(half-length\)](#) or the [battery \(full-length\)](#).
- 2 Replace the [base cover](#).

Identifier	GUID-4AF7A7F4-79DC-43F4-A4DF
Status	Released

Removing the wireless card

⚠ WARNING: Before working inside your computer, read the safety information that shipped with your computer and follow the steps in [Before working inside your computer](#). After working inside your computer, follow the instructions in [After working inside your computer](#). For more safety best practices, see the Regulatory Compliance home page at www.dell.com/regulatory_compliance.

Identifier	GUID-28F89DF8-99BB-4B9C-88D1-6DB4494163CF
Status	Released

Prerequisites

- 1 Remove the [base cover](#).
- 2 Remove the [battery \(half-length\)](#) or the [battery \(full-length\)](#).

Identifier	GUID-6F685E0B-92D5-4CEF-AA20-0A459D7A8E89
Status	Released

Procedure

- 1 Loosen the captive screw that secures the wireless-card bracket to the wireless card.
- 2 Lift the wireless-card bracket off the wireless card.
- 3 Disconnect the antenna cables from the wireless card.
- 4 Slide and remove the wireless card out of the wireless-card slot.

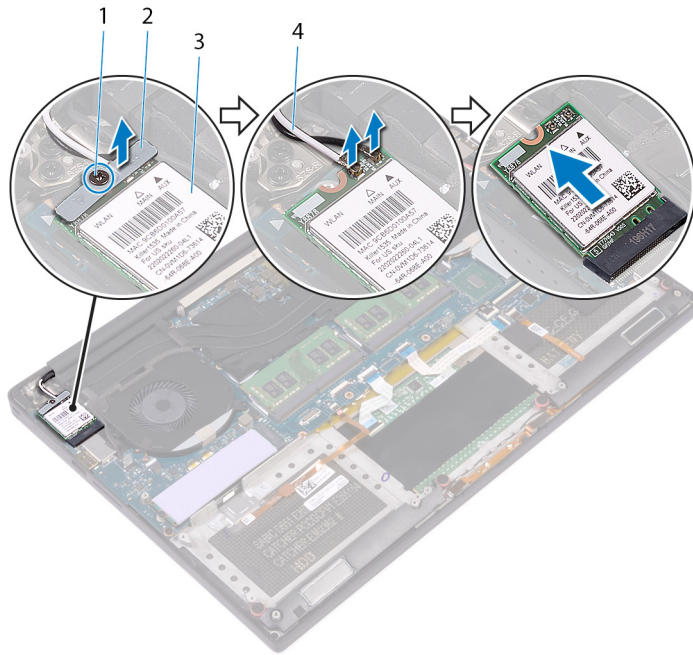

Figure 16. Removing the wireless card

- | | | | |
|---|---------------|---|-----------------------|
| 1 | captive screw | 2 | wireless-card bracket |
| 3 | wireless card | 4 | antenna cables (2) |

Identifier	GUID-94E88AEC-6F12-4B0E-AA6A
Status	Released

Replacing the wireless card

⚠ WARNING: Before working inside your computer, read the safety information that shipped with your computer and follow the steps in [Before working inside your computer](#). After working inside your computer, follow the instructions in [After working inside your computer](#). For more safety best practices, see the Regulatory Compliance home page at www.dell.com/regulatory_compliance.

Identifier	GUID-7D457601-D15C-4126-B9DA-6C9B7B8A871C
Status	Released

Procedure

⚠ CAUTION: To avoid damage to the wireless card, do not place any cables under it.

- 1 Align the notch on the wireless card with the tab on the wireless-card slot and slide the card into the slot.
- 2 Connect the antenna cables to the wireless card. The following table provides the antenna-cable color scheme for the wireless card supported by your computer:

Table 2. Antenna-cable color scheme

Connectors on the wireless card	Antenna-cable color
Main (white triangle)	White
Auxiliary (black triangle)	Black

- 3 Align the screw hole on the wireless-card bracket with the screw-hole on the wireless card.
- 4 Tighten the captive screw that secures the wireless-card bracket to the wireless card.

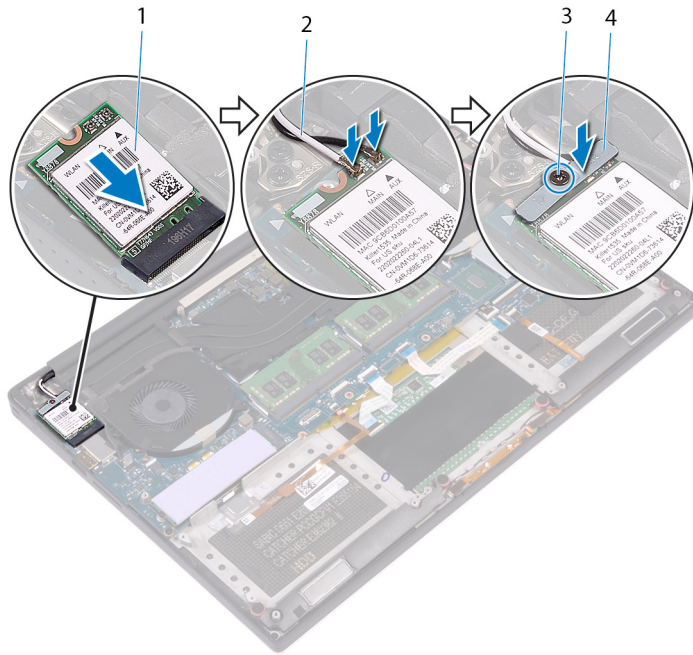

Figure 17. Replacing the wireless card

- | | | | |
|---|---------------|---|-----------------------|
| 1 | wireless card | 2 | antenna cables (2) |
| 3 | captive screw | 4 | wireless-card bracket |

Identifier	GUID-D6D9C7FD-F5F2-4841-BED9-C4F8672A8F1D
Status	Released

Post-requisites

- 1 Replace the [battery \(half-length\)](#) or the [battery \(full-length\)](#).
- 2 Replace the [base cover](#).

Identifier	GUID-F98150E9-52A3-4FCD-8420-8
Status	Released

Removing the fans

⚠ WARNING: Before working inside your computer, read the safety information that shipped with your computer and follow the steps in [Before working inside your computer](#). After working inside your computer, follow the instructions in [After working inside your computer](#). For more safety best practices, see the Regulatory Compliance home page at www.dell.com/regulatory_compliance.

Identifier	GUID-28F89DF8-99BB-4B9C-88D1-6DB4494163CF
Status	Released

Prerequisites

- 1 Remove the [base cover](#).
- 2 Remove the [battery \(half-length\)](#) or the [battery \(full-length\)](#).

Identifier	GUID-46347393-A4A3-49D6-B230-FFDA52BEE4A3
Status	Released

Procedure

- 1 Remove the two screws (M2x4) that secure the right fan to the system-board assembly.
- 2 Disconnect the touch-screen cable (optional) from the system-board assembly.

ⓘ NOTE: The touch-screen cable is available only on laptop configurations with touch displays.

- 3 Peel off the tape that secures the touch-screen cable (optional) to the right fan.
- 4 Peel off the tape that secures the touch-screen cable (optional) to the system board.
- 5 Disconnect the right fan cable (JFAN2) from the system-board assembly.
- 6 Lift the right fan off the palm-rest assembly.

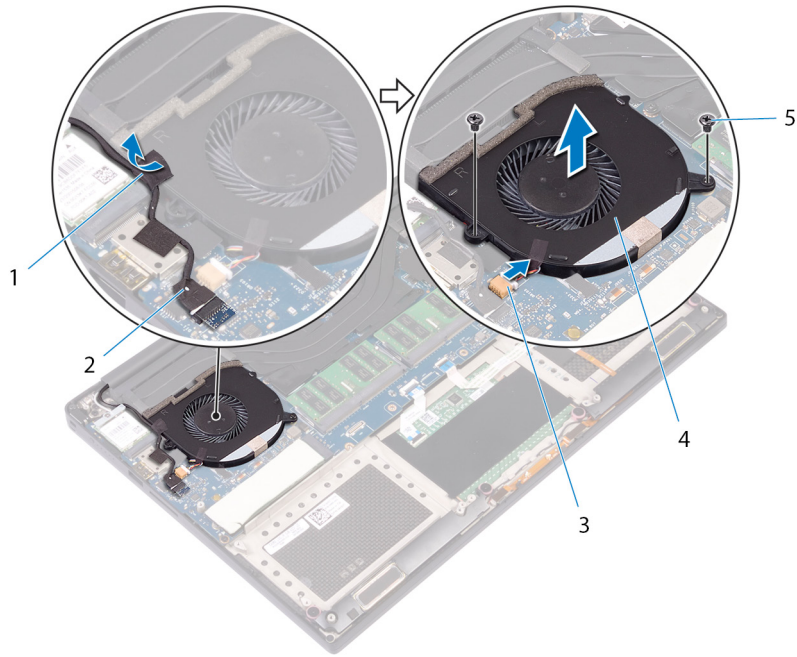

Figure 18. Removing the right fan

- | | | | |
|---|-------------------|---|-------------------------------|
| 1 | tape | 2 | touch-screen cable (optional) |
| 3 | fan cable (JFAN2) | 4 | right fan |
| 5 | screws (2) | | |

7 Remove the two screws (M2x4) that secure the display-cable bracket to the system-board assembly.

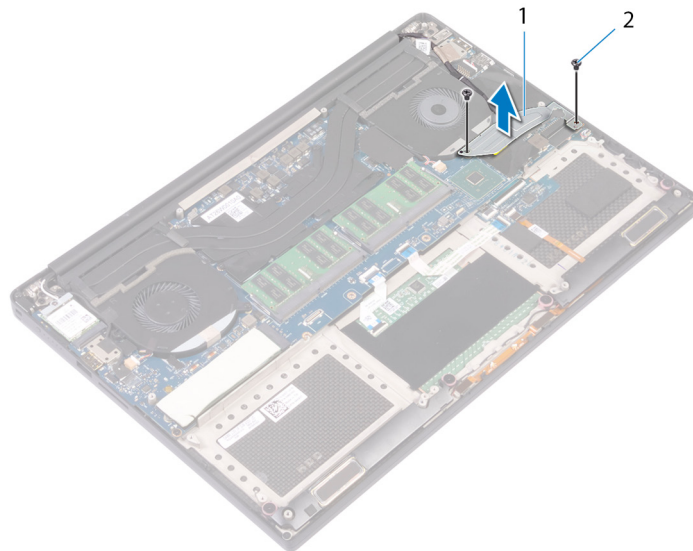

Figure 19. Removing the display-cable bracket

- | | | | |
|---|-----------------------|---|------------|
| 1 | display-cable bracket | 2 | screws (2) |
|---|-----------------------|---|------------|

- 8 Disconnect the display cable from the system-board assembly.
 9 Note the routing of the display cable and remove the cable from the routing guides on the left fan.
 10 Peel off the tape that secures the display cable to the system-board assembly.
 11 Disconnect the left fan cable (JFAN1) from the system-board assembly.

- 12 Remove the screw (M2x4) that secures the left fan to the palm-rest assembly.
- 13 Lift the left fan off the palm-rest assembly.

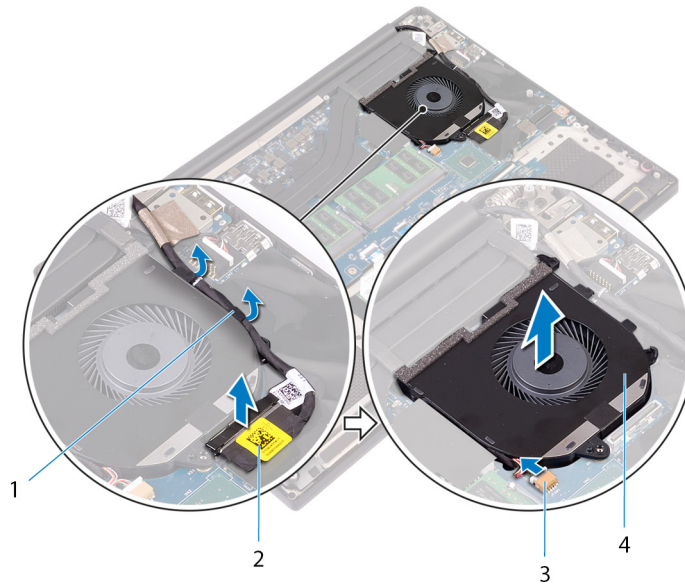

Figure 20. Removing the left fan

- | | | | |
|---|-------------------|---|---------------|
| 1 | routing guides | 2 | display cable |
| 3 | fan cable (JFAN1) | 4 | left fan |

Identifier	GUID-C3E89978-1994-4C7D-98C9-
Status	Released

Replacing the fans

⚠ WARNING: Before working inside your computer, read the safety information that shipped with your computer and follow the steps in [Before working inside your computer](#). After working inside your computer, follow the instructions in [After working inside your computer](#). For more safety best practices, see the Regulatory Compliance home page at www.dell.com/regulatory_compliance.

Identifier	GUID-C8036FB4-AC64-4DE0-89EC-B4D4C3105DBD
Status	Released

Procedure

- 1 Align and place the left fan on the palm-rest assembly.
- 2 Replace the screw (M2x4) that secures the left fan to the palm-rest assembly.
- 3 Connect the left fan cable (JFAN1) to the system-board assembly.
- 4 Adhere the tape that secures the display cable to the system-board assembly.
- 5 Route the display cable through the routing guides on the left fan.

① NOTE: When routing the display cable, make sure that the cable is not routed over the screw hole on the left fan.

- 6 Connect the display cable to the system-board assembly.
- 7 Replace the two screws (M2x4) that secure the display-cable bracket to the system-board assembly.
- 8 Align and place the right fan on the palm-rest assembly.
- 9 Connect the right fan cable (JFAN2) cable to the system-board assembly.
- 10 Route the touch-screen cable (optional) through the routing guides on the right fan.

① NOTE: When routing the touch-screen cable, ensure that the cable is not routed over the screw hole on the right fan.

- 11 Adhere the tape that secures the touch-screen cable (optional) to the right fan.
- 12 Connect the touch-screen cable (optional) to the system-board assembly.
- 13 Replace the two screws (M2x4) that secure the right fan (JFAN2) to the system-board assembly.

Identifier	GUID-D6D9C7FD-F5F2-4841-BED9-C4F8672A8F1D
Status	Released

Post-requisites

- 1 Replace the [battery \(half-length\)](#) or the [battery \(full-length\)](#).
- 2 Replace the [base cover](#).

Identifier	GUID-3AE08A92-614C-4411-90FB-
Status	Released

Removing the heat sink

- ⚠ WARNING:** Before working inside your computer, read the safety information that shipped with your computer and follow the steps in [Before working inside your computer](#). After working inside your computer, follow the instructions in [After working inside your computer](#). For more safety best practices, see the Regulatory Compliance home page at www.dell.com/regulatory_compliance.
- ⚠ WARNING:** The heat sink may become hot during normal operation. Allow sufficient time for the heat sink to cool before you touch it.
- ⚠ CAUTION:** For maximum cooling of the processor, do not touch the heat transfer areas on the heat sink. The oils in your skin can reduce the heat transfer capability of the thermal grease.

Identifier	GUID-28F89DF8-99BB-4B9C-88D1-6DB4494163CF
Status	Released

Prerequisites

- 1 Remove the [base cover](#).
- 2 Remove the [battery \(half-length\)](#) or the [battery \(full-length\)](#).

Identifier	GUID-D0336A92-DD14-4B56-9EE6-70503A69BD17
Status	Released

Procedure

- 1 In sequential order (indicated on the heat sink), remove the four screws (M2x3) that secure the heat sink to the system board.
 - ① **NOTE:** The fourth screw is covered by tape. Remove this screw before lifting the heat sink from the system board.
 - ① **NOTE:** For configurations shipped with integrated graphics, the heat sink has only three screws (M2x3).
- 2 Lift the heat sink off the system board.

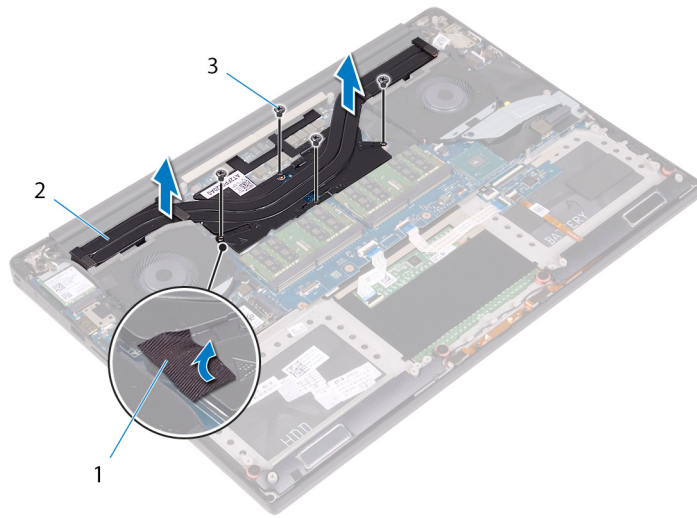

Figure 21. Removing the heat sink

1 heat sink

2 screws (5)

Identifier	GUID-69332260-F504-4C70-A535-1
Status	Released

Replacing the heat sink

⚠ WARNING: Before working inside your computer, read the safety information that shipped with your computer and follow the steps in [Before working inside your computer](#). After working inside your computer, follow the instructions in [After working inside your computer](#). For more safety best practices, see the Regulatory Compliance home page at www.dell.com/regulatory_compliance.

⚠ CAUTION: Incorrect alignment of the heat sink can damage the system board and processor.

ⓘ NOTE: If either the system board or the heat sink is replaced, use the thermal pad/paste provided in the kit to ensure that thermal conductivity is achieved.

Identifier	GUID-CA991006-FF8C-4D79-86B6-6EA732DC181D
Status	Released

Procedure

- 1 Align the screw holes on the heat sink with the screw holes on the system board.
- 2 In sequential order (indicated on the heat sink), replace the four screws (M2x3) that secure the heat sink to the system board.

ⓘ NOTE: For configurations shipped with integrated graphics, the heat sink has only three screws (M2x3).

Identifier	GUID-D6D9C7FD-F5F2-4841-BED9-C4F8672A8F1D
Status	Released

Post-requisites

- 1 Replace the [battery \(half-length\)](#) or the [battery \(full-length\)](#).
- 2 Replace the [base cover](#).

Identifier	GUID-D0608F72-3719-40C9-9E39-5
Status	Released

Removing the system-board assembly

⚠ WARNING: Before working inside your computer, read the safety information that shipped with your computer and follow the steps in [Before working inside your computer](#). After working inside your computer, follow the instructions in [After working inside your computer](#). For more safety best practices, see the Regulatory Compliance home page at www.dell.com/regulatory_compliance.

- ⓘ NOTE:** Your computer's Service Tag is stored in the system board. You must enter the Service Tag in the BIOS setup program after you replace the system board.
- ⓘ NOTE:** Replacing the system board removes any changes you have made to the BIOS using the BIOS setup program. You must make the appropriate changes again after you replace the system board.
- ⓘ NOTE:** Before disconnecting the cables from the system board, note the location of the connectors so that you can reconnect the cables correctly after you replace the system board.

Identifier	GUID-3CDEC4BE-A292-4A1F-BC04-BF305C3B75C9
Status	Released

Prerequisites

- ⓘ NOTE:** Remove the SD card before removing the system board to avoid damage to the SD card.

- 1 Remove the [base cover](#).
- 2 Remove the [battery \(half-length\)](#) or the [battery \(full-length\)](#).
- 3 Remove the [memory modules](#).
- 4 Follow the procedure from step 1 to step 4 in "[Removing the hard drive](#)".
- 5 Remove the [solid-state drive \(half-length\)](#) or the [solid-state drive \(full-length\)](#).
- 6 Remove the [wireless card](#).
- 7 Remove the [fans](#).
- 8 Remove the [heat sink](#).

Identifier	GUID-E70EEBAE-98A7-4629-BF58-0FFAF88EB51B
Status	Released

Procedure

- ⓘ NOTE:** The touch-screen cable is available only on laptop configurations with touch displays.

- 1 Disconnect the power-adaptor port cable and speaker cable from the system-board assembly.
- 2 Open the latch and disconnect the keyboard-control board cable and touchpad cable from the system-board assembly.
- 3 Peel the tape to access the fingerprint reader cable.
- 4 Open the latch and disconnect the fingerprint reader cable (optional) from the system-board assembly.
- 5 Peel off the tape that secures the touch-screen cable to the system-board assembly if applicable.
- 6 Peel the tape and then disconnect the touch-screen cable from the system-board assembly if applicable.

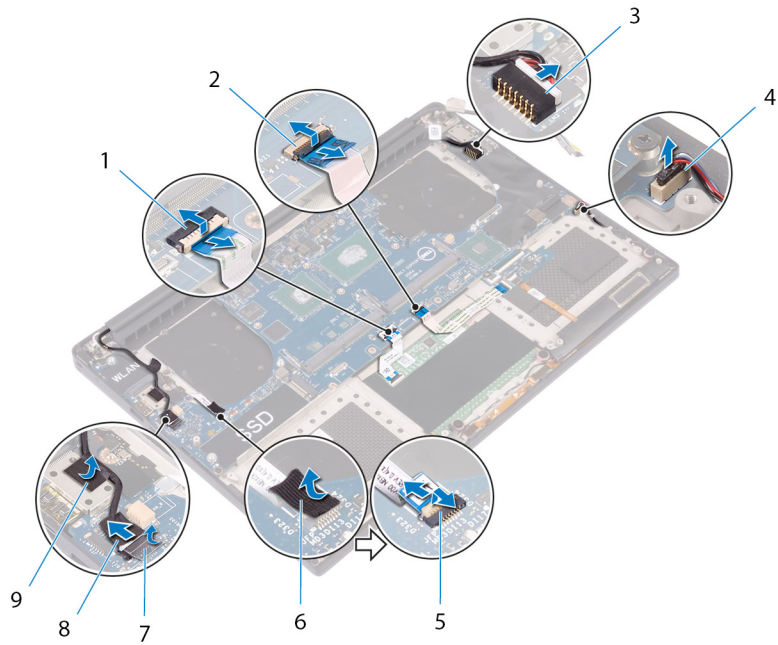

Figure 22. Disconnecting the cables

- | | | | |
|---|-------------------------------------|---|-------------------------------|
| 1 | touchpad cable | 2 | keyboard control-board cable |
| 3 | power-adaptor port cable | 4 | speaker cable |
| 5 | fingerprint reader cable (optional) | 6 | tape |
| 7 | tape | 8 | touch-screen cable (optional) |
| 9 | tape | | |

- 7 Remove the four screws (M2x4) that secure the system-board assembly to the palm-rest assembly.
- 8 Lift the system-board assembly off the palm-rest assembly.

⚠ CAUTION: Do not hold the system board on the area of heat transfer and circuitry.

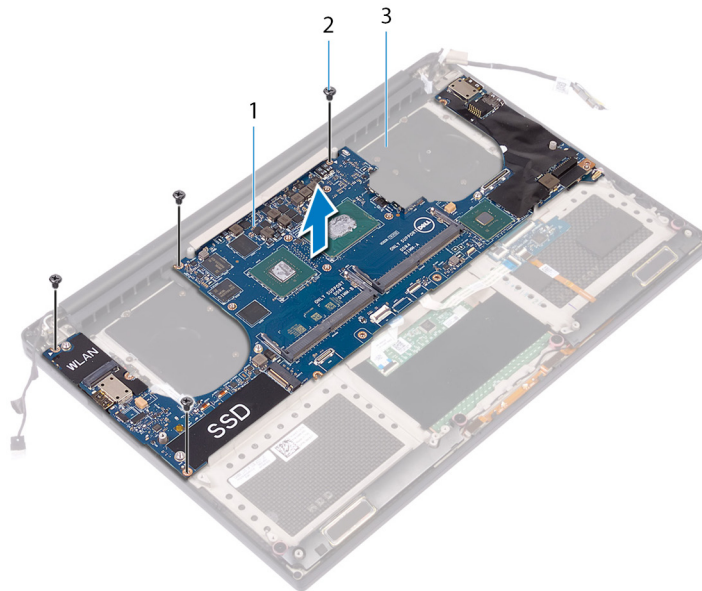

Figure 23. Removing the system board

- 1 system-board assembly
- 2 screws (4)
- 3 palm-rest assembly

Identifier	GUID-828BE30D-72EC-4782-A72D-
Status	Released

Replacing the system-board assembly

⚠ WARNING: Before working inside your computer, read the safety information that shipped with your computer and follow the steps in [Before working inside your computer](#). After working inside your computer, follow the instructions in [After working inside your computer](#). For more safety best practices, see the Regulatory Compliance home page at www.dell.com/regulatory_compliance.

ⓘ NOTE: Your computer's Service Tag is stored in the system board. You must enter the Service Tag in the BIOS setup program after you replace the system board.

ⓘ NOTE: Replacing the system board removes any changes you have made to the BIOS using the BIOS setup program. You must make the appropriate changes again after you replace the system board.

Identifier	GUID-42E57A41-7130-4EED-92E6-6D0076C96D49
Status	Released

Procedure

⚠ CAUTION: Do not hold the system board on the area of heat transfer and circuitry.

- 1 Align the screw holes on the system-board assembly with the screw holes on the palm-rest assembly.
- 2 Replace the four screws (M2x4) that secure the system-board assembly to the palm-rest assembly.
- 3 Adhere the tape and then connect the touch-screen cable to the system-board assembly if applicable.
- 4 Adhere the tape that secures the touch-screen cable to the system-board assembly if applicable.
- 5 Slide the fingerprint reader cable (optional) into the connector on the system-board assembly and close the latch to secure the cable.
- 6 Adhere the tape that secures the fingerprint reader cable (optional).
- 7 Slide the keyboard-control board cable and touchpad cable into their connectors on the system-board assembly and then close the latches to secure the cable.
- 8 Connect the power-adaptor port cable and speaker cable to the system-board assembly.

Identifier	GUID-089EE999-93A9-452E-8B02-09D8FCFB7C90
Status	Released

Post-requisites

- 1 Replace the [memory modules](#).
- 2 Replace the [heat sink](#).
- 3 Replace the [fans](#).
- 4 Replace the [solid-state drive \(half-length\)](#) or the [solid-state drive \(full-length\)](#).
- 5 Follow the procedure from step 3 to step 6 in "[Replacing the hard drive](#)".
- 6 Replace the [wireless card](#).
- 7 Replace the [battery \(half-length\)](#) or the [battery \(full-length\)](#).
- 8 Replace the [base cover](#).

Identifier	GUID-3C23730D-19FE-4A80-8998-9
Status	Released

Removing the audio daughter-board

⚠ WARNING: Before working inside your computer, read the safety information that shipped with your computer and follow the steps in [Before working inside your computer](#). After working inside your computer, follow the instructions in [After working inside your computer](#). For more safety best practices, see the Regulatory Compliance home page at www.dell.com/regulatory_compliance.

Identifier	GUID-44D35805-8B60-4013-B93B-9D1ACACD3E33
Status	Released

Prerequisites

- 1 Remove the [base cover](#).
- 2 Remove the [battery \(half-length\)](#) or the [battery \(full-length\)](#).
- 3 Remove the [memory modules](#).
- 4 Follow the procedure from step 1 to step 4 in "[Removing the hard drive](#)".
- 5 Remove the [solid-state drive \(half-length\)](#) or the [solid-state drive \(full-length\)](#).
- 6 Remove the [wireless card](#).
- 7 Remove the [fans](#).
- 8 Remove the [heat sink](#).
- 9 Remove the [system-board assembly](#).

Identifier	GUID-C0E536CB-A5B6-46D2-B284-ECC799DFCD03
Status	Released

Procedure

- 1 Remove the two screws (M2x3) that secure the audio daughter-board to the system-board assembly.
- 2 Lift the audio daughter-board off the system board.

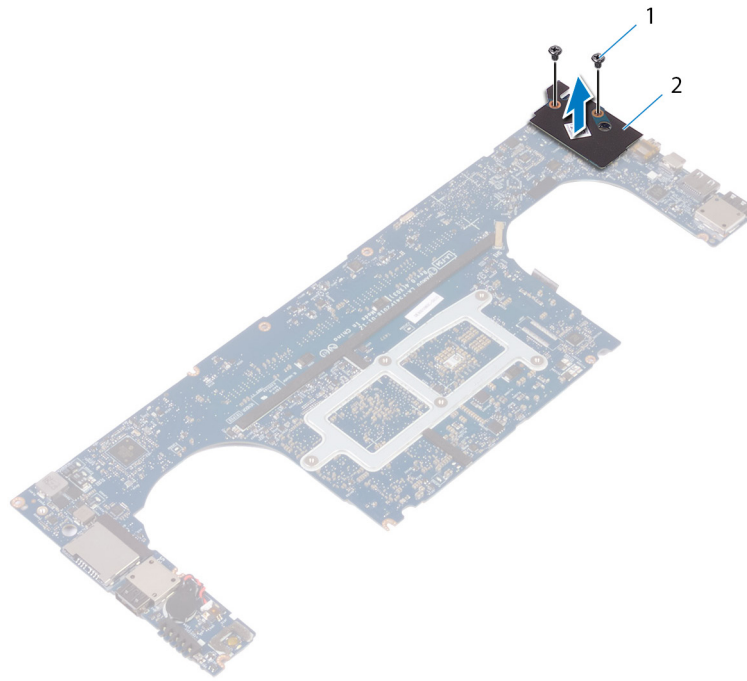

Figure 24. Removing the audio daughter-board

1 screws (2)

2 audio daughter-board

Identifier	GUID-14B28E08-E8D1-4B67-83F3-
Status	Released

Replacing the audio daughter-board

⚠ WARNING: Before working inside your computer, read the safety information that shipped with your computer and follow the steps in [Before working inside your computer](#). After working inside your computer, follow the instructions in [After working inside your computer](#). For more safety best practices, see the Regulatory Compliance home page at www.dell.com/regulatory_compliance.

Identifier	GUID-C9A47377-4CCF-4494-8D1D-338EF8D7B50C
Status	Released

Procedure

- 1 Align the connector on the audio daughter-board with the connector on the system board and snap it into place.
- 2 Replace the two screws (M2x3) that secures the audio daughter-board to the system board.

Identifier	GUID-918C0499-50D7-49AB-8F43-B72724B368FF
Status	Released

Post-requisites

- 1 Replace the [system-board assembly](#).
- 2 Replace the [memory modules](#).
- 3 Replace the [heat sink](#).
- 4 Replace the [fans](#).
- 5 Replace the [solid-state drive \(half-length\)](#) or the [solid-state drive \(full-length\)](#).
- 6 Follow the procedure from step 3 to step 6 in "[Replacing the hard drive](#)".
- 7 Replace the [wireless card](#).
- 8 Replace the [battery \(half-length\)](#) or the [battery \(full-length\)](#).
- 9 Replace the [base cover](#).

Identifier	GUID-30EEBC49-DE3E-4C3F-8226
Status	Released

Removing the coin-cell battery

⚠ WARNING: Before working inside your computer, read the safety information that shipped with your computer and follow the steps in [Before working inside your computer](#). After working inside your computer, follow the instructions in [After working inside your computer](#). For more safety best practices, see the Regulatory Compliance home page at www.dell.com/regulatory_compliance.

⚠ CAUTION: Removing the coin-cell battery resets the BIOS setup program's settings to default. It is recommended that you note the BIOS setup program's settings before removing the coin-cell battery.

Identifier	GUID-6634F686-747A-4FB1-8FEB-7271331E5E56
Status	Released

Prerequisites

- 1 Remove the [base cover](#).
- 2 Remove the [battery \(half-length\)](#) or the [battery \(full-length\)](#).
- 3 Remove the [memory modules](#).
- 4 Follow the procedure from step 1 to step 4 in "[Removing the hard drive](#)".
- 5 Remove the [solid-state drive \(half-length\)](#) or the [solid-state drive \(full-length\)](#).
- 6 Remove the [wireless card](#).
- 7 Remove the [fans](#).
- 8 Remove the [heat sink](#).
- 9 Remove the [system-board assembly](#).

Identifier	GUID-4BC8BFAC-8B48-446D-BECF-20E0BE1F933E
Status	Released

Procedure

- 1 Turn the system-board assembly over.
- 2 Disconnect the coin-cell battery cable from the system board.
- 3 Note the location of the coin-cell battery and pry it off the system board.

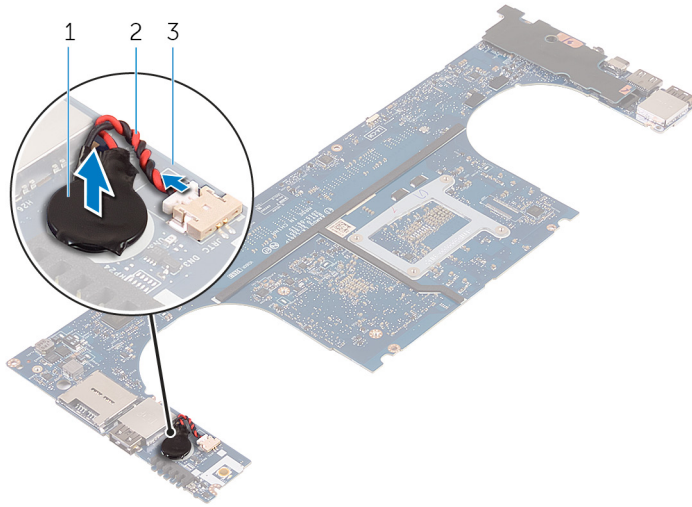

Figure 25. Removing the coin-cell battery

- 1 coin-cell battery
- 3 system board

- 2 coin-cell battery cable

Identifier	GUID-5E22F4A0-F01F-4522-8155-E
Status	Released

Replacing the coin-cell battery

⚠ WARNING: Before working inside your computer, read the safety information that shipped with your computer and follow the steps in **Before working inside your computer**. After working inside your computer, follow the instructions in **After working inside your computer**. For more safety best practices, see the Regulatory Compliance home page at www.dell.com/regulatory_compliance.

Identifier	GUID-A26355E1-1177-48A1-86DE-85C0637849C0
Status	Released

Procedure

- 1 Adhere the coin-cell battery to the system board.
- 2 Connect the coin-cell battery cable to the system board.
- 3 Turn the system board over.

Identifier	GUID-4EB5EDC2-D30F-4CBF-A7C9-99B10F18D946
Status	Released

Post-requisites

- 1 Replace the [system-board assembly](#).
- 2 Replace the [memory modules](#).
- 3 Replace the [heat sink](#).
- 4 Replace the [fans](#).
- 5 Replace the [solid-state drive \(half-length\)](#) or the [solid-state drive \(full-length\)](#).
- 6 Follow the procedure from step 3 to step 6 in "[Replacing the hard drive](#)".
- 7 Replace the [wireless card](#).
- 8 Replace the [battery \(half-length\)](#) or the [battery \(full-length\)](#).
- 9 Replace the [base cover](#).

Identifier	GUID-5AE964CF-7958-4D31-BBA8
Status	Released

Removing the keyboard

⚠ WARNING: Before working inside your computer, read the safety information that shipped with your computer and follow the steps in [Before working inside your computer](#). After working inside your computer, follow the instructions in [After working inside your computer](#). For more safety best practices, see the Regulatory Compliance home page at www.dell.com/regulatory_compliance.

Identifier	GUID-BE0AEDCA-F3D2-47B1-8A55-2367CF360BD7
Status	Released

Prerequisites

- 1 Remove the [base cover](#).
- 2 Remove the [battery \(half-length\)](#) or the [battery \(full-length\)](#).
- 3 Remove the [memory modules](#).
- 4 Follow the procedure from step 1 to step 4 in "[Removing the hard drive](#)".
- 5 Remove the [solid-state drive \(half-length\)](#) or the [solid-state drive \(full-length\)](#).
- 6 Remove the [wireless card](#).
- 7 Remove the [fans](#).
- 8 Remove the [heat sink](#).
- 9 Remove the [system-board assembly](#).

Identifier	GUID-7E2A3847-8117-4A18-9515-E6C10A2F7EBF
Status	Released

Procedure

- 1 Peel off the fingerprint reader cable from the palm-rest assembly.
- 2 Peel off the Mylar that secures the keyboard to the palm-rest assembly.

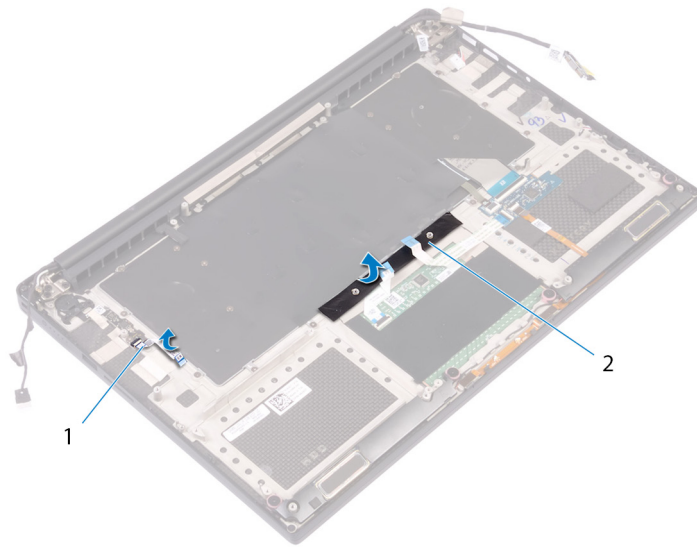

Figure 26. Peeling the Mylar

- | | |
|----------------------------|--------|
| 1 fingerprint-reader cable | 2 tape |
|----------------------------|--------|

- 3 Open the latches and disconnect the keyboard cable and keyboard-backlight cable from the keyboard-controls board.
- 4 Lift up the Mylar to access the screws that secure the keyboard to the palm-rest assembly.

NOTE: All new keyboards will be shipped with the Mylar. Do not peel off the Mylar.

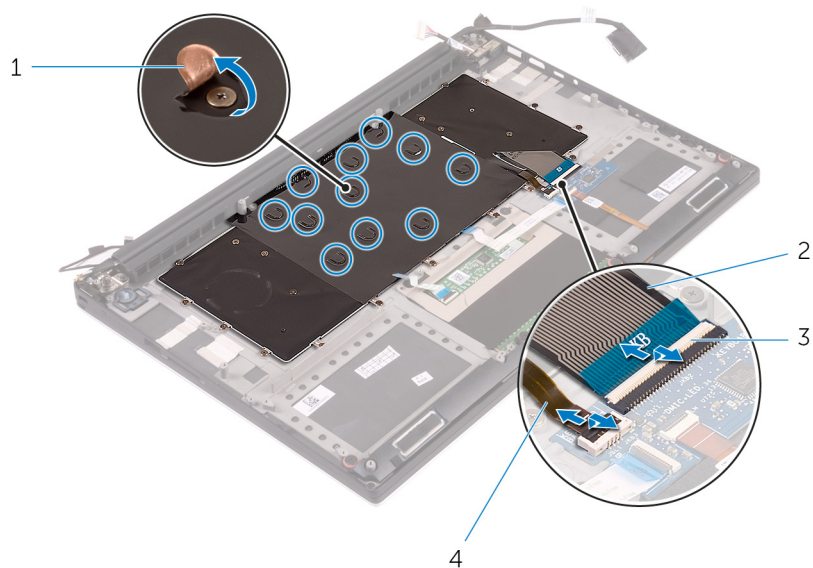

Figure 27. Disconnecting the keyboard and keyboard-backlight cable

- | | |
|---------------|----------------------------|
| 1 Mylar | 2 keyboard cable |
| 3 latches (2) | 4 keyboard-backlight cable |

- 5 Remove the 31 screws (M1.6x1.5) that secure the keyboard to the palm-rest assembly.
- 6 Lift the keyboard off the palm-rest assembly.

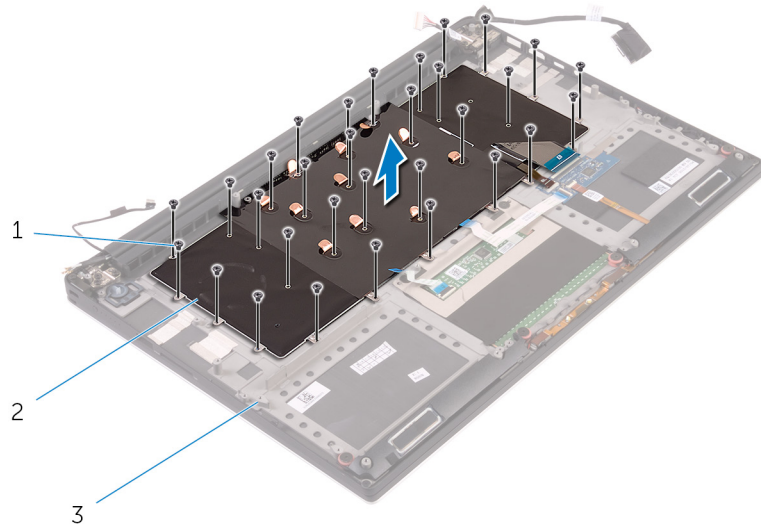

Figure 28. Removing the screws from the keyboard

- 1 screws (31)
- 3 palm-rest assembly

2 keyboard

Identifier	GUID-18204C76-DF75-4DB8-BD6F
Status	Released

Replacing the keyboard

⚠ WARNING: Before working inside your computer, read the safety information that shipped with your computer and follow the steps in [Before working inside your computer](#). After working inside your computer, follow the instructions in [After working inside your computer](#). For more safety best practices, see the Regulatory Compliance home page at www.dell.com/regulatory_compliance.

Identifier	GUID-3BFE10CB-CE60-41A8-9022-145130950C6A
Status	Released

Procedure

- 1 Place the keyboard on the palm-rest assembly
- 2 Align the screw holes on the keyboard with the screw holes on the palm-rest assembly.
- 3 Replace the 31 screws (M1.6x1.5) that secure the keyboard to the palm-rest assembly.
- 4 Adhere the Mylar that secures the keyboard to the palm-rest assembly.
- 5 Connect the keyboard cable and keyboard-backlight cable to the keyboard-controls board and close the latch to secure the cable.
- 6 Adhere the Mylar that secures the keyboard to the palm-rest assembly.
- 7 Adhere the tape that secures the fingerprint-reader cable to the palm-rest assembly.

Identifier	GUID-9DB0941C-C68E-41AA-921E-F226F8F0F3E5
Status	Released

Post-requisites

- 1 Replace the [system-board assembly](#).
- 2 Replace the [memory modules](#).
- 3 Replace the [heat sink](#).
- 4 Replace the [fans](#).
- 5 Replace the [solid-state drive \(half-length\)](#) or the [solid-state drive \(full-length\)](#).
- 6 Follow the procedure from step 3 to step 6 in ["Replacing the hard drive"](#).
- 7 Replace the [wireless card](#).
- 8 Replace the [battery \(half-length\)](#) or the [battery \(full-length\)](#).
- 9 Replace the [base cover](#).

Identifier	GUID-E31FD4D2-D7F5-4CA7-80D8
Status	Released

Removing the power-button module

⚠ WARNING: Before working inside your computer, read the safety information that shipped with your computer and follow the steps in [Before working inside your computer](#). After working inside your computer, follow the instructions in [After working inside your computer](#). For more safety best practices, see the Regulatory Compliance home page at www.dell.com/regulatory_compliance.

Identifier	GUID-280BCF63-F840-441D-9C1E-82A4D9DCC53D
Status	Released

Prerequisites

① **NOTE:** The fingerprint reader is available depending on the configuration ordered.

- 1 Remove the [base cover](#).
- 2 Remove the [battery \(half-length\)](#) or the [battery \(full-length\)](#).
- 3 Remove the [memory modules](#).
- 4 Follow the procedure from step 1 to step 4 in "[Removing the hard drive](#)".
- 5 Remove the [solid-state drive \(half-length\)](#) or the [solid-state drive \(full-length\)](#).
- 6 Remove the [wireless card](#).
- 7 Remove the [heat sink](#).
- 8 Remove the [fans](#).
- 9 Remove the [system-board assembly](#).

Identifier	GUID-05B43FF3-D2EA-4E57-AD5F-B67D18EB5427
Status	Released

Procedure

- 1 Remove the two screws (M1.6x3) that secure the power-button module to the palm-rest assembly.
- 2 Lift the power-button module off the palm-rest assembly.

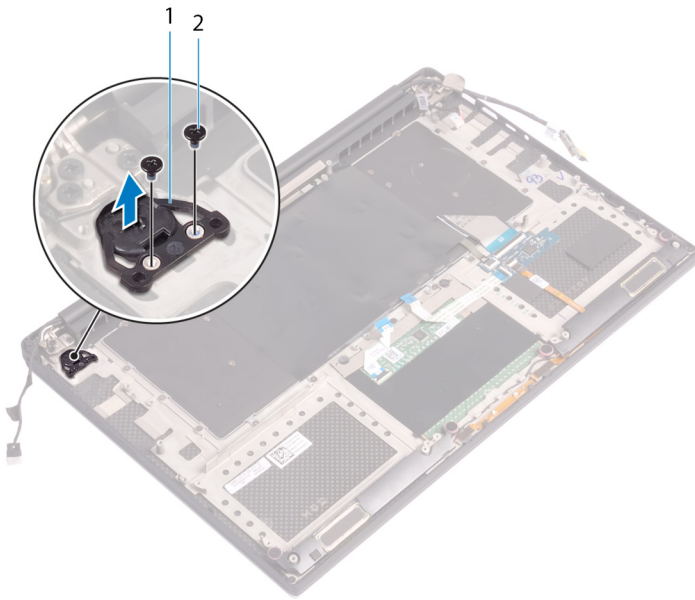

Identifier	GUID-1742A3A3-E83D-4D87-91DA
Status	Released

Replacing the power-button module

⚠ WARNING: Before working inside your computer, read the safety information that shipped with your computer and follow the steps in [Before working inside your computer](#). After working inside your computer, follow the instructions in [After working inside your computer](#). For more safety best practices, see the Regulatory Compliance home page at www.dell.com/regulatory_compliance.

Identifier	GUID-D02421AB-682F-4E73-BA05-DAC3EDE9FD95
Status	Released

Procedure

- 1 Align and place the power-button module on the palm-rest assembly.
- 2 Replace the two screws (M1.6x3) that secure the power-button module to the palm-rest assembly.

Identifier	GUID-8BFF1414-A524-4484-A5A8-94B56F1CA501
Status	Released

Post-requisites

ⓘ NOTE: The fingerprint reader is available depending on the configuration ordered.

- 1 Replace the [system-board assembly](#).
- 2 Replace the [fans](#).
- 3 Replace the [heat sink](#).
- 4 Replace the [wireless card](#).
- 5 Replace the [solid-state drive \(half-length\)](#) or the [solid-state drive \(full-length\)](#).
- 6 Follow the procedure from step 3 to step 6 in “[Replacing the hard drive](#)”.
- 7 Replace the [memory modules](#).
- 8 Replace the [battery \(half-length\)](#) or the [battery \(full-length\)](#).
- 9 Replace the [base cover](#).

Identifier	GUID-0CB0CD7D-64C1-420C-A74D
Status	Released

Removing the fingerprint reader daughter-board (optional)

⚠ WARNING: Before working inside your computer, read the safety information that shipped with your computer and follow the steps in [Before working inside your computer](#). After working inside your computer, follow the instructions in [After working inside your computer](#). For more safety best practices, see the Regulatory Compliance home page at www.dell.com/regulatory_compliance.

Identifier	GUID-280BCF63-F840-441D-9C1E-82A4D9DCC53D
Status	Released

Prerequisites

ⓘ NOTE: The fingerprint reader is available depending on the configuration ordered.

- 1 Remove the [base cover](#).
- 2 Remove the [battery \(half-length\)](#) or the [battery \(full-length\)](#).
- 3 Remove the [memory modules](#).
- 4 Follow the procedure from step 1 to step 4 in "[Removing the hard drive](#)".
- 5 Remove the [solid-state drive \(half-length\)](#) or the [solid-state drive \(full-length\)](#).
- 6 Remove the [wireless card](#).
- 7 Remove the [heat sink](#).
- 8 Remove the [fans](#).
- 9 Remove the [system-board assembly](#).

Identifier	GUID-B6470F6C-600F-4DE4-B2D9-FA4F752C44A1
Status	Released

Procedure

- 1 Peel the fingerprint-reader cable (optional) from the palm-rest assembly.
- 2 Peel the tape that secures the power-button module to the palm-rest assembly.
- 3 Remove the screw (M1.6x1.5) that secures the fingerprint-reader board (optional) to the palm-rest assembly.
- 4 Remove the two screws (M1.6x3) that secure the power-button module to the palm-rest assembly.
- 5 Lift the power-button module and fingerprint-reader board (optional) off the palm-rest assembly.

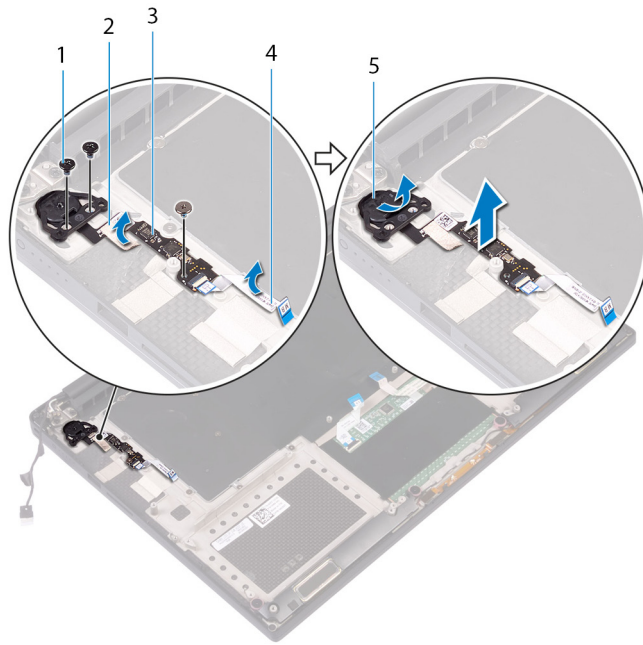

- 1 screw
- 3 fingerprint-reader board (optional)
- 5 power-button module

- 2 tape
- 4 fingerprint-reader cable (optional)

Identifier	GUID-1CD6633C-367C-42BA-A3B8
Status	Released

Replacing the fingerprint reader daughter board (optional)

⚠ WARNING: Before working inside your computer, read the safety information that shipped with your computer and follow the steps in [Before working inside your computer](#). After working inside your computer, follow the instructions in [After working inside your computer](#). For more safety best practices, see the Regulatory Compliance home page at www.dell.com/regulatory_compliance.

Identifier	GUID-D91895C8-5683-49A3-A8FD-CABDB73FEB71
Status	Released

Procedure

- 1 Align and place the power-button module and fingerprint-reader board (optional) on the palm-rest assembly.
- 2 Replace the two screws (M1.6x3) that secure the power-button module to the palm-rest assembly.
- 3 Replace the screw (M1.6x1.5) that secures the fingerprint-reader board (optional) to the palm-rest assembly.
- 4 Adhere the tape that secures the power-button module to the palm-rest assembly.
- 5 Adhere the fingerprint reader daughter-board cable (optional) to the palm-rest assembly.

Identifier	GUID-8BFF1414-A524-4484-A5A8-94B56F1CA501
Status	Released

Post-requisites

ⓘ NOTE: The fingerprint reader is available depending on the configuration ordered.

- 1 Replace the [system-board assembly](#).
- 2 Replace the [fans](#).
- 3 Replace the [heat sink](#).
- 4 Replace the [wireless card](#).
- 5 Replace the [solid-state drive \(half-length\)](#) or the [solid-state drive \(full-length\)](#).
- 6 Follow the procedure from step 3 to step 6 in "[Replacing the hard drive](#)".
- 7 Replace the [memory modules](#).
- 8 Replace the [battery \(half-length\)](#) or the [battery \(full-length\)](#).
- 9 Replace the [base cover](#).

Identifier	GUID-AB1F153B-621B-42FC-89BE
Status	Released

Removing the display assembly

⚠ WARNING: Before working inside your computer, read the safety information that shipped with your computer and follow the steps in [Before working inside your computer](#). After working inside your computer, follow the instructions in [After working inside your computer](#). For more safety best practices, see the Regulatory Compliance home page at www.dell.com/regulatory_compliance.

Identifier	GUID-B56E2301-3ABA-48D9-BC76-A2962E57BC12
Status	Released

Prerequisites

- 1 Remove the [base cover](#).
- 2 Remove the [battery \(half-length\)](#) or the [battery \(full-length\)](#).
- 3 Remove the [wireless card](#).

Identifier	GUID-E6EDE1BD-C493-4867-8008-297F94BFE6F9
Status	Released

Procedure

ⓘ NOTE: The touch-screen cable is available only on laptop configurations with touch displays.

- 1 Remove the two screws (M2x2) that secure the display-cable bracket to the system board.
- 2 Disconnect the display cable from the system board.
- 3 Note the cable routing and remove the display cable from the routing guides on the left fan.
- 4 Peel off the tape that secures the display cable to the system board.
- 5 Peel the tape and disconnect the touch-screen cable from the system board if applicable.
- 6 Peel off the tape that secures the touch-screen cable to the system board if applicable.

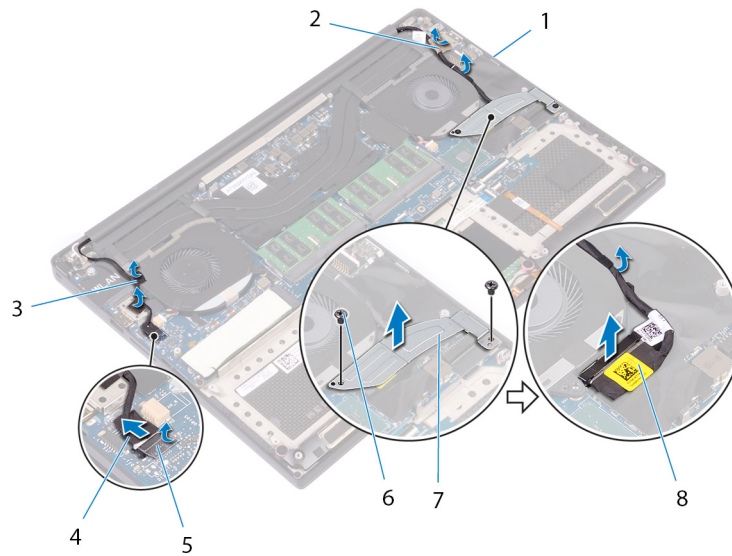

Figure 29. Disconnecting the cables

- | | | | |
|---|----------------------------|---|-------------------------------|
| 1 | routing guides | 2 | tape (display cable) |
| 3 | tapes (touch-screen cable) | 4 | touch-screen cable (optional) |
| 5 | tape | 6 | screws (2) |
| 7 | display-cable bracket | 8 | display cable |

- 7 Turn the computer over and open the display at an angle of 90 degrees.
- 8 Rotate the computer and place it on the edge of the table in a position that allows access to the screws on the display hinges.
- 9 Remove the six screws (M2.5x5) that secure the display hinges to the palm-rest assembly.
- 10 Carefully lift the display assembly from the palm-rest assembly.

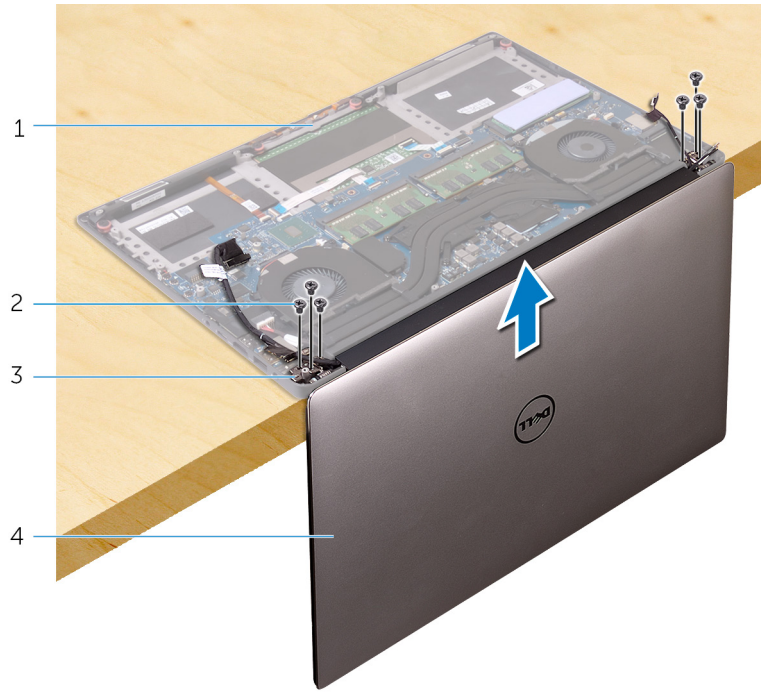

Figure 30. Removing the screws that secure the display hinges to palm-rest assembly

- | | | | |
|---|--------------------|---|------------------|
| 1 | palm-rest assembly | 2 | screws (6) |
| 3 | display hinges (2) | 4 | display assembly |

11 Carefully place the display assembly on a clean, flat surface.

NOTE: The display assembly cannot be further disassembled. If the display bezel, display panel, camera module, display cable and touch-screen cable (optional) are defective and need to be replaced, replace the entire display assembly.



Figure 31. Display assembly

- | | |
|---|------------------|
| 1 | display assembly |
|---|------------------|

Identifier	GUID-2DF70EB1-9D26-4051-8B7C-
Status	Released

Replacing the display assembly

⚠ WARNING: Before working inside your computer, read the safety information that shipped with your computer and follow the steps in [Before working inside your computer](#). After working inside your computer, follow the instructions in [After working inside your computer](#). For more safety best practices, see the Regulatory Compliance home page at www.dell.com/regulatory_compliance.

Identifier	GUID-9DE80CBE-AB75-4075-AFB5-F1C875EBD51E
Status	Released

Procedure

- 1 Place the palm-rest assembly at the edge of the table with the speakers facing away from the edge.
- 2 Align the screw holes on the palm-rest assembly with the screw holes on the display hinges.
- 3 Replace the six screws (M2.5x5) that secure the display assembly to the palm-rest assembly.
- 4 Turn the computer over and open the display at an angle of 90 degrees.
- 5 Adhere the tape that secures the touch-screen cable to the system board if applicable.
- 6 Adhere the tape and connect the touch-screen cable to the system board if applicable.
- 7 Adhere the tape that secures the display cable to the system board.
- 8 Route the display cable through the routing guides on the left fan.

① NOTE: When routing the display cable, make sure that the cable is not routed over the screw hole on the left fan.

- 9 Replace the screw (M2x2) that secures the display-cable bracket to the system board.

Identifier	GUID-96465A79-3284-4285-B73F-150E1B213336
Status	Released

Post-requisites

- 1 Replace the [wireless card](#).
- 2 Replace the [battery \(half-length\)](#) or the [battery \(full-length\)](#).
- 3 Replace the [base cover](#).

Identifier	GUID-35D5032D-9652-403C-9A8A-
Status	Released

Removing the power-adapter port

⚠ WARNING: Before working inside your computer, read the safety information that shipped with your computer and follow the steps in [Before working inside your computer](#). After working inside your computer, follow the instructions in [After working inside your computer](#). For more safety best practices, see the Regulatory Compliance home page at www.dell.com/regulatory_compliance.

Identifier	GUID-2FF28833-B61C-40FB-888B-254BA7578BCB
Status	Released

Prerequisites

- 1 Remove the [base cover](#).
- 2 Remove the [battery \(half-length\)](#) or the [battery \(full-length\)](#).
- 3 Remove the [display assembly](#).

Identifier	GUID-A6D5FBD8-01B6-4CA4-987A-80FE336B8AF5
Status	Released

Procedure

- 1 Disconnect the power-adapter port cable from the system board.
- 2 Remove the screw (M2x3) that secures the power-adapter port to the palm-rest assembly.
- 3 Lift the power-adapter port along with its cable, off the palm-rest assembly.

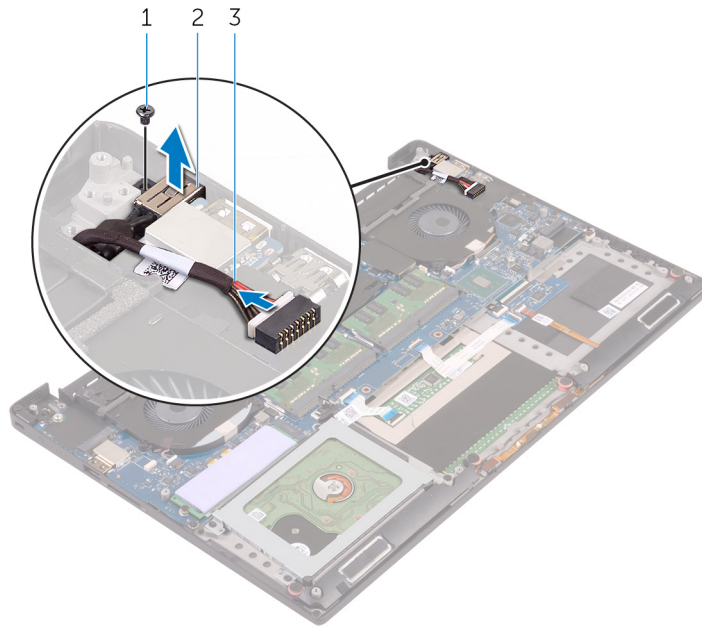

Figure 32. Removing the power-adaptor port

- 1 screw
- 2 power-adaptor port
- 3 power-adaptor port cable

Identifier	GUID-A99140DB-7AF3-4218-B305-
Status	Released

Replacing the power-adapter port

⚠ WARNING: Before working inside your computer, read the safety information that shipped with your computer and follow the steps in [Before working inside your computer](#). After working inside your computer, follow the instructions in [After working inside your computer](#). For more safety best practices, see the Regulatory Compliance home page at www.dell.com/regulatory_compliance.

Identifier	GUID-6573CEC9-6601-4D86-B746-449414FF1856
Status	Released

Procedure

- 1 Place the power-adapter port into the slot on the palm-rest assembly.
- 2 Route the power-adapter port cable through its routing guides on the palm-rest assembly.
- 3 Replace the screw (M2x3) that secures the power-adapter port to the palm-rest assembly.
- 4 Connect the power-adapter port cable to the system board.

Identifier	GUID-F0710676-729E-43A4-BC18-2F7005354246
Status	Released

Post-requisites

- 1 Replace the [display assembly](#).
- 2 Replace the [battery \(half-length\)](#) or the [battery \(full-length\)](#).
- 3 Replace the [base cover](#).

Identifier	GUID-2D298405-DB18-4207-B981-8
Status	Released

Removing the antenna cover

⚠ WARNING: Before working inside your computer, read the safety information that shipped with your computer and follow the steps in [Before working inside your computer](#). After working inside your computer, follow the instructions in [After working inside your computer](#). For more safety best practices, see the Regulatory Compliance home page at www.dell.com/regulatory_compliance.

Identifier	GUID-80BA3639-45CF-469B-A62E-647326B941AC
Status	Released

Prerequisites

- 1 Remove the [base cover](#).
- 2 Remove the [battery \(half-length\)](#) or the [battery \(full-length\)](#).
- 3 Remove the [wireless card](#).
- 4 Remove the [display assembly](#).

Identifier	GUID-A8377F5B-D34E-4898-A4F8-FC8C47A285BF
Status	Released

Procedure

- 1 Carefully turn the display hinges at an angle.

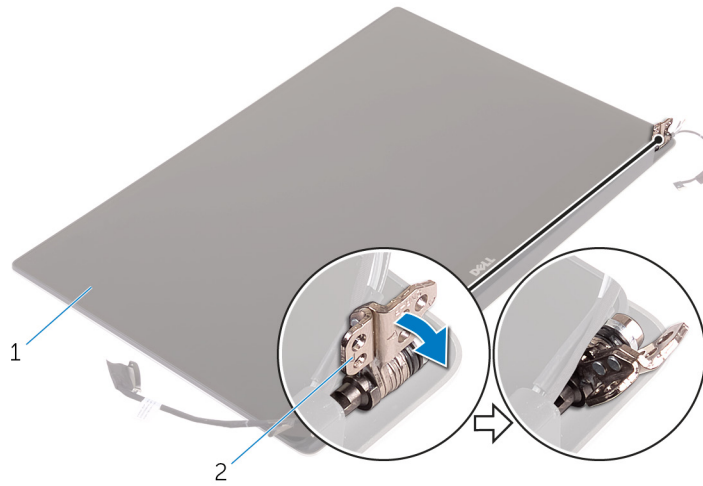

Figure 33. Turning the display hinge

- 1 display assembly
 - 2 display hinges (2)
- 2 Slide and lift the antenna cover off the antenna module.

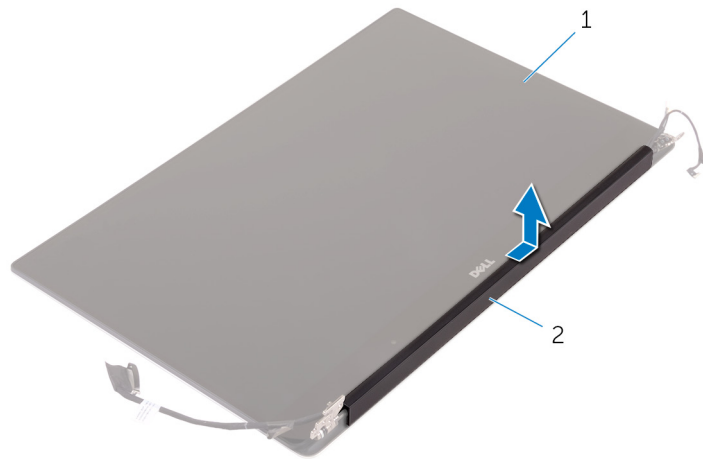

Figure 34. Removing the antenna cover

- 1 display assembly
- 2 antenna cover

Identifier	GUID-CDC36DAD-8593-48BA-A3B
Status	Released

Replacing the antenna cover

⚠ WARNING: Before working inside your computer, read the safety information that shipped with your computer and follow the steps in [Before working inside your computer](#). After working inside your computer, follow the instructions in [After working inside your computer](#). For more safety best practices, see the Regulatory Compliance home page at www.dell.com/regulatory_compliance.

Identifier	GUID-7ACABB91-5AEC-4E93-9AA6-74128A6B65CF
Status	Released

Procedure

- 1 Align the antenna cover on the antenna module with the flat surface of the cover facing away from the display assembly.
- 2 Replace the antenna cover and slide it to snap into place.
- 3 Turn the display hinges to the normal position.

Identifier	GUID-6A25475D-B8FF-473F-BDD0-52E3BAD02710
Status	Released

Post-requisites

- 1 Replace the [display assembly](#).
- 2 Replace the [wireless card](#).
- 3 Replace the [battery \(half-length\)](#) or the [battery \(full-length\)](#).
- 4 Replace the [base cover](#).

Identifier	GUID-A84F666A-38B4-4C77-A8DE
Status	Released

Removing the antenna module

⚠ WARNING: Before working inside your computer, read the safety information that shipped with your computer and follow the steps in [Before working inside your computer](#). After working inside your computer, follow the instructions in [After working inside your computer](#). For more safety best practices, see the Regulatory Compliance home page at www.dell.com/regulatory_compliance.

Identifier	GUID-892244E2-6E72-43F7-B7E4-E161D5995363
Status	Released

Prerequisites

① NOTE: These instructions are applicable only for laptops with a non-touchscreen display.

- 1 Remove the [base cover](#).
- 2 Remove the [battery \(half-length\)](#) or the [battery \(full-length\)](#).
- 3 Remove the [wireless card](#).
- 4 Remove the [display assembly](#).
- 5 Remove the [antenna cover](#).

Identifier	GUID-941A9399-CB90-4058-A802-7987DC7ECD57
Status	Released

Procedure

- 1 Peel the tape to access the antenna cables.
- 2 Remove the four screws (M2x4) that secure the antenna module to the display assembly.
- 3 Lift the antenna module off the display assembly.

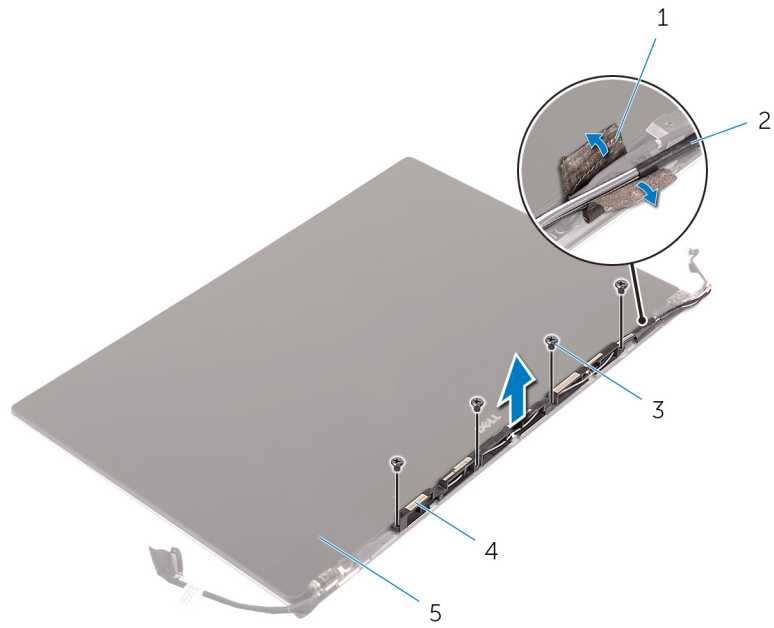

Figure 35. Removing the antenna module

- | | | | |
|---|------------------|---|----------------|
| 1 | tape | 2 | antenna cable |
| 3 | screws (4) | 4 | antenna module |
| 5 | display assembly | | |

Identifier	GUID-29CD5413-5042-412F-825D-1
Status	Released

Replacing the antenna module

⚠ WARNING: Before working inside your computer, read the safety information that shipped with your computer and follow the steps in [Before working inside your computer](#). After working inside your computer, follow the instructions in [After working inside your computer](#). For more safety best practices, see the Regulatory Compliance home page at www.dell.com/regulatory_compliance.

Identifier	GUID-56FF35CE-C58B-4DD9-B304-DEF3C5645827
Status	Released

Procedure

- 1 Align the screw holes on the antenna module with the screw holes on the display assembly.
- 2 Replace the four screws (M2x4) that secure the antenna module to the display assembly.
- 3 Adhere the tape that secures the antenna cable.

Identifier	GUID-0F926196-E7CA-4FE1-8FCC-80AA3AE6AD93
Status	Released

Post-requisites

- 1 Replace the [antenna cover](#).
- 2 Replace the [display assembly](#).
- 3 Replace the [wireless card](#).
- 4 Replace the [battery \(half-length\)](#) or the [battery \(full-length\)](#).
- 5 Replace the [base cover](#).

Identifier	GUID-740BADE7-E98C-41E6-A2C7
Status	Released

Removing the palm-rest assembly

⚠ WARNING: Before working inside your computer, read the safety information that shipped with your computer and follow the steps in [Before working inside your computer](#). After working inside your computer, follow the instructions in [After working inside your computer](#). For more safety best practices, see the Regulatory Compliance home page at www.dell.com/regulatory_compliance.

Identifier	GUID-476C3863-8DEB-42A4-B59B-589BBE094817
Status	Released

Prerequisites

① **NOTE:** Remove the SD card before removing the palm-rest assembly to avoid damage to the SD card.

- 1 Remove the [base cover](#).
- 2 Remove the [battery \(half-length\)](#) or the [battery \(full-length\)](#).
- 3 Remove the [memory modules](#).
- 4 Follow the procedure from step 1 to step 4 in "[Removing the hard drive](#)".
- 5 Remove the [solid-state drive \(half-length\)](#) or the [solid-state drive \(full-length\)](#).
- 6 Remove the [speakers](#).
- 7 Remove the [wireless card](#).
- 8 Remove the [fans](#).
- 9 Remove the [heat sink](#).
- 10 Remove the [system-board assembly](#).
- 11 Remove the [keyboard](#).
- 12 Remove the [fingerprint reader daughter-board \(optional\)](#).
- 13 Remove the [display assembly](#).
- 14 Remove the [power-adaptor port](#).

Identifier	GUID-66890565-CDD9-4FE0-9191-510485D7F3AC
Status	Released

Procedure

After performing the steps in the prerequisites we are left with the palm-rest assembly.

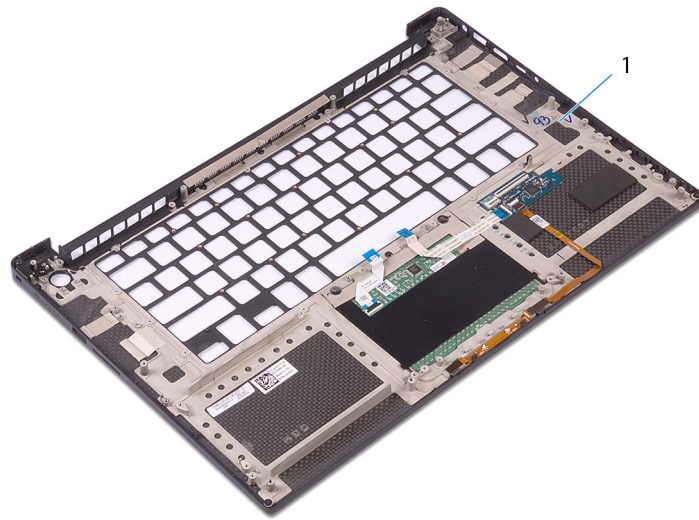

Figure 36. Removing the palm-rest assembly

- 1 palm-rest assembly

Identifier	GUID-C338CD8A-D6B9-47AE-9629
Status	Released

Replacing the palm-rest assembly

⚠ WARNING: Before working inside your computer, read the safety information that shipped with your computer and follow the steps in [Before working inside your computer](#). After working inside your computer, follow the instructions in [After working inside your computer](#). For more safety best practices, see the Regulatory Compliance home page at www.dell.com/regulatory_compliance.

Identifier	GUID-EBACC18B-687C-46E5-8818-DE3A7576F360
Status	Released

Procedure

Place the palm-rest assembly on a clean and flat surface.

Identifier	GUID-00D61B20-7643-4C01-B4CE-87DADED94772
Status	Released

Post-requisites

- 1 Replace the [power-adaptor port](#).
- 2 Replace the [display assembly](#).
- 3 Replace the [fingerprint reader daughter-board](#).
- 4 Replace the [keyboard](#).
- 5 Replace the [system-board assembly](#).
- 6 Replace the [heat sink](#).
- 7 Replace the [fans](#).
- 8 Replace the [wireless card](#).
- 9 Replace the [speakers](#).
- 10 Replace the [solid-state drive \(half-length\)](#) or the [solid-state drive \(full-length\)](#).
- 11 Follow the procedure from step 3 to step 6 in "Replacing the hard drive".
- 12 Replace the [memory modules](#).
- 13 Replace the [battery \(half-length\)](#) or the [battery \(full-length\)](#).
- 14 Replace the [base cover](#).

Identifier	GUID-F4DA2E4B-976A-4AE4-A9ED
Status	Released

Downloading drivers

Identifier	GUID-7C35A9FE-5B08-4401-8F52-3E2202A698A9
Status	Released

Downloading the audio driver

- 1 Turn on your computer.
- 2 Go to www.dell.com/support.
- 3 Enter the Service Tag of your computer, and then click **Submit**.

NOTE: If you do not have the Service Tag, use the autodetect feature or manually browse for your computer model.

- 4 Click **Drivers & downloads**.
- 5 Click the **Detect Drivers** button.
- 6 Review and agree to the Terms and Conditions to use **SupportAssist**, then click **Continue**.
- 7 If necessary, your computer starts to download and install **SupportAssist**.

NOTE: Review on-screen instructions for browser-specific instructions.

- 8 Click **View Drivers for My System**.
- 9 Click **Download and Install** to download and install all driver updates detected for your computer.
- 10 Select a location to save the files.
- 11 If prompted, approve requests from **User Account Control** to make changes on the system.
- 12 The application installs all drivers and updates identified.

NOTE: Not all files can be installed automatically. Review the installation summary to identify if manual installation is necessary.

- 13 For manual download and installation, click **Category**.
- 14 Click **Audio** in the drop-down list.
- 15 Click **Download** to download the audio driver for your computer.
- 16 After the download is complete, navigate to the folder where you saved the audio driver file.
- 17 Double-click the audio driver file icon and follow the instructions on the screen to install the driver.

Table 3. Audio driver before and after installation

Before Installation	After Installation
<ul style="list-style-type: none"> Other devices <ul style="list-style-type: none"> Audio Device on High Definition Audio Bus 	<ul style="list-style-type: none"> Sound, video and game controllers <ul style="list-style-type: none"> Intel(R) Display Audio Realtek(R) Audio

Identifier	GUID-F073CA9E-5F83-4E6E-8A36-294422CD35CE
Status	Released

Downloading the graphics driver

- 1 Turn on your computer.
- 2 Go to www.dell.com/support.
- 3 Enter the Service Tag of your computer, and then click **Submit**.
 - ① **NOTE:** If you do not have the Service Tag, use the autodetect feature or manually browse for your computer model.
- 4 Click **Drivers & downloads**.
- 5 Click the **Detect Drivers** button.
- 6 Review and agree to the Terms and Conditions to use **SupportAssist**, then click **Continue**.
- 7 If necessary, your computer starts to download and install **SupportAssist**.
 - ① **NOTE:** Review on-screen instructions for browser-specific instructions.
- 8 Click **View Drivers for My System**.
- 9 Click **Download and Install** to download and install all driver updates detected for your computer.
- 10 Select a location to save the files.
- 11 If prompted, approve requests from **User Account Control** to make changes on the system.
- 12 The application installs all drivers and updates identified.
 - ① **NOTE:** Not all files can be installed automatically. Review the installation summary to identify if manual installation is necessary.
- 13 For manual download and installation, click **Category**.
- 14 Click **Video** in the drop-down list.
- 15 Click **Download** to download the graphics driver for your computer.
- 16 After the download is complete, navigate to the folder where you saved the graphics driver file.
- 17 Double-click the graphics driver file icon and follow the instructions on the screen to install the driver.

Table 4. Display adapters before and after installation

Before installation	After installation
<ul style="list-style-type: none"> Display adapters <ul style="list-style-type: none"> Microsoft Basic Display Adapter 	<ul style="list-style-type: none"> Display adapters <ul style="list-style-type: none"> Intel(R) UHD Graphics 630 NVIDIA GeForce GTX 1050 Ti with Max-Q Design

Identifier	GUID-E78C82DA-C8D3-4CC2-BE95-E7007AE313ED
Status	Released

Downloading the chipset driver

- 1 Turn on your computer.
- 2 Go to www.dell.com/support.
- 3 Enter the Service Tag of your computer, and then click **Submit**.
 - ① **NOTE:** If you do not have the Service Tag, use the autodetect feature or manually browse for your computer model.
- 4 Click **Drivers & downloads**.
- 5 Click the **Detect Drivers** button.
- 6 Review and agree to the Terms and Conditions to use **SupportAssist**, then click **Continue**.

7 If necessary, your computer starts to download and install **SupportAssist**.

NOTE: Review on-screen instructions for browser-specific instructions.

8 Click **View Drivers for My System**.

9 Click **Download and Install** to download and install all driver updates detected for your computer.

10 Select a location to save the files.

11 If prompted, approve requests from **User Account Control** to make changes on the system.

12 The application installs all drivers and updates identified.

NOTE: Not all files can be installed automatically. Review the installation summary to identify if manual installation is necessary.

13 For manual download and installation, click **Category**.

14 Click **Chipset** in the drop-down list.

15 Click **Download** to download the appropriate chipset driver for your computer.

16 After the download is complete, navigate to the folder where you saved the chipset driver file.

17 Double-click the chipset driver file icon and follow the instructions on the screen to install the driver.

Identifier	GUID-1F8C8336-570F-4377-BD72-1325C2020ADD
Status	Released

Downloading the USB driver

1 Turn on your computer.

2 Go to www.dell.com/support.

3 Enter the Service Tag of your computer, and then click **Submit**.

NOTE: If you do not have the Service Tag, use the autodetect feature or manually browse for your computer model.

4 Click **Drivers & downloads**.

5 Click the **Detect Drivers** button.

6 Review and agree to the Terms and Conditions to use **SupportAssist**, then click **Continue**.

7 If necessary, your computer starts to download and install **SupportAssist**.

NOTE: Review on-screen instructions for browser-specific instructions.

8 Click **View Drivers for My System**.

9 Click **Download and Install** to download and install all driver updates detected for your computer.

10 Select a location to save the files.

11 If prompted, approve requests from **User Account Control** to make changes on the system.

12 The application installs all drivers and updates identified.

NOTE: Not all files can be installed automatically. Review the installation summary to identify if manual installation is necessary.

13 For manual download and installation, click **Category**.

14 Click **Chipset** in the drop-down list.

15 Click **Download** to download the USB driver for your computer.

16 After the download is complete, navigate to the folder where you saved USB driver file.

17 Double-click the USB driver file icon and follow the instructions on screen to install the driver.

Table 5. USB driver before and after installation

Before Installation

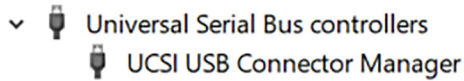

After Installation



Identifier	GUID-E78C82DA-C8D3-4CC2-BE95-E7007AE313ED
Status	Released

Downloading the chipset driver

- 1 Turn on your computer.
- 2 Go to www.dell.com/support.
- 3 Enter the Service Tag of your computer, and then click **Submit**.

NOTE: If you do not have the Service Tag, use the autodetect feature or manually browse for your computer model.

- 4 Click **Drivers & downloads**.
- 5 Click the **Detect Drivers** button.
- 6 Review and agree to the Terms and Conditions to use **SupportAssist**, then click **Continue**.
- 7 If necessary, your computer starts to download and install **SupportAssist**.

NOTE: Review on-screen instructions for browser-specific instructions.

- 8 Click **View Drivers for My System**.
- 9 Click **Download and Install** to download and install all driver updates detected for your computer.
- 10 Select a location to save the files.
- 11 If prompted, approve requests from **User Account Control** to make changes on the system.
- 12 The application installs all drivers and updates identified.

NOTE: Not all files can be installed automatically. Review the installation summary to identify if manual installation is necessary.

- 13 For manual download and installation, click **Category**.
- 14 Click **Chipset** in the drop-down list.
- 15 Click **Download** to download the appropriate chipset driver for your computer.
- 16 After the download is complete, navigate to the folder where you saved the chipset driver file.
- 17 Double-click the chipset driver file icon and follow the instructions on the screen to install the driver.

Identifier	GUID-688B94B4-0A83-4CD9-A94F-E01205615005
Status	Released

Downloading the network driver

- 1 Turn on your computer.
- 2 Go to www.dell.com/support.
- 3 Enter the Service Tag of your computer, and then click **Submit**.

NOTE: If you do not have the Service Tag, use the autodetect feature or manually browse for your computer model.

- 4 Click **Drivers & downloads**.
- 5 Click the **Detect Drivers** button.

- 6 Review and agree to the Terms and Conditions to use **SupportAssist**, then click **Continue**.
 - 7 If necessary, your computer starts to download and install **SupportAssist**.
- ① **NOTE: Review on-screen instructions for browser-specific instructions.**
- 8 Click **View Drivers for My System**.
 - 9 Click **Download and Install** to download and install all driver updates detected for your computer.
 - 10 Select a location to save the files.
 - 11 If prompted, approve requests from **User Account Control** to make changes on the system.
 - 12 The application installs all drivers and updates identified.

① **NOTE: Not all files can be installed automatically. Review the installation summary to identify if manual installation is necessary.**

- 13 For manual download and installation, click **Category**.
- 14 Click **Network** in the drop-down list.
- 15 Click **Download** to download the network driver for your computer.
- 16 Save the file, and after the download is complete, navigate to the folder where you saved the network driver file.
- 17 Double-click the network driver file icon and follow the instructions on screen.

Table 6. Network driver before and after installation

Before installation	After installation
<ul style="list-style-type: none"> Network adapters <ul style="list-style-type: none"> Bluetooth Device (RFCOMM Protocol TDI) WAN Miniport (IKEv2) WAN Miniport (IP) WAN Miniport (IPv6) WAN Miniport (L2TP) WAN Miniport (Network Monitor) WAN Miniport (PPPOE) WAN Miniport (PPTP) WAN Miniport (SSTP) 	<ul style="list-style-type: none"> Network adapters <ul style="list-style-type: none"> Bluetooth Device (Personal Area Network) Bluetooth Device (RFCOMM Protocol TDI) Killer Wireless-n/a/ac 1535 Wireless Network Adapter WAN Miniport (IKEv2) WAN Miniport (IP) WAN Miniport (IPv6) WAN Miniport (L2TP) WAN Miniport (Network Monitor) WAN Miniport (PPPOE) WAN Miniport (PPTP) WAN Miniport (SSTP)

Identifier	GUID-782CEAE4-2E49-4531-9D2B-EFB4D1462EDE
Status	Released

Downloading the fingerprint reader driver

- 1 Turn on your computer.
 - 2 Go to www.dell.com/support.
 - 3 Enter the Service Tag of your computer, and then click **Submit**.
- ① **NOTE: If you do not have the Service Tag, use the auto detect feature or manually browse for your computer model.**
- 4 Click **Drivers & downloads**.
 - 5 Click the **Detect Drivers** button.
 - 6 Review and agree to the Terms and Conditions to use **SupportAssist**, then click **Continue**.
 - 7 If necessary, your computer starts to download and install **SupportAssist**.

① **NOTE: Review on-screen instructions for browser-specific instructions.**

- 8 Click **View Drivers for My System**.
- 9 Click **Download and Install** to download and install all driver updates detected for your computer.
- 10 Select a location to save the files.
- 11 If prompted, approve requests from **User Account Control** to make changes on the system.

12 The application installs all drivers and updates identified.

 **NOTE: Not all files can be installed automatically. Review the installation summary to identify if manual installation is necessary.**

13 For manual download and installation, click **Category**.

14 Click **Security** in the drop-down list.

15 Click **Download** to download the fingerprint reader driver for your computer.

16 After the download is complete, navigate to the folder where you saved the fingerprint reader driver file.

17 Double-click the fingerprint reader driver file icon and follow the instructions on the screen to install the driver.

Identifier	GUID-4D6759B1-4017-4F54-87E6-9
Status	Released

System setup

NOTE: Depending on the computer and its installed devices, the items listed in this section may or may not be displayed.

Identifier	GUID-39EA0288-9174-49B6-ABA2-37C542A11FC5
Status	Released

Boot Sequence

Boot Sequence allows you to bypass the System Setup–defined boot device order and boot directly to a specific device (for example: optical drive or hard drive). During the Power-on Self Test (POST), when the Dell logo appears, you can:

- Access System Setup by pressing F2 key
- Bring up the one-time boot menu by pressing F12 key

The one-time boot menu displays the devices that you can boot from including the diagnostic option. The boot menu options are:

- Removable Drive (if available)
- STXXXX Drive

NOTE: XXX denotes the SATA drive number.

- Optical Drive (if available)
- SATA Hard Drive (if available)
- Diagnostics

NOTE: Choosing Diagnostics, will display the ePSA diagnostics screen.

The boot sequence screen also displays the option to access the System Setup screen.

Identifier	GUID-7A7EB30A-4A48-422B-AE30-B8DC236A1790
Status	Released

Navigation keys

NOTE: For most of the System Setup options, changes that you make are recorded but do not take effect until you restart the system.

Keys	Navigation
Up arrow	Moves to the previous field.
Down arrow	Moves to the next field.
Enter	Selects a value in the selected field (if applicable) or follow the link in the field.
Spacebar	Expands or collapses a drop-down list, if applicable.

Keys	Navigation
Tab	Moves to the next focus area.
Esc	Moves to the previous page until you view the main screen. Pressing Esc in the main screen displays a message that prompts you to save any unsaved changes and restarts the system.

Identifier	GUID-E8E05C46-BC9D-4CF1-AC84-34B87FDCCFB7
Status	Released

System setup

CAUTION: Unless you are an expert computer user, do not change the settings in the BIOS Setup program. Certain changes can make your computer work incorrectly.

NOTE: Before you change BIOS Setup program, it is recommended that you write down the BIOS Setup program screen information for future reference.

Use the BIOS Setup program for the following purposes:

- Get information about the hardware installed in your computer, such as the amount of RAM and the size of the hard drive.
- Change the system configuration information.
- Set or change a user-selectable option, such as the user password, type of hard drive installed, and enabling or disabling base devices.

Identifier	GUID-1432A924-49E9-4080-961D-2AFBDAF42039
Status	Released

Entering BIOS setup program

- 1 Turn on (or restart) your computer.
- 2 During POST, when the DELL logo is displayed, watch for the F2 prompt to appear, and then press F2 immediately.

NOTE: The F2 prompt indicates that the keyboard is initialized. This prompt can appear very quickly, so you must watch for it, and then press F2. If you press F2 before the F2 prompt, this keystroke is lost. If you wait too long and the operating system logo appears, continue to wait until you see the desktop. Then, turn off your computer and try again.

Identifier	GUID-257010C2-3FCB-42B6-8728-825C8CE89A44
Status	Released

Enabling or disabling the USB in BIOS setup program

- 1 Turn on or restart your computer.
- 2 Press F2 when the Dell logo is displayed on the screen to enter the BIOS setup program.
The BIOS setup program is displayed.
- 3 On the left pane, select **Settings > System Configuration > USB Configuration**.
The USB configuration is displayed on the right pane.
- 4 Select or clear the **Enable External USB Port** check box to enable or disable it, respectively.
- 5 Save the settings and exit.

Identifier	GUID-21205808-E913-4BFF-B101-8F9DD1203FB4
Status	Released

Identifying the hard drive in BIOS setup program

- 1 Turn on or restart your computer.
- 2 Press F2 when the Dell logo is displayed on the screen to enter the BIOS setup program.
A list of hard drives are displayed under the **System Information** in the **General** group.

Identifier	GUID-548F27AB-69B0-4DE4-AA18-82B34E2C3FDC
Status	Released

Checking the system memory in BIOS setup program

- 1 Turn on or restart your computer.
- 2 Press F2 when the Dell logo is displayed to enter the BIOS setup program.
- 3 On the left pane, select **Settings > General > System Information**.
The memory information is displayed on the right pane.

Identifier	GUID-4FF6787D-08D0-47C4-8A0D-BA3F0C405F50
Status	Released

System setup options

NOTE: Depending on this computer and its installed devices, the items listed in this section may or may not be displayed.

Table 7. System setup options—System information menu

General-System Information

System Information

BIOS Version	Displays the BIOS version number.
Service Tag	Displays the Service Tag of the computer.
Asset Tag	Displays the Asset Tag of the computer.
Ownership Tag	Displays the ownership tag of the computer.
Manufacture Date	Displays the manufacture date of the computer.
Ownership Date	Displays the ownership date of the computer.
Express Service Code	Displays the express service code of the computer.

Memory Information

Memory Installed	Displays the total computer memory installed.
Memory Available	Displays the total computer memory available.
Memory Speed	Displays the memory speed.
Memory Channel Mode	Displays single or dual channel mode.
Memory Technology	Displays the technology used for the memory.

General-System Information

DIMM A Size Displays the DIMM A memory size.

DIMM B Size Displays the DIMM B memory size.

Processor Information

Processor Type Displays the processor type.

Core Count Displays the number of cores on the processor.

Processor ID Displays the processor identification code.

Current Clock Speed Displays the current processor clock speed.

Minimum Clock Speed Displays the minimum processor clock speed.

Maximum Clock Speed Displays the maximum processor clock speed.

Processor L2 Cache Displays the processor L2 Cache size.

Processor L3 Cache Displays the processor L3 Cache size.

HT Capable Displays whether the processor is hyper-threading (HT) capable.

64-Bit Technology Displays whether 64-bit technology is used.

Device Information

M.2 SATA Displays the M.2 SATA device information.

Primary Hard Drive Displays the primary hard drive.

M.2 PCIe SSD-0 Displays the M.2 PCIe solid state drive.

Passthrough MAC Address Displays the pass-through MAC address.

Video Controller Displays the video controller.

Video BIOS Version Displays the video BIOS version.

Video Memory Displays the video memory.

Panel Type Displays the display panel type.

Native Resolution Displays the display resolution.

Audio Controller Displays the audio controller.

Wi-Fi Device Displays the wireless device.

Bluetooth Device Displays the Bluetooth device.

Battery Information Displays the battery health information.

Boot Sequence

Boot Sequence Displays the boot sequence.

Boot List Option Displays the available boot options.

Advanced Boot Options

Enable Legacy Option ROMs Enable or disable legacy option ROMs.

Enable Attempt Legacy Boot Enable or disable attempts to legacy boot when the computer fails to boot in UEFI boot mode.

Enable UEFI Network Stack Enable or disable the UEFI network stack.

UEFI Boot Path Security Enables or disables prompts for the administrator password when booting from UEFI.

Date/Time

Displays the current date in MM/DD/YY format and current time in HH:MM:SS AM/PM format.

Table 8. System setup options—System configuration menu**System Configuration**

SATA Operation	Configure operating mode of the integrated SATA hard drive controller.
Drives	Enable or disable various drives on board.
SMART Reporting	Enable or disable SMART reporting during system startup.
USB Configuration	
Enable Boot Support	Enable or disable booting from USB mass storage devices such as external hard drive, optical drive, and USB drive.
Enable External USB Port	Enable or disable the external USB port.
Enable Thunderbolt ports	Enable or disable the thunderbolt ports.
Enable Thunderbolt Boot Support	Enable or disable booting from USB mass storage devices connected to the thunderbolt ports.
Always Allow Dell Docks	Enable or disable the computer to always allow the Dell docking stations.
Enable Thunderbolt (and PCIe behind TBT) Pre-boot	Enable or disable the Thunderbolt (and PCIe behind Thunderbolt) preboot.
USB PowerShare	Enable or disable charging external devices through the USB PowerShare port.
Audio	Enable or disable the integrated audio controller.
Keyboard illumination	Configure the operating mode of the keyboard illumination feature.
Touchscreen	Enables or disables the touch screen.
Miscellaneous Devices	Enable or disable various onboard devices.
Enable Camera	Enable or disable the camera.
Enable Secure Digital (SD) Card	Enable or disable the SD card.
Enable Secure Digital (SD) Card Boot	Enable or disable booting from the SD card.
Secure Digital (SD) Card Read-Only Mode	Enable or disable the SD card read-only mode.

Table 9. System setup options—Video menu**Video**

LCD Brightness	Set the panel brightness independently for battery and AC power.
----------------	--

Table 10. System setup options—Security menu**Security**

Admin Password	Set, change, or delete the administrator password.
System Password	Set, change, or delete the system password.
Strong Password	Enable or disable strong passwords.
Password Configuration	Control the minimum and maximum number of characters allowed for administrator and system passwords.
Password Bypass	Bypass system (boot) password and internal hard disk password prompts during a system restart.
Password Change	Enable or disable changes to the system and hard disk passwords when an administrator password is set.
Non-Admin Setup Changes	Determines whether changes to the setup option are permitted when an administrator password is set.

Security

UEFI Capsule Firmware Updates	Enable or disable BIOS updates through UEFI capsule update packages.
TPM 1.2 Security	Enable or disable Trusted Platform Module (TPM) visibility to the operating system.
Computrace(R)	Enable or disable the BIOS module interface of the optional Computrace service.
CPU XD Support	Enable or disable the execute disable mode of the processor.
OROM Keyboard Access	Enable or disable access to Option ROM (OROM) configuration screens during boot.
Admin Setup Lockout	Enable to prevent users from entering the BIOS setup when an administrator password is set.
Master Password Lockout	Enable or disable master password support.

Table 11. System setup options—Secure boot menu

Secure Boot

Secure Boot Enable	Enable or disable the secure boot feature.
--------------------	--

Expert Key Management

Expert Key Management	Enable or disable expert key management.
Custom Mode Key Management	Select custom values for expert key management.

Table 12. System setup options—Intel Software Guard Extensions menu

Intel Software Guard Extensions

Intel SGX Enable	Enable or disable Intel Software Guard Extensions (SGX).
Enclave Memory Size	Set the Intel SGX enclave reserve memory size.

Performance

Multi Core Support	Enable multiple cores. Default: Enabled.
Intel SpeedStep	Enable or disable the Intel SpeedStep technology. Default: Enabled.

NOTE: If enabled, the processor clock speed and core voltage are adjusted dynamically based on the processor load.

C-States Control	Enable or disable additional processor sleep states. Default: Enabled.
Intel TurboBoost	Enable or disable Intel TurboBoost mode in the processor. Default: Enabled.
HyperThread control	Enable or disable hyper-threading in the processor. Default: Enabled.

Power Management

AC Behavior	Enables the system to power-on automatically, when an AC power adaptor is connected.
Auto on Time	Enable to set the computer to turn on automatically every day or on a pre-selected date and time. This option can be configured only if the Auto On Time is set to everyday, weekdays, or selected days. Default: Disabled.

Intel Software Guard Extensions

USB Wake Support	Enable the USB devices to wake the computer from standby mode.
Wake on LAN	Enable the LAN signal to wake the computer from standby mode.
	i NOTE: This feature only works when the computer is connected to an AC power adaptor.
Block Sleep	Enable or disable the sleep state.
Peak Shift	Configure the AC power usage.
Advanced Battery Charge Configuration	Enable from the beginning of the day to a specified work period.
Primary Battery Charge Configuration	Set the primary battery charge setting with a pre-selected custom charge start and stop. Default: Adaptive.

POST Behavior

Adapter Warnings	Enable or disable adapter warnings. Default: Enabled.
Keypad (Embedded)	Enable or disable the keypad that is embedded in the internal keyboard.
Num lock Enable	Enable or disable the numeric lock—numlock. Default: Enabled.
Fn Key Emulation	Enable or disable the function (fn) key emulation.
Fn Lock Options	Enable or disable the function (fn) lock mode.
Fast-boot	Enable to set the speed of the boot process. Default: Thorough.
Extend BIOS POST Time	Configure the additional preboot delay.
Full Screen logo	Enable or disable the full screen logo.
Warnings and Errors	Configure the boot process behavior when warnings or errors are detected.

Table 13. System setup options—Manageability

Manageability

MEBx Hotkey	Enable or disable the Intel Management Engine BIOS Extension (Intel MEBX) hot key when the system boots.
-------------	--

Table 14. System setup options—Virtualization support menu

Virtualization Support

Virtualization	Specify whether a Virtual Machine Monitor can utilize the additional hardware capabilities provided by Intel Virtualization Technology.
VT for Direct I/O	Specify whether a Virtual Machine Monitor can utilize the additional hardware capabilities provided by Intel Virtualization Technology for Direct I/O.

Table 15. System setup options—Wireless menu

Wireless

Wireless Switch	Determine which wireless devices can be controlled by the wireless switch.
Wireless Device Enable	Enable or disable internal wireless devices.

Table 16. System setup options—Maintenance menu

Maintenance

Service Tag	Display the system's Service Tag.
Asset Tag	Create a system asset tag.
BIOS Downgrade	Control flashing of the system firmware to previous revisions.
Data Wipe	Enable to securely erase data from all internal storage devices.
BIOS Recovery	Enable to recover corrupted BIOS using a recovery file on the primary hard drive or from an external USB storage device.

Table 17. System setup options—System Logs menu

System Logs

BIOS Events	Display BIOS-related events in system logs.
Thermal Events	Display thermal-related events in system logs.
Power Events	Display power-related events in system logs.

Table 18. System setup options—SupportAssist System Resolution

SupportAssist System Resolution

Auto OS Recovery Threshold	Control the automatic boot flow for the SupportAssist System Resolution console and for the Dell OS Recovery tool.
SupportAssist OS Recovery	Enable or disable the boot flow for the SupportAssist OS Recovery tool in the event of certain system errors.

Identifier	GUID-859887F0-B1B4-4530-855E-1
Status	Released

System and setup password

Table 19. System and setup password

Password type	Description
System password	Password that you must enter to log on to your system.
Setup password	Password that you must enter to access and make changes to the BIOS settings of your computer.

You can create a system password and a setup password to secure your computer.

⚠ CAUTION: The password features provide a basic level of security for the data on your computer.

⚠ CAUTION: Anyone can access the data stored on your computer if it is not locked and left unattended.

ℹ NOTE: System and setup password feature is disabled.

Identifier	GUID-D91DBF33-F0AB-477E-A22D-D6CD2D066BBE
Status	Released

Assigning a system setup password

You can assign a new **System or Admin Password** only when the status is in **Not Set**.

To enter the system setup, press F2 immediately after a power-on or re-boot.

- In the **System BIOS** or **System Setup** screen, select **Security** and press Enter.
The **Security** screen is displayed.
- Select **System/Admin Password** and create a password in the **Enter the new password** field.
Use the following guidelines to assign the system password:
 - A password can have up to 32 characters.
 - The password can contain the numbers 0 through 9.
 - Only lower case letters are valid, upper case letters are not allowed.
 - Only the following special characters are allowed: space, ("), (+), (,), (-), (.), (/), (:), ([), (\), (]), (`).
- Type the system password that you entered earlier in the **Confirm new password** field and click **OK**.
- Press Esc and a message prompts you to save the changes.
- Press Y to save the changes.
The computer reboots.

Identifier GUID-3D32F643-EE78-4538-9D89-34BDFB68E9F1

Status Released

Deleting or changing an existing system setup password

Ensure that the **Password Status** is Unlocked (in the System Setup) before attempting to delete or change the existing System and/or Setup password. You cannot delete or change an existing System or Setup password, if the **Password Status** is Locked. To enter the System Setup, press F2 immediately after a power-on or reboot.

- 1 In the **System BIOS** or **System Setup** screen, select **System Security** and press Enter.
The **System Security** screen is displayed.
- 2 In the **System Security** screen, verify that **Password Status** is **Unlocked**.
- 3 Select **System Password**, alter or delete the existing system password and press Enter or Tab.
- 4 Select **Setup Password**, alter or delete the existing setup password and press Enter or Tab.

NOTE: If you change the System and/or Setup password, re-enter the new password when prompted. If you delete the System and/or Setup password, confirm the deletion when prompted.

- 5 Press Esc and a message prompts you to save the changes.
- 6 Press Y to save the changes and exit from System Setup.
The computer reboot.

Identifier GUID-6A32A2DF-B793-4D55-8497-047059D92FE7

Status Released

Clearing BIOS (System Setup) and System passwords

Contact Dell technical support to clear the forgotten passwords. For more information, see www.dell.com/contactdell.

Identifier GUID-647C1E15-AF1F-4815-95E2-06A934E73944

Status Released

Clearing CMOS settings

- 1 Remove the [base cover](#).
- 2 Remove the [battery \(half-length\)](#) or the [battery \(full-length\)](#).
- 3 Remove the [coin-cell battery](#).
- 4 Wait for one minute.
- 5 Replace the [coin-cell battery](#).
- 6 Replace the [battery \(half-length\)](#) or the [battery \(full-length\)](#).
- 7 Replace the [base cover](#).

Identifier GUID-2B6B8AE6-67E2-4932-B29D-7D9D4203EABA

Status Released

Real Time Clock (RTC) battery reset

Press and hold the power button for 25 seconds to force Real Time Clock (RTC) battery reset.

Identifier	GUID-80364CC4-EA5A-4C96-B7D4-C49ED486E109
------------	---

Status	Released
--------	----------

Flashing BIOS (USB key)

- 1 Follow the procedure from step 1 to step 7 in "[Flashing the BIOS](#)" to download the latest BIOS setup program file.
- 2 Create a bootable USB drive. For more information see the knowledge base article [SLN143196](#) at www.dell.com/support.
- 3 Copy the BIOS setup program file to the bootable USB drive.
- 4 Connect the bootable USB drive to the computer that needs the BIOS update.
- 5 Restart the computer and press **F12** when the Dell logo is displayed on the screen.
- 6 Boot to the USB drive from the **One Time Boot Menu**.
- 7 Type the BIOS setup program filename and press **Enter**.
- 8 The **BIOS Update Utility** appears. Follow the instructions on the screen to complete the BIOS update.

Identifier	GUID-F93F7E34-BE30-464B-886E-
Status	Released

Troubleshooting

Identifier	GUID-F5899359-C2E1-41C0-9663-4C79969506EB
Status	Released

Flashing the BIOS

You may need to flash (update) the BIOS when an update is available or when you replace the system board. Follow these steps to flash the BIOS:

- 1 Turn on your computer.
- 2 Go to www.dell.com/support.
- 3 Click **Product support**, enter the Service Tag of your computer, and then click **Submit**.

NOTE: If you do not have the Service Tag, use the auto-detect feature or manually browse for your computer model.

- 4 Click **Drivers & downloads > Find it myself**.
- 5 Select the operating system installed on your computer.
- 6 Scroll down the page and expand **BIOS**.
- 7 Click **Download** to download the latest version of the BIOS for your computer.
- 8 After the download is complete, navigate to the folder where you saved the BIOS update file.
- 9 Double-click the BIOS update file icon and follow the instructions on the screen.

Identifier	GUID-3E5E47A3-671E-4E01-8949-53F6F26DA1D2
Status	Released

Reinstall Windows using a USB recovery drive

CAUTION: This process formats the hard drive and removes all data on your computer. Ensure that you back up data on your computer before beginning this task.

NOTE: Before reinstalling Windows, ensure your computer has more than 2 GB of memory and more than 32 GB of storage space.

NOTE: This process may take up to an hour to complete and your computer will restart during the recovery process.

- 1 Connect the USB recovery drive to your computer.
- 2 Restart your computer.
- 3 Press F12 after the Dell logo is displayed on the screen to access the boot menu. A **Preparing one-time boot menu** message appears.
- 4 After the boot menu loads, select the USB recovery device under **UEFI BOOT**. The system reboots and a screen to **Choose the keyboard layout** is displayed.
- 5 Choose your keyboard layout.
- 6 In the **Choose an option** screen, click **Troubleshoot**.

- 7 Click **Recover from a drive**.
- 8 Choose one of the following options:
 - **Just remove my files** to do a quick format.
 - **Fully clean the drive** to do a complete format.
- 9 Click **Recover** to start the recovery process.

Identifier	GUID-A6CA69D0-4BE1-40C4-84FE-983F5567B35A
Status	Released

Fixing a no-boot issue caused by USB-boot support

Sometimes the computer does not boot to the operating system when USB devices are connected to the computer during startup. This behavior occurs because the computer is looking for bootable files in connected USB devices.

Either disconnect USB devices before booting or follow these steps to fix the no-boot issue.

- 1 Turn on or restart your computer.
- 2 Press F2 when the Dell logo is displayed on the screen to enter the BIOS setup program.

NOTE: The F2 prompt indicates that the keyboard is initialized. This prompt can appear very quickly, so you must watch for it, and then press F2. If you press F2 before the F2 prompt, this keystroke is lost. If you wait too long and the operating system logo appears, continue to wait until you see the desktop. Then, turn off your computer and try again.

The BIOS setup program is displayed.

- 3 On the left pane, select **Settings > System Configuration > USB Configuration**.
The USB configuration is displayed on the right pane.
- 4 Clear the **Enable Boot Support** check box to disable it.
- 5 Save the settings and exit.

Identifier	GUID-EE9A5D95-88BE-4EE7-983E-D97C680BDECD
Status	Released

Enhanced Pre-Boot System Assessment (ePSA) diagnostics

The ePSA diagnostics (also known as system diagnostics) performs a complete check of your hardware. The ePSA is embedded with the BIOS and is launched by the BIOS internally. The embedded system diagnostics provides a set of options for particular devices or device groups allowing you to:

- Run tests automatically or in an interactive mode
- Repeat tests
- Display or save test results
- Run thorough tests to introduce additional test options to provide extra information about the failed device(s)
- View status messages that inform you if tests are completed successfully
- View error messages that inform you of problems encountered during testing

NOTE: Some tests for specific devices require user interaction. Always ensure that you are present at the computer terminal when the diagnostic tests are performed.

For more information, see [Dell EPSA Diagnostic 3.0](#).

Identifier	GUID-5FC0D943-B848-4BDC-9A26-78A5E88FDA45
Status	Released

Running the ePSA Diagnostics

Invoke diagnostics boot by either of the methods that are suggested below:

- 1 Power on the computer.
- 2 As the computer boots, press the F12 key when the Dell logo is displayed.
- 3 In the boot menu screen, use Up/Down arrow key to select the **Diagnostics** option and then press **Enter**.

NOTE: The Enhanced Pre-boot System Assessment window displays, listing all devices detected in the computer. The diagnostics starts running the tests on all the detected devices.

- 4 Press the arrow in the lower-right corner to go to the page listing.
The detected items are listed and tested.
- 5 To run a diagnostic test on a specific device, press Esc and click **Yes** to stop the diagnostic test.
- 6 Select the device from the left pane and click **Run Tests**.
- 7 If there are any issues, error codes are displayed.
Note the error code and contact Dell.
or
- 8 Shut down the computer.
- 9 Press and hold the Fn key, while pressing the power button, and then release both.
- 10 Repeat steps 3–7 above.

Identifier	GUID-80DC43D6-1463-45B2-A696-31AA152DE5AE
Status	Released

Diagnostics

Power and battery-status light

Indicates the power and battery-charge status.

Solid white – Power adapter is connected and the battery has more than 5 percent charge.

Amber – Computer is running on battery and the battery has less than 5 percent charge.

Off

- Power adapter is connected and the battery is fully charged.
- Computer is running on battery and the battery has more than 5 percent charge.
- Computer is in sleep state, hibernation, or turned off.

The power and battery-status light blinks amber along with beep codes indicating failures.

For example, the power and battery-status light blinks amber two times followed by a pause, and then blinks white three times followed by a pause. This 2,3 pattern continues until the computer is turned off indicating no memory or RAM is detected.

The following table shows different light patterns and what they indicate.

Table 20. Diagnostics

Light Pattern	Problem description
2,1	CPU failure
2,2	System board: BIOS and ROM failure
2,3	No memory or RAM detected
2,4	Memory or RAM failure
2,5	Invalid memory installed
2,6	System board or chipset error
2,7	LCD failure
3,1	CMOS battery failure
3,2	PCI/video card failure
3,3	Recovery image not found
3,4	Recovery image found but invalid

The computer may emit a series of beeps during start-up if the errors or problems cannot be displayed. The repetitive beep codes help the user troubleshoot problems with the computer.

Camera status light: Indicates whether the camera is in use.

- Solid white – Camera is in use.
- Off – Camera is not in use.

Caps Lock status light: Indicates whether Caps Lock is enabled or disabled.

- Solid white – Caps Lock enabled.
- Off – Caps Lock disabled.

Identifier	GUID-BB99B5E4-3C94-4EAB-92E1-EC33EC6388AA
Status	Released

Flea power release

Flea power is the residual static electricity that remains on the computer even after it has been powered off and the battery has been removed. The following procedure provides the instructions on how to conduct flea power release:

- 1 Turn off your computer.
- 2 Remove the [base cover](#).
- 3 Press and hold the power button for 15 seconds to drain the flea power.
- 4 Replace the [base cover](#).
- 5 Turn on your computer.

Identifier	GUID-7D2143EA-2C62-498E-97AF-DCEF3DA56624
Status	Released

Wi-Fi power cycle

If your computer is unable to access the Internet due to Wi-Fi connectivity issues a Wi-Fi power cycle procedure may be performed. The following procedure provides the instructions on how to conduct a Wi-Fi power cycle:

 **NOTE:** Some ISPs (Internet Service Providers) provide a modem/router combo device.

- 1 Turn off your computer.
- 2 Turn off the modem.
- 3 Turn off the wireless router.
- 4 Wait for 30 seconds.
- 5 Turn on the wireless router.
- 6 Turn on the modem.
- 7 Turn on your computer.



Identifier	GUID-AF18382F-D265-43C2-85DA-
Status	Released

Getting help and contacting Dell

Self-help resources

You can get information and help on Dell products and services using these self-help resources:

Table 21. Self-help resources

Self-help resources	Resource location
Information about Dell products and services	www.dell.com
My Dell	
Tips	
Contact Support	In Windows search, type <code>Contact Support</code> , and press Enter.
Online help for operating system	www.dell.com/support/windows www.dell.com/support/linux
Troubleshooting information, user manuals, setup instructions, product specifications, technical help blogs, drivers, software updates, and so on.	www.dell.com/support
Dell knowledge base articles for a variety of computer concerns.	<ol style="list-style-type: none"> 1 Go to www.dell.com/support. 2 Type the subject or keyword in the Search box. 3 Click Search to retrieve the related articles.
Learn and know the following information about your product:	See <i>Me and My Dell</i> at www.dell.com/support/manuals .
<ul style="list-style-type: none"> • Product specifications • Operating system • Setting up and using your product • Data backup • Troubleshooting and diagnostics • Factory and system restore • BIOS information 	<p>To locate the <i>Me and My Dell</i> relevant to your product, identify your product through one of the following:</p> <ul style="list-style-type: none"> • Select Detect Product. • Locate your product through the drop-down menu under View Products. • Enter the Service Tag number or Product ID in the search bar.

Contacting Dell

To contact Dell for sales, technical support, or customer service issues, see www.dell.com/contactdell.

- ① **NOTE:** Availability varies by country and product, and some services may not be available in your country.
- ① **NOTE:** If you do not have an active internet connection, you can find contact information on your purchase invoice, packing slip, bill, or Dell product catalog.