

Dell EMC PowerEdge R540

Installation and Service Manual

Identifier	GUID-5B8DE7B7-879F-45A4-88E0-732155904029
Status	Released

Notes, cautions, and warnings

 **NOTE:** A NOTE indicates important information that helps you make better use of your product.

 **CAUTION:** A CAUTION indicates either potential damage to hardware or loss of data and tells you how to avoid the problem.

 **WARNING:** A WARNING indicates a potential for property damage, personal injury, or death.

© 2018-2019 Dell Inc. or its subsidiaries. All rights reserved. Dell, EMC, and other trademarks are trademarks of Dell Inc. or its subsidiaries. Other trademarks may be trademarks of their respective owners.

1 Dell EMC PowerEdge R540 overview.....	8
Supported configurations for the PowerEdge R540 system.....	8
Front view of the system.....	9
Left control panel view.....	11
Right control panel view.....	14
Drive indicator codes.....	15
Back panel features.....	16
NIC indicator codes.....	20
Power supply unit indicator codes.....	21
LCD panel.....	23
Viewing Home screen.....	23
Setup menu.....	24
View menu.....	24
Locating the Service Tag of your system.....	24
System information label.....	26
2 Documentation resources.....	29
3 Technical specifications.....	31
System dimensions.....	31
Chassis weight.....	32
Processor specifications.....	32
Supported operating systems.....	32
Cooling fans specifications.....	32
PSU specifications.....	33
System battery.....	33
Expansion bus specifications.....	33
Memory specifications.....	33
Storage controller specifications.....	33
Drive specifications.....	34
Drives.....	34
Optical drives.....	34
Tape Drives.....	34
Ports and connectors specifications.....	34
USB ports.....	34
NIC ports.....	35
VGA ports.....	35
Serial connector.....	35
Internal Dual SD Module.....	35
Video specifications.....	35
Environmental specifications.....	36
Standard operating temperature.....	37
Expanded operating temperature.....	37
Particulate and gaseous contamination specifications	38

4 Initial system setup and configuration.....	40
Setting up your system.....	40
iDRAC configuration.....	40
Options to set up iDRAC IP address.....	40
Log in to iDRAC.....	41
Options to install the operating system.....	41
Methods to download firmware and drivers.....	42
Downloading drivers and firmware.....	42
5 Pre-operating system management applications.....	43
Options to manage the pre-operating system applications.....	43
System Setup.....	43
Viewing System Setup.....	43
System Setup details.....	44
System BIOS.....	44
iDRAC Settings utility.....	66
Device Settings.....	66
Dell Lifecycle Controller.....	66
Embedded system management.....	66
Boot Manager.....	66
Viewing Boot Manager.....	66
Boot Manager main menu.....	67
One-shot UEFI boot menu.....	67
System Utilities.....	67
PXE boot.....	67
6 Installing and removing system components	68
Safety instructions.....	68
Before working inside your system.....	68
After working inside your system.....	68
Recommended tools.....	69
Optional front bezel.....	69
Removing the front bezel.....	69
Installing the front bezel.....	70
System cover.....	71
Removing the system cover.....	71
Installing the system cover.....	72
Backplane cover.....	73
Removing the backplane cover.....	73
Installing the backplane cover.....	74
Inside the system.....	75
Air shroud.....	77
Removing the air shroud.....	77
Installing the air shroud.....	79
Cooling fans.....	80
Removing the cooling fan.....	80
Installing cooling fan.....	82
Internal PERC riser.....	83

Removing the internal PERC riser.....	83
Installing the internal PERC riser.....	85
Removing the PERC card from the internal PERC riser.....	86
Installing PERC card into the internal PERC riser.....	87
Intrusion switch.....	88
Removing the intrusion switch.....	88
Installing the intrusion switch.....	89
Drives.....	90
Removing a drive blank.....	90
Installing a drive blank.....	91
Removing a 2.5-inch drive from a 3.5-inch drive adapter.....	91
Installing a 2.5-inch drive into a 3.5-inch drive adapter.....	92
Removing a 3.5-inch drive adapter from a 3.5-inch drive carrier.....	93
Installing a 3.5-inch drive adapter into the 3.5-inch drive carrier.....	94
Removing a drive carrier.....	95
Installing a drive carrier.....	96
Removing the drive from the drive carrier.....	97
Installing a drive into the drive carrier.....	98
System memory.....	98
System memory guidelines.....	98
General memory module installation guidelines.....	99
Mode-specific guidelines.....	100
Removing a memory module.....	102
Installing a memory module.....	103
Processors and heat sinks.....	104
Removing a processor and heat sink module.....	104
Removing the non-fabric processor from the processor and heat sink module.....	105
Installing the non-fabric processor into a processor and heat sink module.....	106
Installing a processor and heat sink module.....	109
Expansion cards and expansion card risers.....	110
Expansion card installation guidelines.....	110
Removing expansion card from the expansion card riser.....	113
Installing expansion card into the expansion card riser.....	117
Removing expansion card from the system board.....	120
Installing expansion card on the system board.....	122
Removing an expansion card riser.....	123
Installing an expansion card riser.....	126
M.2 SSD module.....	128
Removing the M.2 SSD module.....	128
Installing the M.2 SSD module.....	129
Optional MicroSD or vFlash card.....	130
Removing the MicroSD card.....	130
Installing the MicroSD card.....	131
Optional IDSDM or vFlash module.....	132
Removing the optional IDSDM or vFlash card.....	132
Installing optional IDSDM or vFlash card.....	133
LOM riser card.....	134
Removing the LOM riser card.....	134
Installing the LOM riser card.....	135
Drive backplane.....	136

Backplane details.....	136
Removing the backplane	138
Installing the backplane.....	139
Removing the 3.5-inch rear drive backplane.....	139
Installing the 3.5-inch rear drive backplane.....	140
Cable routing.....	142
Rear drive cage.....	145
Removing the rear drive cage.....	145
Installing the rear drive cage.....	146
System battery.....	147
Optional internal USB memory key.....	147
Replacing the optional internal USB memory key.....	147
Optical drive (optional).....	148
Removing the optical drive.....	148
Installing the optical drive.....	149
Power supply units.....	150
Hot spare feature.....	150
Removing a power supply unit blank.....	151
Installing a power supply unit blank.....	151
Removing a power supply unit.....	152
Installing a power supply unit.....	153
Removing a non-redundant cabled AC power supply unit.....	154
Installing a non-redundant cabled AC power supply unit.....	154
Removing a DC power supply unit.....	155
Installing DC power supply unit.....	156
Wiring instructions for a DC power supply unit.....	156
Power interposer board.....	158
Removing power interposer board.....	158
Installing power interposer board.....	159
Control panel.....	160
Removing the left control panel.....	160
Installing the left control panel.....	161
Removing the right control panel.....	162
Installing the right control panel.....	163
System board.....	164
Removing the system board.....	164
Installing the system board.....	166
Restoring the system using Easy Restore.....	168
Manually update the Service Tag.....	168
Entering the system Service Tag by using System Setup.....	168
Trusted Platform Module.....	169
Upgrading the Trusted Platform Module.....	169
Initializing TPM for BitLocker users.....	170
Initializing the TPM 1.2 for TXT users.....	170
7 System diagnostics.....	171
Dell Embedded System Diagnostics.....	171
Running the Embedded System Diagnostics from Boot Manager.....	171
Running the Embedded System Diagnostics from the Dell Lifecycle Controller.....	172
System diagnostic controls.....	172

8 Jumpers and connectors	173
System board jumpers and connectors.....	174
System board jumper settings.....	175
Disabling forgotten password.....	176
9 Getting help.....	177
Contacting Dell EMC.....	177
Documentation feedback.....	178
Accessing system information by using QRL.....	178
Quick Resource Locator for R540.....	178
Receiving automated support with SupportAssist	178
Recycling or End-of-Life service information.....	179

Identifier	GUID-A75F5CE9-6D03-4B70-861B-1028858EF1FE
Status	Released

Dell EMC PowerEdge R540 overview

The Dell EMC PowerEdge R540 system is a 2U, dual socket rack system that supports up to:

- Two Intel Xeon Scalable Processors
- 16 DIMM slots
- Two AC and DC redundant power supply units (PSU) or single cabled PSU
- 14 drives or solid-state drives

NOTE: All instances of SAS, SATA hard drives and SSDs are referred to as drives in this document, unless specified otherwise.

Topics:

- [Supported configurations for the PowerEdge R540 system](#)
- [Front view of the system](#)
- [Back panel features](#)
- [LCD panel](#)
- [Locating the Service Tag of your system](#)
- [System information label](#)

Identifier	GUID-83DB8D87-3552-4626-9861-652598B1C67A
Status	Released

Supported configurations for the PowerEdge R540 system

The Dell EMC PowerEdge R540 system supports the following configurations:

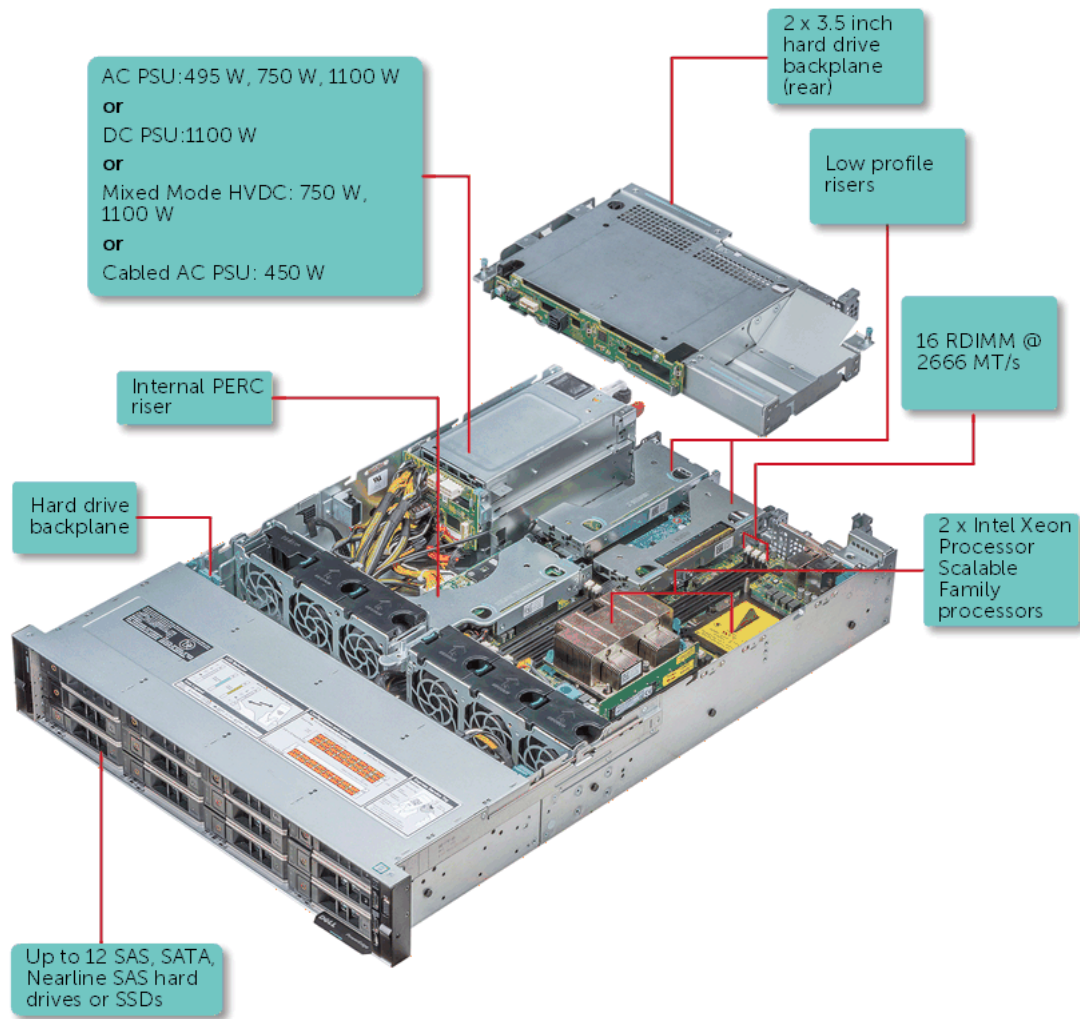

Figure 1. Supported configurations for a PowerEdge R540 system with rear drive

Identifier	GUID-146EE47B-790F-4D09-9411-2A6BCC20F658
Status	Released

Front view of the system

The front view displays the features available on the front of the system.



Figure 2. Front view of 12 x 3.5-inch drive system

Table 1. Features available on the front of the system

Item	Ports, panels, and slots	Icon	Description
1	Left control panel	N/A	<p>Contains the system health and system ID, status LED, and the iDRAC Quick Sync 2 (wireless) indicator.</p> <p>NOTE: The iDRAC Quick Sync 2 indicator is available only on certain configurations.</p> <ul style="list-style-type: none"> Status LED: Enables you to identify any failed hardware components. There are up to five status LEDs and an overall system health LED (Chassis health and system ID) bar. For more information, see the Status LED indicators section. Quick Sync 2 (wireless): Indicates a Quick Sync enabled system. The Quick Sync feature is optional. This feature enables management of the system by using mobile devices. This feature aggregates hardware or firmware inventory and various system level diagnostic and error information that can be used in troubleshooting the system. For more information, see the <i>Integrated Dell Remote Access Controller User's Guide</i> at www.dell.com/poweredgemanuals.
2	Drive slots	N/A	Enable you to install drives that are supported on your system. For more information about drives, see the Technical specifications section.
3	Right control panel	N/A	Contains the power button, USB ports, iDRAC Direct (Micro-AB USB), VGA port.
4	Information tag	N/A	The Information Tag is a slide-out label panel that contains system information such as Service Tag, NIC, MAC address, and so on. If you have opted for the secure default access to iDRAC, the Information tag also contains the iDRAC secure default password.

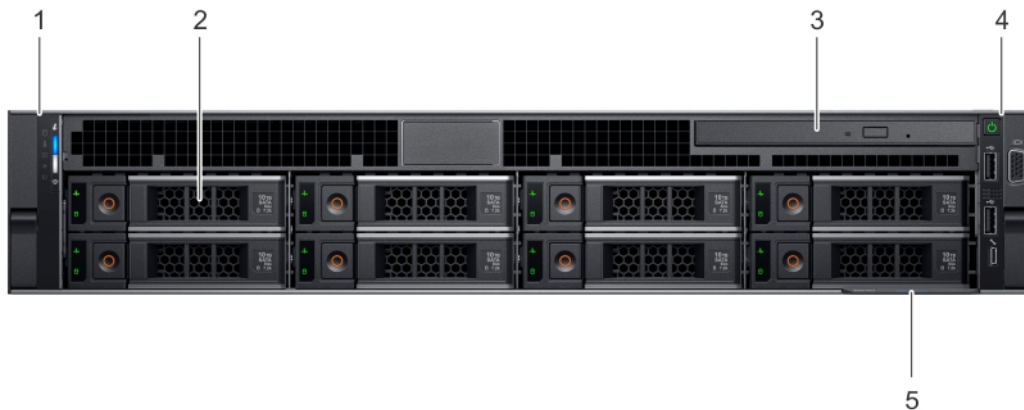

Figure 3. Front view of 8 x 3.5-inch drive system

Table 2. Features available on the front of the system

Item	Ports, panels, and slots	Icon	Description
1	Left control panel	N/A	<p>Contains the system health and system ID, status LED, and the iDRAC Quick Sync 2 (wireless) indicator.</p> <p>NOTE: The iDRAC Quick Sync 2 indicator is available only on certain configurations.</p> <ul style="list-style-type: none"> Status LED: Enables you to identify any failed hardware components. There are up to five status LEDs and an overall system health LED (Chassis health and system ID) bar. For more information, see the Status LED indicators section.

Item	Ports, panels, and slots	Icon	Description
			<ul style="list-style-type: none"> Quick Sync 2 (wireless): Indicates a Quick Sync enabled system. The Quick Sync feature is optional. This feature enables management of the system by using mobile devices. This feature aggregates hardware or firmware inventory and various system level diagnostic and error information that can be used in troubleshooting the system. For more information, see the <i>Integrated Dell Remote Access Controller User's Guide</i> at www.dell.com/idracmanuals.
2	Drive slots	N/A	Enable you to install drives that are supported on your system. For more information about drives, see the Technical specifications section.
3	Optical drive (optional)	N/A	One optional slim SATA DVD-ROM drive or DVD+/-RW drive.
4	Right control panel	N/A	Contains the power button, USB ports, iDRAC Direct (Micro-AB USB), VGA port.
5	Information tag	N/A	The Information Tag is a slide-out label panel that contains system information such as Service Tag, NIC, MAC address, and so on. If you have opted for the secure default access to iDRAC, the Information tag also contains the iDRAC secure default password.

Identifier	GUID-DCBB05E0-A504-4725-B97A-7F5EB4EA8497
Status	Released

Left control panel view

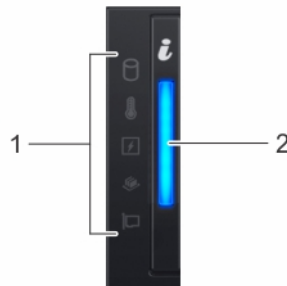

Figure 4. Left control panel without optional iDRAC Quick Sync 2.0 indicator

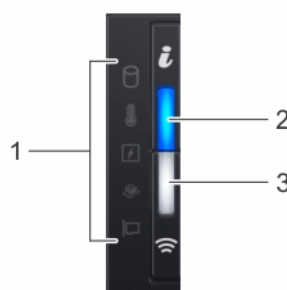



Figure 5. Left control panel with optional iDRAC Quick Sync 2.0 indicator

Table 3. Left control panel

Item	Indicator, button, or connector	Icon	Description
1	Status LED indicators	N/A	Indicate the status of the system. For more information, see the Status LED indicators section.







Item	Indicator, button, or connector	Icon	Description
2	System health and system ID indicator		Indicates the system health.
3	iDRAC Quick Sync 2 wireless indicator (optional)		Indicates if the iDRAC Quick Sync 2 wireless option is activated. The Quick Sync 2 feature allows management of the system using mobile devices. This feature aggregates hardware/firmware inventory and various system level diagnostic/error information that can be used in troubleshooting the system. You can access system inventory, Dell Lifecycle Controller logs or system logs, system health status, and also configure iDRAC, BIOS, and networking parameters. You can also launch the virtual Keyboard, Video, and Mouse (KVM) viewer and virtual Kernel based Virtual Machine (KVM), on a supported mobile device. For more information, see the <i>Integrated Dell Remote Access Controller User's Guide</i> at www.dell.com/poweredge/manuals .

Identifier GUID-C18AD1B2-EC7A-4427-B677-4A5BD5F7789D
 Status Released

Status LED indicators

 **NOTE:** The indicators display solid amber if any error occurs.

Table 4. Status LED indicators and descriptions

Icon	Description	Condition	Corrective action
	Drive indicator	The indicator turns solid amber if there is a drive error.	<ul style="list-style-type: none"> Check the System Event Log to determine if the drive has an error. Run the appropriate Online Diagnostics test. Restart the system and run embedded diagnostics (ePSA). If the drives are configured in a RAID array, restart the system, and enter the host adapter configuration utility program.
	Temperature indicator	The indicator turns solid amber if the system experiences a thermal error (for example, the ambient temperature is out of range or there is a fan failure).	<p>Ensure that none of the following conditions exist:</p> <ul style="list-style-type: none"> A cooling fan has been removed or has failed. Ambient temperature is too high. External airflow is obstructed. <p>If the problem persists, see Getting help.</p>
	Electrical indicator	The indicator turns solid amber if the system experiences an electrical error (for example, voltage out of range, or a failed power supply unit (PSU) or voltage regulator).	<p>Check the System Event Log or system messages for the specific issue. If it is due to a problem with the PSU, check the LED on the PSU. Reseat the PSU.</p> <p>If the problem persists, see Getting help.</p>
	Memory indicator	The indicator turns solid amber if a memory error occurs.	<p>Check the System Event Log or system messages for the location of the failed memory. Reseat the memory module.</p> <p>If the problem persists, see Getting help.</p>
	PCIe indicator	The indicator turns solid amber if a PCIe card experiences an error.	<p>Restart the system. Update any required drivers for the PCIe card. Reinstall the card.</p> <p>If the problem persists, see Getting help.</p> <p> NOTE: For more information about the supported PCIe cards, see Expansion card installation guidelines.</p>

Identifier	GUID-F65F6E4C-5251-4075-BCDC-16F64277F563
Status	Released

System health and system ID indicator codes

The system health and system ID indicator is located on the left control panel of your system.



Figure 6. System health and system ID indicators

Table 5. System health and system ID indicator codes

System health and system ID indicator code	Condition
Solid blue	Indicates that the system is turned on, system is healthy, and system ID mode is not active. Press the system health and system ID button to switch to system ID mode.
Blinking blue	Indicates that the system ID mode is active. Press the system health and system ID button to switch to system health mode.
Solid amber	Indicates that the system is in fail-safe mode. If the problem persists, see the Getting help section.
Blinking amber	Indicates that the system is experiencing a fault. Check the System Event Log or the LCD panel, if available on the bezel, for specific error messages. For more information about error messages, see the <i>Event and Error Message Reference Guide for 14th Generation Dell EMC PowerEdge Servers</i> at www.dell.com/qrl .

Identifier	GUID-A0B65110-65A1-4130-B4F1-525B35CDF91E
Status	Released

iDRAC Quick Sync 2 indicator codes

iDRAC Quick Sync 2 module (optional) is located on the front panel of your system.

Table 6. iDRAC Quick Sync 2 indicators and descriptions

iDRAC Quick Sync 2 indicator code	Condition	Corrective action
Off (default state)	Indicates that the iDRAC Quick Sync 2 feature is turned off. Press the iDRAC Quick Sync 2 button to turn on the iDRAC Quick Sync 2 feature.	If the LED fails to turn on, reseal the cable and check. If the problem persists, see the Getting help section.
Solid white	Indicates that iDRAC Quick Sync 2 is ready to communicate. Press the iDRAC Quick Sync 2 button to turn off.	If the LED fails to turn off, restart the system. If the problem persists, see the Getting help section.
Blinks white rapidly	Indicates data transfer activity.	If the indicator continues to blink indefinitely, see the Getting help section.
Blinks white slowly	Indicates that firmware update is in progress.	If the indicator continues to blink indefinitely, see the Getting help section.
Blinks white five times rapidly and then turns off	Indicates that the iDRAC Quick Sync 2 feature is disabled.	Check if iDRAC Quick Sync 2 feature is configured to be disabled by iDRAC. If the problem persists, see the Getting help section. For more information, see <i>Integrated Dell Remote Access Controller User's Guide</i> at www.dell.com/poweredgemanuals or <i>Dell OpenManage Server Administrator User's Guide</i> at

iDRAC Quick Sync 2 indicator code	Condition	Corrective action
Solid amber	Indicates that the system is in fail-safe mode.	www.dell.com/openmanagemanuals > OpenManage Server Administrator. Restart the system. If the problem persists, see the Getting help section.
Blinking amber	Indicates that the iDRAC Quick Sync 2 hardware is not responding properly.	Restart the system. If the problem persists, see the Getting help section.

Identifier	GUID-A9DDCC7F-C123-491D-BD73-83DC7E9E9891
Status	Released

Right control panel view

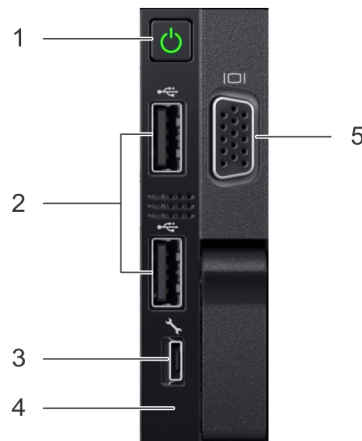





Figure 7. Right control panel

Table 7. Right control panel

Item	Indicator, button, or connector	Icon	Description
1	Power button		Indicates if the system is powered on or off. Press the power button to manually power on or off the system. NOTE: Press the power button to gracefully shut down an ACPI-compliant operating system.
2	USB port		The USB ports are 4-pin, 2.0-compliant. These ports enable you to connect USB devices to the system.
3	iDRAC Direct (Micro-AB USB)		The iDRAC Direct (Micro-AB USB) port enables you to access the iDRAC Direct (Micro-AB) features. For more information, see <i>Integrated Dell Remote Access Controller User's Guide</i> at www.dell.com/poweredgemanuals .
4	iDRAC Direct (Micro-AB USB) LED	N/A	The iDRAC Direct (Micro-AB USB) LED indicator lights up to indicate that the iDRAC Direct port is connected. For more information, see the <i>Integrated Dell Remote Access Controller User's Guide</i> at www.dell.com/poweredgemanuals .

Item	Indicator, button, or connector	Icon	Description
5	VGA port		Enables you to connect a display device to the system. For more information, see the Technical specifications section.

Identifier GUID-4B4F68B2-B1EE-4D77-A93E-5C1C10E05AF4
 Status Released

iDRAC Direct LED indicator codes

The iDRAC Direct LED indicator lights up to indicate that the port is connected and is being used as a part of the iDRAC subsystem.

You can configure iDRAC Direct by using a USB to micro USB (type AB) cable, which you can connect to your laptop or tablet. The following table describes iDRAC Direct activity when the iDRAC Direct port is active:

Table 8. iDRAC Direct LED indicator codes

iDRAC Direct LED indicator code	Condition
Solid green for two seconds	Indicates that the laptop or tablet is connected.
Flashing green (on for two seconds and off for two seconds)	Indicates that the laptop or tablet connected is recognized.
Turns off	Indicates that the laptop or tablet is unplugged.

Identifier GUID-6B7C0F3A-ECEF-469D-9680-A0DDB0B64609
 Status Released

Drive indicator codes

Each drive carrier has an activity LED indicator and a status LED indicator. The indicators provide information about the current status of the drive. The activity LED indicator indicates whether the drive is currently in use or not. The status LED indicator indicates the power condition of the drive.



Figure 8. Drive indicators

1. Drive activity LED indicator
2. Drive status LED indicator
3. Drive capacity label

NOTE: If the drive is in the Advanced Host Controller Interface (AHCI) mode, the status LED indicator does not turn on.

Table 9. Drive indicator codes

Drive status indicator code	Condition
Flashes green twice per second	Identifying drive or preparing for removal.

Drive status indicator code	Condition
Off	Drive ready for removal. NOTE: The drive status indicator remains off until all drives are initialized after the system is turned on. Drives are not ready for removal during this time.
Flashes green, amber, and then turns off	Predicted drive failure.
Flashes amber four times per second	Drive failed.
Flashes green slowly	Drive rebuilding.
Solid green	Drive online.
Flashes green for three seconds, amber for three seconds, and then turns off after six seconds	Rebuild stopped.

Identifier GUID-3AB789D9-CCAB-4498-8173-25CB711EB040
 Status Released

Back panel features

This back view displays the features available on the back of the system.

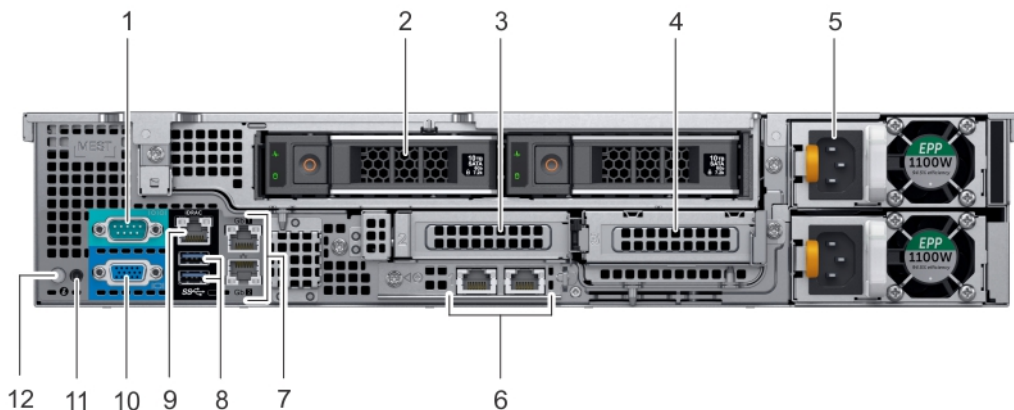







Figure 9. Back panel features of 12 x 3.5-inch + 2 x 3.5-inch (rear) drive system

Table 10. Back panel features of R540

Item	Features	Icon	Description
1	Serial port	IOIO1	Use the serial port to connect a serial device to the system. For more information about the supported serial port, see the Technical specifications section.
2	Drive (2)	N/A	Two optional rear drives supported for 12 x 3.5 -inch system.
3	Low profile riser right slot	N/A	Use the card slot to connect half-height PCIe expansion card on low profile riser.
4	Low profile riser left slot	N/A	Use the card slot to connect half-height PCIe expansion card on low profile riser.
5	Power supply unit (PSU) (2)	N/A	For information about supported PSUs, see the Technical specifications section.

Item	Features	Icon	Description
6	LOM riser port (2)		Use the Ethernet or SFP+ ports to connect Local Area Networks (LANs) to the system. For more information about the supported Ethernet or SFP+ ports, see the Technical specifications section.
7	Ethernet port (2)		Use the Ethernet ports to connect Local Area Networks (LANs) to the system. For more information about the supported Ethernet ports, see the Technical specifications section.
8	USB 3.0 port (2)		Use the USB 3.0 port to connect USB devices to the system. These ports are 4-pin, USB 3.0-compliant.
9	iDRAC9 dedicated network port		Use the iDRAC9 dedicated network port to securely access the embedded iDRAC on a separate management network, see the <i>Integrated Dell Remote Access Controller User's Guide</i> at www.dell.com/poweredgemanuals .
10	VGA port		Use the VGA port to connect a display to the system. For more information about the supported VGA port, see the Technical specifications section.
11	System status indicator cable port	N/A	Enables you to connect the status indicator cable and view system status when the CMA is installed.
12	System identification button		<p>Press the system ID button:</p> <ul style="list-style-type: none"> • To locate a particular system within a rack. • To turn the system ID on or off. <p>To reset iDRAC, press and hold the button for more than 15 s.</p> <p>NOTE:</p> <ul style="list-style-type: none"> • To reset iDRAC using system ID, ensure that the system ID button is enabled in the iDRAC setup. • If the system stops responding during POST, press and hold the system ID button (for more than five seconds) to enter the BIOS progress mode.

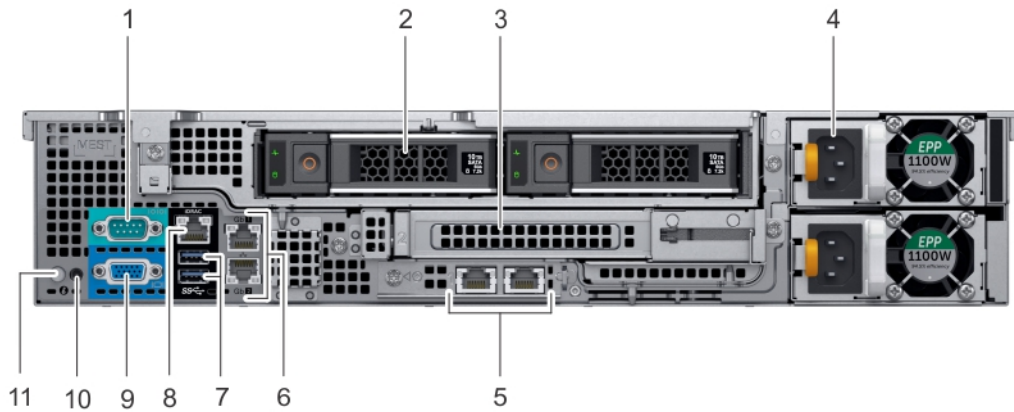







Figure 10. Back panel features of 12 x 3.5-inch + 2 x 3.5-inch (rear) drive system

Table 11. Back panel features of R540

Item	Features	Icon	Description
1	Serial port	IOIOI	Use the serial port to connect a serial device to the system. For more information about the supported serial port, see the Technical specifications section.
2	Drive (2)	N/A	Two optional rear drives supported for 12 x 3.5 inch system.
3	Full height riser slot	N/A	Use the card slots to connect full-height PCIe expansion cards on full height riser.
4	Power supply unit (PSU) (2)	N/A	For information about supported PSUs, see the Technical specifications section.
5	LOM riser port (2)		Use the Ethernet or SFP+ ports to connect Local Area Networks (LANs) to the system. For more information about the supported Ethernet or SFP+ ports, see the Technical specifications section.
6	Ethernet port (2)		Use the Ethernet ports to connect Local Area Networks (LANs) to the system. For more information about the supported Ethernet ports, see the Technical specifications section.
7	USB 3.0 port (2)		Use the USB 3.0 port to connect USB devices to the system. These ports are 4-pin, USB 3.0-compliant.
8	iDRAC9 dedicated network port		Use the iDRAC9 dedicated network port to securely access the embedded iDRAC on a separate management network, see the <i>Integrated Dell Remote Access Controller User's Guide</i> at www.dell.com/poweredge/manuals .

Item	Features	Icon	Description
9	VGA port		Use the VGA port to connect a display to the system. For more information about the supported VGA port, see the Technical specifications section.
10	System status indicator cable port	N/A	Enables you to connect the status indicator cable and view system status when the CMA is installed.
11	System identification button		<p>Press the system ID button:</p> <ul style="list-style-type: none"> To locate a particular system within a rack. To turn the system ID on or off. <p>To reset iDRAC, press and hold the button for more than 15 seconds.</p> <p>NOTE:</p> <ul style="list-style-type: none"> To reset iDRAC using system ID, ensure that the system ID button is enabled in the iDRAC setup. If the system stops responding during POST, press and hold the system ID button (for more than five seconds) to enter the BIOS progress mode.

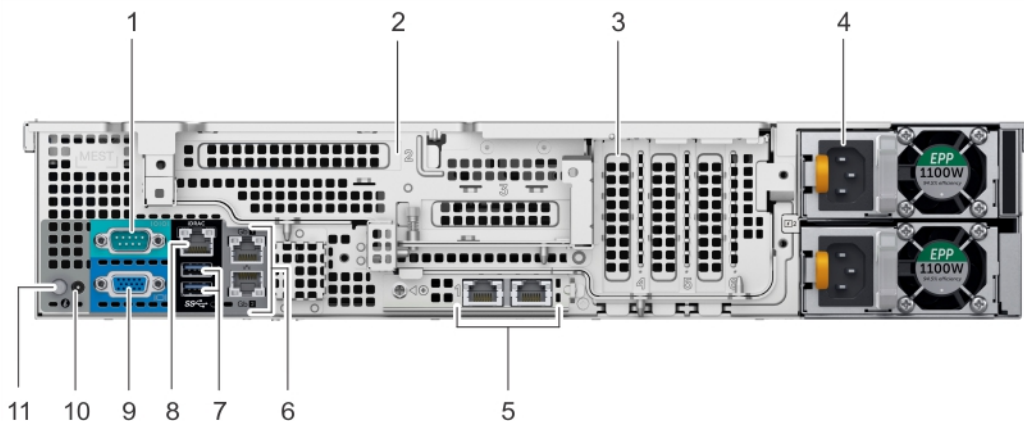









Figure 11. Back panel features of 12 x 3.5-inch drive system with butterfly riser

Table 12. Back panel features of R540

Item	Features	Icon	Description
1	Serial port		Use the serial port to connect a serial device to the system. For more information about the supported serial port, see the Technical specifications section.
2	Butterfly riser slot	N/A	Use the card slots to connect full-height PCIe expansion cards on butterfly riser.

Item	Features	Icon	Description
3	PCIe slot (3)	N/A	Use the card slots to connect up to three half-height PCIe expansion cards on the system board.
4	Power supply unit (PSU)	N/A	For information about supported PSUs, see the Technical specifications section.
5	LOM riser ports		Use the Ethernet or SFP+ ports to connect Local Area Networks (LANs) to the system. For more information about the supported Ethernet or SFP+ ports, see the Technical specifications section.
6	Ethernet ports (2)		Use the Ethernet ports to connect Local Area Networks (LANs) to the system. For more information about the supported Ethernet ports, see the Technical specifications section.
7	USB 3.0 port		Use the USB 3.0 port to connect USB devices to the system. These ports are 4-pin, USB 3.0-compliant.
8	iDRAC9 dedicated network port		Use the iDRAC9 dedicated network port to securely access the embedded iDRAC on a separate management network, see the <i>Integrated Dell Remote Access Controller User's Guide</i> at www.dell.com/poweredgemanuals .
9	VGA port		Use the VGA port to connect a display to the system. For more information about the supported VGA port, see the Technical specifications section.
10	Status indicator cable port	N/A	Enables you to connect the status indicator cable and view system status when the CMA is installed.
11	System identification button		<p>Press the system ID button:</p> <ul style="list-style-type: none"> To locate a particular system within a rack. To turn the system ID on or off. <p>To reset iDRAC, press and hold the button for more than 15 seconds.</p> <p>NOTE:</p> <ul style="list-style-type: none"> To reset iDRAC using system ID, ensure that the system ID button is enabled in the iDRAC setup. If the system stops responding during POST, press and hold the system ID button (for more than five seconds) to enter the BIOS progress mode.

Identifier	GUID-C1175869-CE62-40E0-840F-3120E9DD702D
Status	Released

NIC indicator codes

Each NIC on the back of the system has indicators that provide information about the activity and link status. The activity LED indicator indicates if data is flowing through the NIC, and the link LED indicator indicates the speed of the connected network.

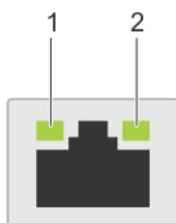

Figure 12. NIC indicator codes

1. link LED indicator

2. activity LED indicator

Table 13. NIC indicator codes

Status	Condition
Link and activity indicators are off	The NIC is not connected to the network.
Link indicator is green and activity indicator is blinking green	The NIC is connected to a valid network at its maximum port speed and data is being sent or received.
Link indicator is amber and activity indicator is blinking green	The NIC is connected to a valid network at less than its maximum port speed and data is being sent or received.
Link indicator is green and activity indicator is off	The NIC is connected to a valid network at its maximum port speed and data is not being sent or received.
Link indicator is amber and activity indicator is off	The NIC is connected to a valid network at less than its maximum port speed and data is not being sent or received.
Link indicator is blinking green and activity is off	NIC identify is enabled through the NIC configuration utility.

Identifier	GUID-3C0F52FF-FC00-46BD-B6FE-C64A303BCE9C
Status	Released

Power supply unit indicator codes

AC power supply units (PSUs) have an illuminated translucent handle that serves as an indicator.

The DC PSUs have an LED that serves as an indicator.

The indicator shows whether power is present or if a power fault has occurred.

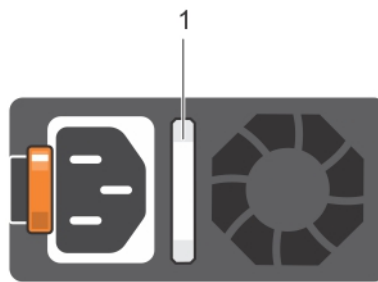

Figure 13. AC PSU status indicator

1. AC PSU status indicator/handle

Table 14. AC PSU status indicator codes

Power indicator codes	Condition
Green	A valid power source is connected to the PSU and the PSU is operational.
Blinking amber	Indicates a problem with the PSU.
Not illuminated	Power is not connected to the PSU.
Blinking green	When the firmware of the PSU is being updated, the PSU handle blinks green. ⚠ CAUTION: Do not disconnect the power cord or unplug the PSU when updating firmware. If firmware update is interrupted, the PSUs do not function.
Blinking green and turns off	When hot-plugging a PSU, the PSU handle blinks green five times at a rate of 4 Hz and turns off. This indicates a PSU mismatch with respect to efficiency, feature set, health status, or supported voltage. ⚠ CAUTION: If two PSUs are installed, both the PSUs must have the same type of label; for example, Extended Power Performance (EPP) label. Mixing PSUs from previous generations of PowerEdge servers is not supported, even if the PSUs have the same power rating. This results in a PSU mismatch condition or failure to turn the system on. ⚠ CAUTION: When correcting a PSU mismatch, replace only the PSU with the blinking indicator. Swapping the PSU to make a matched pair can result in an error condition and

Power indicator codes	Condition
	unexpected system shutdown. To change from a high output configuration to a low output configuration or vice versa, you must turn off the system.
△	CAUTION: AC PSUs support both 240 V and 120 V input voltages with the exception of Titanium PSUs, which support only 240 V. When two identical PSUs receive different input voltages, they can output different wattages, and trigger a mismatch.
△	CAUTION: If two PSUs are used, they must be of the same type and have the same maximum output power.
△	CAUTION: Combining AC and DC PSUs is not supported and triggers a mismatch.

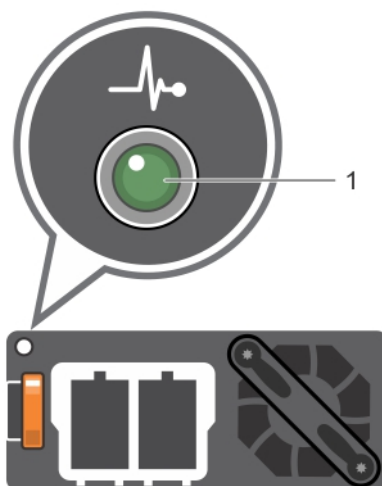

Figure 14. DC PSU status indicator

1. DC PSU status indicator

Table 15. DC PSU status indicator codes

Power indicator codes	Condition
Green	A valid power source is connected to the PSU and the PSU is operational.
Blinking amber	Indicates a problem with the PSU.
Not illuminated	Power is not connected to the PSU.
Blinking green	When hot-plugging a PSU, the PSU indicator blinks green. This indicates that there is a PSU mismatch with respect to efficiency, feature set, health status, or supported voltage. △ CAUTION: If two PSUs are installed, both the PSUs must have the same type of label; for example, Extended Power Performance (EPP) label. Mixing PSUs from previous generations of PowerEdge servers is not supported, even if the PSUs have the same power rating. This results in a PSU mismatch condition or failure to turn the system on. △ CAUTION: When correcting a PSU mismatch, replace only the PSU with the blinking indicator. Swapping the PSU to make a matched pair can result in an error condition and unexpected system shutdown. To change from a High Output configuration to a Low Output configuration or vice versa, you must turn off the system. △ CAUTION: If two PSUs are used, they must be of the same type and have the same maximum output power. △ CAUTION: Combining AC and DC PSUs is not supported and triggers a mismatch.

LCD panel

The LCD panel provides system information, status, and error messages to indicate if the system is functioning correctly or requires attention. The LCD panel can also be used to configure or view the system's iDRAC IP address. For information about the event and error messages generated by the system firmware and agents that monitor system components, see the Error Code Lookup page at qrl.dell.com.

The LCD panel is available only on the optional front bezel. The optional front bezel is hot pluggable.

The statuses and conditions of the LCD panel are outlined here:

- The LCD backlight is white during normal operating conditions.
- When the system needs attention, the LCD backlight turns amber, and displays an error code followed by descriptive text.
- **NOTE: If the system is connected to a power source and an error is detected, the LCD turns amber regardless of whether the system is turned on or off.**
- When the system turns off and there are no errors, LCD enters the standby mode after five minutes of inactivity. Press any button on the LCD to turn it on.
- If the LCD panel stops responding, remove the bezel and reinstall it.
- If the problem persists, see [Getting help](#).
- The LCD backlight remains off if LCD messaging is turned off using the iDRAC utility, the LCD panel, or other tools.



Figure 15. LCD panel features

Table 16. LCD panel features



Item	Button or display	Description
1	Left	Moves the cursor back in one-step increments.
2	Select	Selects the menu item highlighted by the cursor.
3	Right	Moves the cursor forward in one-step increments. During message scrolling: <ul style="list-style-type: none"> • Press and hold the right button to increase scrolling speed. • Release the button to stop. NOTE: The display stops scrolling when the button is released. After 45 seconds of inactivity, the display starts scrolling.
4	LCD display	Displays system information, status, and error messages or iDRAC IP address.

Viewing Home screen

The **Home** screen displays user-configurable information about the system. This screen is displayed during normal system operation when there are no status messages or errors. When the system turns off and there are no errors, LCD enters the standby mode after five minutes of inactivity. Press any button on the LCD to turn it on.

Steps

1. To view the **Home** screen, press one of the three navigation buttons (Select, Left, or Right).
2. To navigate to the **Home** screen from another menu, complete the following steps:

- Press and hold the navigation button until the up arrow  is displayed.
- Navigate to the **Home** icon  using the up arrow .
- Select the **Home** icon.
- On the **Home** screen, press the **Select** button to enter the main menu.

Identifier	GUID-8B570F82-1398-46A4-963B-2BBA5B82A584
Status	Released

Setup menu

 **NOTE:** When you select an option in the Setup menu, you must confirm the option before proceeding to the next action.

Option	Description
iDRAC	Select DHCP or Static IP to configure the network mode. If Static IP is selected, the available fields are IP , Subnet (Sub) , and Gateway (Gtw) . Select Setup DNS to enable DNS and to view domain addresses. Two separate DNS entries are available.
Set error	Select SEL to view LCD error messages in a format that matches the IPMI description in the SEL. This enables you to match an LCD message with an SEL entry. Select Simple to view LCD error messages in a simplified user-friendly description. For information about the event and error messages generated by the system firmware and agents that monitor system components, see the Error Code Lookup page at qrl.dell.com
Set home	Select the default information to be displayed on the Home screen. See View menu section for the options and option items that can be set as the default on the Home screen.

Identifier	GUID-80A8E2AB-645D-4120-AE0B-E6C673A395FE
Status	Released

View menu

 **NOTE:** When you select an option in the View menu, you must confirm the option before proceeding to the next action.

Option	Description
iDRAC IP	Displays the IPv4 or IPv6 addresses for iDRAC9. Addresses include DNS (Primary and Secondary) , Gateway , IP , and Subnet (IPv6 does not have Subnet).
MAC	Displays the MAC addresses for iDRAC , iSCSI , or Network devices.
Name	Displays the name of the Host , Model , or User String for the system.
Number	Displays the Asset tag or the Service tag for the system.
Power	Displays the power output of the system in BTU/hr or Watts. The display format can be configured in the Set home submenu of the Setup menu.
Temperature	Displays the temperature of the system in Celsius or Fahrenheit. The display format can be configured in the Set home submenu of the Setup menu.

Identifier	GUID-19DF125D-0151-4A8B-AA6F-46298D8F4472
Status	Released

Locating the Service Tag of your system

You can identify your system using the unique Express Service Code and Service Tag. Pull out the information tag in front of the system to view the Express Service Code and Service Tag. Alternatively, the information may be on a sticker on the chassis of the system. The mini Enterprise Service Tag (EST) is found on the back of the system. Dell uses this information to route support calls to the appropriate personnel.

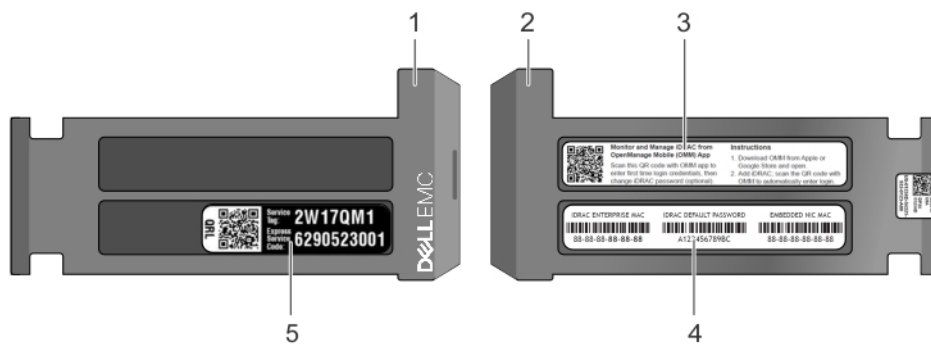

Figure 16. Locating Service Tag of your system

1. information tag (front view)
2. information tag (back view)
3. OpenManage Mobile (OMM) label
4. iDRAC MAC address and iDRAC secure password label
5. Service Tag

System information label

Service Information

System Touchpoints

- Hot swap touchpoints: Components with terracotta touchpoints can be serviced while the system is running.
- Cold swap touchpoints: Components with blue touchpoints require a full system shutdown before servicing.

Electrical Overview

System Board Connections

<ul style="list-style-type: none"> 1 System Power 2 SATA_C 3 SATA_B 4 PIB Signal 1 5 PIB Signal 2 6 SATA_A 7 IDSDM + vFlash 8 Front USB 9 ODD/Rear Backplane Power 10 VGA 11 Internal USB 3.0 12 PCIe Card Slot 6 (PCH) 13 Jumpers 14 PCIe Card Slot 5 (CPU 1) 	<ul style="list-style-type: none"> 15 TPM 16 PCIe Card Slot 4 (CPU 2) 17 LOM Riser Card 18 Backplane Signal 2 (Rear) 19 PCIe Internal Storage (CPU 1) 20 Riser 1 (CPU 1) 21 DIMMs For CPU 2 Channels 0, 1, 2 22 CPU 2 23 DIMMs For CPU 2 Channels 3, 4, 5 24 Slimline (PCIe_A0) 25 CPU 2 Power 	<ul style="list-style-type: none"> 26 Fan 6 27 DIMMs For CPU 1 Channels 0, 1, 2 28 CPU 1 29 DIMMs For CPU 1 Channels 3, 4, 5 30 Fan 5 31 Fan 4 32 CPU 1 Power 33 Intrusion Switch 34 Fan 3 35 Fan 2 36 Backplane Signal 1 37 Left Control Panel 38 Right Control Panel
--	---	---

Mechanical Overview

Top View

Rear View

HDD Drives

HDD Drives

*Your system may be configured with either hot- or cold-swap components. Follow the corresponding instructions.
 **Your system may be configured with Riser or non-Riser in PCIe Card Slots. Follow the corresponding instructions.

Jumper Settings

Jumper	Setting	Description
PWRD_EN	(default)	BIOS password is enabled.
↓		BIOS password is disabled. iDRAC local access is unlocked at next AC power cycle. iDRAC password reset is enabled in F2 iDRAC settings menu.
NVRAM_CLR	(default)	BIOS configuration settings retained at system boot.
↓		BIOS configuration settings cleared at system boot.

Figure 17. PowerEdge R540 – Service information

Memory Information

⚠ Caution: Memory (DIMMs) and CPUs may be hot during servicing

Memory Population Configuration

Configuration	Sequence
Memory-Optimized	C1{1}, C2{1}, C1{2}, C2{2}, C1{3}, C2{3}
Mirroring	C1{1,2,3,4,5,6}, C2{1,2,3,4,5,6}

Memory Sparring details are documented in the *Installation and Service Manual*.

Scan to see hardware servicing and software setup videos, how-to's, and documentation.

Quick Resource Locator
Dell.com/QRL/Server/PER540

Icon Legend

EST Express Service Tag	Hard Drive Activity
Memory Bank	Mgmt Port
Power Supply	Push
System Status	Fan
System Info	CPU

Figure 18. Memory information

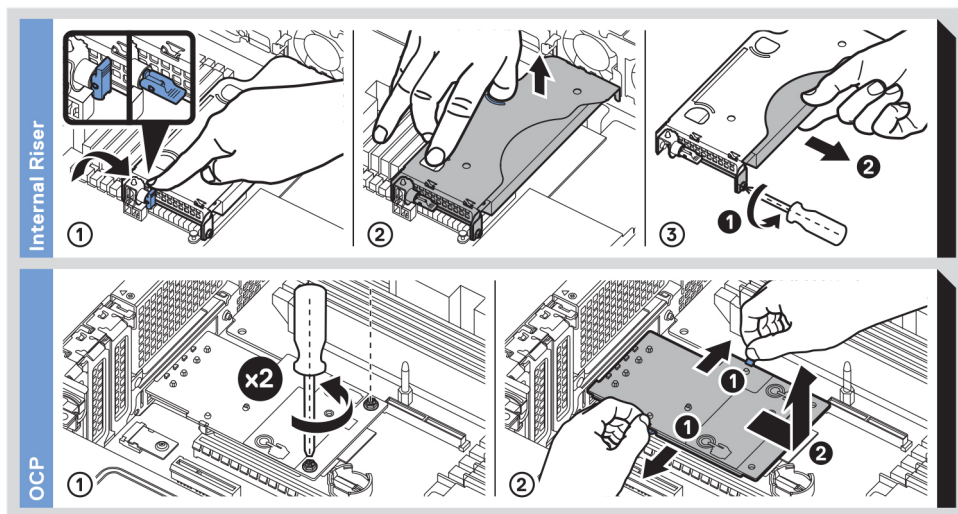

Figure 19. OCP and internal PERC riser installation

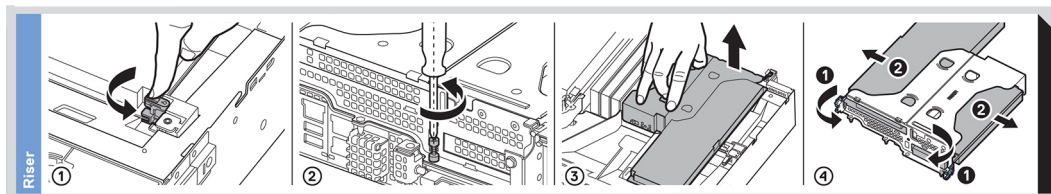

Figure 20. Riser installation

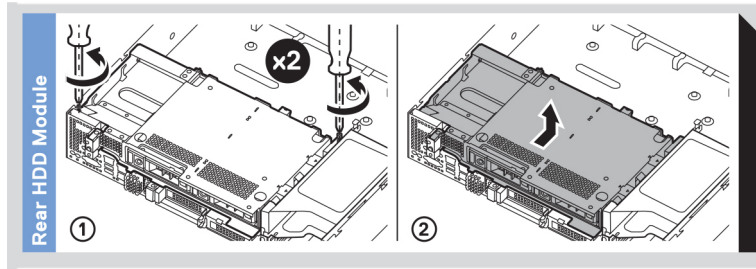

Figure 21. Rear drive installation

Identifier	GUID-D2CFC267-94F6-4A0C-B813-2EC7A31EE8C6
Status	Released

Documentation resources

This section provides information about the documentation resources for your system.

To view the document that is listed in the documentation resources table:

- From the Dell EMC support site:
 1. Click the documentation link that is provided in the Location column in the table.
 2. Click the required product or product version.
 - ① **NOTE: To locate the product name and model, see the front of your system.**
 3. On the Product Support page, click **Manuals & documents**.
- Using search engines:
 - Type the name and version of the document in the search box.

Table 17. Additional documentation resources for your system

Task	Document	Location
Setting up your system	For more information about installing and securing the system into a rack, see the Rail Installation Guide included with your rack solution. For information about setting up your system, see the <i>Getting Started Guide</i> document that is shipped with your system.	www.dell.com/poweredgemanuals
Configuring your system	For information about the iDRAC features, configuring and logging in to iDRAC, and managing your system remotely, see the Integrated Dell Remote Access Controller User's Guide. For information about understanding Remote Access Controller Admin (RACADM) subcommands and supported RACADM interfaces, see the RACADM CLI Guide for iDRAC. For information about Redfish and its protocol, supported schema, and Redfish Eventing implemented in iDRAC, see the Redfish API Guide. For information about iDRAC property database group and object descriptions, see the Attribute Registry Guide.	www.dell.com/poweredgemanuals
	For information about earlier versions of the iDRAC documents. To identify the version of iDRAC available on your system, on the iDRAC web interface, click ? > About .	www.dell.com/idracmanuals
	For information about installing the operating system, see the operating system documentation.	www.dell.com/operatingsystemmanuals
	For information about updating drivers and firmware, see the Methods to download firmware and drivers section in this document.	www.dell.com/support/drivers

Task	Document	Location
Managing your system	For information about systems management software offered by Dell, see the Dell OpenManage Systems Management Overview Guide.	www.dell.com/poweredgemanuals
	For information about setting up, using, and troubleshooting OpenManage, see the Dell OpenManage Server Administrator User's Guide.	www.dell.com/openmanagemanuals > OpenManage Server Administrator
	For information about installing, using, and troubleshooting Dell OpenManage Essentials, see the Dell OpenManage Essentials User's Guide.	www.dell.com/openmanagemanuals > OpenManage Essentials
	For information about installing and using Dell SupportAssist, see the Dell EMC SupportAssist Enterprise User's Guide.	www.dell.com/serviceabilitytools
	For information about partner programs enterprise systems management, see the OpenManage Connections Enterprise Systems Management documents.	www.dell.com/openmanagemanuals
Working with the Dell PowerEdge RAID controllers	For information about understanding the features of the Dell PowerEdge RAID controllers (PERC), Software RAID controllers, or BOSS card and deploying the cards, see the Storage controller documentation.	www.dell.com/storagecontrollermanuals
Understanding event and error messages	For information about the event and error messages generated by the system firmware and agents that monitor system components, see the Error Code Lookup.	www.dell.com/qrl
Troubleshooting your system	For information about identifying and troubleshooting the PowerEdge server issues, see the Server Troubleshooting Guide.	www.dell.com/poweredgemanuals

Identifier	GUID-F6A17A77-7275-43CA-9B28-FA7BEC53ED93
Status	Released

Technical specifications

Identifier	GUID-BE83F2E8-1B1F-4913-BA82-8746CE35D3D7
Status	Released

System dimensions

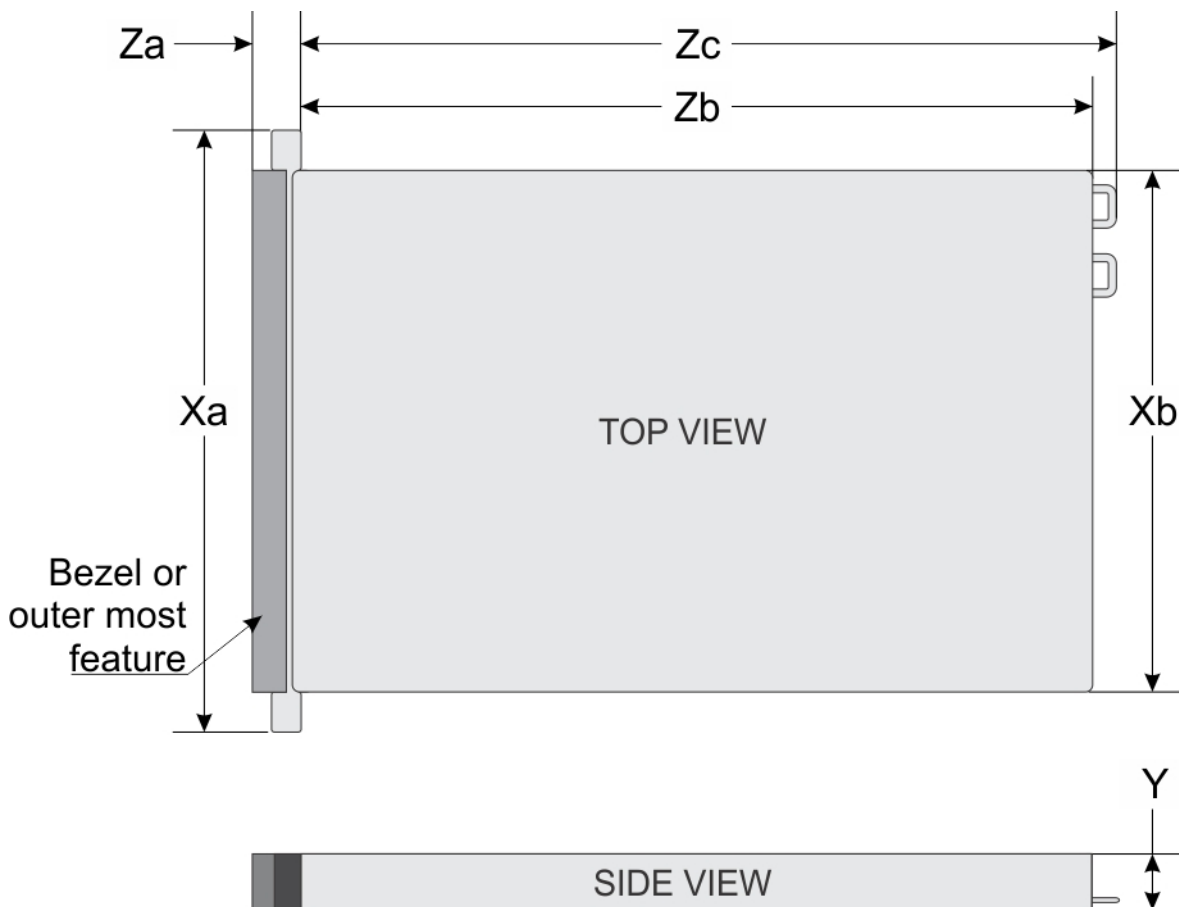

Figure 22. Dimensions of the Dell EMC PowerEdge R540 system

Table 18. Dimensions of the Dell EMC R540 system

Xa	Xb	Y	Za (with bezel)	Za (without bezel)	Zb	Zc
482.0 mm (18.97 inches)	434.0 mm (17.08 inches)	86.8 mm (3.41 inches)	35.84 mm (1.41 inches)	22 mm (0.87 inches)	647.07 mm (25.47 inches)	681.755 mm (26.84 inches)

Identifier	GUID-D26183AF-9A3B-42E7-822A-14B0BAE0A428
Status	Released

Chassis weight

Table 19. Chassis weight

System	Maximum weight (with all drives/SSDs)
8 x 3.5 inch	25.4 kg (55.99 lb)
12 x 3.5 inch	29.68 kg (65.43 lb)

Identifier	GUID-46687A82-7160-47FB-A9D8-C32B77EE4289
Status	Released

Processor specifications

The Dell EMC PowerEdge R540 System supports up to two Intel Xeon Scalable processors, up to 20 cores per processor.

Identifier	GUID-DA60940A-C8EF-41B8-ABFD-CD8B6F051E23
Status	Released

Supported operating systems

The Dell EMC PowerEdgeR540 supports the following operating systems:

- Red Hat Enterprise Linux
- SUSE Linux Enterprise Server
- Canonical Ubuntu LTS
- Microsoft Windows Server with Hyper-V
- VMware ESXi
- Citrix XenServer

NOTE: For more information about the specific versions and additions, go to Dell.com/support/home/Drivers/SupportedOS/poweredge-R540.

Identifier	GUID-F1A470F4-8A15-4712-93D1-FEA1DC3AB724
Status	Released

Cooling fans specifications

Your system supports up to six standard or high performance cabled cooling fans.

Table 20. Fan support matrix for Dell EMC PowerEdge R540 System

Front Storage	PSU type	CPU count	Fan1	Fan2	Fan3	Fan4	Fan5	Fan6
8 x 3.5-inch	Cable PSU or Redundant PSU	1	Not required	Required	Required	Required	Required	Not required
	Redundant PSU	2	Not required	Required	Required	Required	Required	Required
12 x 3.5-inch	Redundant PSU only	1	Required	Required	Required	Required	Required	Not required
		2	Required	Required	Required	Required	Required	Required

NOTE: The high performance fans are required for 12 x 3.5-inch drive + 2 x 3.5-inch rear drive system. For more information, see the Thermal restriction matrix topic in the Technical specifications section.

Identifier GUID-FAA68947-C510-4BB7-A3CA-C821B81B9B0C
Status Released

PSU specifications

The Dell EMC PowerEdge R540 system supports the following AC or DC power supply units (PSU).

Table 21. PSU specifications

PSU	Class	Heat dissipation (maximum)	Frequency	Voltage
1100 W AC	Platinum	4100 BTU/hr	50/60 Hz	100–240 V AC, autoranging
1100 W DC	Platinum	4416 BTU/hr	50/60 Hz	200–380 V DC, autoranging
750 W AC	Platinum	2891 BTU/hr	50/60 Hz	100–240 V AC, autoranging
750 W DC	Platinum	2902 BTU/hr	50/60 Hz	240 V DC
495 W AC	Platinum	1908 BTU/hr	50/60 Hz	100–240 V AC, autoranging
450 W AC	Bronze	1871 BTU/hr	50/60 Hz	100–240 V AC, autoranging

NOTE: Heat dissipation is calculated using the PSU wattage rating.

NOTE: This system is also designed to connect to the IT power systems with a phase-to-phase voltage not exceeding 230 V.

Identifier GUID-08401B58-31A6-42A5-89F4-2FBE211FBF19
Status Released

System battery

Identifier GUID-C18FC680-E2D0-46E4-AA5C-7C4D9C317454
Status Released

Expansion bus specifications

The Dell EMC PowerEdge R540 system supports PCI express (PCIe) generation three expansion cards, which must be installed on the system board using expansion card risers. The R540 system supports three types of expansion card risers.

Identifier GUID-A13C9B4B-3CB0-4ECC-BC25-3CBE156E6CCA
Status Released

Memory specifications

Table 22. Memory specifications

DIMM type	DIMM rank	DIMM capacity	Single processor		Dual processors	
			Minimum RAM	Maximum RAM	Minimum RAM	Maximum RAM
RDIMM	Single rank	8 GB	8 GB	80 GB	16 GB	128 GB
RDIMM	Dual rank	16 GB	16 GB	160 GB	32 GB	256 GB
RDIMM	Dual rank	32 GB	32 GB	320 GB	64 GB	512 GB
LRDIMM	Quad rank	64 GB	64 GB	640 GB	128 GB	1024 GB

Identifier GUID-09958A66-285A-45D7-B84D-F204A787F262
Status Released

Storage controller specifications

The Dell EMC PowerEdge R540 system supports:

- **Internal controllers:** PowerEdge RAID Controller (PERC) H330, H730p, H740p, HBA330, Software RAID (SWRAID) S140
- **Boot Optimized Subsystem:** HWRAID 2 x M.2 SSDs 120GB, 240 GB .
- **External controller:** 12 Gbps SAS HBA.

Identifier	GUID-6CD0E5BF-3B87-4156-9133-C674032FC4B2
Status	Released

Drive specifications

Identifier	GUID-FF86C4AF-B21F-4942-A280-4FCEC0D17AB8
Status	Released

Drives

The PowerEdge R540 system supports:

- Up to 14 x 3.5 inch drives or 2.5 inch drives with drive adapter, internal, hot swappable SAS, SATA, or Nearline SAS drives
or
- Up to 8 x 3.5 inch drives or 2.5 inch drives with drive adapter, internal, hot swappable SATA SSDs

Identifier	GUID-BCBA2D1E-B972-4376-84B7-7418C439EB86
Status	Released

Optical drives

The Dell EMC PowerEdge R540 system supports one optional slim SATA DVD-ROM drive or DVD +/-RW drive.

Identifier	GUID-4D89E84A-1030-457E-BAB5-D86CDE32B776
Status	Released

Tape Drives

The Dell EMC PowerEdge R540 system supports external tape backup devices.

NOTE: The Dell EMC PowerEdge R540 system does not support internal tape drives.

Supported external tape drives:

- External RD1000 USB
- External LTO-5, LTO-6, LTO-7 and 6 Gb SAS tape drives
- 114X rack mount chassis with LTO-5, LTO-6, and LTO-7 6 Gb SAS tape drives
- TL1000 with LTO-5, LTO-6, and LTO-7 6 Gb SAS tape drives
- TL2000 with LTO-5, LTO-6, and LTO-7 6 Gb SAS tape drives
- TL2000 with LTO-5, LTO-6, and LTO-7 8Gb FC tape drives
- TL4000 with LTO-5, LTO-6, and LTO-7 6 Gb SAS tape drives
- TL4000 with LTO-5, LTO-6, and LTO-7 8Gb FC tape drives
- ML6000 with LTO-5, LTO-6, 6 Gb SAS tape drives
- ML6000 with LTO-5, LTO-6, LTO-7 8Gb FC tape drives

Identifier	GUID-973633D8-8C4C-4ACC-BF2B-7B198AEA36AB
Status	Released

Ports and connectors specifications

Identifier	GUID-78C72946-3ACF-48F8-B036-09FF79D0546C
Status	Released

USB ports

The Dell EMC PowerEdge R540 system supports:

Table 23. USB specifications

Front panel	Back panel	Internal USB
<ul style="list-style-type: none"> Two USB 2.0-compliant port One iDRAC Direct (Micro-AB USB) port 	<ul style="list-style-type: none"> Two USB 3.0-compliant port 	<ul style="list-style-type: none"> One internal USB 3.0 port

Identifier	GUID-3CE3599A-AE4C-46B9-A63E-F23C6A864149
Status	Released

NIC ports

The Dell EMC PowerEdge R540 system supports two Network Interface Controller (NIC) ports on the back panel, which have two 1 Gbps configuration.

NOTE: You can install up to six PCIe add-on NIC cards.

Identifier	GUID-C2B24720-22CC-436E-970B-A17D2064F301
Status	Released

VGA ports

The Video Graphic Array (VGA) port enables you to connect the system to a VGA display. The Dell EMC PowerEdge R540 system supports two 15-pin VGA ports.

Identifier	GUID-79E40E83-7572-4D5A-A0BC-CFDA829CD935
Status	Released

Serial connector

The serial connector connects a serial device to the system. The Dell EMC PowerEdge R540 system supports one serial connector on the back panel, which is a 9-pin connector, Data Terminal Equipment (DTE), 16550-compliant.

Identifier	GUID-2DA6B68F-8020-437C-8A24-5D5EB0CCC955
Status	Released

Internal Dual SD Module

The Dell EMC PowerEdge R540 system supports two optional flash memory card slots with an internal dual MicroSD module.

NOTE: One card slot is dedicated for redundancy.

Identifier	GUID-97E55792-C099-4813-BE69-C5FDFFFDA8B6
Status	Released

Video specifications

The PowerEdge Dell EMC PowerEdge R540 system supports Matrox G200eR2 graphics card with 16 MB capacity.

Table 24. Supported video resolution options

Resolution	Refresh rate (Hz)	Horizontal frequency (kHz)	Pixel clock	Rear Panel	Front panel	DVO DisplayPort
1024x768	60	48.4	65.0	Yes	Yes	Yes
1280x800	60	49.7	83.5	Yes	Yes	Yes
1280x1024	60	64.0	108.0	Yes	TBD	Yes
1360x768	60	47.71	85.5	Yes	Yes	Yes
1440x900	60	55.9	106.5	Yes	TBD	Yes
1600x900	60 (RB)	55.54	97.75	Yes	Yes	Yes
1600x1200	60	75.0	162.0	TBD	TBD	Yes

Resolution	Refresh rate (Hz)	Horizontal frequency (kHz)	Pixel clock	Rear Panel	Front panel	DVO DisplayPort
1680x1050	60 (RB)	64.7	119.0	Yes	TBD	Yes
1920x1080	60	67.158	173.0	TBD	No	No
1920x1200	60	74.556	193.25	TBD	No	No

Identifier GUID-32B9D0FB-5508-45EB-9184-00F461B0CB0F
Status Released

Environmental specifications

NOTE: For additional information about environmental certifications, please refer to the Product Environmental Datasheet located with the Manuals & Documents on www.dell.com/poweredgemanuals

Table 25. Temperature specifications

Temperature	Specifications
Storage	-40°C to 65°C (-40°F to 149°F)
Continuous operation (for altitude less than 950 m or 3117 ft)	10°C to 35°C (50°F to 95°F) with no direct sunlight on the equipment.
Fresh air	For information about fresh air, see the Expanded Operating Temperature section.
Maximum temperature gradient (operating and storage)	20°C/h (68°F/h)

Table 26. Relative humidity specifications

Relative humidity	Specifications
Storage	5% to 95% RH with 33°C (91°F) maximum dew point. Atmosphere must be non-condensing at all times.
Operating	10% to 80% relative humidity with 29°C (84.2°F) maximum dew point.

Table 27. Maximum vibration specifications

Maximum vibration	Specifications
Operating	0.26 G _{rms} at 5 Hz to 350 Hz (all operation orientations).
Storage	1.88 G _{rms} at 10 Hz to 500 Hz for 15 min (all six sides tested).

Table 28. Maximum shock specifications

Maximum shock	Specifications
Operating	Six consecutively executed shock pulses in the positive and negative x, y, and z axes of 6 G for up to 11 ms.
Storage	Six consecutively executed shock pulses in the positive and negative x, y, and z axes (one pulse on each side of the system) of 71 G for up to 2 ms.

Table 29. Maximum altitude specifications

Maximum altitude	Specifications
Operating	30482000 m (10,0006560 ft)
Storage	12,000 m (39,370 ft)

Table 30. Operating temperature derating specifications

Operating temperature derating	Specifications
Up to 35°C (95°F)	Maximum temperature is reduced by 1°C/300 m (1°F/547 ft) above 950 m (3,117 ft).

Operating temperature derating	Specifications
35°C to 40°C (95°F to 104°F)	Maximum temperature is reduced by 1°C/175 m (1°F/319 ft) above 950 m (3,117 ft).
40°C to 45°C (104°F to 113°F)	Maximum temperature is reduced by 1°C/125 m (1°F/228 ft) above 950 m (3,117 ft).

Identifier GUID-A70F7609-6E0F-4D19-9C7F-58FF6936EC41
 Status Released

Standard operating temperature

Table 31. Standard operating temperature specifications

Standard operating temperature	Specifications
Continuous operation (for altitude less than 950 m or 3117 ft)	10°C to 35°C (50°F to 95°F) with no direct sunlight on the equipment.

Identifier GUID-CD253CA4-39C3-4F06-BC7C-4D41782E8A8A
 Status Released

Expanded operating temperature

Table 32. Expanded operating temperature specifications

Expanded operating temperature	Specifications
Continuous operation	<p>5°C to 40°C at 5% to 85% RH with 29°C dew point.</p> <p>NOTE: Outside the standard operating temperature (10°C to 40°C), the system can operate continuously in temperatures as low as 5°C and as high as 40°C.</p> <p>For temperatures between 35°C and 40°C, de-rate maximum allowable temperature by 1°C per 175 m above 950 m (1°F per 319 ft).</p>
≤ 1% of annual operating hours	<p>–5°C to 45°C at 5% to 90% RH with 29°C dew point.</p> <p>NOTE: Outside the standard operating temperature (10°C to 40°C), the system can operate down to –5°C or up to 45°C for a maximum of 1% of its annual operating hours.</p> <p>For temperatures between 40°C and 45°C, de-rate maximum allowable temperature by 1°C per 125 m above 950 m (1°F per 228 ft).</p>

NOTE: When operating in the expanded temperature range, system performance may be impacted.

NOTE: When operating in the expanded temperature range, ambient temperature warnings may be reported on the bezel's LCD panel and in the System Event Log.

Identifier GUID-5E65F614-EFF0-4696-A61C-85EBD9B7CDC2
 Status Released

Expanded operating temperature restrictions

- Do not perform a cold startup below 5°C.
- The operating temperature specified is for a maximum altitude of 3050 m (10,000 ft).
- Redundant power supply configuration is required.
- AEP DIMM is not supported.
- GPGPU card is not supported.
- Rear drive configuration is not supported.
- 12 x 3.5 inch SM configuration with CPU 140 W/130 W/115 W/105 W_4C is not supported.
- LRDIMM is not supported.
- Non-Dell qualified peripheral cards and/or peripheral cards greater than 25 W are not supported.

- Tape backup unit (TBU) is not supported.

Identifier GUID-60BFAF7D-8A6B-44EA-A7FE-1D9BEB0998D3
 Status Released

Thermal restriction matrix

Table 33. Thermal restriction matrix for R540

Storage configuration		Front	8 drive	12 drive		12 drive
		Rear	NA	NA		2 drive
Fan type			Standard fan	Standard fan		High performance fan
CPU heat sink type			1.5U heat sink	1.5U heat sink		1U heat sink
Processor number	TDP (W)	Core count	Ambient = 35°C	Ambient = 35°C	Ambient = 30°C	Ambient = 30°C
Intel Xenon Gold 6138	125	20	Yes	Yes	Yes	Yes
Intel Xenon Gold 6130	125	16	Yes	Yes	Yes	Yes
Intel Xenon Gold 6126	125	12	Yes	Yes	Yes	Yes
Intel Xenon Gold 6128	115	6	Yes	No	Yes	Yes
Intel Xenon Gold 5122	105	4	Yes	No	Yes	Yes
Intel Xenon Gold 5115	85	10	Yes	Yes	Yes	Yes
Intel Xenon Silver 4116	85	12	Yes	Yes	Yes	Yes
Intel Xenon Silver 4114	85	10	Yes	Yes	Yes	Yes
Intel Xenon Silver 4110	85	8	Yes	Yes	Yes	Yes
Intel Xenon Bronze 3106	85	8	Yes	Yes	Yes	Yes
Intel Xenon Bronze 3104	85	6	Yes	Yes	Yes	Yes
Intel Xenon Silver 4112	85	4	Yes	Yes	Yes	Yes

Identifier GUID-639D023A-0DB6-418C-9D0F-3FD7C4A2A627
 Status Released

Particulate and gaseous contamination specifications

The following table defines the limitations that help avoid any equipment damage or failure from particulates and gaseous contamination. If the levels of particulates or gaseous pollution exceed the specified limitations and result in equipment damage or failure, you may need to rectify the environmental conditions. Re-mediation of environmental conditions is the responsibility of the customer.

Table 34. Particulate contamination specifications

Particulate contamination	Specifications
Air filtration	<p>Data center air filtration as defined by ISO Class 8 per ISO 14644-1 with a 95% upper confidence limit.</p> <p>NOTE: This condition applies to data center environments only. Air filtration requirements do not apply to IT equipment designed to be used outside a data center, in environments such as an office or factory floor.</p> <p>NOTE: Air entering the data center must have MERV11 or MERV13 filtration.</p>
Conductive dust	<p>Air must be free of conductive dust, zinc whiskers, or other conductive particles.</p> <p>NOTE: This condition applies to data center and non-data center environments.</p>
Corrosive dust	<ul style="list-style-type: none"> · Air must be free of corrosive dust. · Residual dust present in the air must have a deliquescent point less than 60% relative humidity. <p>NOTE: This condition applies to data center and non-data center environments.</p>

Table 35. Gaseous contamination specifications

Gaseous contamination	Specifications
Copper coupon corrosion rate	<300 Å/month per Class G1 as defined by ANSI/ISA71.04-1985.
Silver coupon corrosion rate	<200 Å/month as defined by AHSRAE TC9.9.

NOTE: Maximum corrosive contaminant levels measured at ≤50% relative humidity.

Identifier	GUID-AEDA80DE-F171-42AC-967B-D62DF112EFDE
Status	Released

Initial system setup and configuration

Identifier	GUID-CEB81DE2-87AF-458B-952E-B71D3A5C3FEA
Status	Released

Setting up your system

Perform the following steps to set up your system:

Steps

1. Unpack the system.
2. Install the system into the rack. For more information about installing the system into the rack, see the *Rail Installation Guide* at www.dell.com/poweredgemanuals.
3. Connect the peripherals to the system.
4. Connect the system to its electrical outlet.
5. Power on the system by pressing the power button or by using iDRAC.
6. Power on the attached peripherals.

For more information about setting up your system, see the *Getting Started Guide* that shipped with your system.

Identifier	GUID-F6A0C7AF-C3D1-430A-9C19-9CD1F42FD138
Status	Released

iDRAC configuration

The Integrated Dell Remote Access Controller (iDRAC) is designed to make system administrators more productive and improve the overall availability of Dell systems. iDRAC alerts administrators about system issues and enables them to perform remote system management. This reduces the need for physical access to the system.

Identifier	GUID-B103AA76-1FAA-4450-87DB-595415D60C5B
Status	Released

Options to set up iDRAC IP address

To enable communication between your system and iDRAC, you must first configure the network settings based on your network infrastructure.

NOTE: For static IP configuration, you must request for it at the time of purchase.

This option is set to **DHCP** by Default. You can set up the IP address by using one of the following interfaces:

Interfaces	Document/Section
iDRAC Settings utility	<i>Dell Integrated Dell Remote Access Controller User's Guide</i> at www.dell.com/poweredgemanuals
Dell Deployment Toolkit	<i>Dell Deployment Toolkit User's Guide</i> at www.dell.com/openmanagemanuals > OpenManage Deployment Toolkit
Dell Lifecycle Controller	<i>Dell Lifecycle Controller User's Guide</i> at www.dell.com/poweredgemanuals
Server LCD panel	LCD panel section

Interfaces Document/Section

iDRAC Direct and Quick Sync 2 (optional) See *Dell Integrated Dell Remote Access Controller User's Guide* at www.dell.com/poweredgemanuals

NOTE: To access iDRAC, ensure that you connect the ethernet cable to the iDRAC9 dedicated network port. You can also access iDRAC through the shared LOM mode, if you have opted for a system that has the shared LOM mode enabled.

Identifier	GUID-4C2107BA-EF66-4B32-9913-6F8E53C335F2
Status	Released

Log in to iDRAC

You can log in to iDRAC as:

- iDRAC user
- Microsoft Active Directory user
- Lightweight Directory Access Protocol (LDAP) user

If you have opted for secure default access to iDRAC, you must use the iDRAC secure default password available on the system Information tag. If you have not opted for secure default access to iDRAC, then use the default user name and password `-root` and `calvin`. You can also log in by using your Single Sign-On or Smart Card.

NOTE: You must have the iDRAC credentials to log in to iDRAC.

NOTE: Ensure that you change the default user name and password after setting up the iDRAC IP address.

NOTE: The Intel Quick Assist Technology (QAT) on the Dell EMC PowerEdge R540 is supported with chipset integration and is enabled through an optional license. The license files are enabled on the sleds through iDRAC.

For more information about drivers, documentation, and white papers on the Intel QAT, see <https://01.org/intel-quickassist-technology>.

For more information about logging in to the iDRAC and iDRAC licenses, see the latest *Integrated Dell Remote Access Controller User's Guide* at www.dell.com/poweredgemanuals.

You can also access iDRAC by using RACADM. For more information, see the *RACADM Command Line Interface Reference Guide* at www.dell.com/poweredgemanuals.

Identifier	GUID-DB9032D7-9186-4AD3-88C9-72F96686378C
Status	Released

Options to install the operating system

If the system is shipped without an operating system, install a supported operating system by using one of the following resources:

Table 36. Resources to install the operating system

Resources	Location
iDRAC	www.dell.com/idracmanuals
Lifecycle Controller	www.dell.com/idracmanuals > Lifecycle Controller
OpenManage Deployment Toolkit	www.dell.com/openmanagemanuals > OpenManage Deployment Toolkit
Dell certified VMware ESXi	www.dell.com/virtualizationsolutions
Installation and How-to videos for supported operating systems on PowerEdge systems	Supported Operating Systems for Dell EMC PowerEdge systems

Identifier	GUID-5D54BF63-7014-4627-8336-7EED724A6E97
Status	Released

Methods to download firmware and drivers

You can download the firmware and drivers by using any of the following methods:

Table 37. Firmware and drivers

Methods	Location
From the Dell EMC support site	www.dell.com/support/home
Using Dell Remote Access Controller Lifecycle Controller (iDRAC with LC)	www.dell.com/idracmanuals
Using Dell Repository Manager (DRM)	www.dell.com/openmanagemanuals > Repository Manager
Using Dell OpenManage Essentials (OME)	www.dell.com/openmanagemanuals > OpenManage Essentials
Using Dell Server Update Utility (SUU)	www.dell.com/openmanagemanuals > Server Update Utility
Using Dell OpenManage Deployment Toolkit (DTK)	www.dell.com/openmanagemanuals > OpenManage Deployment Toolkit
Using iDRAC virtual media	www.dell.com/idracmanuals

Identifier	GUID-3FEE65C4-8FCA-4A29-B042-19F05D746390
Status	Released

Downloading drivers and firmware

Dell EMC recommends that you download and install the latest BIOS, drivers, and systems management firmware on your system.

Prerequisites

Ensure that you clear the web browser cache before downloading the drivers and firmware.

Steps

1. Go to www.dell.com/support/home.
2. In the **Drivers & Downloads** section, type the Service Tag of your system in the **Enter a Service Tag or product ID** box, and then click **Submit**.

 **NOTE: If you do not have the Service Tag, select Detect Product to allow the system to automatically detect the Service Tag, or click View products, and navigate to your product.**
3. Click **Drivers & Downloads**.
The drivers that are applicable to your system are displayed.
4. Download the drivers to a USB drive, CD, or DVD.

Identifier	GUID-53CC073C-7846-4BB4-901B-8043412A4237
Status	Released

Pre-operating system management applications

You can manage basic settings and features of a system without booting to the operating system by using the system firmware.

Topics:

- Options to manage the pre-operating system applications
- System Setup
- Dell Lifecycle Controller
- Boot Manager
- PXE boot

Identifier	GUID-29043DBD-F47B-4194-9EDF-A4AD839649D5
Status	Released

Options to manage the pre-operating system applications

Your system has the following options to manage the pre-operating system applications:

- System Setup
- Dell Lifecycle Controller
- Boot Manager
- Preboot Execution Environment (PXE)

Identifier	GUID-D926FD8D-A977-4289-B1E7-45D0FE546139
Status	Released

System Setup

By using the **System Setup** screen, you can configure the BIOS settings, iDRAC settings, and device settings of your system.

NOTE: Help text for the selected field is displayed in the graphical browser by default. To view the help text in the text browser, press F1.

You can access system setup by one of the following:

- Standard graphical browser—The browser is enabled by default.
- Text browser—The browser is enabled by using Console Redirection.

Identifier	GUID-89205AA6-C400-4026-AE6A-76A0A287F636
Status	Released

Viewing System Setup

To view the **System Setup** screen, perform the following steps:

Steps

1. Power on, or restart your system.

2. Press F2 immediately after you see the following message:

```
F2 = System Setup
```

NOTE: If your operating system begins to load before you press F2, wait for the system to finish booting, and then restart your system and try again.

Identifier	GUID-A3527EA8-BDCC-42EF-BEE3-DE4E4463A55B
Status	Released

System Setup details

The **System Setup Main Menu** screen details are explained as follows:

Option	Description
System BIOS	Enables you to configure BIOS settings.
iDRAC Settings	Enables you to configure the iDRAC settings. The iDRAC settings utility is an interface to set up and configure the iDRAC parameters by using UEFI (Unified Extensible Firmware Interface). You can enable or disable various iDRAC parameters by using the iDRAC settings utility. For more information about this utility, see <i>Integrated Dell Remote Access Controller User's Guide</i> at www.dell.com/poweredge/manuals .
Device Settings	Enables you to configure device settings.
Service Tag Settings	Enables you to configure service tag settings.

Identifier	GUID-4C2BEF93-8071-4771-8FD6-8B34A3C9A0D2
Status	Released

System BIOS

You can use the **System BIOS** screen to edit specific functions such as boot order, system password, and setup password, set the SATA and PCIe NVMe RAID mode, and enable or disable USB ports.

Identifier	GUID-27E3876A-751B-4D5C-8AF6-D23532E519C7
Status	Released

Viewing System BIOS

To view the **System BIOS** screen, perform the following steps:

Steps

1. Power on, or restart your system.
2. Press F2 immediately after you see the following message:

```
F2 = System Setup
```

NOTE: If the operating system begins to load before you press F2, wait for the system to finish booting, and then restart the system and try again.

3. On the **System Setup Main Menu** screen, click **System BIOS**.

Identifier	GUID-62C95E9F-DCA7-4314-967F-8C31B3E9EDB1
Status	Released

System BIOS Settings details

About this task

The **System BIOS Settings** screen details are explained as follows:

Option	Description
System Information	Provides information about the system such as the system model name, BIOS version, and Service Tag.
Memory Settings	Provides information and options related to the installed memory.
Processor Settings	Provides information and options related to the processor such as speed and cache size.
SATA Settings	Provides options to enable or disable the integrated SATA controller and ports.
NVMe Settings	Provides options to change the NVMe settings. If the system contains the NVMe drives that you want to configure in a RAID array, you must set both this field and the Embedded SATA field on the SATA Settings menu to RAID mode. You might also need to change the Boot Mode setting to UEFI . Otherwise, you should set this field to Non-RAID mode.
Boot Settings	Provides options to specify the Boot mode (BIOS or UEFI). Enables you to modify UEFI and BIOS boot settings.
Network Settings	Provides options to manage the UEFI network settings and boot protocols. Legacy network settings are managed from the Device Settings menu.
Integrated Devices	Provides options to manage integrated device controllers and ports, specifies related features and options.
Serial Communication	Provides options to manage the serial ports, their related features and options.
System Profile Settings	Provides options to change the processor power management settings, and memory frequency.
System Security	Provides options to configure the system security settings, such as system password, setup password, Trusted Platform Module (TPM) security, and UEFI secure boot. It also manages the power button on the system.
Redundant OS Control	Sets the redundant OS information for redundant OS control.
Miscellaneous Settings	Provides options to change the system date and time.

Identifier	GUID-CC252A6A-99FC-4DCF-8872-5C84F52B5D64
Status	Released

System Information

You can use the **System Information** screen to view system properties such as Service Tag, system model name, and BIOS version.

Identifier	GUID-702069D6-7862-4BD4-A2EA-627A2CD38A6E
Status	Released

Viewing System Information

To view the **System Information** screen, perform the following steps:

Steps

1. Power on, or restart your system.
2. Press F2 immediately after you see the following message:

F2 = System Setup



NOTE: If your operating system begins to load before you press F2, wait for the system to finish booting, and then restart your system and try again.

3. On the **System Setup Main Menu** screen, click **System BIOS**.
4. On the **System BIOS** screen, click **System Information**.

Identifier	GUID-673D8A44-44EA-411A-A73F-3C43E3D9A083
Status	Released

System Information details

About this task

The **System Information** screen details are explained as follows:

Option	Description
System Model Name	Specifies the system model name.
System BIOS Version	Specifies the BIOS version installed on the system.
System Management Engine Version	Specifies the current version of the Management Engine firmware.
System Service Tag	Specifies the system Service Tag.
System Manufacturer	Specifies the name of the system manufacturer.
System Manufacturer Contact Information	Specifies the contact information of the system manufacturer.
System CPLD Version	Specifies the current version of the system complex programmable logic device (CPLD) firmware.
UEFI Compliance Version	Specifies the UEFI compliance level of the system firmware.

Identifier	GUID-87E8FC3A-D77A-4D26-9F74-A84DD1073CEC
Status	Released

Memory Settings

You can use the **Memory Settings** screen to view all the memory settings and enable or disable specific memory functions, such as system memory testing and node interleaving.

Identifier	GUID-39B095BC-6429-4A16-B399-1537E3351366
Status	Released

Viewing Memory Settings

To view the **Memory Settings** screen, perform the following steps:

Steps

1. Power on, or restart your system.
2. Press F2 immediately after you see the following message:

```
F2 = System Setup
```

NOTE: If the operating system begins to load before you press F2, wait for the system to finish booting, and then restart the system and try again.

3. On the **System Setup Main Menu** screen, click **System BIOS**.
4. On the **System BIOS** screen, click **Memory Settings**.

Identifier	GUID-82ABA29C-1E0D-404D-A7C7-B2F2C93E65CC
Status	Released

Memory Settings details

About this task

The **Memory Settings** screen details are explained as follows:

Option	Description
System Memory Size	Specifies the memory size in the system.
System Memory Type	Specifies the type of memory installed in the system.
System Memory Speed	Specifies the system memory speed.
System Memory Voltage	Specifies the system memory voltage.
Video Memory	Specifies the amount of video memory.
System Memory Testing	Specifies whether the system memory tests are run during system boot. Options are Enabled and Disabled . This option is set to Disabled by default.
Memory Operating Mode	Specifies the memory operating mode. The options available are Optimizer Mode , Single Rank Spare Mode , Multi Rank Spare Mode , and Mirror Mode . This option is set to Optimizer Mode by default.  NOTE: The Memory Operating Mode option can have different default and available options depending on the memory configuration of your system.
Current State of Memory Operating Mode	Specifies the current state of the memory operating mode.
Node Interleaving	Specifies if Non-Uniform Memory Architecture (NUMA) is supported. If this field is set to Enabled , memory interleaving is supported if a symmetric memory configuration is installed. If this field is set to Disabled , the system supports NUMA (asymmetric) memory configurations. This option is set to Disabled by default.
ADDDC Setting	Enables or disables ADDDC Setting feature. When Adaptive Double DRAM Device Correction (ADDDC) is enabled, failing DRAM's are dynamically mapped out. When set to Enabled it can have some impact to system performance under certain workloads. This feature is applicable for x4 DIMMs only. This option is set to Enabled by default.
Opportunistic Self-Refresh	Enables or disables opportunistic self-refresh feature. This option is set to Disabled by default.

Identifier	GUID-62A667F2-00F2-4DEE-BFA7-1924C88FCAAF
Status	Released

Processor Settings

You can use the **Processor Settings** screen to view the processor settings and perform specific functions such as enabling virtualization technology, hardware prefetcher, logical processor idling.

Identifier	GUID-C441DB6C-38FF-4CA9-BDBA-DA060A8B16F1
Status	Released

Viewing Processor Settings

To view the **Processor Settings** screen, perform the following steps:

Steps

1. Power on, or restart your system.
2. Press F2 immediately after you see the following message:

F2 = System Setup

NOTE: If your operating system begins to load before you press F2, wait for the system to finish booting, and then restart your system and try again.

- On the **System Setup Main Menu** screen, click **System BIOS**.
- On the **System BIOS** screen, click **Processor Settings**.

Identifier	GUID-AC6A729A-E608-44B1-AFFC-E024F94B28C9
Status	Released

Processor Settings details

About this task

The **Processor Settings** screen details are explained as follows:

Option	Description
Logical Processor	Enables or disables the logical processors and displays the number of logical processors. If this option is set to Enabled , the BIOS displays all the logical processors. If this option is set to Disabled , the BIOS displays only one logical processor per core. This option is set to Enabled by default.
CPU Interconnect Speed	<p>Enables you to govern the frequency of the communication links among the processors in the system.</p> <p>NOTE: The standard and basic bin processors support lower link frequencies.</p> <p>The options available are Maximum data rate, 10.4 GT/s, and 9.6 GT/s. This option is set to Maximum data rate by default.</p> <p>Maximum data rate indicates that the BIOS runs the communication links at the maximum frequency supported by the processors. You can also select specific frequencies that the processors support, which can vary.</p> <p>For best performance, you should select Maximum data rate. Any reduction in the communication link frequency affects the performance of non-local memory accesses and cache coherency traffic. In addition, it can slow access to non-local I/O devices from a particular processor.</p> <p>However, if power saving considerations outweigh performance, you might want to reduce the frequency of the processor communication links. If you do this, you should localize memory and I/O accesses to the nearest NUMA node to minimize the impact to system performance.</p>
Virtualization Technology	Enables or disables the virtualization technology for the processor. This option is set to Enabled by default.
Adjacent Cache Line Prefetch	Optimizes the system for applications that need high utilization of sequential memory access. This option is set to Enabled by default. You can disable this option for applications that need high utilization of random memory access.
Hardware Prefetcher	Enables or disables the hardware prefetcher. This option is set to Enabled by default.
Software Prefetcher	Enables or disables the software prefetcher. This option is set to Enabled by default.
DCU Streamer Prefetcher	Enables or disables the Data Cache Unit (DCU) streamer prefetcher. This option is set to Enabled by default.
DCU IP Prefetcher	Enables or disables the Data Cache Unit (DCU) IP prefetcher. This option is set to Enabled by default.
Sub NUMA Cluster	Enables or disables the Sub NUMA Cluster. This option is set to Disabled by default.
UPI Prefetch	Enables you to get the memory read started early on DDR bus. The Ultra Path Interconnect (UPI) Rx path will spawn the speculative memory read to Integrated Memory Controller (iMC) directly. This option is set to Enabled by default.
Logical Processor Idling	Enables you to improve the energy efficiency of a system. It uses the operating system core parking algorithm and parks some of the logical processors in the system which in turn allows the corresponding processor cores to transition into a lower power idle state. This option can only be enabled if the operating system supports it. It is set to Disabled by default.
Configurable TDP	<p>Enables you to configure the TDP level. The available options are Nominal, Level 1, and Level 2. This option is set to Nominal by default.</p> <p>NOTE: This option is only available on certain stock keeping units (SKUs) of the processors.</p>

Option	Description
SST-Performance Profile	Enables you to reconfigure the processor using Speed Select Technology.
x2APIC Mode	Enables or disables the x2APIC mode. This option is set to Enabled by default.
Number of Cores per Processor	Controls the number of enabled cores in each processor. This option is set to All by default.
Processor Core Speed	Specifies the maximum core frequency of the processor.
Processor Bus Speed	Displays the bus speed of the processor.
Processor n	 NOTE: Depending on the number of processors, there might be up to two processors listed.

The following settings are displayed for each processor installed in the system:

Option	Description
Family-Model-Stepping	Specifies the family, model, and stepping of the processor as defined by Intel.
Brand	Specifies the brand name.
Level 2 Cache	Specifies the total L2 cache.
Level 3 Cache	Specifies the total L3 cache.
Number of Cores	Specifies the number of cores per processor.
Maximum Memory Capacity	Specifies the maximum memory capacity per processor.
Microcode	Specifies the microcode.

Identifier	GUID-699EFC0B-7064-45F8-BF04-BC2CEABDBC3
Status	Released

SATA Settings

You can use the **SATA Settings** screen to view the settings of SATA devices and enable SATA and PCIe NVMe RAID mode on your system.

Identifier	GUID-4EB7A9C6-1CCD-4F80-B520-BA9FCBC63360
Status	Released

Viewing SATA Settings

To view the **SATA Settings** screen, perform the following steps:

Steps

1. Power on, or restart your system.
2. Press F2 immediately after you see the following message:

```
F2 = System Setup
```

 **NOTE: If your operating system begins to load before you press F2, wait for the system to finish booting, and then restart your system and try again.**

3. On the **System Setup Main Menu** screen, click **System BIOS**.
4. On the **System BIOS** screen, click **SATA Settings**.

Identifier	GUID-B28501D9-C477-4F5C-A0D4-0D20F2ACC4D8
Status	Released

SATA Settings details

About this task

The **SATA Settings** screen details are explained as follows:

Option	Description
Embedded SATA	Enables the embedded SATA option to be set to AHCI Mode , or RAID Mode . This option is set to AHCI Mode by default.
Security Freeze Lock	Enables you to send Security Freeze Lock command to the embedded SATA drives during POST. This option is applicable only for AHCI mode. This option is set to Enabled by default.
Write Cache	Enables or disables the command for the embedded SATA drives during POST. This option is set to Disabled by default.
Port n	Enables you to set the drive type of the selected device. For AHCI Mode or RAID Mode , BIOS support is always enabled.

Option	Description
Model	Specifies the drive model of the selected device.
Drive Type	Specifies the type of drive attached to the SATA port.
Capacity	Specifies the total capacity of the drive. This field is undefined for removable media devices such as optical drives.

Identifier	GUID-396B6A87-6C11-4116-B230-D8B2765905E4
Status	Released

NVMe Settings

The NVMe settings enable you to set the NVMe drives to either **RAID** mode or **Non-RAID** mode.

NOTE: To configure these drives as RAID drives, you must set the NVMe drives and the Embedded SATA option in the SATA Settings menu to RAID mode. If not, you must set this field to Non-RAID mode.

Identifier	GUID-41D3A07F-564A-4010-BA86-E02882BCBD13
Status	Released

Viewing NVMe Settings

To view the **NVMe Settings** screen, perform the following steps:

Steps

1. Power on, or restart your system.
2. Press F2 immediately after you see the following message:

```
F2 = System Setup
```

NOTE: If your operating system begins to load before you press F2, wait for the system to finish booting, and then restart your system and try again.

3. On the **System Setup Main Menu** screen, click **System BIOS**.
4. On the **System BIOS** screen, click **NVMe Settings**.

Identifier	GUID-D9FE4589-88F0-4172-A708-F1D76EAFB44B
Status	Released

NVMe Settings details

About this task

The NVMe Settings screen details are explained as follows:

Option	Description
NVMe Mode	Enables you to set the NVMe mode. This option is set to Non RAID by default.

Identifier	GUID-9E547053-FE7C-4824-8FCA-A0DBD619108F
Status	Released

Boot Settings

You can use the **Boot Settings** screen to set the boot mode to either **BIOS** or **UEFI**. It also enables you to specify the boot order.

- **UEFI:** The Unified Extensible Firmware Interface (UEFI) is a new interface between operating systems and platform firmware. The interface consists of data tables with platform related information, boot and runtime service calls that are available to the operating system and its loader. The following benefits are available when the **Boot Mode** is set to **UEFI**:
 - Support for drive partitions larger than 2 TB.
 - Enhanced security (e.g., UEFI Secure Boot).
 - Faster boot time.
- **BIOS:** The **BIOS Boot Mode** is the legacy boot mode. It is maintained for backward compatibility.

NOTE: You must use only the UEFI boot mode in order to boot from NVMe drives.

Identifier	GUID-1433BB4D-532E-4873-BA59-635D7AA90DE7
Status	Released

Viewing Boot Settings

To view the **Boot Settings** screen, perform the following steps:

Steps

1. Power on, or restart your system.
2. Press F2 immediately after you see the following message:

```
F2 = System Setup
```

NOTE: If your operating system begins to load before you press F2, wait for the system to finish booting, and then restart your system and try again.

3. On the **System Setup Main Menu** screen, click **System BIOS**.
4. On the **System BIOS** screen, click **Boot Settings**.



Identifier	GUID-4288B5CF-F132-4B56-9F29-3E795967FF20
Status	Released

Boot Settings details

About this task

The **Boot Settings** screen details are explained as follows:

Option	Description
Boot Mode	Enables you to set the boot mode of the system. <div style="display: flex; align-items: center;"> CAUTION: Switching the boot mode may prevent the system from booting if the operating system is not installed in the same boot mode. </div>

Option	Description
	<p>If the operating system supports UEFI, you can set this option to UEFI. Setting this field to BIOS enables compatibility with non-UEFI operating systems. This option is set to UEFI by default.</p> <p> NOTE: Setting this field to UEFI disables the BIOS Boot Settings menu.</p>
Boot Sequence Retry	Enables or disables the Boot Sequence Retry feature. If this option is set to Enabled and the system fails to boot, the system re-attempts the boot sequence after 30 seconds. This option is set to Enabled by default.
Hard-Disk Failover	Specifies the drive that is booted in the event of a drive failure. The devices are selected in the Hard-Disk Drive Sequence on the Boot Option Setting menu. When this option is set to Disabled , only the first drive in the list is attempted to boot. When this option is set to Enabled , all drives are attempted to boot in the order selected in the Hard-Disk Drive Sequence . This option is not enabled for UEFI Boot Mode . This option is set to Disabled by default.
Generic USB Boot	Enables or disables the USB boot option. This option is set to Disabled by default.
Hard-disk Drive Placeholder	Enables or disables the Hard-disk drive placeholder option. This option is set to Disabled by default.
BIOS Boot Settings	Enables or disables BIOS boot options.  NOTE: This option is enabled only if the boot mode is BIOS.
UEFI Boot Settings	Enables or disables UEFI Boot options. The Boot options include IPv4 PXE and IPv6 PXE . This option is set to IPv4 by default.  NOTE: This option is enabled only if the boot mode is UEFI.
UEFI Boot Sequence	Enables you to change the boot device order.
Boot Options Enable/Disable	Enables you to select the enabled or disabled boot devices.

Identifier	GUID-95595EDB-CAB5-4D81-86DD-282E9542F7B6
Status	Released

Choosing system boot mode

System Setup enables you to specify one of the following boot modes for installing your operating system:

- BIOS boot mode is the standard BIOS-level boot interface.
- UEFI boot mode (the default), is an enhanced 64-bit boot interface.

If you have configured your system to boot to UEFI mode, it replaces the system BIOS.

1. From the **System Setup Main Menu**, click **Boot Settings**, and select **Boot Mode**.
2. Select the UEFI boot mode you want the system to boot into.

 **CAUTION: Switching the boot mode may prevent the system from booting if the operating system is not installed in the same boot mode.**

3. After the system boots in the specified boot mode, proceed to install your operating system from that mode.

 **NOTE: Operating systems must be UEFI-compatible to be installed from the UEFI boot mode. DOS and 32-bit operating systems do not support UEFI and can only be installed from the BIOS boot mode.**

 **NOTE: For the latest information about supported operating systems, go to www.dell.com/ossupport.**

Identifier	GUID-07C7DF74-38AB-4C4D-9AA8-D93624C5158E
Status	Released

Changing boot order

About this task

You may have to change the boot order if you want to boot from a USB key or an optical drive. The following instructions may vary if you have selected **BIOS** for **Boot Mode**.

Steps

1. On the **System Setup Main Menu** screen, click **System BIOS** > **Boot Settings** > **UEFI/BIOS Boot Settings** > **UEFI/BIOS Boot Sequence**.
2. Click **Exit**, and then click **Yes** to save the settings on exit.

Identifier	GUID-CC167672-81D3-4B87-8CED-B74427962AD0
Status	Released

Network Settings

You can use the **Network Settings** screen to modify UEFI PXE, iSCSI, and HTTP boot settings. The network settings option is available only in the UEFI mode.

NOTE: BIOS does not control network settings in the BIOS mode. For the BIOS boot mode, the optional Boot ROM of the network controllers handles the network settings.

Identifier	GUID-C9080BAA-62B2-40DE-941F-5D939747475C
Status	Released

Viewing Network Settings

To view the **Network Settings** screen, perform the following steps:

Steps

1. Power on, or restart your system.
2. Press F2 immediately after you see the following message:

```
F2 = System Setup
```

NOTE: If your operating system begins to load before you press F2, wait for the system to finish booting, and then restart your system and try again.

3. On the **System Setup Main Menu** screen, click **System BIOS**.
4. On the **System BIOS** screen, click **Network Settings**.

Identifier	GUID-9C51DA51-981C-4A94-A060-BC107A2615A7
Status	Released

Network Settings screen details

The **Network Settings** screen details are explained as follows:

About this task

Option	Description				
UEFI PXE Settings	<table border="1"> <thead> <tr> <th>Options</th> <th>Description</th> </tr> </thead> <tbody> <tr> <td>PXE Device n (n = 1 to 4)</td> <td>Enables or disables the device. When enabled, a UEFI PXE boot option is created for the device.</td> </tr> </tbody> </table>	Options	Description	PXE Device n (n = 1 to 4)	Enables or disables the device. When enabled, a UEFI PXE boot option is created for the device.
Options	Description				
PXE Device n (n = 1 to 4)	Enables or disables the device. When enabled, a UEFI PXE boot option is created for the device.				

Option	Description				
UEFI HTTP Settings	<table border="1"> <thead> <tr> <th>Options</th> <th>Description</th> </tr> </thead> <tbody> <tr> <td>HTTP Device (n = 1 to 4)</td> <td>Enables or disables the device. When enabled, a UEFI HTTP boot option is created for the device.</td> </tr> </tbody> </table>	Options	Description	HTTP Device (n = 1 to 4)	Enables or disables the device. When enabled, a UEFI HTTP boot option is created for the device.
Options	Description				
HTTP Device (n = 1 to 4)	Enables or disables the device. When enabled, a UEFI HTTP boot option is created for the device.				
UEFI iSCSI Settings	Enables you to control the configuration of the iSCSI device.				

Table 38. UEFI iSCSI Settings screen details

Option	Description
iSCSI Initiator Name	Specifies the name of the iSCSI initiator in IQN format.
iSCSI Device1	Enables or disables the iSCSI device. When disabled, a UEFI boot option is created for the iSCSI device automatically. This is set to Disabled by default.
iSCSI Device1 Settings	Enables you to control the configuration of the iSCSI device.

Identifier	GUID-3CC949D0-B7BD-42E2-8875-91CB6983D1CF
Status	Released

Integrated Devices

You can use the **Integrated Devices** screen to view and configure the settings of all integrated devices including the video controller, integrated RAID controller, and the USB ports.

Identifier	GUID-CF42E884-BDCB-4730-8AB7-60CA078E4FCC
Status	Released

Viewing Integrated Devices

To view the **Integrated Devices** screen, perform the following steps:

Steps

1. Power on, or restart your system.
2. Press F2 immediately after you see the following message:

```
F2 = System Setup
```



NOTE: If your operating system begins to load before you press F2, wait for the system to finish booting, and then restart your system and try again.

3. On the **System Setup Main Menu** screen, click **System BIOS**.
4. On the **System BIOS** screen, click **Integrated Devices**.



Identifier	GUID-23E470F9-16B1-4A77-A17E-637BFC3BA641
Status	Released

Integrated Devices details

About this task

The **Integrated Devices** screen details are explained as follows:

Option	Description
User Accessible USB Ports	<p>Configures the user accessible USB ports. Selecting Only Back Ports On disables the front USB ports; selecting All Ports Off disables all front and back USB ports.</p> <p>The USB keyboard and mouse still function in certain USB ports during the boot process, depending on the selection. After the boot process is complete, the USB ports will be enabled or disabled as per the setting.</p>
Internal USB Port	Enables or disables the internal USB port. This option is set to On or Off . This option is set to On by default.

Option	Description
	<p> NOTE: The Internal SD Card Port on the PCIe riser is controlled by Internal USB Port.</p>
iDRAC Direct USB Port	The iDRAC Direct USB port is managed by iDRAC exclusively with no host visibility. This option is set to ON or OFF . When set to OFF , iDRAC does not detect any USB devices installed in this managed port. This option is set to On by default.
Integrated RAID Controller	Enables or disables the integrated RAID controller. This option is set to Enabled by default.
Embedded NIC1 and NIC2	<p> NOTE: The Embedded NIC1 and NIC2 options are only available on systems that do not have Integrated Network Card 1.</p> <p>Enables or disables the Embedded NIC1 and NIC2 options. If set to Disabled, the NIC may still be available for shared network access by the embedded management controller. The embedded NIC1 and NIC2 options are only available on systems that do not have Network Daughter Cards (NDCs). The Embedded NIC1 and NIC2 option is mutually exclusive with the Integrated Network Card 1 option. Configure the Embedded NIC1 and NIC2 option by using the NIC management utilities of the system.</p>
I/OAT DMA Engine	Enables or disables the I/O Acceleration Technology (I/OAT) option. I/OAT is a set of DMA features designed to accelerate network traffic and lower CPU utilization. Enable only if the hardware and software support the feature. This option is set to Disabled by default.
Embedded Video Controller	<p>Enables or disables the use of Embedded Video Controller as the primary display. When set to Enabled, the Embedded Video Controller is used as the primary display even if add-in graphic cards are installed. When set to Disabled, an add-in graphics card is used as the primary display. BIOS will output displays to both the primary add-in video and the embedded video during POST and pre-boot environment. The embedded video is disabled before the operating system boots. This option is set to Enabled by default.</p> <p> NOTE: When there are multiple add-in graphic cards installed in the system, the first card discovered during PCI enumeration is selected as the primary video. You might have to re-arrange the cards in the slots in order to control which card is the primary video.</p>
Current State of Embedded Video Controller	Displays the current state of the embedded video controller. The Current State of Embedded Video Controller option is a read-only field. If the Embedded Video Controller is the only display capability in the system (that is, no add-in graphics card is installed), then the Embedded Video Controller is automatically used as the primary display even if the Embedded Video Controller setting is set to Disabled .
SR-IOV Global Enable	Enables or disables the BIOS configuration of Single Root I/O Virtualization (SR-IOV) devices. This option is set to Disabled by default.
Internal SD Card Port	Enables or disables the internal SD card port of the Internal Dual SD Module (IDSMD). This option is set to On by default.
Internal SD Card Redundancy	<p>Configures the redundancy mode of the Internal Dual SD Module (IDSMD). When set to Mirror Mode, data is written on both SD cards. After failure of either card and replacement of the failed card, the data of the active card is copied to the offline card during the system boot.</p> <p>When Internal SD Card Redundancy is set to Disabled, only the primary SD card is visible to the OS. This option is set to Disabled by default.</p>
Internal SD Primary Card	By default, the primary SD card is selected to be SD Card 1. If SD Card 1 is not present, then the controller selects SD Card 2 to be the primary SD card.
OS Watchdog Timer	If your system stops responding, this watchdog timer aids in the recovery of your operating system. When this option is set to Enabled , the operating system initializes the timer. When this option is set to Disabled (the default), the timer does not have any effect on the system.
Empty Slot Unhide	Enables or disables the root ports of all the empty slots that are accessible to the BIOS and OS. This option is set to Disabled by default.
Memory Mapped I/O above 4 GB	Enables or disables the support for the PCIe devices that need large amounts of memory. Enable this option only for 64-bit operating systems. This option is set to Enabled by default.
Memory Mapped I/O Base	When set to 12 TB , the system maps the MMIO base to 12 TB. Enable this option for an OS that requires 44 bit PCIe addressing. When set to 512 GB , the system maps the MMIO base to 512 GB, and reduces the maximum support for memory to less than 512 GB. Enable this option only for the 4 GPU DGMA issue. This option is set to 56 TB by default.

Option	Description
Slot Disablement	Enables or disables the available PCIe slots on your system. The slot disablement feature controls the configuration of the PCIe cards installed in the specified slot. Slots must be disabled only when the installed peripheral card prevents booting into the operating system or causes delays in system startup. If the slot is disabled, both the Option ROM and UEFI drivers are disabled. Only slots that are present on the system are available for control.

Table 39. Slot Disablement

Option	Description
Slot 1	Enables or disables or only the boot driver is disabled for the PCIe slot 1. This option is set to Enabled by default.
Slot 2	Enables or disables or only the boot driver is disabled for the PCIe slot 2. This option is set to Enabled by default.
Slot 3	Enables or disables or only the boot driver is disabled for the PCIe slot 3. This option is set to Enabled by default.
Slot 4	Enables or disables or only the boot driver is disabled for the PCIe slot 4. This option is set to Enabled by default.
Slot 5	Enables or disables or only the boot driver is disabled for the PCIe slot 5. This option is set to Enabled by default.
Slot 6	Enables or disables or only the boot driver is disabled for the PCIe slot 6. This option is set to Enabled by default.

Slot Bifurcation	Allows Platform Default Bifurcation , Auto Discovery of Bifurcation and Manual Bifurcation Control . The default is set to Platform Default Bifurcation . The slot bifurcation field is accessible when set to Manual Bifurcation Control and is disabled when set to Platform Default Bifurcation or Auto Discovery of Bifurcation .
-------------------------	--

Table 40. Slot Bifurcation

Option	Description
Auto Discovery Bifurcation Settings	Platform Default Bifurcation , Auto Bifurcation, and Manual bifurcation
Slot 2 Bifurcation	x4 or x8 Bifurcation
Slot 3 Bifurcation	x4 or x8 Bifurcation
Slot 5 Bifurcation	x4 Bifurcation
Slot 6 Bifurcation	x4 Bifurcation

Identifier	GUID-8D06E915-1110-489C-8985-45419AE5C99A
Status	Released

Serial Communication

You can use the **Serial Communication** screen to view the properties of the serial communication port.

Identifier	GUID-86BA3A37-3D8F-4D6F-A11C-4DA28D0D90D3
Status	Released

Viewing Serial Communication

To view the **Serial Communication** screen, perform the following steps:

Steps

1. Power on, or restart your system.
2. Press F2 immediately after you see the following message:

```
F2 = System Setup
```

NOTE: If your operating system begins to load before you press F2, wait for the system to finish booting, and then restart your system and try again.

3. On the **System Setup Main Menu** screen, click **System BIOS**.
4. On the **System BIOS** screen, click **Serial Communication**.

Identifier	GUID-E0779196-FA22-4268-8E8C-E3EBB586897D
Status	Released

Serial Communication details

About this task

The **Serial Communication** screen details are explained as follows:

Option	Description
Serial Communication	<p>Enables you to select serial communication devices (Serial Device 1 and Serial Device 2) in BIOS. BIOS console redirection can also be enabled, and the port address can be specified. This option is set to Auto by default.</p>
Serial Port Address	<p>Enables you to set the port address for serial device. This field sets the serial port address to either COM1 or COM2 (COM1=0x3F8, COM2=0x2F8). This option is set to Serial Device1=COM2 or Serial Device 2=COM1 by default.</p> <p>NOTE: You can use only Serial Device 2 for the Serial Over LAN (SOL) feature. To use console redirection by SOL, configure the same port address for console redirection and the serial device.</p> <p>NOTE: Every time the system boots, the BIOS syncs the serial MUX setting saved in iDRAC. The serial MUX setting can independently be changed in iDRAC. Loading the BIOS default settings from within the BIOS setup utility may not always revert the serial MUX setting to the default setting of Serial Device 1.</p>
External Serial Connector	<p>Enables you to associate the External Serial Connector to Serial Device 1, Serial Device 2, or the Remote Access Device by using this option. This option is set to Serial Device 1 by default.</p> <p>NOTE: Only Serial Device 2 can be used for Serial Over LAN (SOL). To use console redirection by SOL, configure the same port address for console redirection and the serial device.</p> <p>NOTE: Every time the system boots, the BIOS syncs the serial MUX setting saved in iDRAC. The serial MUX setting can independently be changed in iDRAC. Loading the BIOS default settings from within the BIOS setup utility may not always revert this setting to the default setting of Serial Device 1.</p>
Failsafe Baud Rate	<p>Specifies the failsafe baud rate for console redirection. The BIOS attempts to determine the baud rate automatically. This failsafe baud rate is used only if the attempt fails, and the value must not be changed. This option is set to 115200 by default.</p>

Option	Description
Remote Terminal Type	Enables you to set the remote console terminal type. This option is set to VT100/VT220 by default.
Redirection After Boot	Enables or disables the BIOS console redirection when the operating system is loaded. This option is set to Enabled by default.

Identifier	GUID-E16FB291-2D50-435C-A986-6B7364F1C26C
Status	Released

System Profile Settings

You can use the **System Profile Settings** screen to enable specific system performance settings such as power management.

Identifier	GUID-4F8DAFA5-E5A9-4078-A782-D2D2051D546D
Status	Released

Viewing System Profile Settings

To view the **System Profile Settings** screen, perform the following steps:

Steps

1. Power on, or restart your system.
2. Press F2 immediately after you see the following message:

```
F2 = System Setup
```

NOTE: If your operating system begins to load before you press F2, wait for the system to finish booting, and then restart your system and try again.

3. On the **System Setup Main Menu** screen, click **System BIOS**.
4. On the **System BIOS** screen, click **System Profile Settings**.

Identifier	GUID-F2409FCF-E00D-4510-9012-200658384CFD
Status	Released

System Profile Settings details

About this task

The **System Profile Settings** screen details are explained as follows:

Option	Description
System Profile	Sets the system profile. If you set the System Profile option to a mode other than Custom , the BIOS automatically sets the rest of the options. You can only change the rest of the options if the mode is set to Custom . This option is set to Performance Per Watt Optimized (DAPC) by default. DAPC is Dell Active Power Controller. Other options include Performance Per Watt (OS) , Performance , and Workstation Performance . NOTE: All the parameters on the system profile setting screen are available only when the System Profile option is set to Custom.
CPU Power Management	Sets the CPU power management. This option is set to System DBPM (DAPC) by default. DBPM is Demand-Based Power Management. Other options include OS DBPM , and Maximum Performance .
Memory Frequency	Sets the speed of the system memory. You can select Maximum Performance , Maximum Reliability , or a specific speed. This option is set to Maximum Performance by default.
Turbo Boost	Enables or disables the processor to operate in the turbo boost mode. This option is set to Enabled by default.
C1E	Enables or disables the processor to switch to a minimum performance state when it is idle. This option is set to Enabled by default.
C States	Enables or disables the processor to operate in all available power states. This option is set to Enabled by default.
Write Data CRC	Enables or disables the Write Data CRC. This option is set to Disabled by default.

Option	Description
Memory Patrol Scrub	Sets the memory patrol scrub frequency. This option is set to Standard by default.
Memory Refresh Rate	Sets the memory refresh rate to either 1x or 2x. This option is set to 1x by default.
Uncore Frequency	Enables you to select the Processor Uncore Frequency option. Dynamic mode enables the processor to optimize power resources across cores and uncores during runtime. The optimization of the uncore frequency to either save power or optimize performance is influenced by the setting of the Energy Efficiency Policy option.
Energy Efficient Policy	Enables you to select the Energy Efficient Policy option. The CPU uses the setting to manipulate the internal behavior of the processor and determines whether to target higher performance or better power savings. This option is set to Balanced Performance by default.
Number of Turbo Boost Enabled Cores for Processor 1	<p>NOTE: If there are two processors installed in the system, you will see an entry for Number of Turbo Boost Enabled Cores for Processor 2.</p> <p>Controls the number of turbo boost enabled cores for Processor 1. The maximum number of cores is enabled by default.</p>
Monitor/Mwait	<p>Enables the Monitor/Mwait instructions in the processor. This option is set to Enabled for all system profiles, except Custom by default.</p> <p>NOTE: This option can be disabled only if the C States option in the Custom mode is set to disabled.</p> <p>NOTE: When C States is set to Enabled in the Custom mode, changing the Monitor/Mwait setting does not impact the system power or performance.</p>
CPU Interconnect Bus Link Power Management	Enables or disables the CPU Interconnect Bus Link Power Management. This option is set to Enabled by default.
PCI ASPM L1 Link Power Management	Enables or disables the PCI ASPM L1 Link Power Management. This option is set to Enabled by default.

Identifier	GUID-74D436C0-8345-4F55-B0B9-274B8A9F2FBF
Status	Released

System Security

You can use the **System Security** screen to perform specific functions such as setting the system password, setup password and disabling the power button.

Identifier	GUID-672C66C8-33C6-4BE4-A055-33A23A15FB93
Status	Released

Viewing System Security

To view the **System Security** screen, perform the following steps:

Steps

1. Power on, or restart your system.
2. Press F2 immediately after you see the following message:

F2 = System Setup

NOTE: If your operating system begins to load before you press F2, wait for the system to finish booting, and then restart your system and try again.

3. On the **System Setup Main Menu** screen, click **System BIOS**.
4. On the **System BIOS** screen, click **System Security**.

System Security Settings details

About this task

The **System Security Settings** screen details are explained as follows:

Option	Description
CPU AES-NI	Improves the speed of applications by performing encryption and decryption by using the Advanced Encryption Standard Instruction Set (AES-NI). This option is set to Enabled by default.
System Password	Enables you to set the system password. This option is set to Enabled by default and is read-only if the password jumper is not installed in the system.
Setup Password	Enables you to set the system setup password. This option is read-only if the password jumper is not installed in the system.
Password Status	Enables you to lock the system password. This option is set to Unlocked by default.
TPM Security	<p> NOTE: The TPM menu is available only when the TPM module is installed.</p>

Enables you to control the reporting mode of the TPM. The **TPM Security** option is set to **Off** by default. You can only modify the TPM Status TPM Activation, and the Intel TXT fields if the **TPM Status** field is set to either **On with Pre-boot Measurements** or **On without Pre-boot Measurements**.

When TPM 1.2 is installed, the **TPM Security** option is set to **Off**, **On with Pre-boot Measurements**, or **On without Pre-boot Measurements**.

Table 41. TPM 1.2 security information

Option	Description
TPM Information	Changes the operational state of the TPM. This option is set to No Change by default.
TPM Firmware	Indicates the firmware version of the TPM.
TPM Status	Specifies the TPM status.
TPM Command	Controls the Trusted Platform Module (TPM). When set to None , no command is sent to the TPM. When set to Activate , the TPM is enabled and activated. When set to Deactivate , the TPM is disabled and deactivated. When set to Clear , all the contents of the TPM are cleared. This option is set to None by default.

When TPM 2.0 is installed, the **TPM Security** option is set to **On** or **Off**. This option is set to **Off** by default.

Table 42. TPM 2.0 security information

Option	Description
TPM Information	Changes the operational state of the TPM. This option is set to No Change by default.
TPM Firmware	Indicates the firmware version of the TPM.
TPM Hierarchy	<p>Enable, disable, or clear the storage and endorsement hierarchies. When set to Enabled, the storage and endorsement hierarchies can be used.</p> <p>When set to Disabled, the storage and endorsement hierarchies cannot be used.</p> <p>When set to Clear, the storage and endorsement hierarchies are cleared of any values, and then reset to Enabled.</p>

Option	Description						
TPM Advanced Settings	This setting is enabled only when TPM Security is set to ON.						
Table 43. TPM Advanced Settings Details							
Option	Description						
TPM PPI Bypass Provision	When set to Enabled allows the Operating System to bypass Physical Presence Interface (PPI).						
TPM PPI Bypass Clear	When set to Enabled allows the Operating System to bypass Physical Presence Interface (PPI).						
Intel(R) TXT	<p>Enables you to set the Intel Trusted Execution Technology (TXT) option. To enable the Intel TXT option, virtualization technology and TPM Security must be enabled with Pre-boot measurements. This option is set to Off by default.</p> <p>When TPM 2.0 is installed, TPM 2 Algorithm option is available. It enables you to select a hash algorithm from those supported by the TPM (SHA1, SHA256). TPM 2 Algorithm option must be set to SHA256, to enable TXT.</p>						
Power Button	Enables you to set the power button on the front of the system. This option is set to Enabled by default.						
AC Power Recovery	Sets how the system behaves after AC power is restored to the system. This option is set to Last by default.						
AC Power Recovery Delay	Enables you to set the time that the system should take to power up after AC power is restored to the system. This option is set to Immediate by default.						
User Defined Delay (60 s to 600 s)	Enables you to set the User Defined Delay option when the User Defined option for AC Power Recovery is selected.						
UEFI Variable Access	Provides varying degrees of securing UEFI variables. When set to Standard (the default), UEFI variables are accessible in the operating system per the UEFI specification. When set to Controlled , selected UEFI variables are protected in the environment, and new UEFI boot entries are forced to be at the end of the current boot order.						
In-Band Manageability Interface	<p>When set to Disabled, this setting will hide the Management Engine's (ME), HECI devices, and the system's IPMI devices from the operating system. This prevents the operating system from changing the ME power capping settings, and blocks access to all in-band management tools. All management should be managed through out-of-band. This option is set to Enabled by default.</p> <p>NOTE: BIOS update requires HECI devices to be operational and DUP updates require IPMI interface to be operational. This setting needs to be set to Enabled to avoid updating errors.</p>						
Secure Boot	Enables Secure Boot, where the BIOS authenticates each pre-boot image by using the certificates in the Secure Boot Policy. Secure Boot is set to Disabled by default.						
Secure Boot Policy	When Secure Boot policy is set to Standard , the BIOS uses the system manufacturer key and certificates to authenticate pre-boot images. When Secure Boot policy is set to Custom , the BIOS uses the user-defined key and certificates. Secure Boot policy is set to Standard by default.						
Secure Boot Mode	<p>Enables you to configure how the BIOS uses the Secure Boot Policy Objects (PK, KEK, db, dbx).</p> <p>If the current mode is set to Deployed Mode, the available options are User Mode and Deployed Mode. If the current mode is set to User Mode, the available options are User Mode, Audit Mode, and Deployed Mode.</p> <table border="1"> <thead> <tr> <th>Options</th> <th>Description</th> </tr> </thead> <tbody> <tr> <td>User Mode</td> <td> <p>In User Mode, PK must be installed, and BIOS performs signature verification on programmatic attempts to update policy objects.</p> <p>BIOS allows unauthenticated programmatic transitions between modes.</p> </td> </tr> <tr> <td>Audit Mode</td> <td> <p>In Audit mode, PK is not present. BIOS does not authenticate programmatic updates to the policy objects, and transitions between modes.</p> <p>Audit Mode is useful for programmatically determining a working set of policy objects.</p> </td> </tr> </tbody> </table>	Options	Description	User Mode	<p>In User Mode, PK must be installed, and BIOS performs signature verification on programmatic attempts to update policy objects.</p> <p>BIOS allows unauthenticated programmatic transitions between modes.</p>	Audit Mode	<p>In Audit mode, PK is not present. BIOS does not authenticate programmatic updates to the policy objects, and transitions between modes.</p> <p>Audit Mode is useful for programmatically determining a working set of policy objects.</p>
Options	Description						
User Mode	<p>In User Mode, PK must be installed, and BIOS performs signature verification on programmatic attempts to update policy objects.</p> <p>BIOS allows unauthenticated programmatic transitions between modes.</p>						
Audit Mode	<p>In Audit mode, PK is not present. BIOS does not authenticate programmatic updates to the policy objects, and transitions between modes.</p> <p>Audit Mode is useful for programmatically determining a working set of policy objects.</p>						

Option	Description						
	<table border="1"> <thead> <tr> <th>Options</th> <th>Description</th> </tr> </thead> <tbody> <tr> <td></td> <td>BIOS performs signature verification on pre-boot images and logs the results in the image Execution Information Table, but approves the images whether they pass or fail verification.</td> </tr> <tr> <td>Deployed Mode</td> <td> <p>Deployed Mode is the most secure mode. In Deployed Mode, PK must be installed and the BIOS performs signature verification on programmatic attempts to update policy objects.</p> <p>Deployed Mode restricts the programmatic mode transitions.</p> </td> </tr> </tbody> </table>	Options	Description		BIOS performs signature verification on pre-boot images and logs the results in the image Execution Information Table, but approves the images whether they pass or fail verification.	Deployed Mode	<p>Deployed Mode is the most secure mode. In Deployed Mode, PK must be installed and the BIOS performs signature verification on programmatic attempts to update policy objects.</p> <p>Deployed Mode restricts the programmatic mode transitions.</p>
Options	Description						
	BIOS performs signature verification on pre-boot images and logs the results in the image Execution Information Table, but approves the images whether they pass or fail verification.						
Deployed Mode	<p>Deployed Mode is the most secure mode. In Deployed Mode, PK must be installed and the BIOS performs signature verification on programmatic attempts to update policy objects.</p> <p>Deployed Mode restricts the programmatic mode transitions.</p>						
Secure Boot Policy Summary	Specifies the list of certificates and hashes that secure boot uses to authenticate images.						
Secure Boot Custom Policy Settings	Configures the Secure Boot Custom Policy. To enable this option, set the Secure Boot Policy to Custom .						

Identifier	GUID-984D6DD1-69C0-4BED-8926-E98CE36EB826
Status	Released

Creating a system and setup password

Prerequisites

Ensure that the password jumper is enabled. The password jumper enables or disables the system password and setup password features. For more information, see the System board jumper settings section.

NOTE: If the password jumper setting is disabled, the existing system password and setup password are deleted and you need not provide the system password to boot the system.

Steps

1. To enter System Setup, press F2 immediately after turning on or rebooting your system.
2. On the **System Setup Main Menu** screen, click **System BIOS > System Security**.
3. On the **System Security** screen, verify that **Password Status** is set to **Unlocked**.
4. In the **System Password** field, type your system password, and press Enter or Tab.

Use the following guidelines to assign the system password:

- A password can have up to 32 characters.
- The password can contain the numbers 0 through 9.

A message prompts you to reenter the system password.

5. Reenter the system password, and click **OK**.
6. In the **Setup Password** field, type your setup password and press Enter or Tab. A message prompts you to reenter the setup password.
7. Reenter the setup password, and click **OK**.
8. Press Esc to return to the System BIOS screen. Press Esc again.

A message prompts you to save the changes.

NOTE: Password protection does not take effect until the system reboots.

Identifier	GUID-1D68A622-09C9-4741-849C-78791F7F485A
Status	Released

Using your system password to secure the system

About this task

If you have assigned a setup password, the system accepts your setup password as an alternate system password.

Steps

1. Power on or reboot your system.
2. Type the system password and press Enter.

Next steps

When **Password Status** is set to **Locked**, type the system password and press Enter when prompted at reboot.

NOTE: If an incorrect system password is typed, the system displays a message and prompts you to reenter your password. You have three attempts to type the correct password. After the third unsuccessful attempt, the system displays an error message that the system has stopped functioning and must be turned off. Even after you turn off and restart the system, the error message is displayed until the correct password is entered.

Identifier	GUID-EFB53C42-EDA6-42AA-8795-227BAF55DCC3
Status	Released

Deleting or changing system and setup password

Prerequisites

NOTE: You cannot delete or change an existing system or setup password if the Password Status is set to Locked.

Steps

1. To enter System Setup, press F2 immediately after turning on or restarting your system.
2. On the **System Setup Main Menu** screen, click **System BIOS > System Security**.
3. On the **System Security** screen, ensure that **Password Status** is set to **Unlocked**.
4. In the **System Password** field, change or delete the existing system password, and then press Enter or Tab.
5. In the **Setup Password** field, alter or delete the existing setup password, and then press Enter or Tab.
6. Press Esc to return to the **System BIOS** screen. Press Esc again, and a message prompts you to save the changes.
7. Select **Setup Password**, change, or delete the existing setup password and press Enter or Tab.

NOTE: If you change the system password or setup password, a message prompts you to reenter the new password. If you delete the system password or setup password, a message prompts you to confirm the deletion.

NOTE: If you change the system password or setup password, a message prompts you to reenter the new password. If you delete the system password or setup password, a message prompts you to confirm the deletion.

Identifier	GUID-54E6215C-94A0-4E6C-AA8F-D273EDA723B1
Status	Released

Operating with setup password enabled

If **Setup Password** is set to **Enabled**, type the correct setup password before modifying the system setup options.

If you do not type the correct password in three attempts, the system displays the following message:

```
Number of unsuccessful password attempts: <3> Maximum number of password attempts exceeded.
System Halted!
```

Even after you restart the system, the error message is displayed until the correct password is typed. The following options are exceptions:

- If **System Password** is not set to **Enabled** and is not locked through the **Password Status** option, you can assign a system password. For more information, see the [System Security Settings details](#) section.
- You cannot disable or change an existing system password.

NOTE: You can use the password status option with the setup password option to protect the system password from unauthorized changes.

Identifier	GUID-0177BFF2-C212-4670-AA15-723F85ACD9EC
Status	Released

Redundant OS Control

In the **Redundant OS Control** screen you can set the redundant OS information. This enables you to set up a physical recovery disk on the system.

Identifier	GUID-855936E4-232B-4BD9-8542-F43B58840E52
Status	Released

Viewing Redundant OS Control

To view the **Redundant OS Control** screen, perform the following steps:

Steps

1. Power on, or restart your system.
2. Press F2 immediately after you see the following message:

```
F2 = System Setup
```

NOTE: If your operating system begins to load before you press F2, wait for the system to finish booting, and then restart your system and try again.

3. On the **System Setup Main Menu** screen, click **System BIOS**.
4. On the **System BIOS** screen, click **Redundant OS Control**.

Identifier	GUID-B991B96F-3166-4AA6-B182-A5658A2556C1
Status	Released

Redundant OS Control screen details

The **Redundant OS Control** screen details are explained as follows:

About this task

Option	Description
Redundant OS Location	<p>Enables you to select a backup disk from the following devices:</p> <ul style="list-style-type: none"> • None • IDSDM • SATA Ports in AHCI mode • BOSS PCIe Cards (Internal M.2 Drives) • Internal USB <p>NOTE: RAID configurations and NVMe cards not are included as BIOS does not have the ability to distinguish between individual drives in those configurations.</p>
Redundant OS State	<p>NOTE: This option is disabled if Redundant OS Location is set to None.</p> <p>When set to Visible, the backup disk is visible to the boot list and OS. When set to Hidden, the backup disk is disabled and is not visible to the boot list and OS. This option is set to Visible by default.</p> <p>NOTE: BIOS will disable the device in hardware, so it cannot be accessed by the OS.</p>
Redundant OS Boot	<p>NOTE: This option is disabled if Redundant OS Location is set to None or if Redundant OS State is set to Hidden.</p> <p>When set to Enabled, BIOS boots to the device specified in Redundant OS Location. When set to Disabled, BIOS preserves the current boot list settings. This option is set to Disabled by default.</p>

Identifier	GUID-D2600F98-5F49-4C50-BAE6-9F333D6F8677
Status	Released

Miscellaneous Settings

You can use the **Miscellaneous Settings** screen to perform specific functions such as updating the asset tag and changing the system date and time.

Identifier	GUID-EFE6B2BF-F8DD-48AB-BF1A-1030644C9809
Status	Released

Viewing Miscellaneous Settings

To view the **Miscellaneous Settings** screen, perform the following steps:

Steps

1. Power on, or restart your system.
2. Press F2 immediately after you see the following message:

```
F2 = System Setup
```

NOTE: If your operating system begins to load before you press F2, wait for the system to finish booting, and then restart your system and try again.

3. On the **System Setup Main Menu** screen, click **System BIOS**.
4. On the **System BIOS** screen, click **Miscellaneous Settings**.

Identifier	GUID-5178EE7D-9F95-47E1-9E25-0448E7E6029A
Status	Released

Miscellaneous Settings details

About this task

The **Miscellaneous Settings** screen details are explained as follows:

Option	Description
System Time	Enables you to set the time on the system.
System Date	Enables you to set the date on the system.
Asset Tag	Specifies the asset tag and enables you to modify it for security and tracking purposes.
Keyboard NumLock	Enables you to set whether the system should boot with the NumLock enabled or disabled. This option is set to On by default. NOTE: This option does not apply to 84-key keyboards.
F1/F2 Prompt on Error	Enables or disables the F1/F2 prompt on error. This option is set to Enabled by default. The F1/F2 prompt also includes keyboard errors.
Load Legacy Video Option ROM	Enables you to determine whether the system BIOS loads the legacy video (INT 10H) option ROM from the video controller. Selecting Enabled in the operating system does not support UEFI video output standards. This field is available only for UEFI boot mode. You cannot set the option to Enabled if UEFI Secure Boot mode is enabled. This option is set to Disabled by default.
Dell Wyse P25/P45 BIOS Access	Enables or disables the Dell Wyse P25/P45 BIOS Access. This option is set to Enabled by default.
Power Cycle Request	Enables or disables the Power Cycle Request. This option is set to None by default.

Identifier	GUID-2D2F7DBD-0B3E-4B1A-8503-75D18E836955
Status	Released

iDRAC Settings utility

The iDRAC settings utility is an interface to set up and configure the iDRAC parameters by using UEFI. You can enable or disable various iDRAC parameters by using the iDRAC settings utility.

NOTE: Accessing some of the features on the iDRAC settings utility needs the iDRAC Enterprise License upgrade.

For more information about using iDRAC, see *Dell Integrated Dell Remote Access Controller User's Guide* at www.dell.com/poweredge/manuals.

Identifier	GUID-40773DA2-58EA-404E-BD8D-A0308E12A989
Status	Released

Device Settings

Device Settings enables you to configure the below device parameters:

- Controller Configuration Utility
- Embedded NIC Port1-X Configuration
- NICs in slotX, Port1-X Configuration
- BOSS Card configuration

Identifier	GUID-D1FF20AF-4F7C-4D18-874E-7BD41E141760
Status	Released

Dell Lifecycle Controller

Dell Lifecycle Controller (LC) provides advanced embedded systems management capabilities including system deployment, configuration, update, maintenance, and diagnosis. LC is delivered as part of the iDRAC out-of-band solution and Dell system embedded Unified Extensible Firmware Interface (UEFI) applications.

Identifier	GUID-882886FC-ADCC-414B-803E-E932F55D562B
Status	Released

Embedded system management

The Dell Lifecycle Controller provides advanced embedded system management throughout the lifecycle of the system. The Dell Lifecycle Controller can be started during the boot sequence and can function independently of the operating system.

NOTE: Certain platform configurations may not support the full set of features provided by the Dell Lifecycle Controller.

For more information about setting up the Dell Lifecycle Controller, configuring hardware and firmware, and deploying the operating system, see the Dell Lifecycle Controller documentation at www.dell.com/poweredge/manuals.

Identifier	GUID-301C8F19-9D4C-414E-B450-92A98C78C965
Status	Released

Boot Manager

The **Boot Manager** screen enables you to select boot options and diagnostic utilities.

Identifier	GUID-27C038B5-7632-468E-A9FC-A67BBFEEAAD8
Status	Released

Viewing Boot Manager

About this task

To enter Boot Manager:

Steps

1. Power on, or restart your system.
2. Press F11 when you see the following message:

F11 = Boot Manager

If your operating system begins to load before you press F11, allow the system to complete the booting, and then restart your system and try again.

Identifier	GUID-9B375692-1330-4E9A-A007-6535C90919CD
Status	Released

Boot Manager main menu

Menu item	Description
Continue Normal Boot	The system attempts to boot to devices starting with the first item in the boot order. If the boot attempt fails, the system continues with the next item in the boot order until the boot is successful or no more boot options are found.
One-shot Boot Menu	Enables you to access boot menu, where you can select a one-time boot device to boot from.
Launch System Setup	Enables you to access System Setup.
Launch Lifecycle Controller	Exits the Boot Manager and invokes the Dell Lifecycle Controller program.
System Utilities	Enables you to launch System Utilities menu such as System Diagnostics.

Identifier	GUID-6831C705-6DBC-4C2C-A1B6-B697BA34D15F
Status	Released

One-shot UEFI boot menu

One-shot UEFI boot menu enables you to select a boot device to boot from.

Identifier	GUID-60273432-69F8-478E-A414-DE59FBD04EC8
Status	Released

System Utilities

System Utilities contains the following utilities that can be launched:

- Launch Diagnostics
- BIOS Update File Explorer
- Reboot System

Identifier	GUID-C6D96AEE-4A28-4152-A5F6-7F9306DA0CB9
Status	Released

PXE boot

You can use the Preboot Execution Environment (PXE) option to boot and configure the networked systems, remotely.







To access the **PXE boot** option, boot the system and then press F12 during POST instead of using standard Boot Sequence from BIOS Setup. It does not pull any menu or allows managing of network devices.

Identifier	GUID-1E7AB119-C26B-4FF2-A18D-D03BFFB0795A
Status	Released

Installing and removing system components

Identifier	GUID-AF9B4B15-E3A6-479C-89EF-6BD35203ABD3
Status	Released

Safety instructions

-  **NOTE:** Whenever you need to lift the system, get others to assist you. To avoid injury, do not attempt to lift the system by yourself.
-  **WARNING:** Opening or removing the system cover while the system is powered on may expose you to a risk of electric shock.
-  **CAUTION:** Do not operate the system without the cover for a duration exceeding five minutes. Operating the system without the system cover can result in component damage.
-  **CAUTION:** Many repairs may only be done by a certified service technician. You should only perform troubleshooting and simple repairs as authorized in your product documentation, or as directed by the online or telephone service and support team. Damage due to servicing that is not authorized by Dell is not covered by your warranty. Read and follow the safety instructions that are shipped with your product.
-  **NOTE:** It is recommended that you always use an antistatic mat and antistatic strap while working on components inside the system.
-  **CAUTION:** To ensure proper operation and cooling, all bays in the system and system fans must be always populated with a component or a blank.

Identifier	GUID-054A41FE-EC01-4C46-ABBE-DD94746BEC7D
Status	Released

Before working inside your system

Prerequisites

Follow the safety guidelines listed in [Safety instructions](#).

Steps

1. Turn off the system, including all attached peripherals.
2. Disconnect the system from the electrical outlet and disconnect the peripherals.

Identifier	GUID-28CB125E-1484-4061-98B3-B40522E3CEED
Status	Released

After working inside your system

Prerequisites

Follow the safety guidelines listed in [Safety instructions](#).

Steps

1. Reconnect the peripherals and connect the system to the electrical outlet.

2. Turn on the attached peripherals and then turn on the system.

Identifier	GUID-41B35D64-30B4-40A6-9381-24EDA7AD4571
Status	Released

Recommended tools

You need the following tools to perform the removal and installation procedures:

- Key to the bezel lock
The key is required only if your system includes a bezel.
- Phillips #1 screwdriver
- Phillips #2 screwdriver
- Torx #T30 screwdriver
- Torx #T8 screwdriver
- Wrist grounding strap

You need the following tools to assemble the cables for a DC power supply unit:

- AMP 90871-1 hand-crimping tool or equivalent
- Tyco Electronics 58433-3 or equivalent
- Wire-stripper pliers to remove insulation from size 10 AWG solid or stranded, insulated copper wire

 **NOTE:** Use alpha wire part number 3080 or equivalent (65/30 stranding).

Identifier	GUID-9F1802AE-E54B-406C-A7DD-058C069238F5
Status	Released

Optional front bezel

 **NOTE:** The procedure to remove the front bezel with and without the LCD panel is the same.

Identifier	GUID-A1E67D53-ECAD-41CD-8C27-E974E97304D8
Status	Released

Removing the front bezel

Prerequisites

Follow the safety guidelines listed in [Safety instructions](#).

Steps

1. Unlock the bezel by using the bezel key.
2. Press the release button, and pull the left end of the bezel.
3. Unhook the right end, and remove the bezel.

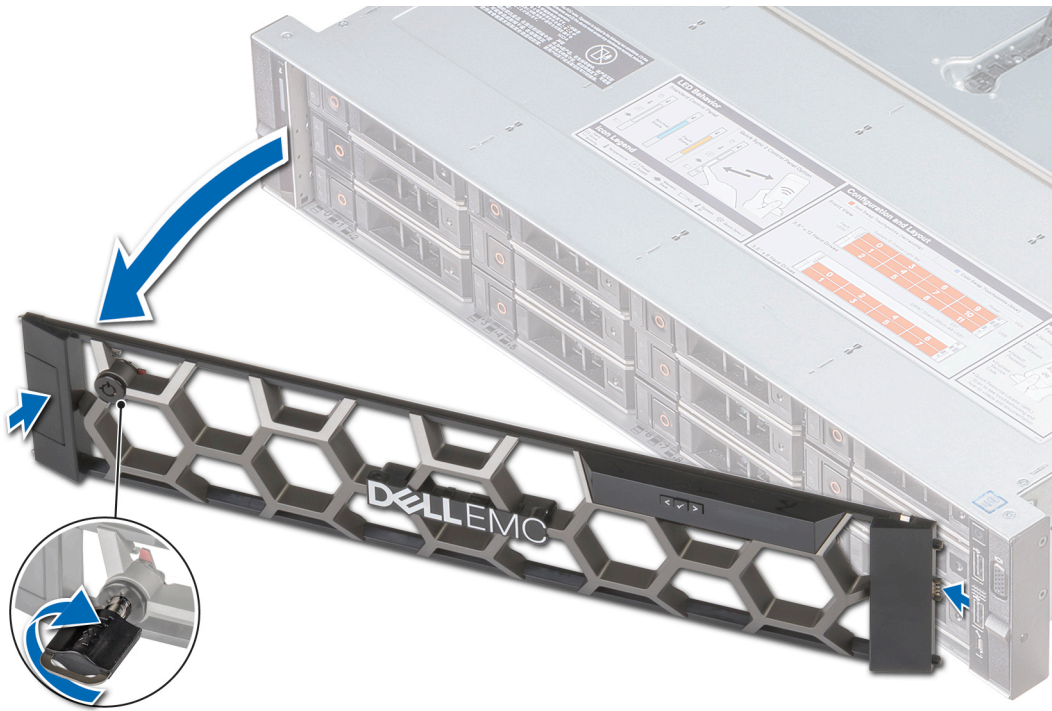

Figure 23. Removing the front bezel with the LCD panel

Identifier	GUID-D2B00413-48EF-4796-93B0-F0107BAE330A
Status	Released

Installing the front bezel

Prerequisites

Follow the safety guidelines listed in [Safety instructions](#).

Steps

1. Locate and remove the bezel key.

NOTE: The bezel key is part of the LCD bezel package.

2. Align and insert the right end of the bezel onto the system.
3. Press the bezel until the button clicks in place and fit the left end of the bezel onto the system.
4. Lock the bezel by using the key.

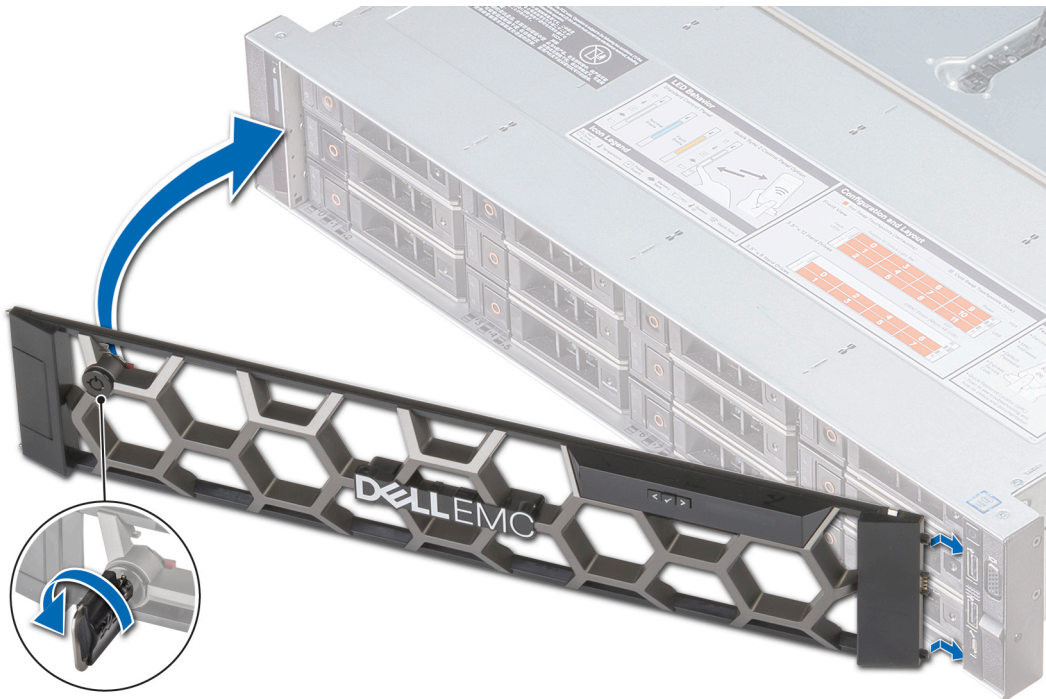

Figure 24. Installing the front bezel with the LCD panel

Identifier	GUID-B77E9775-865F-4E4D-AC97-5AF32F81E1C6
Status	Released

System cover

NOTE: The system cover of 12 x 3.5-inch + 2 x 3.5-inch (rear) system is different from other systems. The cover has one additional mylar and foam layer on the front side of the system cover.

Identifier	GUID-C2B468F2-597F-4A03-804E-33A3C15BA1D8
Status	Released

Removing the system cover

Prerequisites

1. Follow the safety guidelines listed in [Safety instructions](#).
2. Turn off the system, including any attached peripherals.
3. Disconnect the system from the electrical outlet and disconnect the peripherals.

Steps

1. Using a 1/4 inch flat head or a Phillips #2 screwdriver, rotate the latch release lock counter clockwise to the unlocked position.
2. Lift the latch till the system cover slides back and the tabs on the system cover disengage from the guide slots on the system.
3. Hold the cover on both sides, and lift the cover away from the system.

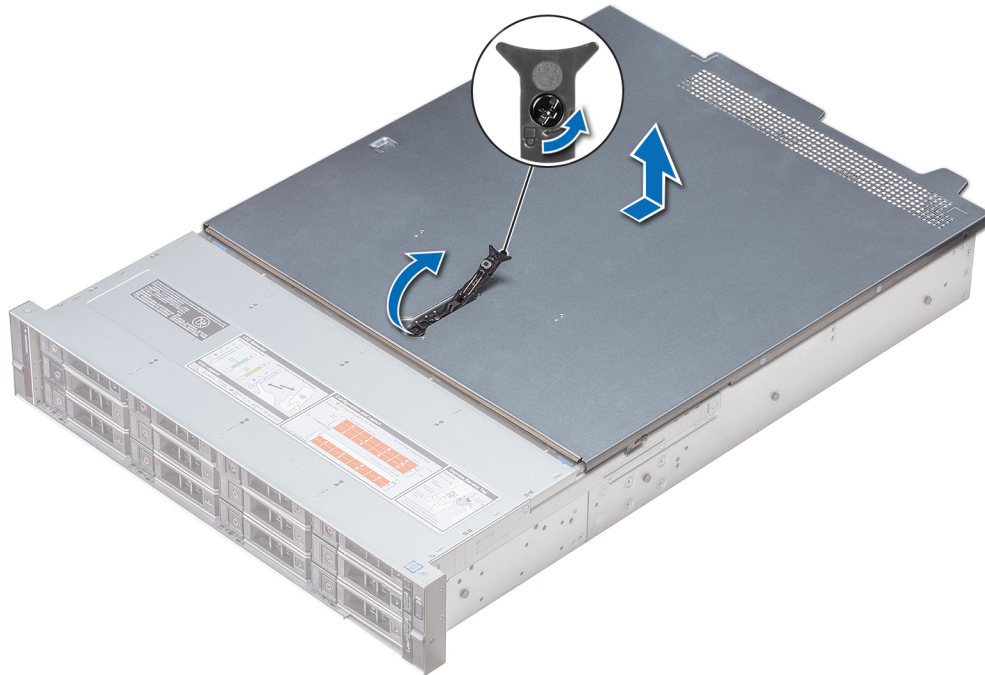

Figure 25. Removing the system cover

Identifier	GUID-743636A2-1906-46B6-ADF5-2D85AE74E3C7
Status	Released

Installing the system cover

Prerequisites

1. Follow the safety guidelines listed in [Safety instructions](#).
2. Ensure that all internal cables are routed correctly and connected, and no tools or extra parts are left inside the system.

Steps

1. Align the tabs on the system cover with the guide slots on the system.
2. Push the system cover latch down.
The system cover slides forward, the tabs on the system cover engage with the guide slots on the system and the system cover latch locks into place.
3. Using a 1/4 inch flat head or Phillips #2 screwdriver, rotate the latch release lock clockwise to the locked position.

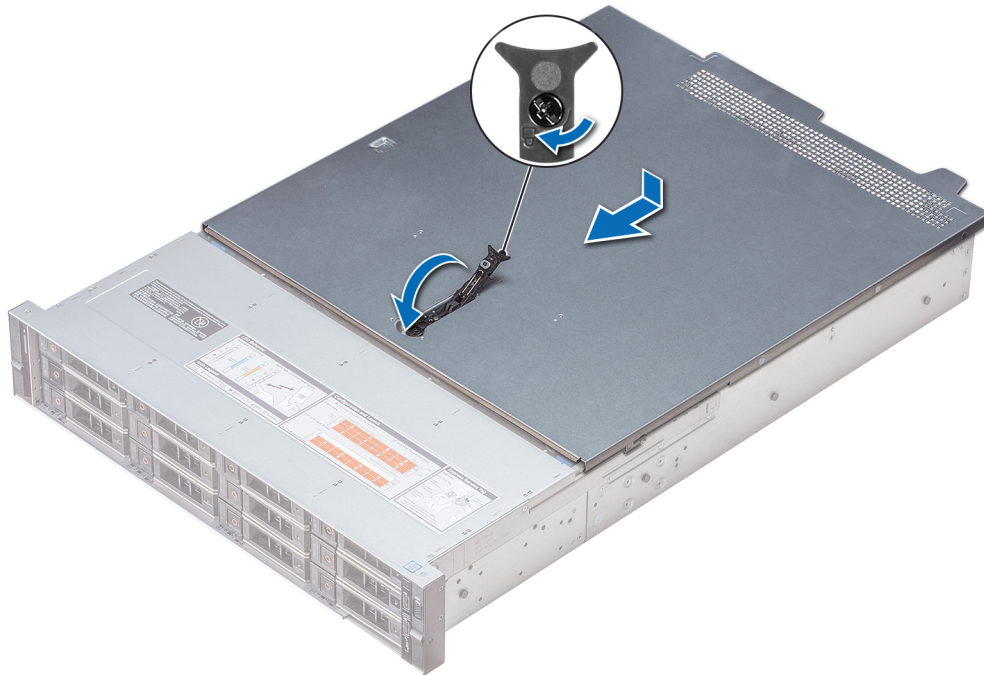

Figure 26. Installing system cover

Next steps

1. Reconnect the peripherals and connect the system to the electrical outlet.
2. Turn on the system, including any attached peripherals.

Identifier	GUID-315ACF65-9327-4298-8421-8FEFEEC111C4
Status	Released

Backplane cover

Identifier	GUID-B7CCFB86-0768-41D1-8D39-9C5D1DBE6930
Status	Released

Removing the backplane cover

Prerequisites

1. Follow the safety guidelines listed in [Safety instructions](#).
2. Follow the procedure listed in [Before working inside your system](#).
3. [Removing the system cover](#).

Steps

1. Slide the backplane cover in the direction of the arrows marked on the backplane cover.
2. Lift the backplane cover away from the system.

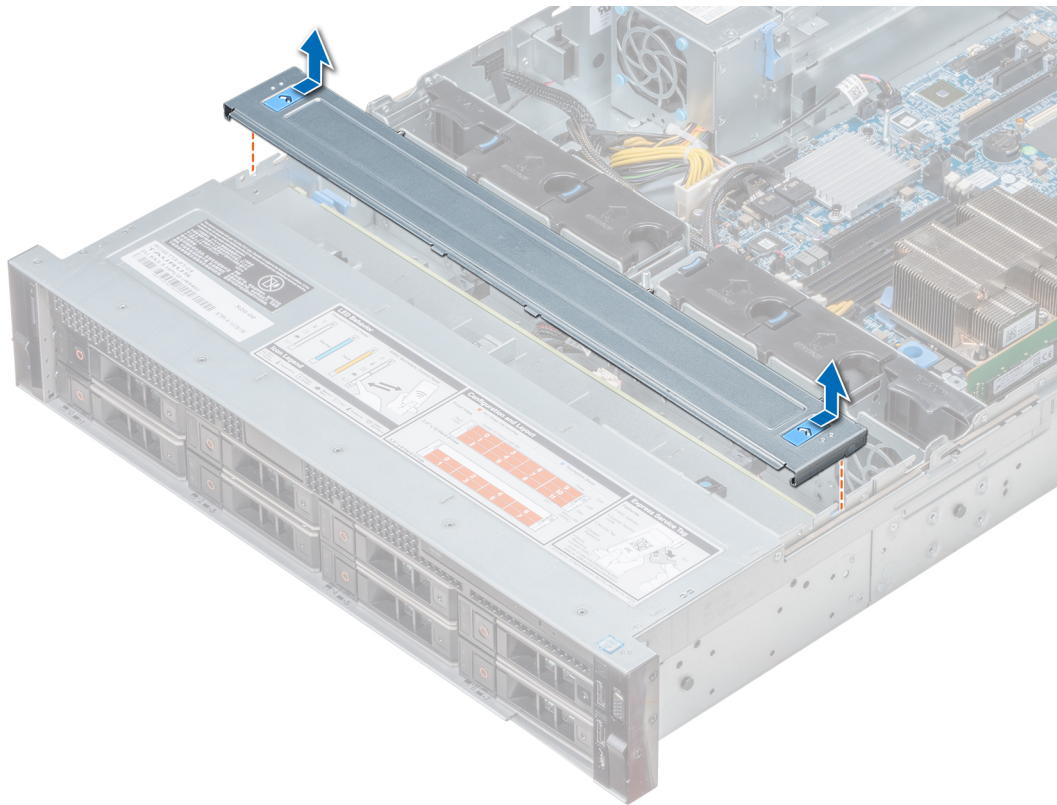

Figure 27. Removing backplane cover

Identifier	GUID-F958F391-987E-4880-9FCE-AEDE11BC1358
Status	Released

Installing the backplane cover

Prerequisites

1. Follow the safety guidelines listed in [Safety instructions](#).
2. Follow the procedure listed in [Before working inside your system](#).
3. [Installing the system cover](#).

Steps

1. Align the tabs on the backplane cover with the guide slots on the system.
2. Slide the backplane cover toward the front of the system until the cover locks into place.

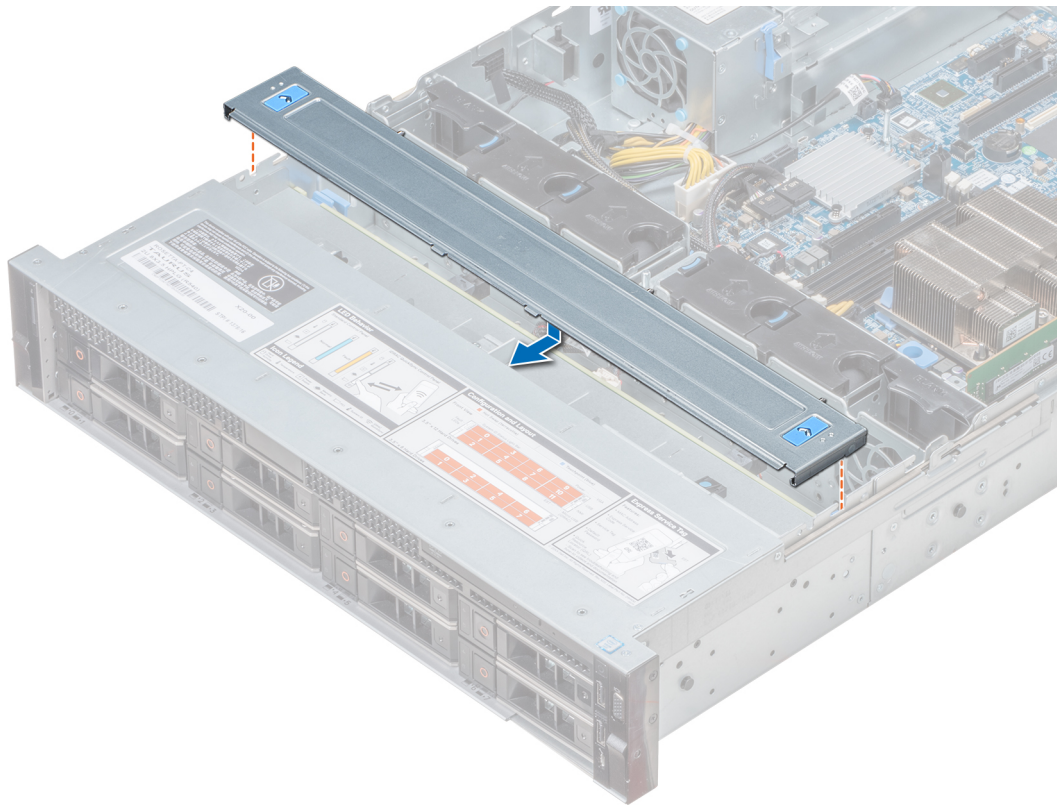

Figure 28. Installing backplane cover

Next steps

Follow the procedure listed in [After working inside your system.](#)

Identifier	GUID-1A240EF1-CB72-4D0E-9249-01AE609CFA55
Status	Released

Inside the system

NOTE: Components that are hot swappable are marked orange and touch points on the components are marked blue.

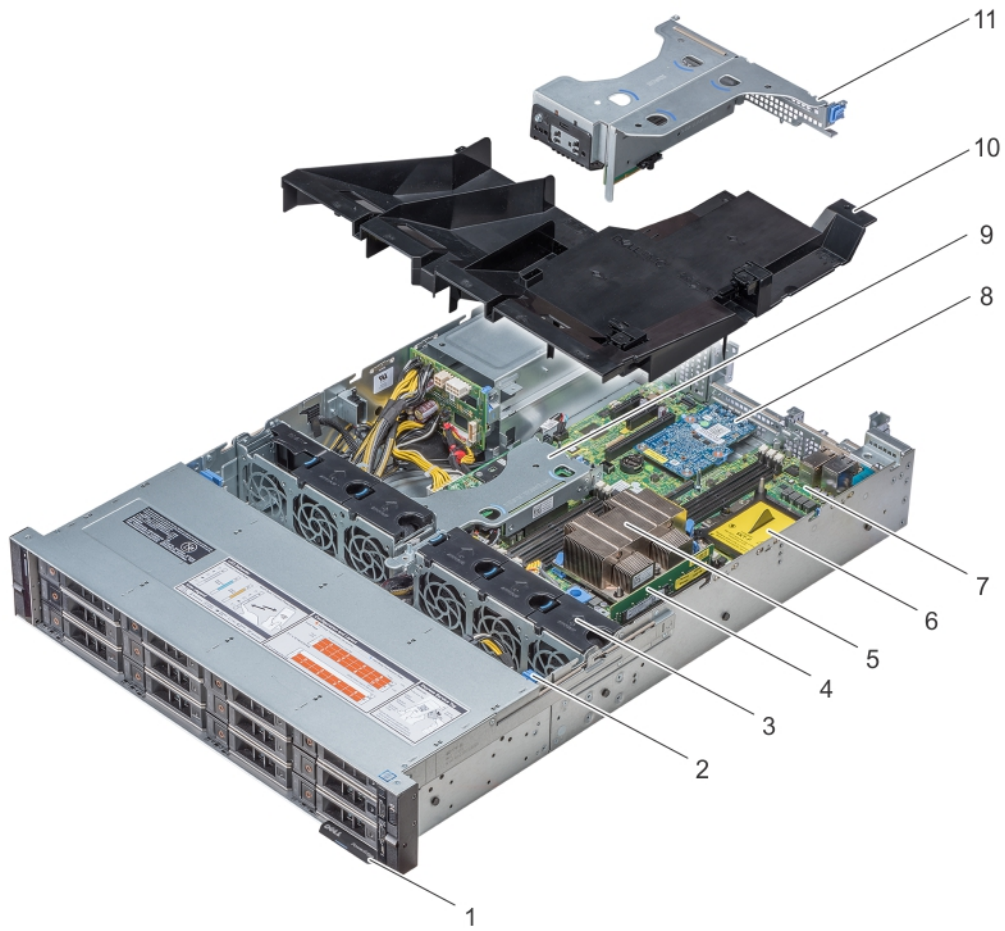

Figure 29. Inside the system without rear drive cage

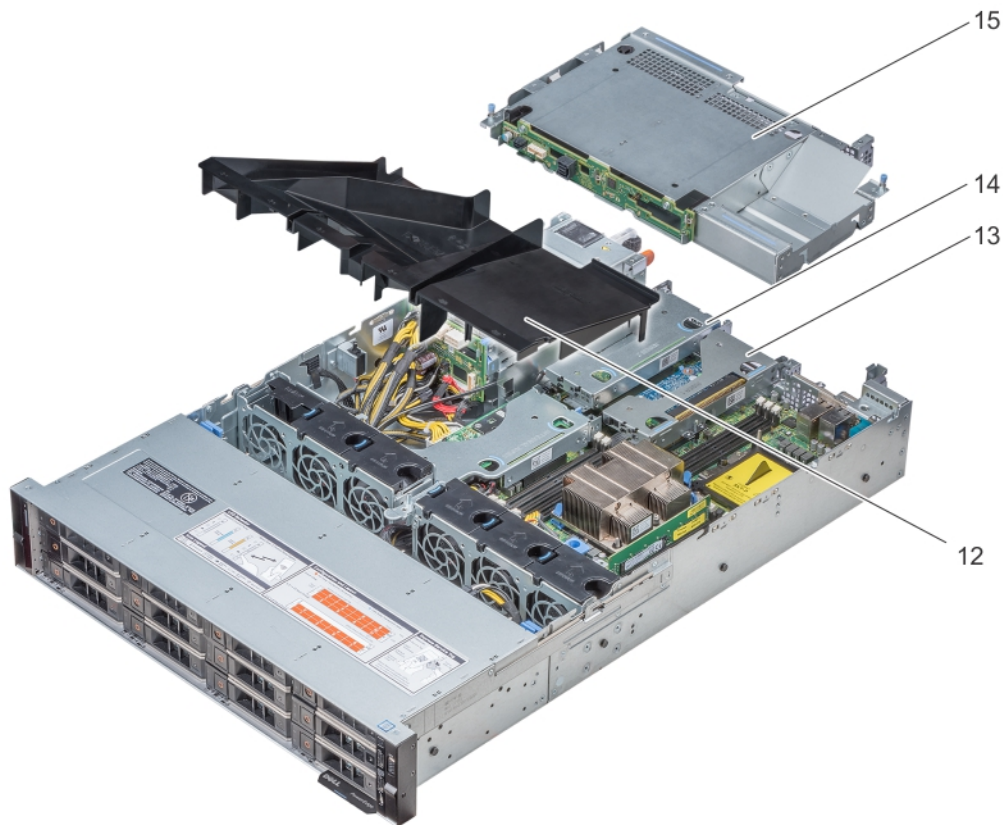

Figure 30. Inside the system with rear drive cage

- | | |
|-----------------------------|--|
| 1. Information tag | 2. Drive backplane |
| 3. Cooling fans | 4. Memory module |
| 5. CPU 1 | 6. CPU 2 |
| 7. System board | 8. LOM riser card |
| 9. Internal PERC riser | 10. Air shroud |
| 11. Butterfly riser | 12. Air shroud (12 x 3.5 inch + 2 x 3.5 inch rear hard drive system) |
| 13. Low profile riser right | 14. Low profile riser left |
| 15. Drive cage (rear) | |

Identifier	GUID-FB7A3D23-B9AD-40A3-A8A3-6A0367E81089
Status	Released

Air shroud

Identifier	GUID-2A580E64-E908-4091-9A8F-6E216A581901
Status	Released

Removing the air shroud

Prerequisites

CAUTION: Never operate your system with the air shroud removed. The system may get overheated quickly, resulting in shutdown of the system and loss of data.

1. Follow the safety guidelines listed in [Safety instructions](#).
2. Follow the procedure listed in [Before working inside your system](#).
3. If installed, [remove the butterfly riser](#).

Steps

Hold the air shroud at both ends and lift it away from the system.

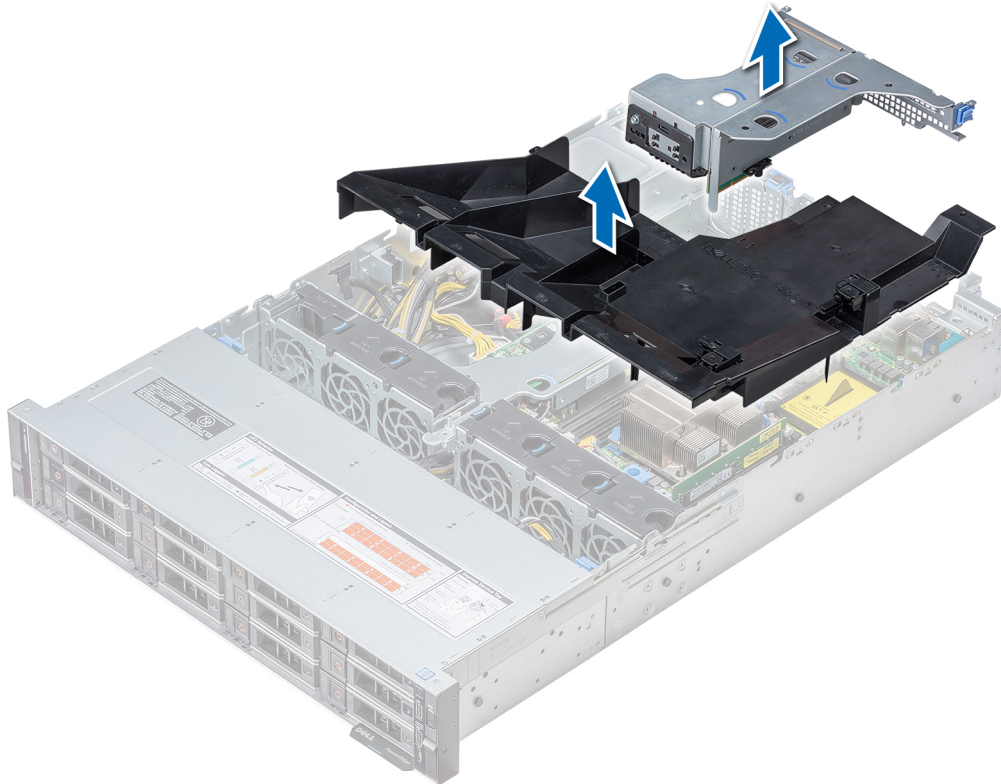
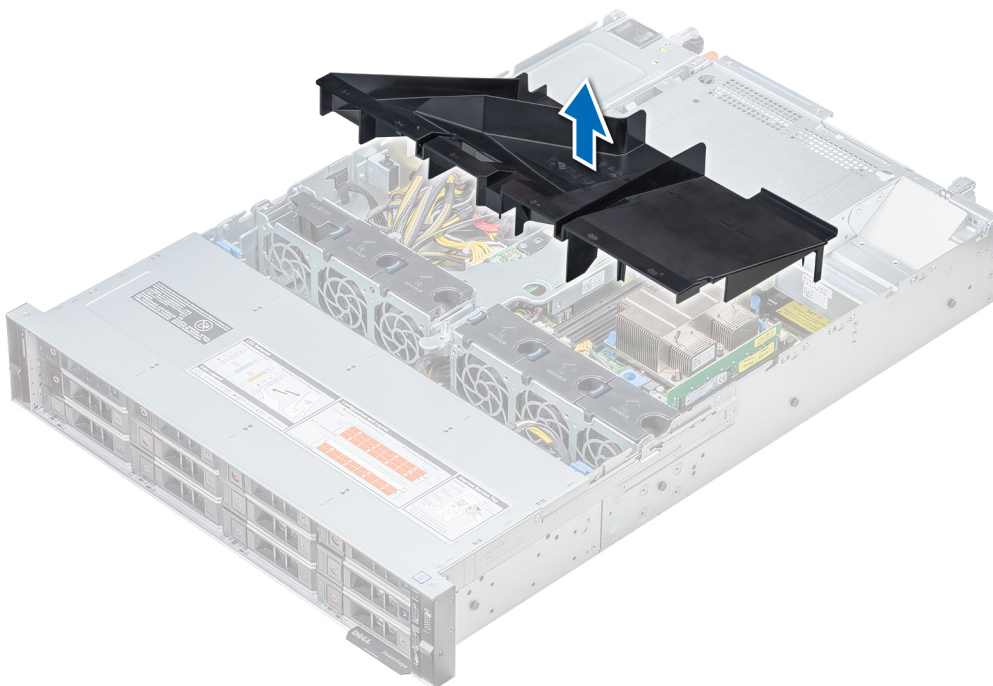

Figure 31. Removing air shroud

NOTE: The system with 2 x 3.5-inch rear drive has a different air shroud. However, the procedure to remove the air shroud is identical.



Next steps

1. If applicable, [Installing the air shroud](#)
2. Follow the procedure listed in [After working inside your system](#).

Identifier	GUID-37B4F977-C84B-47A5-A008-F83B2D69E508
Status	Released

Installing the air shroud

Prerequisites

1. Follow the safety guidelines listed in [Safety instructions](#).
2. Follow the procedure listed in [Before working inside your system](#).
3. If applicable, route the cables inside the system along the system wall and secure the cables by using the cable latch.

Steps

1. Align the tabs on the air shroud with the slots on the system.
2. Lower the air shroud into the system until it is firmly seated.

When firmly seated, the memory socket numbers marked on the air shroud align with the respective memory sockets.

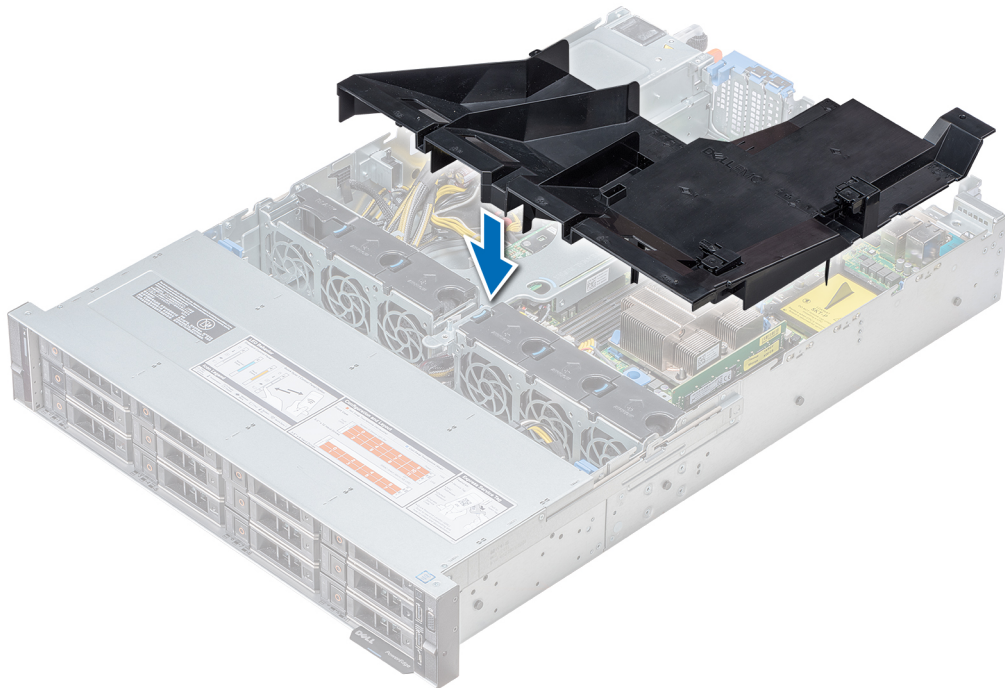
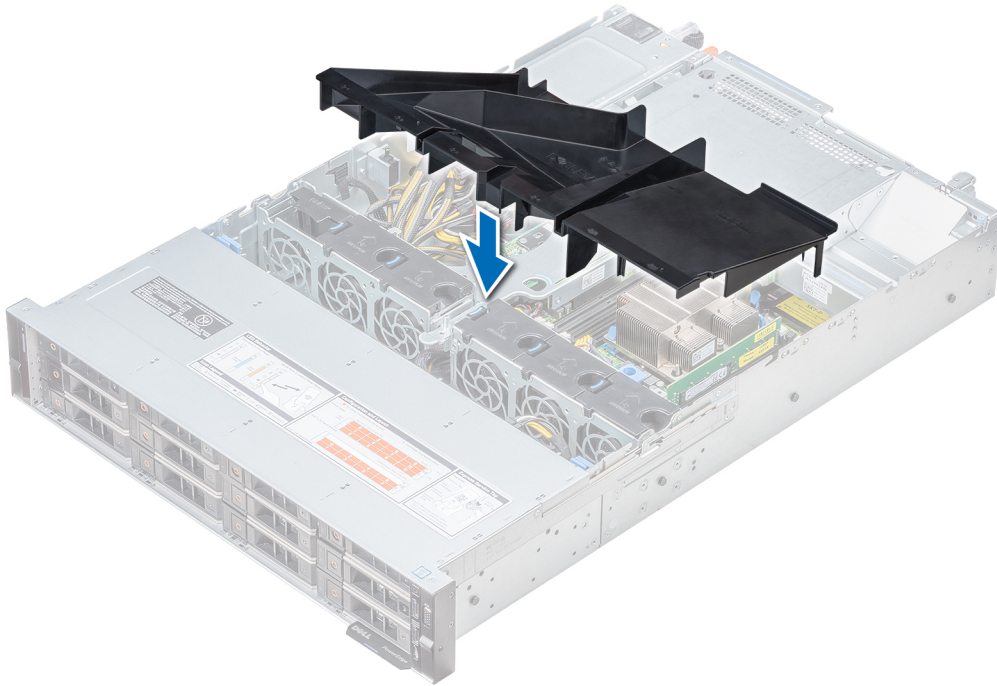

Figure 32. Installing air shroud

NOTE: The procedure to install the air shroud for 2 x 3.5-inch rear drive system is identical.



Next steps

1. If removed, [install the butterfly riser](#).
2. Follow the procedure listed in [After working inside your system](#).

Identifier	GUID-224AB3C4-6306-4735-BF25-959698F7C219
Status	Released

Cooling fans

Identifier	GUID-6D5F24E5-56F2-4C35-A41B-75B7D91695C6
Status	Released

Removing the cooling fan

The procedure for removing standard and high performance fans are identical.

Prerequisites

1. Follow the safety guidelines listed in [Safety instructions](#).
2. Follow the procedure listed in [Before working inside your system](#).
3. [Removing the air shroud](#)
4. [Removing the internal PERC riser](#)
5. Move the cables out of the way to access the cooling fan cable connector on the system board.

Steps

1. Lift the fan out holding the blue touch point.
2. Disconnect the cooling fan cable connected to the system board connector.

NOTE: In the 12 x 3.5-inch drive system, disconnect the fan 1 cable from the power interposer board connector.

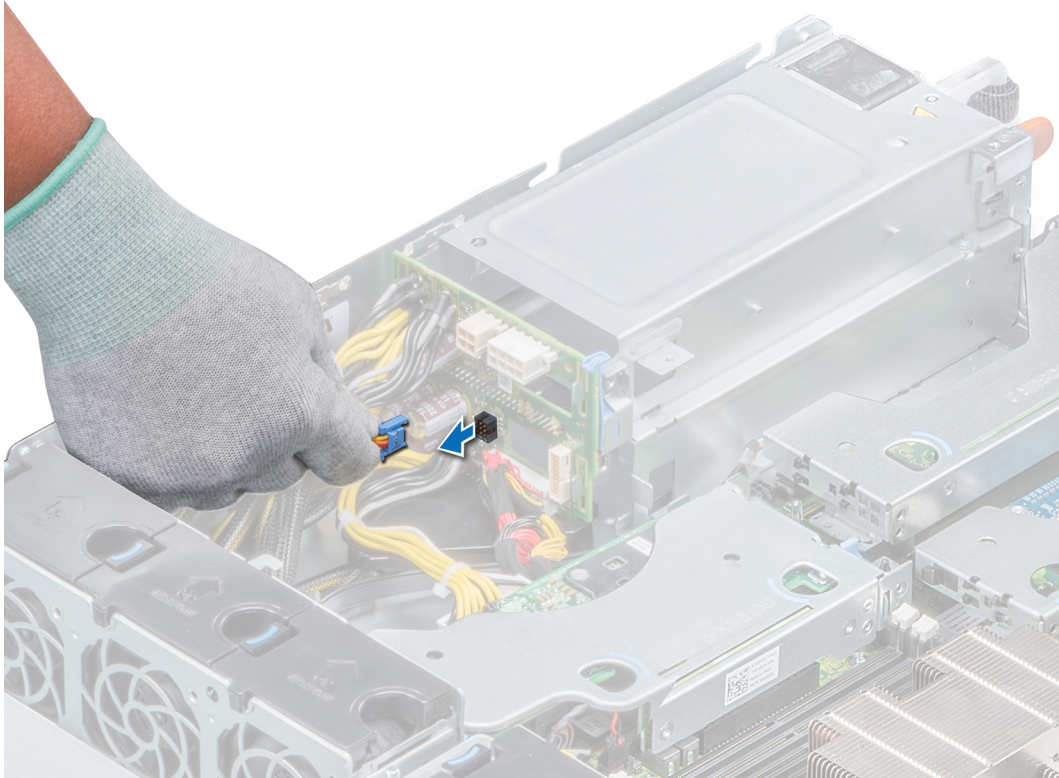

Figure 33. Disconnecting fan cable from PIB connector

3. Press the release tab and lift the cooling fan out of the cooling fan cage.

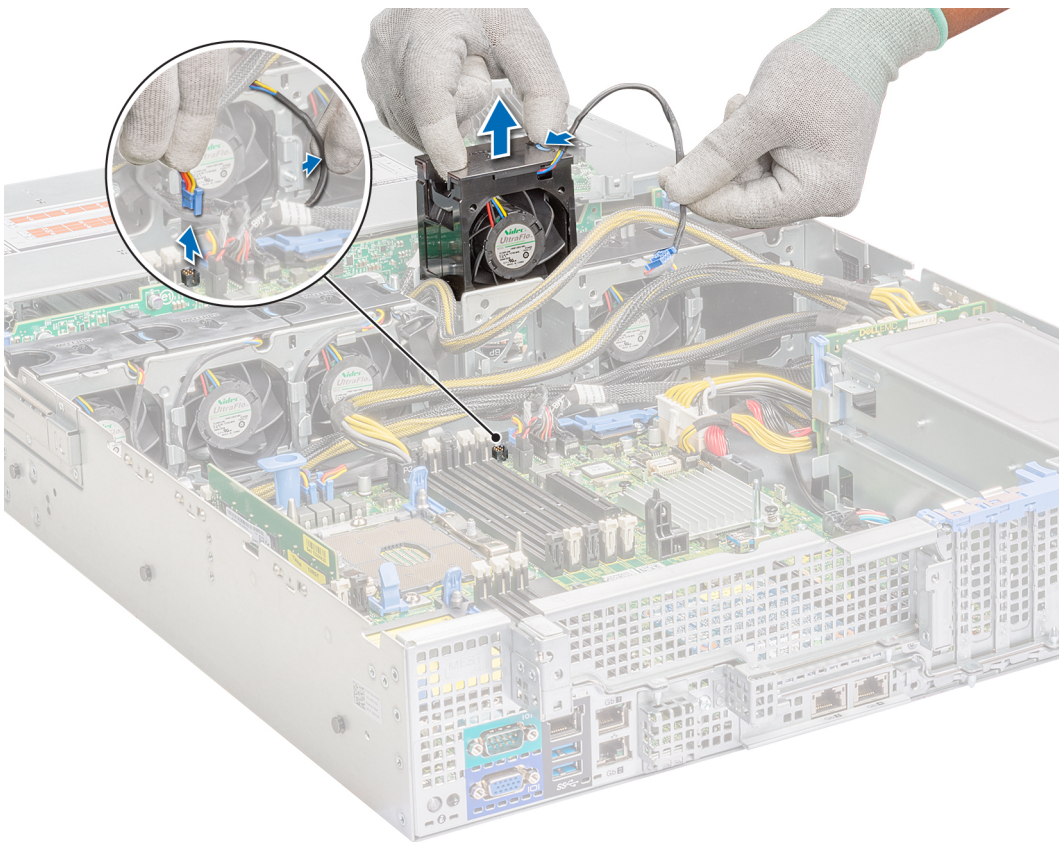

Figure 34. Removing cooling fan

Next steps

1. [Installing cooling fan.](#)
2. [Installing the internal PERC riser](#)
3. [Installing the air shroud](#)
4. Follow the procedure listed in [After working inside your system.](#)

Identifier	GUID-C2818EB4-4990-494A-B91F-9FA8741B2716
Status	Released

Installing cooling fan

The procedure for installing standard and high performance fans are identical.

Prerequisites

1. Follow the safety guidelines listed in [Safety instructions.](#)
2. Follow the procedure listed in [Before working inside your system.](#)
3. [Removing the air shroud](#)
4. [Removing the internal PERC riser](#)
5. Remove the power cable.
6. Move the cables out of the way to access the cooling fan cable connector on the system board.

Steps

1. Holding the release tab blue touch point, place the cooling fan into the cooling fan cage.
2. Route the cooling fan cable and connect it to the connector on the system board.

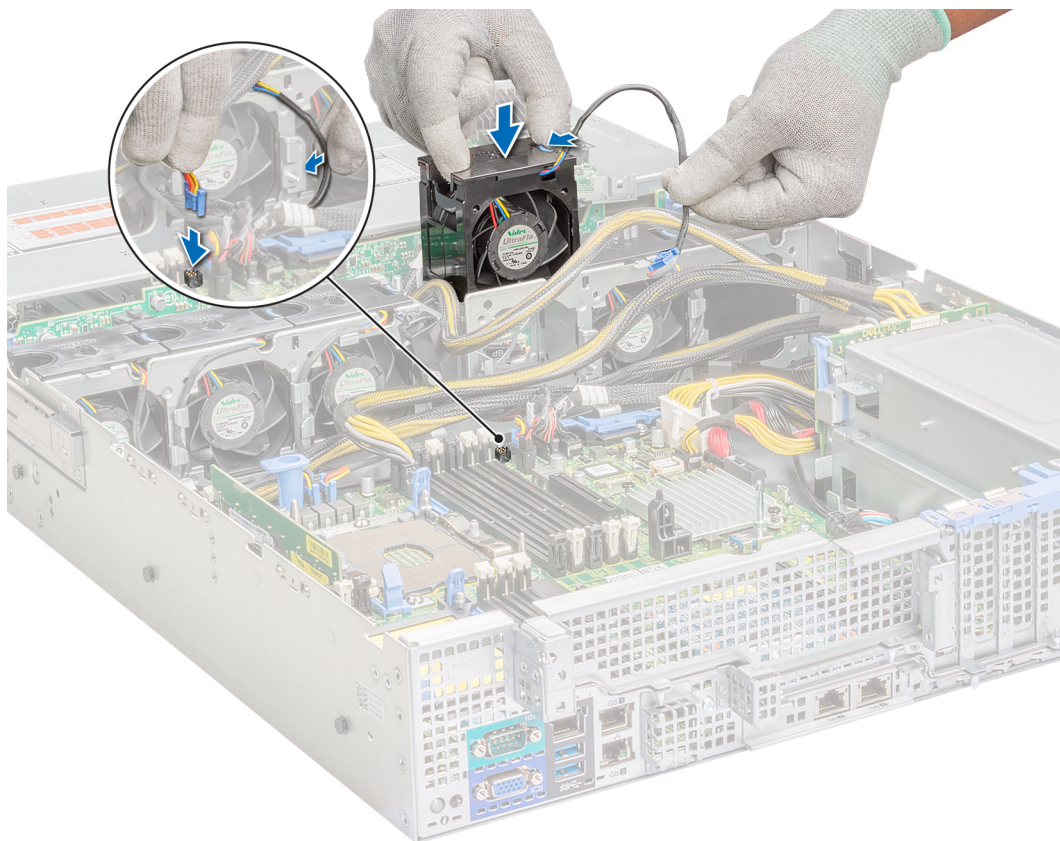

Figure 35. Installing cooling fan

NOTE: In the 12 x 3.5-inch drive system, connect the fan 1 cable to the power interposer board connector.

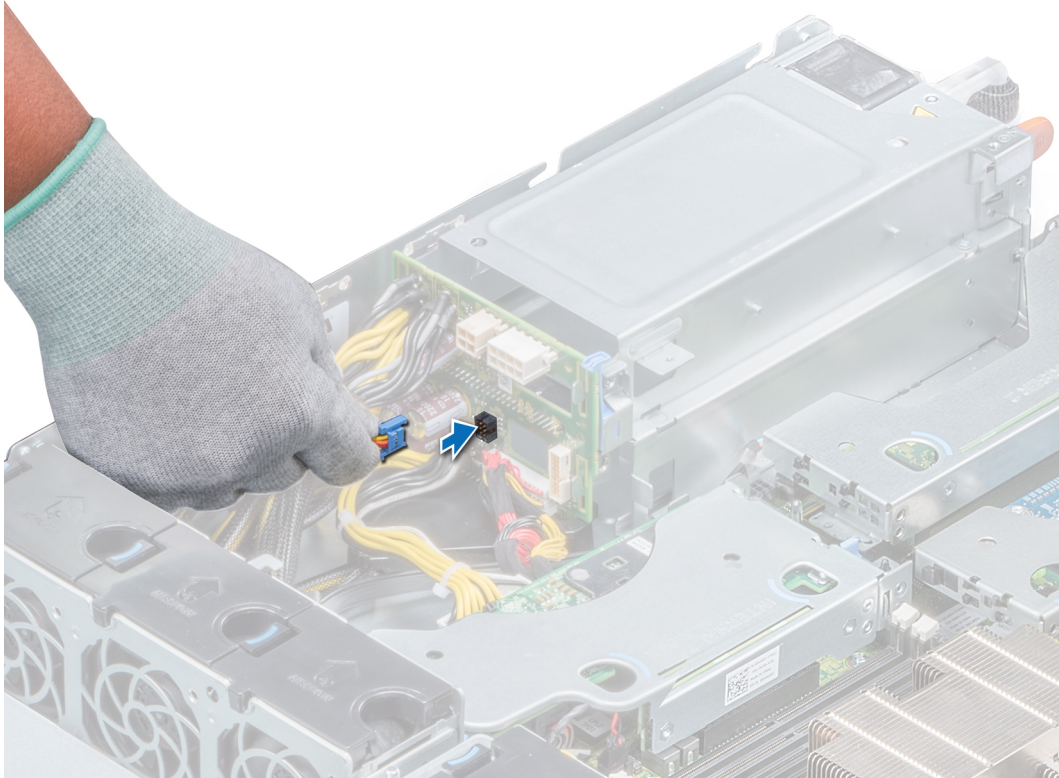

Figure 36. Connecting fan cable to PIB connector

Next steps

1. [Installing the internal PERC riser](#)
2. Ensure all the cables are routed correctly.
3. [Installing the air shroud](#)
4. Follow the procedure listed in [After working inside your system](#).

Identifier	GUID-69D4052E-3696-4D0C-95B1-517B96BB36A7
Status	Released

Internal PERC riser

Identifier	GUID-3B89644A-417C-4913-B99C-6C5FFD06598D
Status	Released

Removing the internal PERC riser

Prerequisites

1. Follow the safety guidelines listed in [Safety instructions](#).
2. Follow the procedure listed in [Before working inside your system](#).
3. [Removing the air shroud](#)

Steps

1. Open the cable guiding latch for easy access.
2. Lower the plunger.
3. Press the cable connector and disconnect the PERC cable from the backplane.
4. Hold the blue touch points and lift the internal PERC riser out of the system.

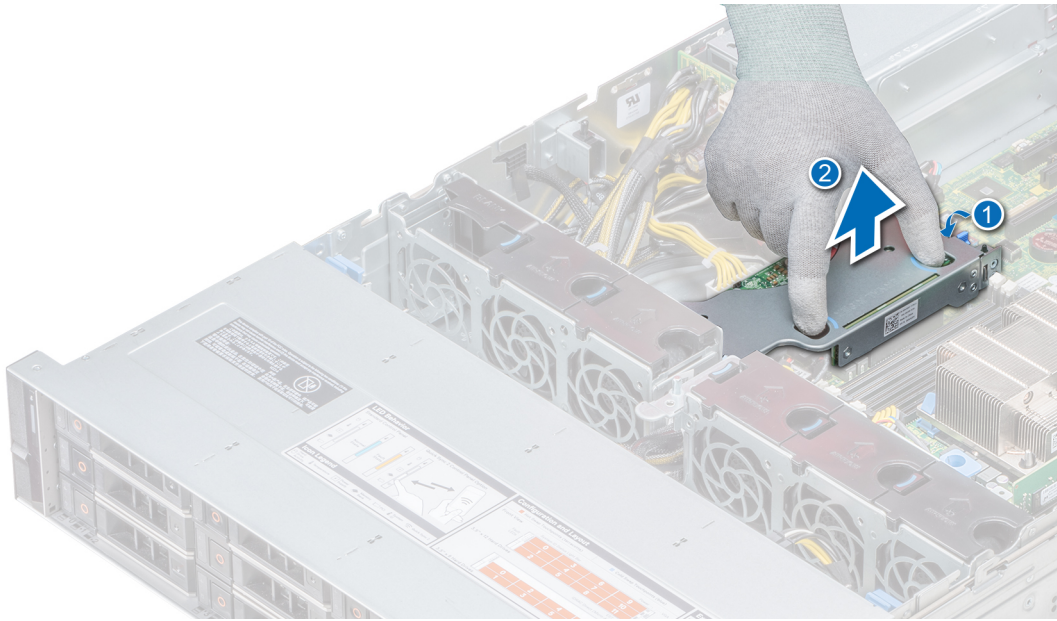

Figure 37. Removing internal PERC riser

5. Turn the internal riser so that the PERC card is facing up.
6. Press the cable connector and disconnect the cable connected to the internal PERC card.

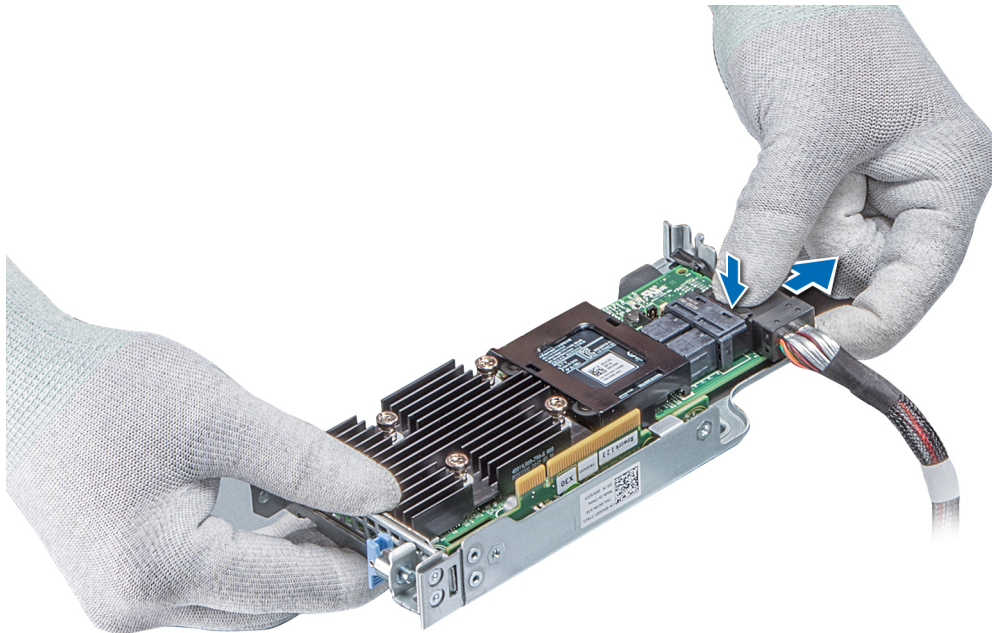

Figure 38. Disconnecting the cable from internal PERC card

Next steps

1. [Installing the air shroud](#)
2. Follow the procedure listed in [After working inside your system.](#)
3. [Installing the internal PERC riser](#)

Installing the internal PERC riser

Prerequisites

Follow the safety guidelines listed in [Safety instructions](#).

Steps

1. Connect the cable to the internal PERC card.

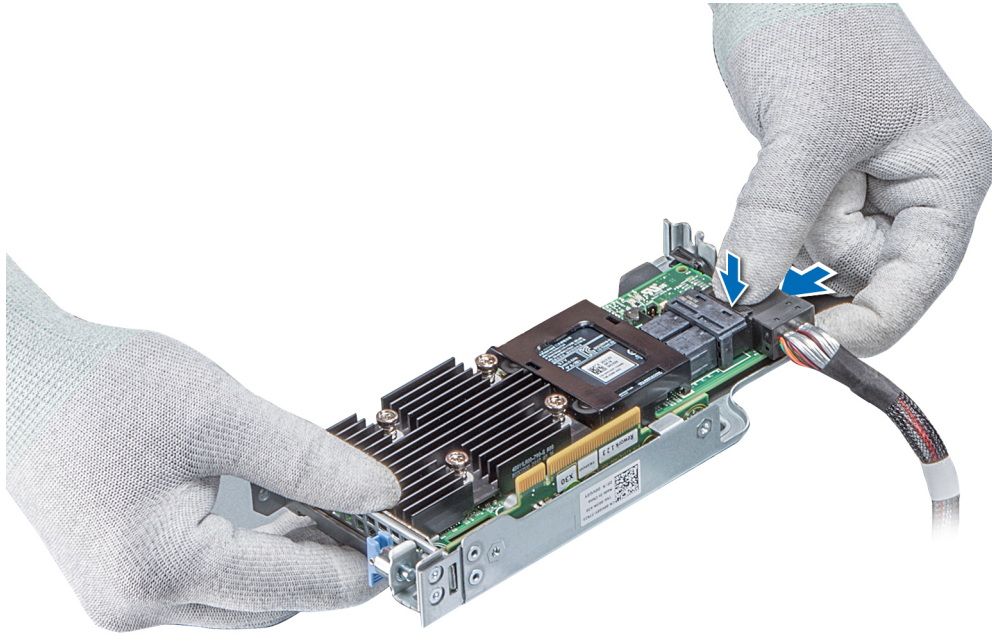

Figure 39. Connecting the cable to internal PERC riser

2. Holding the blue touch points, align the slot on the internal PERC riser to the guide on the system board.
3. Insert the internal riser card's edge connector firmly into the system board connector until the riser is fully seated.
4. Lift the plunger to lock the riser in place.

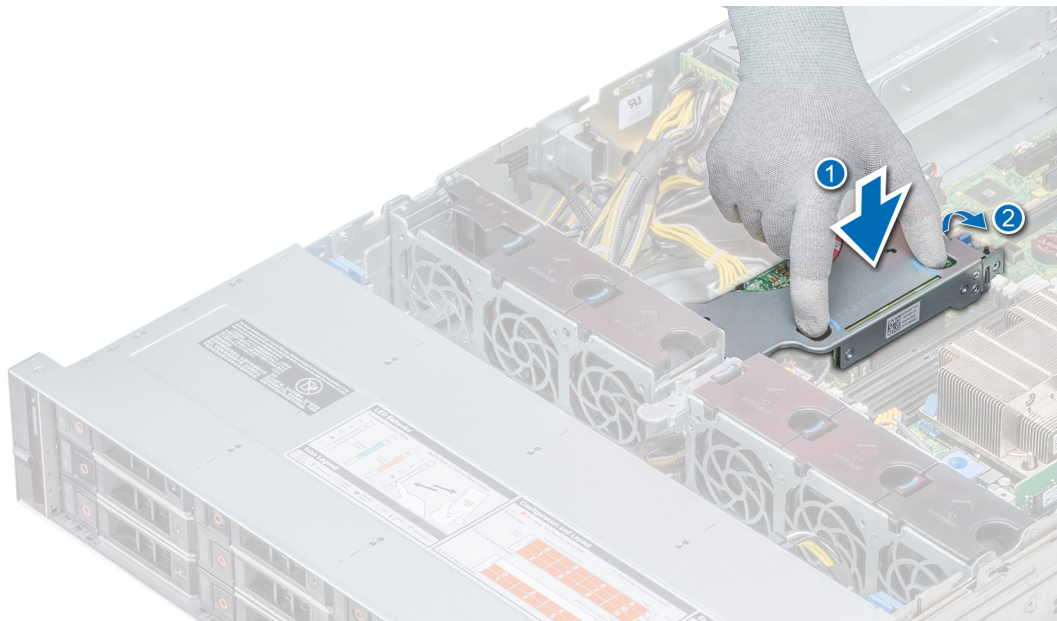

Figure 40. Installing internal PERC riser

5. Connect the cables to the backplane and then route the cables to the cable guiding latch to close the latch.

Next steps

1. [Installing the air shroud](#)
2. Follow the procedure listed in [After working inside your system.](#)

Identifier	GUID-FC7A7FB7-2228-4507-9097-C155600FA906
Status	Released

Removing the PERC card from the internal PERC riser

Prerequisites

1. Follow the safety guidelines listed in [Safety instructions.](#)
2. Follow the procedure listed in [Before working inside your system.](#)
3. [Removing the air shroud](#)
4. [Removing the internal PERC riser](#)

Steps

1. Using a Phillips #2 screwdriver, remove the screw that secures the PERC card to the internal PERC riser.
2. Pull the PERC card out of the connector on the internal PERC riser.

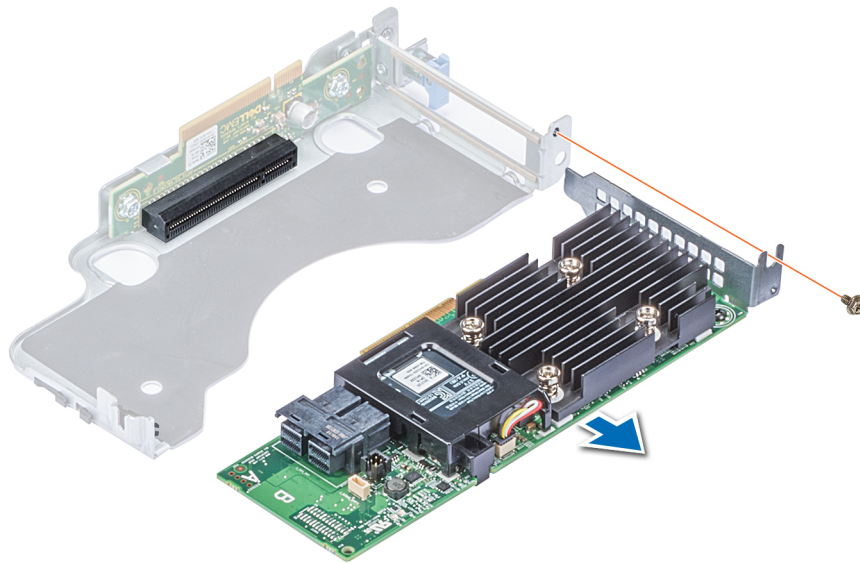

Figure 41. Removing the PERC card from the internal PERC riser

Next steps

1. [Installing the internal PERC riser](#)
2. [Installing the air shroud](#)
3. Follow the procedure listed in [After working inside your system.](#)

Identifier	GUID-C2788289-EAD9-4E0E-AFBE-CC794884CF84
Status	Released

Installing PERC card into the internal PERC riser

Prerequisites

1. Follow the safety guidelines listed in [Safety instructions.](#)

Steps

1. Insert the PERC card into the internal PERC riser and push the card in.
2. Using a Phillips #2 screwdriver, replace the screw to secure the PERC card on the internal PERC riser.

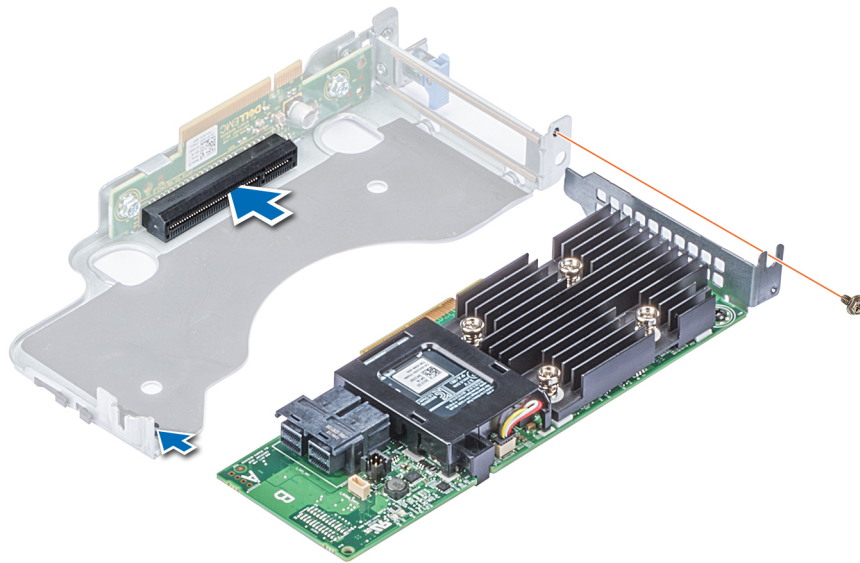

Figure 42. Installing PERC card into internal PERC riser

Next steps

1. [Installing the internal PERC riser](#)
2. [Installing the air shroud](#)
3. Follow the procedure listed in [After working inside your system.](#)

Identifier	GUID-77EDBF3F-634B-4E03-B00E-60D18183722B
Status	Released

Intrusion switch

Identifier	GUID-22E16A41-E2DC-4991-B836-C0A2865E3049
Status	Released

Removing the intrusion switch

Prerequisites

1. Follow the safety guidelines listed in [Safety instructions.](#)
2. Follow the procedure listed in [Before working inside your system.](#)
3. [Removing the air shroud](#)
4. [Removing the internal PERC riser](#)

Steps

1. Disconnect the intrusion switch cable connected to the system board.
 - (i) NOTE:** Ensure that you note the routing of the cables as you remove them from the system board.
2. Slide the intrusion switch out of the intrusion switch slot.

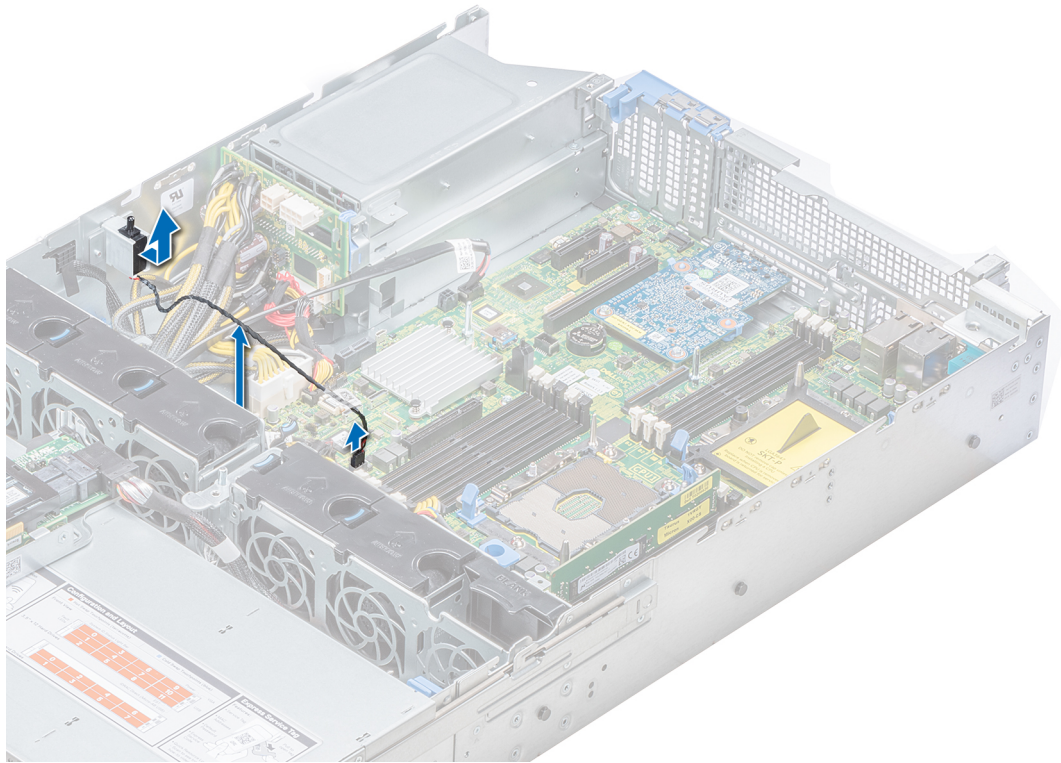

Figure 43. Removing an intrusion switch

Next steps

Installing the intrusion switch.

Identifier	GUID-9B0C7DCF-17FC-497D-AB9F-D2666D53DAB9
Status	Released

Installing the intrusion switch

Prerequisites

1. Follow the safety guidelines listed in [Safety instructions](#).
2. Follow the procedure listed in [Before working inside your system](#).

Steps

1. Align the intrusion switch with the intrusion switch slot.

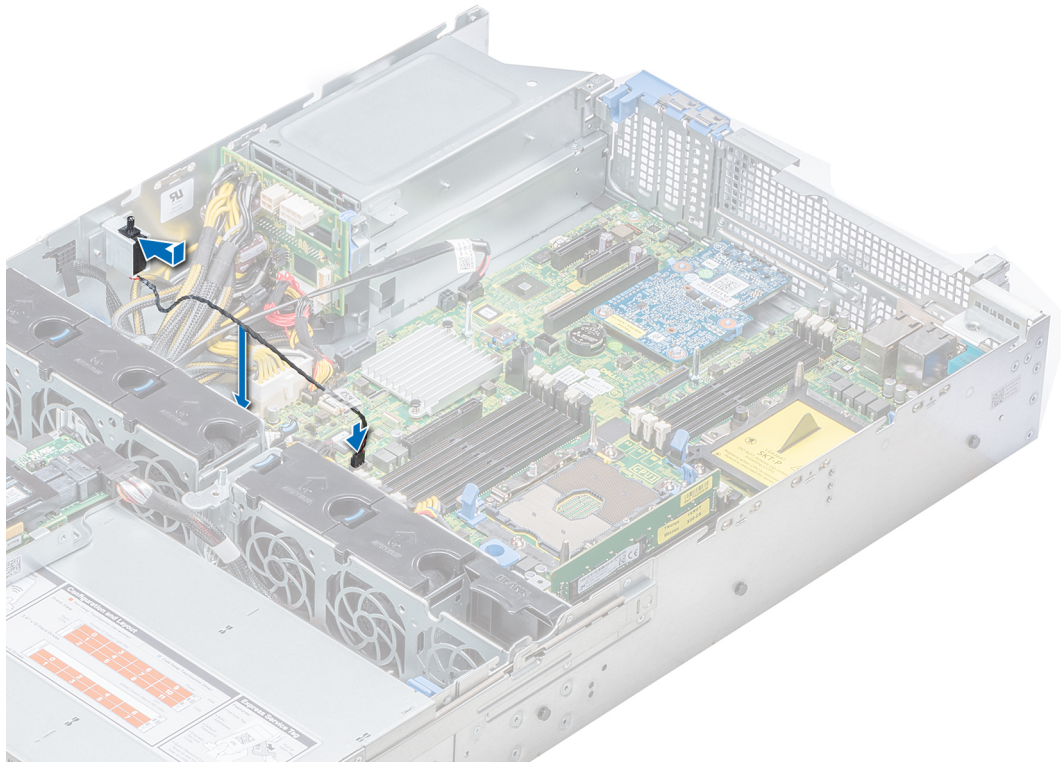

Figure 44. Installing intrusion switch

2. Slide the intrusion switch until it is firmly seated in the intrusion switch slot.
3. Connect the intrusion switch cable to the connector on the system board.

Next steps

1. [Installing the internal PERC riser](#)
2. Follow the procedure listed in [After working inside your system.](#)

Identifier	GUID-CFDC0B81-3797-4CD7-845D-1144CAD5BE38
Status	Released

Drives

Identifier	GUID-1C02B0AC-4881-489A-806C-CC5CB7D369D8
Status	Released

Removing a drive blank

The procedure for removing 2.5-inch and 3.5-inch drive blanks is identical.

Prerequisites

1. Follow the safety guidelines listed in [Safety instructions.](#)
2. If installed, [Removing the front bezel](#)

⚠ CAUTION: To maintain proper system cooling, drive blanks must be installed in all empty drive slots.

⚠ CAUTION: Mixing drive blanks from previous generations of PowerEdge servers is not supported.

Steps

Press the release button, and slide the drive blank out of the drive slot.

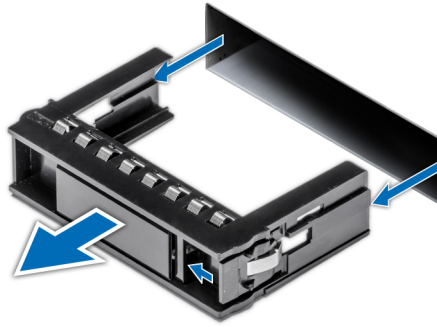

Figure 45. Removing a drive blank

Next steps

1. [Installing a drive blank](#)

Identifier	GUID-4F9DFDE4-596A-4661-9F6C-51E365245A91
Status	Released

Installing a drive blank

The procedure for installing 2.5-inch and 3.5-inch drive blanks is identical.

Prerequisites

1. Follow the safety guidelines listed in [Safety instructions](#).
2. If installed, [Removing the front bezel](#)

CAUTION: Mixing drive blanks from previous generations of PowerEdge servers is not supported.

Steps

Insert the drive blank into the drive slot, and push the blank until the release button clicks into place.

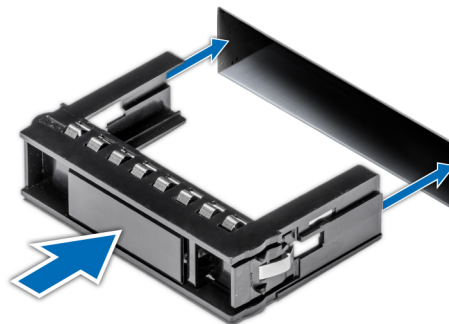

Figure 46. Installing a drive blank

Next steps

If removed, [Installing the front bezel](#)

Identifier	GUID-AEED48AD-9EE4-48A4-ADB4-D766F3F4371D
Status	Released

Removing a 2.5-inch drive from a 3.5-inch drive adapter

Prerequisites

1. Follow the safety guidelines listed in [Safety instructions](#).
2. [Removing a 3.5-inch drive adapter from a 3.5-inch drive carrier](#)

NOTE: A 2.5 inch drive is installed in a 3.5 inch drive adapter, which is then installed in the 3.5-inch drive carrier.

Steps

1. Using a Phillips #2 screwdriver, remove the screws from the side of the 3.5-inch drive adapter.
2. Remove the 2.5-inch drive from the 3.5-inch drive adapter.

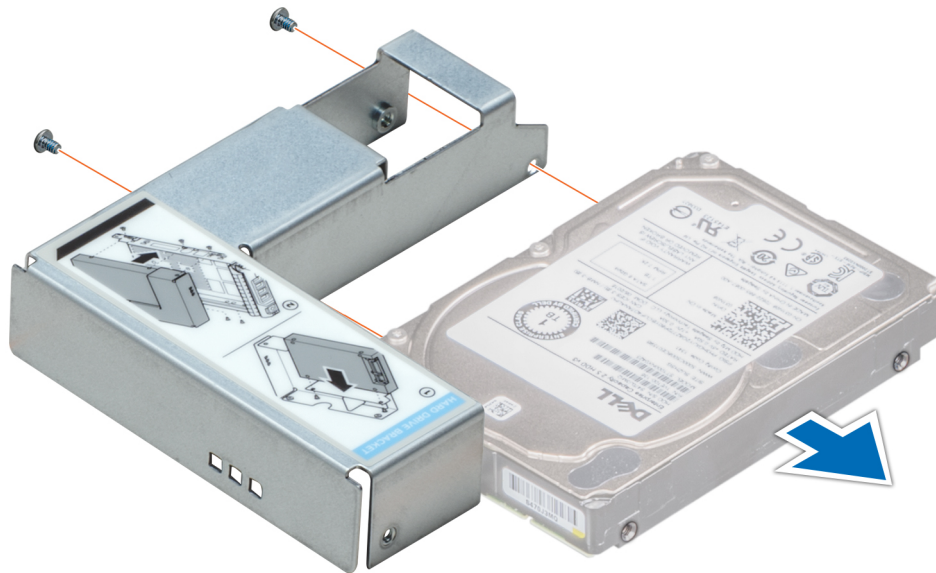

Figure 47. Removing a 2.5 inch drive from a 3.5-inch drive adapter

Next steps

Installing a 2.5-inch drive into a 3.5-inch drive adapter

Identifier	GUID-FB9EA11A-013B-4832-BE3B-50F315E1F455
Status	Released

Installing a 2.5-inch drive into a 3.5-inch drive adapter

Prerequisites

1. Follow the safety guidelines listed in [Safety instructions](#).
2. [Removing a 3.5-inch drive adapter from a 3.5-inch drive carrier](#)

Steps

1. Align the screw holes on the 2.5-inch drive with the screw holes on the 3.5-inch drive adapter.
2. Using a Phillips #2 screwdriver, secure the 2.5-inch drive to the 3.5-inch drive adapter.

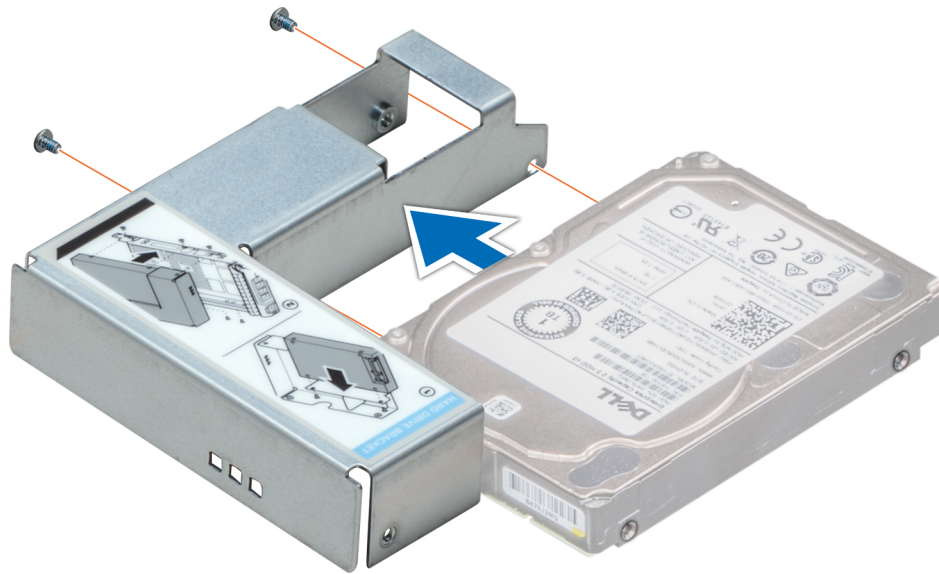

Figure 48. Installing a 2.5-inch drive into a 3.5-inch drive adapter

Identifier	GUID-68DF8F8D-8029-4F90-B72C-F2647FEE9606
Status	Released

Removing a 3.5-inch drive adapter from a 3.5-inch drive carrier

Prerequisites

1. Follow the safety guidelines listed in [Safety instructions](#).
2. If installed, [Removing the front bezel](#)
3. Remove the 3.5-inch drive carrier from the system.

Steps

1. Using a Phillips #1 screwdriver, remove the screws from the rails on the drive carrier.
2. Lift the 3.5 inch drive adapter out of the 3.5-inch drive carrier.

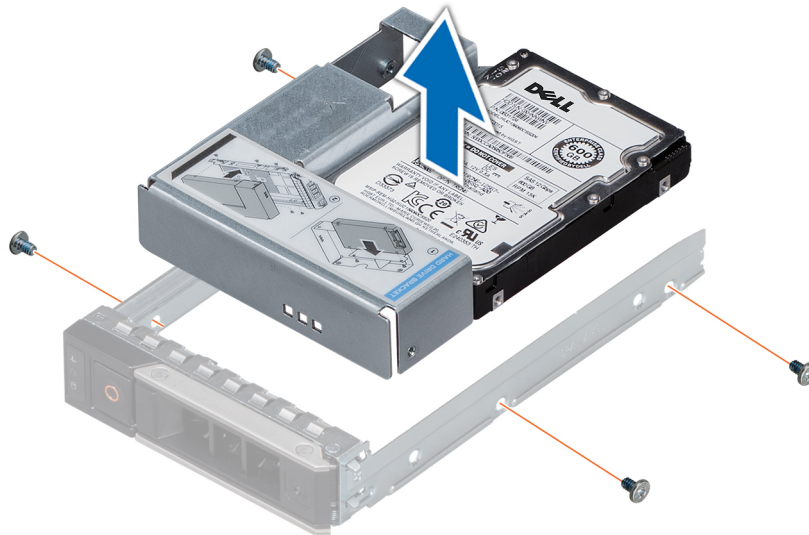

Figure 49. Removing a 3.5-inch drive adapter from a 3.5-inch drive carrier

Next steps

Installing a 3.5-inch drive adapter into the 3.5-inch drive carrier

Identifier	GUID-0BFDE164-4B6D-4A45-ADD9-198F6C34EF4A
Status	Released

Installing a 3.5-inch drive adapter into the 3.5-inch drive carrier

Prerequisites

1. Follow the safety guidelines listed in [Safety instructions](#).
2. [Install the 2.5-inch drive into the 3.5-inch drive adapter](#).

Steps

1. Insert the 3.5-inch drive adapter into the 3.5-inch drive carrier with the connector end of the drive toward the back of the 3.5-inch drive carrier.
2. Align the screw holes on the 3.5-inch drive adapter with the holes on the 3.5-inch drive carrier.
3. Using a Phillips #1 screwdriver, secure the 3.5-inch drive adapter to the 3.5-inch carrier.

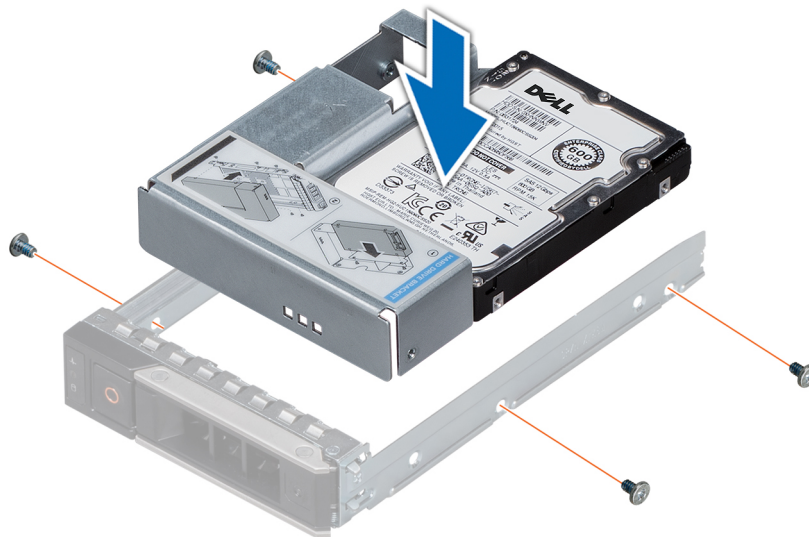

Figure 50. Installing a 3.5-inch drive adapter into the 3.5-inch drive carrier

Next steps

1. Install the 3.5-inch drive carrier into the system.
2. If removed, install the front bezel.

Identifier	GUID-2D0894B5-2171-4EE2-9C7E-BD18E5904B11
Status	Released

Removing a drive carrier

Prerequisites

1. Follow the safety guidelines listed in [Safety instructions](#).
2. If applicable, remove the front bezel.
3. Using the management software, prepare the drive for removal.

If the drive is online, the green activity or fault indicator flashes while the drive is turning off. When the drive indicators are off, the drive is ready for removal. For more information, see the documentation for the storage controller.

CAUTION: Before attempting to remove or install a drive while the system is running, see the documentation for the storage controller card to ensure that the host adapter is configured correctly to support drive removal and insertion.

CAUTION: Mixing drives from previous generations of PowerEdge servers is not supported.

CAUTION: To prevent data loss, ensure that your operating system supports drive installation. See the documentation supplied with your operating system.

Steps

1. Press the release button to open the drive carrier release handle.
2. Holding the handle, slide the drive carrier out of the drive slot.



Figure 51. Removing a drive carrier

Next steps

1. Follow the procedure listed in [After working inside your system](#).
2. [Install a drive carrier](#).
3. If you are not replacing the drive immediately, [Insert a drive blank](#) in the empty drive slot to maintain proper system cooling.

Identifier	GUID-AB92388B-A51E-4C3C-8020-6CD375CA680F
Status	Released

Installing a drive carrier

Prerequisites

- ⚠ **CAUTION:** Before attempting to remove or install a drive while the system is running, see the documentation for the storage controller card to ensure that the host adapter is configured correctly to support drive removal and insertion.
- ⚠ **CAUTION:** Mixing drives from previous generations of PowerEdge servers is not supported.
- ⚠ **CAUTION:** Combining SAS and SATA drives in the same RAID volume is not supported.
- ⚠ **CAUTION:** When installing a drive, ensure that the adjacent drives are fully installed. Inserting a drive carrier and attempting to lock its handle next to a partially installed carrier can damage the partially installed carrier's shield spring and make it unusable.
- ⚠ **CAUTION:** To prevent data loss, ensure that your operating system supports hot-swap drive installation. See the documentation supplied with your operating system.
- ⚠ **CAUTION:** When a replacement hot swappable drive is installed and the system is powered on, the drive automatically begins to rebuild. Ensure that the replacement drive is blank or contains data that you wish to overwrite. Any data on the replacement drive is immediately lost after the drive is installed.

1. Follow the safety guidelines listed in [Safety instructions](#).
2. If applicable, [remove the drive blank](#).

Steps

1. Press the release button on the front of the drive carrier to open the release handle.
2. Insert the drive carrier into the drive slot and slide until the drive connects with the backplane.
3. Close the drive carrier release handle to lock the drive in place.



Figure 52. Installing a drive carrier

Next steps

If applicable, install the front bezel.

Identifier	GUID-B8ECB7D7-9FE1-42F1-94B1-01EFFE0DCF76
Status	Released

Removing the drive from the drive carrier

Prerequisites

CAUTION: Mixing drives from previous generations of PowerEdge servers is not supported.

Steps

1. Using a Phillips #1 screwdriver, remove the screws from the slide rails on the drive carrier.
2. Lift the drive out of the drive carrier.



Figure 53. Removing the drive from the drive carrier

Next steps

If applicable, [Installing a drive into the drive carrier](#)

Identifier	GUID-6DDC18EC-DE29-4C6A-813E-885262A0C86A
Status	Released

Installing a drive into the drive carrier

Prerequisites

CAUTION: Mixing drive carriers from other generations of PowerEdge servers is not supported.

NOTE: When installing a drive into the drive carrier, ensure that the screws are torqued to 4 in-lbs.

Steps

1. Insert the drive into the drive carrier with the connector end of the drive towards the back of the carrier.
2. Align the screw holes on the drive with the screws holes on the drive carrier.
When aligned correctly, the back of the drive is flush with the back of the drive carrier.
3. Using a Phillips #1 screwdriver, secure the drive to the drive carrier with screws.



Figure 54. Installing a drive into the drive carrier

Identifier	GUID-4114DBC0-D984-4E10-AB9F-5F042BCB9AA0
Status	Released

System memory

Identifier	GUID-F8A3BFB5-6E72-436D-9454-CD776A73DA5A
Status	Released

System memory guidelines

The PowerEdge systems support DDR4 Registered DIMMs (RDIMMs), and Load Reduced DIMMs (LRDIMMs). The processor runs the instructions that are held by the system memory.

Your system contains 16 memory sockets. Processor 1 supports up to 10 memory sockets and Processor 2 supports up to six memory sockets. Six memory channels are allocated to each processor. Processor 1 has four 2xDIMM slots per channel and two 1xDIMM slot per channel. Processor 2 has six 1xDIMM per channel.

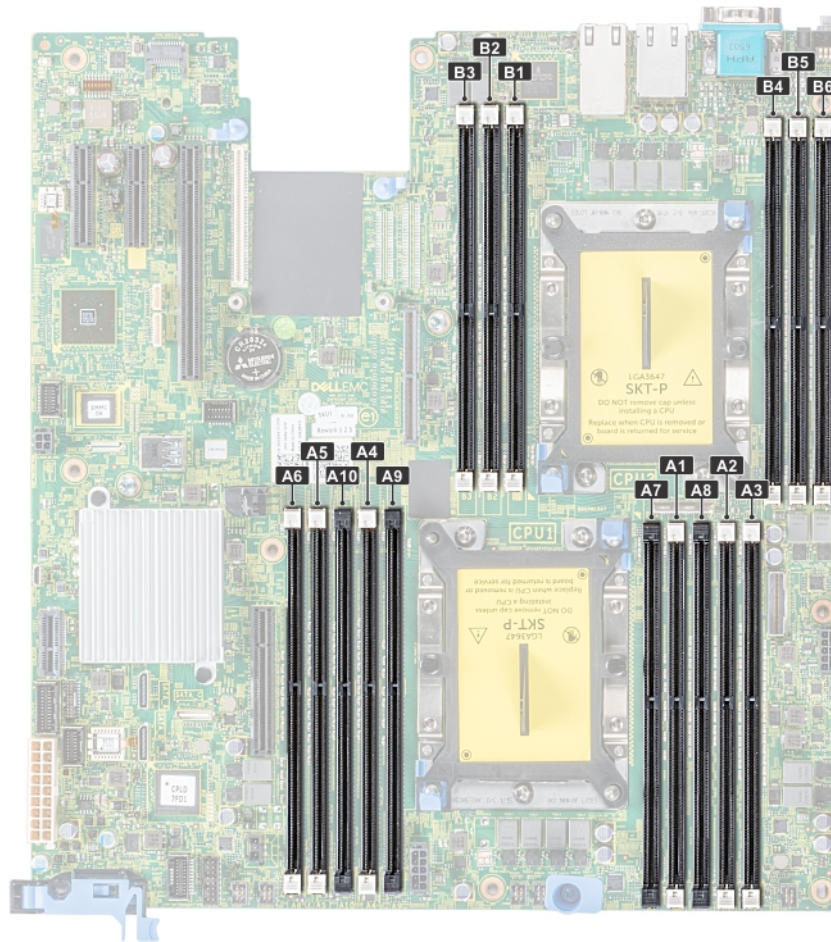

Figure 55. Memory socket locations

Memory channels are organized as follows:

Table 44. Memory channels

Processor	Channel 0	Channel 1	Channel 2	Channel 3	Channel 4	Channel 5
Processor 1	Slots A1 and A7	Slots A2 and A8	Slots A3	Slots A4 and A9	Slots A5 and A10	Slots A6
Processor 2	Slots B1	Slots B2	Slots B3	Slots B4	Slots B5	Slots B6

Identifier	GUID-ACBC0F13-DEDB-492B-A0B0-18303DED565A
Status	Released

General memory module installation guidelines

To ensure optimal performance of your system, observe the following general guidelines when configuring your system memory. If your system's memory configurations fail to observe these guidelines, your system might not boot, stop responding during memory configuration, or operate with reduced memory.

- System profile selected (for example, Performance Optimized, or Custom [can be run at high speed or lower])
- Maximum supported DIMM speed of the processors.
- Maximum supported speed of the DIMMs

NOTE: MT/s indicates DIMM speed in MegaTransfers per second.

The system supports Flexible Memory Configuration, enabling the system to be configured and run in any valid chipset architectural configuration. The following are the recommended guidelines for installing memory modules:

- All DIMMs must be DDR4.
- RDIMMs and LRDIMMs must not be mixed.

- 64 GB LRDIMMs that are DDP (Dual Die Package) LRDIMMs must not be mixed with 128 GB LRDIMMs that are TSV (Through Silicon Via/3DS) LRDIMMs.
- x4 and x8 DRAM based memory modules can be mixed.
- Up to two RDIMMs can be populated per channel regardless of rank count.
- Up to two LRDIMMs can be populated per channel regardless of rank count.
- A maximum of two different ranked DIMMs can be populated in a channel regardless of rank count.
- If memory modules with different speeds are installed, they will operate at the speed of the slowest installed memory module(s).
- Populate memory module sockets only if a processor is installed.

- For single-processor systems, sockets A1 to A10 are available.
- For dual-processor systems, sockets A1 to A10 and sockets B1 to B6 are available.
- Populate all the sockets with white release tabs first, followed by the black release tabs.
- When mixing memory modules with different capacities, populate the sockets with memory modules with the highest capacity first.

For example, if you want to mix 8 GB and 16 GB memory modules, populate 16 GB memory modules in the sockets with white release tabs and 8 GB memory modules in the sockets with black release tabs.

- Memory modules of different capacities can be mixed provided other memory population rules are followed.

For example, 8 GB and 16 GB memory modules can be mixed.

- In a dual-processor configuration, the memory configuration for each processor must be identical.

For example, if you populate socket A1 for processor 1, then populate socket B1 for processor 2, and so on.

- Mixing of more than two memory module capacities in a system is not supported.
- Unbalanced memory configurations will result in a performance loss so always populate memory channels identically with identical DIMMs for best performance.
- Populate six identical memory modules per processor (one DIMM per channel) at a time to maximize performance.
- To ensure proper system cooling, memory module blanks must be installed in memory sockets that are not occupied.

DIMM population update for Performance Optimized mode with quantity of 4 and 8 DIMMs per processor.

- When the DIMM quantity is 4 per processor, the population is slot 1, 2, 4, 5.
- When the DIMM quantity is 8 per processor, the population is slot 1, 2, 4, 5, 7, 8, 9, 10.

Identifier	GUID-7BC6FF1B-674F-4B65-BE86-1699131E66BA
Status	Released

Mode-specific guidelines

The configurations allowed depend on the memory mode selected in the System BIOS.

Table 45. Memory operating modes

Memory Operating Mode	Description
Optimizer Mode	The Optimizer Mode if enabled, the DRAM controllers operate independently in the 64-bit mode and provide optimized memory performance.
Mirror Mode	The Mirror Mode if enabled, the system maintains two identical copies of data in memory, and the total available system memory is one half of the total installed physical memory. Half of the installed memory is used to mirror the active memory modules. This feature provides maximum reliability and enables the system to continue running even during a catastrophic memory failure by switching over to the mirrored copy. The installation guidelines to enable Mirror Mode require that the memory modules be identical in size, speed, and technology, and they must be populated in sets of 6 per processor.
Single Rank Spare Mode	Single Rank Spare Mode allocates one rank per channel as a spare. If excessive correctable errors occur in a rank or channel, while the operating system is running, they are moved to the spare area to prevent errors from causing an uncorrectable failure. Requires two or more ranks to be populated in each channel.
Multi Rank Spare Mode	Multi Rank Spare Mode allocates two ranks per channel as a spare. If excessive correctable errors occur in a rank or channel,

Memory Operating Mode

Description

while the operating system is running, they are moved to the spare area to prevent errors from causing an uncorrectable failure. Requires three or more ranks to be populated in each channel.

With single rank memory sparing enabled, the system memory available to the operating system is reduced by one rank per channel.

For example, in a dual-processor configuration with sixteen 16 GB dual-rank memory modules, the available system memory: $16 \text{ GB} \times 16(\text{memory modules}) - 8\text{GB}(1 \text{ rank sparing/channel}) \times 12(\text{channel}) = 256 \text{ GB} - 96 \text{ GB} = 160 \text{ GB}$

For multi rank sparing, in a dual-processor configuration with sixteen 64 GB quad-rank memory modules, the available system memory: $64 \text{ GB} \times 16(\text{memory modules}) - 32 \text{ GB}(2 \text{ rank sparing/channel}) \times 12(\text{channel}) = 1024 \text{ GB} - 384 \text{ GB} = 640 \text{ GB}$

NOTE: To use memory sparing, this feature must be enabled in the BIOS menu of System Setup.

NOTE: Memory sparing does not offer protection against a multi-bit uncorrectable error.

Dell Fault Resilient Mode

The **Dell Fault Resilient Mode** if enabled, the BIOS creates an area of memory that is fault resilient. This mode can be used by an OS that supports the feature to load critical applications or enables the OS kernel to maximize system availability.

Optimizer Mode

This mode supports Single Device Data Correction (SDDC) only for memory modules that use x4 device width. It does not impose any specific slot population requirements.

- Dual processor: Populate the slots in round robin sequence starting with processor 1.

NOTE: Processor 1 and processor 2 population should match.

Table 46. Memory population rules

Processor	Configuration	Memory population	Memory population information
Single processor	Optimizer (Independent channel) population order	1, 2, 3, 4, 5, 6, 7, 8, 9, 10	<ul style="list-style-type: none">Populate in this order, odd amount allowed.Odd number of DIMM population is allowed. <p>NOTE: Odd number of DIMMs will result in unbalanced memory configurations, which in turn will result in performance loss. It is recommended to populate all memory channels identically with identical DIMMs for best performance.</p> <ul style="list-style-type: none">Optimizer population order is not traditional for 4 and 8 DIMM installations of single processor.<ul style="list-style-type: none">For 4 DIMMs: A1, A2, A4, A5For 8 DIMMs: A1, A2, A4, A5, A7, A8, A9, A10

Processor	Configuration	Memory population	Memory population information
	Mirror population order	{1, 2, 3, 4, 5, 6}	Mirroring is supported with 6 DIMM slots per processor.
	Single rank sparing population order	1, 2, 3, 4, 5, 6, 7, 8, 9, 10	Populate in this order, odd amount allowed. Requires two ranks or more per channel.
	Multi rank sparing population order	1, 2, 3, 4, 5, 6, 7, 8, 9, 10	Populate in this order, odd amount allowed. Requires three ranks or more per channel.
Dual processor (Populate round robin starting with processor1)	Optimized (Independent channel) population order	A{1}, B{1}, A{2}, B{2}, A{3}, B{3}...	<ul style="list-style-type: none"> • Odd amount of DIMM slots per processor allowed. • Odd number of DIMM population is allowed. <p>NOTE: Odd number of DIMMs will result in unbalanced memory configurations, which in turn will result in performance loss. It is recommended to populate all memory channels identically with identical DIMMs for best performance.</p> <ul style="list-style-type: none"> • Optimizer population order is not traditional for 8 and 14 DIMM installations of dual processor. <ul style="list-style-type: none"> • For 8 DIMMs: A1, A2, A4, A5, B1, B2, B4, B5 • For 14 DIMMs: A1, A2, A4, A5, A7, A8, A9, A10, B1, B2, B3, B4, B5, B6
	Mirroring population order	A{1, 2, 3, 4, 5, 6}, B{1, 2, 3, 4, 5, 6}	Mirroring is supported with 6 DIMM slots per processor.
	Single rank sparing population order	A{1}, B{1}, A{2}, B{2}, A{3}, B{3}...	Populate in this order, odd amount per processor allowed. Requires two ranks or more per channel.
	Multi rank sparing population order	A{1}, B{1}, A{2}, B{2}, A{3}, B{3}...	Populate in this order, odd amount per processor allowed. Requires three ranks or more per channel.

Identifier	GUID-872FF086-58C6-4003-BF09-C31E7FD932C8
Status	Released

Removing a memory module

Prerequisites

1. Follow the safety guidelines listed in [Safety instructions](#).
2. Follow the procedure listed in [Before working inside your system](#).
3. If applicable, [Removing the air shroud](#)

⚠ WARNING: Allow the memory modules to cool after you power off the system. Handle the memory modules by the card edges and avoid touching the components or metallic contacts on the memory module.

Steps

1. Locate the appropriate memory module socket.

CAUTION: Handle each memory module only by the card edges, ensuring not to touch the middle of the memory module or metallic contacts.

2. Push the ejectors outward on both ends of the memory module socket to release the memory module from the socket.
3. Lift and remove the memory module from the system.

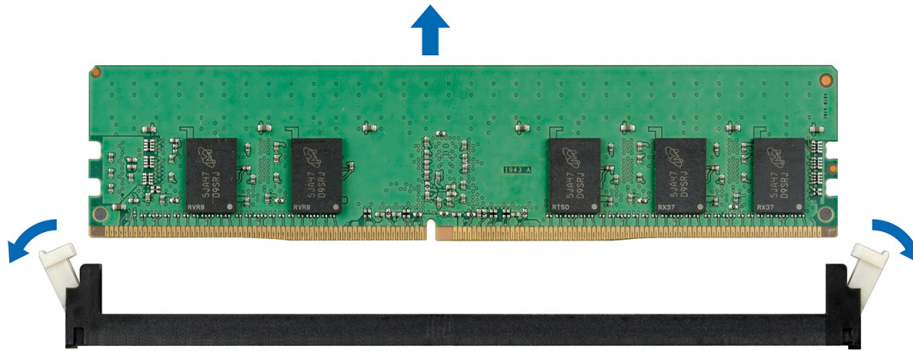

Figure 56. Removing a memory module

Identifier	GUID-716E4B9C-3755-4CD3-A3A9-4ADEC7089C91
Status	Released

Installing a memory module

Prerequisites

Follow the safety guidelines listed in [Safety instructions](#).

Steps

1. Locate the appropriate memory module socket.

CAUTION: Handle each memory module only by the card edges, ensuring not to touch the middle of the memory module or metallic contacts.

CAUTION: To prevent damage to the memory module or the memory module socket during installation, do not bend or flex the memory module. You must insert both ends of the memory module simultaneously.

2. Open the ejectors on the memory module socket outward to allow the memory module to be inserted into the socket.
3. Align the edge connector of the memory module with the alignment key of the memory module socket, and insert the memory module in the socket.

CAUTION: Do not apply pressure at the center of the memory module; apply pressure at both ends of the memory module evenly.

NOTE: The memory module socket has an alignment key that enables you to install the memory module in the socket in only one orientation.

4. Press the memory module with your thumbs until the socket levers firmly click into place.

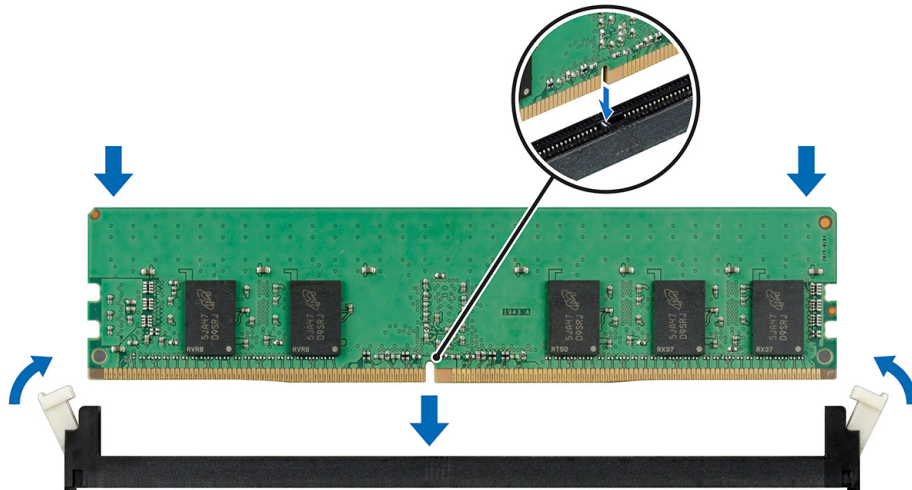

Figure 57. Installing a memory module

Next steps

1. [Installing the air shroud](#)
2. Follow the procedure listed in [After working inside your system](#).
3. To verify if the memory module has been installed properly, press F2 and navigate to **System Setup Main Menu > System BIOS > Memory Settings**. In the **Memory Settings** screen, the System Memory Size must reflect the updated capacity of the installed memory.
4. If the value is incorrect, one or more of the memory modules may not be installed properly. Ensure that the memory module is firmly seated in the memory module socket.
5. Run the system memory test in system diagnostics.

Identifier	GUID-4B898F3E-34A5-4E37-80D7-F393575EF62F
Status	Released

Processors and heat sinks

Identifier	GUID-A6DD4597-85DE-4C80-A836-104D468ABCAB
Status	Released

Removing a processor and heat sink module

Prerequisites

⚠ WARNING: The heat sink may be hot to touch for some time after the system is powered down. Allow the heat sink to cool before removing it.

1. Follow the safety guidelines listed in [Safety instructions](#).
2. Follow the procedure listed in [Before working inside your system](#).
3. [Remove the air shroud](#).

Steps

1. Using a Torx #T30 screwdriver, loosen the screws on the heat sink in the order below:
 - a) Loosen the first screw three turns.
 - b) Loosen the second screw completely.
 - c) Return to the first screw and loosen it completely.
2. Pushing both blue retention clips simultaneously, lift the processor and heat sink module (PHM) processor and heat sink module
3. Set the PHM aside with the processor side facing up.

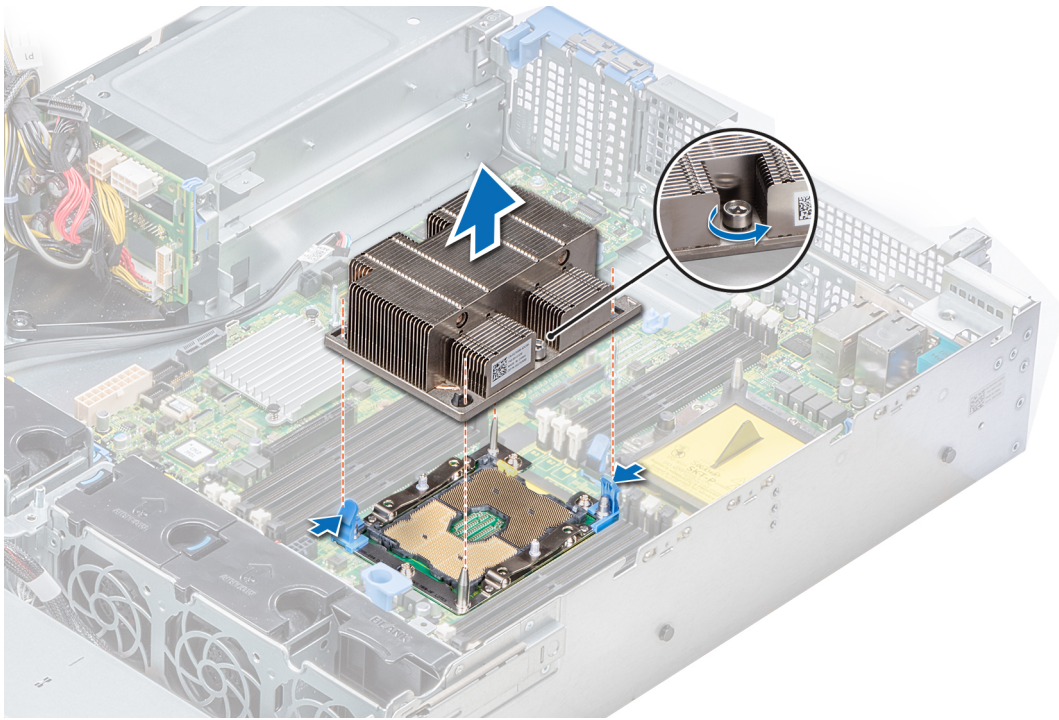

Figure 58. Removing processor and heat sink module

Next steps

Installing a processor and heat sink module

Identifier	GUID-DCF6A3CA-C546-42E3-9F88-47E58B05CE7F
Status	Released

Removing the non-fabric processor from the processor and heat sink module

Prerequisites

NOTE: Only remove the processor from the processor and heat sink module if you are replacing the processor or heat sink. This procedure is not required when replacing a system board.

1. Follow the safety guidelines listed in [Safety instructions](#).
2. Follow the procedure listed in [Before working inside your system](#).
3. [Removing the air shroud](#)
4. [Removing a processor and heat sink module](#)

Steps

1. Place the heat sink with the processor side facing up.
2. Insert a flat blade screwdriver into the release slot marked with a yellow label. Twist (do not pry) the screwdriver to break the thermal paste seal.
3. Push the retaining clips on the processor bracket to unlock the bracket from the heat sink.

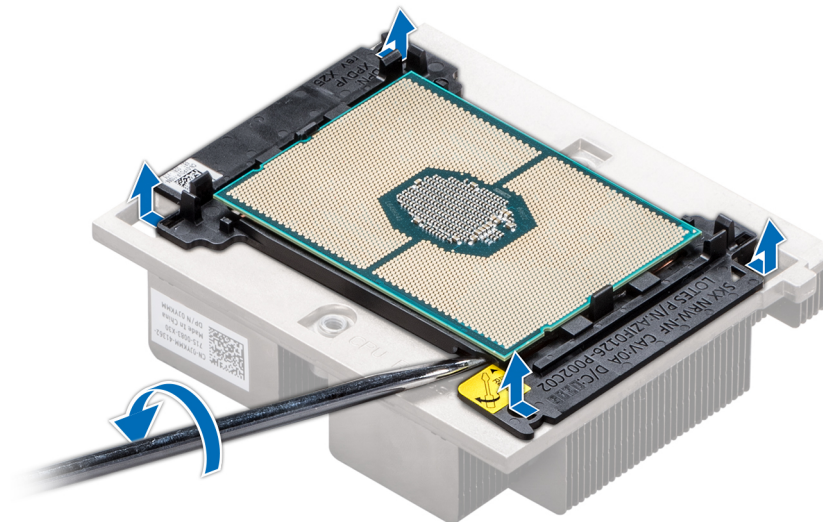

Figure 59. Loosening the processor bracket

4. Lift the bracket and the processor away from the heat sink, and place the processor connector side down on the processor tray.
5. Flex the outer edges of the bracket to release the bracket from the processor.

NOTE: Ensure that the processor and the bracket are placed in the tray after you remove the heat sink.



Figure 60. Removing the processor bracket

Next steps

[Installing a processor and heat sink module](#)

Identifier	GUID-8AA70E3E-ABA2-4E96-AD54-E3290CB71A70
Status	Released

Installing the non-fabric processor into a processor and heat sink module

Prerequisites

Follow the safety guidelines listed in [Safety instructions](#).

Steps

1. Place the processor in the processor tray.

i **NOTE:** Ensure that the pin 1 indicator on the processor tray is aligned with the pin 1 indicator on the processor.

2. Flex the outer edges of the bracket around the processor ensuring that the processor is locked into the clips on the bracket.

i **NOTE:** Ensure that the pin 1 indicator on the bracket is aligned with the pin 1 indicator on the processor before placing the bracket on the processor.

i **NOTE:** Ensure that the processor and the bracket are placed in the tray before you install the heat sink.



Figure 61. Installing the processor bracket

3. If you are using an existing heat sink, remove the thermal grease from the heat sink by using a clean lint-free cloth.
4. Use the thermal grease syringe included with your processor kit to apply the grease in a quadrilateral design on the top of the processor.

⚠ CAUTION: Applying too much thermal grease can result in excess grease coming in contact with and contaminating the processor socket.

i **NOTE:** The thermal grease syringe is intended for single use only. Dispose the syringe after you use it.

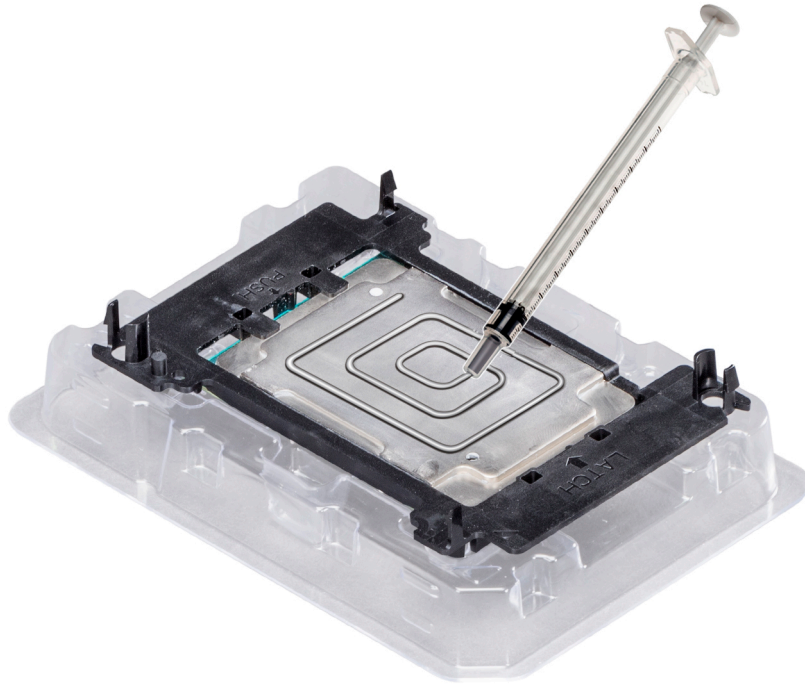

Figure 62. Applying thermal grease on top of the processor

5. Place the heat sink on the processor and push down on the base of the heat sink until the bracket locks onto the heat sink.

NOTE:

- Ensure that the two guide pin holes on the bracket match the guide holes on the heat sink.
- Do not press on the heat sink fins.
- Ensure that the pin 1 indicator on the heat sink is aligned with the pin 1 indicator on the bracket before placing the heat sink onto the processor and bracket.

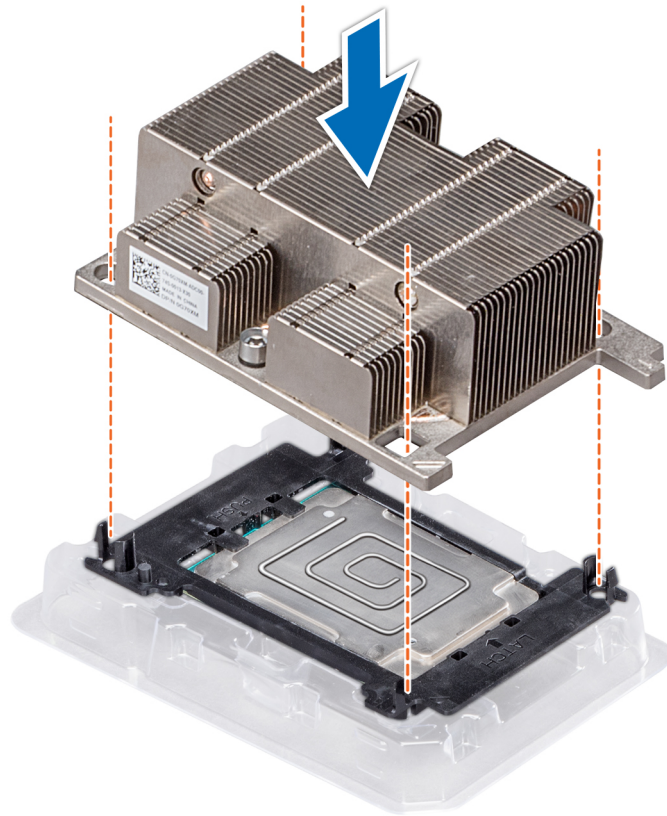

Figure 63. Installing the heat sink onto the processor

Next steps

1. [Installing a processor and heat sink module](#)
2. [Installing the air shroud](#)
3. Follow the procedure listed in [After working inside your system](#).

Identifier	GUID-A6F8B9E2-D58B-4AAB-B13F-2F7F2A7A583C
Status	Released

Installing a processor and heat sink module

Prerequisites

CAUTION: Never remove the heat sink from a processor unless you intend to replace the processor. The heat sink is necessary to maintain proper thermal conditions.

1. Follow the safety guidelines listed in [Safety instructions](#).
2. If installed, remove the CPU dust cover.

Steps

1. Align the pin 1 indicator of the heat sink to the system board and then place the processor and heat sink module (PHM) on the processor socket.

CAUTION: To avoid damaging the fins on the heat sink, do not press down on the heat sink fins.

NOTE: Ensure that the PHM is held parallel to the system board to prevent damaging the components.

2. Push the blue retention clips inward to allow the heat sink to drop into place.
3. Using the Torx #T30 screwdriver, tighten the screws on the heat sink in the order below:

- a) Partially tighten the first screw (approximately 3 turns).
- b) Tighten the second screw completely.
- c) Return to the first screw and tighten it completely.

If the PHM slips off the blue retention clips when the screws are partially tightened, follow these steps to secure the PHM:

- a. Loosen both the heat sink screws completely.
- b. Lower the PHM on to the blue retention clips, following the procedure described in step 2.
- c. Secure the PHM to the system board, following the replacement instructions listed in this step above. 4.

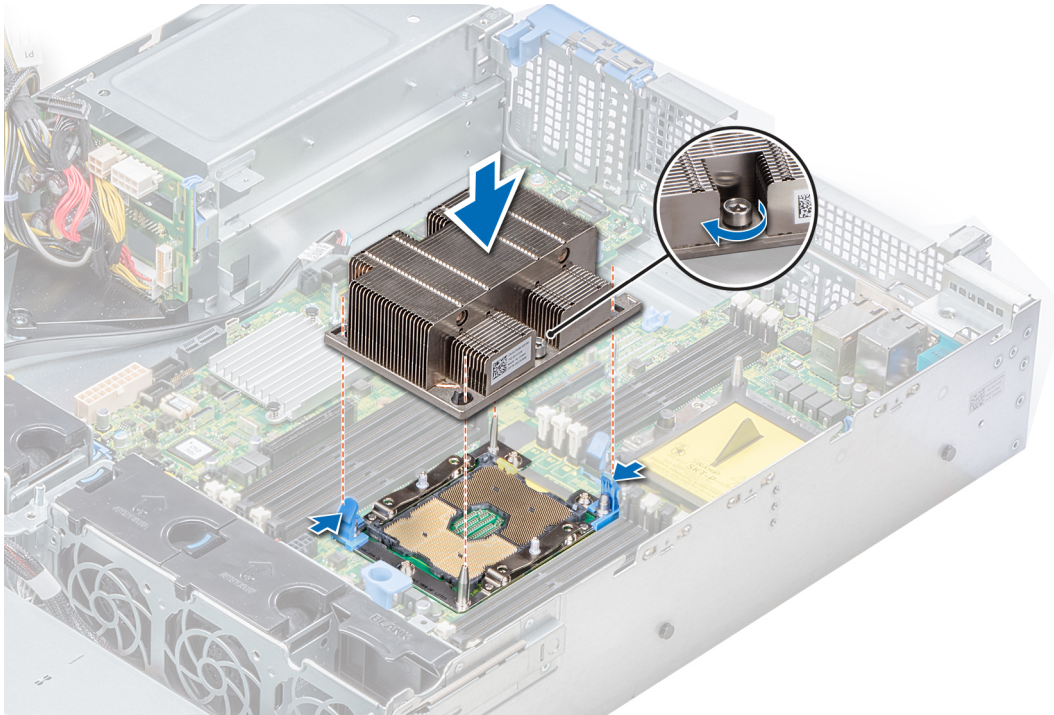

Figure 64. Installing the processor and heat sink module

Next steps

1. [Install the air shroud.](#)
2. Follow the procedure listed in [After working inside your system.](#)

Identifier	GUID-9236BC8B-A5E5-43DD-8BA1-BE9A68C4B05B
Status	Released

Expansion cards and expansion card risers

Identifier	GUID-6572CCE6-C41F-42FC-8950-7E3C175923C0
Status	Released

Expansion card installation guidelines

The following table describes the supported expansion cards:

Table 47. Expansion card riser configurations

Expansion card riser	PCIe slots on the riser	Processor connection	Height	Length	Slot width
Full height right riser	Slot 2	Processor 1	Full Height	Half Length	x16
Low profile right riser	Slot 2	Processor 1	Low Profile	Half Length	x16
Low profile left riser	Slot 3	Processor 2	Low Profile	Half Length	x16
Butterfly riser	Slot 2	Processor 1	Full Height	Half Length	x16

Expansion card riser	PCIe slots on the riser	Processor connection	Height	Length	Slot width
Butterfly riser	Slot 3	Processor 1	Low Profile	Half Length	x8

NOTE: The expansion-card slots are not hot-swappable.

The following table provides guidelines for installing expansion cards to ensure proper cooling and mechanical fit. The expansion cards with the highest priority should be installed first using the slot priority indicated. All the other expansion cards should be installed in the card priority and slot priority order.

Table 48. Riser configurations: No RSR - 1 CPU

Card Type	Slot Priority	Maximum number of cards
LOM riser ; 2x1G BCM5720L (FXN)	1	1
LOM riser ; 2x10G BCM57416 (BASeT/SFP +) (FXN)	1	1
PCIe SSD PCIe Card (Samsung)	5	1
Card,Network (Broadcom/INTEL/Mellanox/Solarflare)	5	1
Card,Controller (EMULEX/QLOGIC/)	5	1
Intel OPA NIC (Intel OPA)	5	1
BOSS M.2 (SATA) (Dell)	5	1
Card,Network (Broadcom/INTEL)	6, 5	2
PERC9.14G/PERC10 (FXN)	Integrated Slot	1
RAID - PERC9.14G/PERC10 (Internal) (Dell)	Integrated Slot	1

Table 49. Riser configurations: No RSR - 2 CPU

Card type	Slot priority	Maximum number of cards
LOM riser ; 2x1G BCM5720L (FXN)	1	1
LOM riser ; 2x10G BCM57416 (BASeT/SFP +) (FXN)	1	1
Card,Network (Broadcom/INTEL/Mellanox/Solarflare)	4, 5	2
Card,Controller (EMULEX/QLOGIC)	4, 5	2
Intel OPA NIC (Intel OPA)	4, 5	2
BOSS M.2 (SATA) (Dell)	4, 5	2
Card,Network (Braodcom/INTEL)	6, 5, 4	3
PERC9.14G/PERC10 (FXN)	Integrated Slot	1
RAID - PERC9.14G/PERC10 (Internal) (Dell)	Integrated Slot	1

Table 50. Riser configurations: FH - 1 CPU and 2 CPU

Card type	Slot priority	Maximum number of cards
LOM riser ; 2x1G BCM5720L (FXN)	1	1
LOM riser ; 2x10G BCM57416 (BASeT/SFP +)	1	1
PERC9.14G/PERC10 (FXN)	2	1
RAID - PERC10 (External) (Dell)	2	1
PCIe SSD PCIe Card (Samsung)	2	1

Card type	Slot priority	Maximum number of cards
NIC (Broadcom/INTEL/EMULEX/Mellanox/Solarflare)	2	1
Card,Network (Broadcom/INTEL/Mellanox/INTEL)	2	1
Card,Controller (EMULEX/QLOGIC)	2	1
BOSS M.2 (SATA) (Dell)	2	1
PERC9.14G/PERC10 (FXN)	Integrated Slot	1
RAID - PERC9.14G/PERC10 (Internal)	Integrated Slot	1

Table 51. Riser configurations: LP + LP - 2 CPU

Card type	Slot priority	Maximum number of cards
LOM riser ; 2x1G BCM5720L	1	1
LOM riser ; 2x10G BCM57416 (BASeT/SFP +)	1	1
PCIe SSD PCIe Card (Samsung)	3, 2	2
Card,Network (Broadcom/INTEL/Mellanox/Solarflare)	3, 2	2
Card,Controller (EMULEX/QLOGIC)	3, 2	2
Intel OPA NIC (Intel OPA)	3, 2	2
BOSS M.2 (SATA) (Dell)	3, 2	2
PERC9.14G/PERC10 (FXN)	Integrated Slot	1
RAID - PERC9.14G/PERC10 (Internal) (Dell)	Integrated Slot	1

Table 52. Riser configurations: BTF + 3 XLP - 1 CPU

Card type	Slot priority	Maximum number of cards
LOM riser ; 2x1G BCM5720L	1	1
LOM riser ; 2x10G BCM57416 (BASeT/SFP +)	1	1
PERC9.14G/PERC10 (FXN)	2	1
RAID - PERC10 (External) (Dell)	2	1
NIC (Broadcom/INTEL/Emulex/Mellanox/Solarflare)	2	1
Card,Network (Broadcom/INTEL/Mellanox/Solarflare)	2	1
Card,Controller (EMULEX/QLOGIC)	2	1
BOSS M.2 (SATA) (Dell)	2	1
PCIe SSD PCIe Card (Samsung)	3, 2, 5	3
Card,Controller (QLOGIC/EMULEX)	3, 2, 5	3
Card,Network (Broadcom/INTEL/Mellanox/QLOGIC/Solarflare)	3, 5	2
Card,Controller (QLOGIC)	3, 5	2
Intel OPA NIC (Intel OPA)	3, 5	2
BOSS M.2 (SATA) (Dell)	3, 5	2
Card,Network (Broadcom)	6, 5, 3	3

Card type	Slot priority	Maximum number of cards
Card,Network (INTEL)	6, 5, 3	3
PERC9.14G/PERC10 (FXN)	Integrated Slot	1
RAID - PERC9.14G/PERC10 (Internal) (Dell)	Integrated Slot	1

Table 53. Riser configurations: BTF + 3 XLP - 2 CPU

Card type	Slot priority	Maximum number of cards
LOM riser ; 2x1G BCM5720L (FXN)	1	1
LOM riser ; 2x10G BCM57416 (BASeT/SFP +) (FXN)	1	1
PERC9.14G/PERC10 (FXN)	2	1
RAID - PERC10 (External) (Dell)	2	1
Broadcom NIC (Broadcom)	2	1
Card,Network (Broadcom/INTEL)	2	1
NIC (Intel/Emulex/Mellanox/Solarflare)	2	1
Card,Controller (EMULEX/QLOGIC)	2	1
Card,Network (Mellanox/QLOGIC/INTEL/Solarflare)	2	1
BOSS M.2 (SATA) (Dell)	2	1
PCIe SSD PCIe Card (Samsung)	3, 4, 2, 5	4
Card,Controller (QLOGIC)	3, 4, 2, 5	4
Card,Network (Broadcom/INTEL/Mellanox/QLOGIC)	4, 3, 5	3
Card,Controller (EMULEX/QLOGIC)	4, 3, 5	3
Intel OPA NIC (Intel OPA)	4, 3, 5	3
Card,Network (Solarflare)	4, 3, 5	3
BOSS M.2 (SATA) (Dell)	4, 3, 5	3
Card,Network (Broadcom/INTEL)	6, 5, 4, 3	4
PERC9.14G/PERC10 (FXN)	Integrated Slot	1
RAID - PERC9.14G/PERC10 (Internal)	Integrated Slot	1

Identifier	GUID-CD980F3D-AEE3-42C0-BDE9-EF221FBCA4BE
Status	Released

Removing expansion card from the expansion card riser

Prerequisites

1. Follow the safety guidelines listed in [Safety instructions](#).
2. Follow the procedure listed in [Before working inside your system](#).
3. If applicable, [Removing the air shroud](#).
4. If applicable, disconnect the cables from the expansion card.
5. When removing a card from low profile, full height X1, or butterfly riser, ensure that the PCIe card holder latch is closed.

Steps

1. Pull and lift up the expansion card retention latch lock to open.
2. Hold the expansion card by its edges, and pull the card until the card edge connector disengages from the expansion card connector on the riser.

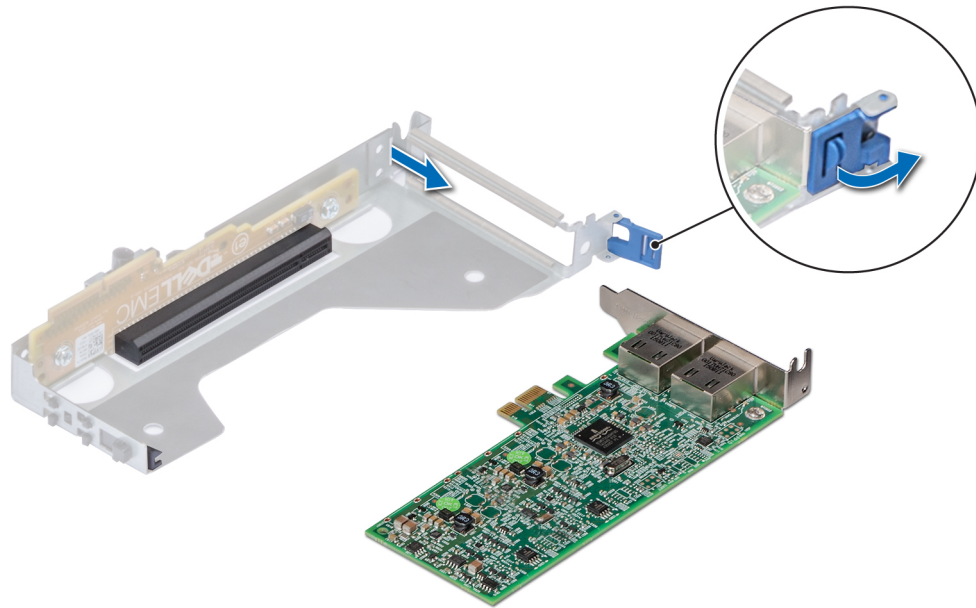

Figure 65. Removing expansion card from low profile riser

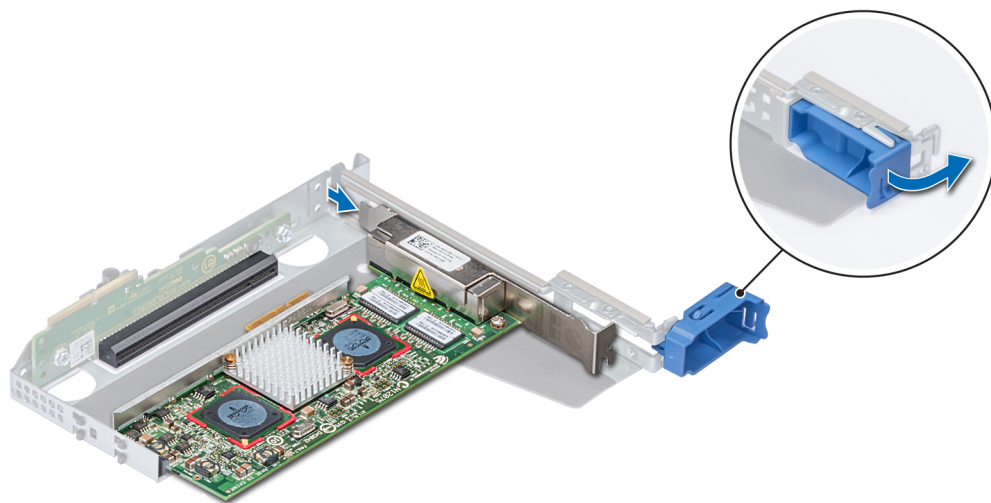

Figure 66. Removing expansion card from full height X1 riser

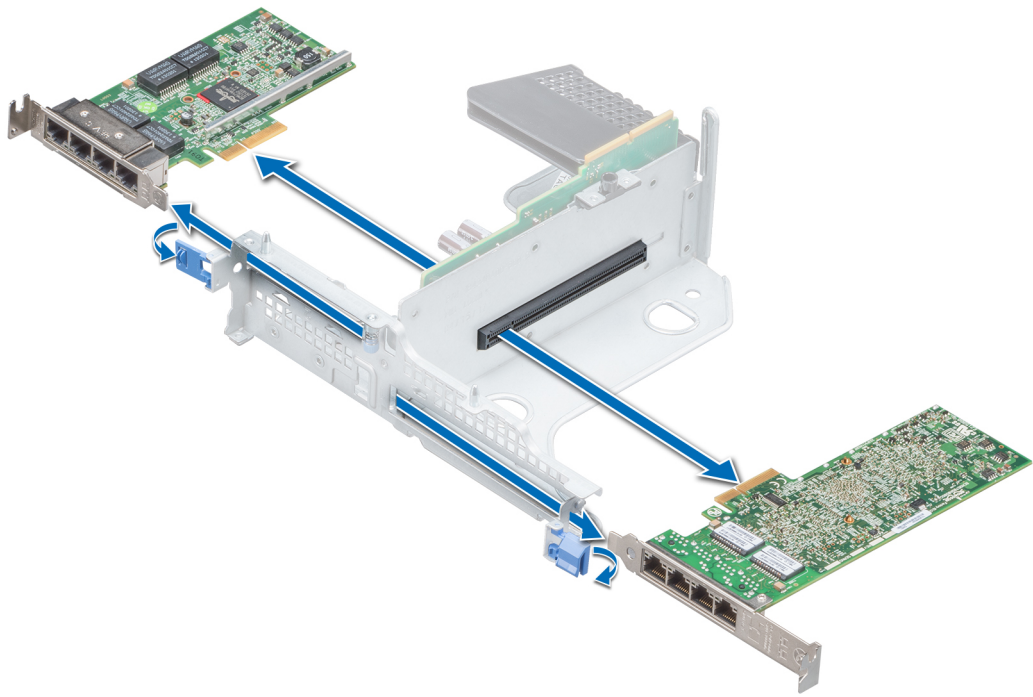

Figure 67. Removing expansion card from butterfly riser

3. If the expansion card is not going to be replaced, install a filler bracket.

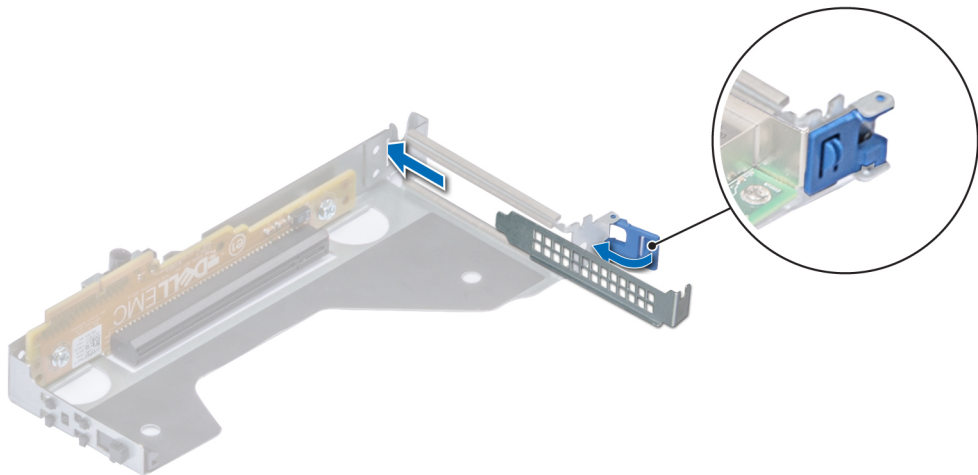

Figure 68. Installing filler bracket for low profile riser

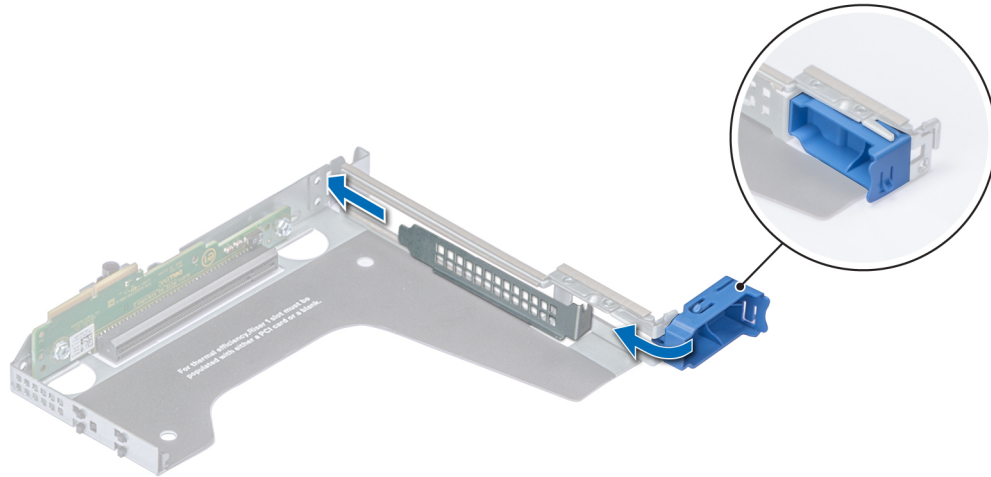

Figure 69. Installing filler bracket for full height X1 riser

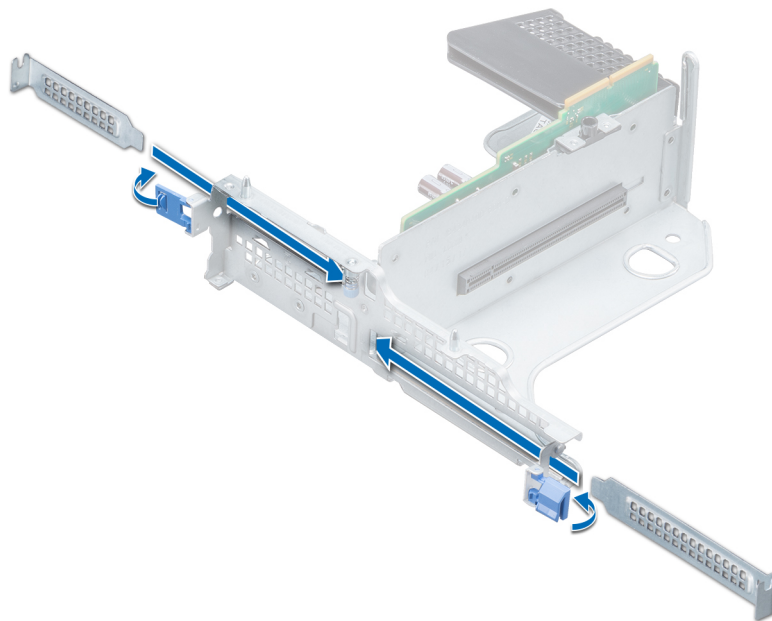

Figure 70. Installing filler bracket for butterfly riser

Next steps

1. [Install expansion card into the expansion card riser.](#)
2. If you are removing the card permanently, install a metal filler bracket over the empty expansion slot opening and push the expansion card latch.

NOTE: You must install a filler bracket over an empty expansion card slot to maintain Federal Communications Commission (FCC) certification of the system. The brackets also keep dust and dirt out of the system and aid in proper cooling and airflow inside the system.

Identifier	GUID-BC2E9CC9-CF27-4FBA-AB10-D73099A46C9E
Status	Released

Installing expansion card into the expansion card riser

Prerequisites

1. Follow the safety guidelines listed in [Safety instructions](#).
2. If installing a new expansion card, unpack it and prepare the card for installation.
3. When installing a card into low profile, full height X1, or butterfly riser, open the PCIe card holder latch.

NOTE: For instructions, see the documentation accompanying the card.

Steps

1. Pull and lift up the expansion card retention latch lock to open
2. If installed, remove the filler bracket.

NOTE: Store the filler bracket for future use. Filler brackets must be installed in empty expansion card slots to maintain Federal Communications Commission (FCC) certification of the system. The brackets also keep dust and dirt out of the system and aid in proper cooling and airflow inside the system.

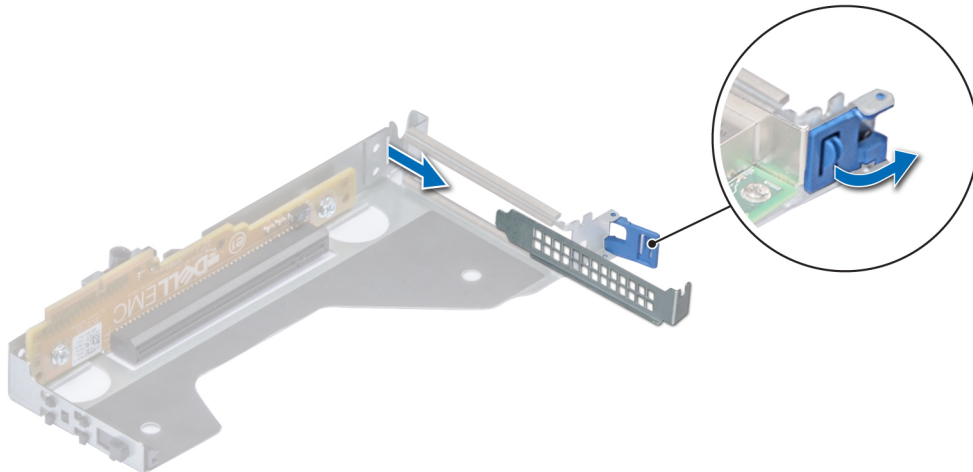

Figure 71. Removing filler bracket for low profile riser

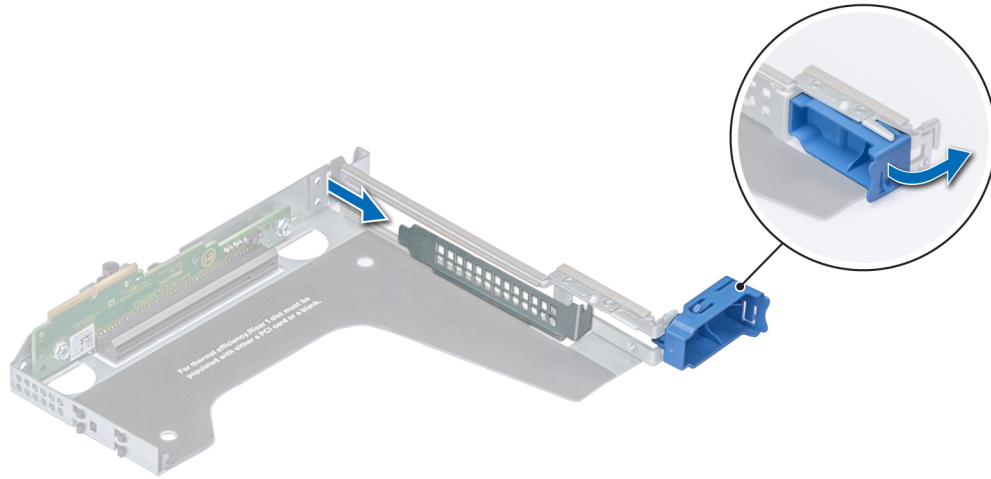

Figure 72. Removing filler bracket for full height X1 riser

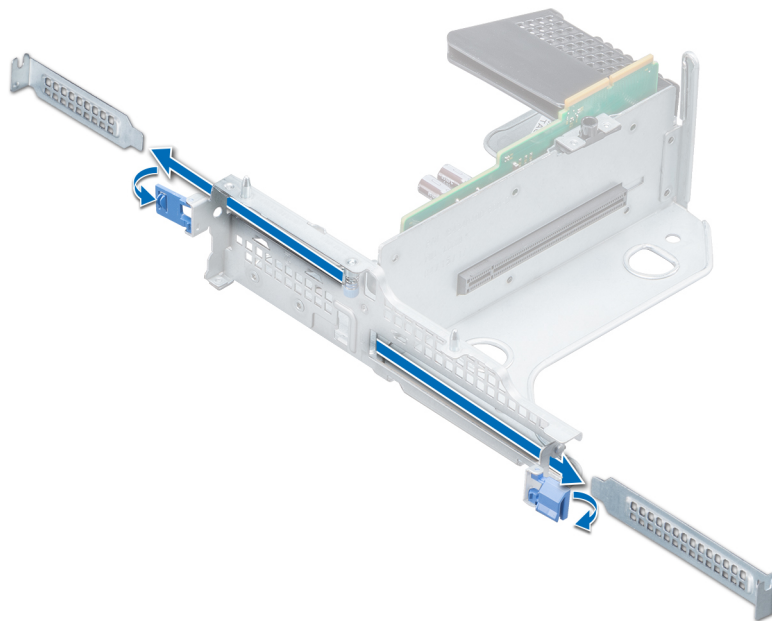

Figure 73. Removing filler bracket for butterfly riser

3. Hold the card by its edges, and align the card edge connector with the expansion card connector on the riser.
4. Insert the card edge connector firmly into the expansion card connector until the card is fully seated.
5. Close the expansion card retention latch.

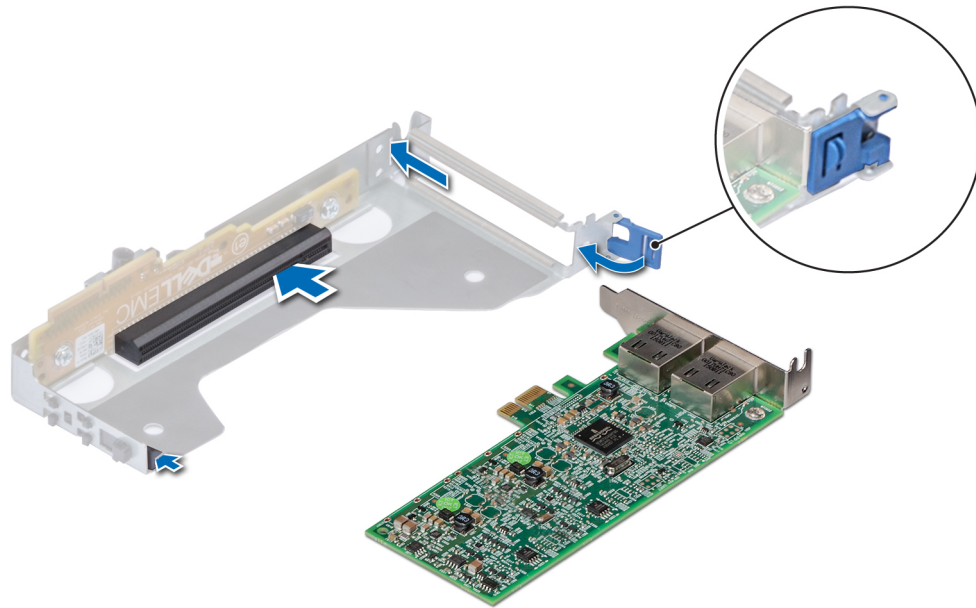

Figure 74. Installing expansion card into low profile riser

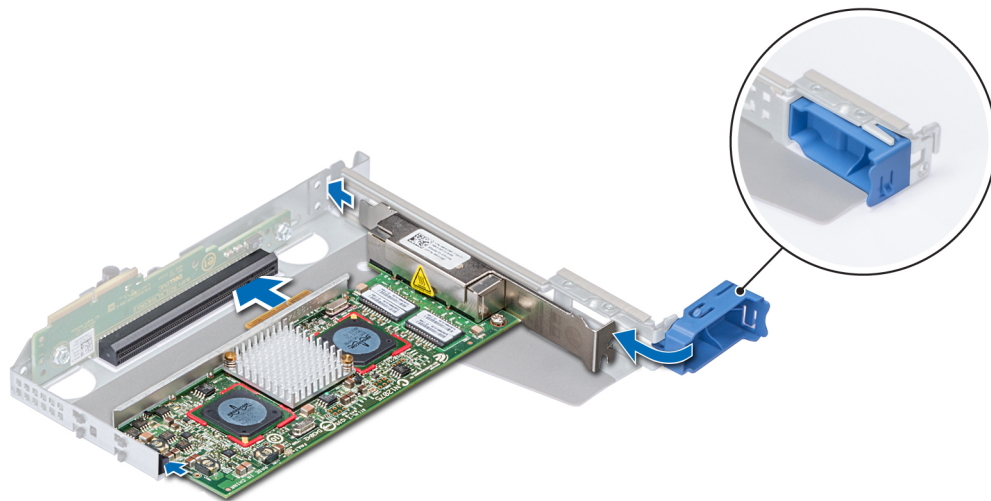

Figure 75. Installing expansion card into full height X1 riser

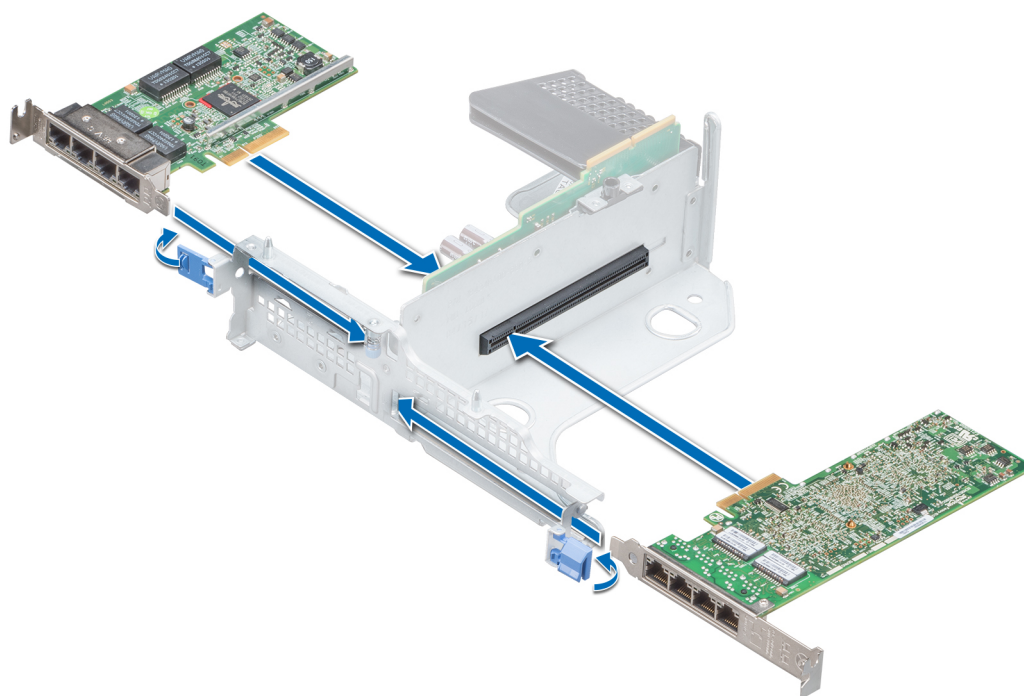

Figure 76. Installing expansion card into butterfly riser

Next steps

1. If applicable, connect the cables to the expansion card.
2. If applicable, [install air shroud](#).
3. Follow the procedure listed in [After working inside your system](#).
4. Install any device drivers required for the card as described in the documentation for the card.

Identifier	GUID-E599244F-C343-4659-8FA0-84E0A300FF3F
Status	Released

Removing expansion card from the system board

Prerequisites

1. Follow the safety guidelines listed in [Safety instructions](#).
2. Follow the procedure listed in [Before working inside your system](#).
3. Disconnect any cables connected to the expansion card.

Steps

1. Pull and lift up the expansion card retention latch lock to open.
2. Hold the expansion card by the edge and pull the card to disconnect from the system board connector.

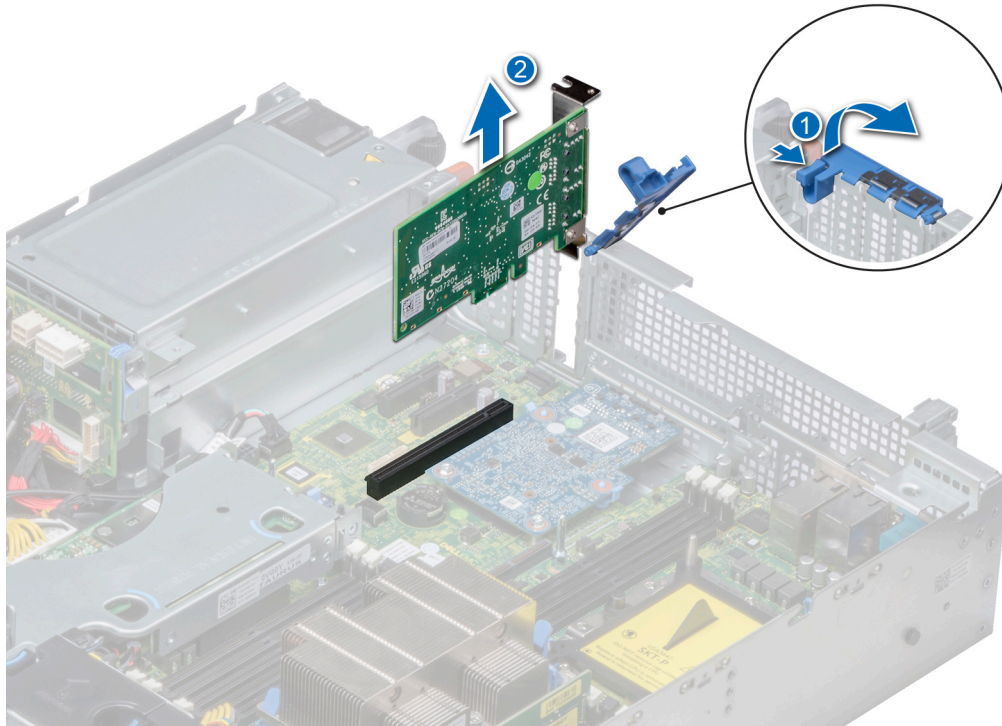

Figure 77. Removing expansion card from system board

3. If the expansion card is not going to be replaced, install a filler bracket by performing the following steps:
 - a) Align the filler bracket with the slot on the system.
 - b) Push the filler bracket downward until firmly seated.
 - c) Close the expansion card retention latch by pushing the latch down until the latch snaps into place.

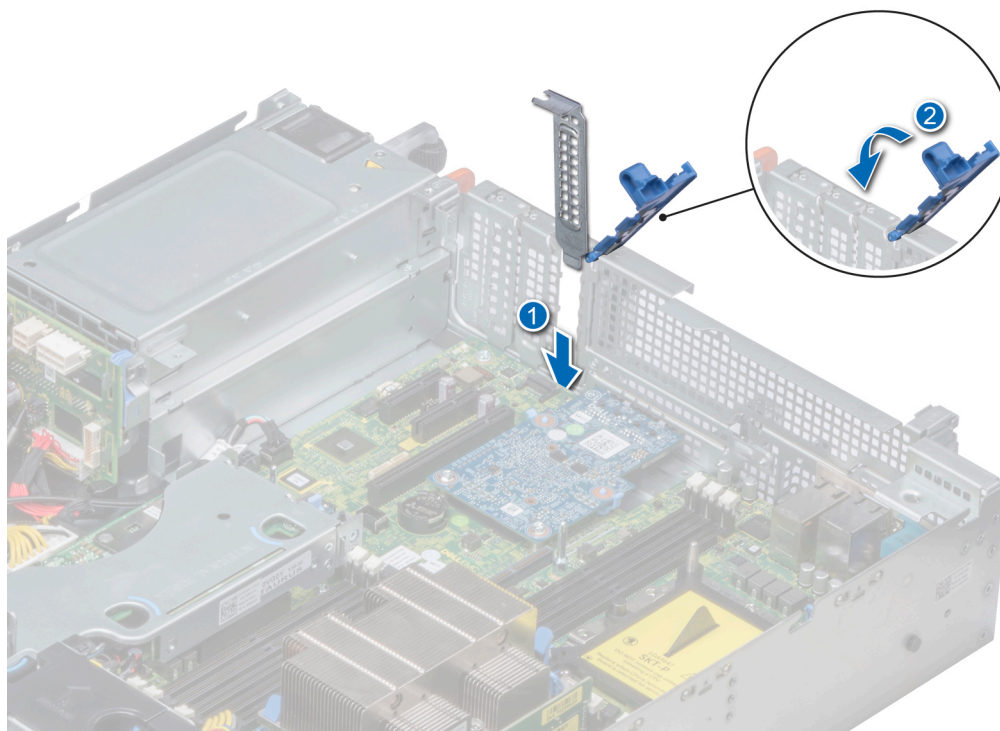

Figure 78. Installing the filler bracket

- NOTE:** Filler brackets must be installed over empty expansion card slots to maintain FCC certification of the system. The brackets also keep dust and dirt out of the system and aid in proper cooling and airflow inside the system.

Next steps

1. [Install the expansion card on the system board](#)

Identifier	GUID-E6011F3C-F49B-452C-919A-434F9DC73430
Status	Released

Installing expansion card on the system board

Prerequisites

1. Follow the safety guidelines listed in [Safety instructions](#).

Steps

1. Unpack the expansion card and prepare it for installation.
For instructions, see the documentation accompanying the card.
2. If you are installing a new card, remove the filler bracket.
 - a) Pull and lift up the expansion card retention latch lock to open.
 - b) Pull the filler bracket upward out of the system.

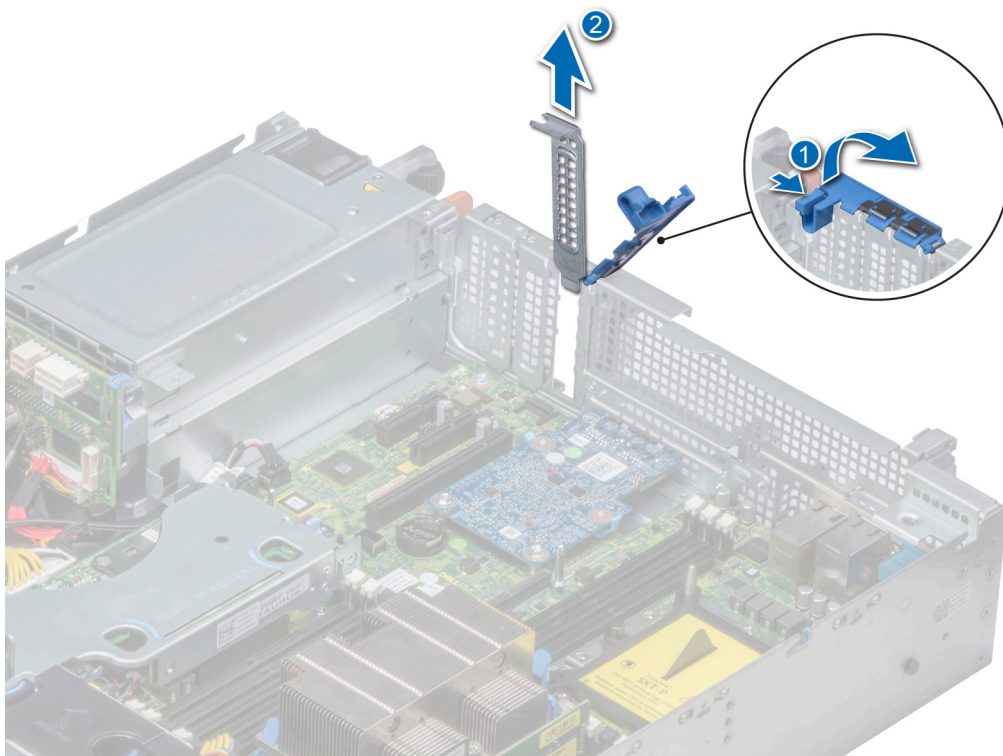

Figure 79. Removing the filler bracket

NOTE: Store the filler bracket for future use. Filler brackets must be installed in empty expansion card slots to maintain FCC certification of the system. The brackets also keep dust and dirt out of the system and aid in proper cooling and airflow inside the system.

3. Holding the card on the edges, align the card with the expansion card connector on the system board.
4. Press the expansion card firmly into the expansion card connector on the system board until the card is fully seated.
5. Close the expansion card retention latch by pushing the latch down until the latch snaps into place.

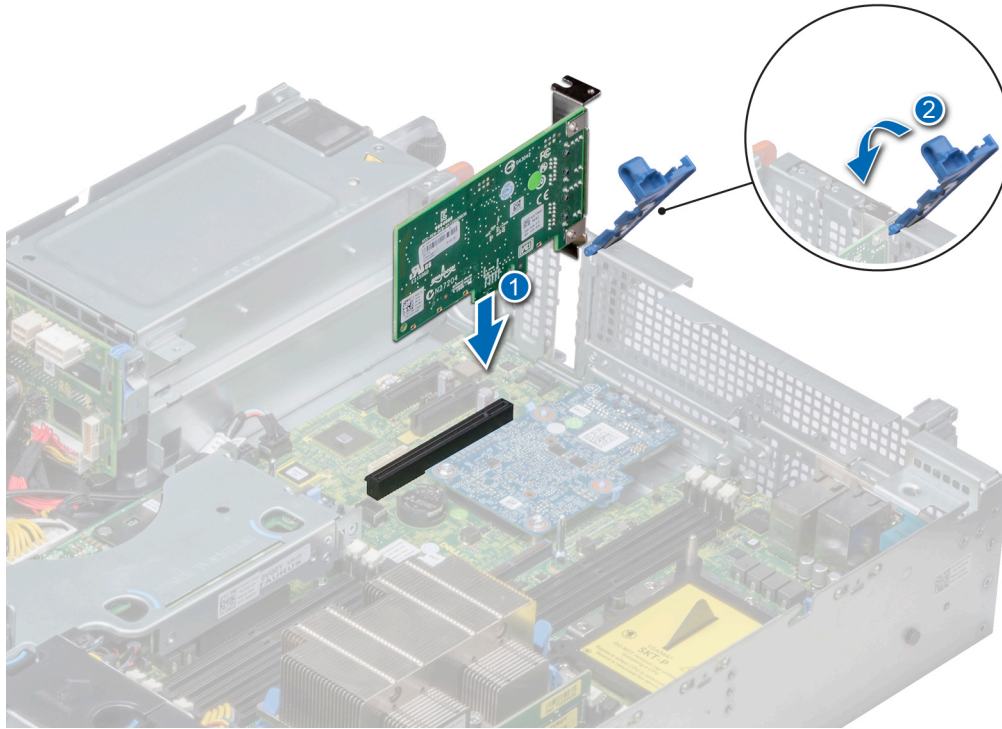

Figure 80. Installing expansion card on system board

Next steps

1. Connect the required cables to the expansion card.
2. Follow the procedure listed in [After working inside your system](#).

Identifier	GUID-1E6E5C3D-4BED-4C4C-BD0D-A09D77C01F82
Status	Released

Removing an expansion card riser

Prerequisites

1. Follow the safety guidelines listed in [Safety instructions](#).
2. Follow the procedure listed in [Before working inside your system](#).
3. Disconnect any cables connected to the expansion card.

Steps

Hold the touch points, and lift the expansion card riser, from the riser connector, on the system board.

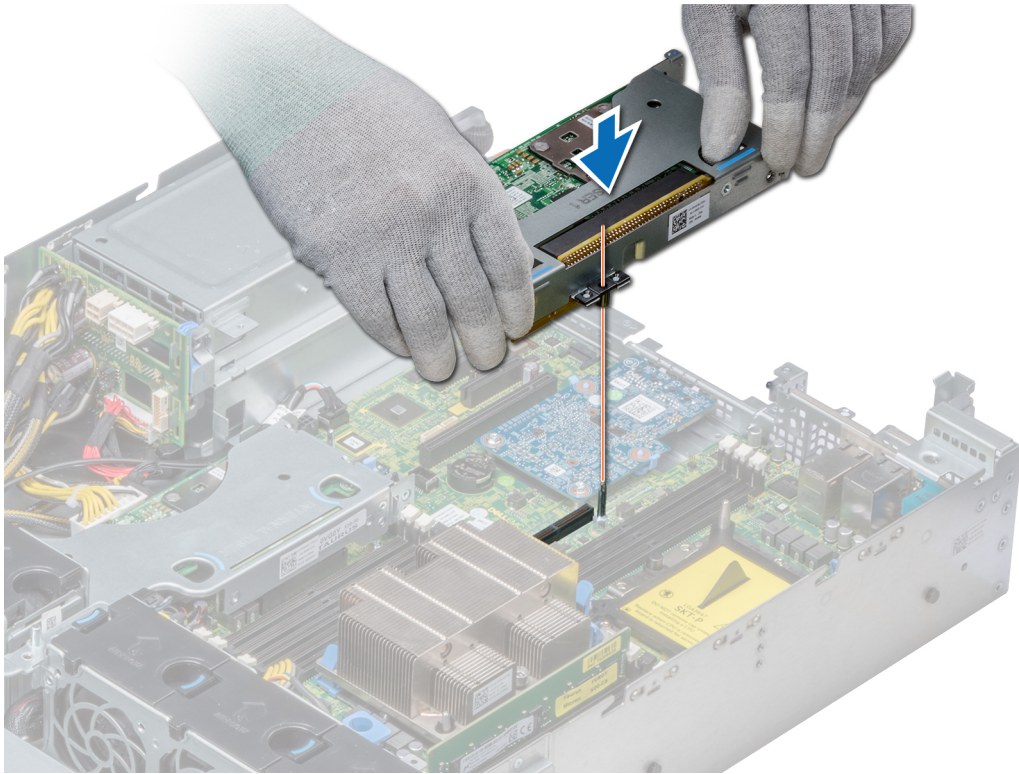

Figure 81. Removing low profile riser right

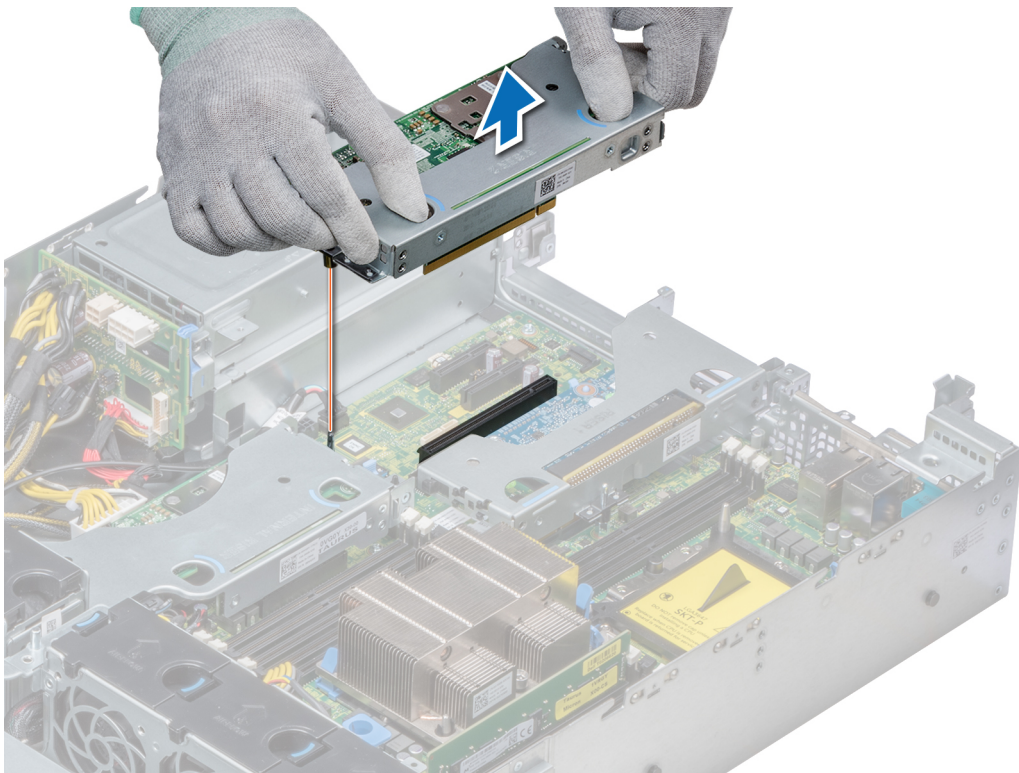

Figure 82. Removing low profile riser left

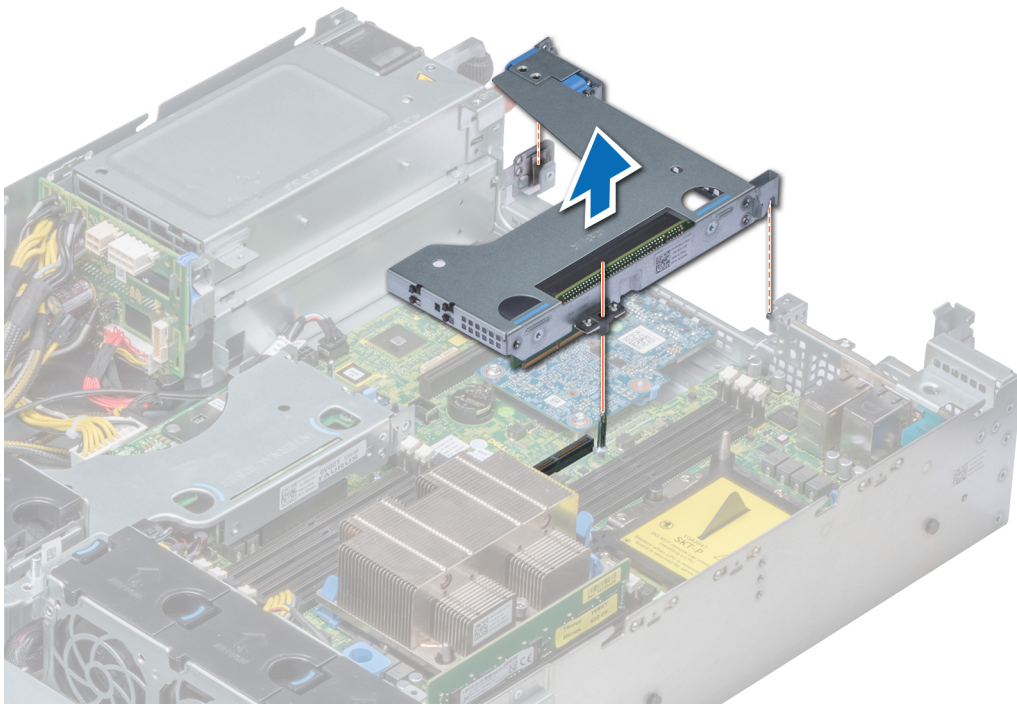

Figure 83. Removing full height X1 riser

NOTE: For butterfly riser, loosen the captive screw and holding the touch points lift the riser away from the system.

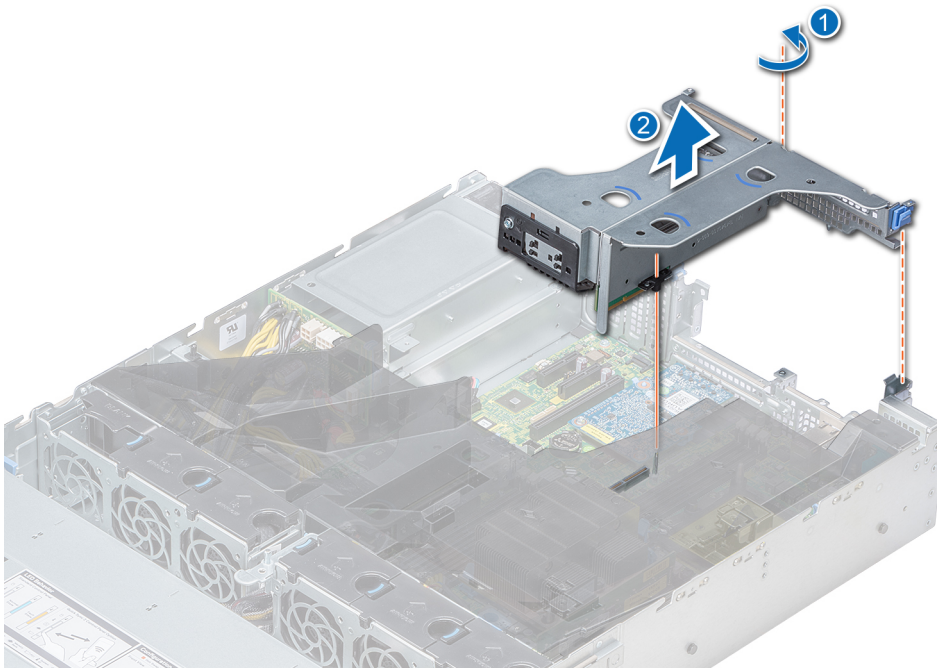

Figure 84. Removing butterfly riser

Next steps

Install the expansion card riser.

Installing an expansion card riser

Prerequisites

1. Follow the safety guidelines listed in [Safety instructions](#).

Steps

1. If removed, install the expansion cards into the expansion card riser.
2. Holding the touch points, align the expansion card riser with the connector and the riser guide pin on the system board.
3. Lower the expansion card riser into place until the expansion card riser connector is fully seated in the connector.

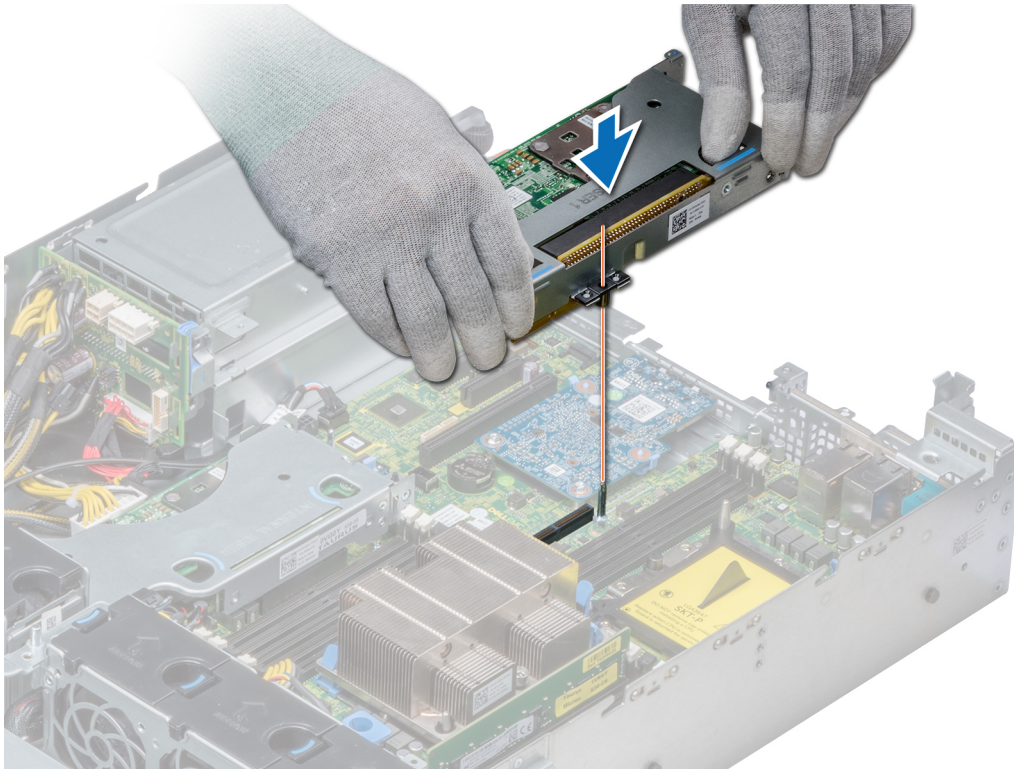

Figure 85. Installing low profile riser right

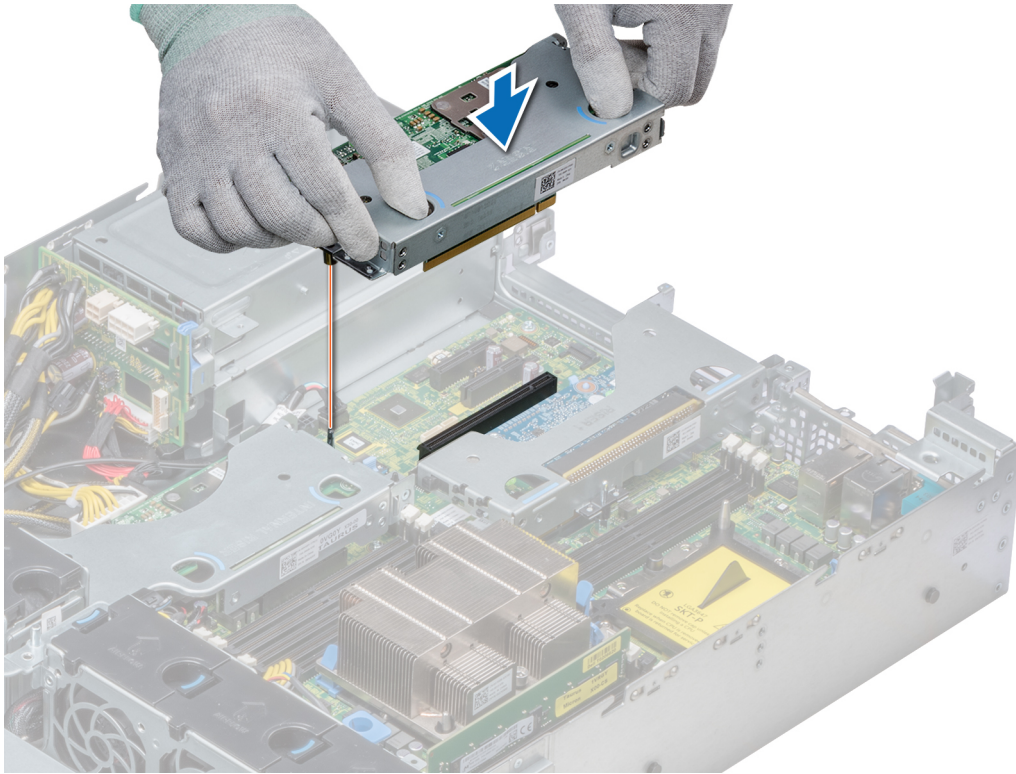

Figure 86. Installing low profile riser left

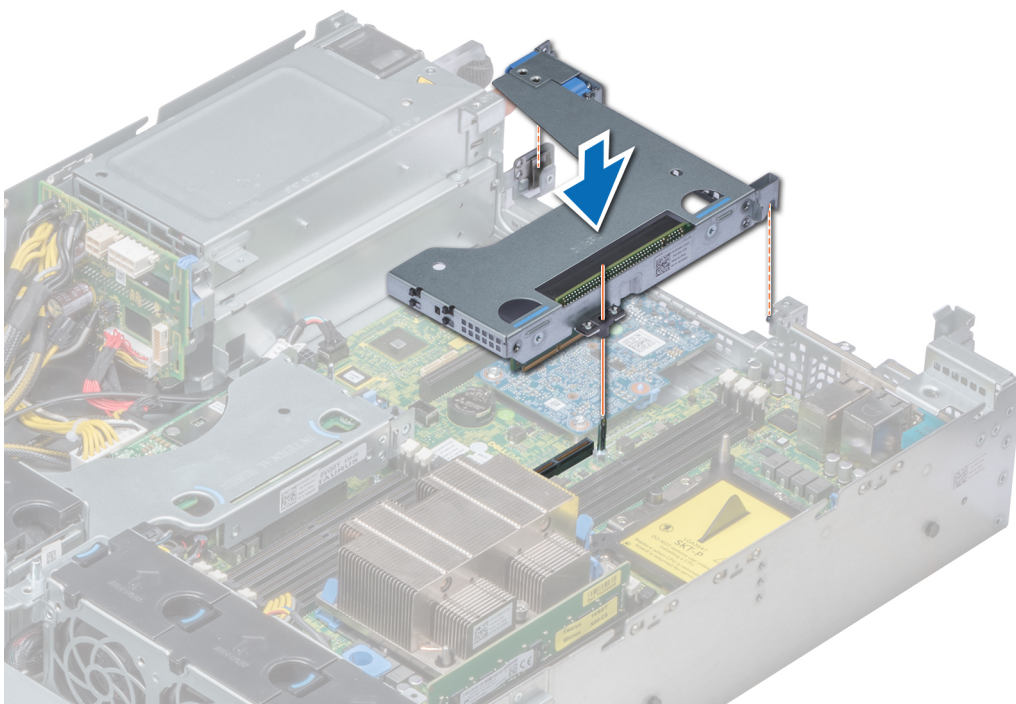

Figure 87. Installing full height X1 riser

NOTE: For butterfly riser, tighten the captive screw to firmly hold the riser to the system board.

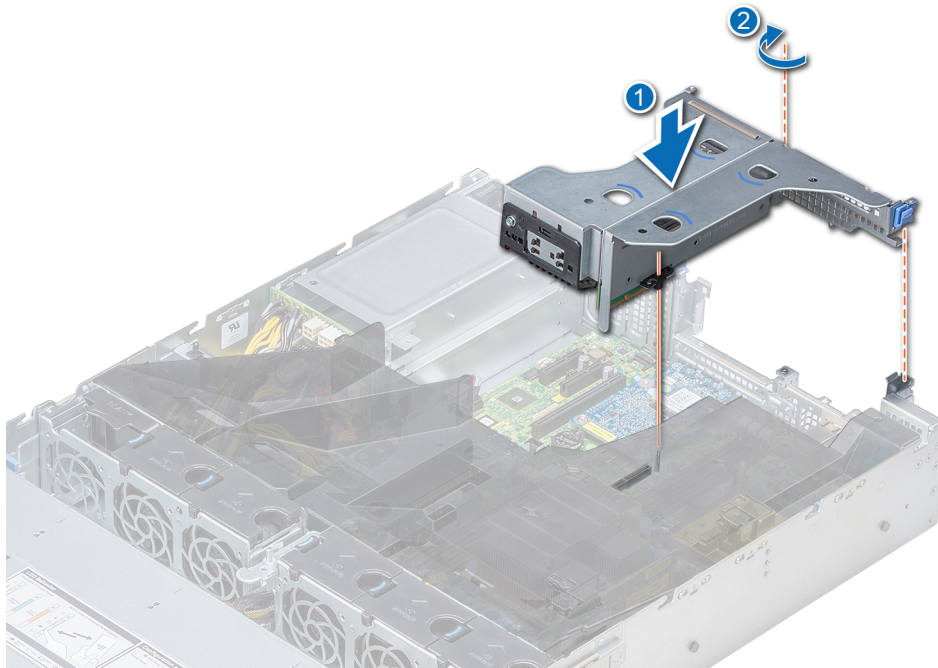

Figure 88. Installing butterfly riser

Next steps

1. Follow the procedure listed in [After working inside your system](#).
2. Install any device drivers required for the card as described in the documentation for the card.

Identifier	GUID-107386B5-56C8-4914-9B2D-4EE6B8EF8B68
Status	Released

M.2 SSD module

Identifier	GUID-5C915FE3-046B-4DC1-A4C7-E0DB33748B8B
Status	Released

Removing the M.2 SSD module

Prerequisites

1. Follow the safety guidelines listed in [Safety instructions](#).
2. Follow the procedure listed in [Before working inside your system](#).
3. [Remove the air shroud](#).
4. If installed, [remove the rear drive cage](#).
5. Remove the BOSS card.

NOTE: The procedure to remove the BOSS card is similar to the [removing an expansion card](#).

Steps

1. Loosen the screw and lift the retention strap that secures the M.2 SSD module on the BOSS card.
2. Lift the M.2 SSD module and slide it out of the connector on the BOSS card.

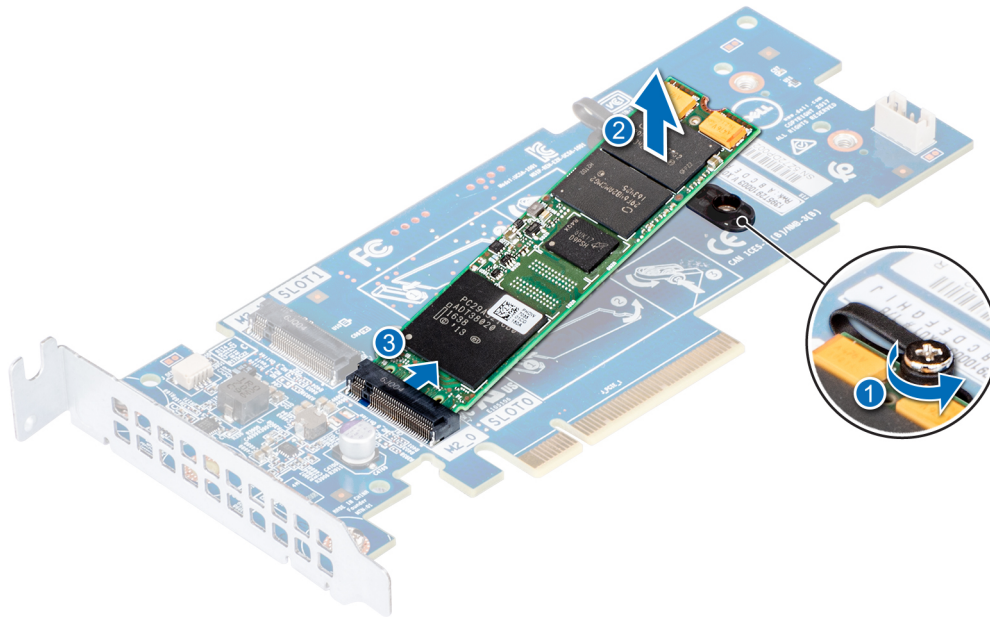

Figure 89. Removing the M.2 SSD module

Next steps

Replace the M.2 SSD module.

Identifier	GUID-07E07EBB-3EA5-4EB4-BC96-88FE8C7CA1D2
Status	Released

Installing the M.2 SSD module

Prerequisites

1. Follow the safety guidelines listed in [Safety instructions](#).
2. Follow the procedure listed in [Before working inside your system](#).
3. [Remove the air shroud](#).
4. [Remove the BOSS card](#)

NOTE: The procedure to remove the BOSS card is similar to the [removing an expansion card](#).

Steps

1. Connect the M.2 SSD module to the connector on the BOSS card.
2. Place the retention strap on the M.2 SSD module, and tighten the screw to secure the module.

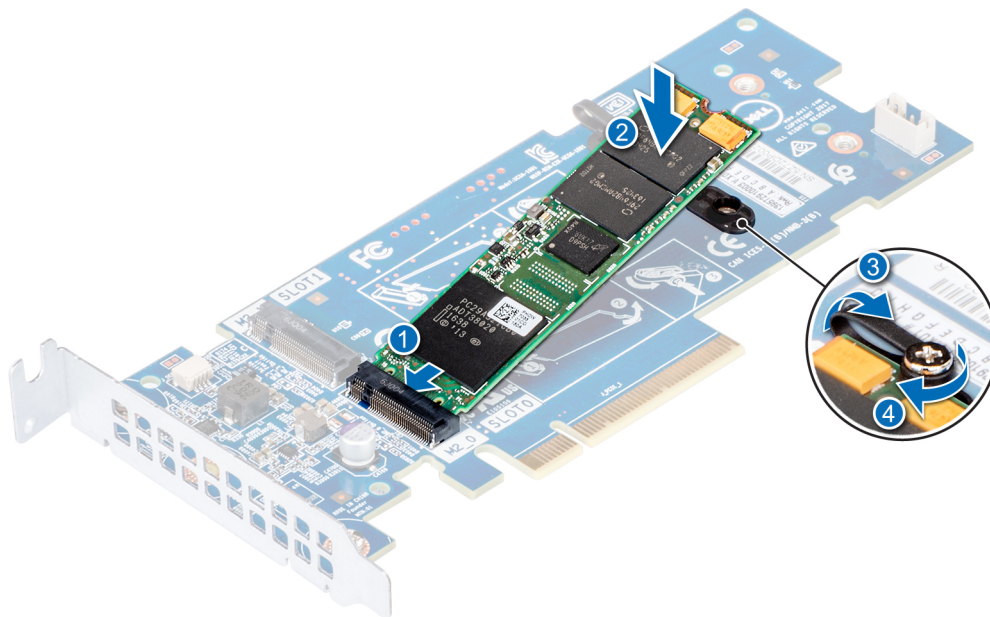

Figure 90. Installing the M.2 SSD module

Next steps

1. Install the BOSS card.

NOTE: The procedure to install the BOSS card is similar to the [Installing expansion card on the system board](#).

2. Install the applicable air shroud.
3. Follow the procedure listed in [After working inside your system](#).

Identifier	GUID-5E31A940-66EC-430D-AB67-4A90F233369E
Status	Released

Optional MicroSD or vFlash card

Identifier	GUID-FC0463DA-2131-4AE3-8858-BAA74C0F3F19
Status	Released

Removing the MicroSD card

Prerequisites

1. Follow the safety guidelines listed in [Safety instructions](#).
2. Follow the procedure listed in [Before working inside your system](#).

Steps

1. Locate the MicroSD card slot on the vFlash/IDSDM module, and press the card to partially release it from the slot. To locate IDSDM/vFlash module, see the System board jumpers and connectors section.
2. Hold the MicroSD card and remove it from the slot.

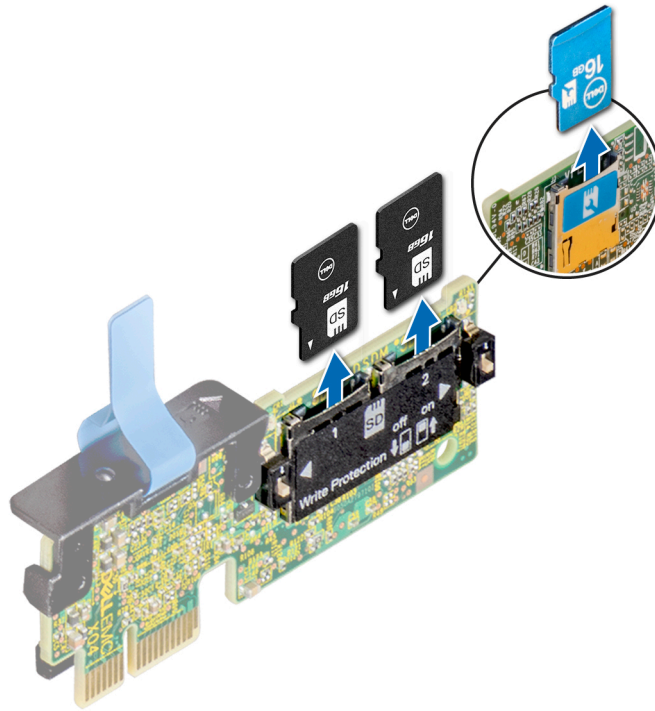

Figure 91. Removing the MicroSD card

NOTE: Temporarily label each MicroSD card with its corresponding slot number after removal.

Next steps

1. Follow the procedure listed in [After working inside your system](#).
2. [Installing the MicroSD card](#)

Identifier	GUID-60EC139F-6DDB-4A8D-9099-E02253BA3B14
Status	Released

Installing the MicroSD card

Prerequisites

Follow the safety guidelines listed in [Safety instructions](#).

NOTE: To use an MicroSD card with your system, ensure that the Internal SD Card Port is enabled in System Setup.

NOTE: If reinstalling, ensure that you install the MicroSD cards into the same slots based on the labels you had marked on the cards during removal.

Steps

1. Locate the MicroSD card connector on the IDSDM/vFlash module. Orient the MicroSD card appropriately and insert the contact-pin end of the card into the slot. To locate IDSDM/vFlash, see the System board jumpers and connectors section.

NOTE: The slot is keyed to ensure correct insertion of the card.

2. Press the card into the card slot to lock it into place.

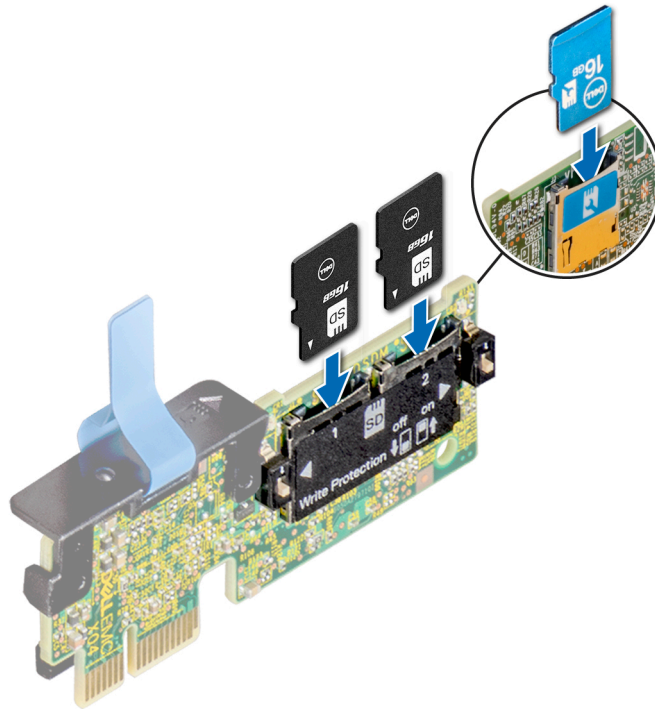

Figure 92. Installing the MicroSD card

Next steps

Follow the procedure listed in [After working inside your system.](#)

Identifier	GUID-F00E03D5-CF40-4A54-9D1F-9A87C66F371E
Status	Released

Optional IDSDM or vFlash module

Identifier	GUID-9478BDF2-91AA-4FBB-91EB-A9D364F9636F
Status	Released

Removing the optional IDSDM or vFlash card

Prerequisites

1. Follow the safety guidelines listed in [Safety instructions.](#)
2. Follow the procedure listed in [Before working inside your system.](#)

Steps

1. Locate the IDSDM/vFlash connector on the system board.
To locate IDSDM/vFlash connector, see the System board jumpers and connectors section.
2. Holding the pull tab, lift the IDSDM/vFlash card out of the system.

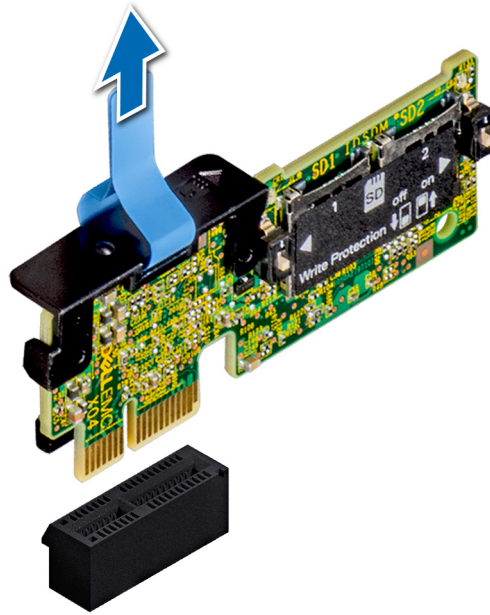

Figure 93. Removing the optional IDSDM/vFlash card

NOTE: There are two dip switches on the IDSDM/vFlash card for write-protection.

Next steps

Installing optional IDSDM or vFlash card

Identifier	GUID-E91DE03A-425E-4E07-A5C0-15F840C0FC5F
Status	Released

Installing optional IDSDM or vFlash card

Prerequisites

Follow the safety guidelines listed in [Safety instructions](#).

Steps

1. Locate the IDSDM/vFlash connector on the system board.
To locate IDSDM/vFlash connector, see the [Jumpers and connectors](#) section.
2. Align the IDSDM/vFlash card with the connector on the system board.
3. Push the IDSDM/vFlash card until it is firmly seated on the system board.

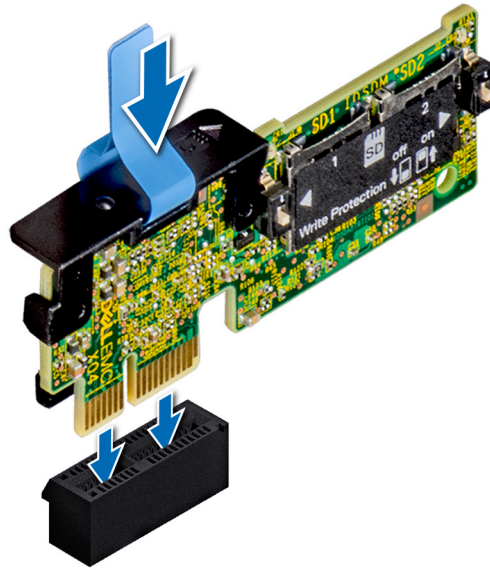

Figure 94. Installing optional IDSDM/vFlash card

Next steps

1. [Install the MicroSD cards.](#)



NOTE: Reinstall the MicroSD cards into the same slots based on the labels you had marked on the cards during removal.

2. Follow the procedure listed in [After working inside your system.](#)

Identifier	GUID-8CBA04E2-57D4-48C7-B953-936F6A8AE2BE
Status	Released

LOM riser card

Identifier	GUID-9149126A-7715-41C7-B7E7-B6979DDC00DD
Status	Released

Removing the LOM riser card

Prerequisites

1. Follow the safety guidelines listed in [Safety instructions.](#)
2. Follow the procedure listed in [Before working inside your system.](#)
3. If installed, [remove the risers.](#)
4. If installed, [remove the rear drive cage.](#)

Steps

1. Using a Phillips #2 screwdriver, loosen the screws that secure the LOM riser card to the system board.
2. Release the two blue side plastic snaps holding the LOM riser card.
3. Hold the LOM riser card by the edges on either side, and lift to remove it from the connector on the system board.
4. Slide the LOM riser card towards the front of the system until the Ethernet connectors or the Small form-factor pluggable (SFP) are clear of the slot in the back of the system.

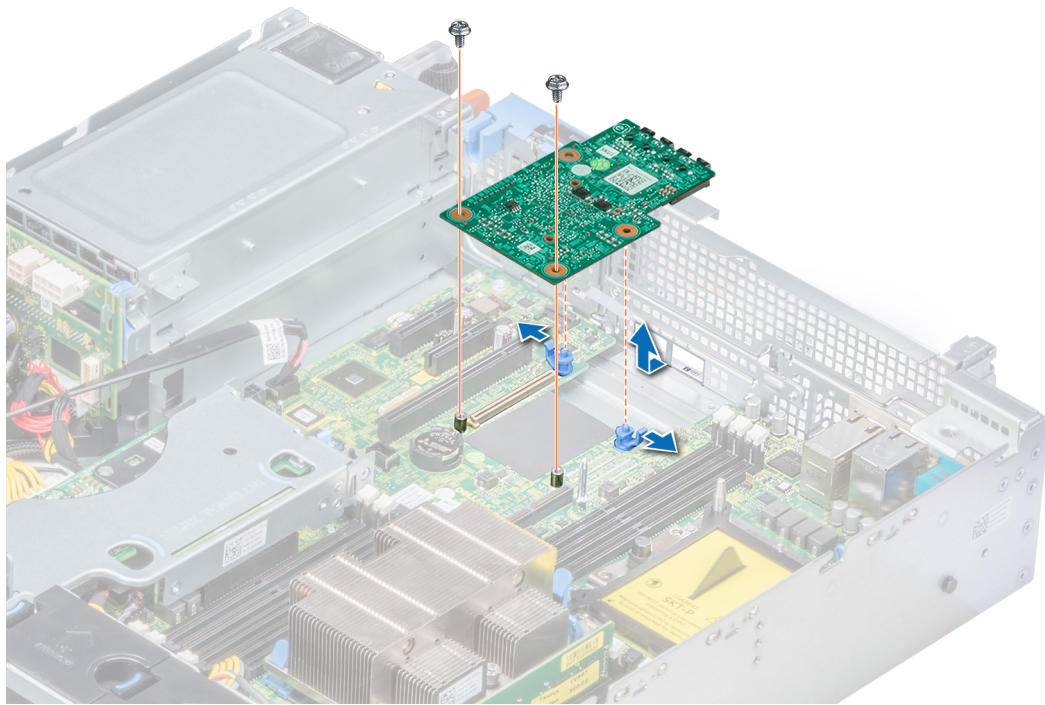

Figure 95. Removing LOM riser card

Next steps

[Installing the LOM riser card](#)

Identifier	GUID-19FCBC08-2B5C-4A50-8F26-52F94D1450A2
Status	Released

Installing the LOM riser card

Prerequisites

Follow the safety guidelines listed in [Safety instructions](#).

Steps

1. Align the connectors on the LOM riser card with the slot on the system.
2. Press the LOM riser card until the card is firmly seated on the system board connector and the two blue plastic snap hold the LOM riser card in place.
3. Using a Phillips #2 screwdriver, replace the screws to secure the LOM riser card to the system board.

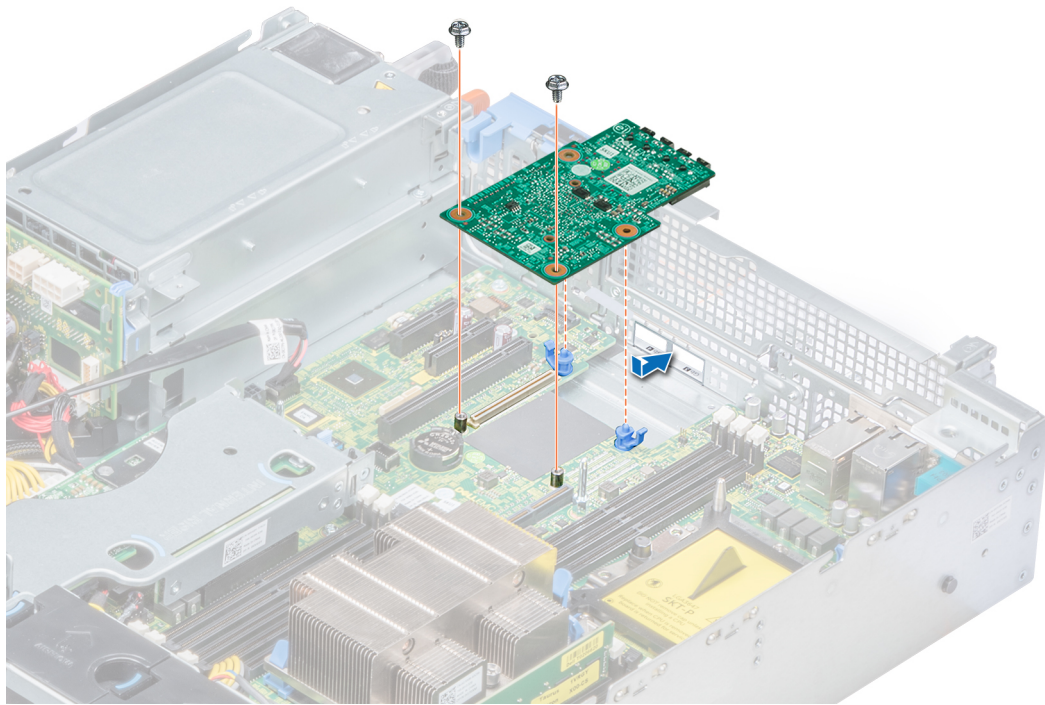

Figure 96. Installing LOM riser card

Next steps

1. If removed, [install the risers](#).
2. If removed, [install the rear drive cage](#).
3. Follow the procedure listed in [After working inside your system](#).

Identifier	GUID-DA10F2F2-2FE6-4295-B1F6-B638C4009DEC
Status	Released

Drive backplane

Identifier	GUID-E6ECE60E-D57C-4388-82A9-1FB7A5DEC2CF
Status	Released

Backplane details

Depending on your system configuration, the drive backplanes supported in PowerEdge R540 are listed here:

Table 54. Supported backplane options for PowerEdge R540 systems

System	Supported hard drives options
PowerEdge R540	3.5 inch (x8) SAS, SATA backplane 3.5 inch (x12) SAS or SATA backplane and 3.5 inch (x2) SAS or SATA backplane (rear)

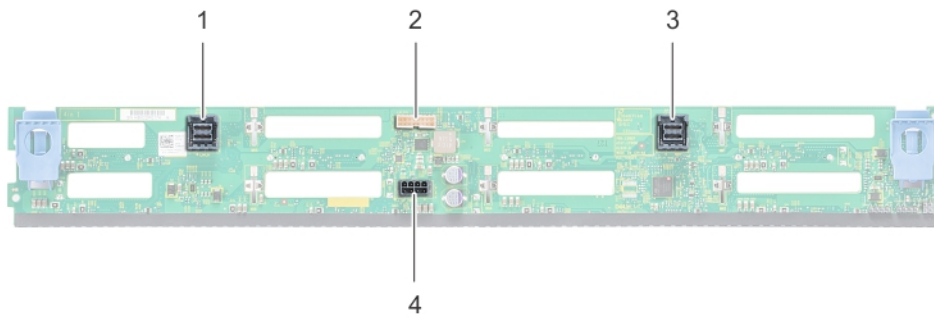

Figure 97. 8 X 3.5 inch drive backplane

- 1. SAS/SATA B cable connector
- 2. Signal connector
- 3. SAS/SATA A cable connector
- 4. Power connector

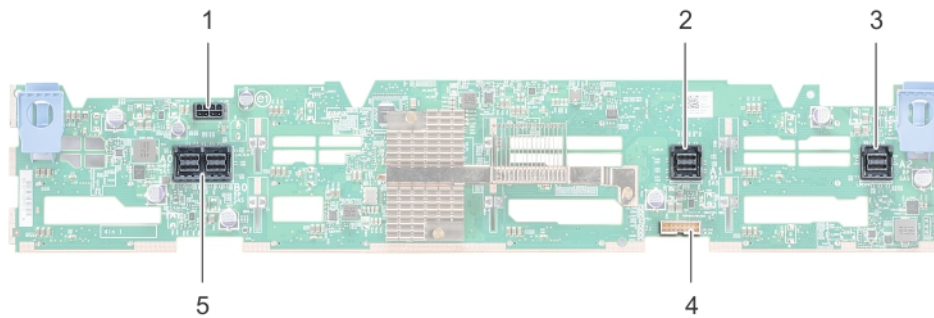

Figure 98. 12 X 3.5 inch drive backplane

- 1. Power cable connector
- 2. SAS/SATA cable connector
- 3. SAS/SATA cable connector
- 4. Backplane signal connector
- 5. SAS cable connector

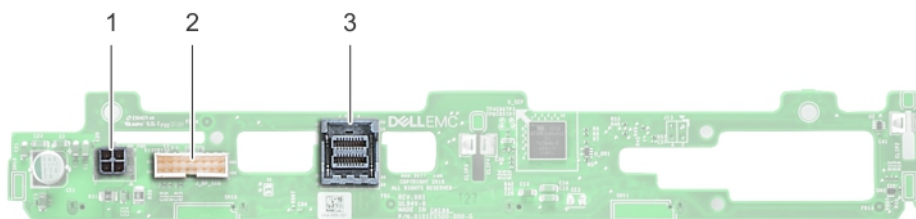

Figure 99. 2 x 3.5 inch drive backplane (rear)

- 1. Power connector
- 2. Signal connector
- 3. SAS cable connector

Removing the backplane

Prerequisites

- CAUTION:** To prevent damage to the drives and backplane, remove the drives from the system before removing the backplane.
- CAUTION:** Note the number of each drive and temporarily label them before you remove the drive so that you can replace them in the same location.
- NOTE:** The procedure to remove the backplane is similar for all backplane configurations.

1. Follow the safety guidelines listed in [Safety instructions](#).
2. Follow the procedure listed in [Before working inside your system](#).
3. [Remove the air shroud](#).
4. [Remove the backplane cover](#).
5. [Remove all the drives](#) from the hard-drive slots from the front of the system.
6. Disconnect all the cables from the backplane.

Steps

Press the blue release tabs and lift the backplane to disengage the backplane from the hooks on the system.

Figure 100. Removing backplane



Figure 101. Removing backplane

Next steps

[Install the backplane](#).

Installing the backplane

Prerequisites

Follow the safety guidelines listed in [Safety instructions](#).

NOTE: The procedure to install the backplane is similar for all backplane configurations.

Steps

1. Use the hooks on the system as guides to align the slots on the backplane with the guides on the system.
2. Lower the drive backplane until the blue release tabs snap into place.



Figure 102. Installing the backplane

Next steps

1. Connect all the cables to the backplane.
2. [Install all the drives..](#)
3. [Install the backplane cover..](#)
4. [Install the air shroud](#)
5. Follow the procedure listed in [After working inside your system](#).

Removing the 3.5-inch rear drive backplane

Prerequisites

CAUTION: To prevent damage to the drives and backplane, you must remove the drives from the system before removing the backplane.

CAUTION: You must note the number of each hard drive and temporarily label them before removal so that you can replace them in the same locations.

1. Follow the safety guidelines listed in [Safety instructions](#).
2. Follow the procedure listed in [Before working inside your system](#).
3. Remove all the drives from the rear drive cage.
4. Disconnect all the cables from the backplane.
5. [Remove the rear drive cage](#).

Steps

1. Using Phillips #2 screwdriver, remove the screws that secure the drive backplane to the rear drive cage.
2. Disengage the backplane from the hooks on the rear drive cage, and remove it from the rear drive cage.

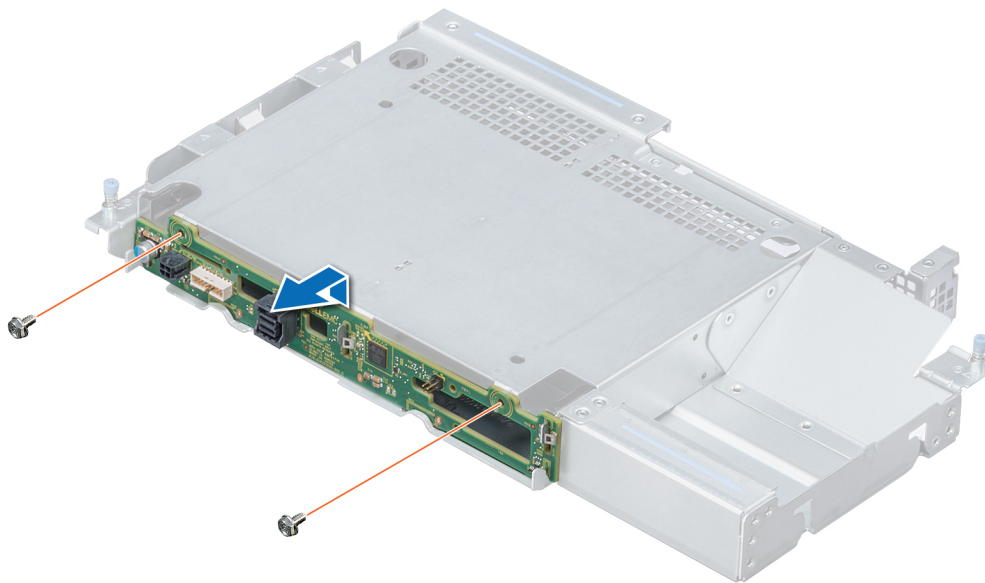

Figure 103. Removing 3.5-inch rear drive backplane

Next steps

Install the 3.5-inch rear drive backplane.

Identifier	GUID-25F3C3A8-66B5-4F3D-86F1-0EE886E6DF38
Status	Released

Installing the 3.5-inch rear drive backplane

Prerequisites

Follow the safety guidelines listed in [Safety instructions](#).

Steps

1. Use the hooks on the rear drive cage as guides to align the drive backplane.
2. Lower the backplane into the system until it is firmly seated.
3. Using Phillips #2 screwdriver, replace the screws to secure the backplane to the rear drive cage.

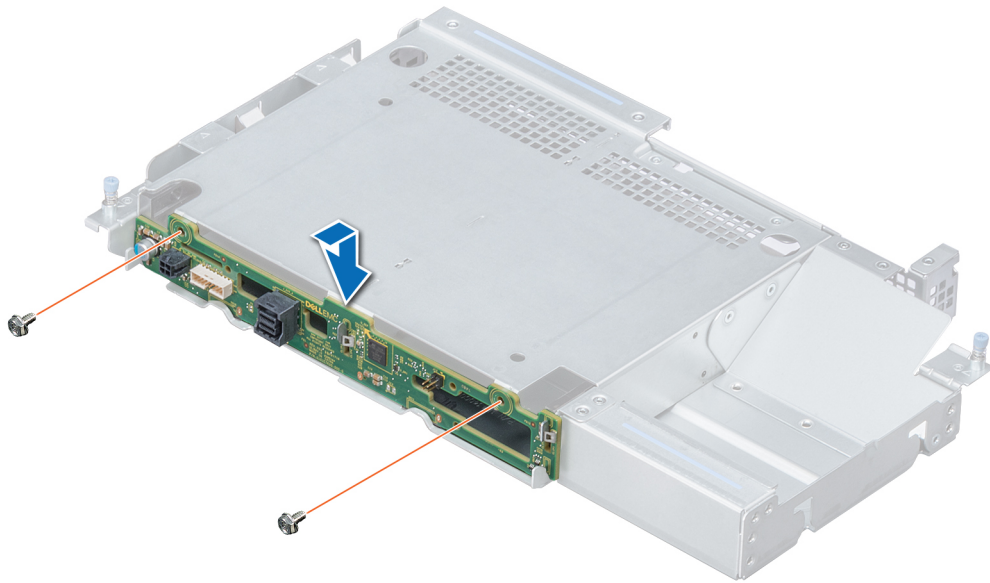

Figure 104. Installing 3.5-inch rear drive backplane

Next steps

1. [Install the rear drive cage.](#)
2. [Install all the drives.](#)
3. Connect all the cables to the backplane.
4. Follow the procedure listed in [After working inside your system.](#)

Cable routing

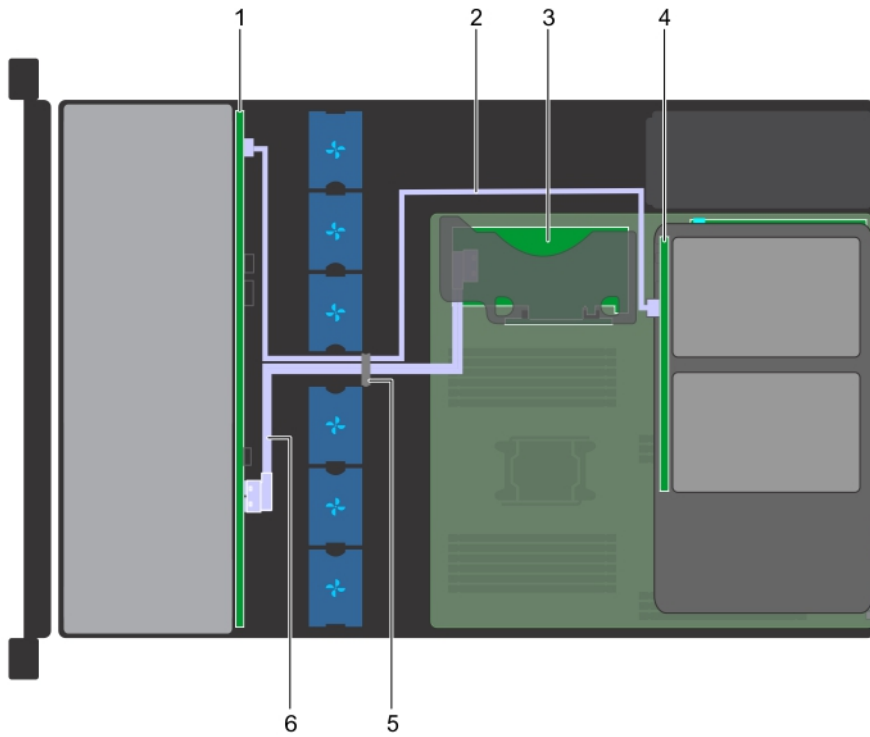

Figure 105. Cable routing - 12 x 3.5-inch drive backplane and 2 x 3.5-inch rear drive backplane with internal PERC riser

1. Drive backplane
2. SAS cable (BP: SAS A2 to rear drive backplane)
3. Internal PERC riser
4. Drive backplane (rear)
5. Cable guiding latch
6. SAS cable (BP: SAS A0/B0 to internal PERC riser)

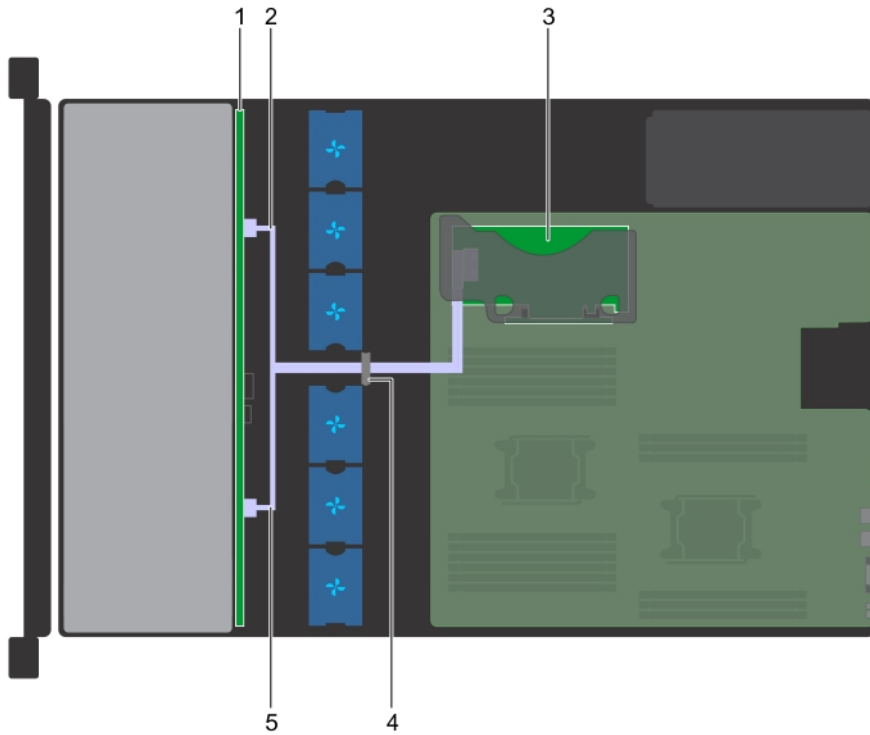

Figure 106. Cable routing - 8 x 3.5-inch drive backplane with internal PERC riser

- | | |
|---|---|
| 1. Drive backplane | 2. SATA cable (BP: BP_A to internal PERC riser: SATA_A) |
| 3. Internal PERC riser | 4. Cable guiding latch |
| 5. SATA cable (BP: BP_B to internal PERC riser: SATA_B) | |

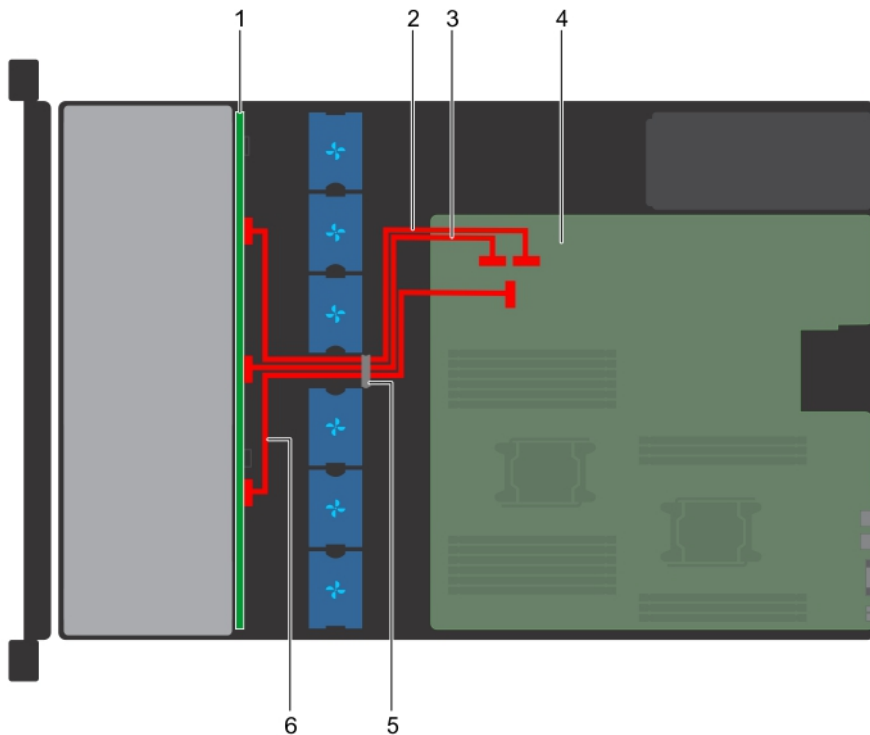

Figure 107. Cable routing - 12 x 3.5-inch drive backplane

- | | |
|---|---|
| 1. Drive backplane | 2. SATA A cable (BP: BP_A0 to MB: SATA_A) |
| 3. SATA B cable (BP: BP_B0 to MB: SATA_B) | 4. System board |
| | 5. SATA cable (BP: BP_B0 to MB: SATA_B) |
| | 6. SATA cable (BP: BP_A0 to MB: SATA_A) |

5. Cable guiding latch

6. SATA C cable (BP: BP_C0 to MB: SATA_C)

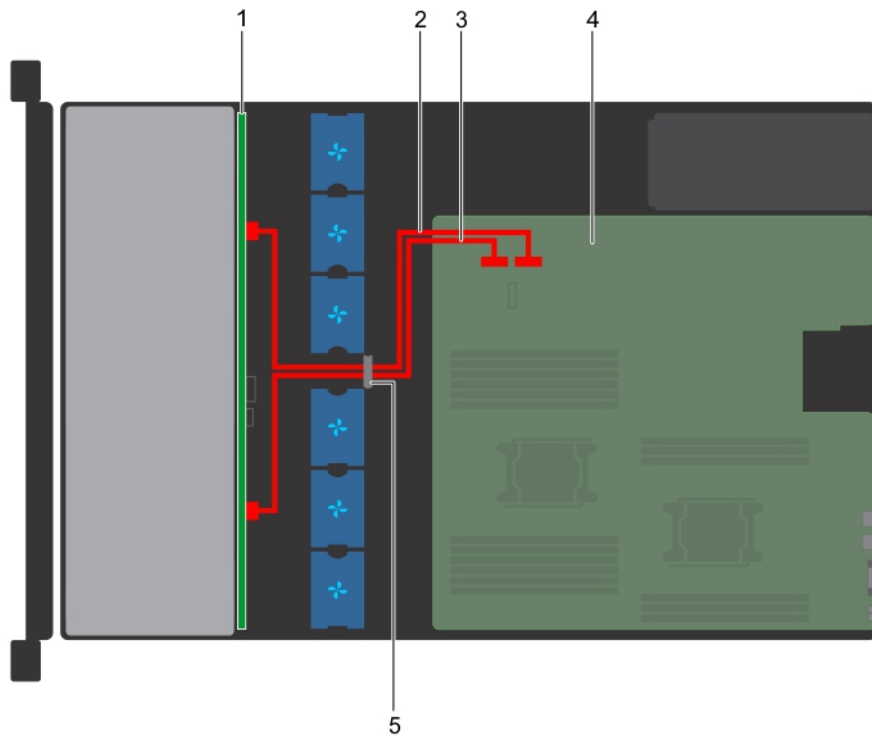

Figure 108. Cable routing - 8 x 3.5-inch drive backplane

1. Drive backplane

3. SATA B cable (BP: BP_B to MB: SATA_B)

5. Cable guiding latch

2. SATA A cable (BP: BP_A to MB: SATA_A)

4. System board

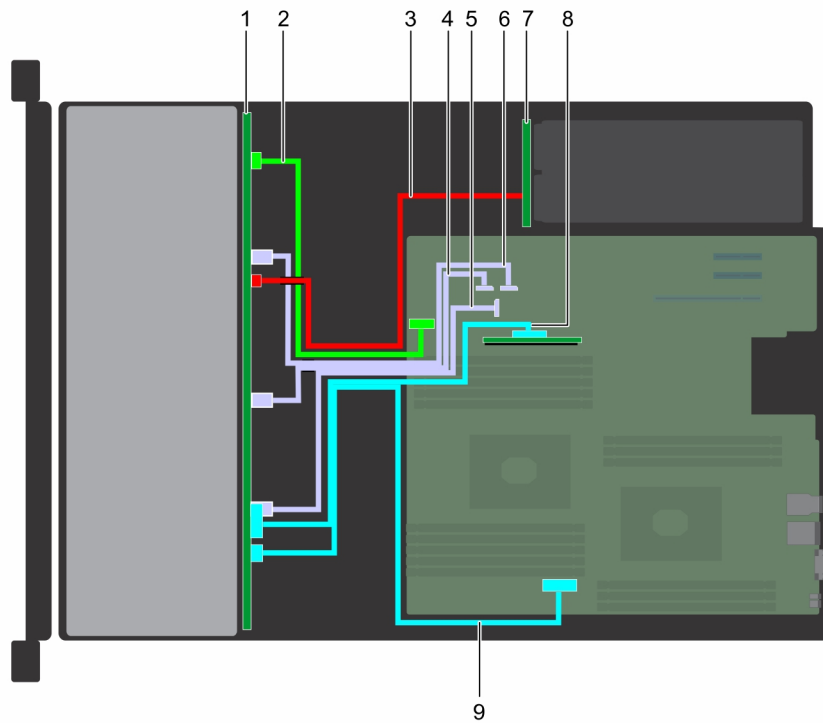

Figure 109. Cable routing - 2 x 3.5-inch Hybrid backplane with NVMe U.2 SSD

- | | |
|---|--|
| 1. drive backplane | 2. backplane signal cable (BP:BP_SIG1 to MB:BP_SIG1) |
| 3. backplane power cable | 4. SATA cable (BP:BP_B0 to MB SATA_B1) |
| 5. SATA cable (BP:BP_C0 to MB SATA_C1) | 6. SATA cable (BP:BP_A0 to MB SATA_A1) |
| 7. Power interposer board (PIB) | 8. PCIe cable (BP:BP PCIe B0 to MB Interposer_A) |
| 9. PCIe cable (BP:BP PCIe A0 to MB PCIe_A0) | |

Identifier	GUID-01A8DBDF-7866-47BC-BDA3-700865C0EA8E
Status	Released

Rear drive cage

Identifier	GUID-0AEDFB7F-6000-434B-A405-A6B13283B7ED
Status	Released

Removing the rear drive cage

Prerequisites

1. Follow the safety guidelines listed in [Safety instructions](#).
2. Follow the procedure listed in [Before working inside your system](#).
3. [Remove all the drives](#).
4. Disconnect all the cables from the rear drive backplane.

Steps

1. Using Phillips #2 screwdriver, loosen the screws that secure the drive cage to the system.
2. Pull and hold the screws to lift the drive cage away from the system.

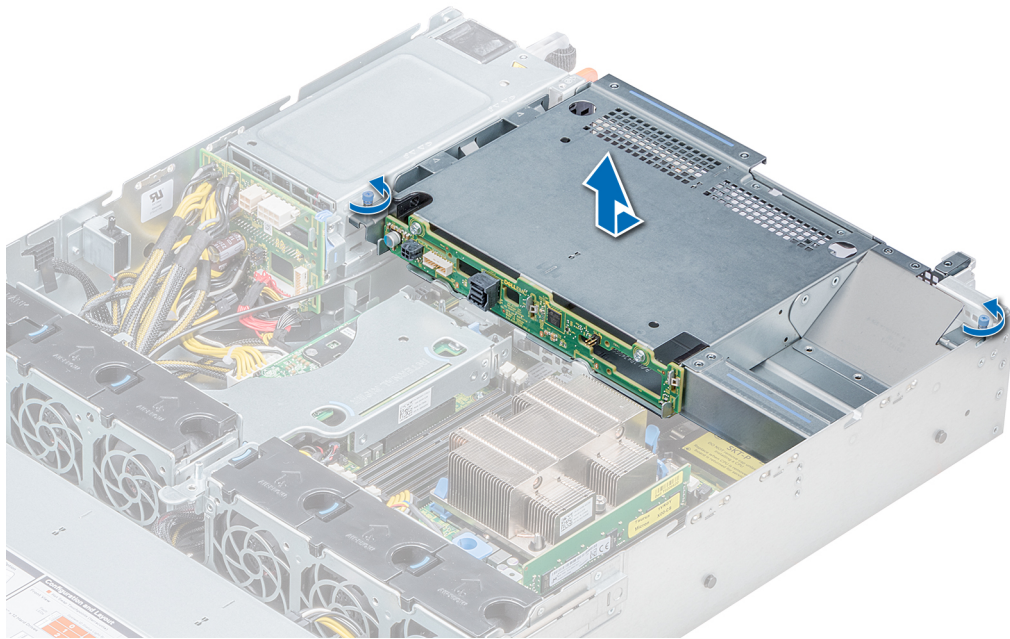

Figure 110. Removing the rear drive cage

Next steps

Install the rear drive cage.

Identifier	GUID-AAF8A6DF-8618-4E26-A9C4-5BCB87022269
Status	Released

Installing the rear drive cage

Prerequisites

Follow the safety guidelines listed in [Safety instructions](#).

Steps

1. Align the screws on the drive cage with the screw holes on the system chassis.
2. Lower the drive cage into the system until it is firmly seated and the screws lock into place.
3. Using Phillips #2 screwdriver, tighten the screws.

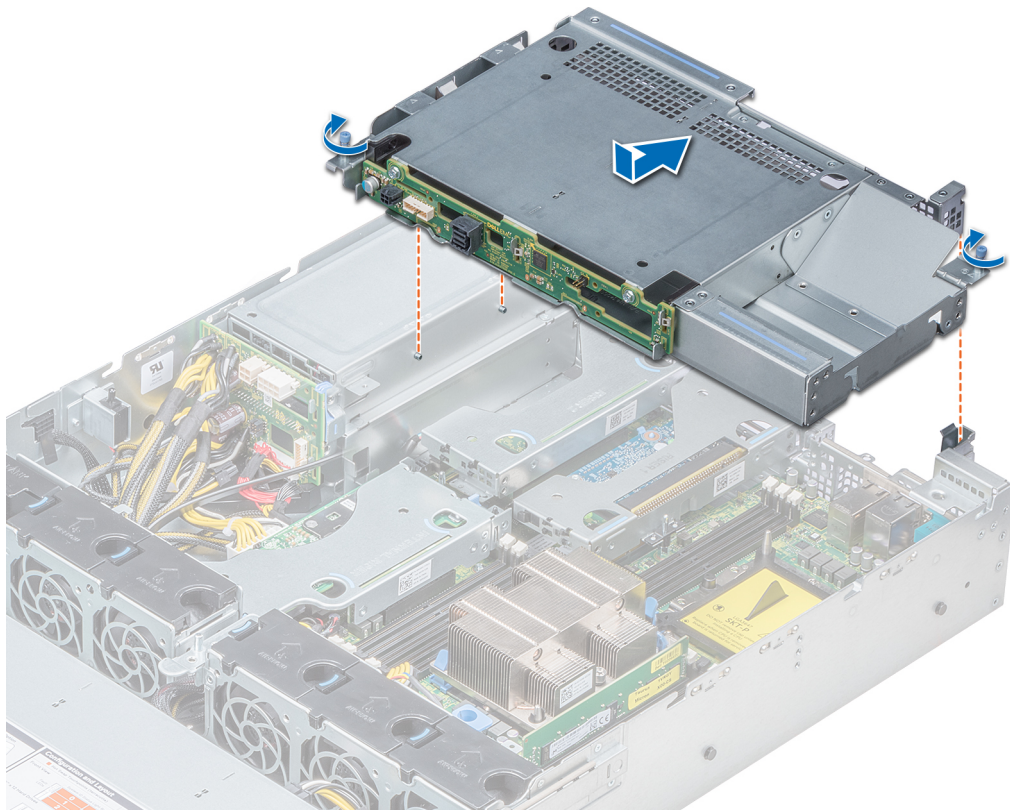

Figure 111. Installing the rear drive cage

Next steps

1. Reconnect all the disconnected cables to the rear drive backplane.
2. [Install all the drives.](#)
3. Follow the procedure listed in [After working inside your system.](#)

Identifier	GUID-08401B58-31A6-42A5-89F4-2FBE211FBF19
Status	Released

System battery

Identifier	GUID-BA558892-5A78-42F2-B4AD-77DEFC5C2C63
Status	Released

Optional internal USB memory key

Identifier	GUID-79FC6DC1-FEC5-4B06-98CA-F897F426FA7E
Status	Released

Replacing the optional internal USB memory key

Prerequisites

CAUTION: To avoid interference with other components in the server, the maximum permissible dimensions of the USB memory key are 15.9 mm wide x 57.15 mm long x 7.9 mm high.

1. Follow the safety guidelines listed in [Safety instructions.](#)
2. Follow the procedure listed in [Before working inside your system.](#)
3. If installed, [remove the low profile expansion card riser.](#)

Steps

1. Locate the USB port or USB memory key on the system board.
To locate the USB port, see the [Jumpers and connectors](#) .
2. If installed, remove the USB memory key from the USB port.
3. Insert the replacement USB memory key into the USB port.

Next steps

1. If removed, [Install the low profile expansion card riser](#).
2. Follow the procedure listed in [After working inside your system](#).
3. While booting, press F2 to enter **System Setup** and verify that the system detects the USB memory key.

Identifier	GUID-9956AD3F-D6D4-47E8-9197-F6D83FE92435
Status	Released

Optical drive (optional)

Identifier	GUID-619BB370-F587-4522-AEB3-8E5749DFBDD7
Status	Released

Removing the optical drive

Prerequisites

1. Follow the safety guidelines listed in [Safety instructions](#).
2. Follow the procedure listed in [Before working inside your system](#).
3. If applicable, [remove the front bezel](#).
4. Disconnect the power and data cables from the connectors on the optical drive.



NOTE: Ensure that you note the routing of the power and data cable on the side of the system and drive. Route these cables properly when you replace them to prevent them from being pinched or crimped.

Steps

1. Press the release tab to release the optical drive.
2. Slide the optical drive out of the system until it is out of the optical drive slot.
3. If you are not adding a new optical drive, install the optical drive blank. The procedure to install the optical drive blank is the same as the optical drive.

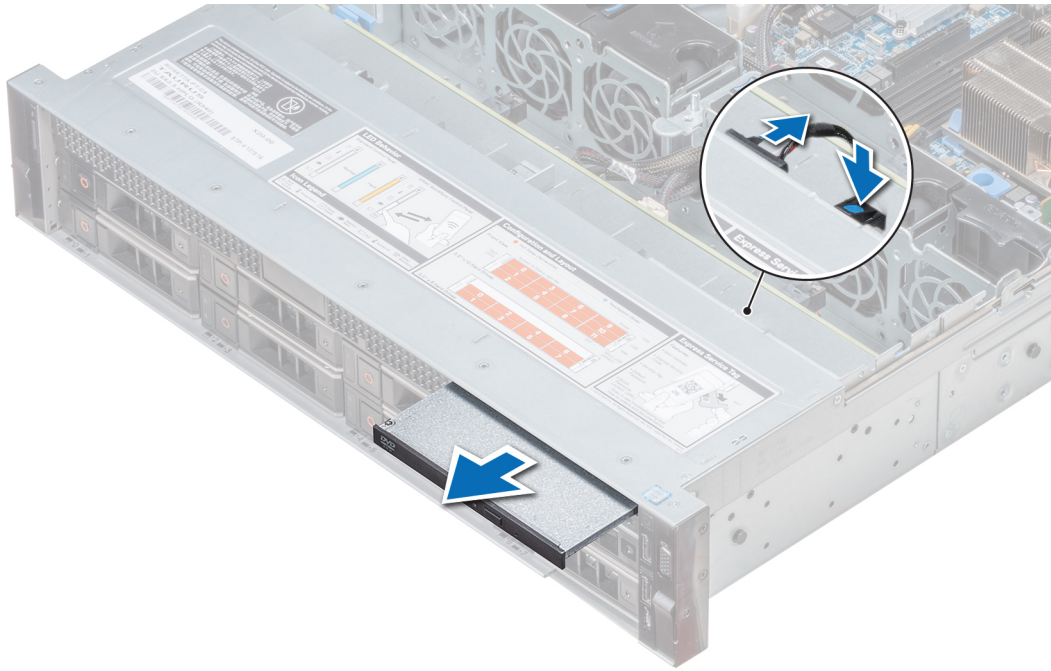

Figure 112. Removing optical drive

Next steps

Install an optical drive.

Identifier	GUID-38EEE27B-306A-4ADD-84C1-8A193CADA286
Status	Released

Installing the optical drive

Prerequisites

Follow the safety guidelines listed in [Safety instructions](#).

Steps

1. Align the optical drive with the optical drive slot on the front of the system.
2. Slide in the optical drive until the release tab snaps into place.

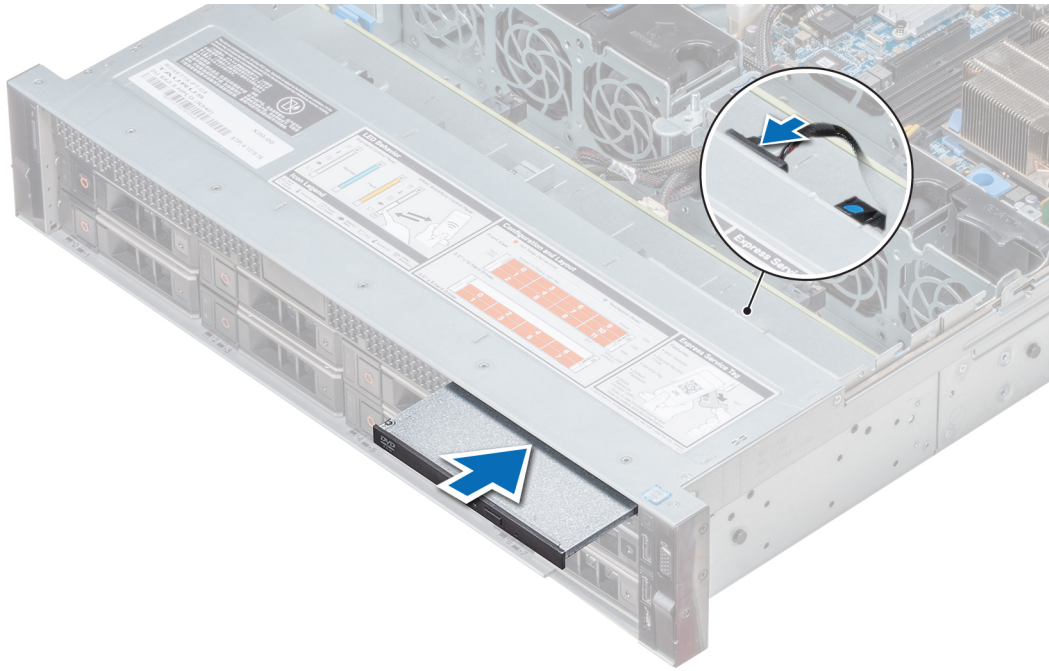

Figure 113. Installing the optical drive

Next steps

1. Connect the power and data cables to the connector on the optical drive and the connector on the system board.
 - NOTE:** Route the cable properly on the side of the system to prevent it from being pinched or crimped.
2. Follow the procedure listed in [After working inside your system](#).

Identifier	GUID-46617170-948F-4C04-9DF0-646C9C91C7CB
Status	Released

Power supply units

NOTE: For more information, see the [Technical specifications](#) section.

CAUTION: If two PSUs are installed, both the PSUs must have the same type of label. For example, Extended Power Performance (EPP) label. Mixing PSUs from previous generations of PowerEdge servers is not supported, even if the PSUs have the same power rating. Mixing PSUs will result in mismatch condition or failure to turn the system on.

NOTE: When two identical PSUs are installed, power supply redundancy (1+1 – with redundancy or 2+0 – without redundancy) is configured in system BIOS. In redundant mode, power is supplied to the system equally from both PSUs when Hot Spare is disabled. When Hot Spare is enabled, one of the PSUs is put into the sleep mode when system utilization is low in order to maximize efficiency.

NOTE: If two PSUs are used, they must be of the same maximum output power.

Identifier	GUID-4ABC4D1A-F881-4E7E-AA44-A2C202D7B5D9
Status	Released

Hot spare feature

Your system supports the hot spare feature that significantly reduces the power overhead associated with power supply unit (PSU) redundancy.

When the hot spare feature is enabled, one of the redundant PSUs is switched to the sleep state. The active PSU supports 100 percent of the load, thus operating at higher efficiency. The PSU in the sleep state monitors output voltage of the active PSU. If the output voltage of the active PSU drops, the PSU in the sleep state returns to an active output state.

If having both PSUs active is more efficient than having one PSU in the sleep state, the active PSU can also activate the sleeping PSU.

The default PSU settings are as follows:

- If the load on the active PSU is more than 50 percent, then the redundant PSU is switched to the active state.
- If the load on the active PSU falls below 20 percent, then the redundant PSU is switched to the sleep state.

You can configure the hot spare feature by using the iDRAC settings. For more information about iDRAC settings, see the *Integrated Dell Remote Access Controller User's Guide* available at www.dell.com/idracmanuals.

Identifier	GUID-3A346F82-0E6E-4967-A1D1-ED6FD147C029
Status	Released

Removing a power supply unit blank

Prerequisites

Follow the safety guidelines listed in [Safety instructions](#).

Steps

If you are installing a second power supply unit, remove the power supply unit blank in the bay by pulling the blank outward.

CAUTION: To ensure proper system cooling, the power supply unit blank must be installed in the second power supply unit bay in a non-redundant configuration. Remove the power supply unit blank only if you are installing a second power supply unit.

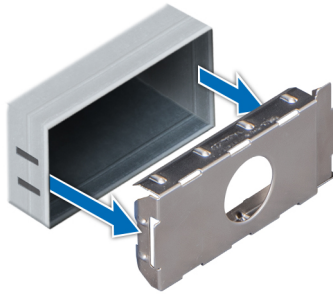

Figure 114. Removing a power supply unit blank

Next steps

[Installing a power supply unit](#)

Identifier	GUID-B1C6938B-1017-4D58-B704-0E3477B77A3A
Status	Released

Installing a power supply unit blank

Prerequisites

1. Follow the safety guidelines listed in [Safety instructions](#).

NOTE: Install the power supply unit (PSU) blank only in the second PSU bay.

Steps

Align the PSU blank with the PSU slot and push it into the PSU slot until it clicks into place.

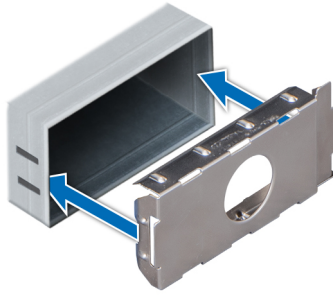

Figure 115. Installing a power supply unit blank

Next steps

Follow the procedure listed in [After working inside your system](#).

Identifier	GUID-6D5B5BE6-E855-4BD7-99AD-6CAD68D1A429
Status	Released

Removing a power supply unit

The procedure for removing AC and DC PSUs is identical.

Prerequisites

CAUTION: The system needs one power supply unit (PSU) for normal operation. On power-redundant systems, remove and replace only one PSU at a time in a system that is powered on.

1. Follow the safety guidelines listed in [Safety instructions](#).
2. Disconnect the power cable from the power source and from the PSU you intend to remove, and then remove the cable from the strap on the PSU handle.
3. Unlatch and lift the optional cable management arm if it interferes with the PSU removal.

For information about the cable management arm, see the system's rack documentation at www.dell.com/poweredgemanuals.

Steps

Press the release latch and slide the PSU out of the system by using the PSU handle.

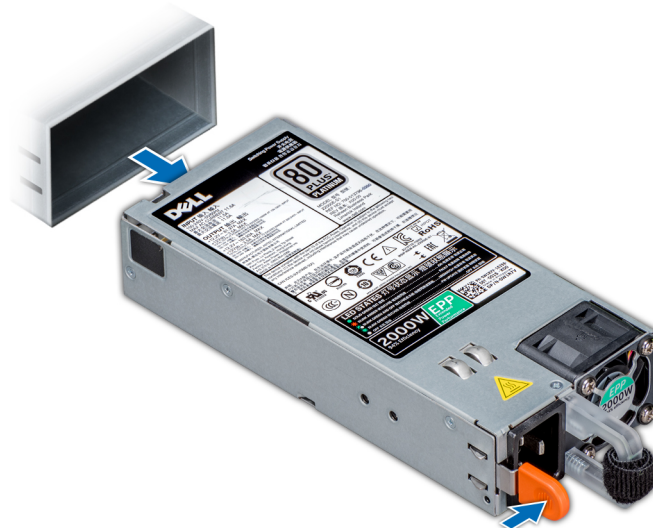

Figure 116. Removing a power supply unit

Next steps

[Installing a processor and heat sink module](#)

Identifier	GUID-24B177EA-8174-4665-96AB-FA0B61728567
Status	Released

Installing a power supply unit

The procedure for installing AC and DC PSUs is identical.

Prerequisites

1. Follow the safety guidelines listed in [Safety instructions](#).
2. For systems that support redundant PSU, ensure that both the PSUs are of the same type and have the same maximum output power.

NOTE: The maximum output power (shown in watts) is listed on the PSU label.

Steps

Slide the PSU into the system until the PSU is fully seated and the release latch snaps into place.

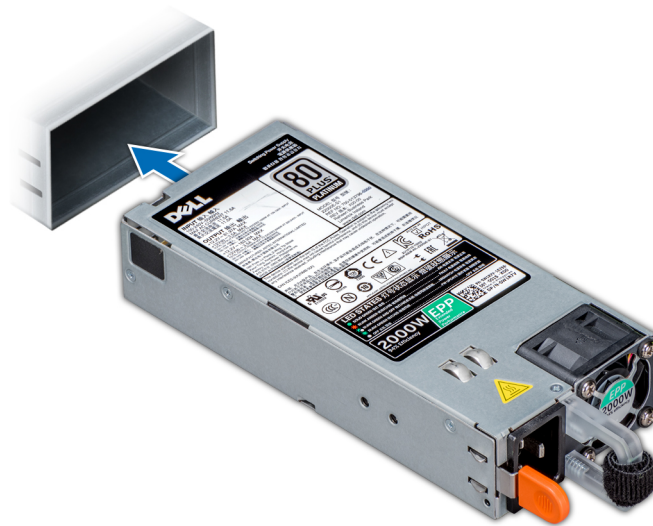

Figure 117. Installing a power supply unit

Next steps

1. If you have unlatched the cable management arm, relatch it. For information about the cable management arm, see the system's rack documentation at www.dell.com/poweredgemanuals.
2. Connect the power cable to the PSU, and plug the cable into a power outlet.

CAUTION: When connecting the power cable to the PSU, secure the cable to the PSU with the strap.

NOTE: When installing, hot swapping, or hot adding a new PSU, wait for 15 seconds for the system to recognize the PSU and determine its status. The PSU redundancy may not occur until discovery is complete. Wait until the new PSU is discovered and enabled before you remove the other PSU. The PSU status indicator turns green to signify that the PSU is functioning properly.

Removing a non-redundant cabled AC power supply unit

Prerequisites

1. Follow the safety guidelines listed in [Safety instructions](#).
2. Follow the procedure listed in [Before working inside your system](#).
3. [Removing the air shroud](#).
4. Disconnect the system from the electrical outlet.
5. Disconnect all the cables connected from the PSU to the system board.
6. If applicable, [Removing an expansion card riser](#)

Steps

1. Using a Phillips #2 screwdriver, remove the screw securing the PSU to the system.
2. Slide the PSU out of the PSU cage.

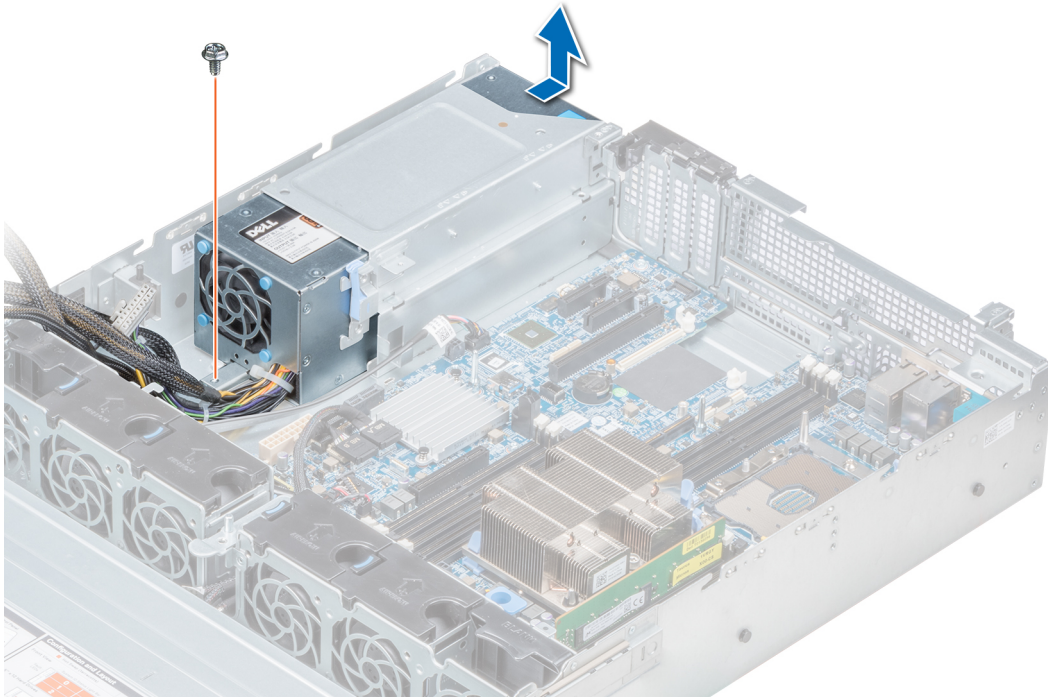

Figure 118. Removing non-redundant cabled AC PSU

Next steps

1. [Installing a non-redundant cabled AC power supply unit](#)

Installing a non-redundant cabled AC power supply unit

Prerequisites

1. Follow the safety guidelines listed in [Safety instructions](#).

Steps

1. Unpack the new power supply unit (PSU).
2. Slide the new PSU into the PSU cage until the PSU is fully seated.
3. Using a Phillips #2 screwdriver, replace the screw to secure the PSU to the system.

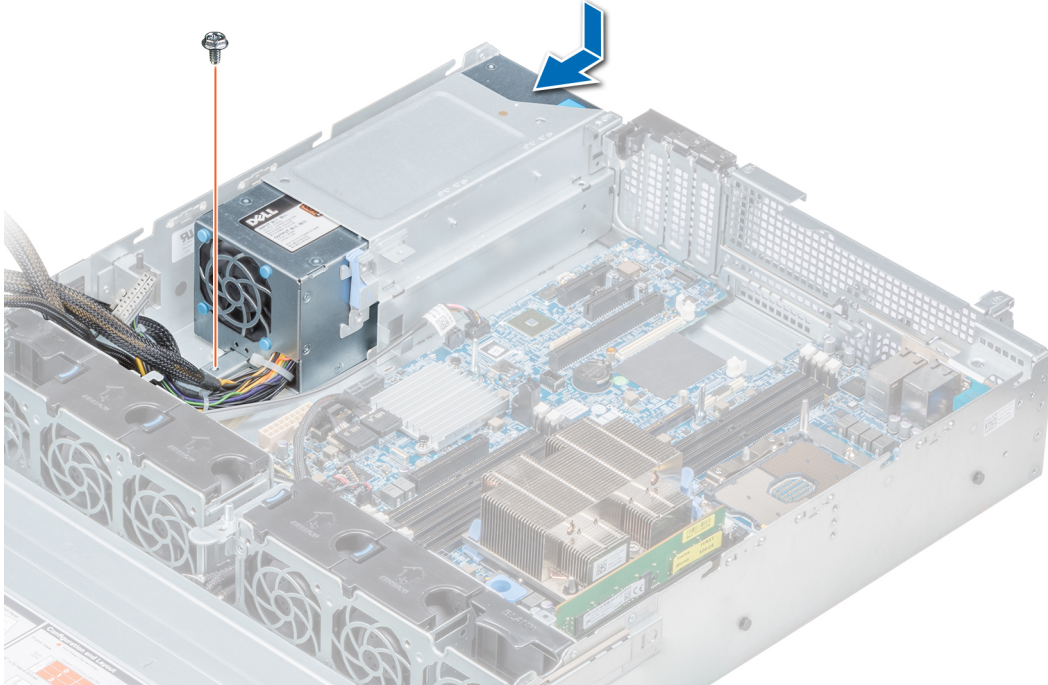

Figure 119. Installing non-redundant cabled AC PSU

Next steps

1. Connect the PSU cables to the connectors on the system board.
2. If applicable, [Installing an expansion card riser](#)
3. [Installing the air shroud](#)
4. Follow the procedure listed in [After working inside your system](#).

Identifier	GUID-47E3F79A-BCCF-44A2-AFB1-813128B954F8
Status	Released

Removing a DC power supply unit

Prerequisites

NOTE: For equipment using $-(48-60)$ V DC power supply units (PSUs), a qualified electrician must perform all connections to DC power and to safety grounds. Do not attempt connecting to DC power or installing grounds yourself. All electrical wiring must comply with applicable local or national codes and practices. Damage due to servicing that is not authorized by Dell is not covered by your warranty. Read and follow all safety instructions that came with the product.

CAUTION: The system needs one PSU for normal operation. On power-redundant systems, remove and replace only one PSU at a time in a system that is powered on.

1. Follow the safety guidelines listed in [Safety instructions](#).
2. Disconnect the power wires from the power source and the connector from the PSU you intend to remove.
3. Disconnect the safety ground wire.
4. Unlatch and lift the optional cable management arm if it interferes with PSU removal. For information about the cable management arm, see the system's rack documentation at www.dell.com/poweredge manuals.

Steps

Press the release latch and slide the PSU out of the system by using the PSU handle.

Next steps

Install the DC PSU.

Identifier	GUID-DA9A8D46-DBBC-4F8D-AEA9-CC204F289FB6
Status	Released

Installing DC power supply unit

Prerequisites

NOTE: For equipment using $-(48-60)$ V DC power supply units (PSUs), a qualified electrician must perform all connections to DC power and to safety grounds. Do not attempt connecting to DC power or installing grounds yourself. All electrical wiring must comply with applicable local or national codes and practices. Damage due to servicing that is not authorized by Dell is not covered by your warranty. Read and follow all safety instructions that came with the product.

1. Follow the safety guidelines listed in [Safety instructions](#).
2. For systems that support redundant power supply units (PSUs), ensure that both the PSUs are of the same type and have the same maximum output power.

NOTE: The maximum output power (shown in watts) is listed on the PSU label.

Steps

Slide the PSU into the system until the PSU is fully seated and the release latch snaps into place.

Next steps

1. If you have unlatched the cable management arm, relatch it. For information about the cable management arm, see the system's rack documentation at www.dell.com/poweredge manuals.
2. Connect the safety ground wire.
3. Install the DC power connector in the PSU.

CAUTION: When connecting the power wires, ensure that you secure the wires with the strap to the PSU handle.

4. Connect the wires to a DC power source.

NOTE: When installing, hot-swapping, or hot-adding a new PSU, wait for 15 seconds for the system to recognize the PSU and determine its status. The PSU status indicator turns green to signify that the PSU is functioning properly.

Identifier	GUID-5CDBF367-16BB-4C66-AC40-3C237CA440E5
Status	Released

Wiring instructions for a DC power supply unit

Your system supports up to two $-(48-60)$ V DC power supply units (PSUs).

NOTE: For equipment using $-(48-60)$ V DC power supply units (PSUs), a qualified electrician must perform all connections to DC power and to safety grounds. Do not attempt connecting to DC power or installing grounds yourself. All electrical wiring must comply with applicable local or national codes and practices. Damage due to servicing that is not authorized by Dell is not covered by your warranty. Read and follow all safety instructions that came with the product.

CAUTION: Wire the unit with copper only, unless otherwise specified, use only 10 American Wire Gauge (AWG) wire rated minimum 90°C for source and return. Protect the $-(48-60)$ V DC (1 wire) with a branch circuit over-current protection rated 50 A for DC with a high interrupt current rating.

CAUTION: Connect the equipment to a $-(48-60)$ V DC supply source that is electrically isolated from the AC source (reliably grounded $-(48-60)$ V DC SELV source). Ensure that the $-(48-60)$ V DC source is efficiently secured to earth (ground).

NOTE: A readily accessible disconnect device that is suitably approved and rated shall be incorporated in the field wiring.

Input requirements

- Supply voltage: $-(48-60)$ V DC
- Current consumption: 32 A (maximum)

Kit contents

- Dell part number 6RYJ9 terminal block or equivalent (1)
- #6-32 nut equipped with lock washer (1)

Required tools

Wire-stripper pliers capable of removing insulation from size 10 AWG solid or stranded, insulated copper wire.

NOTE: Use alpha wire part number 3080 or equivalent (65/30 stranding).

Required wires

- One UL 10 AWG, 2 m maximum (stranded) black wire [$-(48-60)$ V DC].
- One UL 10 AWG, 2 m maximum (stranded) red wire (V DC return).
- One UL 10 AWG, 2 m maximum, green with a yellow stripe, stranded wire (safety ground).

Identifier	GUID-D1C2CC34-ECE8-4DC7-B5D9-95ED0E485820
Status	Released

Assembling and connecting safety ground wire

Prerequisites

NOTE: For equipment using $-(48-60)$ V DC power supply units (PSUs), a qualified electrician must perform all connections to DC power and to safety grounds. Do not attempt connecting to DC power or installing grounds yourself. All electrical wiring must comply with applicable local or national codes and practices. Damage due to servicing that is not authorized by Dell is not covered by your warranty. Read and follow all safety instructions that came with the product.

Steps

1. Strip the insulation from the end of the green or yellow wire, exposing approximately 4.5 mm (0.175 inch) of copper wire.
2. Using a hand-crimping tool (Tyco Electronics, 58433-3 or equivalent), crimp the ring-tongue terminal (Jeeson Terminals Inc., R5-4SA or equivalent) to the green and yellow wire (safety ground wire).
3. Connect the safety ground wire to the grounding post on the back of the system by using a #6-32 nut equipped with a locking washer.

Identifier	GUID-690E7399-EF4F-412C-A01A-14AC35333B87
Status	Released

Assembling DC input power wires

Prerequisites

NOTE: For equipment using $-(48-60)$ V DC power supply units (PSUs), a qualified electrician must perform all connections to DC power and to safety grounds. Do not attempt connecting to DC power or installing grounds yourself. All electrical wiring must comply with applicable local or national codes and practices. Damage due to servicing that is not authorized by Dell is not covered by your warranty. Read and follow all safety instructions that came with the product.

Steps

1. Strip the insulation from the ends of the DC power wires, exposing approximately 13 mm (0.5 inch) of copper wire.
i **NOTE: Reversing polarity when connecting DC power wires can permanently damage the power supply or the system.**
2. Insert the copper ends into the mating connectors and tighten the captive screws at the top of the mating connector using a Phillips #2 screwdriver.
i **NOTE: To protect the power supply from electrostatic discharge, the captive screws must be covered with the rubber cap before inserting the mating connector into the power supply.**
3. Rotate the rubber cap clockwise to fix it over the captive screws.
4. Insert the mating connector into the power supply.

Identifier	GUID-327BE274-905A-4D44-955E-6253702C8CCF
Status	Released

Power interposer board

Identifier	GUID-EF8BAD0A-1CFA-41BB-87B4-273944ECEAA1
Status	Released

Removing power interposer board

Prerequisites

1. Follow the safety guidelines listed in [Safety instructions](#).
2. Follow the procedure listed in [Before working inside your system](#).
3. [Removing the air shroud](#)
4. Disconnect all the cables connected from the PIB to the system board.
i **NOTE: Ensure that you note the routing of the cables as you remove them from the system board.**
5. [Removing a processor and heat sink module](#)

Steps

1. Using a Phillips #2 screwdriver, remove the screw securing the power interposer board (PIB) to the system.
2. Press the blue release latch on the PIB to release it from the hook on the PSU cage.
3. Lift the board and slide it out at an angle to disengage the guide pins on the board.

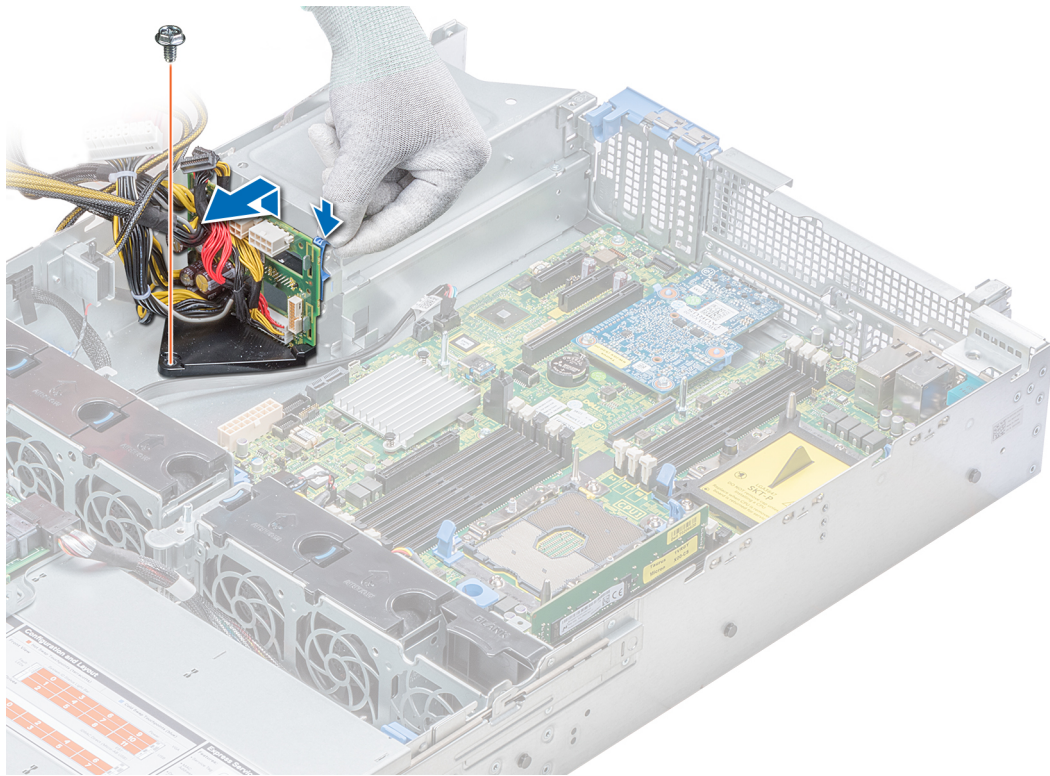

Figure 120. Removing power interposer board

4. Lift the board away for the system.

Next steps

1. [Installing power interposer board](#)

Identifier	GUID-5B9F3911-8A2C-4159-93F5-BAA359E3EE2A
Status	Released

Installing power interposer board

Prerequisites

Follow the safety guidelines listed in [Safety instructions](#).

Steps

1. Align the slots on the PIB with the hook on the PSU cage and slide it into place.
2. Using a Phillips #2 screwdriver, tighten the screw to secure the PIB to the system.
3. Route the cables and connect it to the system board.

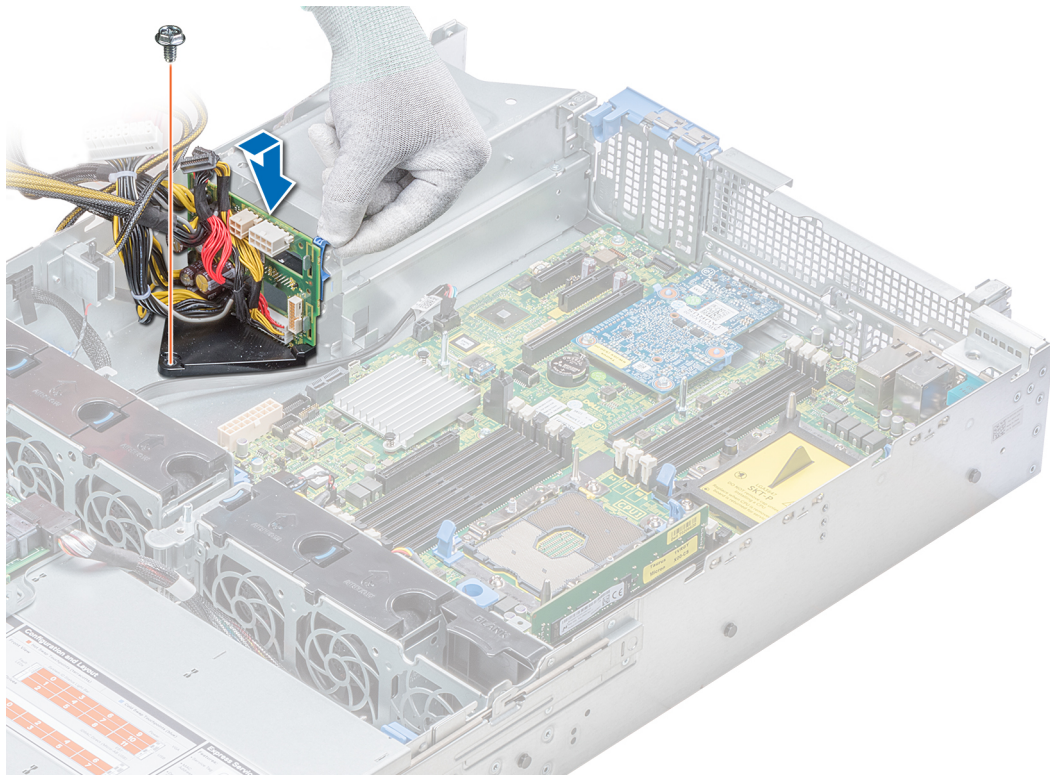

Figure 121. Installing power interposer board

Next steps

1. [Installing a processor and heat sink module](#)
2. [Installing the air shroud](#)
3. Follow the procedure listed in [After working inside your system.](#)

Identifier	GUID-A51AB05A-CA32-4BB9-8F8E-6B991CAD3B03
Status	Released

Control panel

Identifier	GUID-21A50ED3-3A1F-4754-8618-78DD839660C8
Status	Released

Removing the left control panel

Prerequisites

1. Follow the safety guidelines listed in [Safety instructions.](#)
2. Follow the procedure listed in [Before working inside your system.](#)
3. [Removing the air shroud](#)
4. [Removing the PERC card from the internal PERC riser](#)

Steps

1. Disconnect the control panel cable from the system board connector.

(i) NOTE: Ensure that you note the routing of the cables as you remove them from the system board. You must route the cables properly when you replace them to prevent the cables from being pinched or crimped.

2. Using a Phillips #1 screwdriver, remove the screws that secure the left control panel assembly to the system.

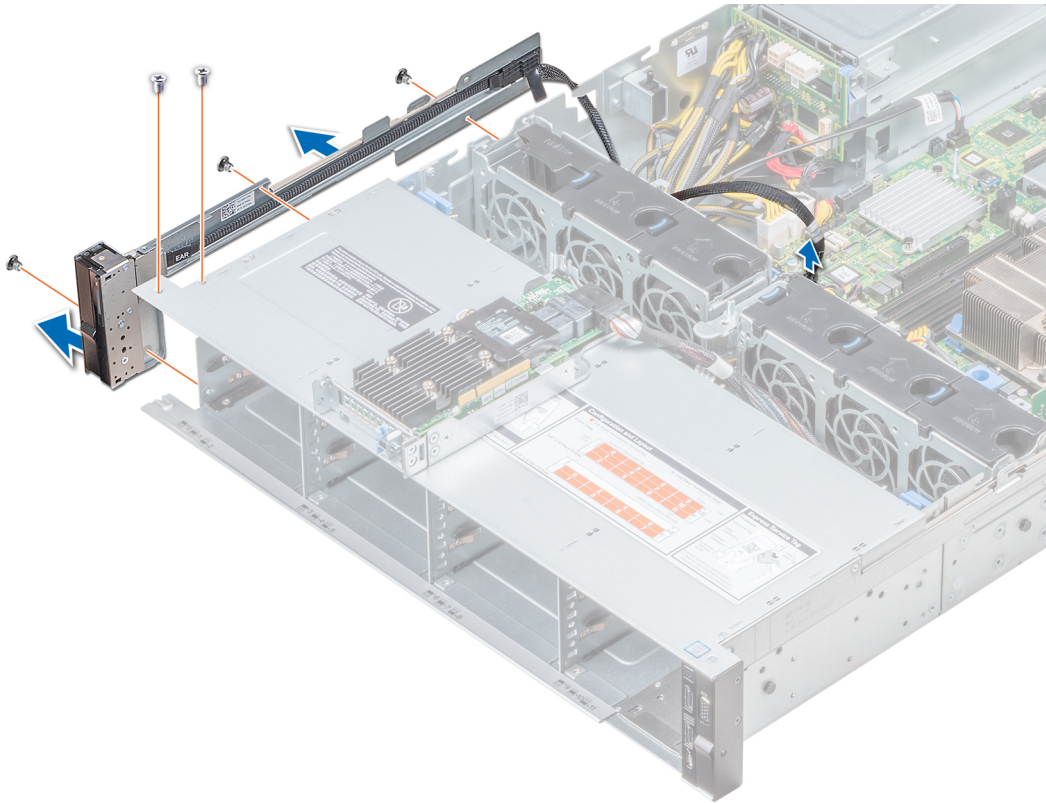

Figure 122. Removing left control panel

3. Holding by the sides, remove the left control panel assembly away from the system.

Next steps

[Installing the left control panel](#)

Identifier	GUID-DA2E4E0B-5BF6-4383-A37A-FC297651B95A
Status	Released

Installing the left control panel

Prerequisites

Follow the safety guidelines listed in [Safety instructions](#).

Steps

1. Route the control panel cable through the side wall of the system.
2. Align the left control panel assembly with the control panel slot on the system and place the assembly in the slot on the system.
3. Connect the control panel cable to the system board connector.
4. Using Phillips #1 screwdriver, tighten the screws to secure the left control panel assembly to the system.

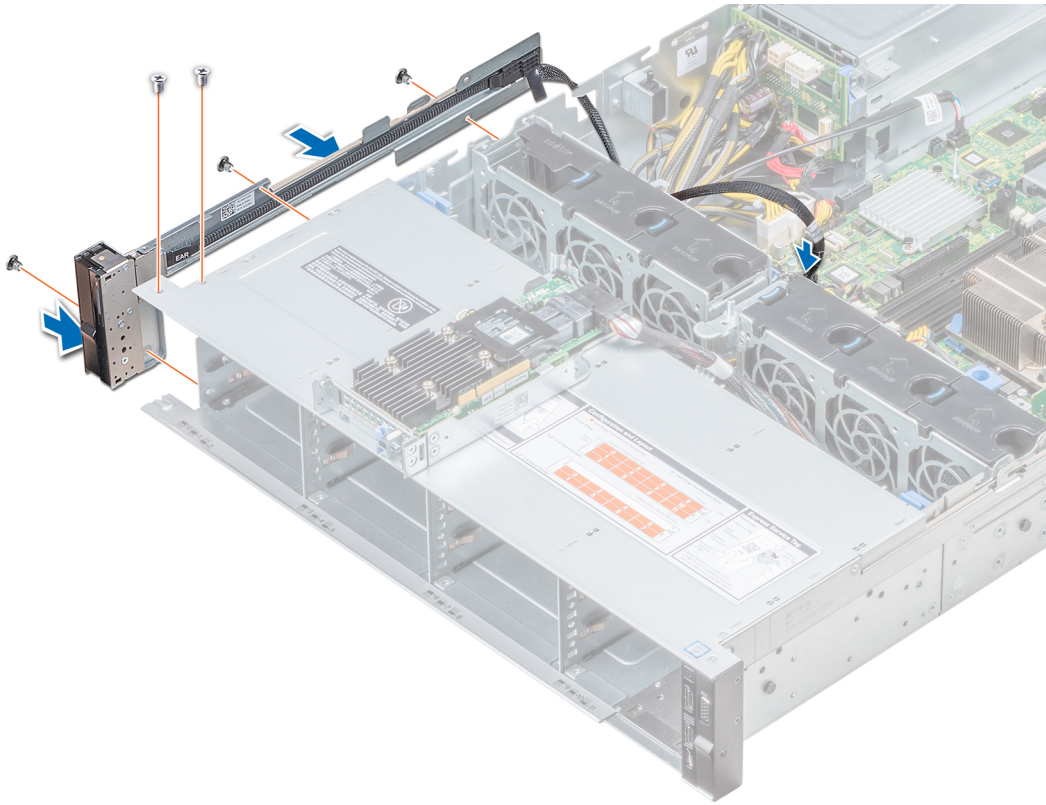

Figure 123. Installing left control panel

Next steps

1. [Installing the air shroud](#)
2. [Installing PERC card into the internal PERC riser](#)
3. Follow the procedure listed in [After working inside your system](#).

Identifier	GUID-86A563B6-E012-4B0C-A883-9F8E30811EBF
Status	Released

Removing the right control panel

Prerequisites

1. Follow the safety guidelines listed in [Safety instructions](#).
2. Follow the procedure listed in [Before working inside your system](#).
3. [Removing the PERC card from the internal PERC riser](#)

Steps

1. Lift the cable latch and disconnect the control panel cable from the connector on the system board.

NOTE: Ensure that you note the routing of the cables as you remove them from the system board. You must route the cables properly when you replace them to prevent the cables from being pinched or crimped.

2. Using Phillips #1 screwdriver, remove the screws that secure the right control panel assembly to the system.

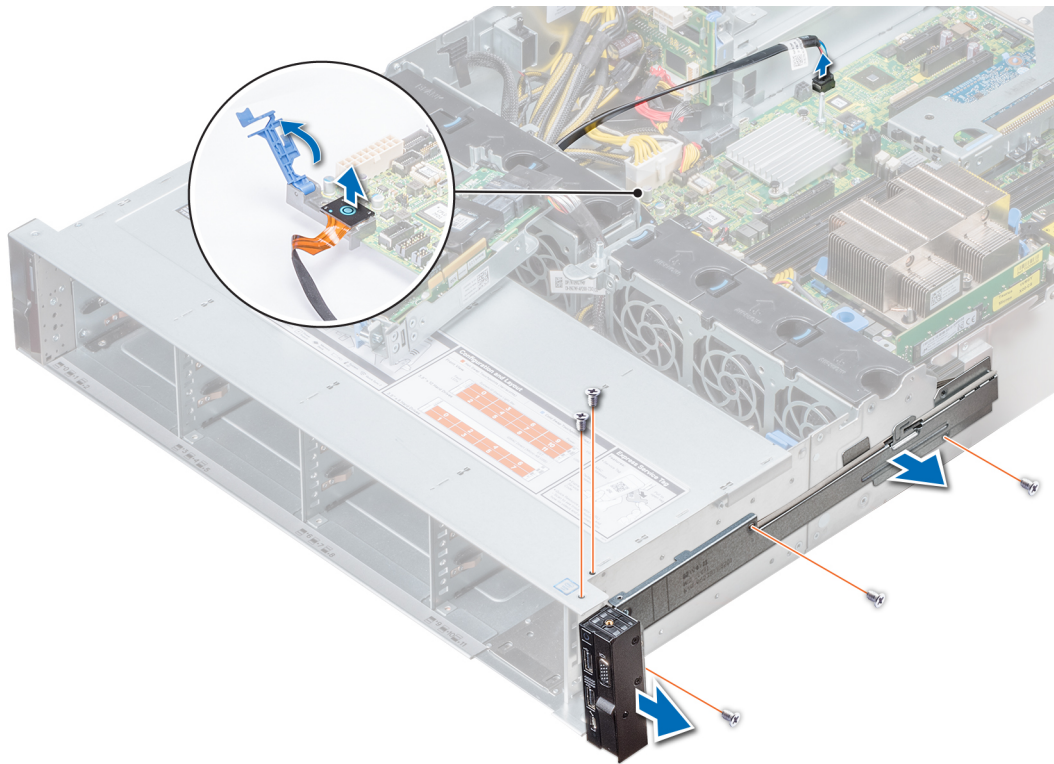

Figure 124. Removing right control panel

3. Holding by the sides, remove the right control panel assembly away from the system.

Next steps

[Installing the right control panel](#)

Identifier	GUID-F5DD7508-7E64-460D-9074-48DB1AEEEEEB2
Status	Released

Installing the right control panel

Prerequisites

Follow the safety guidelines listed in [Safety instructions](#).

Steps

1. Route the control panel cable through the side wall of the system.
2. Align the right control panel assembly with the control panel slot on the system and attach the control panel assembly to the system.
3. Connect the control panel cable to the connector on the system board and lower the cable latch to secure the cable in place.
4. Using a Phillips #1 screwdriver, tighten the screws to secure the right control panel assembly to the system.

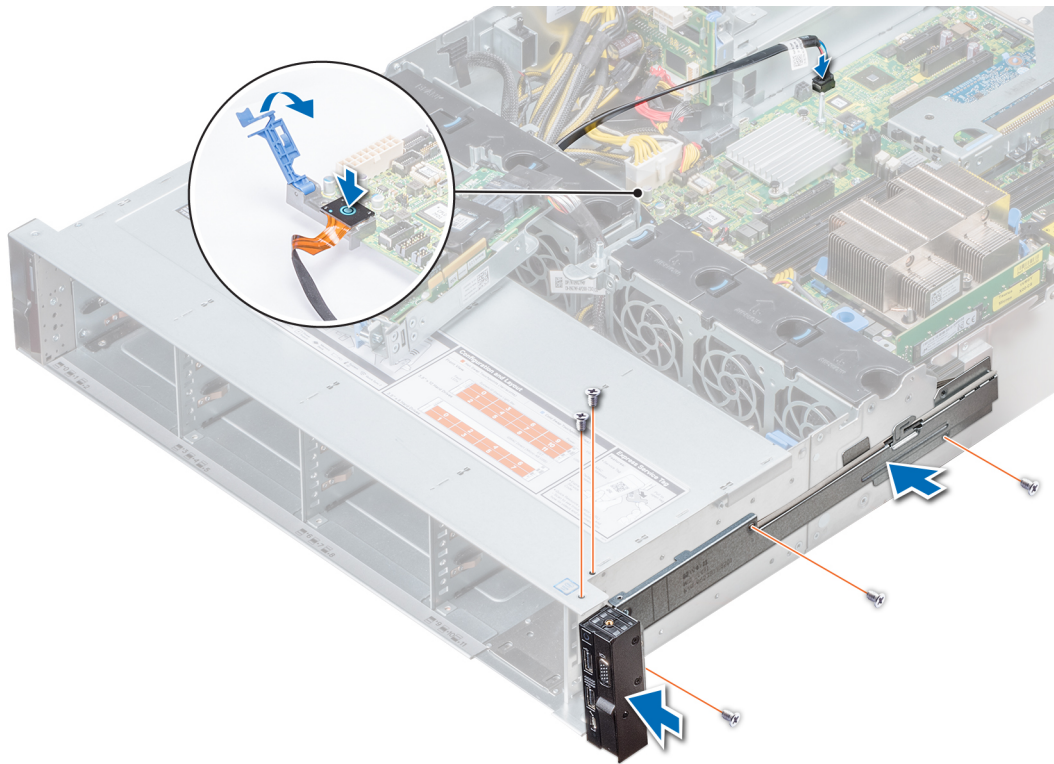

Figure 125. Installing right control panel

Next steps

1. Installing PERC card into the internal PERC riser
2. Follow the procedure listed in [After working inside your system](#).

Identifier	GUID-808D608B-EA7E-4DF7-A7F7-C7E2E22C34F1
Status	Released

System board

Identifier	GUID-50148971-0C22-495B-95DB-09E247810FEF
Status	Released

Removing the system board

Prerequisites

CAUTION: If you are using the Trusted Platform Module (TPM) with an encryption key, you may be prompted to create a recovery key during program or System Setup. Be sure to create and safely store this recovery key. If you replace this system board, you must supply the recovery key when you restart your system or program before you can access the encrypted data on your drives.

CAUTION: Do not attempt to remove the TPM plug-in module from the system board. Once the TPM plug-in module is installed, it is cryptographically bound to that specific system board. Any attempt to remove an installed TPM plug-in module breaks the cryptographic binding, and it cannot be re-installed or installed on another system board.

1. Follow the safety guidelines listed in [Safety instructions](#).
2. Follow the procedure listed in [Before working inside your system](#).
3. Remove the following:

CAUTION: Do not lift the system board by holding a memory module, processor, or other components.

- a. Air shroud
- b. All expansion cards and risers

- c. Internal PERC riser
- d. vFlash/IDSDM module
- e. Internal USB key (if installed)
- f. USB 3.0 module (if installed)
- g. Processors and heat sink modules
- h. Processors blanks (if installed)

CAUTION: To prevent damage to the processor socket when replacing a faulty system board, ensure that you cover the processor socket with the processor dust cover.

- i. Memory modules and memory module blanks
- j. LOM riser card
- k. Drive cage (rear) (if installed)

Steps

1. Disconnect all cables from the system board.

CAUTION: Take care not to damage the system identification button while removing the system board from the chassis.

2. Using a Torx #T30 screwdriver, remove nine screws securing the system board to the chassis.

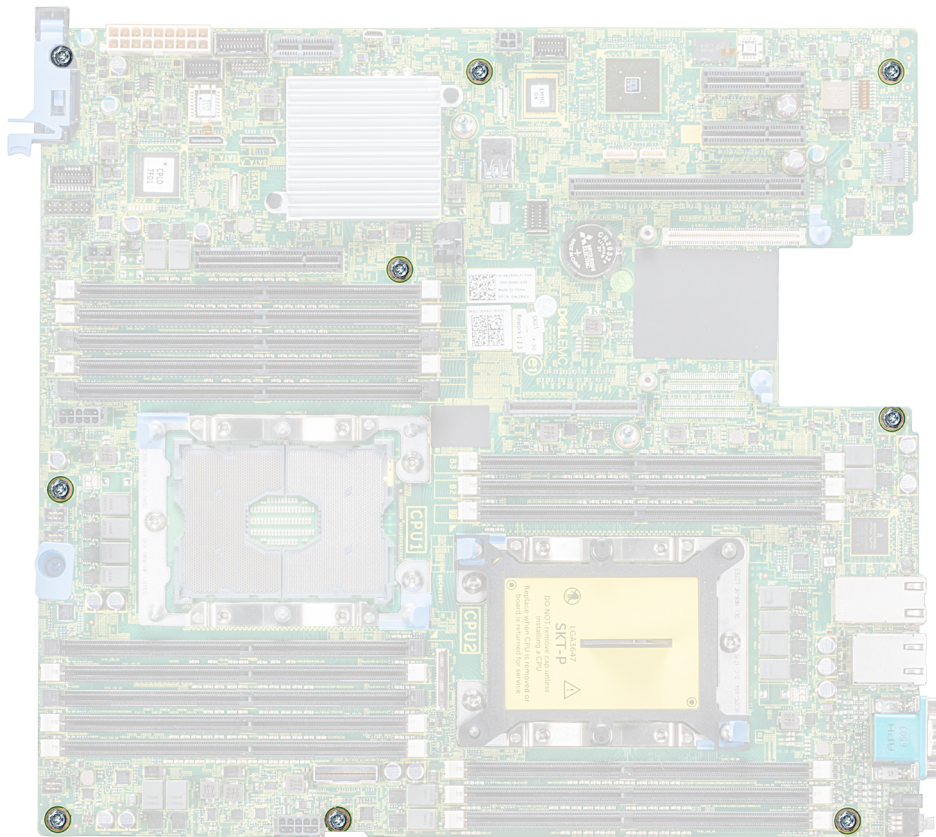

Figure 126. System board screws

3. Hold the system board holder, slightly lift the system board, and then slide it toward the front of the chassis.
4. Incline the system board at an angle, and lift the system board out of the chassis.

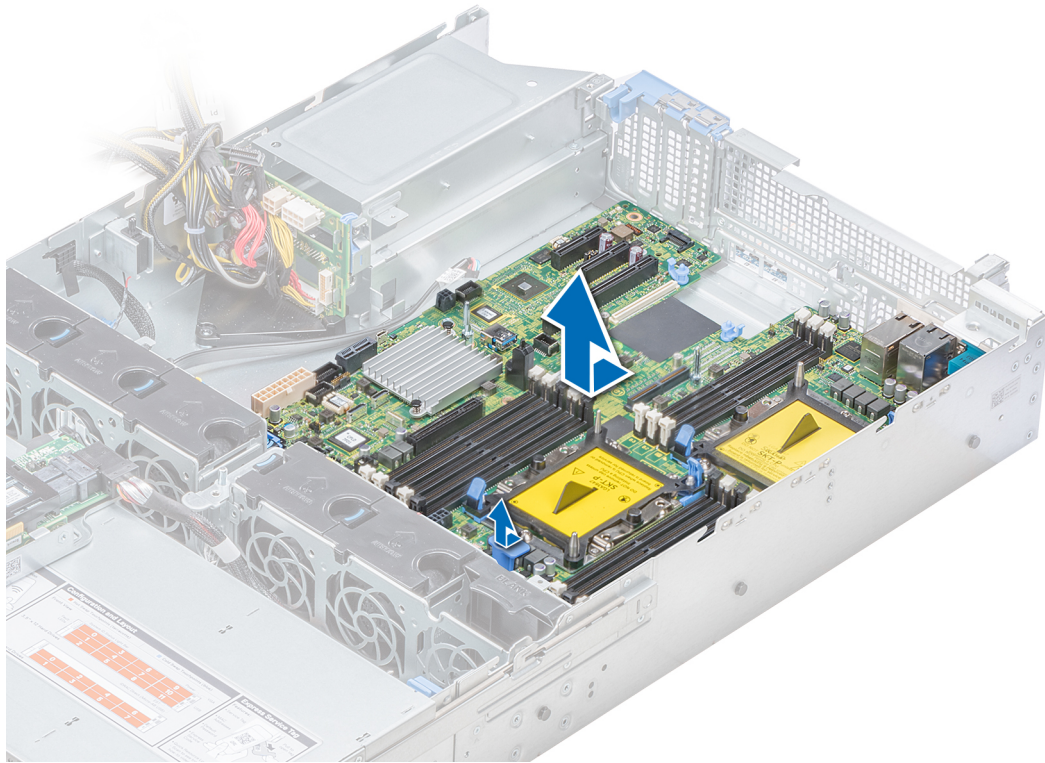

Figure 127. Removing the system board

Next steps

Installing the system board.

Identifier	GUID-900A0BD2-D1B9-47FD-A7E5-C0A00E0F14F5
Status	Released

Installing the system board

Prerequisites

Follow the safety guidelines listed in [Safety instructions](#).

Steps

1. Unpack the new system board assembly.

CAUTION: Do not lift the system board by holding a memory module, processor, or other components.

CAUTION: Take care not to damage the system identification button while placing the system board into the chassis.

2. Holding the system board holder, push the system board toward the back of the system till it is seated.
3. Using Phillips #2 screwdriver, tighten the screws to secure the system board to the chassis.

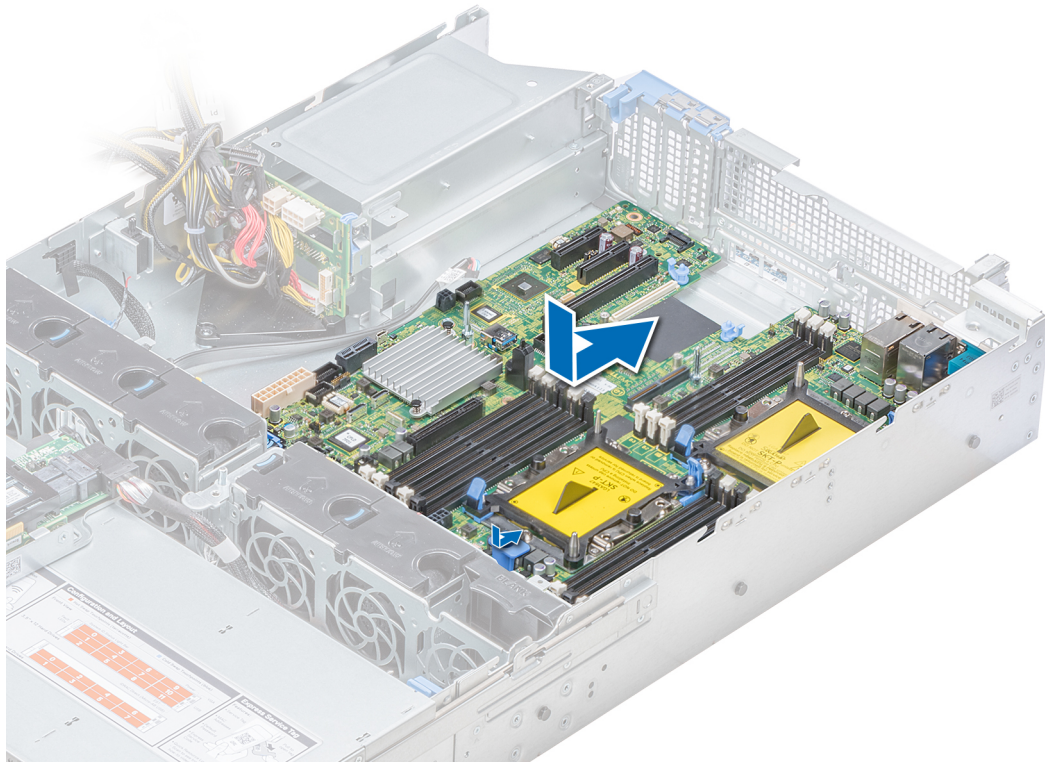

Figure 128. Installing system board

Next steps

1. Replace the following:
 - a. [Upgrading the Trusted Platform Module](#)
 - b. [Installing PERC card into the internal PERC riser](#)
 - c. [Optional internal USB memory key](#)
 - d. [USB 3.0 module \(if applicable\)](#)
 - e. [IDSDM/vFlash module card](#)
 - f. [All expansion cards and risers](#)
 - g. [Processors and heat sink modules](#)
 - h. [Processors blanks \(if applicable\)](#)
 - i. [Memory modules and memory module blanks](#)
 - j. [LOM riser card](#)
 - k. [Air shroud](#)
 - l. [Drive cage \(rear\) \(if applicable\)](#)
2. Reconnect all cables to the system board.

i **NOTE:** Ensure that the cables inside the system are routed along the chassis wall and secured using the cable securing bracket.
3. Follow the procedure listed in [After working inside your system](#).
4. Ensure that you:
 - a. Use the Easy Restore feature to restore the Service Tag. For more information, see the [Restoring the service tag using Easy Restore](#) section.
 - b. If the Service Tag is not backed up in the backup flash device, enter the Service Tag manually. For more information, see the [Manually update the Service Tag](#) section.
 - c. Update the BIOS and iDRAC versions.
 - d. Re-enable the Trusted Platform Module (TPM). For more information, see the [Upgrading the Trusted Platform Module](#) section.
5. Import your new or existing iDRAC Enterprise license.



For more information, see *Integrated Dell Remote Access Controller User's Guide*, at www.dell.com/poweredge manuals.

Restoring the system using Easy Restore

The easy restore feature enables you to restore your service tag, license, UEFI configuration, and the system configuration data after replacing the system board. All data is backed up in a backup flash device automatically. If BIOS detects a new system board, and the service tag in the backup flash device, BIOS prompts the user to restore the backup information.

About this task

Below is a list of options available:

- Restore the service tag, license, and diagnostics information, press **Y**
- Navigate to the Lifecycle Controller based restore options, press **N**.
- Restore data from a previously created **Hardware Server Profile**, press **F10**
-  **NOTE: When the restore process is complete, BIOS prompts to restore the system configuration data.**
- To restore the system configuration data, press **Y**
- To use the default configuration settings, press **N**
-  **NOTE: After the restore process is complete, system reboots.**

Manually update the Service Tag

After replacing a system board, if Easy Restore fails, follow this process to manually enter the Service Tag, using **System Setup**.

About this task

If you know the system service tag, use the **System Setup** menu to enter the service tag.

Steps

1. Power on the system.
2. To enter the **System Setup**, press **F2**.
3. Click **Service Tag Settings**.
4. Enter the service tag.
-  **NOTE: You can enter the service tag only when the Service Tag field is empty. Ensure that you enter the correct service tag. Once the service tag is entered, it cannot be updated or changed.**
5. Click **OK**.

Entering the system Service Tag by using System Setup

If Easy Restore fails to restore the Service Tag, use System Setup to enter the Service Tag.

Steps

1. Turn on the system.
2. Press F2 to enter System Setup.
3. Click **Service Tag Settings**.
4. Enter the Service Tag.
-  **NOTE: You can enter the Service Tag only when the Service Tag field is empty. Ensure that you enter the correct Service Tag. After the Service Tag is entered, it cannot be updated or changed.**
5. Click **OK**.
6. Import your new or existing iDRAC Enterprise license.

For more information, see the *Integrated Dell Remote Access Controller User's Guide* at www.dell.com/poweredge/manuals.

Identifier	GUID-D178B70E-9F36-45AB-8922-08508AC5C956
Status	Released

Trusted Platform Module

Identifier	GUID-881CD083-C31A-4228-B8B4-B5BAA209495F
Status	Released

Upgrading the Trusted Platform Module

Prerequisites

1. Follow the safety guidelines listed in [Safety instructions](#).
2. Follow the procedure listed in [Before working inside your system](#).

NOTE:

- Ensure that your operating system supports the version of the TPM module being installed.
- Ensure that you download and install the latest BIOS firmware on your system.
- Ensure that the BIOS is configured to enable UEFI boot mode.

About this task

 **CAUTION:** Once the TPM plug-in module is installed, it is cryptographically bound to that specific system board. Any attempt to remove an installed TPM plug-in module breaks the cryptographic binding, the removed TPM cannot be reinstalled or installed on another system board.

Removing the TPM

Steps

1. Locate the TPM connector on the system board.

 **NOTE:** To locate the TPM connector on the system board, see the [Jumpers and connectors](#) section.

2. Press to hold the module down and remove the screw using the security Torx 8-bit shipped with the TPM module.
3. Slide the TPM module out from its connector.
4. Push the plastic rivet away from the TPM connector and rotate it 90° counterclockwise to release it from the system board.
5. Pull the plastic rivet out of its slot on the system board.

Installing the TPM

Steps

1. To install the TPM, align the edge connectors on the TPM with the slot on the TPM connector.
2. Insert the TPM into the TPM connector such that the plastic rivet aligns with the slot on the system board.
3. Press the plastic rivet until the rivet snaps into place.

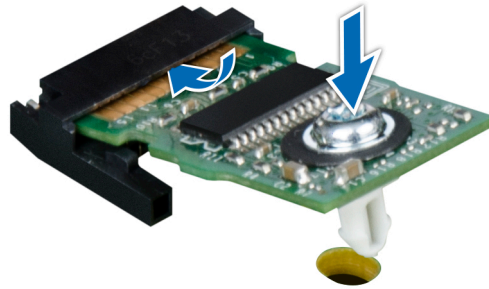

Figure 129. Installing the TPM

Next steps

1. [Install the system board.](#)
2. Follow the procedure listed in [After working inside your system.](#)

Identifier	GUID-75B29419-FA77-495D-BADC-F2E789E14631
Status	Released

Initializing TPM for BitLocker users

Steps

Initialize the TPM.

For more information, see <http://technet.microsoft.com/en-us/library/cc753140.aspx>.

The **TPM Status** changes to **Enabled, Activated**.

Identifier	GUID-2D8A61C1-D674-4EBB-8F86-28B861E203AC
Status	Released

Initializing the TPM 1.2 for TXT users

Steps

1. While booting your system, press F2 to enter System Setup.
2. On the **System Setup Main Menu** screen, click **System BIOS > System Security Settings**.
3. From the **TPM Security** option, select **On with Pre-boot Measurements**.
4. From the **TPM Command** option, select **Activate**.
5. Save the settings.
6. Restart your system.
7. Enter **System Setup** again.
8. On the **System Setup Main Menu** screen, click **System BIOS > System Security Settings**.
9. From the **Intel TXT** option, select **On**.

Identifier	GUID-36DC3F01-8F25-4C37-A6EE-57861CE811CB
Status	Released

System diagnostics

If you experience a problem with your system, run the system diagnostics before contacting Dell for technical assistance. The purpose of running system diagnostics is to test your system hardware without using additional equipment or risking data loss. If you are unable to fix the problem yourself, service and support personnel can use the diagnostics results to help you solve the problem.

Topics:

- [Dell Embedded System Diagnostics](#)

Identifier	GUID-1605B82A-D1FF-4100-8ABF-360FEA7E5887
Status	Released

Dell Embedded System Diagnostics

NOTE: The Dell Embedded System Diagnostics is also known as Enhanced Pre-boot System Assessment (ePSA) diagnostics.

The Embedded System Diagnostics provides a set of options for particular device groups or devices allowing you to:

- Run tests automatically or in an interactive mode
- Repeat tests
- Display or save test results
- Run thorough tests to introduce additional test options to provide extra information about the failed device(s)
- View status messages that inform you if tests are completed successfully
- View error messages that inform you of problems encountered during testing

Identifier	GUID-1E13B31E-71C2-4727-A788-FE65991C422E
Status	Released

Running the Embedded System Diagnostics from Boot Manager

Run the Embedded System Diagnostics (ePSA) if your system does not boot.

Steps

1. When the system is booting, press F11.
2. Use the up arrow and down arrow keys to select **System Utilities > Launch Diagnostics**.
3. Alternatively, when the system is booting, press F10, select **Hardware Diagnostics > Run Hardware Diagnostics**. The **ePSA Pre-boot System Assessment** window is displayed, listing all devices detected in the system. The diagnostics starts executing the tests on all the detected devices.

Results

Identifier	GUID-6741A128-2B0D-4613-BA58-8247403F4BA3
Status	Released

Running the Embedded System Diagnostics from the Dell Lifecycle Controller

Steps

1. As the system boots, press F10.
2. Select **Hardware Diagnostics** → **Run Hardware Diagnostics**.
The **ePSA Pre-boot System Assessment** window is displayed, listing all devices detected in the system. The diagnostics starts executing the tests on all the detected devices.

Identifier	GUID-3C4899F0-142A-4DB3-90E6-D820799D4509
Status	Released

System diagnostic controls

Menu	Description
Configuration	Displays the configuration and status information of all detected devices.
Results	Displays the results of all tests that are run.
System health	Provides the current overview of the system performance.
Event log	Displays a time-stamped log of the results of all tests run on the system. This is displayed if at least one event description is recorded.

Identifier	GUID-64FA26B7-629D-4342-BF65-6583F8ABCF42
Status	Released

Jumpers and connectors

This topic provides specific information about the jumpers. It also provides some basic information about jumpers and switches and describes the connectors on the various boards in the system. Jumpers on the system board help to disable the system and setup passwords. You must know the connectors on the system board to install components and cables correctly.

Topics:

- [System board jumpers and connectors](#)
- [System board jumper settings](#)
- [Disabling forgotten password](#)

System board jumpers and connectors

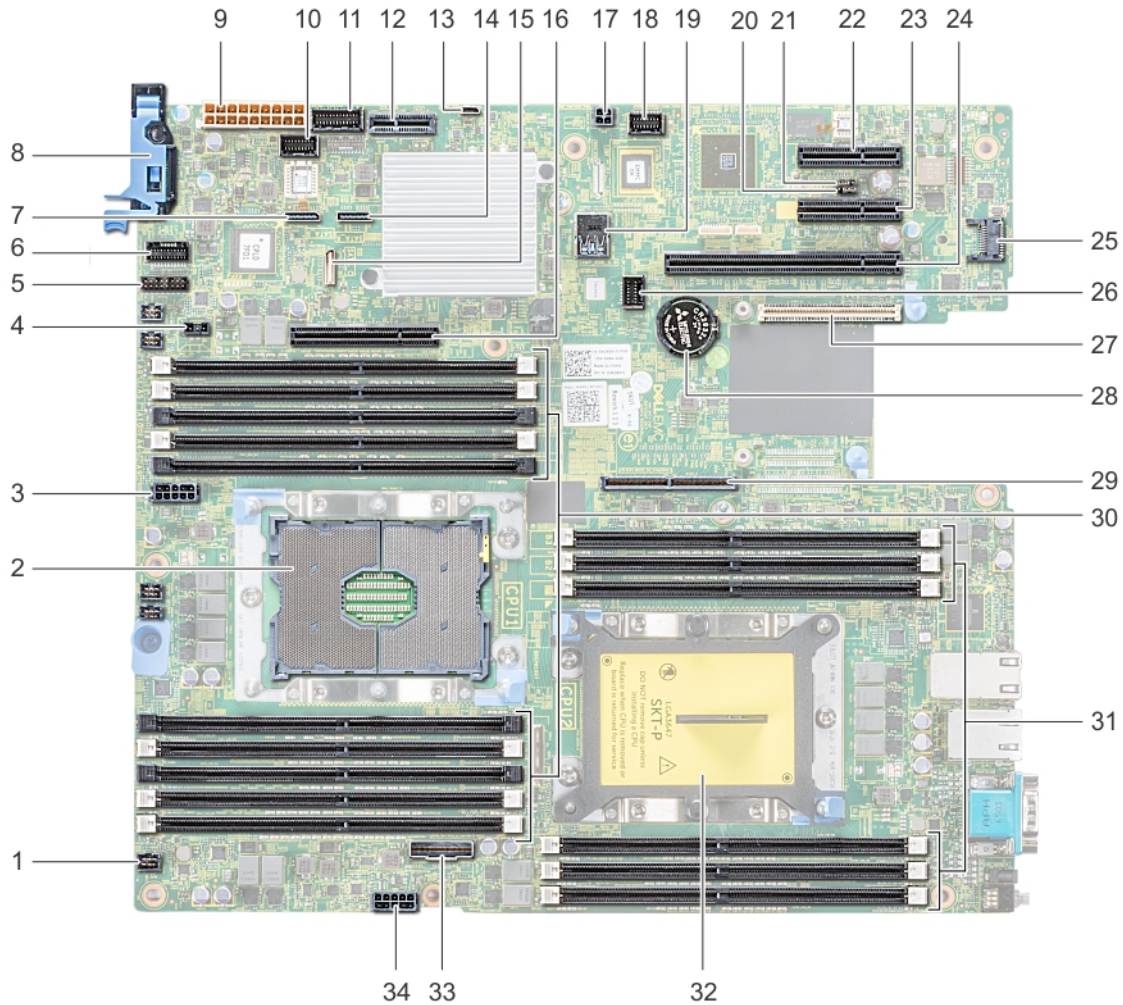

Figure 130. System board jumpers and connectors

Table 55. System board jumpers and connectors

Item	Connector	Description
1.	FAN6	Cooling fan 6 connector
2.	CPU1	Processor socket 1
3.	CPU1_PWR_CONN(P2)	CPU1 power connector
4.	J_INTRU	Intrusion switch connector
5.	J_BP_SIG1	Backplane signal connector 1
6.	LFT_CP_CONN	Left control panel connector
7.	J_SATA_B1	Internal SATA B connector
8.	RGT_CP_CONN	Right panel connector
9.	SYS_PWR_CONN(P1)	System power connector
10.	J_PIB_SIG1	Power interface board signal connector 1





Item	Connector	Description
11.	J_PIB_SIG2	Power interface board signal connector 2
12.	J_ACE	Internal Dual SD Module
13.	J_CP_USB2	Front USB connector
14.	J_SATA_A1	Internal SATA A connector
15.	J_SATA_C1	Internal SATA C connector
16.	PCIE_G3_X8(CPU1)	Internal PERC controller connector
17.	J_REAR_BP_PWR1	ODD power connector
18.	J_FRONT_VIDEO	VGA connector
19.	INT_USB_3.0	USB connector
20.	NVRAM_CLR	Clear NVRAM
21.	PWRD_EN	Reset BIOS password
22.	SLOT6	PCIe slot 6
23.	SLOT5	PCIe slot 5
24.	SLOT4	PCIe slot 4
25.	J_TPM_MODULE	TPM module connector
26.	J_BP_SIG0	Backplane signal connector
27.	J_MEZZ_A1	LOM riser card connector
28.	BATTERY	Battery connector
29.	PCIE_G3_X16(CPU1)	Riser 1 connector
30.	A6, A5, A10, A4, A9, A7, A1, A8, A2, A3	Memory module sockets
31.	B3, B2, B1, B4, B5, B6	Memory module sockets
32.	CPU2	Processor socket 2
33.	PCIE_A0	NVMe connector
34.	CPU2_PWR_CONN(P3)	CPU2 power connector

Identifier GUID-07FCBF6E-DE4A-4E7C-B77F-F3479105222A
Status Released

System board jumper settings

For information on resetting the password jumper to disable a password, see the [Disabling a forgotten password](#) section.

Table 56. System board jumper settings

Jumper	Setting	Description
PWRD_EN	 (default)	The BIOS password feature is enabled.
		The BIOS password feature is disabled. iDRAC local access is unlocked at next AC power cycle. iDRAC password reset is enabled in F2 iDRAC settings menu.
NVRAM_CLR	 (default)	The BIOS configuration settings are retained at system boot.
		The BIOS configuration settings are cleared at system boot.

Disabling forgotten password

The software security features of the system include a system password and a setup password. The password jumper enables or disables password features and clears any password(s) currently in use.

Prerequisites

⚠ CAUTION: Many repairs may only be done by a certified service technician. You should only perform troubleshooting and simple repairs as authorized in your product documentation, or as directed by the online or telephone service and support team. Damage due to servicing that is not authorized by Dell is not covered by your warranty. Read and follow the safety instructions that are shipped with your product.

Steps

1. Power off the system, including any attached peripherals, and disconnect the system from the electrical outlet.
2. Remove the system cover.
3. Move the jumper on the system board jumper from pins 2 and 4 to pins 4 and 6.
4. Install the system cover.

The existing passwords are not disabled (erased) until the system boots with the jumper on pins 4 and 6. However, before you assign a new system and/or setup password, you must move the jumper back to pins 2 and 4.

i NOTE: If you assign a new system and/or setup password with the jumper on pins 4 and 6, the system disables the new password(s) the next time it boots.

5. Reconnect the system to its electrical outlet and power on the system, including any attached peripherals.
6. Power off the system, including any attached peripherals, and disconnect the system from the electrical outlet.
7. Remove the system cover.
8. Move the jumper on the system board jumper from pins 4 and 6 to pins 2 and 4.
9. Install the system cover.
10. Reconnect the system to its electrical outlet and power on the system, including any attached peripherals.
11. Assign a new system and/or setup password.

Identifier	GUID-882E39D8-4986-45E1-A28B-1B3C5D0F7501
Status	Released

Getting help

Topics:

- [Contacting Dell EMC](#)
- [Documentation feedback](#)
- [Accessing system information by using QRL](#)
- [Receiving automated support with SupportAssist](#)
- [Recycling or End-of-Life service information](#)

Identifier	GUID-DCA91BD8-DB0D-45D8-BB42-184861B08BA9
Status	Released

Contacting Dell EMC

Dell EMC provides several online and telephone based support and service options. If you do not have an active internet connection, you can find contact information about your purchase invoice, packing slip, bill, or Dell EMC product catalog. Availability varies by country and product, and some services may not be available in your area. To contact Dell EMC for sales, technical assistance, or customer service issues:

Steps

1. Go to www.dell.com/support/home.
2. Select your country from the drop-down menu on the lower right corner of the page.
3. For customized support:
 - a) Enter your system Service Tag in the **Enter your Service Tag** field.
 - b) Click **Submit**.
The support page that lists the various support categories is displayed.
4. For general support:
 - a) Select your product category.
 - b) Select your product segment.
 - c) Select your product.
The support page that lists the various support categories is displayed.
5. For contact details of Dell EMC Global Technical Support:
 - a) Click [Global Technical Support](#).
 - b) The **Contact Technical Support** page is displayed with details to call, chat, or e-mail the Dell EMC Global Technical Support team.

Identifier	GUID-4B759C30-846C-4112-9D10-F2E046D6690A
Status	Released

Documentation feedback

You can rate the documentation or write your feedback on any of our Dell EMC documentation pages and click **Send Feedback** to send your feedback.

Identifier	GUID-9ACE1BD3-E3FB-4823-A49B-88E2F2787E62
Status	Released

Accessing system information by using QRL

You can use the Quick Resource Locator (QRL) located on the information tag in the front of the R540, to access the information about the Dell EMC PowerEdge R540.

Prerequisites

Ensure that your smartphone or tablet has the QR code scanner installed.

The QRL includes the following information about your system:

- How-to videos
- Reference materials, including the Installation and Service Manual, LCD diagnostics, and mechanical overview
- Your system service tag to quickly access your specific hardware configuration and warranty information
- A direct link to Dell to contact technical assistance and sales teams

Steps

1. Go to www.dell.com/qrl and navigate to your specific product or
2. Use your smartphone or tablet to scan the model-specific Quick Resource (QR) code on your system or in the Quick Resource Locator section.

Identifier	GUID-8A40469C-D181-41C6-BB6D-06B1DC809B6E
Status	Released

Quick Resource Locator for R540

Quick Resource Locator for PowerEdge R540



Identifier	GUID-61748589-5F8A-4B0B-A909-F08477FE3572
Status	Released

Receiving automated support with SupportAssist

Dell EMC SupportAssist is an optional Dell EMC Services offering that automates technical support for your Dell EMC server, storage, and networking devices. By installing and setting up a SupportAssist application in your IT environment, you can receive the following benefits:

- **Automated issue detection** — SupportAssist monitors your Dell EMC devices and automatically detects hardware issues, both proactively and predictively.
- **Automated case creation** — When an issue is detected, SupportAssist automatically opens a support case with Dell EMC Technical Support.
- **Automated diagnostic collection** — SupportAssist automatically collects system state information from your devices and uploads it securely to Dell EMC. This information is used by Dell EMC Technical Support to troubleshoot the issue.
- **Proactive contact** — A Dell EMC Technical Support agent contacts you about the support case and helps you resolve the issue.

The available benefits vary depending on the Dell EMC Service entitlement purchased for your device. For more information about SupportAssist, go to www.dell.com/supportassist.

Identifier	GUID-13205CA2-D447-498D-BBB8-B2A7F8CAADA0
Status	Released

Recycling or End-of-Life service information

Take back and recycling services are offered for this product in certain countries. If you want to dispose of system components, visit www.dell.com/recyclingworldwide and select the relevant country.