



PHILIPS

Super automatic
espresso machine

5000 series

EP5961, EP5960, EP5365
EP5364, EP5363, EP5361
EP5360, EP5065, EP5064
EP5060

EN USER MANUAL
DA BRUGERVEJLEDNING
DE BENUTZERHANDBUCH
ES MANUAL DEL USUARIO
FR MODE D'EMPLOI
IT MANUALE UTENTE
NL GEBRUIKSAANWIJZING
NO BRUKERHÅNDBOK
PT MANUAL DO UTILIZADOR
FI KÄYTTÖOPAS
SV ANVÄNDARHANDBOK
EL ΕΓΧΕΙΡΙΔΙΟ ΧΡΗΣΗΣ



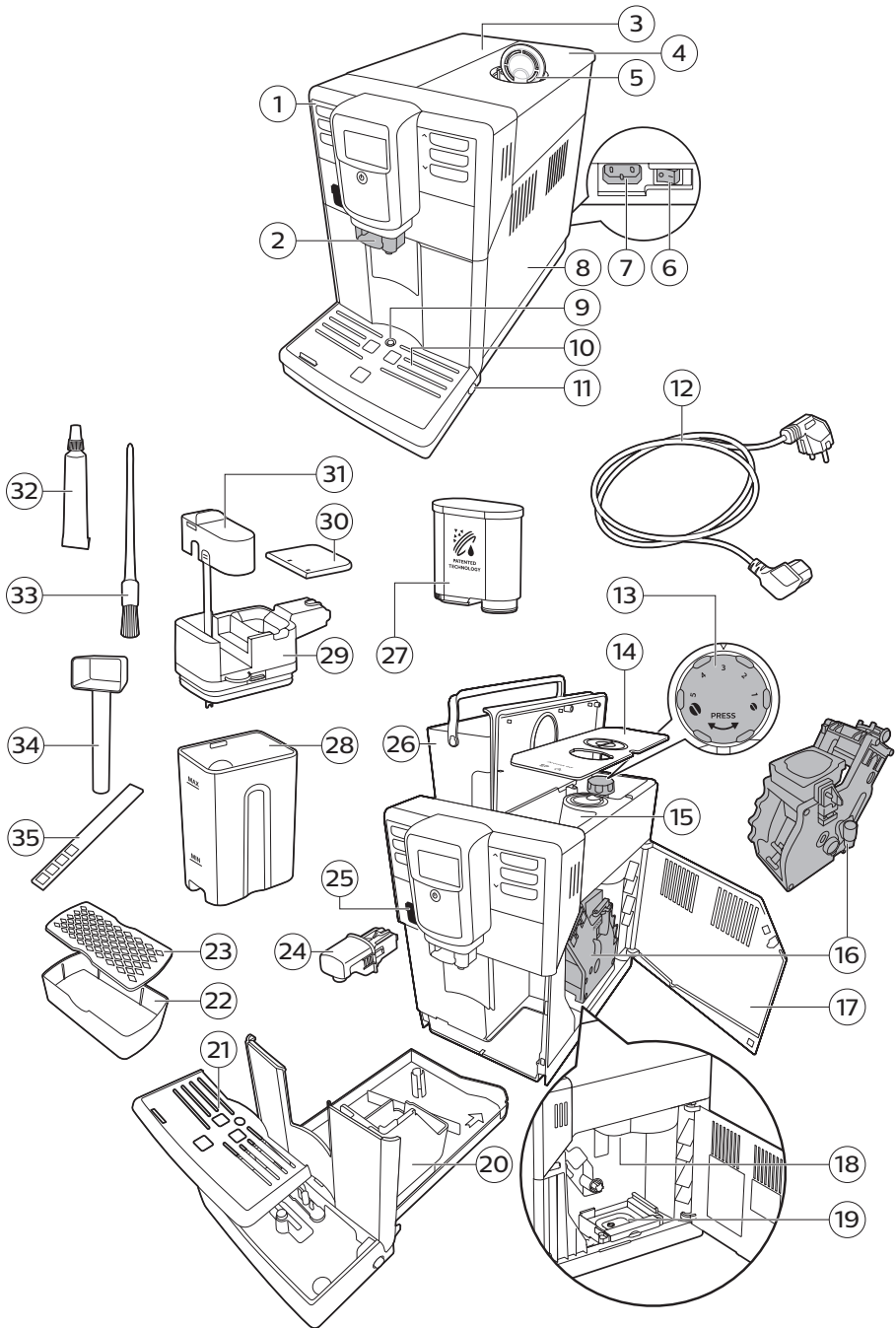

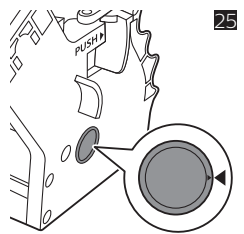
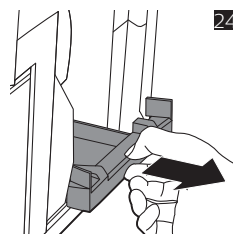
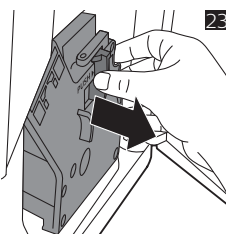
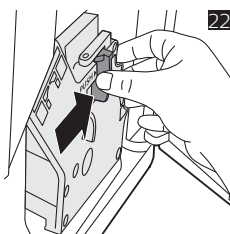
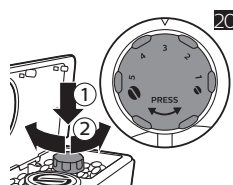
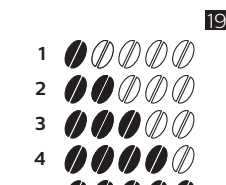
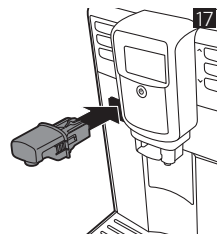
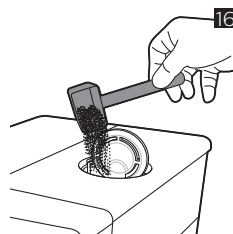
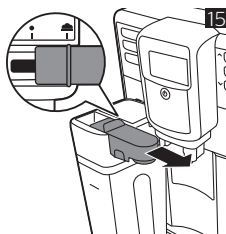
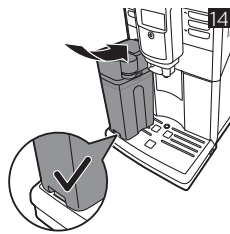
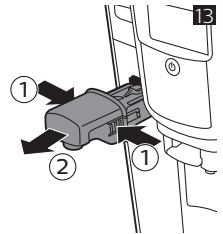
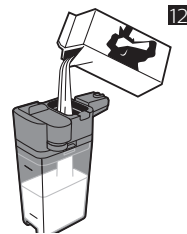
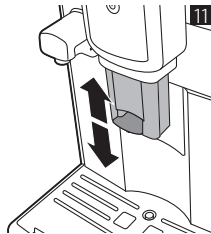
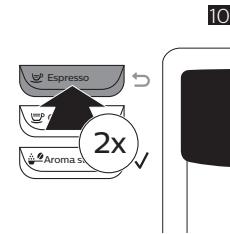
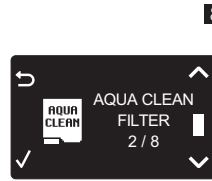
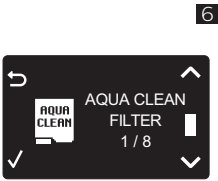
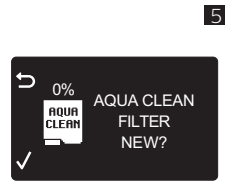
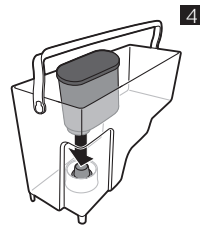
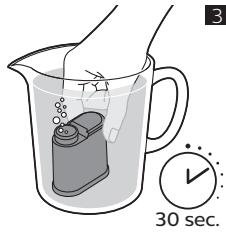
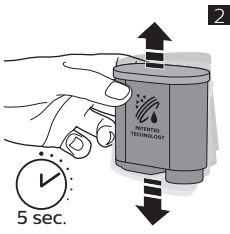

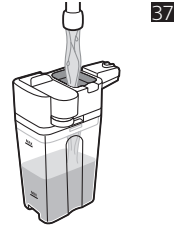
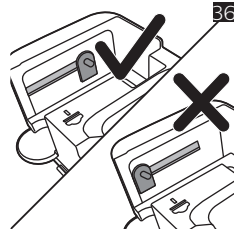
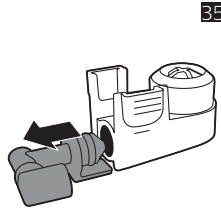
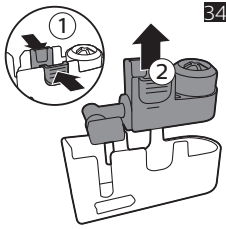
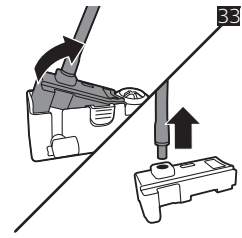
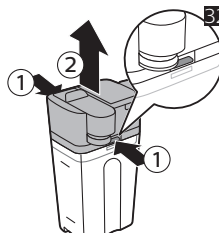
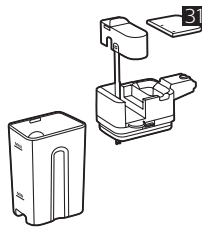
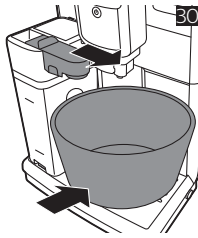
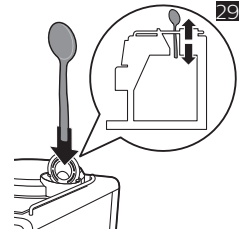
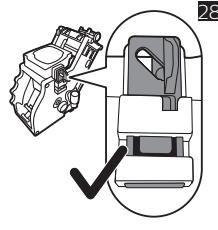
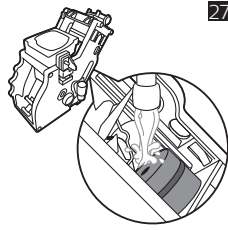
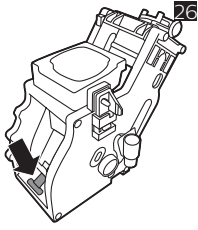

38

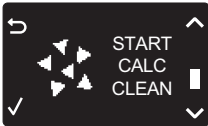

39



40



41



42

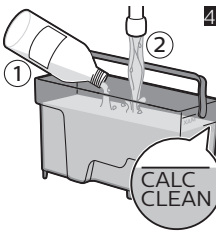

Contents

Machine overview (Fig. 1)	6
Introduction	7
First installation	7
AquaClean filter	7
Measuring water hardness	8
Using the control panel	9
Brewing drinks	9
Personalizing drinks	10
Adjusting grinder settings	11
Handling the brew group	11
Cleaning and maintenance	12
Cleaning the milk carafe	14
Descaling procedure	16
Warning icons and error codes	17
Ordering accessories	18
Troubleshooting	18
Technical specifications	22

Machine overview (Fig. 1)

1 Control panel	19 Coffee residues drawer
2 Adjustable coffee and milk dispensing spout	20 Coffee grounds container
3 Lid of water tank	21 Drip tray cover
4 Lid of bean hopper	22 Espresso stand tray
5 Lid of pre-ground coffee compartment	23 Espresso stand cover
6 Main switch	24 Hot water dispensing spout
7 Socket for cord	25 Opening for hot water dispensing spout
8 Service door	26 Water tank
9 'Drip tray full' indicator	27 AquaClean filter
10 Drip tray	28 Milk container
11 Drip tray release button	29 Milk dispensing unit
12 Cord	30 Lid of milk dispensing unit
13 Grind setting knob	31 Milk dispensing spout
14 Cover of bean hopper	32 Grease tube
15 Bean hopper	33 Cleaning brush

16	Brew group	34	Measuring scoop
17	Inside of service door with contact information	35	Water hardness test strip
18	Coffee exit duct		

Introduction

Congratulations on your purchase of a Philips full-automatic coffee machine! To fully benefit from the support that Philips offers, please register your product at www.philips.com/coffee-care.

Read the separate safety booklet carefully before you use the machine for the first time and save it for future reference.

To help you get the best out of your coffee machine, Philips offers full support in 3 different ways:

- 1 The separate quick start guide for first installation and first use.
- 2 This user manual for more detailed information.
- 3 Online support and movies: scan the QR code on the front page or visit www.philips.com/coffee-care

Note: This machine has been tested with coffee. Although it has been carefully cleaned, there may be some coffee residues left. We guarantee, however, that the machine is absolutely new.

First installation

To prepare your coffee machine for use, you need to perform a few simple steps such as filling the water circuit and activating the AquaClean filter. These steps are shown in the separate quick start guide.

For the best-tasting coffee, you need to brew 5 coffees initially to allow the machine to complete its self-adjustment.

The machine has been set up to get the best taste out of your coffee beans. Therefore we advise you not to adjust the grinder settings until you have brewed 100-150 cups (approx. 1 month of usage).

The machine is provided with the espresso stand, with the double function of cup support and extra drip tray to collect rinsing water.

AquaClean filter

The AquaClean filter is designed to reduce limescale deposits in your coffee machine and provide filtered water to preserve the aroma and flavor of each cup of coffee. If you use a series of 8 AquaClean filters as indicated by the machine and in this user manual, you don't have to descale your machine for up to 5000 cups. With each filter you can enjoy up to 625 cups, depending on the selected coffee varieties and the rinsing and cleaning frequencies.

Preparing the AquaClean filter for activation

Before you place the AquaClean filter in the water tank, you need to prepare it for use:

- 1 Shake the filter for about 5 seconds (Fig. 2).
- 2 Immerse the filter upside down in a jug with cold water for at least 30 seconds and wait until no more air bubbles come out (Fig. 3).
- 3 Push the filter onto the filter connection to the lowest possible point (Fig. 4).

Activating the AquaClean filter

You need to activate every new AquaClean filter that you use. By activating the AquaClean filter, the machine monitors the capacity of the AquaClean filter and the number of filters used. There are 3 ways to activate the AquaClean filter.

1. Activating the AquaClean filter during first installation

After switching on for the first time, the machine guides you through the first installation steps such as filling the water tank, filling the water circuit and activating the AquaClean filter. Simply follow the instructions on the screen.

2. Activating the AquaClean filter when prompted

Note: Replace the AquaClean filter as soon as the capacity has dropped to 0% and the filter icon flashes quickly. Replace the AquaClean filter at least every 3 months, even if the machine has not yet indicated that replacement is required.

Tip: We advise you to buy a new filter when the capacity has dropped to 10% and the filter icon starts flashing slowly. This ensures that you can replace the filter when the capacity has dropped to 0%.

- 1 Press the MENU button, scroll to AQUACLEAN FILTER and press the OK button to confirm.
 - The display asks if you want to activate a new filter (Fig. 5).
- 2 Press the OK button to confirm.
 - The display automatically updates the number of filters used (Fig. 6).

Note: If you want to replace the AquaClean filter after 8 filters have been used, you first need to descale the machine. Follow the instructions on the display.

3. Activating the AquaClean filter at any other time

You can start using the AquaClean filter at any time by following the instructions below.

- 1 Press the MENU button, select MENU and press the OK button to confirm. Scroll to AQUACLEAN FILTER. Press the OK button (✓) to confirm.
 - The display shows the numbers of AquaClean filters that have been installed previously from 0 to 8 filters (Fig. 6).
- 2 Select ON on the display and press the OK button (✓) to confirm (Fig. 7).
 - The display automatically updates the number of filters used (Fig. 8).
 - Then the 'machine ready' screen appears with the AquaClean 100% icon to indicate that the filter has been installed (Fig. 9).
- 3 Dispense 2 cups of hot water (0.5 l) to complete the activation. Discard this water.

Note: In some situations the machine will tell you that you need to descale the machine before you can install and activate a new AquaClean filter. This is because your machine has to be completely limescale-free before you start to use the AquaClean filter. Follow the instructions on the screen.

Measuring water hardness

Use the water hardness test strip supplied to set the water hardness. Press the MENU button, select MENU and scroll to select WATER HARDNESS.

- 1 Immerse the water hardness test strip in tap water for 1 second. Then wait for 1 minute.
- 2 Check how many squares have turned red.
- 3 Select the appropriate water hardness setting and press the OK button to confirm.

Number of red squares:	■ ■ ■ ■	■ ■ ■ ■	■ ■ ■ ■	■ ■ ■ ■
Value to be set	1	2	3	4

Using the control panel

Below you find an overview and description of the control panel of the machine. Some of the buttons have a double function; if applicable the navigation icons appear on the display. Use the buttons next to this icon to select or confirm your choices.

Use the MENU button to select other drinks and to change settings such as the water hardness and coffee temperature.

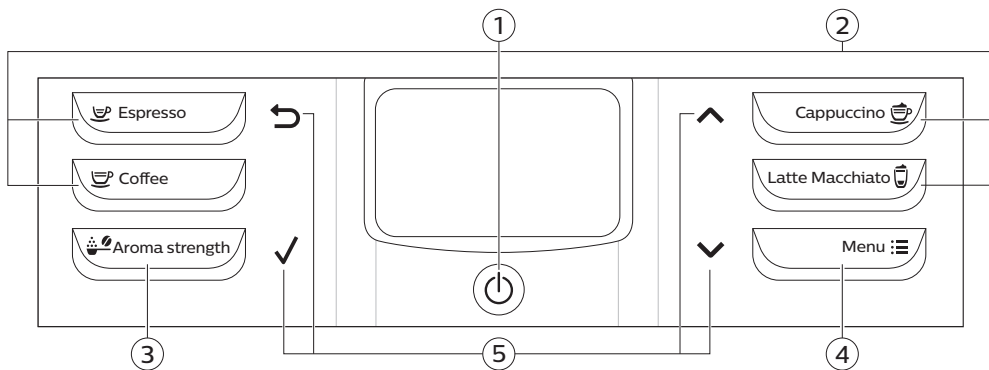

- | | |
|----------------------------|--|
| 1. On/off button | 4. MENU button |
| 2. One-touch drink buttons | 5. Navigation icons (up, down, back, ok) |
| 3. AROMA STRENGTH button | |

Brewing drinks

You can select a drink by pressing one of the one-touch drink buttons or by selecting another drink in the menu.

- If you want to brew two cups, press the one-touch drink button of the selected drink twice (Fig. 10) or select a coffee drink via the MENU and press it twice. The machine automatically carries out two grinding cycles in sequence for the selected drink. You can only brew two cups of coffee or two cups of espresso at the same time.
- Slide the dispensing spout up or down to adjust its height to the size of the cup or glass you are using (Fig. 11).

Brewing coffee drinks

Brewing coffee with beans

- 1 Fill the water tank with tap water and fill the bean hopper with beans.
- 2 To brew a coffee, press one of the one-touch drink buttons. To select another drink, press the MENU button, select DRINKS, scroll down to the desired drink and press the OK button.
- 3 To stop dispensing coffee, press the OK button.

Brewing milk-based drinks

- 1 Fill the water tank with tap water and fill the bean hopper with beans.
- 2 Remove the lid of the milk container and fill the milk container with milk (Fig. 12).

Always use milk coming directly from the fridge for optimal results.

- 3 Place the lid back onto the milk container.
- 4 If attached, remove the hot water spout from the machine (Fig. 13).
- 5 Slightly tilt the milk carafe and attach it to the machine (Fig. 14).
- 6 Open the milk dispensing spout (Fig. 15) and place a cup on the drip tray.
- 7 To brew a milk-based drink, press one of the one-touch drink buttons. To select another type of milk-based drink, press the MENU button, select DRINKS, scroll down to the desired drink and press the OK button.
- 8 After brewing milk-based coffee beverages, the display asks you if you want to perform the quick clean procedure for the milk carafe. You have 10 seconds to activate the quick clean procedure. You can perform the quick clean procedure while leaving the milk inside the milk carafe. It is recommended to perform the quick clean procedure at least once a day. Press the OK button to confirm that you want to perform the quick clean procedure or press the escape button to perform the quick clean procedure later.

Brewing coffee with pre-ground coffee

- 1 Open the lid and pour one leveled measuring scoop of pre-ground coffee into the pre-ground coffee compartment. Then close the lid (Fig. 16).
- 2 Place a cup under the coffee dispensing spout. For smaller cups you can use the espresso stand.
- 3 Press the AROMA STRENGTH button and select the pre-ground coffee brewing function. Press the ESPRESSO button.

Note: With pre-ground coffee you can only brew one coffee at a time.

Dispensing hot water

- 1 If it is not attached, attach the hot water spout to the machine (Fig. 17).
- 2 Press the MENU button. Select DRINKS, confirm and scroll to select HOT WATER.
- 3 Press the OK button to confirm. The display reminds you to install the hot water dispensing spout; press the OK button to confirm. The machine starts dispensing hot water.
- 4 To stop dispensing hot water, press the OK button.

Personalizing drinks

Adjusting coffee and milk volume

You can adjust the volume of the drink brewed according to your taste and to the size of the cups. We advise you to use glass cups or cups with a ceramic-coated rim.

- 1 To adjust the espresso volume, press and hold the ESPRESSO button until the display shows the MEMO icon (Fig. 18).
 - The machine enters the programming phase and starts to brew the selected drink.
- 2 Press the OK button when the cup contains the desired amount of espresso.
 - The tick on the display shows that the button is programmed: every time it is pressed, the machine brews the set espresso volume.

Note: To set the volume of coffee, cappuccino and latte macchiato, follow the same procedure: press and hold the button of the beverage and press the OK button when the cup contains the desired amount. To adjust the volume of other drinks: select your drink, press and hold the OK button until the display shows the MEMO icon and then press the OK button again to save the desired volume. To adjust the volume of milk-based coffee beverages, first insert the milk carafe and save the milk volume and then save the coffee volume.

Adjusting coffee strength

- To change the coffee strength, press the AROMA STRENGTH button.
- Each time you press the AROMA STRENGTH button, the machine selects a higher aroma strength setting. There are 5 strengths, 1 is very mild and 5 is very strong. After setting 5, setting 1 is selected again (Fig. 19).
- Note: You can also use the AROMA STRENGTH button to brew coffee with pre-ground coffee
- The display shows the chosen strength. After adjusting the coffee strength, the display shows the main menu again and saves the chosen aroma strength when you brew a coffee.

Adjusting grinder settings

You can adjust the grinder settings by using the grind setting knob inside the bean container. There are 5 different grind settings you can choose from. The lower the setting, the stronger the coffee.

Note: You can only adjust the grind settings when the machine is grinding coffee beans. You need to brew 2 to 3 drinks before you can taste the full difference.

Caution: Do not turn the grind setting knob more than one notch at a time to prevent damage to the grinder.

- 1 Place a cup under the coffee dispensing spout.
- 2 Open the lid of the bean hopper.
- 3 Press the ESPRESSO button.
- 4 When the grinder starts grinding, press down the grind setting knob and turn it to the left or right (Fig. 20).

Handling the brew group

Go to www.philips.com/coffee-care for detailed video instructions on how to remove, insert and clean the brew group.

Removing the brew group from the machine

- 1 Switch off the machine by pressing the main switch on the back of the machine.
- 2 Remove the drip tray with the coffee grounds container.
- 3 Open the service door (Fig. 21).
- 4 Press the PUSH button (Fig. 22) and pull at the grip of the brew group to remove it from the machine (Fig. 23).
- 5 Remove the coffee residues drawer (Fig. 24).

Reinserting the brew group

Before you slide the brew group back into the machine, make sure it is in the correct position.

12 English

- 1 Check if the arrow on the yellow cylinder on the side of the brew group is aligned with the black arrow and N.
 - If they are not aligned, push down the lever until it is in contact with the base of the brew group (Fig. 26).
- 2 Make sure that the yellow locking hook on the other side of the brew group is in the correct position.
 - To position the hook correctly, push it upwards until it is in uppermost position (Fig. 28).
- 3 Place back the coffee residues drawer.
- 4 Slide the brew group back into the machine along the guiding rails on the sides until it locks into position with a click. Do not press the PUSH button.
- 5 Place back the drip tray with the coffee grounds container.

Cleaning and maintenance

Regular cleaning and maintenance keeps your machine in top condition and ensures good-tasting coffee for a long time, a steady coffee flow and a perfect milk froth.

Consult the table on when and how to clean all detachable parts of the machine. You can find more detailed information and video instructions on www.philips.com/coffee-care.

Cleaning table

Part description	When to clean	How to clean
Brew group	Weekly	Remove the brew group and rinse it under the tap (see 'Cleaning the brew group under the tap').
	Monthly	Clean the brew group with the Philips coffee oil remover tablet (see 'Cleaning the brew group with the coffee oil remover tablets'). Go to www.philips.com/coffee-care for detailed video instructions.
Lubrication of the brew group	Depending on the type of usage. Consult the lubrication table (see 'Lubricating the brew group').	Lubricate the brew group with the Philips grease. Go to www.philips.com/coffee-care for detailed video instructions.
Milk carafe	After every day of use	Perform the QUICK CARAFE CLEAN as indicated on the machine after preparing a milk-based drink.
	Daily	Clean the milk carafe thoroughly (see 'Thorough cleaning of the milk carafe').
	Weekly	Disassemble the milk carafe and clean all parts under the tap (see 'Weekly cleaning of the milk carafe').
	Monthly	Clean the milk carafe with the Philips milk circuit cleaner (see 'Monthly cleaning of the milk carafe').

Part description	When to clean	How to clean
Drip tray	Empty the drip tray as soon as the red 'drip tray full' indicator pops up through the drip tray. Clean the drip tray when it suits you.	Remove the drip tray and rinse it under the tap with some washing-up liquid.
Coffee grounds container	Empty the coffee grounds container when prompted by the machine. Clean it when it suits you.	Remove the coffee grounds container while the machine is switched on and rinse it under the tap with some washing-up liquid.
Water tank	When it suits you.	Rinse the water tank under the tap
Coffee funnel	Check the coffee funnel weekly to see if it is clogged.	Unplug the machine and remove the brew group. Open the lid of the pre-ground coffee compartment and insert the spoon handle into the coffee funnel. Move the handle up and down until the clogged ground coffee falls down (Fig. 29). Go to www.philips.com/coffee-care for detailed video instructions.
Espresso stand	Daily	Empty the espresso stand and clean it under the tap or in the dishwasher.

Tip: There is a cleaning calendar on the last page of this user manual. Write down the dates on which you have performed a cleaning action.

Cleaning the brew group

Regular cleaning of the brew group prevents coffee residues from clogging up the internal circuits. Visit www.philips.com/coffee-care for support videos on how to remove, insert and clean the brew group.

Cleaning the brew group under the tap

- 1 Remove the brew group and the coffee residues drawer.
- 2 Rinse the coffee residues drawer and the brew group thoroughly with water. Carefully clean the upper filter (Fig. 27) of the brew group.
- 3 Let the brew group air-dry before you place it back. Do not dry the brew group with a cloth to prevent fibers from collecting inside the brew group.

Cleaning the brew group with the coffee oil remover tablets

Only use Phillips Saeco coffee oil remover tablets. Follow the instructions given in the user manual that comes with the coffee oil remover tablets.

Lubricating the brew group

Lubricate the brew group regularly to ensure that the moving parts continue to move smoothly. See the table below for the lubrication frequency. Visit www.philips.com/coffee-care for detailed video instructions.

Usage frequency	Nr of drinks brewed daily	Lubrication frequency
Low	1-5	Every 4 months

14 English

Usage frequency	Nr of drinks brewed daily	Lubrication frequency
Normal	6-10	Every 2 months
Heavy	>10	Every month

Cleaning the milk carafe

Carafe quick clean

You can select the QUICK CLEAN function via the menu as described in the steps below:

- 1 Press the MENU button and select QUICK CLEAN, press the OK button to confirm.
- 2 Make sure that the milk carafe is installed and the milk froth dispensing spout is open.
- 3 Place the container under the milk froth dispensing spout.

Note: Make sure the milk dispensing spout is pulled out.

- 4 Press the OK button to start dispensing hot water.

Thorough cleaning of the milk carafe

To clean the milk carafe thoroughly, you have to do the following regularly:

- 1 Remove the lid of the milk dispensing unit.
- 2 Lift the milk dispensing spout out of the milk dispensing unit and remove the milk tube from the milk dispensing spout (Fig. 31).
- 3 Remove the milk tube from the milk dispensing spout.
- 4 Rinse the milk tube and milk dispensing spout with lukewarm water thoroughly.

Weekly cleaning of the milk carafe

The milk carafe consists of multiple components. Disassemble all components once a week and clean them under the tap. You can also clean some of the components in the dishwasher (see below figure).

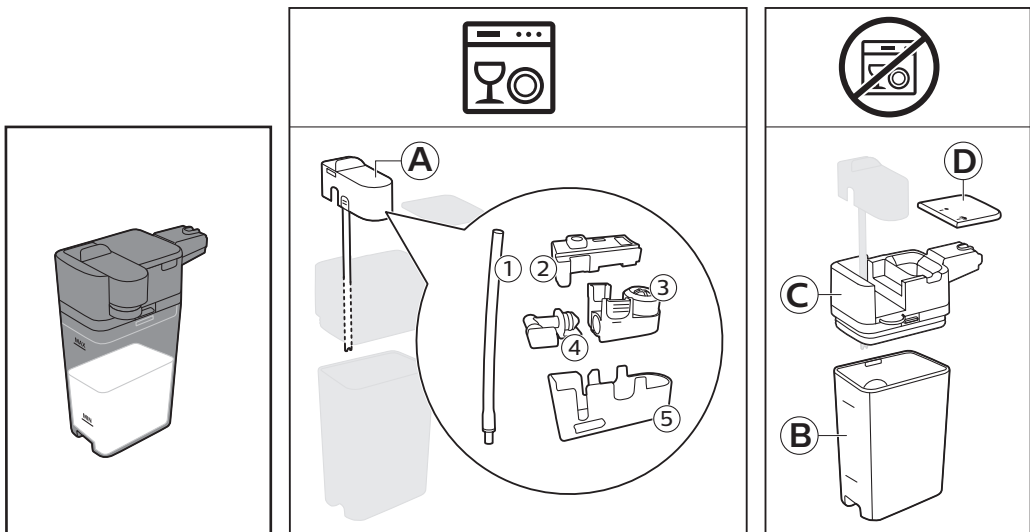

A	Milk dispensing spout	B	Lid of milk dispensing unit
A1	Milk tube	C	Milk dispensing unit
A2	Rubber support	D	Milk container
A3	Milk frother lid		
A4	Milk frother connector		
A5	Housing of milk dispensing spout		

Disassembling the milk dispensing spout

- 1 Press the release buttons on both sides of the top of the milk dispensing unit (1) and lift the top off the milk container (2) (Fig. 32).
- 2 Turn the milk dispensing unit upside down and hold it firmly in your hand. Pull the milk tube off the support (Fig. 33).
- 3 Press the release buttons on the milk frother and remove the milk frother from the the rubber support (Fig. 34).
- 4 Pull the milk frother connector out of the milk frother (Fig. 35).
- 5 Rinse all components under a lukewarm tap.

Reassembling the milk carafe

- 1 To reassemble the milk dispensing spout, follow steps 2 to 4 of 'Disassembling the milk dispensing spout' in reverse order.
- 2 Place the milk dispensing spout back into the top of the milk carafe.
- 3 Place the top of the milk carafe back onto the milk carafe.

Note: Before you place the milk dispensing spout back into the top of the milk carafe, move the pin inside the top to the correct position. If this pin is not in the correct position, you cannot place the milk dispensing spout back into the top of the milk carafe (Fig. 36).

Monthly cleaning of the milk carafe

Only use Philips milk circuit cleaner for this cleaning cycle.

- 1 Pour the contents of the milk circuit cleaner sachet in the milk carafe. Then fill the milk carafe with water up to the MAX indication (Fig. 37).
- 2 Insert the milk carafe into the machine and place a container under the milk dispensing spout.
- 3 Press the MENU button, select DRINKS and scroll to MILK FROTH. Press the OK button to start dispensing the cleaning solution.
- 4 Repeat step 3 until the milk carafe is empty.
- 5 When the carafe is empty, remove the container and the milk carafe from the machine.
- 6 Rinse the milk carafe thoroughly and fill it with fresh water up to the MAX level indication.
- 7 Insert the milk carafe into the machine.
- 8 Place the container under the milk dispensing spout.
- 9 Press the MENU button and select MILK FROTH in the DRINKS menu to start the carafe rinsing cycle.
- 10 Repeat step 9 until the milk carafe is empty.
- 11 Repeat steps 6-10.

16 English

12 When the machine stops dispensing water, the cleaning cycle is finished.

13 Disassemble all the components and rinse them under a lukewarm tap.

Descaling procedure

Please use Philips descaler only. Under no circumstances should you use a descaler based on sulfuric acid, hydrochloric acid, sulfamic or acetic acid (vinegar) as this may damage the water circuit in your machine and not dissolve the limescale properly. Not using the Philips descaler will void your warranty. Failure to descale the appliance will also void your warranty. You can buy Philips descaling solution in the online shop at www.philips.com/coffee-care.

- 1** When the machine asks you to descale it (Fig. 38), press the OK button to start. To start descaling without being prompted by the machine, press the MENU button, scroll to select START CALC CLEAN and press the OK button to confirm.
 - The display reminds you that you have to insert the milk carafe. (Fig. 39) Fill the milk carafe with water up to the MIN level indication. Insert the milk carafe into the machine and open the milk dispensing spout.
 - The display reminds you that you have to open the milk dispensing spout (Fig. 40).
 - The display reminds you that you have to remove the AquaClean filter (Fig. 41).
- 2** Remove the espresso stand from the drip tray.
- 3** Remove the drip tray and the coffee grounds container, empty them and put them back into place.
- 4** Remove the water tank and empty it.
- 5** Place a large container (1.5 l) under the coffee dispensing spout.
- 6** Pour the whole bottle of Philips descaler in the water tank and then fill it with water up to the CALC CLEAN level (Fig. 42). Then place it back into the machine and press the OK button to confirm.
- 7** The first phase of the descaling procedure starts. The descaling procedure lasts approx. 30 minutes and consists of a descaling cycle and a rinsing cycle.
- 8** Let the machine dispense the descaling solution until the display reminds you that the water tank is empty.
- 9** Empty the water tank, rinse it and then refill it with fresh water up to the CALC CLEAN level indication.
- 10** Remove and rinse the milk carafe. Fill it with fresh water up to the MIN level indication and reinsert it into the machine. Then open the milk froth dispensing spout.
- 11** Empty the container and place it back under the coffee dispensing spout. Press OK to confirm.
- 12** The second phase of the descaling cycle, the rinsing phase, starts and lasts 3 minutes. The display shows the rinsing icon and the duration of the phase.
- 13** Wait until the machine stops dispensing water. The descaling procedure is finished when the tick appears on the display.
- 14** Press the OK button to exit the descaling cycle. The machine starts heating up and performs the automatic rinsing cycle.
- 15** Clean the milk carafe after descaling (see 'Weekly cleaning of the milk carafe').
- 16** Clean the brew group after descaling (see 'Cleaning the brew group under the tap').
- 17** Place a new AquaClean filter in the water tank.

Tip: Using the AquaClean filter reduces the need for descaling!

What to do if the descaling procedure is interrupted

You can exit the descaling procedure by pressing the on/off button on the control panel. If the descaling procedure is interrupted before it is completely finished, do the following:

- 1** Empty and rinse the water tank thoroughly.

- 2 Fill the water tank with fresh water up to the CALC CLEAN level indication and switch the machine back on. The machine will heat up and perform an automatic rinsing cycle.
- 3 Before brewing any drinks, perform a manual rinsing cycle. To perform a manual rinsing cycle, first dispense half a water tank of hot water and then brew 2 cups of pre-ground coffee without adding ground coffee.

Note: If the descaling procedure was not completed, the machine will require another descaling procedure as soon as possible.

Warning icons and error codes

Meaning of the warning icons



Fill the water tank with fresh water to the MAX level indication.



The brew group is blocked by coffee powder. Clean the brew group.



The bean hopper is empty. Put new coffee beans in the bean hopper.



Insert the drip tray and close the service door.



The brew group is not in the machine or it is not inserted correctly. Insert the brew group.



If the display shows an error code, check section 'Meaning of the error codes' to see what the code on the display means and what you can do. The machine cannot be used when this icon is on the display.



The coffee grounds container is full. Make sure the machine is switched on. Then remove and empty the coffee grounds container.



There is air in the machine, place a cup under the hot water spout and select Ok to start priming. Make sure the hot water spout is inserted before starting the process.

Meaning of error codes

Below you find a list of the error codes showing problems that you can solve yourself. Video instructions are available on www.philips.com/coffee-care. If another error code appears, please contact the Philips Consumer Care Center in your country. For contact details, see the warranty leaflet.

Error code	Problem	Possible solution
01	The coffee funnel is blocked by ground coffee or a foreign object.	Switch off the machine and unplug it. Remove the brew group. Then open the lid of the pre-ground coffee compartment. Insert the spoon handle and move it up and down to make clogged ground coffee fall down (Fig. 29). If a foreign object is blocking the coffee funnel, remove it. Visit www.philips.com/coffee-care for detailed video instructions

18 English

Error code	Problem	Possible solution
03	The brew group is dirty or not well-greased.	Switch off the machine with the main switch. Rinse the brew group with fresh water, let it air-dry and then lubricate it (see 'Lubricating the brew group'). Consult chapter 'Cleaning the brew group' or visit www.philips.com/coffee-care for detailed video instructions. Then switch the machine on again.
04	The brew group is not positioned correctly.	Switch off the machine with the main switch. Remove the brew group and reinsert it. Make sure that the brew group is in the correct position before you insert it. Consult chapter 'Handling the brew group' or visit www.philips.com/coffee-care for detailed video instructions. Then switch the machine on again.
05	There is air in the water circuit.	Restart the machine by switching it off and on again with the main switch. If this works, dispense 2-3 cups of hot water. Descale the machine if you have not done so for a longer period of time.
	The AquaClean filter was not prepared properly before installation or it is clogged.	Remove the AquaClean filter and try again to brew a coffee. If this works, make sure that the AquaClean filter is prepared properly before you place it back (see 'Preparing the AquaClean filter for activation'). Put the AquaClean filter back into the water tank. If this still does not work, the filter is clogged and needs to be replaced.
14	The machine is overheated.	Switch the machine off and switch it back on again after 30 minutes.

Ordering accessories

To clean and descale the machine, only use the Philips maintenance products. These products can be purchased from your local retailer, from the authorized service centers or online at www.shop.philips.com/service. To find a full list of spare parts online, enter the model number of your machine. You can find the model number on the inside of the service door.

Maintenance products and type numbers:

- Descaling solution CA6700
- AquaClean filter CA6903
- Brew group grease HD5061
- Coffee oil remover tablets CA6704
- Milk circuit cleaner CA6705
- Maintenance kit CA6707

Troubleshooting

This chapter summarizes the most common problems you could encounter with the machine. Support videos and a complete list of frequently asked questions are available on www.philips.com/coffee-care. If you are unable to solve the problem, contact the Consumer Care Center in your country. For contact details, see the warranty leaflet.

Problem	Cause	Solution
The drip tray fills up quickly.	This is normal. The machine uses water to rinse the internal circuit and brew group. Some water flows through the internal system directly into the drip tray.	Empty the drip tray when the 'drip tray full' indicator pops up through the drip tray cover.
		Place the espresso stand under the dispensing spout to collect rinsing water.
The machine is in DEMO mode.	You pressed the standby button for more than 8 seconds.	Switch the machine off and then on again with the main switch on the back of the machine.
The 'coffee grounds container full' icon remains displayed.	You emptied the coffee grounds container while the machine was switched off.	Always empty the coffee grounds container while the machine is switched on. If you empty the coffee grounds container when the machine is switched off, the coffee cycle counter is not reset.
	You placed back the coffee grounds container too early.	Do not place back the coffee grounds container until the screen prompts you to put it back.
I cannot remove the brew group.	The brew group is not in the correct position.	Reset the machine in the following way: place back the drip tray and the coffee grounds container. Then close the service door and switch the machine off and back on again. Try again to remove the brew group.
	You have not removed the coffee grounds container.	Remove the coffee grounds container before you remove the brew group.
I cannot insert the brew group.	The brew group is not in the correct position.	Reset the machine in the following way: place back the drip tray and the coffee grounds container. Leave the brew group out. Close the service door and switch the machine on and off. Then put the brew group in the correct position and reinsert it into the machine.
	The machine is still in the descaling procedure.	You cannot remove the brew group when the descaling procedure is in progress. First complete the descaling procedure and then remove the brew group.
The coffee is watery.	The grinder is set to a too coarse setting.	Set the grinder to a finer (lower) setting.
	The coffee exit duct is clogged.	Clean the coffee exit duct with the spoon handle. Then switch the machine off and on again.

20 English

Problem	Cause	Solution
	The machine is performing its self-adjustment procedure.	Brew a few cups of coffee.
	The brew group is dirty or needs to be lubricated.	Clean and lubricate the brew group.
The coffee is not hot enough.	The cups you use are cold.	Preheat the cups by rinsing them with hot water.
	The temperature is set too low. Check the menu settings.	Set the temperature to 'high' in the menu.
	You added milk.	Whether the milk you add is warm or cold, it always decreases the temperature of the coffee to some extent.
Coffee is leaking from the coffee dispensing spout.	The coffee dispensing spout is clogged.	Clean the coffee dispensing spout and its holes with a pipe cleaner.
	The coffee exit duct is clogged	Clean the coffee exit duct with the handle of the measuring spoon or a spoon handle. Then switch the appliance off and on again.
Coffee does not come out or coffee comes out slowly.	The AquaClean filter was not prepared properly for installation or it is clogged.	Remove the AquaClean filter and try to brew a coffee again. If this works, make sure the AquaClean filter is prepared properly before you place it back. Place back the prepared filter. If this still does not work, the filter is clogged and needs to be replaced.
	The grinder is set to a too fine setting.	Set the grinder to a coarser (higher) setting.
	The brew group is dirty.	Clean the brew group.
	The coffee dispensing spout is dirty.	Clean the coffee dispensing spout and its holes with a needle.
	The machine circuit is blocked by limescale.	Descale the machine.
The milk does not froth.	The milk carafe is dirty or not inserted correctly.	Clean the carafe and make sure that you position and insert it correctly.
	The milk dispensing spout has not been opened fully.	Make sure that the milk dispensing spout is in the correct position.
	The milk carafe is incompletely assembled.	Make sure that all the components (especially the milk tube) have been assembled correctly.

Problem	Cause	Solution
	The type of milk used is not suitable for frothing.	Different types of milk result in different amounts of froth and different froth qualities. We have tested the following milk types which proved to deliver a good milk froth result: semi-skimmed or full-fat cow's milk, soy milk and lactose-free milk.
The coffee is splashing.	The distance between cup and spout is too large.	Place the espresso stand on the drip tray, under the spout.
The milk is splashing.	The milk you use is not cold enough.	Make sure you use cold milk coming directly from the fridge.
The machine seems to be leaking.	The machine uses water to rinse the internal circuit and brew group. Some water flows through the internal system directly into the drip tray.	Empty the drip tray when the 'drip tray full' indicator pops up through the drip tray cover. Place the espresso stand under the dispensing spout to collect rinsing water.
	The drip tray is too full and has overflowed which makes it look like the machine is leaking.	Empty the drip tray when the 'drip tray full' indicator pops up through the drip tray cover. Place the espresso stand under the dispensing spout to collect rinsing water.
	The machine is not placed on a horizontal surface.	Place the machine on a horizontal surface so that the 'drip tray full' indicator works properly.
I cannot activate the AquaClean filter and the machine asks for descaling.	The filter has not been replaced in time after the AquaClean filter icon flashed and the capacity dropped to 0%.	Descal your machine first and then install the AquaClean filter.
	You did not install the AquaClean filter during first installation, but after having brewed approx. 25 coffees (based on 100ml cups). The machine has to be completely limescale-free before you install the AquaClean filter.	First descale the machine and then install a new AquaClean filter. After descaling, the filter counter is reset to 0/8. Always confirm filter activation in the machine menu. Also do this after filter replacement.
The new water filter does not fit.	You are trying to install another filter than the AquaClean filter.	Only the AquaClean filter fits into the machine.
The machine is making a noise.	It is normal that your machine makes noise during use.	If the machine starts to make a different kind of noise, clean the brew group and lubricate it (see 'Lubricating the brew group').

Technical specifications

The manufacturer reserves the right to improve the technical specifications of the product. All the preset quantities are approximate.

Description	Value
Housing material	Thermoplastic
Size (w x h x d)	221 x 340 x 430 mm
Weight	7.6 kg
Power cord length	800 - 1200 mm
Control panel	Front
Cup size	up to 152 mm
Water tank	1.8 litres, removable
Coffee bean hopper capacity	250 g
Coffee grounds drawer capacity	15 pucks
Milk carafe capacity	500 ml
Pump pressure	15 bar
Boiler	stainless steel boiler
Safety devices	thermal fuse
Energy saving mode	< 1 Wh
Nominal voltage - Power rating - Power supply	See data on inside of maintenance door



www.philips.com/coffee-care



421945003991



>75% recycled paper