



**2-Port 4K HDMI / VGA to HDMI Converter Switch
VC1280 User Manual**



www.aten.com

EMC Information

FEDERAL COMMUNICATIONS COMMISSION INTERFERENCE

STATEMENT: This equipment has been tested and found to comply with the limits for a Class A digital device, pursuant to Part 15 of the FCC Rules. These limits are designed to provide reasonable protection against harmful interference when the equipment is operated in a commercial environment.

This equipment generates, uses, and can radiate radio frequency energy and, if not installed and used in accordance with the instruction manual, may cause harmful interference to radio communications. Operation of this equipment in a residential area is likely to cause harmful interference in which case the user will be required to correct the interference at his own expense.

FCC Caution: Any changes or modifications not expressly approved by the party responsible for compliance could void the user's authority to operate this equipment.

CE Warning: Operation of this equipment in a residential environment could cause radio interference.

This device complies with Part 15 of the FCC Rules. Operation is subject to the following two conditions:

- (1) this device may not cause harmful interference, and
- (2) this device must accept any interference received, including interference that may cause undesired operation.

KCC Statement

유선 제품용 / A 급 기기 (업무용 방송 통신 기기)
이 기기는 업무용 (A 급) 전자파적합기기로서 판매자 또는 사용자는 이 점을 주의하시기 바라며, 가정 외의 지역에서 사용하는 것을 목적으로 합니다.

RoHS

This product is RoHS compliant.



User Information

Online Registration

Be sure to register your product at our online support center:

International	http://eservice.aten.com
---------------	---

Telephone Support

For telephone support, call this number:

International	886-2-8692-6959
China	86-400-810-0-810
Japan	81-3-5615-5811
Korea	82-2-467-6789
North America	1-888-999-ATEN ext 4988 1-949-428-1111

User Notice

All information, documentation, and specifications contained in this manual are subject to change without prior notification by the manufacturer. The manufacturer makes no representations or warranties, either expressed or implied, with respect to the contents hereof and specifically disclaims any warranties as to merchantability or fitness for any particular purpose. Any of the manufacturer's software described in this manual is sold or licensed *as is*. Should the programs prove defective following their purchase, the buyer (and not the manufacturer, its distributor, or its dealer), assumes the entire cost of all necessary servicing, repair and any incidental or consequential damages resulting from any defect in the software.

The manufacturer of this system is not responsible for any radio and/or TV interference caused by unauthorized modifications to this device. It is the responsibility of the user to correct such interference.

The manufacturer is not responsible for any damage incurred in the operation of this system if the correct operational voltage setting was not selected prior to operation. PLEASE VERIFY THAT THE VOLTAGE SETTING IS CORRECT BEFORE USE.

Package Contents

1 VC1280 2-Port 4K HDMI / VGA to HDMI Converter Switch
1 RS-232 Terminal Block
1 Power Adapter
1 User Instructions

Note: Make sure that all of the components are present and in good order. If anything is missing or was damaged in shipping, contact your dealer.

Table of Contents

EMC Information	ii
RoHS	ii
User Information	iii
Online Registration	iii
Telephone Support	iii
User Notice	iii
Package Contents	iv
About this Manual	vii
Conventions	viii
Product Information	viii

1. Introduction

Overview	1
Features	2
Planning the Installation	3
Requirements	3
Considerations	3
Compatible Products	3
Components	4
Front View	4
Rear View	5
Top View	6

2. Hardware Setup

Mounting the VC1280 Unit	7
Wall Mounting	7
Rack Mounting	7
Connecting the VC1280 Unit	8

3. Operation

Selecting the Input Mode	9
Source Input Operation	9
Source Switch Pushbutton	10
RS-232 Commands	10

4. The Firmware Upgrade Utility

Introduction	11
Downloading the Firmware Upgrade Package	11
Preparation	12
Starting the Upgrade	13
Upgrade Succeeded	16
Upgrade Failed	16
Firmware Upgrade Recovery	17

Appendix

Safety Instructions	19
General	19
Rack Mounting	21
Technical Support	22
International	22
North America	22
Specifications	23
Limited Warranty	25

About this Manual

This user manual is provided to help you get the most from the VC1280 unit. It covers all aspects of installation, configuration, and operation. An overview of the information found in the manual is provided below.

Chapter 1, *Introduction* introduces you to the 2-Port 4K HDMI / VGA to HDMI Converter Switch. Its purpose, features, installation considerations, and panel components are presented and described.

Chapter 2, *Hardware Setup* describes the steps that are necessary to quickly and safely set up your installation.

Chapter 3, *Operation* explains the source input operation using the source switch pushbutton and RS-232 commands and its limitations.

Chapter 4, *The Firmware Upgrade Utility* explains the source input operation using the source switch pushbutton and RS-232 commands and its limitations.

An Appendix, provides a list of safety instructions and precautions, contact information for ATEN technical support, product specifications, and other technical information.

Note:

- ◆ Read this manual thoroughly and follow the installation and operation procedures carefully to prevent any damage to the unit or any connected devices.
 - ◆ ATEN regularly updates its product documentation for new features and fixes. For an up-to-date VC1280 documentation, visit <http://www.aten.com/global/en/>
-

Conventions

This manual uses the following conventions:

- `Monospaced` Indicates text that you should key in.
- [] Indicates keys you should press. For example, [Enter] means to press the **Enter** key. If keys need to be chorded, they appear together in the same bracket with a plus sign between them: [Ctrl+Alt].
1. Numbered lists represent procedures with sequential steps.
- ◆ Bullet lists provide information, but do not involve sequential steps.
- Indicates selecting the option (on a menu or dialog box, for example), that comes next. For example, Start → Run means to open the *Start* menu, and then select *Run*.
-  Indicates critical information.

Product Information

For information about all ATEN products and how they can help you connect without limits, visit ATEN on the Web or contact an ATEN Authorized Reseller. Visit ATEN on the Web for a list of locations and telephone numbers:

International	http://www.aten.com
North America	http://www.aten-usa.com

Chapter 1

Introduction

Overview

The ATEN VC1280 is a user-friendly device that simply connects HDMI and VGA sources to one HDMI display or projector. Apart from being compliant with HDCP 1.4, the VC1280 also supports HDMI 1.4 including 3D, Deep Color and 4K (3840 X 2160@30 Hz). In addition, the VC1280 features built-in VGA conversion, which allows you to transmit VGA signals to HDMI output without using extra adapters or scalers.

The VC1280 offers three source switching modes – HDMI, VGA, and AUTO, it allows you to switch rapidly and intuitively via a pushbutton for real-time use. When the VC1280 operates on the AUTO input mode, it transmits the first detected input to the HDMI display, and automatically switches to a newly plugged-in source when it detects the signals.

Without any software or driver installation required, the VC1280 is a handy and easy-to-use multi-input A/V switch. It is deal for user that needs automatic and quick switching to adopt. With the VC1280, you can effortlessly accelerate instant collaboration and work efficiency with co-workers.

Features

- ◆ Connects two sources (HDMI/VGA) to one HDMI display
- ◆ Converts VGA signals to HDMI output
- ◆ Easily switches sources among 3 modes (HDMI/VGA/AUTO) via a pushbutton
- ◆ HDMI 1.4 (3D, Deep Color, 4K); HDCP 1.4 compatible
- ◆ Superior video quality – up to 4K (3840 x 2160 @ 30Hz)
- ◆ RS-232 Channel Transmission – allows you to connect to serial terminals or serial devices for firmware upgrade
- ◆ Supports Auto Switch – the VC1280 automatically switches to a newly plugged-in source
- ◆ Supports Consumer Electronic Control (CEC)
- ◆ Plug-and-play; no software or driver installation required
- ◆ Quality and durable metal enclosure

Planning the Installation

Requirements

Prepare the following before installing the VC1280 unit:

- ♦ 1 HDMI and/or VGA source device
- ♦ 1 HDMI Cable
- ♦ 1 HDMI display device

Considerations

- ♦ The maximum transmission distance varies at different parts of the transmission:

Connection	Interface	Distance
Computer to the VC1280	VGA	1.8 m
	HDMI	3 m
VC1280 to the display	HDMI	3 m

Compatible Products

The VC1280 is compatible with a wide range of ATEN video splitters, video switches, and video extender transmitters. Visit our official web site for more details.

Components

Front View

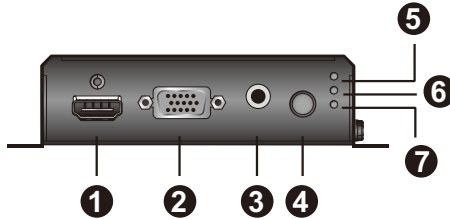

No.	Component	Description
1	HDMI In Port	Connects to the HDMI Out port on the source device.
2	VGA In Port	Connects to the VGA Out port on the source device.
3	Audio In Port	Connects to the Audio Out port on the source device.
4	Source Switch Pushbutton	Press to switch among the Auto Switch, HDMI, and VGA input mode. The input mode status is indicated by the three LEDs to the right of this pushbutton. For details, see <i>Top View</i> , page 6.
5	Auto LED	When LED lights orange, it means the VC1280 is in Auto mode. For more details, see <i>Source Input Operation</i> , page 9.
6	HDMI LED	When LED lights orange, it means the VC1280 is in HDMI mode. For more details, see <i>Source Input Operation</i> , page 9.
7	VGA LED	When LED lights orange, it means the VC1280 is in VGA mode. For more details, see <i>Source Input Operation</i> , page 9.

Rear View

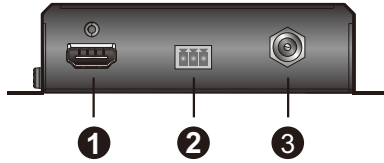

No.	Component	Description
1	HDMI Out Port	Connects to the HDMI In port on the display device.
2	RS-232 Port	Connects to an RS-232 main controller, such as a PC or Control system.
3	Power Jack	Connects to the Power Adapter.

Top View

You can find the unit's LEDs on the top and front panel as illustrated below. See the table below for details on LED indication.

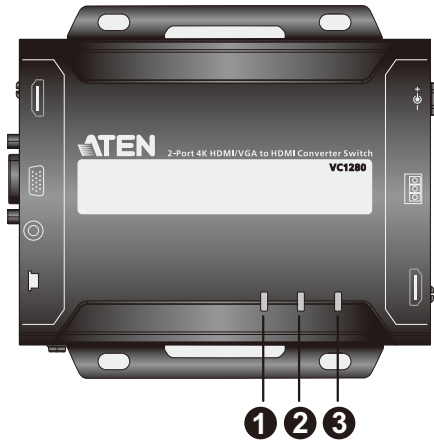

No.	LED	Indication	Description
1	VGA Input Status LED	Lights green	The VGA signal is stable.
2	HDMI Input Status LED	Lights green	The HDMI signal is stable.
3	Power LED	Lights green	The unit is receiving power.

Note:

- ◆ The Power and Link LED blink at the same time to indicate that the firmware upgrade is in progress.

Chapter 2

Hardware Setup



1. Please review the safety information regarding the placement of this device in *Safety Instructions*, page 19.
2. Do not power on the VC1280 until all the necessary hardware is connected.

Mounting the VC1280 Unit

You can mount the VC1280 to the wall or on a rack.

Wall Mounting

Secure or hang the VC1280 unit to the wall using the built-in mounting brackets.

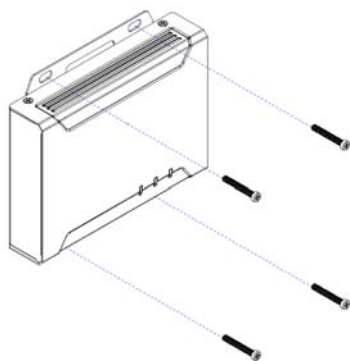

Rack Mounting

Use the VE-RMK 1U Rack Mount Kit to rack-mount the VC1280. For more information about this accessory, go to www.aten.com/products

Connecting the VC1280 Unit

Follow the steps below to connect the VC1280 to a source, and other controls as required.

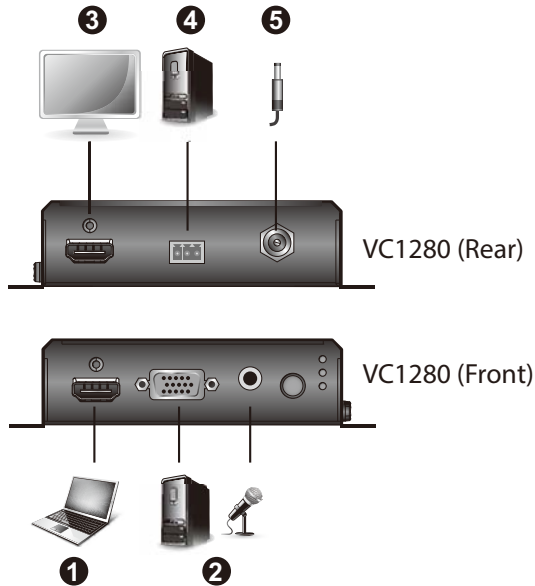

1. Connect the HDMI In Port on the VC1280 to the HDMI Out Port on your video source device using an HDMI cable.
2. Connect the VGA In Port on the VC1280 to the VGA Out Port on your video source device using a VGA cable. To transmit audio, connect the Audio In Port on your VC1280 to the Audio Jack from your video source.
3. Connect the HDMI Out Port on the VC1280 to the HDMI In Port on your HDMI display/projector using an HDMI cable.
4. (Optional) For RS-232 serial transmission and source switch control via RS-232 commands, connect your computer or control system to the terminal block on the VC1280.
5. Plug the power adapter cable into the Power Jack on the VC1280.

Chapter 3

Operation

Selecting the Input Mode

Source Input Operation

Press the Source Switch Pushbutton on the VC1280 to switch between different input modes - Auto, HDMI, and VGA mode. Refer to the table below for details.

Input Mode	Description
Auto (Default)	<p>The VC1280:</p> <ul style="list-style-type: none">◆ Prioritizes HDMI transmission if both HDMI In and VGA In ports are plugged in at the same time.◆ Automatically switches to a newly detected input to the connected receiver.◆ Automatically switches to the remaining port when one of the HDMI / VGA In ports is unplugged. <p>Note: You can disable this part of the Auto Switch mode (automatic input switching) using an RS-232 command. For more details, see <i>RS-232 Commands</i>, page 10.</p>
HDMI (LED lights orange)	The VC1280 only transmits HDMI source to the connected receiver.
VGA (LED lights orange)	The VC1280 only transmits VGA source and its audio input to the connected receiver.

Source Switch Pushbutton

Press the **Source Switch Pushbutton** located on the front panel to switch among the Auto Switch, HDMI, and VGA input mode.

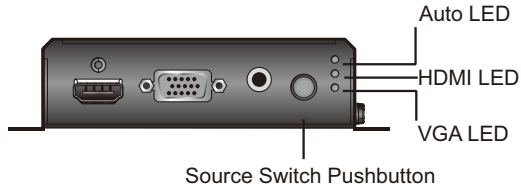

RS-232 Commands

You can change the input mode using RS-232 commands. Refer to the table below for a list of available tasks and the corresponding commands.

Type the corresponding command to execute a task. For example, to enable automatic switching, type **swmode next** and then press **[Enter]**.

Task	Command		
	Control	Input	Port
Enable automatic input switching	swmode next	N/A	N/A
Disable automatic input switching	swmode off	N/A	N/A
Set the unit to the HDMI mode	sw	i	01
Set the unit to the VGA mode	sw	i	02
View the current input mode settings	read	N/A	N/A

Note:

- ◆ Press **[Enter]** to execute a command.
- ◆ The current input mode setting is also indicated by the Auto Switch, HDMI, and VGA LEDs.

Chapter 4

The Firmware Upgrade Utility

Introduction

The purpose of the Windows-based Firmware Upgrade Utility is to provide an easy process for upgrading the VC1280. The program comes as part of a Firmware Upgrade Package that is specific for each device.

As new firmware versions become available, new firmware upgrade packages are posted on our website. Check the website regularly to find the latest information and packages.

Downloading the Firmware Upgrade Package

To download the firmware upgrade package:

1. On our Website go to: *Download - Firmware* and choose the device model, or from the VC1280 product page under the *Resources* tab, select *Firmware*. A list of available firmware upgrade packages appears.
2. Choose the firmware upgrade package that you wish to install (usually the most recent) and download it to your computer.

Preparation

To prepare for the firmware upgrade, do the following:

1. Use an RS-232 cable to connect a COM port on your computer to the *RS-232 Serial Port* of your VC1280 using the RS-232 Terminal Block provided in the package.

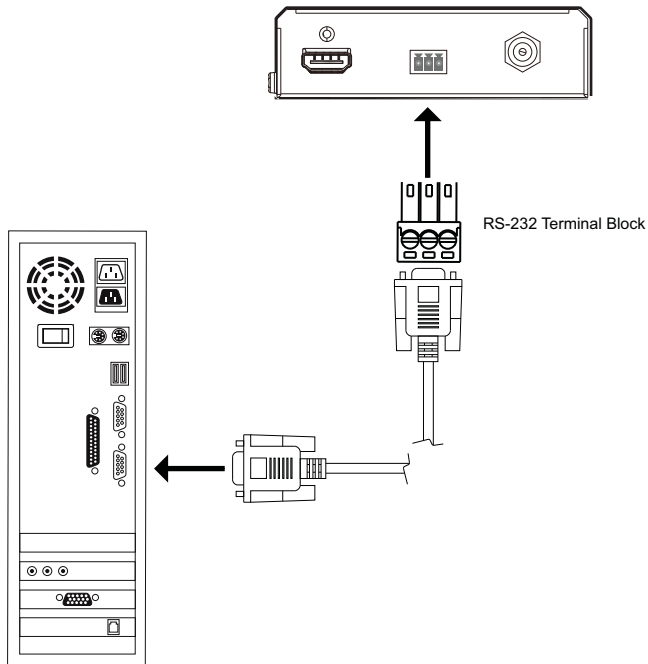

2. Unplug the VC1280's power adapter.
3. Press the Source Switch Pushbutton and plug the power adapter into the VC1280 to power the unit.
4. If successful, the Status LEDs that indicates the VGA, HDMI, and power status will start to flash. Now, you can start the upgrade process as explained on the next page.

Starting the Upgrade

To upgrade the firmware:

1. Run the downloaded firmware upgrade package file either by double-clicking the file icon, or by opening a command line and entering the full path to it.

The *Firmware Upgrade Utility* welcome screen appears:

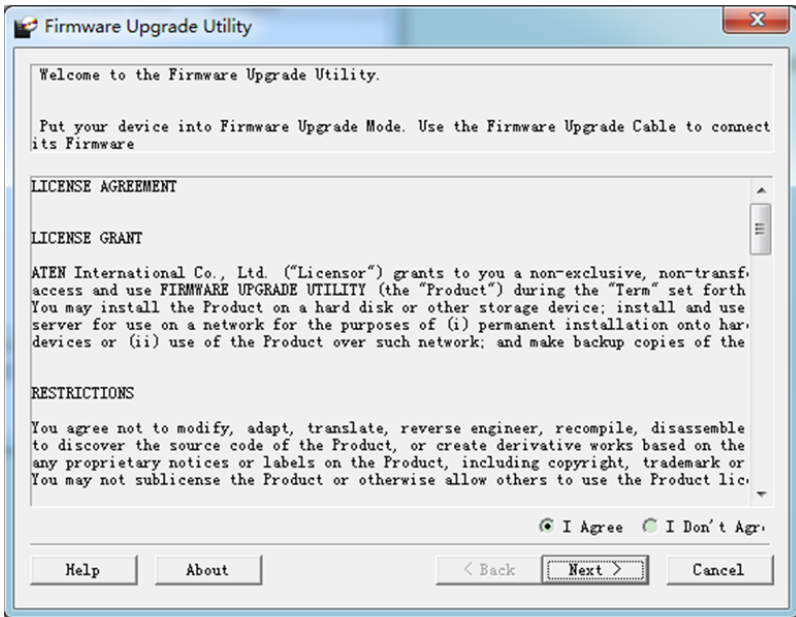

Note: The screens shown in this section are for reference only. The wording and layout of the actual screens put up by the *Firmware Upgrade Utility* may vary slightly from these examples.

2. Read and *Agree* to the License Agreement (click the **I Agree** radio button).
3. Click **Next** to continue. The *Firmware Upgrade Utility* main screen appears. The devices capable of being upgraded are listed in the *Device List* panel:

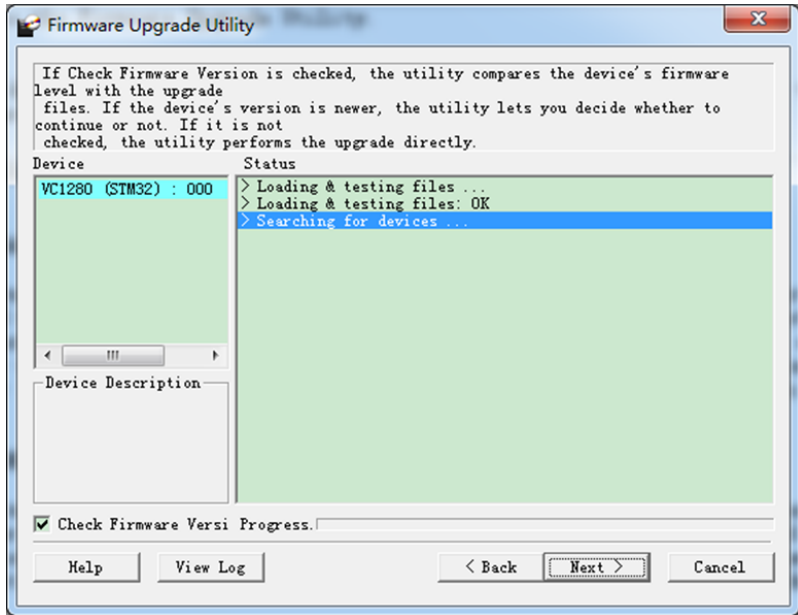

4. Click **Next** to perform the upgrade. The Status LEDs VGA, HDMI, and power will flash while the upgrade is in process.

If you enabled *Check Firmware Version*, the Utility compares the device's firmware level with that of the upgrade files. If it finds that the device's version is higher than the upgrade version, it brings up a dialog box informing you of the situation and gives you the option to continue or cancel.

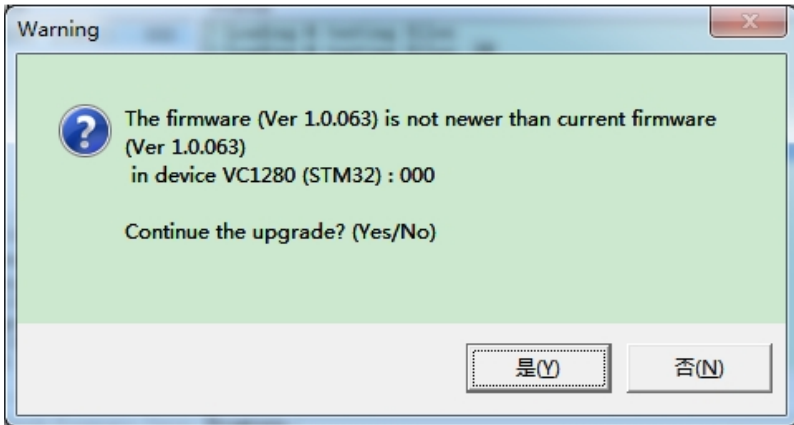

If you didn't enable *Check Firmware Version*, the Utility installs the upgrade files without checking whether they are a higher level, or not.

Status messages appear in the *Status Messages* panel, and the progress toward completion is shown on the *Progress* bar.

Upgrade Succeeded

After the upgrade has completed, all port LEDs will stop flashing and a screen appears to inform you that the procedure was successful:

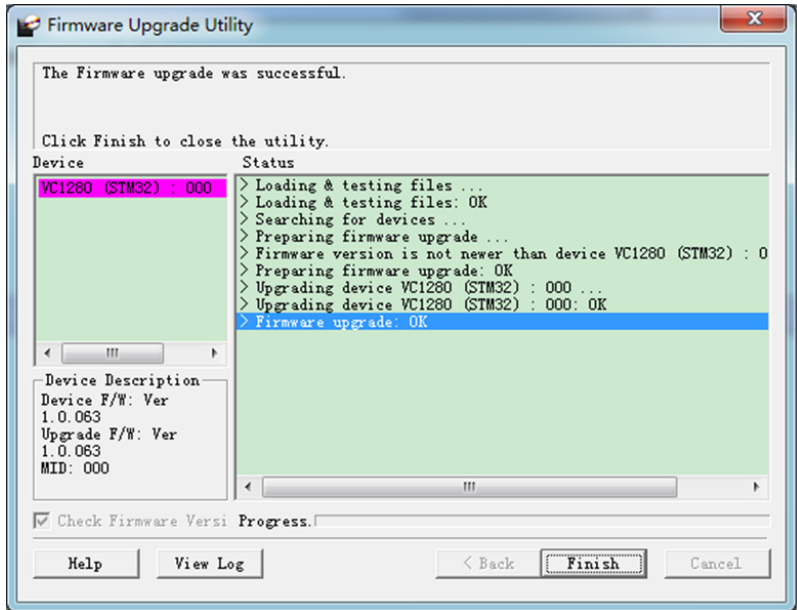

Click **Finish** to close the *Firmware Upgrade Utility*.

Upgrade Failed

If the *Upgrade Succeeded* screen doesn't appear, it means that the upgrade failed to complete successfully. See the next section, *Firmware Upgrade Recovery*, for how to proceed.

Firmware Upgrade Recovery

There are three conditions that call for firmware upgrade recovery:

- ◆ When a firmware upgrade is manually aborted.
- ◆ When the mainboard firmware upgrade fails.
- ◆ When the I/O firmware upgrade fails.

To perform a firmware upgrade recovery, do the following:

1. Power off the device.
2. Connect the RS-232 cable to the *RS-232 Serial Port*.
3. Repeat the upgrade procedure.

This Page Intentionally Left Blank

Safety Instructions

General

- ◆ This product is for indoor use only.
- ◆ Read all of these instructions. Save them for future reference.
- ◆ Follow all warnings and instructions marked on the device.
- ◆ Do not place the device on any unstable surface (cart, stand, table, etc.). If the device falls, serious damage will result.
- ◆ Do not use the device near water.
- ◆ Do not place the device near, or over, radiators or heat registers.
- ◆ The device cabinet is provided with slots and openings to allow for adequate ventilation. To ensure reliable operation, and to protect against overheating, these openings must never be blocked or covered.
- ◆ The device should never be placed on a soft surface (bed, sofa, rug, etc.) as this will block its ventilation openings. Likewise, the device should not be placed in a built in enclosure unless adequate ventilation has been provided.
- ◆ Never spill liquid of any kind on the device.
- ◆ Unplug the device from the wall outlet before cleaning. Do not use liquid or aerosol cleaners. Use a damp cloth for cleaning.
- ◆ The device should be operated from the type of power source indicated on the marking label. If you are not sure of the type of power available, consult your dealer or local power company.
- ◆ The device is designed for IT power distribution systems with 230V phase-to-phase voltage.
- ◆ To prevent damage to your installation it is important that all devices are properly grounded.
- ◆ The device is equipped with a 3-wire grounding type plug. This is a safety feature. If you are unable to insert the plug into the outlet, contact your electrician to replace your obsolete outlet. Do not attempt to defeat the purpose of the grounding-type plug. Always follow your local/national wiring codes.
- ◆ Do not allow anything to rest on the power cord or cables. Route the power cord and cables so that they cannot be stepped on or tripped over.

- ◆ If an extension cord is used with this device make sure that the total of the ampere ratings of all products used on this cord does not exceed the extension cord ampere rating. Make sure that the total of all products plugged into the wall outlet does not exceed 15 amperes.
- ◆ To help protect your system from sudden, transient increases and decreases in electrical power, use a surge suppressor, line conditioner, or uninterruptible power supply (UPS).
- ◆ Position system cables and power cables carefully; Be sure that nothing rests on any cables.
- ◆ Never push objects of any kind into or through cabinet slots. They may touch dangerous voltage points or short out parts resulting in a risk of fire or electrical shock.
- ◆ Do not attempt to service the device yourself. Refer all servicing to qualified service personnel.
- ◆ If the following conditions occur, unplug the device from the wall outlet and bring it to qualified service personnel for repair.
 - ◆ The power cord or plug has become damaged or frayed.
 - ◆ Liquid has been spilled into the device.
 - ◆ The device has been exposed to rain or water.
 - ◆ The device has been dropped, or the cabinet has been damaged.
 - ◆ The device exhibits a distinct change in performance, indicating a need for service.
 - ◆ The device does not operate normally when the operating instructions are followed.
- ◆ Only adjust those controls that are covered in the operating instructions. Improper adjustment of other controls may result in damage that will require extensive work by a qualified technician to repair.

Rack Mounting

- ◆ Before working on the rack, make sure that the stabilizers are secured to the rack, extended to the floor, and that the full weight of the rack rests on the floor. Install front and side stabilizers on a single rack or front stabilizers for joined multiple racks before working on the rack.
- ◆ Always load the rack from the bottom up, and load the heaviest item in the rack first.
- ◆ Make sure that the rack is level and stable before extending a device from the rack.
- ◆ Use caution when pressing the device rail release latches and sliding a device into or out of a rack; the slide rails can pinch your fingers.
- ◆ After a device is inserted into the rack, carefully extend the rail into a locking position, and then slide the device into the rack.
- ◆ Do not overload the AC supply branch circuit that provides power to the rack. The total rack load should not exceed 80 percent of the branch circuit rating.
- ◆ Make sure that all equipment used on the rack – including power strips and other electrical connectors – is properly grounded.
- ◆ Ensure that proper airflow is provided to devices in the rack.
- ◆ Ensure that the operating ambient temperature of the rack environment does not exceed the maximum ambient temperature specified for the equipment by the manufacturer.
- ◆ Do not step on or stand on any device when servicing other devices in a rack.

Technical Support

International

- ◆ For online technical support – including troubleshooting, documentation, and software updates: <http://support.aten.com>
- ◆ For telephone support, see *Telephone Support*, page iii:

North America

Email Support		support@aten-usa.com
Online Technical Support	Troubleshooting Documentation Software Updates	http://www.aten-usa.com/support
Telephone Support		1-888-999-ATEN ext 4988

When you contact us, please have the following information ready beforehand:

- ◆ Product model number, serial number, and date of purchase
- ◆ Your computer configuration, including operating system, revision level, expansion cards, and software
- ◆ Any error messages displayed at the time the error occurred
- ◆ The sequence of operations that led up to the error
- ◆ Any other information you feel may be of help

Specifications

Function	Specifications	
Video Input		
Interfaces	1 x HDMI Type A Female (Black) 1 x VGA HDB-15 Female (Blue)	
Impedance	HDMI: 100 Ω VGA HDB-15: 75 Ω	
Max. Distance	1.8 m - VGA HDB-15 (1920 x 1200) 3 m - HDMI (3840 x 2160 @ 30Hz)	
Video Output		
Max. Data Rate	10.2 Gbps (3.4 Gbps per lane)	
Max. Pixel Clock	340 MHz	
Compliance	HDMI 1.4 (3D, Deep Color, 4K)	
	HDCP 1.4 Compatible	
	Consumer Electronics Control (CEC)	
Max. Resolutions / Distances	Video Input: ♦ 3 m - HDMI (3840 x 2160 @ 30Hz) ♦ 1.8 m - VGA HDB-15 (1920 x 1200) Video Output: ♦ 3 m - HDMI (3840 x 2160 @ 30Hz)	
Audio		
Input	1 x HDMI Type A Female (Black) 1 x 3.5mm Stereo Audio Jack Female (Green)	
Control		
RS-232	Connectors	1 x Terminal Block, 3 Pole
	Baud Rate	19200
	Data Bits	8
	Stop Bits	1, no parity and flow control
Switches		
Video Input Port Selection	1 x Pushbutton - HDMI, VGA, and AUTO	
LEDs		
Status	3 x LED (Front - Source Switching: AUTO / HDMI / VGA) Color: Orange 3 x LED (Top - HDMI / VGA / POWER) Color: Orange - HDMI / VGA Green - POWER	

Function	Specifications
Power	
Connectors	1 x DC Jack (Black) with locking
Consumption	DC 5V:1.8W:8BTU
Environmental	
Operating Temperature	0 - 40°C
Storage Temperature	-20 - 60°C
Humidity	0 x 80% RH, Non-Condensing
Physical Properties	
Housing	Metal
Weight	0.43 Kg (1.04 lb)
Dimensions (L x W x H) with Bracket	14.32 x 12.30 x 3.00 cm (5.64 x 4.84 x 1.18 in.)
Dimensions (L x W x H) without Bracket	13.60 x 10.10 x 2.90 cm (5.35 x 3.98 x 1.14 in.)

Limited Warranty

ATEN warrants its hardware in the country of purchase against flaws in materials and workmanship for a Warranty Period of two [2] years (warranty period may vary in certain regions/countries) commencing on the date of original purchase. This warranty period includes the LCD panel of ATEN LCD KVM switches. Select products are warranted for an additional year (see *A+ Warranty* for further details). Cables and accessories are not covered by the Standard Warranty.

What is covered by the Limited Hardware Warranty

ATEN will provide a repair service, without charge, during the Warranty Period. If a product is defective, ATEN will, at its discretion, have the option to (1) repair said product with new or repaired components, or (2) replace the entire product with an identical product or with a similar product which fulfills the same function as the defective product. Replaced products assume the warranty of the original product for the remaining period or a period of 90 days, whichever is longer. When the products or components are replaced, the replacing articles shall become customer property and the replaced articles shall become the property of ATEN.

To learn more about our warranty policies, please visit our website:

<http://www.aten.com/global/en/legal/policies/warranty-policy>