

SCALE 1/1

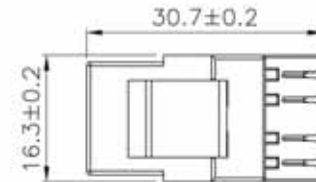
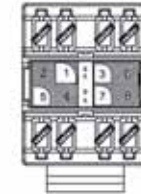
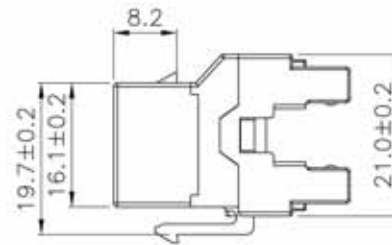
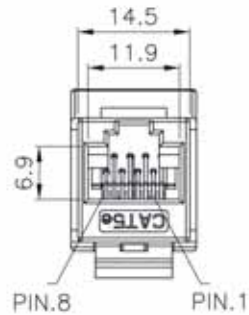

Specification :

Material :

1. RJ45 Jack :
 - 1-1. Housing : ABS+PC, UL 94V-0, with optional color.
 - 1-2. Contact Bracket : PC, UL 94V-2, Transparent color.
2. RJ45 Jack Contact :
 - 2-1. Material : Phosphor Bronze with Nickel plated
 - 2-2. Finish : 50 micro-inch Gold plated on Plug contact area.
3. IDC :
 - 3-1. Housing : PC+Glass Fiber, UL 94V-2
 - 3-2. Terminal : Phosphor Bronze with Tin plated.
4. IDC CAP : ABS, UL 94V-0.
5. PCB : FR4, UL 94V-0.

Performance :

- a. T568A & T568B wiring sticker.
- b. Insertion force : 20N max. (IEC 60603-7-4)
- c. Retention strength : 7.7 kg between Jack and Plug.
- d. Operating temperature : -10°C to 60°C. (ISO/IEC 11801, ANSI/TIA/EIA 568 B.2)
- e. Life(mating cycles) :
 - *Jack : 750 cycles min. (ISO/IEC 11801, IEC 60603-7-4)
 - * IDC : Suitable for 22-26 AWG stranded and solid wire, compatible with both 110 & Krone punch down tools.
- f. The Cat.5e transmission performance is in compliance with the ANSI/TIA/EIA 568 B.2 standard.

TD5012	BLACK
TD5013	WHITE

GENERAL TOLERANCE OF DIMENSIONS X.XXX ±0.005 X.XX ±0.05 X.X ±0.1	DRAWING	22.JUN.2010	QIQI	ACE
	CHECK	22.JUN.2010	JANE	
	APPROVAL	22.JUN.2010	JAIMY	
		DATE	NAME	
SCALE	1/1 (A4)	UNIT	mm	DES.: CAT.5E UNSHIELDED KEYSTONE JACK
DRAWING NO.		DRAWING CLASSIFICATION		
S		SHEET	1 OF 1	A7

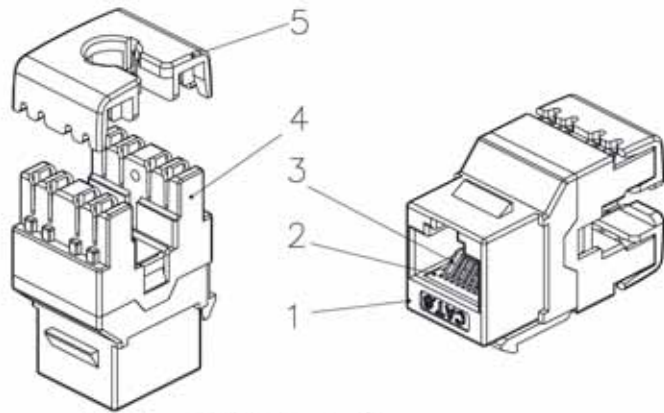

SCALE 1/1

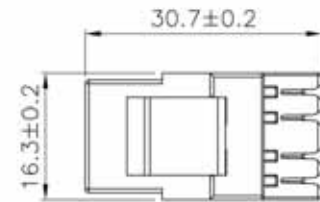
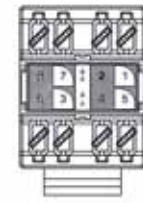
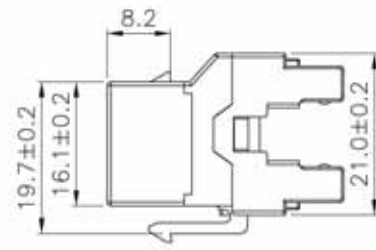
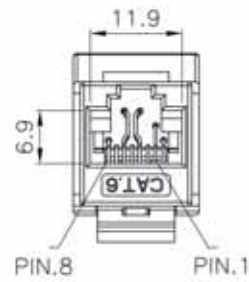

Specification :

Material :

1. RJ45 Jack Housing : ABS+PC, UL 94V-0, with optional color.
2. Contact Bracket : PC, UL 94V-2, Transparent color.
3. RJ45 Jack Contact :
 - 3-1. Material : Phosphor Bronze with Nickel plated
 - 3-2. Finish : 50 micro-inch Gold plated on Plug contact area.
4. IDC :
 - 4-1. Housing : PC+Glass Fiber, UL 94V-2
 - 4-2. Terminal : Phosphor Bronze with Tin plated.
5. IDC CAP : ABS, UL 94V-0.
6. PCB : FR4, UL 94V-0.

Performance :

- a. T568A & T568B wiring sticker.
- b. Insertion force : 20N max. (IEC 60603-7-4)
- c. Retention strength : 7.7 kg between Jack and Plug.
- d. Operating temperature : -10°C to 60°C. (ISO/IEC 11801, ANSI/TIA/EIA 568 B.2)
- e. Life(mating cycles) :
 - *Jack : 750 cycles min. (ISO/IEC 11801, IEC 60603-7-4)
 - *IDC : Suitable for 22-26 AWG stranded and solid wire, compatible with both 110 & Krone punch down tools.
- f. The Cat.6 transmission performance is in compliance with the ANSI/TIA/EIA 568 B.2-1 standard.

TD6012	BLACK
TD6013	WHITE

GENERAL TOLERANCE OF DIMENSIONS X.XXX ±0.005 X.XX ±0.05 X.X ±0.1	DRAWING	12.MAY.2011	QIQI	ACE
	CHECK	12.MAY.2011	JANE	
	APPROVAL	12.MAY.2011	JAIMY	
	DATE		NAME	
SCALE	1/1 (A4)	UNIT	mm	DES.: CAT.6 UNSHIELDED KEYSTONE JACK
DRAWING NO.		DRAWING CLASSIFICATION		
DRAWING CLASSIFICATION		S	SHEET	1 OF 1

