

SC-T5100M Series
SC-T3100M Series
SC-T5100 Series
SC-T3100 Series
SC-T5100N Series
SC-T3100N Series
SC-T2100 Series

User's Guide

Copyrights and Trademarks

Copyrights and Trademarks

No part of this publication may be reproduced, stored in a retrieval system, or transmitted in any form or by any means, electronic, mechanical, photocopying, recording, or otherwise, without the prior written permission of Seiko Epson Corporation. The information contained herein is designed only for use with this Epson printer. Epson is not responsible for any use of this information as applied to other printers.

Neither Seiko Epson Corporation nor its affiliates shall be liable to the purchaser of this product or third parties for damages, losses, costs, or expenses incurred by the purchaser or third parties as a result of accident, misuse, or abuse of this product or unauthorized modifications, repairs, or alterations to this product, or (excluding the U.S.) failure to strictly comply with Seiko Epson Corporation's operating and maintenance instructions.

Seiko Epson Corporation shall not be liable for any damages or problems arising from the use of any options or any consumable products other than those designated as Original Epson Products or Epson Approved Products by Seiko Epson Corporation.

Seiko Epson Corporation shall not be held liable for any damage resulting from electromagnetic interference that occurs from the use of any interface cables other than those designated as Epson Approved Products by Seiko Epson Corporation.

EPSON, EPSON EXCEED YOUR VISION, EXCEED YOUR VISION, and their logos are registered trademarks or trademarks of Seiko Epson Corporation.

Microsoft®, Windows®, and Windows Vista® are registered trademarks of Microsoft Corporation.

Apple, Mac, macOS, OS X, Bonjour, Safari, AirPrint, iPad, iPhone, iPod touch, iBeacon, iTunes and ColorSync are trademarks of Apple Inc., registered in the U.S. and other countries.

Use of the Works with Apple badge means that an accessory has been designed to work specifically with the technology identified in the badge and has been certified by the developer to meet Apple performance standards.

Chrome™, Chrome OS™, and Android™ are trademarks of Google Inc.

Intel® is a registered trademark of Intel Corporation.

Adobe and Reader are either registered trademarks or trademarks of Adobe in the United States and/or other countries.

HP-GL/2® and HP RTL® are registered trademarks of Hewlett-Packard Corporation.

General Notice: Other product names used herein are for identification purposes only and may be trademarks of their respective owners. Epson disclaims any and all rights in those marks.

© 2021 Seiko Epson Corporation.

Contents

Contents

Copyrights and Trademarks

Introduction

Notes on Manuals.	6
Meaning of Symbols.	6
Illustrations.	6
Product Model Descriptions.	6
Manual Organization.	6
Viewing PDF Manuals.	6
Printer Parts.	8
Front.	8
Scanner Section (SC-T5100M Series/SC-T3100M Series Only).	10
Inside.	11
Back.	12
Control panel.	14
Understanding and Operating the Screen.	14
Home screen.	14
Using your Presets.	16
Features of Printer.	18
Realizing High Resolution.	18
Insistence on Ease-of-Use.	18
Notes on Usage and Storage.	19
Installation space.	19
Notes when using the printer.	19
Notes when not using the printer.	20
Notes on handling ink cartridges.	20
Notes on handling paper.	21
Saving Power.	22

Introducing the Software

Provided Software.	24
Built-in Software in the Printer.	25
How to Use Web Config.	26
How to Start.	26
Closing.	26
Function Summary.	26
Updating Software or Installing Additional Software.	27
Checking Whether Updates Available and Updating Software.	27
Receiving Update Notifications.	27
Uninstalling Software.	28
Windows.	28
Mac.	28

Loading and Setting the Paper

Notes on Loading the Paper.	29
Paper Load Position.	29
Loading and Removing the Roll Paper.	30
Loading Roll Paper.	30
Cutting the Roll Paper.	32
Removing Roll Paper.	34
Loading and Removing Paper from the Auto Sheet Feeder.	36
Installing and removing the paper stacker (for plain paper).	36
Loading paper into the auto sheet feeder.	36
Removing paper from the auto sheet feeder.	38
Loading and Removing Cut Sheet(1 sheet).	40
Loading Cut Sheet(1 sheet).	40
Removing Cut Sheet (1 Sheet).	41
Setting Loaded Paper.	42
For Roll Paper.	42
For Auto Sheet Feeder/Cut Sheet(1 sheet).	44
Optimizing Paper Settings (Media Adjust).	46
Notes on Making Adjustments.	46
Adjusting.	46

Printing with the Printer Driver from Your Computer

Basic Operating Procedures (Windows).	49
Printing Procedure.	49
Canceling Printing.	51
Customizing the Printer Driver.	52
Basic Operating Procedures (Mac).	55
Printing Procedure.	55
Canceling Printing.	58
Customizing the Printer Driver.	58
Printing CAD Drawings.	60
Enlargements and Horizontal and Vertical Banners.	62
Fitting Documents to the Width of the Roll Paper.	62
Fitting Documents to the Output Size.	64
Choosing a Print Size.	65
Printing at Non-Standard Sizes.	67
Correct color and print.	71
Color Management Printing.	75
About Color Management.	75

Contents

Color Management Print Settings.	75
Setting color management with the applications.	76
Setting color management with the printer driver.	78
Multi-Page Printing (N-up).	82
Manual Double Sided Printing (Windows Only)	83
Notes on double-sided printing.	83
Setting Procedures for Printing.	83
Folded 2-Sided Printing (Windows only).	85
Poster Printing (Windows Only).	86
Printing Multiple Documents (Layout Manager) (Windows Only).	91
Setting Procedures for Printing.	91
Saving and Recalling Settings.	92

Printing Using the HP-GL/2 or HP RTL Mode from a Computer

Printer Settings.	94
Basic Print Settings.	94
HP-GL/2 Specific Print Settings.	94
CAD Application Settings.	95

Changing the Network Connection Methods

Switching to Wired LAN.	96
Switching to Wireless LAN.	96
Directly Connecting Wirelessly (Wi-Fi Direct).	97

Using AirPrint

Printing without Using the Printer Driver(SC-T5100M Series/SC-T3100M Series only)

Printing Directly Over the Web (Upload and Print).	99
Function Summary.	99
Upload and Print Procedure.	99
Printing Files from a Shared Folder (Print from Folder).	100
Function Summary.	100
Preparing a Shared Folder.	100
Print from Folder Procedure.	101
Printing Files on USB Flash Memory Directly.	101

Copy (SC-T5100M Series/SC-T3100M Series only)

Placing Documents in the Scanner.	103
Loadable Document Sizes.	103
Loadable Paper Types.	103
Documents That Cannot Be Loaded.	103
When loading documents that are thin, that are easily torn, or that you do not want to damage.	104
How to Load Documents.	105
Procedure for Copying.	105

Scan (SC-T5100M Series/SC-T3100M Series only)

Function Summary.	107
Preparing to Scan.	107
Procedure for Scanning.	108
Scanning and Saving an Image to a Shared Folder or FTP Server.	108
Scanning and Attaching an Image to an Email	109
Scanning and Saving an Image to a Memory Device.	110

Making Enlarged Copies with an A3 or A4 Scanner (Except for the SC-T5100M Series/SC-T3100M Series)

Connecting the Scanner.	111
Making Enlarged Copies.	112
Placing Documents in the Scanner.	113

Using the Menu

Menu List.	114
Paper Setting menu.	132
Roll Paper menu.	132
Auto Sheet Feeder menu.	135
Cut Sheet(1 sheet) menu.	136
Printer Status menu.	137
Settings menu.	138
General Settings.	138
Maintenance.	159
Printer Status/Print.	160
Enlarged Copy menu (except for the SC-T5100M Series/SC-T3100M Series).	161
Memory Device menu (SC-T5100M Series/SC-T3100M Series only).	163

Contents

Copy Menu (SC-T5100M Series/SC-T3100M Series Only)	166
Scan Menu (SC-T5100M Series/SC-T3100M Series Only).	169
Network Folder Menu (SC-T5100M Series/SC-T3100M Series Only).	178

Maintenance

Clearing a Clogged Print Head.	180
Checking the print head for clogging and then cleaning.	180
Powerful Cleaning.	180
Replacing Consumables.	181
Handling of Used Consumables.	181
Replacing Ink Cartridges.	181
Replacing Maintenance Box.	183
Replacing the Cutter.	184

Problem Solver

What to do When a Message is Displayed.	187
When a Maintenance Call/Printer Error Occurs	188
Troubleshooting.	189
You cannot print (because the printer does not work).	189
The printer operates, but nothing prints.	191
The prints are not what you expected.	192
Feeding or ejecting problems.	196
Others.	199
Copying or Scanning Problems (SC-T5100M Series/SC-T3100M Series Only).	200

Appendix

Options and Consumable Products.	206
Epson Special Media.	206
Ink Cartridges.	206
Others.	207
Supported Media.	209
Epson Special Media Table.	209
Supported Commercially Available Paper.	212
Printable area.	215
Roll Paper.	215
Cut sheets (Auto sheet feeder).	216
Cut Sheet (1 sheet).	216
Moving or Transporting the Printer.	217
Moving to a Different Location in the Same Building.	217
When Transporting.	218

Handling if Transporting/Leaving the Printer in an Environment of -10°C or Less.	218
System Requirements.	220
Printer Driver.	220
Web Config.	221
Specifications Table.	222

Where To Get Help





Technical Support Web Site.	226
Contacting Epson Support.	226
Before Contacting Epson.	226
Help for Users in North America.	227
Help for Users in Europe.	227
Help for Users in Taiwan.	227
Help for Users in Australia/New Zealand.	228
Help for Users in Singapore.	228
Help for Users in Thailand.	229
Help for Users in Vietnam.	229
Help for Users in Indonesia.	229
Help for Users in Hong Kong.	230
Help for Users in Malaysia.	230
Help for Users in India.	230
Help for Users in the Philippines.	231

Introduction

Introduction

Notes on Manuals

Meaning of Symbols

 Warning:	Warnings must be followed to avoid serious bodily injury.
 Caution:	Cautions must be followed to avoid bodily injury.
 Important:	Important must be followed to avoid damage to this product.
Note:	Notes contain useful or additional information on the operation of this product.
	Indicates related reference content.

Illustrations

Unless otherwise specified, the illustrations in the manuals are for the SC-T3000 Series.

The illustrations in the manuals may differ slightly from the model you are using. Please be aware of this when using the manuals.

Product Model Descriptions

Some models described in this manual may not be sold in your country or region.

Manual Organization

The manuals for the product are organized as shown below.

You can view the PDF manuals using Adobe Acrobat Reader or Preview (Mac).

Setup Guide (booklet)	Provides information on how to setup the printer after unpacking it from the box. Make sure you read this manual to perform operations safely.
Operator's Guide (booklet or PDF)	Provides selected information on how to use the printer and frequently used features of the printer.
General Information (PDF)	Provides important safety instructions, printer specifications and contact details.
Online Manuals	
User's Guide (this manual)	Provides overall information and instructions on using the printer and on solving problems.
Administrator's Guide (PDF)	Provides network administrators with information on management and printer settings.

Viewing PDF Manuals

This section uses the Adobe Acrobat Reader DC as an example to explain the basic operations for viewing the PDF in Adobe Acrobat Reader.

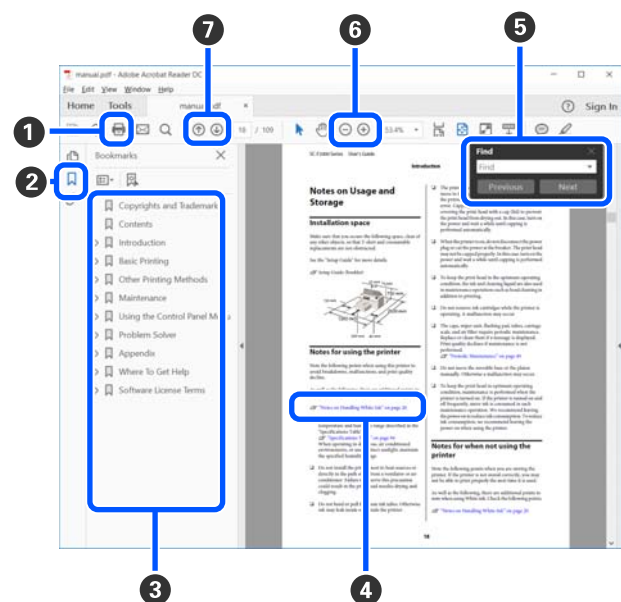

Introduction

- 1 Click to print the PDF manual.
- 2 Each time it is clicked the bookmarks are hidden or shown.
- 3 Click the title to open the relevant page.

Click [+] to open the titles lower in the hierarchy.

- 4 If the reference is in blue text, click the blue text to open the relevant page.

To return to the original page, do the following.

For Windows

While pressing the Alt key, press the ← key.

For Mac

While pressing the command key, press the ← key.

- 5 You can input and search for keywords, such as the names of items you want to confirm.

For Windows

Right click on a page in the PDF manual and select **Find** in the menu that is displayed to open the search toolbar.

For Mac

Select **Find** in the **Edit** menu to open the search toolbar.

- 6 To enlarge text in the display that is too small to see clearly, click ⊕. Click ⊖ to reduce the size. To specify a part of an illustration or screenshot to enlarge, do the following.

For Windows

Right click on the page in the PDF manual and select **Marquee Zoom** in the menu that is displayed. The pointer changes to a magnifying glass, use it to specify the range of the place you want to enlarge.

For Mac

Click **View** menu - **Zoom** - **Marquee Zoom** in this order to change the pointer to a magnifying glass. Use the pointer as a magnifying glass to specify the range of the place you want to enlarge.

- 7 Opens the previous page or next page.

Introduction

Printer Parts

Front

The following illustration provides an explanation of the SC-T3100 Series (model with 24 inch stand).

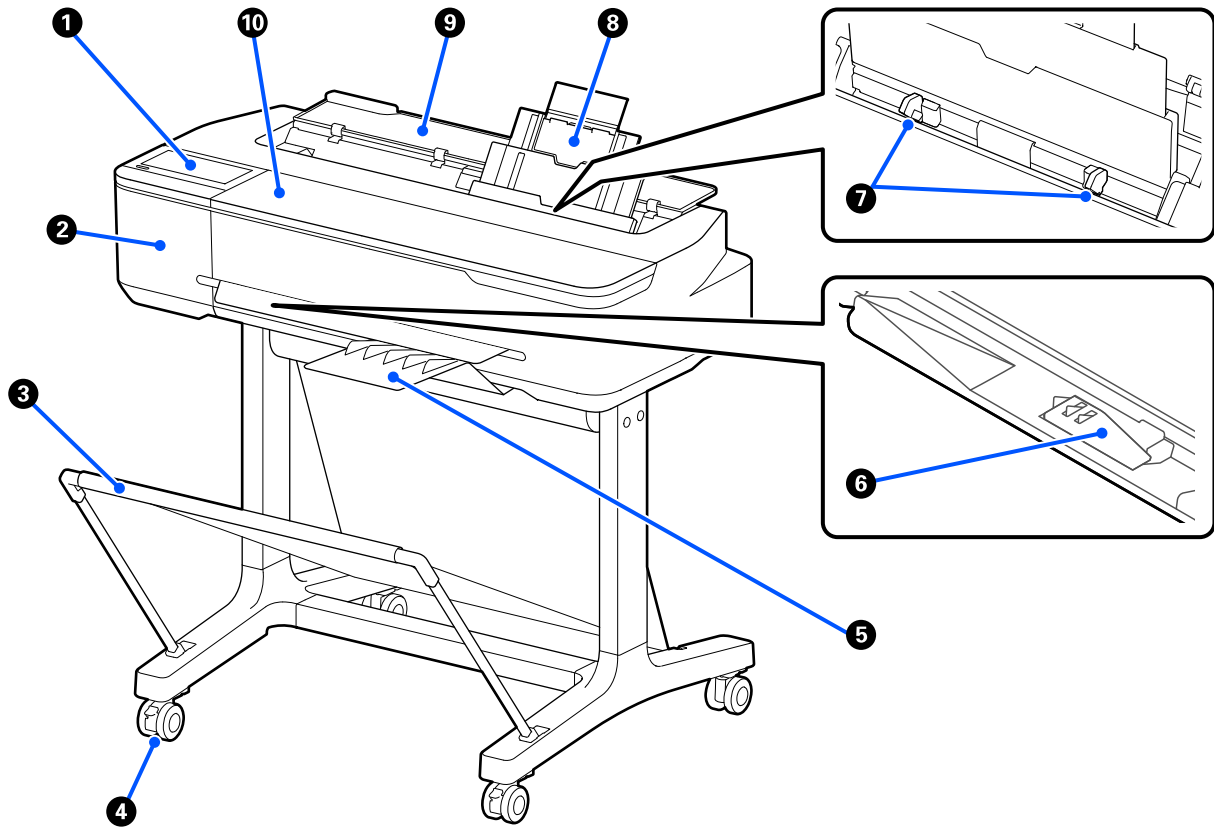

1 Control panel

 [“Control panel” on page 14](#)

2 Cutter cover

Open when replacing the cutter.

 [“Replacing the Cutter” on page 184](#)

3 Paper basket

Output from the printer collects in this basket, keeping the media clean and free of creases.

A dedicated stand that comes with a paper basket is provided as an option for SC-T5100N Series/SC-T3100M Series/SC-T3100N Series/SC-T2100 Series.

 [“Options and Consumable Products” on page 206](#)

Introduction

4 Casters

There are two casters on each leg. The casters are normally kept locked once the printer is in place.

5 Paper stacker (for plain paper)

Attach to the front of the printer as shown when printing multiple sheets of plain paper continuously from the auto sheet feeder. Printed paper stacks up in this tray after it is ejected. Remove this when printing on roll paper or cut sheets (1 sheet).

The paper stacker is not included with the SC-T2100 Series. It is available as an optional extra.

 [“Installing and removing the paper stacker \(for plain paper\)” on page 36](#)

6 B1 width paper support (SC-T5100M Series/SC-T5100 Series/SC-T5100N Series only)

For roll paper or cut sheet (1 sheet) equivalent to B1 width (718 to 738 mm) only, raise the B1 width paper support before printing to prevent scuffing and soiling of the print surface

 [“Loading Roll Paper” on page 30](#)

 [“Loading Cut Sheet\(1 sheet\)” on page 40](#)

7 Edge guide

Align these with the left and right edges of the paper loaded in the auto sheet feeder. Prevents paper from being fed at an angle.

8 Auto Sheet Feeder

You can load multiple cut sheets of A4 to A3 paper. The loaded paper is fed automatically allowing you to print continuously.

 [“Loading paper into the auto sheet feeder” on page 36](#)

9 Cut sheet cover

Open when using the auto sheet feeder or when loading cut sheet paper.

 [“Loading Cut Sheet\(1 sheet\)” on page 40](#)

When loading roll paper, open this cover and then open the roll paper cover.

To prevent dust from accumulating inside the printer, close the auto sheet feeder when it is not in use or when you are not loading cut sheet paper.

10 Front cover

Open this cover when replacing ink cartridges or clearing a paper jam.

Introduction

Scanner Section (SC-T5100M Series/SC-T3100M Series Only)

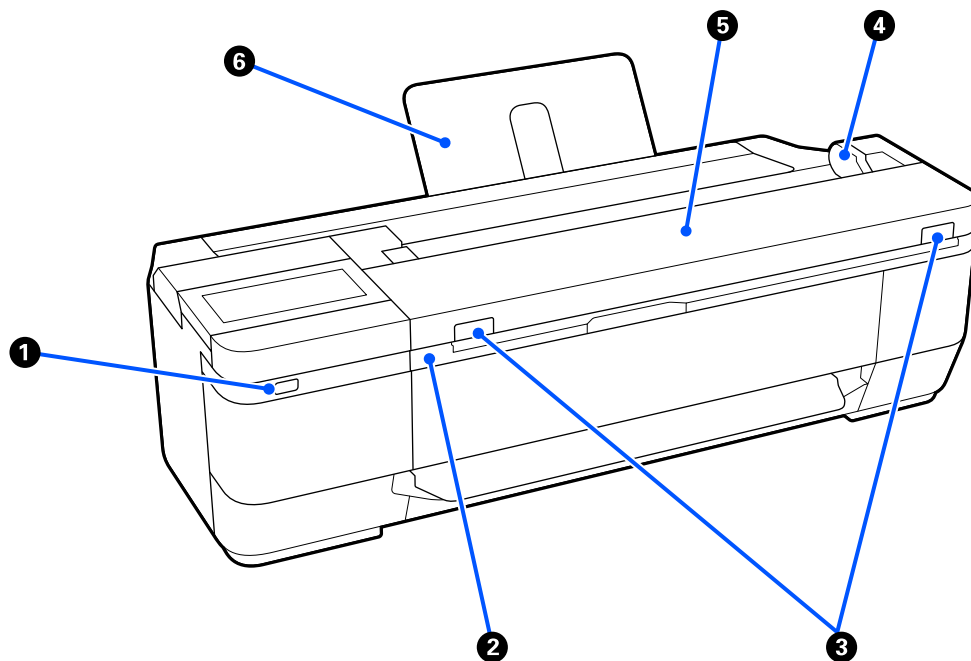

1 USB port (for USB flash drive)

You can connect a USB flash drive to print directly or save your scanned data.

 [“Printing Files on USB Flash Memory Directly” on page 101](#)

 [“Scanning and Saving an Image to a Memory Device” on page 110](#)

2 Scanner unit

Open this cover when replacing ink cartridges or clearing a paper jam.

3 Lock lever

While pressing the left and right lock levers, open the scanner cover.

4 Document guide

This guide allows you to feed originals straight into the printer.

5 Scanner cover

Open this when there is a paper jam, or when you want to clean the scanner.



Important:

Do not press down on the scanner cover or place anything on top of it while scanning. Otherwise, the scan results may be distorted or the original may get jammed.

Introduction

6 Document support

Prevents documents from falling backwards. You can also place long documents that have been rolled up.

 [“How to Load Documents” on page 105](#)

Inside

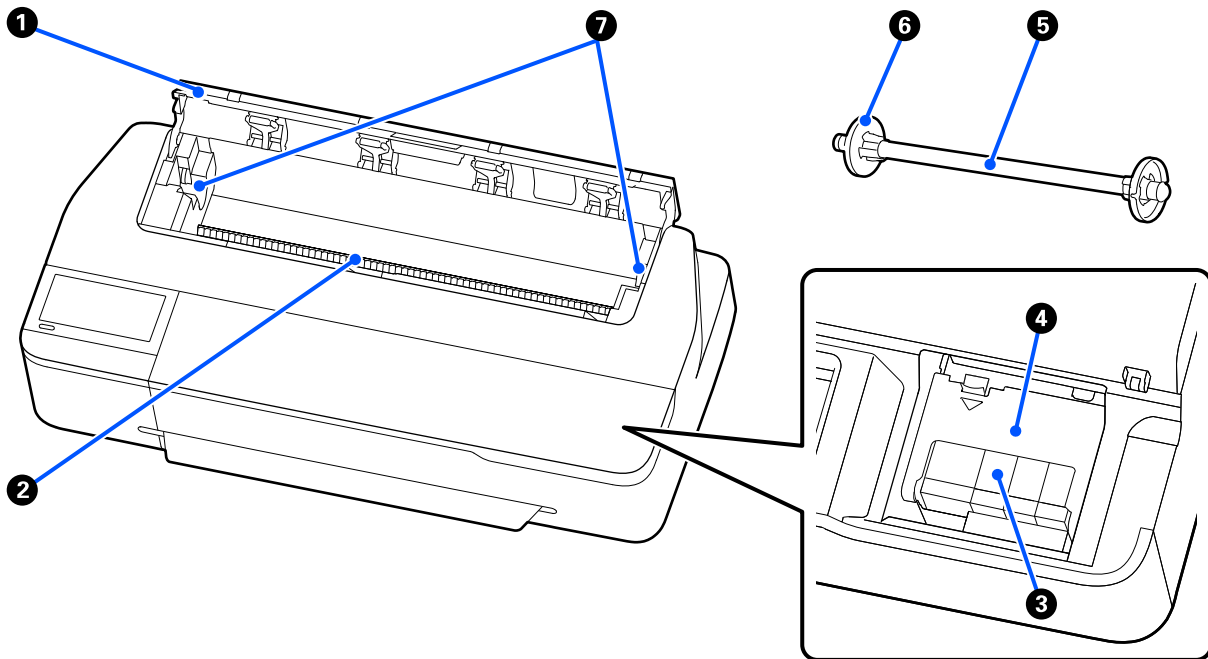

1 Roll paper cover

This cover protects the loaded roll paper and prevents dust from entering inside the printer. Except when loading or removing roll paper, it should be closed when using the printer.

 [“Loading Roll Paper” on page 30](#)

2 Paper slot

The slot through which roll paper or cut sheets are fed during printing. Insert cut sheets manually one by one.

3 Ink Cartridges

Install cartridges into all slots.

 [“Replacing Ink Cartridges” on page 181](#)

4 Cartridge cover

Open when replacing ink cartridges.

5 Spindle

When loading roll paper into the printer, insert this through the roll paper.

Introduction

6 Movable flange (transparent)

This fixes the roll paper placed on the spindle. Attach or detach it when placing or removing roll paper on/from the spindle.

7 Spindle holder

Install the spindle with the roll paper loaded. There is a holder on both the left and right sides.

 [“Loading Roll Paper” on page 30](#)

Back

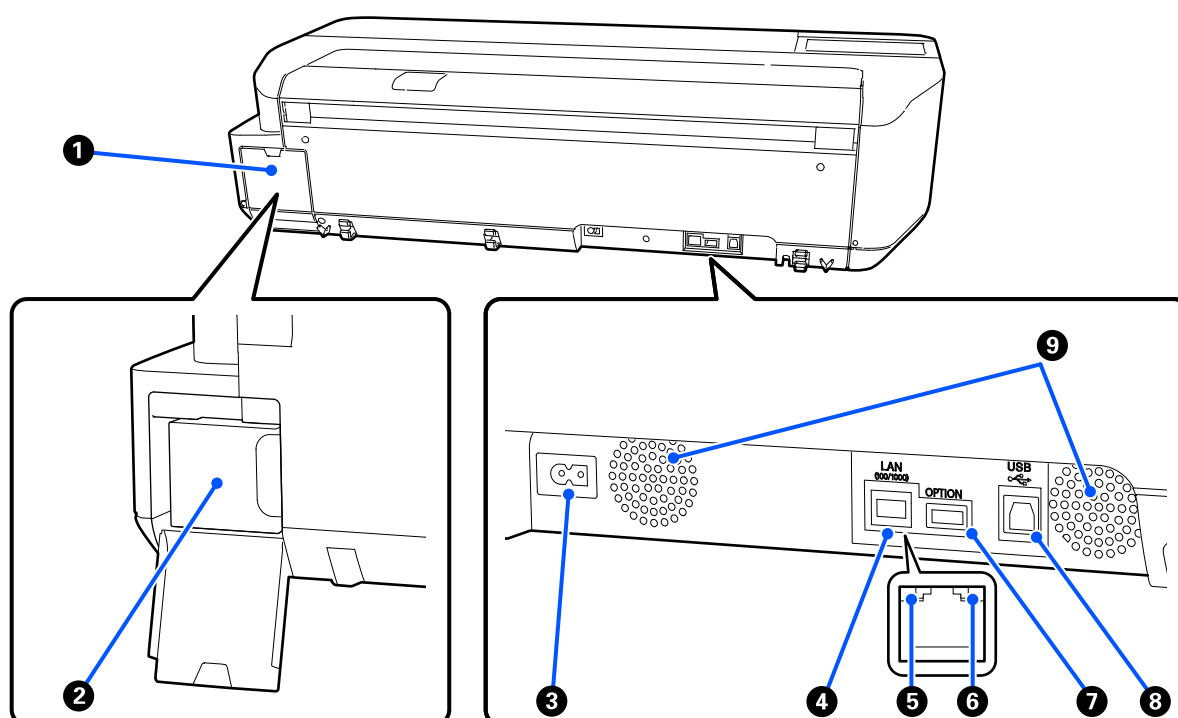

1 Maintenance box cover

Open when replacing the maintenance box.

2 Maintenance box

A container for collecting waste ink.

 [“Replacing Maintenance Box” on page 183](#)

3 AC inlet

Connect the supplied power cable here.

4 LAN port

Connects the LAN cable.

Introduction

5 Status light (green, orange)

The color indicates the network transmission speed.

Off: 10BASE-T

Orange: 100BASE-TX

Green: 1000BASE-T

6 Data light (yellow)

The network connection status and data reception are indicated by a lit or flashing light.

On: Connected.

Flashing: Receiving data.

7 OPTION port (except for the SC-T5100M Series/SC-T3100M Series)

Connect a scanner to perform enlarged copying.

 [“Making Enlarged Copies with an A3 or A4 Scanner \(Except for the SC-T5100M Series/SC-T3100M Series\)” on page 111](#)

8 USB port

Connect the USB cable here.

9 Vents

Do not block the vents.

 [“Installation space” on page 19](#)

Introduction

Control panel

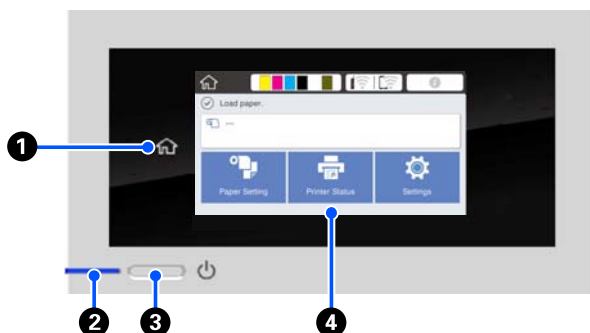



1 Home button

Touch this button while a menu is displayed to return to the Home screen. The home button is off when it cannot be used during operations such as paper feeding.

2 light (power light)

On  : The power is on.

Flashi  : The printer is performing a process such as starting up, powering off, data receiving, or print head cleaning. Please wait without performing any operation until this light stops flashing. Do not disconnect the power cord.

Off  : The power is off.

3 button (power button)

Turns the power on and off.

4 Screen

This is a touch panel to display the printer's status, menus, error messages, and so on. You can select the menu items and options displayed on this screen by gently touching (tapping) them, and scroll the screen by moving your finger while it remains touching the screen.

Understanding and Operating the Screen

Home screen

The contents of the Home screen vary depending on the model and operating conditions.

Common to all models

This section explains the displays and operations that are common to all models.

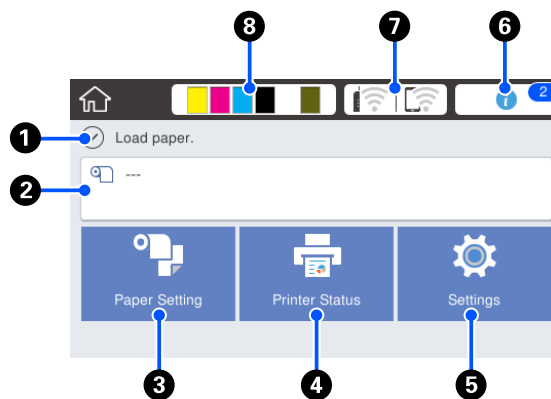

Overview of Home screen operations  *Operator's Guide* (booklet or PDF)

1 Information display area

Displays the printer's status, error messages, and so on.

2 Roll paper information area

- When roll paper is loaded
Displays information on the loaded roll paper. When Setup is set to On, the approximate remaining amount (remaining length) is displayed. Touching this area displays a menu to perform operations such as setting and adjusting the roll paper.
["Roll Paper menu" on page 132](#)
- When roll paper is not loaded
Displays "---". Touching this area displays the procedure for loading roll paper.

3 Paper Setting menu button

Introduction

Touch this button when loading, removing, setting, or adjusting paper.

- ❑ See the following for more details on Roll Paper.
 - 🔗 [“Loading and Removing the Roll Paper” on page 30](#)
 - Menu descriptions 🔗 [“Roll Paper menu” on page 132](#)
- ❑ See the following for details on the Auto Sheet Feeder.
 - 🔗 [“Loading and Removing Paper from the Auto Sheet Feeder” on page 36](#)
 - Menu descriptions 🔗 [“Auto Sheet Feeder menu” on page 135](#)
- ❑ See the following for more details on Cut Sheet(1 sheet).
 - 🔗 [“Loading and Removing Cut Sheet\(1 sheet\)” on page 40](#)
 - Menu descriptions 🔗 [“Cut Sheet\(1 sheet\) menu” on page 136](#)

4 Printer Status menu button

Touch this button when you want to check the status of consumables or details of displayed notifications.

🔗 [“Printer Status menu” on page 137](#)

5 Settings menu button

Touch this button when you want to perform maintenance or configure the printer operation settings, network settings, or other settings. See the following for more details.

🔗 [“Settings menu” on page 138](#)

6 Information icon







When there are notifications, such as consumable remaining amount low warnings, the number of notifications is indicated by a badge at the top right of this icon. If you touch this icon when the badge is displayed, a list of the notifications that require your action is displayed. Touching each item displays instructions on what to do. If you do not perform the actions, the badge will not disappear.

7 Network icon

The network connection status is indicated by an icon as shown below.

Touching the icon allows you to switch the network connection status.

🔗 [“Changing the Network Connection Methods” on page 96](#)

	Not connected to a wired LAN or the wired LAN or wireless LAN not set.
	Connected to a wired LAN.
	Wireless LAN (Wi-Fi) is disabled.
	Searching for SSID, IP address not set, or signal strength is 0 or poor.
	Connected to a wireless LAN (Wi-Fi). The number of lines indicates the signal strength. The more lines there are, the better the signal strength.
	Wi-Fi Direct (simple AP) connection is disabled.
	Wi-Fi Direct (simple AP) connection is enabled.

8 Consumables status icon

Estimates of the remaining amounts of ink cartridges and the empty space in the Maintenance Box are indicated by the length of the bars. The shorter a bar is, the lower the remaining amount of ink or space.

When  is displayed, the remaining amount of the corresponding ink cartridge or the amount of empty space in the Maintenance Box is low. Touching the icon displays the consumables status screen so that you can check the ink cartridge and Maintenance Box product numbers. This is a shortcut button for **Supply Status** in the **Printer Status** menu.

🔗 [“Printer Status menu” on page 137](#)

Except for the SC-T5100M Series/ SC-T3100M Series

When you connect an Epson A3 or A4 scanner to the printer, **Enlarged Copy** appears to allow you to easily make enlarged copies.

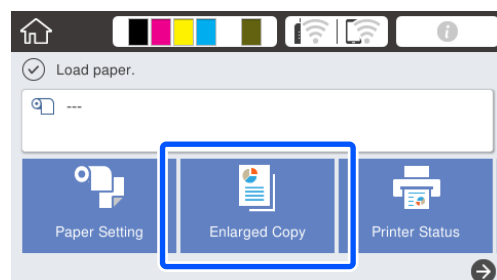

Introduction

☞ “Making Enlarged Copies with an A3 or A4 Scanner (Except for the SC-T5100M Series/SC-T3100M Series)” on page 111

SC-T5100M Series/SC-T3100M Series only

The **Copy**, **Scan**, and **Network Folder** buttons are displayed on the screen.

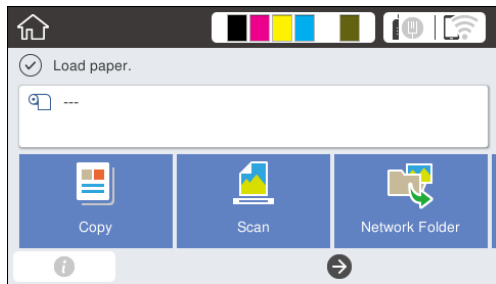

☞ “Copy (SC-T5100M Series/SC-T3100M Series only)” on page 103

☞ “Scan (SC-T5100M Series/SC-T3100M Series only)” on page 107

☞ “Printing Files from a Shared Folder (Print from Folder)” on page 100

Inserting USB flash drive into the printer displays a **Memory Device** button on the screen.

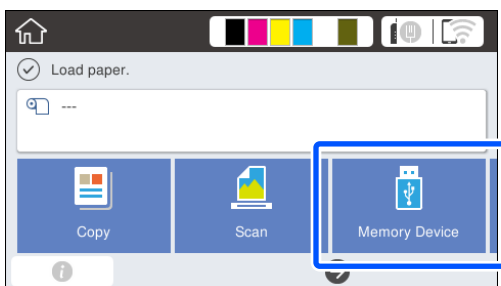

☞ “Printing Files on USB Flash Memory Directly” on page 101

Using your Presets

The following screen has a **Presets** button at the top right of the screen. (The following illustration shows an example of the **Copy** screen.)

- ❑ **Enlarged Copy** screen (except for the SC-T5100M Series/SC-T3100M Series)
- ❑ **Copy, Scan, Memory Device** screen (SC-T5100M Series/SC-T3100M Series only)

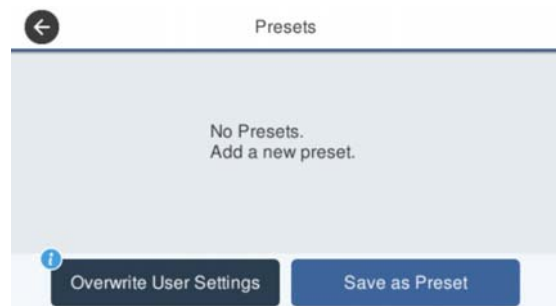
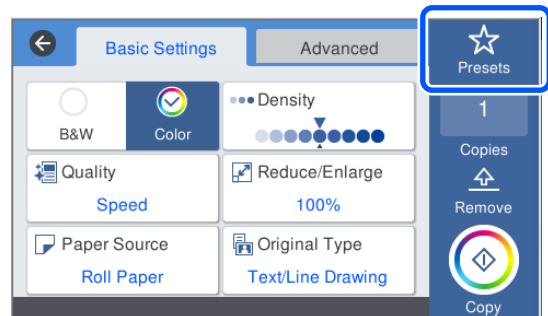

- ❑ Press **Presets** and then **Overwrite User Settings** to continue using the current settings from the next time you print.
- ❑ Press the **Presets** button, press **Save as Preset**, enter the name you want to use, and then press **OK** to register the current settings as a preset.

Entering a registration name

You can use a keyboard to enter the name of the preset.

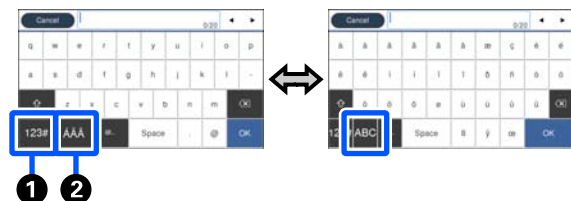

- 1 **Change character type button**

Introduction

Each time you press the button, the type of characters you can enter change as follows.

ABC: Enters alphabet letters.

123#: Enters numbers and symbols.

2 Change input method button

Each time you press the button, the keyboard layout changes as shown in the illustration.

Deleting a saved preset

Press the **Presets** button, press the ">" area on the right of the Presets, and then press the  (trash) button on the next screen to delete the preset.

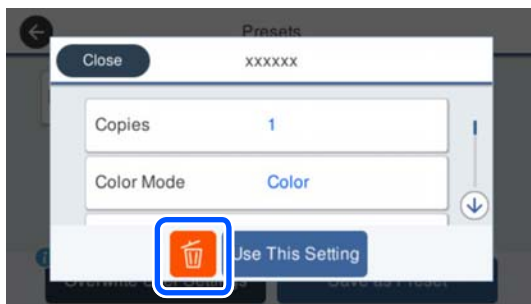

When restoring the initial values for Copy/Scan to the manufacturer's settings

Select **General Settings - System Administration - Restore Default Settings**, and then select **Copy Settings** or **Scan Settings**.

This procedure does not delete your saved presets.

Introduction

Features of Printer

Realizing High Resolution

CAD drawings that are clear, legible, and can even be used safely outdoors

Newly-developed Epson UltraChrome XD2 ink enables the printer to produce extremely detailed drawings both in black and white and in color.

The supplied printer driver offers a line drawing mode, making it easier to optimize printing for line drawing and, through unsurpassed reproduction of line drawing and fine lines in the form of connected lines, diagonals, and curves, ensuring the best possible results when the printer is used for drawings.

In addition, you can even safely take your drawings outdoors with you because they are printed using ink with excellent water resistance.

 [“Printing CAD Drawings” on page 60](#)

Posters and displays that are vivid and also allow for short-term outdoor display

Posters with vivid hues can be printed simply by selecting, for example, **Poster (Photo)/Perspective** in Select Target of the supplied printer driver.

Using ink with superb light resistance means that prints made for indoor use will take a very long time to fade.

Your posters will last even longer if you use lamination processing.

The effect differs depending on the paper.

Insistence on Ease-of-Use

Space-saving large-format printer

As the printer is smaller and lighter than our standard large-format printers, it does not take up as much space. The model without a stand can even be placed on a drawing storage cabinet or the like. See the following for dimensions.

 [“Specifications Table” on page 222](#)

Automatic switching between auto sheet feeder (cut sheets) and roll paper

You can load roll paper in the printer, and load multiple sheets of A3 or smaller paper in the auto sheet feeder at the same time. Selecting one of them from the printer driver's **Source** settings allows you to automatically switch paper and print easily.

Smooth operation while checking the operating instructions on the screen

In addition to having a screen design that enables intuitive operation, this printer allows you to check illustrated instructions of operations such as how to load paper.

 [Operator's Guide \(booklet or PDF\)](#)

Printer driver that is simple and easy to operate

Print settings can be optimized simply by choosing the desired use or target. This saves you the trouble of adjusting print settings individually. When you select a Source setting, printing failures due to paper loading mistakes are reduced because the size and type of paper loaded in the printer are applied automatically.

In addition to checking the set conditions in an illustration in the printer driver, you can also check a detailed image in the preview screen before printing.

Support for wireless LAN connection

This printer can be freely placed where desired without considering cable routing because it can connect with a computer via a wireless LAN to print. Of course, it also supports a wired LAN connection.

Furthermore, even if your device is not connected to a LAN, this printer also allows printing by directly connecting with it using Wi-Fi Direct.

 [“Switching to Wireless LAN” on page 96](#)

 [“Directly Connecting Wirelessly \(Wi-Fi Direct\)” on page 97](#)

Introduction

Notes on Usage and Storage

Installation space

Make sure that you secure the following space, clear of any other objects, so that paper ejection and consumable replacement are not obstructed.

See the "Specifications Table" for the external dimensions of the printer.

 "Specifications Table" on page 222

SC-T5100M Series/SC-T5100 Series/SC-T3100 Series/SC-T3100M Series

When the optional Stand (24") is installed for the SC-T3100M Series.

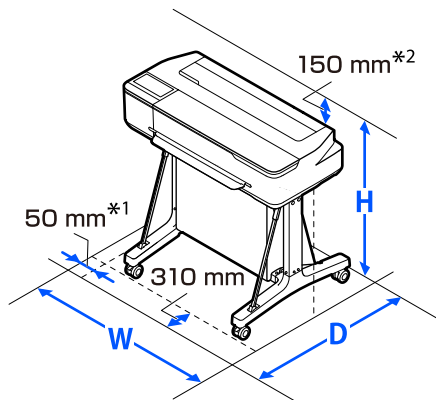

	W	D	H
SC-T5100M Series	1373 mm	1270 mm	1203 mm
SC-T5100 Series	1318 mm	1270 mm	1063 mm
SC-T3100 Series	1020 mm	1270 mm	1063 mm
SC-T3100M Series	1075 mm	1270 mm	1203 mm

SC-T3100M Series/SC-T5100N Series/SC-T3100N Series/SC-T2100 Series/SC-T5100M Series

SC-T5100M Series without the stand.

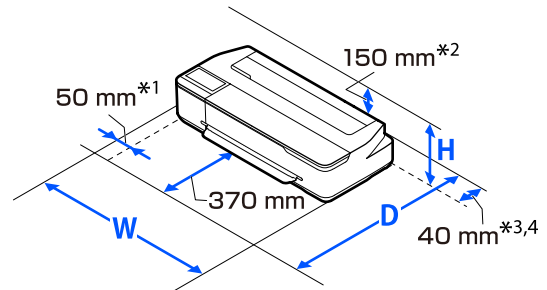

	W	D	H
SC-T3100M Series	1075 mm	915 mm	520 mm
SC-T5100N Series	1318 mm	915 mm	380 mm
SC-T3100N Series SC-T2100 Series	1020 mm	915 mm	380 mm
SC-T5100M Series	1373 mm	915 mm	520 mm

*1 105 mm for the SC-T5100M Series/SC-T3100M Series

*2 228 mm for the SC-T5100M Series/SC-T3100M Series

*3 You need at least 137 mm of space at the back when using the document support on the SC-T5100M Series/SC-T3100M Series.

*4 You need at least 130 mm of space at the back when replacing the maintenance box.

Notes when using the printer

Note the following points when using this printer to avoid breakdowns, malfunctions, and print quality decline.

Introduction

- ❑ When using the printer, observe the operating temperature and humidity range described in the "Specifications Table".
 ↪ "Specifications Table" on page 222
 Even when the conditions above are met, you may not be able to print properly if the environmental conditions are not suitable for the paper. Be sure to use the printer in an environment where the paper's requirements are met. For more details, see the documentation supplied with the paper.
 Also, when operating in dry areas, air conditioned environment, or under direct sunlight, maintain the appropriate humidity.
- ❑ Do not install the printer next to heat sources or directly in the path of air from a ventilator or air conditioner. Failure to observe this precaution could result in the print head nozzles drying and clogging.
- ❑ The print head may not be capped (i.e., may not move to the right-hand side) if an error occurs and the printer is turned off without first resolving the error. Capping is a function for automatically covering the print head with a cap (lid) to prevent the print head from drying out. In this case, turn on the power and wait a while until capping is performed automatically.
- ❑ When the power is on, do not remove the power plug or cut the power at the breaker. The print head may not be capped properly. In this case, turn on the power and wait a while until capping is performed automatically.
- ❑ Even when printing is not performed, some of each color of ink will be consumed by ink cartridge replacement, print head cleaning, and other maintenance operations needed to keep the print head in good condition.
- ❑ The printer may automatically perform print head cleaning to maintain good printing quality. Please wait until cleaning finishes without opening any of the covers or turning off the power.

Notes when not using the printer

If you are not using it, note the following points when storing the printer. If it is not stored correctly, you may not be able to print properly the next time it is used.

- ❑ When storing the printer, store it flat with the ink cartridges installed. Do not place the printer tilted, upright, or upside down.
- ❑ If you do not print for a long time, the print head nozzles may become clogged. We recommend that you print once a week to prevent the print head from clogging.
- ❑ The roller may leave an impression on paper that is left in the printer. This can also cause wavy or curled paper resulting in paper feeding problems or the print head could be scratched. Remove any paper when storing.
- ❑ Store the printer after confirming that the print head has been capped (the print head is positioned at the far right). If the print head is left uncapped for a long time, the print quality may decline.

Note:

If the print head is not capped, turn the printer on, and then turn it off.

- ❑ To prevent the accumulation of dust and other foreign matter in the printer, close all covers before placing it in storage.
 If the printer will be not be used for an extended period, protect it with an anti-static cloth or other cover.
 The print head nozzles are very small, and they can become clogged easily if fine dust gets on the print head, and you may not be able to print properly.
- ❑ The print head may fail if the environmental temperature becomes -10°C or lower. If the environmental temperature in the room or during transport is expected to become -10°C or lower, be sure to discharge the ink in advance.
 ↪ "Handling if Transporting/Leaving the Printer in an Environment of -10°C or Less" on page 218

Notes on handling ink cartridges

Note the following points when handling ink cartridges to maintain good print quality.

- ❑ The ink cartridges packaged with your printer are partly used during initial setup. In order to produce high quality printouts, the print head in your printer will be fully charged with ink. This one-off process consumes a quantity of ink and therefore these cartridges may print fewer pages compared to subsequent ink cartridges.

Introduction

- ❑ The Initial Cartridge included with the printer is designed for printer setup and not for resale or later use. After some ink is used for charging, the rest is available for printing. For the initial setup, make sure you use the Initial Cartridge.
- ❑ We recommend that ink cartridges be stored at room temperature out of direct sunlight and used before the expiry date printed on the packaging.
- ❑ To ensure good results, use all the ink in the cartridges within 6 months of opening the packages.
- ❑ Do not open the ink cartridge package until you are ready to install it in the printer. A vacuum pack is used to maintain quality.
- ❑ Ink cartridges that have been stored at low temperatures for an extended period should be allowed to return to room temperature over a period of at least three hours.
- ❑ Be sure to peel off the tape (yellow) before installing an ink cartridge. If you attempt to forcibly install an ink cartridge without removing the tape, the printer may become unable to print properly. Never peel off anything else such as the film or label. Otherwise, ink could leak.
- ❑ Do not touch the IC chip on the ink cartridge. You may not be able to print properly.
 [“Replacing Ink Cartridges” on page 181](#)
- ❑ Install the ink cartridges for all the colors. Printing is not possible if they are not all installed.
- ❑ Do not leave the printer without ink cartridges installed. The print head nozzles may dry and printing may become no longer possible.
- ❑ The ink level and other data are stored in the IC chip, allowing cartridges to be used after being removed and replaced. However, if an ink cartridge with not much ink remaining is removed and reinstalled, it may not be usable because some ink is consumed to ensure the reliability of the printer.
- ❑ To avoid getting dust on the ink supply port, store a removed partially used ink cartridge with the ink supply port downward or horizontal in the same environment as this product. The ink supply port has a valve in it so it does not need to be capped.
- ❑ Removed ink cartridges may have ink around the ink supply port, so be careful not to get any ink on the surrounding area when removing the cartridges.
- ❑ To maintain the quality of the print head, this printer stops printing before ink cartridges are completely expended.
- ❑ Although the ink cartridges may contain recycled materials, this does not affect printer function or performance.
- ❑ Do not dismantle or remodel ink cartridges. You may not be able to print properly.
- ❑ Do not drop or otherwise subject an ink cartridge to a strong impact. Ink may leak from the cartridge.
- ❑ Even when the printer is not in use, some of each color of ink will be consumed by ink cartridge replacement, print head cleaning, and other maintenance operations needed to keep the print head in good condition.
- ❑ A mixture of color inks may be used to print black depending on the paper type and print quality settings even for black and white and grayscale printing.

Notes on handling paper

Note the following points when handling and storing the paper. If the paper is not in good condition, print quality may decline.

Check the documentation supplied with each paper.

Notes on Handling

- ❑ Use Epson special media under normal room conditions (temperature: 15 to 25°C, humidity: 40 to 60%).
- ❑ Do not fold the paper or scratch the surface of the paper.
- ❑ Avoid touching the printable surface of the paper with your bare hands. Moisture and oils from your hands can affect print quality.
- ❑ Handle paper by the edges. We recommend wearing cotton gloves.

Introduction

- ❑ Changes in temperature and humidity may cause paper to become wavy or curled. Check the following points.
 - ❑ Load the paper just before printing.
 - ❑ Do not use wavy or curled paper.
For roll paper, cut off the wavy or curled parts and then load it again.
For cut sheets, use new paper.
- ❑ Do not wet the paper.
- ❑ Do not throw away the paper packaging as you can use it for storing the paper.
- ❑ Avoid locations that are subject to direct sunlight, excessive heat, or humidity.
- ❑ Keep cut sheets in their original package after opening, and keep them in a flat place.
- ❑ Remove roll paper that is not in use from the printer. Rewind it correctly and then store it in the original packaging that came with the roll paper. If you leave the roll paper in the printer for a long time, its quality may decline.

Notes on handling printed paper

To maintain long lasting, high quality print results, note the following points.

- ❑ Do not rub or scratch print outs. If they are rubbed or scratched, the ink may peel off.
- ❑ Do not touch the surface of print outs. The ink may peel off.
- ❑ Make sure the print outs are completely dry before folding or stacking; otherwise, the color may change where they touch (leaves a mark). These marks will disappear if they are separated immediately and dried; however, they will remain if not separated.
- ❑ If you put the print outs in an album before they are completely dry, they may be blurred.
- ❑ Do not use a dryer to dry the print outs.
- ❑ Avoid direct sunlight.
- ❑ Prevent color distortion while displaying or storing the print outs by following the instructions in the paper's documentation.

Note:

Typically, print outs and photos fade over time (color distortion) due to the effects of light and various constituents in the air. This also applies to Epson special media. However, with the correct storage method, the degree of color distortion can be minimized.

- ❑ *See the documentation supplied with Epson special media for detailed information on handling the paper after printing.*
- ❑ *The colors of photos, posters, and other printed materials appear different under different lighting conditions (light sources*). The colors of print outs from this printer may also appear different under different light sources.*
* *Light sources include sunlight, fluorescent light, incandescent light, and other types.*

Saving Power

The printer enters sleep mode or turns off automatically if no operations are performed for a set period. You can adjust the time before power management is applied. Any increase will affect the product's energy efficiency. Please consider the environment before making any change.

Sleep mode

The printer enters sleep mode when there are no errors, no print jobs being received, and no control panel or other operations performed. When the printer enters sleep mode, the control panel's screen turns off and the internal motors and other parts switch off to consume less power.

Sleep mode is exited if a print job is received or the screen of the control panel is touched.

You can set the time it takes for the printer to enter sleep mode. At default settings, the printer enters sleep mode if no operations are performed for 15 minutes. The time it takes for the printer to enter sleep mode can be changed in the **Basic Settings** menu.

 [“General Settings - Basic Settings” on page 138](#)

Note:

When the printer enters sleep mode, the control panel's screen goes blank as if the power has been turned off, but the  light remains lit.

Introduction

Power Off Timer

This function automatically turns the printer off if no errors occur, no print jobs are received, and no control panel or other operations are performed for a set period of time.

The default setting differs as follows depending on the model.

- SC-T5100M Series/SC-T3100M Series/SC-T5100 Series/SC-T5100N Series/SC-T3100 Series/SC-T3100N Series/SC-T2100 Series
Set to **8h**.
- Models other than the above
Set to **Off**.

Power Off Timer settings can be changed from the Basic Settings menu.

 [“General Settings - Basic Settings” on page 138](#)

Introducing the Software

Introducing the Software

Provided Software

The following table lists the provided software.



The supplied software disc contains the software for Windows. When using a Mac or a computer without a disc drive, download the software from <http://epson.sn> and then install it.

For details on the various software, see the online help of each software or the *Administrator's Guide* (online manual).

Note:

Convenient software compatible with this printer is introduced on the Epson website. Please check the information from the following link.

<https://www.epson.com>

Software Name	Function
Printer Driver	Install the printer driver to take full advantage of the functionality of this printer when printing.  "Printing with the Printer Driver from Your Computer" on page 49
EPSON Software Updater	Software to check whether there is any software update information and then notify you and install the software if an update is available. It allows you to update the firmware and already installed software of the printer.  "Updating Software or Installing Additional Software" on page 27
LFP Print Plug-In for Office (Windows Only)	Plug-in software for Microsoft Office applications (Word, Excel, and PowerPoint). Installing this plug-in displays ribbon items in Office applications that give quick access to horizontal and vertical banner printing and enlarged printing. It can be installed by selecting it in the Additional Installation screen when installing the software. You can also install it later with EPSON Software Updater. The supported Microsoft versions are shown below. Office 2003/Office 2007/Office 2010/Office 2013/Office 2016
EpsonNet Config	Software to configure the initial settings of the network or change the settings of the network in bulk when installing or relocating Epson printers and scanners. EpsonNet Config is not installed automatically. Download it from the Epson website and then install it if necessary. https://www.epson.com For Windows, you can install the software from the following folder on the supplied software disc. \\Network\EpsonNetConfig  <i>Administrator's Guide</i>

Introducing the Software

Built-in Software in the Printer

The following software comes preinstalled in the printer. Start and use it from a Web browser via the network.

Software Name	Function
Web Config	The network security settings can be configured from Web Config. This software also has an email notification function for notifying of printer errors and other problems.  "How to Use Web Config" on page 26

Introducing the Software

How to Use Web Config

This section describes how to start the software and provides a summary of its functions.

How to Start

Start the software from a web browser on a computer or smart device that is connected to the same network as the printer.

- 1 Check the IP address of the printer.

Touch  on the Home screen, select the connected network, and check the IP address.

Note:

The IP address can also be checked by printing a network connection check report. A report can be printed by touching the following in order from the Home screen.

Settings - General Settings - Network Settings - Connection Check

- 2 Start a Web browser on a computer or smart device connected to the printer via the network.

- 3 Enter the IP address of the printer in the address bar of the Web browser and press the **Enter** or **Return** key.

Format:

IPv4: http://IP address of printer/

IPv6: http://[IP address of printer]/

Example:

IPv4: http://192.168.100.201/

IPv6: http://[2001:db8::1000:1]/

Closing

Close the Web browser.

Function Summary

This section introduces the main functions of Web Config. See the *Administrator's Guide* for more details.



Main Functions

- Check the printer's status, such as the remaining amount of ink.
- Check and update the printer's firmware version.
- Configure the printer's network settings and advanced security settings, such as SSL/TLS communication, IPsec/IP filtering, and IEEE802.1X, which cannot be configured with the printer alone.
- Edit the custom paper settings and export and import the settings.
The custom paper settings registered in **Settings - General Settings - Printer Settings - Custom Paper Setting** of the printer can be changed as well as exported to a file and then imported (registered) to another printer. This is convenient when you install multiple printers and want to use common custom paper settings for them.
- You can print by simply selecting the file you want to print, and then uploading it to the printer. (SC-T5100M Series/SC-T3100M Series only)
 ["Printing Directly Over the Web \(Upload and Print\)" on page 99](#)

Introducing the Software

Updating Software or Installing Additional Software

When you install the software during setup as described in the *Setup Guide*, Epson Software Updater is installed. Epson Software Updater allows you to update the printer's firmware, update software that has been installed on your computer, and install additional software for this printer.

Note:

The software is updated as needed for greater convenience and more robust functionality. We recommend setting to receive update notifications with Epson Software Updater and updating the software as soon as possible when there is a notification.

Checking Whether Updates Available and Updating Software

1 Check that the computer and printer are in the following states.

- Computer is connected to the Internet.
- Printer and computer can communicate.

2 Start Epson Software Updater.

- Windows
Display the list of all the programs and then click Epson Software Updater in the Epson Software folder.

Note:

- If you press the Windows key (key with Windows logo mark) on the keyboard and then type the software name in the search box of the displayed window, the software appears immediately.
- The software can also be started by clicking the printer icon on the Taskbar of the desktop and then selecting **Software Update**.

- Mac
Select **Go - Applications - Epson Software - EPSON Software Updater**.

3 Select the software or manuals to be updated and then update them.

Follow the on-screen instructions.

Important:

Do not turn off the computer or printer during the update.

Note:

Software not displayed in the list cannot be updated with EPSON Software Updater. Check the latest versions of software on the Epson website.

Please note that you cannot update or install software using Epson Software Updater if you are using a Windows Server OS. Download the software from the Epson website.

<https://www.epson.com>

Receiving Update Notifications

Windows

- 1** Start Epson Software Updater.
- 2** Click **Auto update settings**.
- 3** Select the interval to perform the update check in the **Interval to Check** field of the printer and then click **OK**.

Mac

The software is set by default to check and notify whether there are updates every 30 days.

Introducing the Software

Uninstalling Software

Windows

Important:

- You must log in as an Administrator.
- If the password or confirmation of an administrator is requested, enter the password and then continue with the operation.

- 1 Turn off the printer, and unplug the interface cable.
- 2 Close all applications running on your computer.
- 3 Go to the **Control Panel** and click **Uninstall a program** from the **Programs** category.



- 4 Select the software you want to remove and then click **Uninstall/Change** (or **Change/Remove / Add/Remove**).
- You can remove the printer driver and EPSON Status Monitor 3 by selecting **EPSON SC-XXXXX Printer Uninstall**.

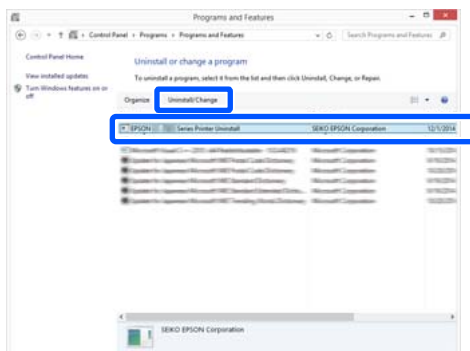

- 5 Select the printer icon, and then click **OK**.



- 6 Follow the on-screen instructions to continue. When the delete confirmation message appears, click **Yes**.

Restart the computer if you are reinstalling the printer driver.

Mac

When reinstalling or upgrading the printer driver or other software, follow the steps below to uninstall the target software first.

Printer Driver

Use the "Uninstaller".

Downloading the Uninstaller

Download the "Uninstaller" from the Epson website.

<https://www.epson.com>

Using the Uninstaller

Follow the instructions on the Epson website.

Other Software

Drag and drop folder with the software name from the **Applications** folder into **Trash** to delete.

Loading and Setting the Paper

Loading and Setting the Paper

Notes on Loading the Paper



Caution:

Do not rub the edges of the paper with your hands. The edges of the paper are thin and sharp and could cause an injury.

Do not leave paper loaded in the printer.

The roller may leave an impression on paper that is left in the printer. In addition, the paper may become wavy or curled due to damp, which may cause paper feeding problems, paper jams, or soiled prints.

We recommend that you return the paper to its original package and store it flat, and take it out of the package for use when printing.

Do not load roll paper with the right and left edges uneven

Loading roll paper with the right and left edges uneven may cause paper feeding problems or paper meandering may occur during printing. Rewind the paper to make the edges even before using roll paper or use roll paper with no problem.

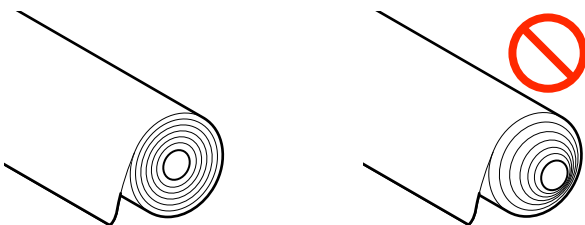

Do not load curled paper

Loading curled paper may cause paper jams or soiled prints. Flatten the paper before use by bending it in the opposite way or use paper with no problem.

Unsupported paper

Do not use paper that is wavy, torn, cut, folded, too thick, too thin, has a sticker affixed, etc. Doing so may cause paper jams or soiled prints. See the following for paper supported by the printer.

☞ [“Epson Special Media Table” on page 209](#)

☞ [“Supported Commercially Available Paper” on page 212](#)

Paper Load Position

The loading position differs depending on the shape and size of the paper being loaded. See the following for more details on the paper that can be used with the printer.

☞ [“Supported Media” on page 209](#)

Roll Paper

You can load roll paper from 297 mm to the maximum printable width.

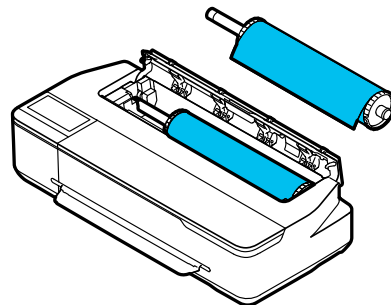

Auto Sheet Feeder

You can load multiple sheets of A4 to A3 paper. The number of sheets that can be loaded at one time depends on the paper. See the following for more details.

☞ [“Cut Sheet” on page 210](#)

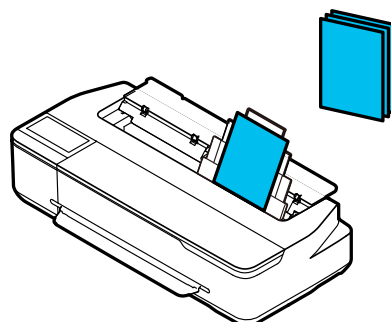

Loading and Setting the Paper

Cut Sheet(1 sheet)

One sheet of cut paper from A4 to the maximum printable width can be loaded.

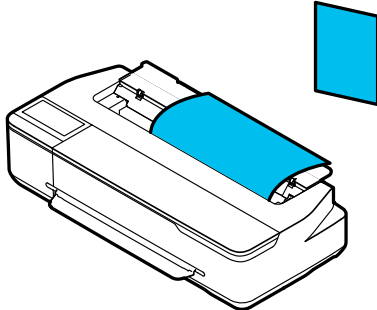

Note:

- ❑ The paper slot for Roll Paper and Cut Sheet(1 sheet) is the same. Insert either one into the paper slot.
- ❑ You can load paper in the auto sheet feeder while roll paper is loaded. You can switch to the paper source you want to print from in the printer driver.

Loading and Removing the Roll Paper

Place the roll paper on the supplied spindle and then load the roll paper in the printer.

When replacing paper, remove the loaded paper first.

[“Removing Roll Paper” on page 34](#)

[“Removing Cut Sheet \(1 Sheet\)” on page 41](#)

If paper is loaded in the auto sheet feeder, remove the paper, load or remove the roll paper, and then re-load the paper in the auto sheet feeder. Remove the paper stacker when printing on roll paper.

[“Removing paper from the auto sheet feeder” on page 38](#)

[“Installing and removing the paper stacker \(for plain paper\)” on page 36](#)

Loading Roll Paper

Caution:

Hold the flange while loading the roll paper. If you load the paper while holding another part, your hand or fingers may get trapped causing an injury.

Note:

You can load the paper while viewing the loading procedure on the screen. To view the procedure on the screen, touch the Roll paper information area of the Home screen.

- 1 Check that "Load paper." is displayed on the Home screen and then open the cut sheet cover.

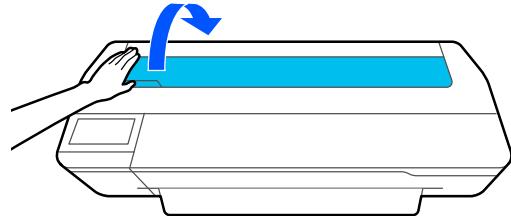

- 2 Unlock the center lock and open the roll paper cover.

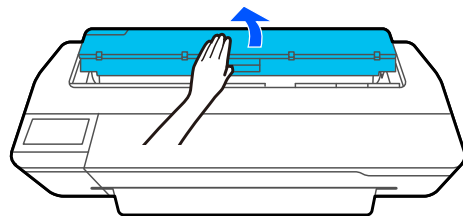

- 3 Remove the inserted spindle.

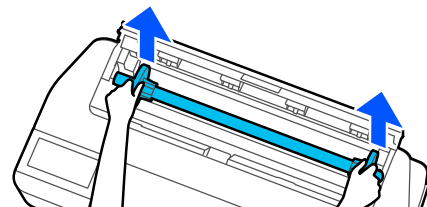

- 4 Pull off the transparent flange from the spindle.

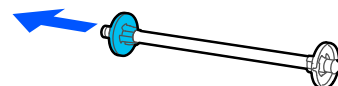

Loading and Setting the Paper

- 5** Place the roll paper on a flat surface and then insert the spindle.
- With the black flange is on the right, orient the roll paper so that the leading edge is as shown in the figure below.

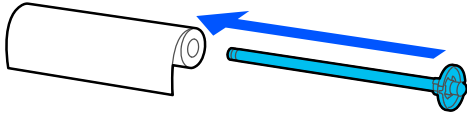

- 6** Push the flange to the roll paper until there is no gap between the flange and roll paper.

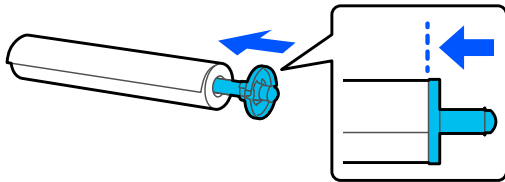

- 7** Attach the transparent flange and push it until there is no gap between the flange and roll paper.
- If there are gaps between the flanges at both ends and the roll paper, the paper may be fed skewed resulting in an error.

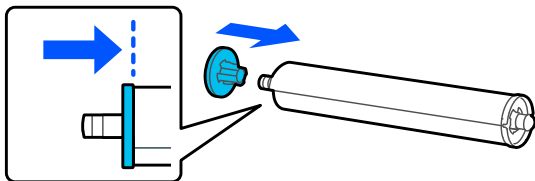

- 8** Place the spindle shaft into the left and right grooves on the spindle holder with the black flange of the spindle on the right.

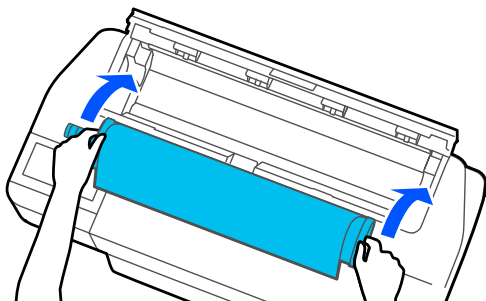

- 9** Check that the leading edge of the roll paper is not bent and then insert it into the paper slot until you hear a beep.

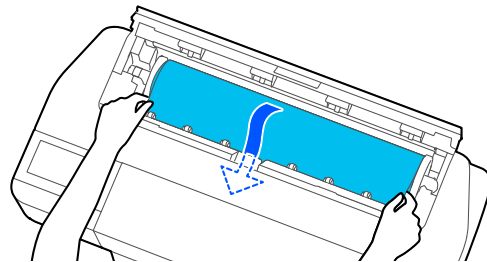

! Important:

Hold the edges of the paper and insert it straight into the paper feed slot. Inserting it skewed will cause a skew error or paper jam.

Note:

*If the leading edge of the roll paper is not horizontal or not cut cleanly, it will be cut automatically after loading completes. However, it will not be cut if **Auto Cut** is set to **Off**.*

- 10** Close the roll paper cover and cut sheet cover.

- 11** On the displayed screen, set the paper type that matches the loaded paper and set remaining amount management if necessary.

Not setting the appropriate paper type will cause print quality trouble. See the following for more details on the paper types and the remaining amount management setting.

[“For Roll Paper” on page 42](#)

Loading and Setting the Paper

Important:

When paper equivalent to B1 width is loaded in the SC-T5100M Series/SC-T5100 Series/SC-T5100N Series

Raise the B1 width paper support as shown in the figure only when you have loaded B1 width (718 to 738 mm) paper. If you do not raise the B1 width paper support, the print surface may be scuffed or soiled.

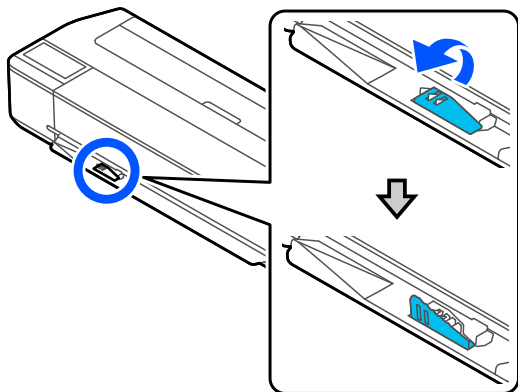

Leave the support lowered when printing to a size other than equivalent to B1 width.

- 12** For the SC-T5100M Series/SC-T5100 Series/SC-T3100 Series, check that the paper basket attached to the stand is open.

Note:
Close the paper basket before printing banners or other documents of sizes that will not fit in the paper basket. Before the paper ejected from the printer touches the floor, we suggest that you take it in both hands close to the paper eject slot and continue to lightly support it until printing is complete.

Cutting the Roll Paper

Auto Cut

Auto Cut is set to On for the printer by default. When On is set, the roll paper is cut automatically at the following times.

- When the leading edge is detected as not horizontal. After the roll paper is loaded, the leading edge part is cut straight.

- When printing of one page is finished. The roll paper is cut before printing of the next page starts.

If you do not want to cut each page or you want to cut at a desired position, see the following procedure.

Cutting after Last Page Printed or at Desired Position

Turn off auto cut in the printer driver, print, and then cut using the **Feed/Cut Paper** menu of the printer after printing finishes.

- 1** Select **Off** in **Advanced - Roll Paper Option - Auto Cut** of the printer driver and then print.

Leave the auto cut setting of the printer on.

Note:

- The auto cut setting of the printer driver has priority over that of the printer. The auto cut setting of the printer driver is reset to the default setting of **Normal Cut** when the application closes.
- To turn off auto cut when HP-GL/2 mode printing or enlarged copying, turn off the auto cut setting of the printer. Touch the Roll paper information area - **Advanced Media Setting - Auto Cut - Off** from the Home screen. The change to the setting is saved as a setting of the currently selected paper type.

- 2** Touch the Roll paper information area - **Feed/Cut Paper** from the Home screen of the printer after printing finishes.



Use the buttons displayed on the screen to cut and feed the paper.

When cutting at the printer default cut position (right after the bottom margin)

Touch the ✂ (Cut) button. The paper is cut and the paper leading edge returns to the print wait position.

Loading and Setting the Paper

When cutting at desired position

- 1 Hold down the  (Forward) or  (Backward) button until the position you want to cut reaches the position of the dotted line in the figure.

You cannot set the cutting position further inside than the bottom margin.

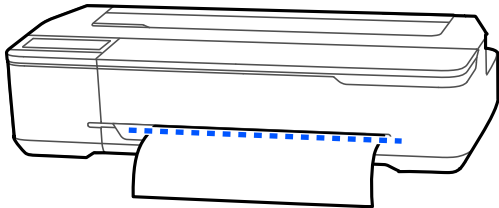

- 2 Touch the  (Cut) button.

The paper is cut.

Note:

When the length of **A** in the figure is shorter than the following length, the paper is fed automatically until the required length is obtained at the time of cutting.

- Plain paper or tracing paper: 100 mm
- Photo paper or coated paper: 80 mm
- Synthetic paper and other thick paper: 60 mm

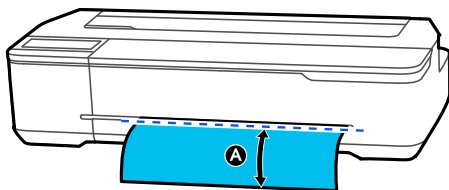

Cutting Commercially Available Synthetic or Canvas Paper with Scissors

When using commercially available paper that cannot be cleanly cut with the cutter of the printer, print cut lines and cut the paper with scissors.

Important:

- If commercially available synthetic or canvas paper is cut with the built-in cutter, the cutter may be damaged or its life may be shortened. When using such paper, cut the paper with scissors as described in the following procedure.
- Do not use a cutter. The printer may be damaged.

- 1 Turn off the auto cut setting and then print.
To print cut lines, turn off the auto cut setting of the printer. When printing via the printer driver, also turn off the setting of the printer driver.

- Printer settings
Roll paper information area - **Advanced Media Setting - Auto Cut - Off** from the Home screen.
- Printer driver settings
Advanced - Roll Paper Option - Auto Cut - Off



- 2 Touch the Roll paper information area - **Feed/Cut Paper** from the Home screen of the printer after printing finishes.

- 3 Operate the buttons displayed on the screen.

When printing cut lines at the printer default position (right after the bottom margin)

Touch the  (Cut) button. The cut or print cut lines selection screen appears.

When printing cut lines at desired position

Hold down the  (Forward) or  (Backward) button until the position you want to print the cutting line reaches the position of the dotted line in the figure.

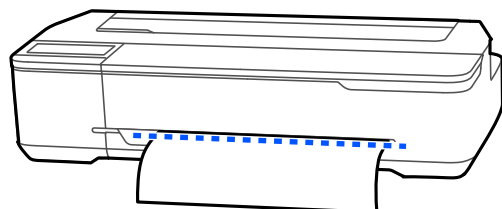

Cut lines cannot be printed further inside than the bottom margin. Once you have finished moving the paper, touch  (Cut). The cut or print cut lines selection screen appears.

Loading and Setting the Paper

- 4 Touch **Print Cutting Guideline**.
Cut lines are printed and the paper is ejected automatically to a position where it can be easily cut with scissors.
- 5 Cut the paper along the cut lines with scissors and then touch **Done**.
The paper rewinds to return the paper leading edge to the print wait position.

Removing Roll Paper

This section describes how to remove and store roll paper after printing. If you leave the roll paper loaded in the printer, the rollers may leave impressions on the roll paper.

Note:

You can remove the roll paper while viewing the roll paper removal procedure on the screen. To view the on-screen instructions, touch the Roll paper information area on the home screen, and then touch **Remove**.

- 1 If the rear edge of the printed paper is held by the printer, grasp the paper with both hands and slowly pull it towards you.
The printed paper drops automatically when the next print job starts.

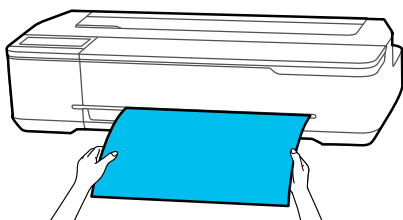

- 2 Open the cut sheet cover.

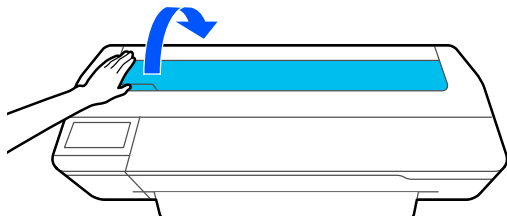

- 3 Unlock the center lock and open the roll paper cover.

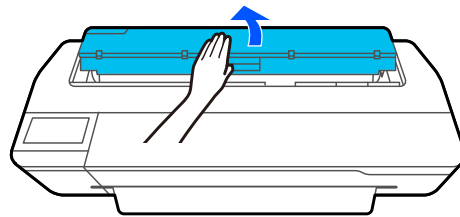

- 4 Press **Remove**.
The paper is rewound and ejected.

Note:

If printed paper is not cut and remains, a confirmation screen appears.

Touch **Cut** to cut the paper at the default cut position or touch **Print Cutting Guideline** to print cut lines at the default position.

If you want to change the cut position or the cut lines print position, touch **Close**, and change the position in the **Feed/Cut Paper** menu.

See the following for more details.

["Cutting the Roll Paper" on page 32](#)

- 5 Hold the flanges on both ends of the spindle and remove the spindle from the spindle holder.

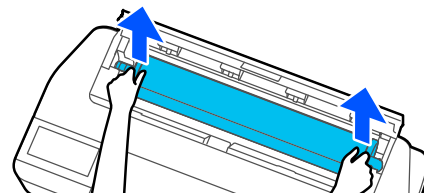

- 6 Detach the transparent flange from the spindle.

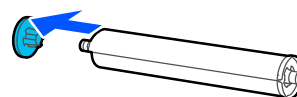

- 7 Remove the spindle from the roll paper.

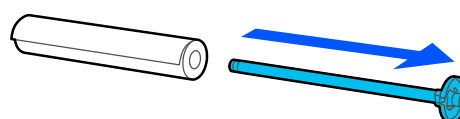

Loading and Setting the Paper

! **Important:**

After rewinding the roll paper carefully, store it in the original package.

- 8** Attach the transparent flange to the spindle and return the spindle in the printer.

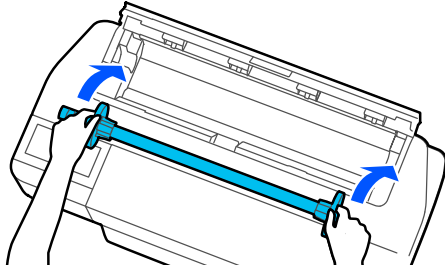

- 9** Close the roll paper cover and cut sheet cover.

Loading and Setting the Paper

Loading and Removing Paper from the Auto Sheet Feeder

Installing and removing the paper stacker (for plain paper)

Attach the paper stacker supplied when printing multiple sheets of plain paper continuously from the auto sheet feeder.

The stacker can hold approximately 20 sheets of printed paper.

However, when printing on roll paper or cut sheets (1 sheet), remove the paper stacker so that paper can be ejected smoothly.

Installing

Insert the hooks on the paper stacker straight into the slots on the front of the printer.

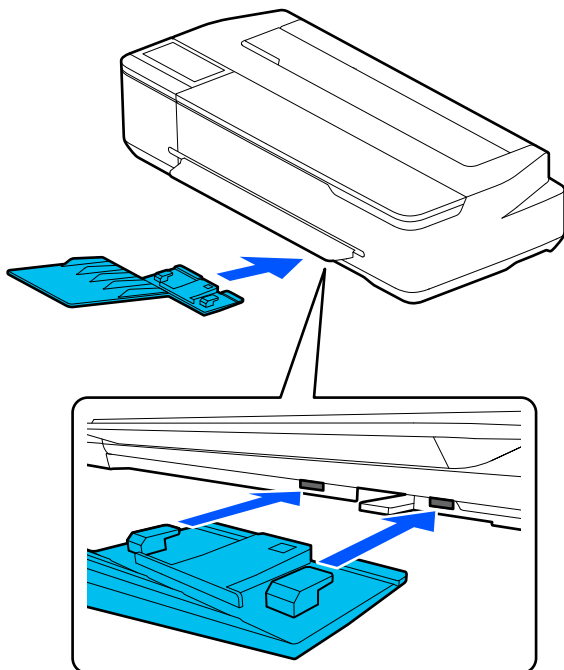

Removing

Pull the paper stacker straight out to remove it.

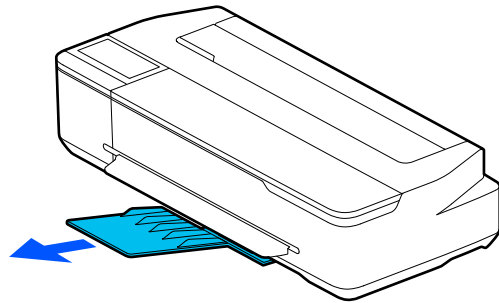

Loading paper into the auto sheet feeder

Note:

- ❑ The number of sheets that you can load into the auto sheet feeder varies depending on the paper type. See the following for more details.
 - 👉 [“Cut Sheet” on page 210](#)
 - 👉 [“Supported Commercially Available Paper” on page 212](#)
- ❑ You can load the paper while viewing the loading procedure on the screen. To view the procedure on the screen, touch **Paper Setting - Auto Sheet Feeder** from the Home screen.

! Important:

When loading multiple sheets of printing paper, carefully wipe away any paper dust and arrange the edges. However, do not clean or bend photo paper. Otherwise, the printable surface could be scratched.

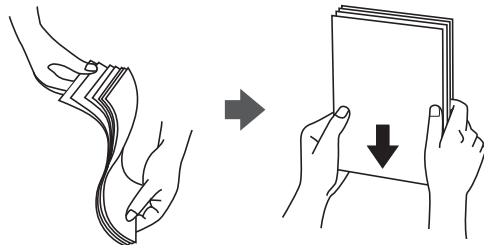

Loading and Setting the Paper

- 1 Check that **Load paper.** or **Ready** is displayed on the Home screen, and then open the cut sheet cover.

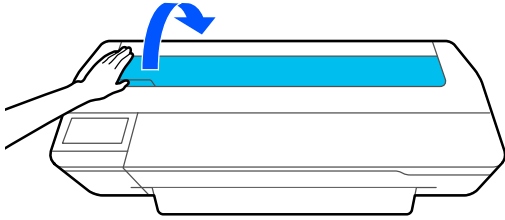

- 2 Unfold the auto sheet feeder, and pull it up and out.

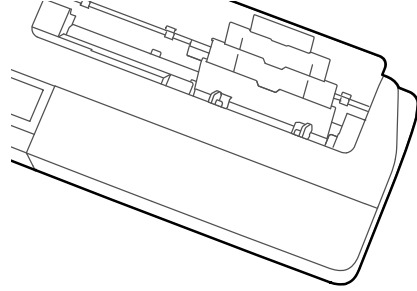
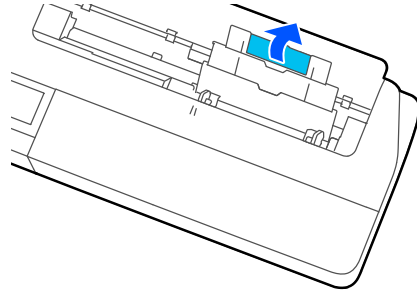
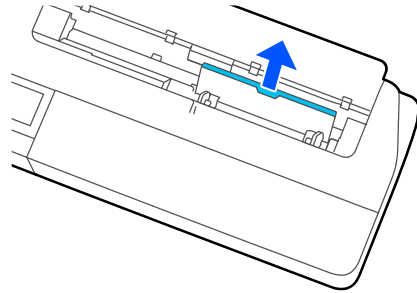
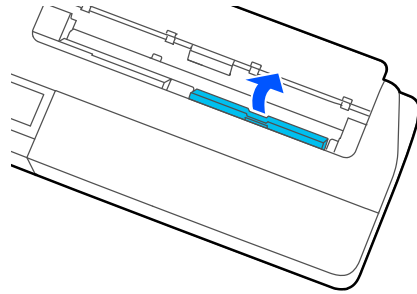

Loading and Setting the Paper

- 3** Load paper in the auto sheet feeder with the printable side facing you.

Align the paper edges before loading.

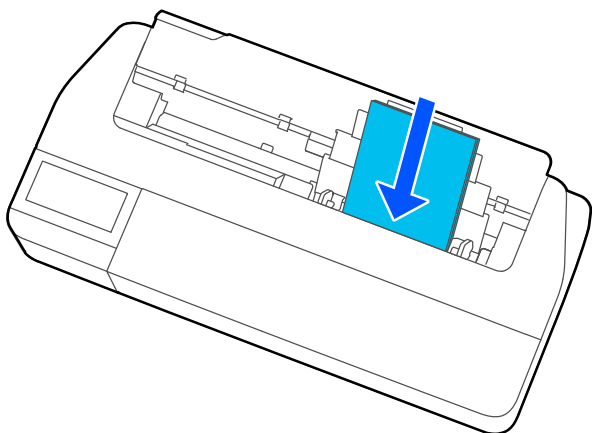

! **Important:**

*Insert all paper in portrait orientation.
Inserting paper in landscape orientation may cause a decline in print quality.*

- 4** Align the edge guides with the edges of the paper.
If the edge guides are too far from the edges of the paper, the paper may be fed at an angle which can cause skew errors and paper jams.

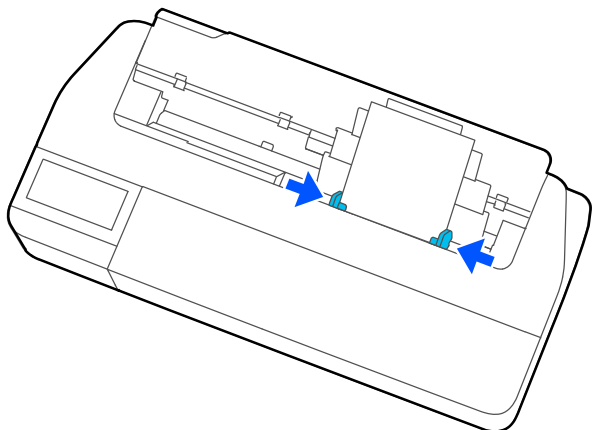

- 5** On the displayed screen, set the paper type and size that match the loaded paper.

Not setting the appropriate paper type will cause print quality trouble. See the following for more details on the paper types and sizes.

[☞ “For Auto Sheet Feeder/Cut Sheet\(1 sheet\)” on page 44](#)

Removing paper from the auto sheet feeder

- 1** Move the edge guides away from the paper and remove the paper.

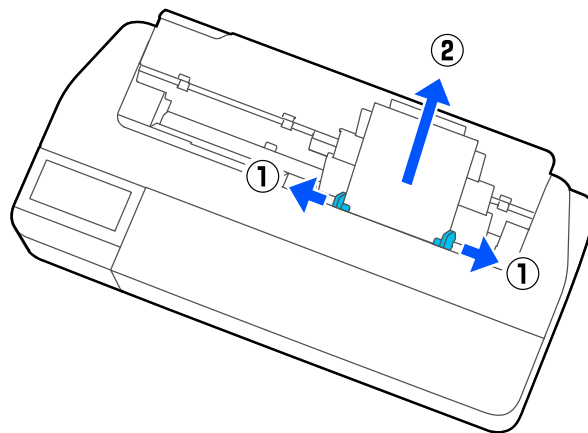

Loading and Setting the Paper

- 2** Push the auto sheet feeder back into its slots, and then fold it forward.

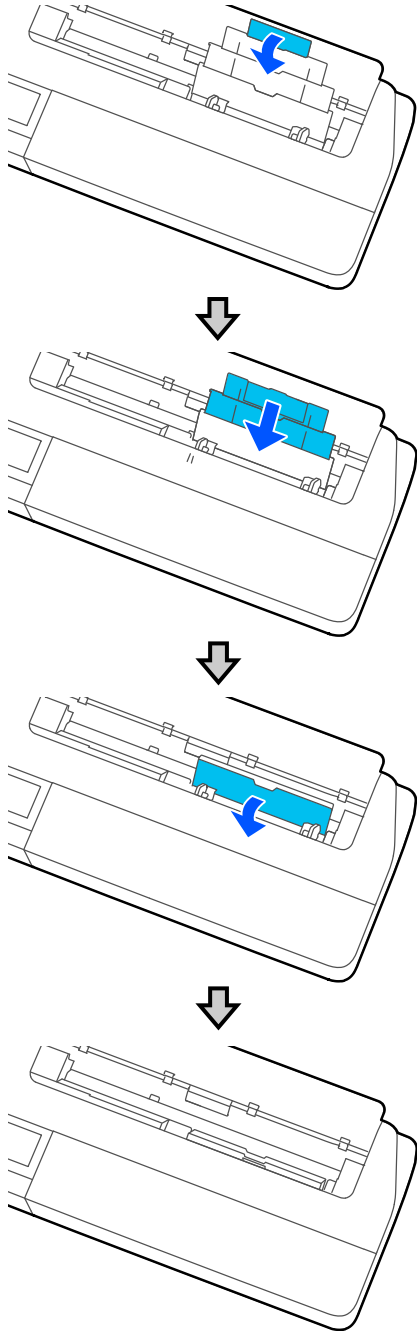

- 3** Close the cut sheet cover.

Loading and Setting the Paper

Loading and Removing Cut Sheet(1 sheet)

Loading Cut Sheet(1 sheet)

When roll paper is loaded, remove it.

 [“Removing Roll Paper” on page 34](#)

If paper is loaded in the auto sheet feeder, remove the paper and stow the auto sheet feeder. Also, make sure you remove the paper stacker if it is installed.

 [“Removing paper from the auto sheet feeder” on page 38](#)

 [“Installing and removing the paper stacker \(for plain paper\)” on page 36](#)

1 Check that **Load paper** is displayed on the Home screen, and then touch **Paper Setting - Cut Sheet(1 sheet)**.

2 Open the cut sheet cover.

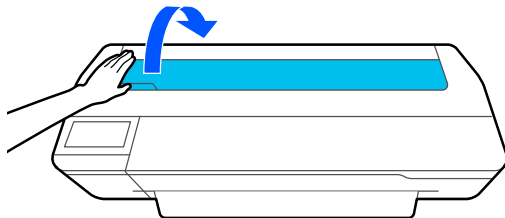

3 With the printable side of the paper facing you, align the right edge of the paper with the right edge mark, and the left edge of the paper with the paper size mark.

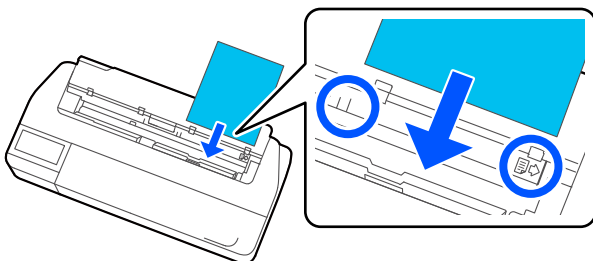

 **Important:**

*Insert all paper in portrait orientation.
Inserting paper in landscape orientation may cause a decline in print quality.*

4 Insert the leading edge of the paper straight into the paper slot until you hear a beep.

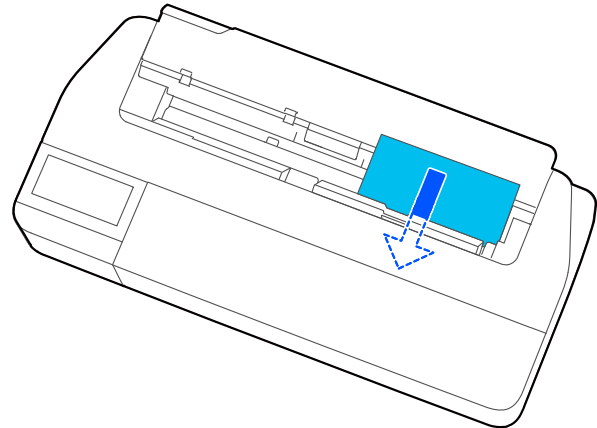

 **Important:**

Hold the edges of the paper and insert it straight into the paper feed slot. Inserting it skewed will cause a skew error or paper jam.

5 On the displayed screen, set the paper type and size that match the loaded paper.

Not setting the appropriate paper type will cause print quality trouble. See the following for more details on the paper types and sizes.

 [“For Auto Sheet Feeder/Cut Sheet\(1 sheet\)” on page 44](#)

Loading and Setting the Paper

! Important:
When paper equivalent to B1 size is loaded in the SC-T5100M Series/SC-T5100 Series/SC-T5100N Series

Raise the B1 width paper support as shown in the figure only when you have loaded B1 width (718 to 738 mm) paper. If you do not raise the B1 width paper support, the print surface may be scuffed or soiled.

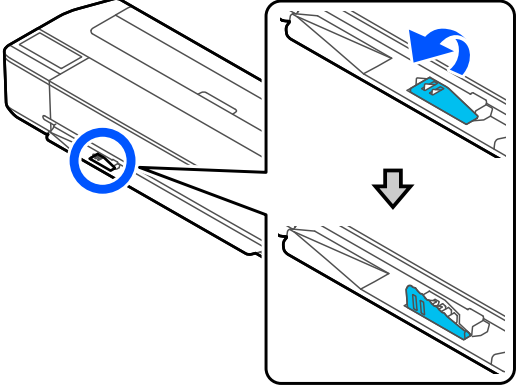

Leave the support lowered when printing to a size other than equivalent to B1 width.

After printing, the paper stops with the trailing edge still held by the printer. If you start printing the next job before removing it manually, it will drop automatically.

- 6** For the SC-T5100M Series/SC-T5100 Series/SC-T3100 Series, check that the paper basket attached to the stand is open.

Removing Cut Sheet (1 Sheet)

When removing unprinted cut sheets

Touch **Paper Setting - Cut Sheet(1 sheet) - Remove** from the Home screen.

The paper is ejected.

When removing printed cut sheets

Grasp the paper with both hands, and pull it out towards you.

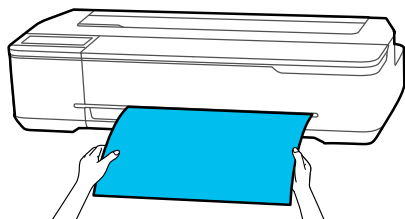

Loading and Setting the Paper

Setting Loaded Paper

For Roll Paper

Configure the following settings after loading roll paper.

Paper Type settings

This is the most important setting to obtain the optimum print results. Not setting a paper type that matches the loaded paper will cause wrinkles, scuffing, uneven colors, and other trouble.

Manage Remaining Amount settings

When Manage Remaining Amount is set to On and the total length of the loaded roll paper has been entered, an estimate of the remaining amount of roll paper is displayed on the printer's Home screen and on the printer driver screen. Furthermore, a notification can also be displayed when the remaining amount has become low.

The remaining amount is saved along with the paper type selected above. For example, you can manage the amount remaining for plain paper and tracing paper separately.

Note:
 When you want to manage the amount remaining when using roll paper with different widths with the same paper type, register one width in Custom Paper Setting. Registering a Custom Paper Setting means adding a new paper type setting. Register the new settings in **Settings - General Settings - Printer Settings - Custom Paper Setting**. For details on Custom Paper Setting, see the following Custom Paper Setting menu.
[🔗 “General Settings - Printer Settings” on page 141](#)

How to Set

- 1 The currently set paper type is shown on the screen displayed after loading roll paper.

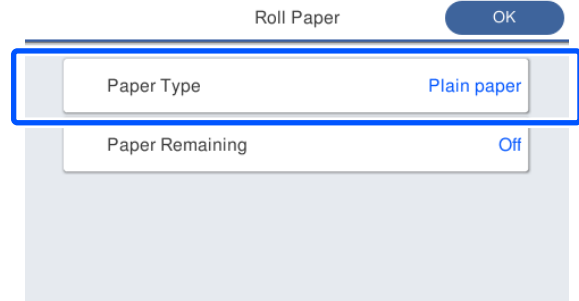

When changing Paper Type

Proceed to step 2.

When setting Paper Remaining without changing Paper Type

Proceed to step 5.

When not changing either of them

Touch **OK**. You can start printing once **Ready** appears on the screen.

Note:
 The settings are confirmed if no operations are performed for 90 seconds on the above screen. To change the settings later, touch the Roll paper information area - **Change Paper Type** from the Home screen and then configure the settings.

- 2 Touch **Paper Type**.
 The following paper type selection screen appears.

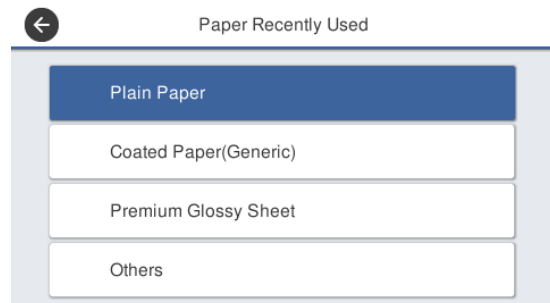

Note:
 The three options other than **Others** display the most recently selected paper type.

Loading and Setting the Paper

3 Select the paper type that matches the loaded roll paper.

Epson Special Media

Select the same product name as the one shown on the package of the paper.

Commercially available non-Epson paper

Select from the following commercially available paper types.

- Plain Paper
- Coated Paper(Generic)
- Photo Paper(Generic)
- Tracing Paper
- Tracing Paper <LowDuty>
- Matte Film
- Blueprint Paper

To select a paper type that is not displayed on the screen, touch **Others**.

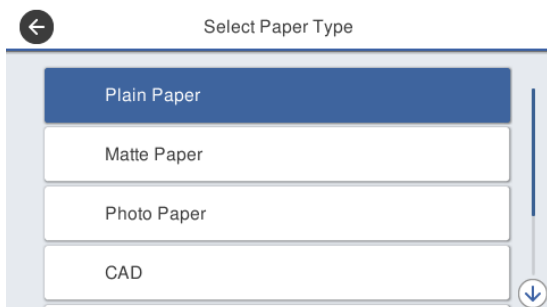

Select a category and select the target paper type.

Note:
If you scroll downward in the category selection screen, **Custom Paper** appears. To select custom paper that has already been registered, touch **Custom Paper**.

4 When a paper type is selected, the screen returns to the one in step 1.

If you will not set the remaining amount management setting, touch **OK**.

5 Touch **Paper Remaining**.

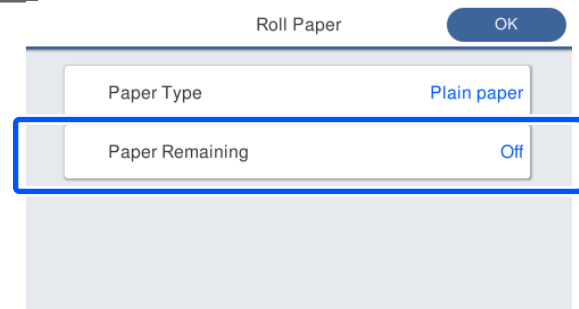

6 Touch **Setup**.

The setting changes to **On**, and **Remaining Amount** and **Remaining Alert** are enabled. Touch each one and enter a value as follows.

- Remaining Amount: Total length of roll paper (see the manual supplied with the roll paper)
- Remaining Alert: Remaining amount value that will be the timing for displaying the remaining amount warning notification.

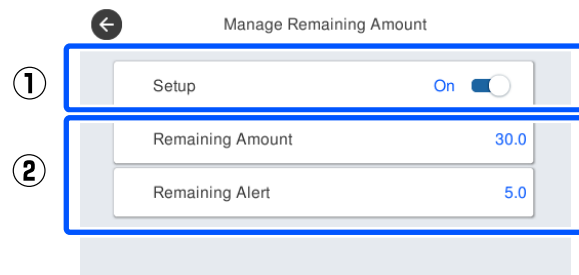

Note:
On the keypad screen for entering a numeric value, enter numbers that include a number of the first decimal place. For example, if you want to enter 5 m, touch [5] and [0].

7 Touch **←** at the top left of the screen to return to the screen of step 5 and then touch **OK**.

You can start printing once **Ready** appears on the screen.

Note:
If you replace the paper after the amount remaining display shows 0 m or the paper has actually run out, **Remaining Amount** returns to the manufacturer's setting of 30m.

Loading and Setting the Paper

For Auto Sheet Feeder/Cut Sheet(1 sheet)

Make the following settings after loading paper in the Auto Sheet Feeder or after loading Cut Sheet(1 sheet).

Settings of Paper Type

This is the most important setting to obtain the optimum print results. Not setting a paper type that matches the loaded paper will cause wrinkles, scuffing, uneven colors, and other trouble.

Settings of Paper Size

The paper size for paper loaded in the auto sheet feeder or for Cut Sheet(1 sheet) is not detected automatically. Set the size of the loaded paper.

How to Set

- 1 The currently set paper type is shown on the screen displayed after loading cut sheet.

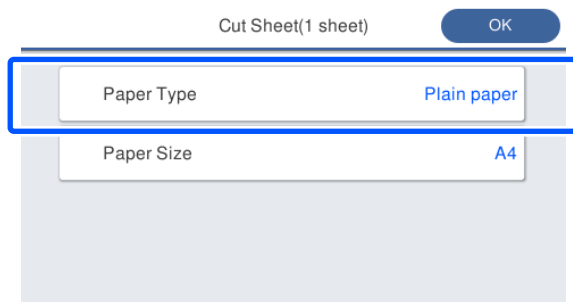

When changing Paper Type

Proceed to step 2.

When changing Paper Size without changing Paper Type

Proceed to step 4.

When not changing either of them

Touch **OK**. You can start printing once **Ready** appears on the screen.

Note:

The settings are confirmed if no operations are performed for 90 seconds on the above screen. To change the settings later, touch the following in order from the Home screen and then configure the settings.

- For Auto Sheet Feeder
Paper Setting - Auto Sheet Feeder - Change Paper Type/Paper Size
- For Cut Sheet(1 sheet)
Paper Setting - Cut Sheet(1 sheet) - Change Paper Type/Paper Size

- 2 Touch **Paper Type**.

The following paper type selection screen appears.

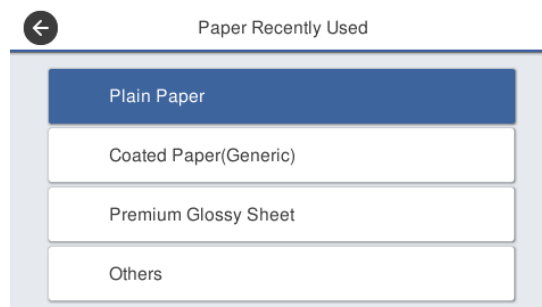

Note:

The three options other than **Others** display the most recently selected paper type.

- 3 Select the paper type that matches the loaded paper.

Epson Special Media

Select the same product name as the one shown on the package of the paper.

Commercially available non-Epson paper

Select from the following commercially available paper types.

- Plain Paper
- Coated Paper(Generic)
- Photo Paper(Generic)
- Tracing Paper
- Tracing Paper <LowDuty>
- Matte Film

Loading and Setting the Paper

❑ Blueprint Paper

To select a paper type that is not displayed on the screen, touch **Others**.

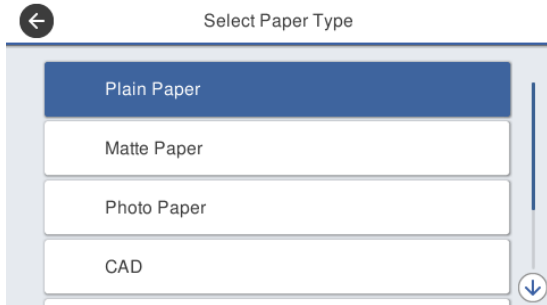

Select a category and select the target paper type. When a paper type is confirmed, the screen returns to the one in step 1.

Note:
If you scroll downward in the category selection screen, **Custom Paper** appears. To select custom paper that has already been registered, touch **Custom Paper**.

4 Touch Paper Size.

If you will not change the paper size, touch **OK**.

For Auto Sheet Feeder

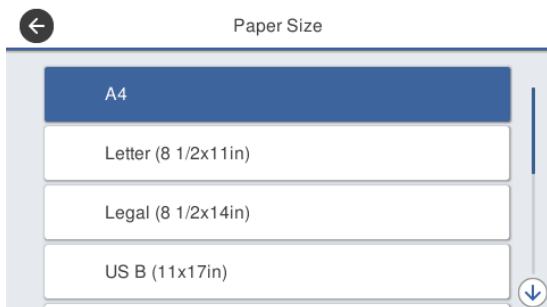

For Cut Sheet(1 sheet)

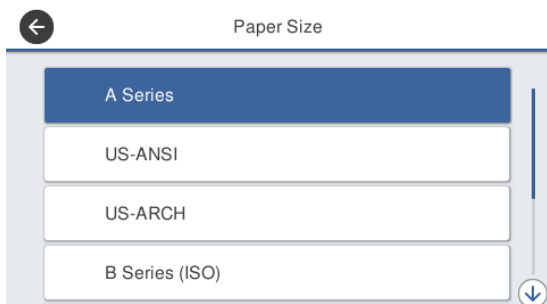

Select a category and select the target paper size.

Note:
Setting non-standard size

For a non-standard size, touch **User-Defined** at the end of the list and then enter the paper width and length.

On the keypad screen for entering a numeric value, enter numbers that include a number of the first decimal place. For example, if you want to enter 5 m, touch [5] and [0].

5 When the screen of step 1 is redisplayed, touch **OK**.

You can start printing once **Ready** appears on the screen.

Loading and Setting the Paper

Optimizing Paper Settings (Media Adjust)

Perform Media Adjust in the following cases. You can make adjustments easily by using the wizard to make sure that your paper prints correctly.

- When there are streaks, double ruled lines, or warped characters in the print results
- When registered with custom paper settings

Adjustment results are saved until the next time you make adjustments. After adjustments are complete, simply select the paper type and the printer will print correctly.

Note:

Adjustment for paper registered with custom paper settings

For roll paper and cut sheets, optimal paper settings will differ even when the paper types are the same. When using roll paper and cut sheets with the same paper type, register the custom paper separately and make adjustments separately.

*Registering a Custom Paper Setting means adding a new paper type setting. Register the new settings in **Settings - General Settings - Printer Settings - Custom Paper Setting**.*

For details on Custom Paper Setting, see the following Custom Paper Setting menu.

[☞ "General Settings - Printer Settings" on page 141](#)

Notes on Making Adjustments

- Correctly load the paper that actually requires adjustment and then select the paper type that matches the loaded paper.
- If paper with visible curls, wrinkles, waves, folds, or bends is used, correct adjustment may not be possible. Remove curled, wavy, or folded sections by cutting them off.

Adjusting

Adjustments are performed by using a wizard. Follow the on-screen instructions to print the adjustment pattern twice.

Adjustments are made by visually checking the pattern and specifying the optimal pattern from the first and second adjustment sheets.

The following shows the length and number of sheets of paper used for adjustment pattern printing.

Roll paper: Approx. 420 mm

Auto sheet feeder: 2 sheets of A4 or A3

Cut sheets: 1 sheet for A2 or larger, 2 sheets for smaller than A2

1

Touch the following in order from the Home screen.

- Roll Paper
Roll paper information area - **Media Adjust**
- Auto Sheet Feeder
Paper Setting - Auto Sheet Feeder - Media Adjust
- Cut Sheet(1 sheet)
Paper Setting - Cut Sheet(1 sheet) - Media Adjust

2

Touch **Start**.

Printing of the first set of adjustment patterns starts.

! Important:

When auto cutting is turned off for cut sheets or roll paper that is A2 size or larger, the paper cannot be removed to perform the second print even when the first print is complete. Do not pull the printed paper.

Note:

A print head nozzle clogging check is performed automatically before adjustment pattern printing. If nozzles are determined to be clogged, cleaning starts and the adjustment patterns will be printed after cleaning finishes.

Loading and Setting the Paper

- 3** Enter the numeric value of the pattern with the least streaks among the printed adjustment patterns of #1 and then touch **Alignment #2**.
In the following example, pattern 0 has the least streaks so you would enter 0.

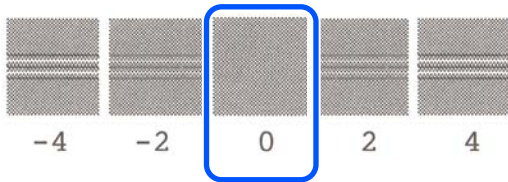

If there is no difference between two adjacent patterns and you are unsure which is the best one to choose, enter the numeric value that comes between them. For example, if you are unsure whether to enter pattern 0 or 2, enter 1.

- 4** Enter the numeric value of the pattern with the least streaks among the adjustment patterns of #2 and #1, and then touch **Alignment #3**.

- 5** Enter the numeric value of the pattern with the most visible straight lines among the adjustment patterns of #3, and then touch **Alignment #4**.
In the following example, pattern 0 has the most straight lines, so you would enter 0.

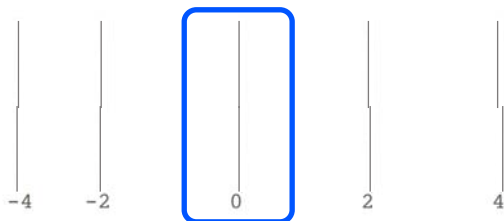

If there is no difference between two adjacent patterns and you are unsure which is the best one to choose, enter the numeric value that comes between them. For example, if you are unsure whether to enter pattern 0 or 2, enter 1.

- 6** In adjustment pattern #4, enter the numeric value of the pattern with the most straight lines in #3 on the screen.

- 7** Touch **OK**.
Printing of the second set of adjustment patterns starts. For cut sheets smaller than A2 size, load the second sheet of paper.

! Important:

When using A2 size or larger cut sheets or roll paper with the auto cut turned off, the part with the first set of patterns printed on it is pulled inside the printer to print the second set of patterns. Do not touch the paper with your hands.

- 8** Enter the numeric value of the pattern with the least streaks among the printed adjustment patterns of #1 and then touch **Alignment #2**.
In the following example, pattern 0 has the least streaks so you would enter 0.

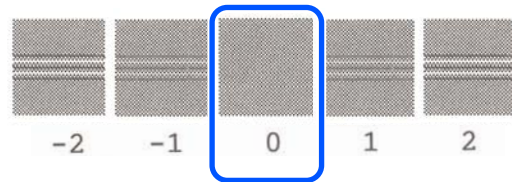

- 9** Enter the numeric value of the pattern with the least streaks among the adjustment patterns of #2 in the same way as #1, and then touch **Alignment #3**.

- 10** Enter the numeric value of the pattern with the least streaks among the adjustment patterns of #3 and then touch **OK**.

In the following example, pattern 0 has the least streaks so you would enter 0.

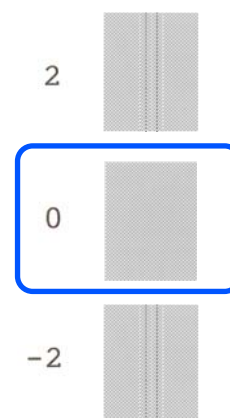

If there is no difference between two adjacent patterns and you are unsure which is the best one to choose, enter the numeric value that comes between them. For example, if you are unsure whether to enter pattern 0 or 2, enter 1.

Loading and Setting the Paper

The adjustment results are saved as settings of the currently selected paper type. Next time, simply select the paper type to realize the optimum print results.

Printing with the Printer Driver from Your Computer

Printing with the Printer Driver from Your Computer

Basic Operating Procedures (Windows)

Printing Procedure

This section describes the basic procedure to print various data, including the data of Word, Excel, and PowerPoint of Microsoft Office and PDFs of Adobe Acrobat, using the printer driver from a computer.

- 1 Turn on the printer, and load the paper.
 - ☞ “Loading Roll Paper” on page 30
 - ☞ “Loading paper into the auto sheet feeder” on page 36
 - ☞ “Loading Cut Sheet(1 sheet)” on page 40

- 2 When you have created the data in the application, click **Print** in the **File** menu.

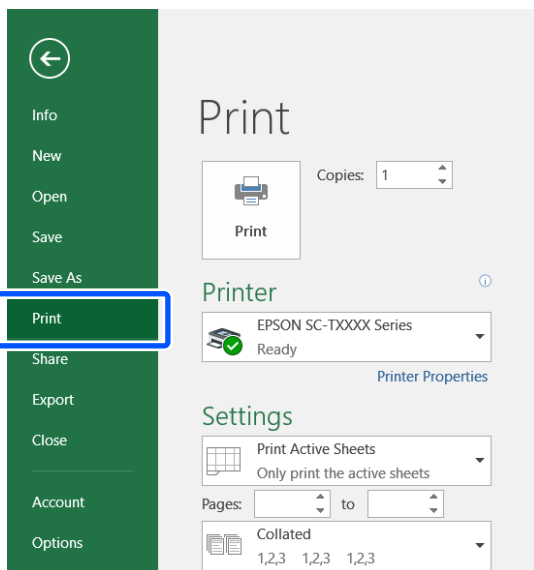

- 3 Select the printer in **Printer** and then click **Printer Properties**.

The printer driver dialog will be displayed.

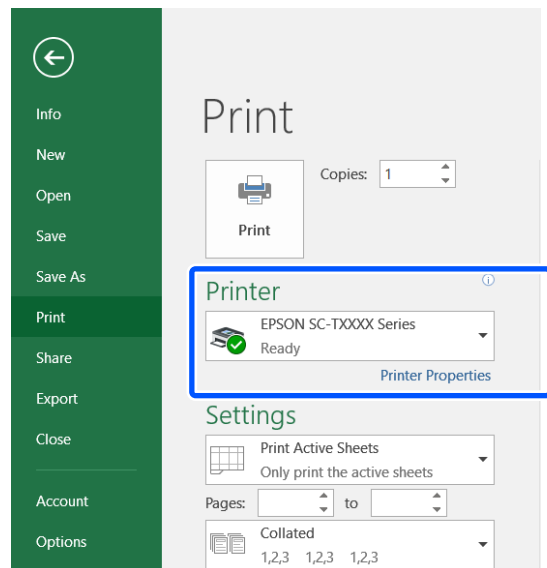

Note:

When printing a PDF file
 In the Print dialog box of Adobe Acrobat, select the **Actual size** (or **Page Scaling: None**) radial button and **Choose paper source by PDF page size** check box. To enlarge or reduce the size, configure the setting in the printer driver settings dialog box.

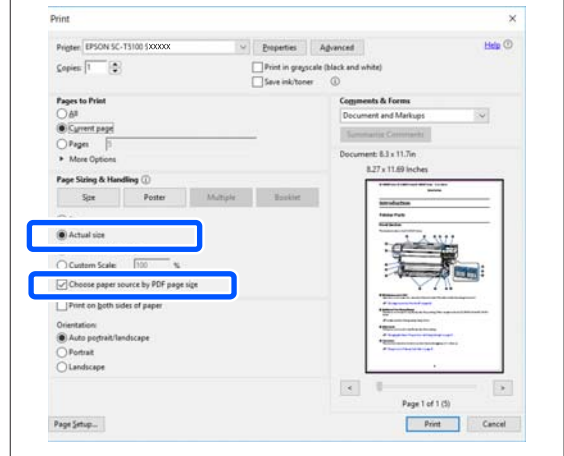

- 4 Check **Document Size** on the Printer Settings tab of the printer driver.

The paper size set in the application is displayed automatically. However, the paper sizes (page sizes) of some applications such as PowerPoint may not be displayed correctly. In such a case, click **Settings...** and specify the size in the displayed Change Paper Size dialog box.

Printing with the Printer Driver from Your Computer

If the desired size is not available in the pull-down menu of the Change Paper Size dialog box, click **Custom Paper Size...** and then set and save a custom size.

 [“Printing at Non-Standard Sizes” on page 67](#)

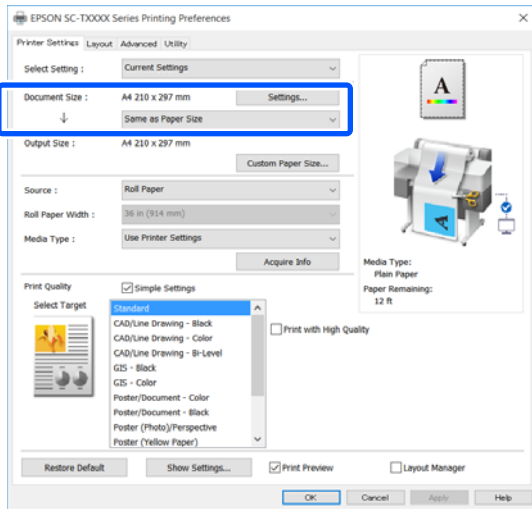

5 Set Output Size.

To enlarge or reduce the size, select from the pull-down menu below the Document Size.

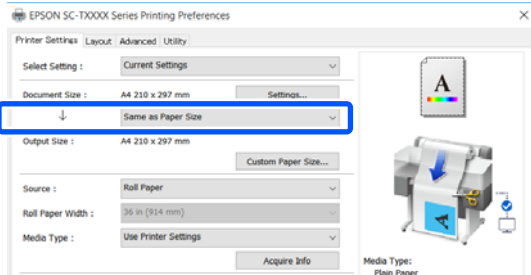

6 Select Source and check the roll paper width and media type.

Select from Roll Paper, Auto Sheet Feeder, or Sheet. If you select a paper source for which paper is not loaded in the printer,  appears.

For Roll Paper Width (Paper Size for cut sheets) and Media Type, the settings configured in the control panel of the printer are applied automatically.

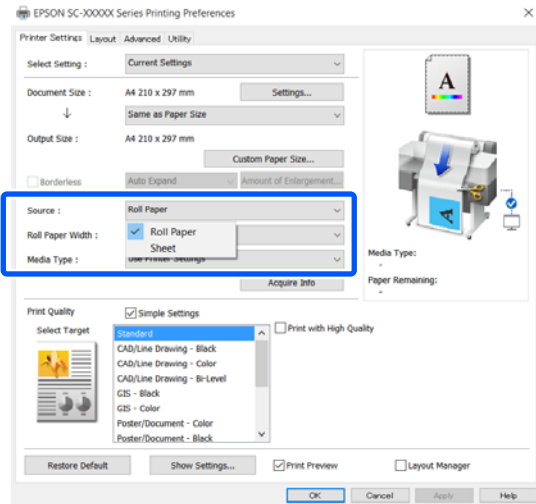

Note:

*If the paper is loaded or changed after opening the printer driver's dialog box, the paper size and paper type settings configured on the printer will not be applied. In this case, click the **Acquire Info** button to apply the settings.*

7 Select Select Target in Print Quality.

Choose an option according to the type of document and how it will be used.

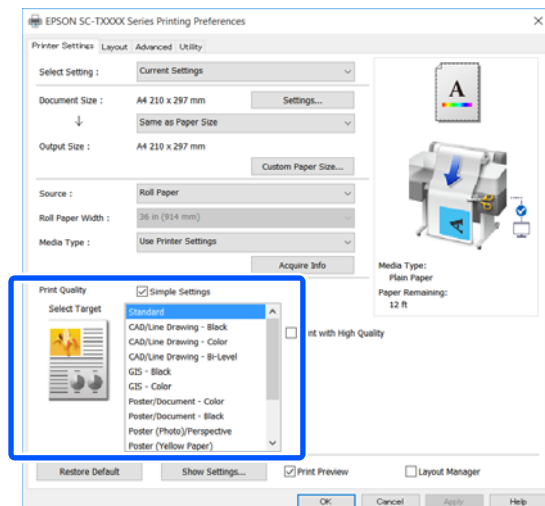

To set the color correction method or color balance in detail to match your preferences, clear the **Simple Settings** check box. See the following for more details.

 [“Correct color and print” on page 71](#)

Printing with the Printer Driver from Your Computer

- 8** Check that the **Print Preview** check box is selected and then click **OK**.

If a preview is not necessary, clear the check box and then click **OK**.

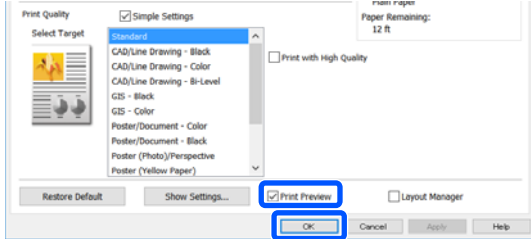

Note:
In the print preview, you can check and change the print settings while viewing the image to be actually printed. We recommend to check with the preview when printing on roll paper or large-sized paper.

- 9** Click **Print** in the Print dialog box of the application.

The print preview screen appears.

- 10** Check the print settings in the print preview screen, and if there is no problem, click **Print** to start printing.

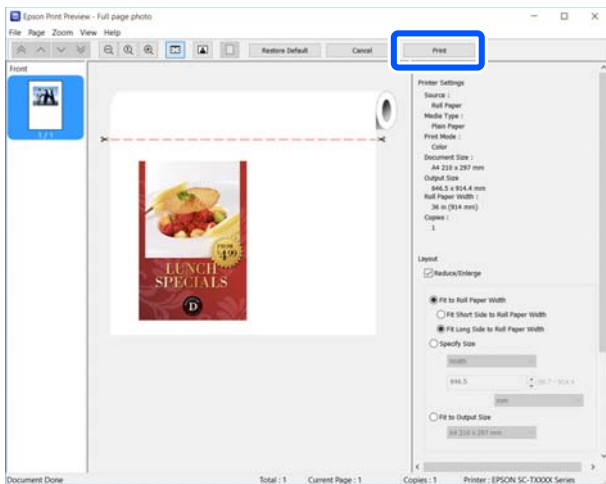

The icons and menus at the top of the preview screen allow you to change the image display settings. You can change the print settings using the menus on the right side. See the help for more details.

Note:
See the printer driver help for more details on setting items. You can display the help in the following two ways:

- Click **Help** at the bottom right of the screen.
- Right-click the item you want to check and then click **Help**. (This is not possible in the print preview screen.)

Canceling Printing

There are a few ways to stop printing operations depending on the situation. When the computer has finished sending data to the printer, you cannot cancel the print job from the computer. Cancel on the printer.

Canceling from a Computer

When the Progress Bar is displayed

Click **Cancel**.

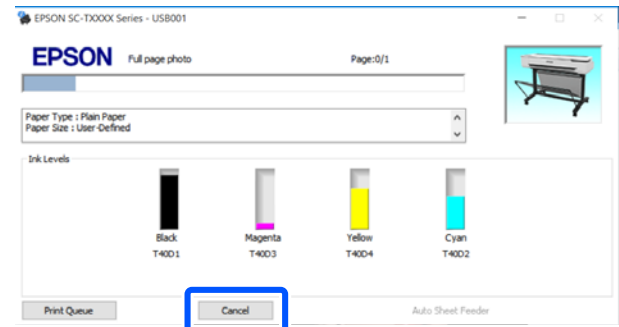

When the Progress Bar is not displayed

- 1** Click the printer icon on the taskbar.



Whether or not an icon is displayed depends on the settings selected for Windows.

Printing with the Printer Driver from Your Computer

- 2** Select the print data you want to cancel and click **Cancel** in the **Document** menu.

To cancel all print data, click **Cancel All Documents** in the **Printer** menu.

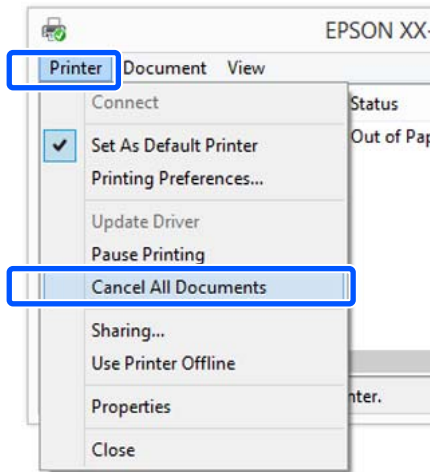

If the job has been sent to the printer, print data is not displayed on the above screen.

Canceling on the printer

The **Cancel** button is displayed on the control panel screen during printing. Touch the **Cancel** button. The print job is canceled even in the middle of printing. It may take a while before the printer returns to the ready status.

However, print jobs in the print queue on a computer cannot be deleted in this way. Use the procedure of "Canceling from a Computer" to delete print jobs in the print queue.

Customizing the Printer Driver

You can save the settings or change the display items as you prefer.

Saving Frequently Used Settings

If you start the printer driver from the Control Panel, change the settings to those you use frequently, and then save the settings, the printer driver's dialog box will be displayed with the saved settings from any application that it is displayed.

- 1** Open **View devices and printers** or **Devices and Printers**.

Windows 10/8.1/8/7

Click in the following order: **Hardware and Sound** (or **Hardware**) > **View devices and printers** (or **Devices and Printers**).

Windows Vista

Click in the following order: **Hardware and Sound** and then **Printer**.

Windows XP

Click in the following order: **Printers and Other Hardware**, and then **Printers and Faxes**.

Note:

If your Windows XP Control Panel is in **Classic View**, click **Start**, **Control Panel**, and then **Printers and Faxes**.

- 2** Right-click your printer icon, and click **Printing preferences**.

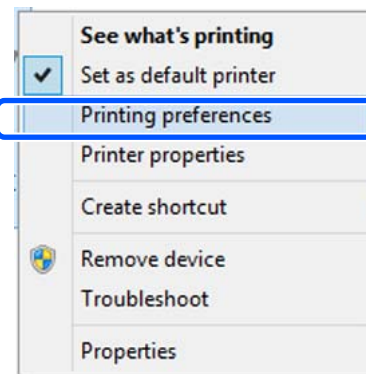

- 3** The printer driver setting screen is displayed.

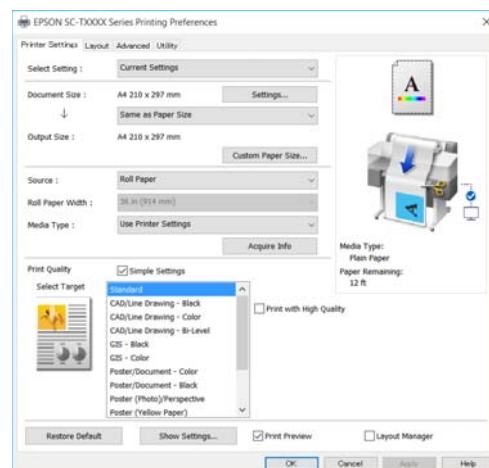

Printing with the Printer Driver from Your Computer

Make the necessary settings. These settings become the default settings of the printer driver.

Saving various settings as your Select Settings

You can save all printer driver settings as a Select Setting. This allows you to easily load settings that have been stored in Select Settings, and repeatedly print using exactly the same settings.

1 Set each item on the Printer Settings, Layout, and Advanced tabs to the settings you want to save as Select Settings.

2 Click **Custom Settings**.

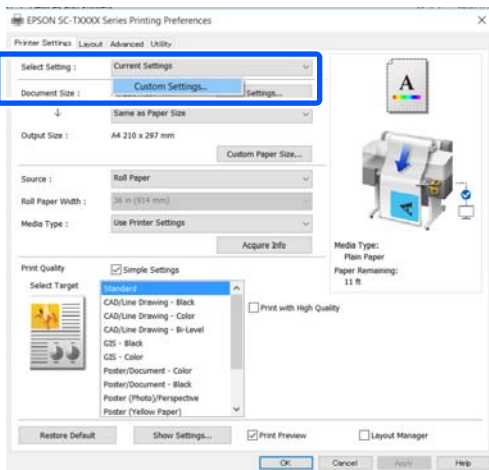

3 Enter the desired name in **Name**, and then click **Save**.

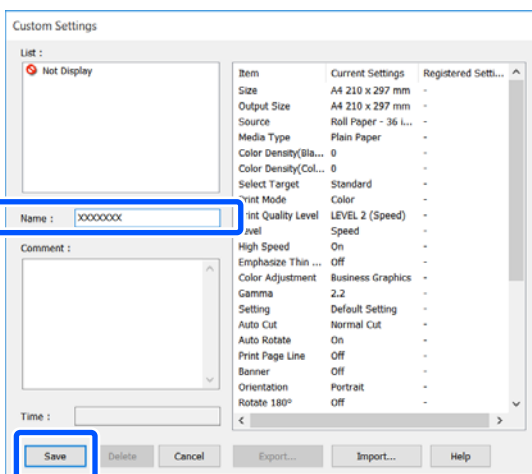

You can save up to 100. The saved select settings can be recalled from **Select Setting**.

Note:

Sharing Select Setting settings with multiple computers

Select the settings you want to share, click **Export...**, and then export the settings to a file. Display the same screen of the printer driver on another computer, click **Import...**, and then import the settings.

Rearranging display items

The display items of **Select Setting**, **Media Type**, and **Paper Size** can be arranged as follows to display the ones you use normally right away.

- Hide unnecessary items.
- Rearrange in an order of most frequent use.
- Arrange in groups (folders).

1 Click **Utility** tab - **Menu Arrangement**.

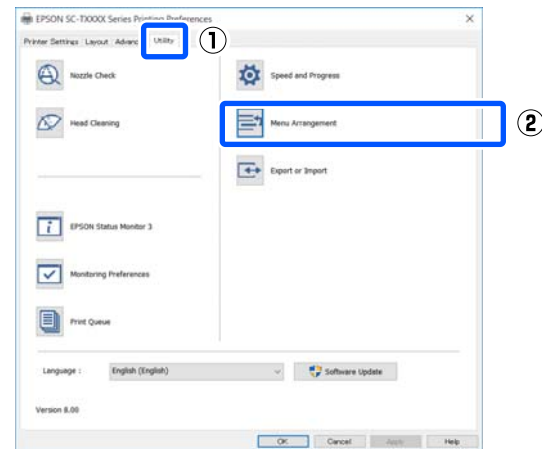

Printing with the Printer Driver from Your Computer

2 Select **Edit Item**.

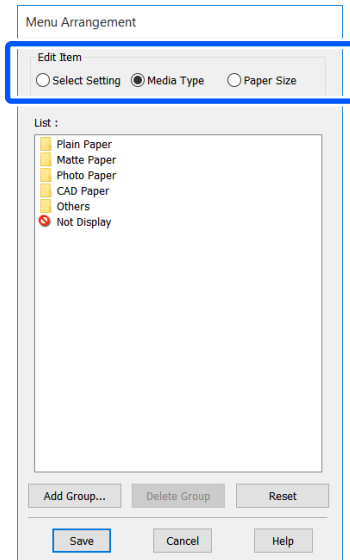

4 Click **Save**.

3 Change the display order and groups in **List**.

- ❑ You can move and order items by dragging and dropping.
- ❑ To add a new group (folder), click **Add Group...**
- ❑ To delete a group (folder), click **Delete Group**.
- ❑ Drag and drop unnecessary items to **Not Display**.

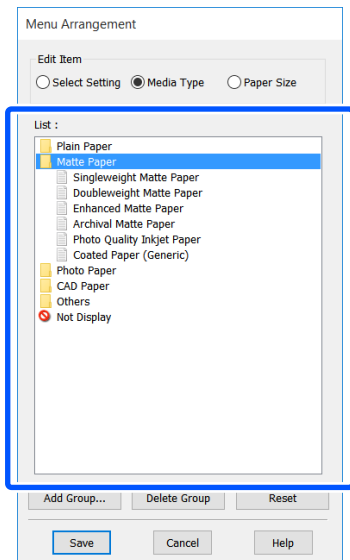

Note:

When **Delete Group** is performed, the group (folder) is deleted, but the settings in the deleted group (folder) remain. Delete them individually from **List** in the save location.

Printing with the Printer Driver from Your Computer

Basic Operating Procedures (Mac)

Printing Procedure

This section describes the basic procedure to print using the printer driver from a computer.

Basic Printing Procedure

- 1 Turn on the printer, and load the paper.
 - ☞ “Loading Roll Paper” on page 30
 - ☞ “Loading paper into the auto sheet feeder” on page 36
 - ☞ “Loading Cut Sheet(1 sheet)” on page 40
- 2 When you have created the data in the application, click **Print** in the **File** menu.

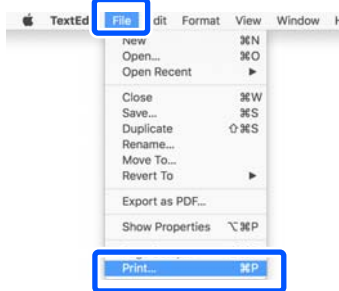

- 3 Click **Show Details** (or ) at the bottom of the screen.

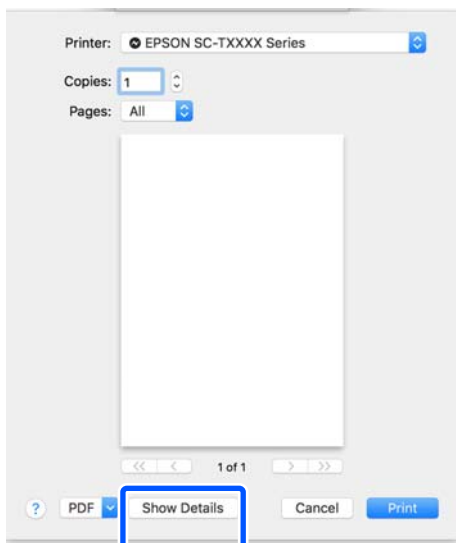

Note:

If page settings are not displayed in the print dialog, click the "page settings" option (e.g., **Page Setup**) in the **File** menu.

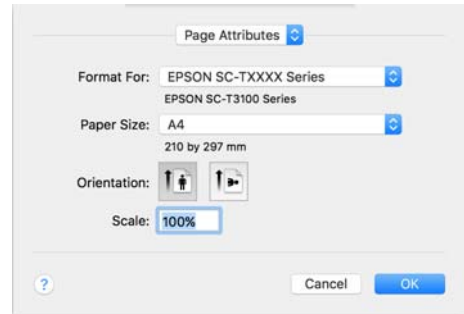

- 4 Check that this printer is selected, and then set the paper size.

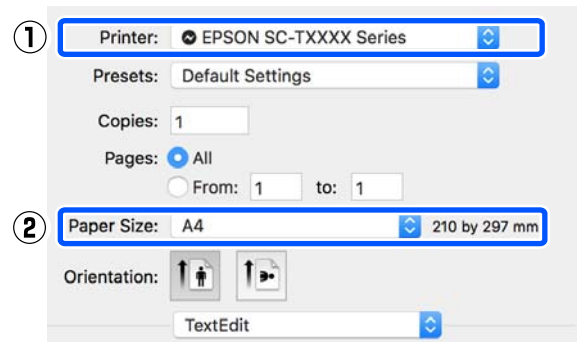

There are three options available for each paper size. For example, if you click A2, the following three options are displayed.

- A2
- A2 (Retain Scale)
- A2 (Roll Paper Banner)

Normally, you should select the option without parenthesis (A2 in the example above). Select one of the other two options in the following situations.

Retain Scale

In the following procedure, the PDF or image data may be printed at a slightly reduced size even if the output size is **Same as Paper Size**. This is done to secure the necessary margins (3 mm on each side) for this printer. Select this when you want to print at the full size without any reduction.

Roll Paper Banner

Select to make long prints on roll paper using banner printing software.

Printing with the Printer Driver from Your Computer

5 Select **Printer Settings** from the list and set **Output Size**.

If **Printer Settings** is not displayed in the list, the dedicated printer driver for this printer has not been added. See the following and then add the printer driver.

 [“How to Select the Dedicated Printer Driver for This Printer” on page 57](#)

To enlarge or reduce the size, select from the pull-down menu below the Paper Size.

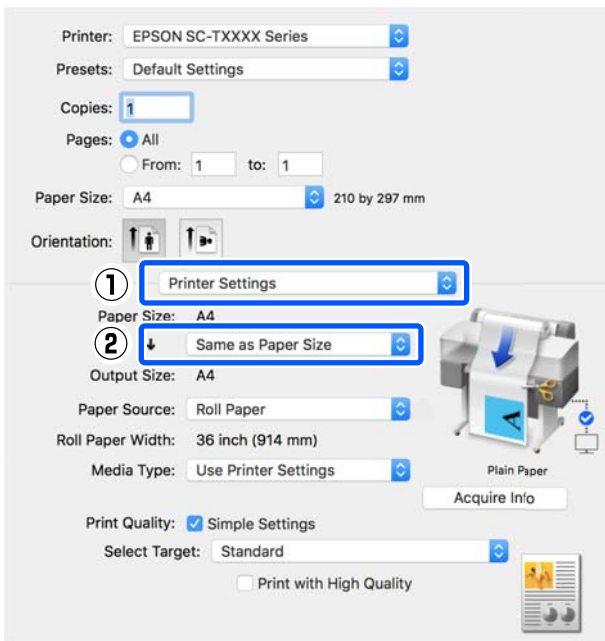

See the following for more details on enlargement settings.

 [“Enlargements and Horizontal and Vertical Banners” on page 62](#)

6 Select Source and check the roll paper width (paper size when cut sheet) and paper type.

Select from Roll Paper, Sheet, or Auto Sheet Feeder. If you select a paper source for which paper is not loaded in the printer,  appears.

For Roll Paper Width (Paper Size for cut sheets) and Media Type, the settings configured in the control panel of the printer are applied automatically.

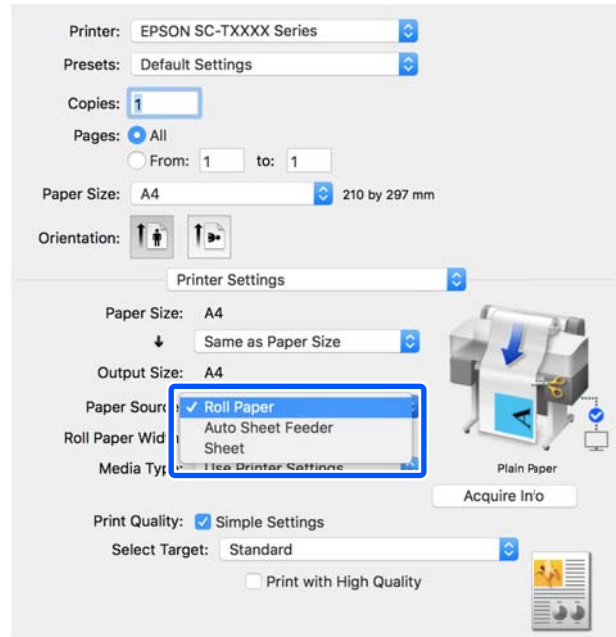

Note:

*If the paper is loaded or changed after opening the printer driver's dialog box, the paper size and paper type settings configured on the printer will not be applied. In this case, click the **Acquire Info** button to apply the settings.*

Printing with the Printer Driver from Your Computer

- 7** Select **Select Target** in **Print Quality**.
Choose an option according to the type of document and how it will be used.

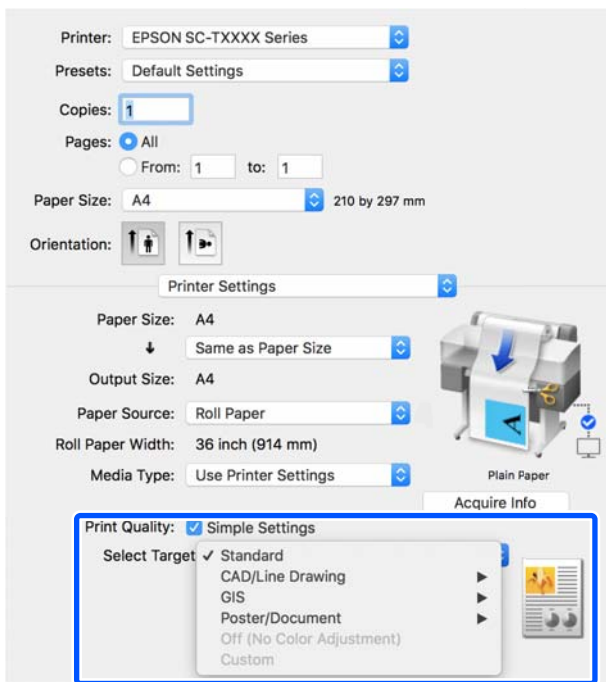

To set the color correction method or color balance in detail to match your preferences, clear the **Simple Settings** check box. See the following for more details.

[“Correct color and print” on page 71](#)

- 8** Check that the **Print Preview** check box is selected and then click **Print**.
If a preview is not necessary, clear the check box and then click **Print**.

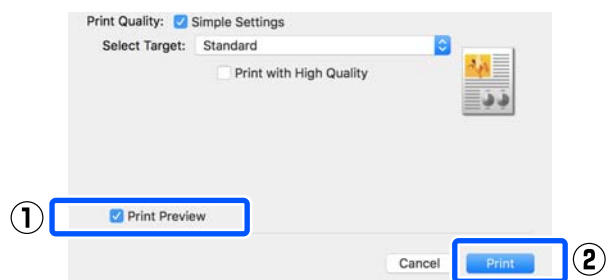

Note:
In the print preview, you can check and change the print settings while viewing the image to be actually printed. We recommend to check with the preview when printing on roll paper or large-sized paper.

- 9** Check the print settings in the print preview screen, and if there is no problem, click **Print** to start printing.

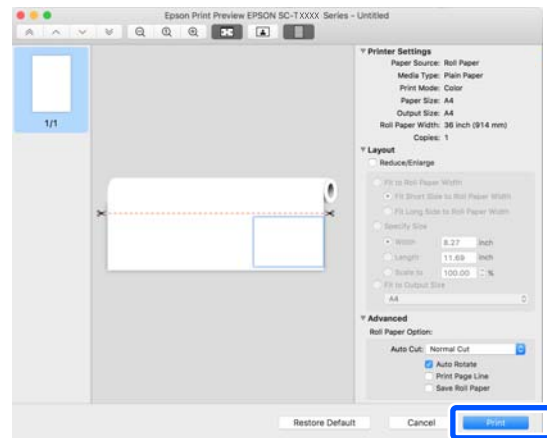

The icons and menus at the top of the preview screen allow you to change the image display settings. You can change the print settings using the menus on the right side. See the help for more details.

Note:
See the printer driver help for more details on setting items. Click in the printer driver settings dialog box to display Help.

How to Select the Dedicated Printer Driver for This Printer

If the menus described in the previous section "Basic Printing Procedure" are not displayed, select the dedicated printer driver for the printer in **Printer**. The dedicated printer driver for this printer is displayed as follows.

- For USB connections EPSON SC-TXXXX
- For network connections EPSON TXXXX or EPSON TXXXX-YYYYYY

*: "XXXX" is the product model number. "YYYYYY" is the last six digits of the MAC address.

If the dedicated printer driver for this printer is not displayed in the list, add it with the following procedure.

- 1** Select **System Preferences - Printers & Scanners** (or **Print & Scan / Print & Fax**) from the Apple menu.

Printing with the Printer Driver from Your Computer

- 2 Click [+] and select **Add Printer or Scanner**.
- 3 When the list of devices appears, select the dedicated printer driver for this printer and click **Add**.

Canceling Printing

There are a few ways to stop printing operations depending on the situation. When the computer has finished sending data to the printer, you cannot cancel the print job from the computer. Cancel on the printer.

Canceling from a Computer

- 1 Click the icon of this printer in the Dock.



- 2 Select the job you want to cancel, and then click **Delete**.

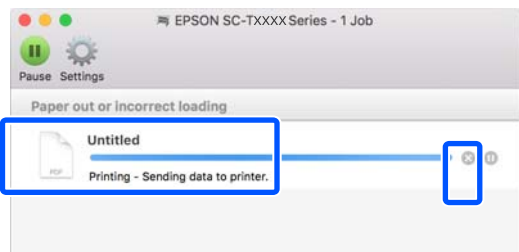

If the job has been sent to the printer, print data is not displayed on the above screen.

Canceling on the printer

The **Cancel** button is displayed on the control panel screen during printing. Touch the **Cancel** button. The print job is canceled even in the middle of printing. It may take a while before the printer returns to the ready status.

However, print jobs in the print queue on a computer cannot be deleted in this way. Use the procedure of "Canceling from a Computer" to delete print jobs in the print queue.

Customizing the Printer Driver

You can assign a name to frequently used setting information (paper size and each item of the basic settings) and then save the information to **Presets**. This allows you to easily load settings and repeatedly print using exactly the same settings.

Saving frequently used settings as a preset

- 1 Set each item on the Paper Size and Printer Settings tabs to the settings you want to save as Presets.

- 2 Click **Save Current Settings as Preset** in **Presets**.

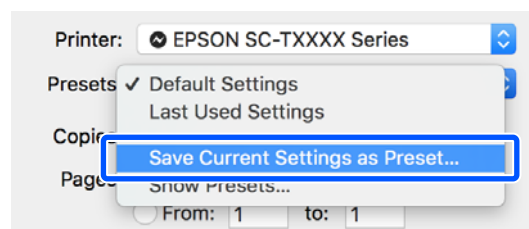

- 3 Enter a name, and then click **OK**.

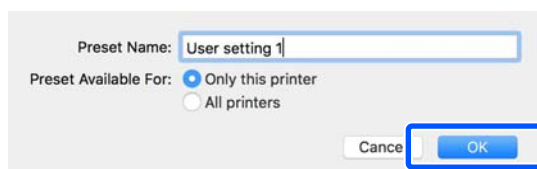

Note:
When **All printers** is selected from **Preset Available For**, you can select the saved **Presets** from all printer drivers installed on your computer.

The settings are saved to **Presets**. You can then select the settings you saved from **Presets**.

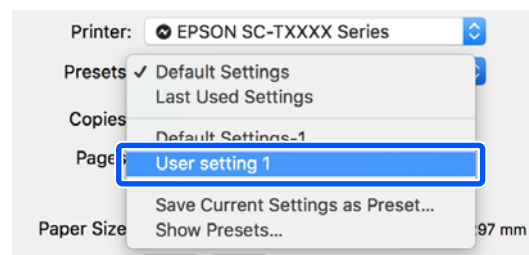

Printing with the Printer Driver from Your Computer

Deleting from presets

- 1 Click **Show Presets...** from **Presets** in the Print dialog box.

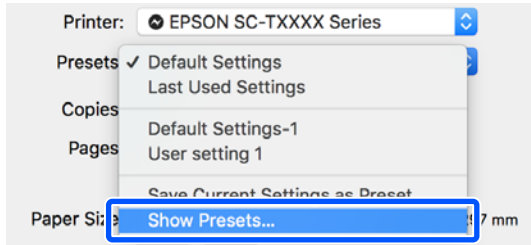

- 2 Select the setting you want to delete, click **Delete**, and then click **OK**.

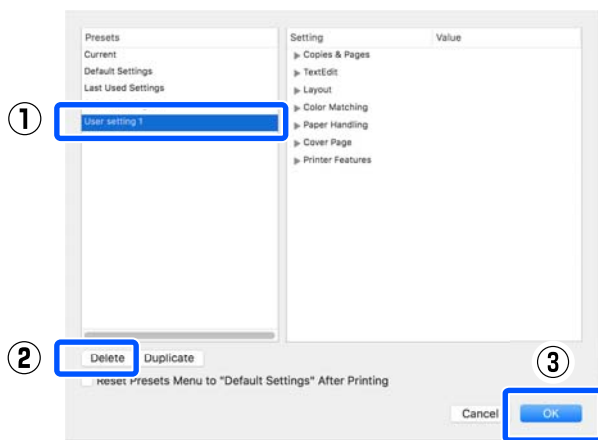

Printing with the Printer Driver from Your Computer

Printing CAD Drawings

There are the following two methods to print CAD drawings.

Printing with the printer driver

This method is best suited for printing CAD drawings such as the appearance views of buildings at high quality. This section describes the procedure to print using the printer driver from AutoCAD 2018.



Important:

If lines or parts in your drawing are not printed properly, print using the HP-GL/2 or HP RTL mode.

Printing using the HP-GL/2 or HP RTL mode

This method is best suited for printing CAD and GIS drawings such as maps and blueprints.

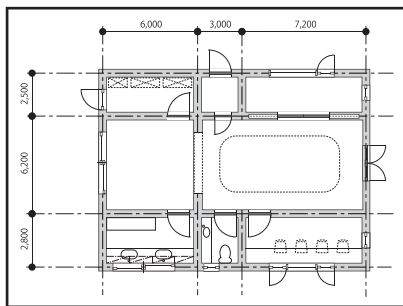

You can print from an application that supports HP-GL/2 (compatible with HP Designjet 750C) and HP RTL. See the following for more details.

[“Printing Using the HP-GL/2 or HP RTL Mode from a Computer” on page 94](#)

1 Open the data to be printed and then click **Plot**.

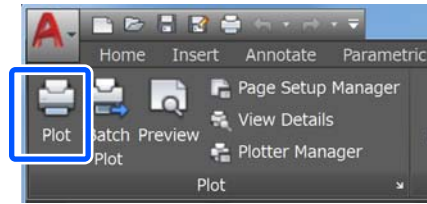

2 Select the printer in **Printer/plotter** and then click **Properties**.

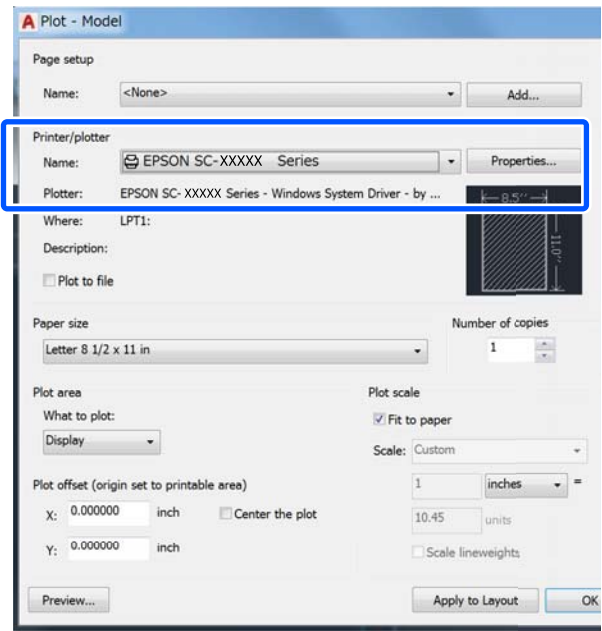

3 Click **Custom Properties**.

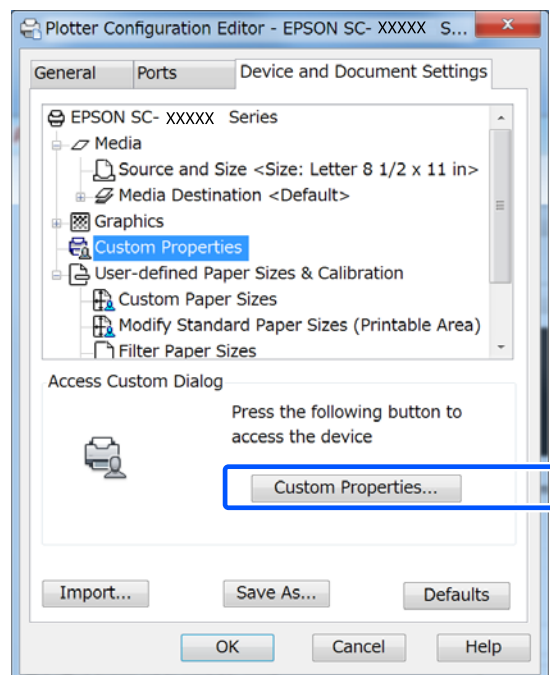

Printing with the Printer Driver from Your Computer

The printer driver's dialog box for this printer appears.

4 Set Output Size and Source in the printer driver.

☞ “Basic Operating Procedures (Windows)” on page 49

☞ “Basic Operating Procedures (Mac)” on page 55

5 Select **CAD/Line Drawing - Black**, **CAD/Line Drawing - Color**, or **CAD/Line Drawing - Bi-Level** from the **Select Target** list.

Windows

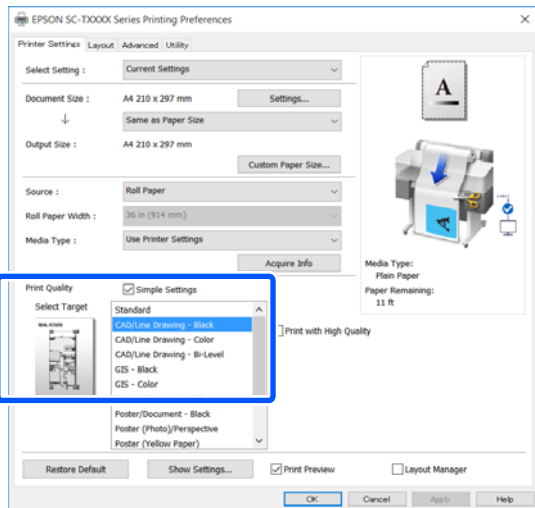

Mac

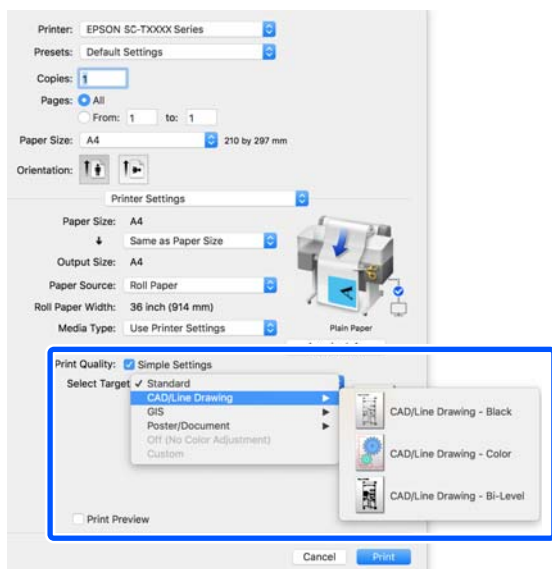

6

Check other settings, and then start printing.

Note:

*If the output size is portrait and the height is smaller than the width of the roll paper, the print image is printed rotated 90° to save paper. This function is enabled if the **Auto Rotate** check box is selected in **Roll Paper Option** on the **Advanced** tab.*

Printing with the Printer Driver from Your Computer

Enlargements and Horizontal and Vertical Banners

The printer driver can enlarge or reduce documents for different paper sizes. There are three setting methods.

Before printing at non-standard sizes, including vertical or horizontal banners and documents with equal sides, enter the desired paper size in the printer driver.

"Printing at Non-Standard Sizes" on page 67

- Fit to Roll Paper Width**
Automatically enlarges or reduces the image size to fit the roll paper width.

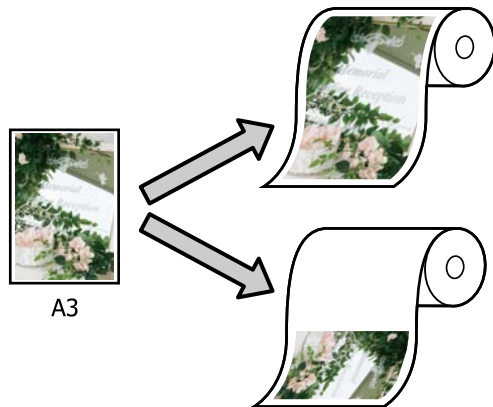

- Fit to Output Size**
Automatically enlarges or reduces the image size to fit the paper size.

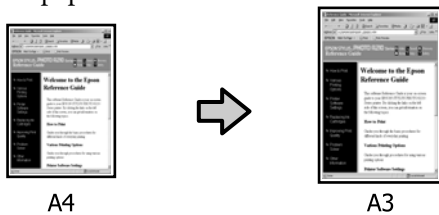

- Specify Size**
You can specify the enlargement or reduction ratio. Use this method for a non-standard paper size.

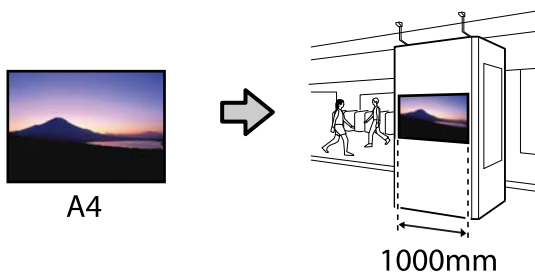

Note:

- When printing from applications designed expressly for horizontal or vertical banners, adjust printer driver settings as described in the application documentation.
- When using a Windows application designed for banners, select **Print Banner** on the Layout tab if necessary.

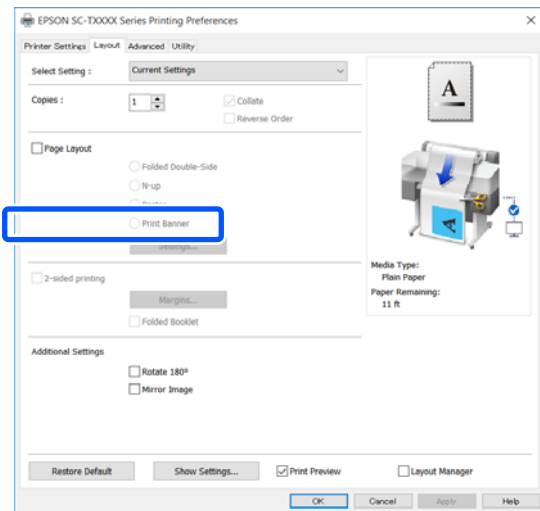

Fitting Documents to the Width of the Roll Paper

- 1 Check the document size (or paper size) setting on the Printer Settings tab of the printer driver.

Windows

Display the Printer Settings tab of the printer driver from the application and check that the document size is the same as the setting of the application.

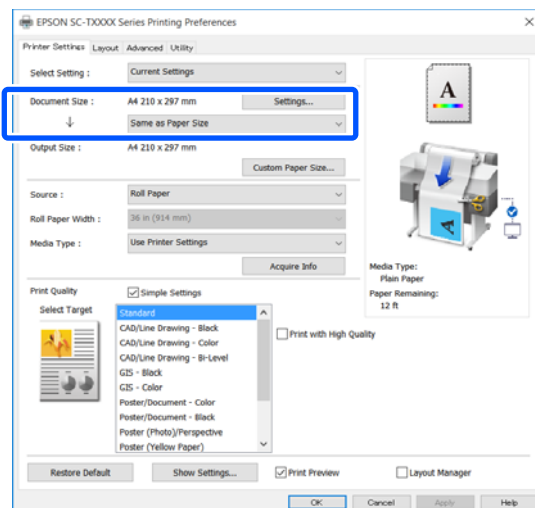

Printing with the Printer Driver from Your Computer

If it differs, click **Settings...** and specify the correct size in the Change Paper Size dialog box.

[“Basic Operating Procedures \(Windows\)” on page 49](#)

Mac

Open the page setup screen of the application and check that this printer is selected in **Printer** and check the paper size.

Select a paper size that does not have (Retain Scale) or (Roll Paper Banner).

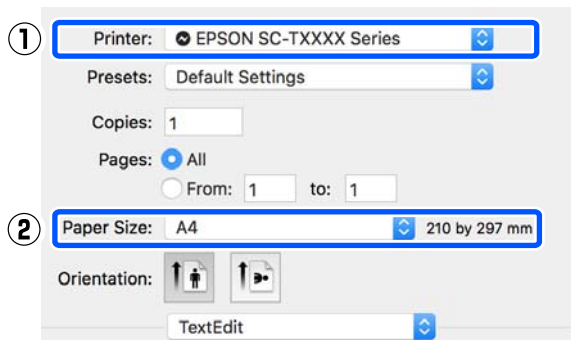

If the size is different, select the correct size from the pull-down menu.

[“Basic Operating Procedures \(Mac\)” on page 55](#)

Note:

*In the case of an application without a page setup menu item, you can set the paper size if you open the Print dialog box from the **Print** menu item.*

- Click **Fit to Roll Paper Width** on the Printer Settings tab of the printer driver and select either **Fit Short Side to Roll Paper Width** or **Fit Long Side to Roll Paper Width**.

Windows

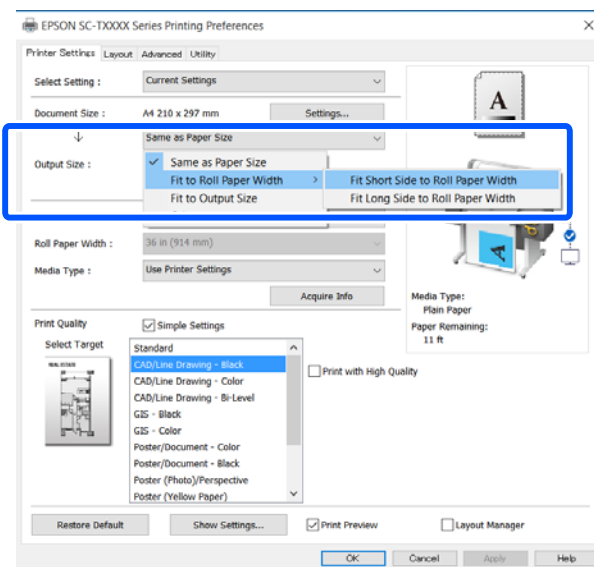

Mac

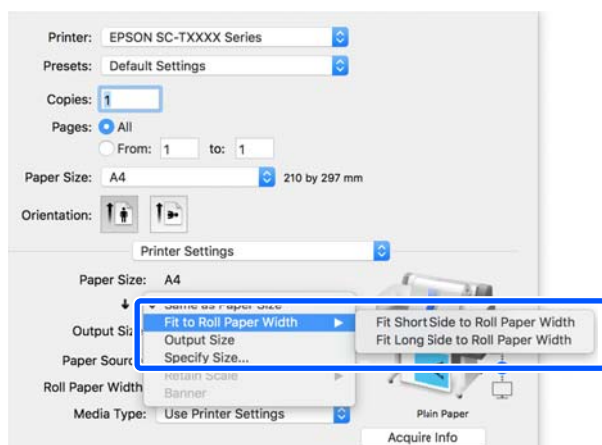

Fit Short Side to Roll Paper Width

Select this when you want to print with the print image enlarged to the maximum size for the loaded roll paper.

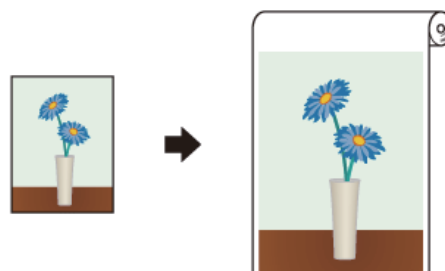

Printing with the Printer Driver from Your Computer

Fit Long Side to Roll Paper Width

Select this when you want to print with the print image enlarged as much as possible to the extent that paper will not be wasted.

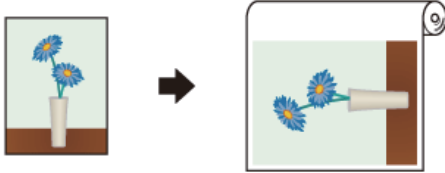

- 3 Check other settings, and then start printing.

Fitting Documents to the Output Size

- 1 Check the document size (or paper size) setting on the Printer Settings tab of the printer driver.

Windows

Display the Printer Settings tab of the printer driver from the application and check that the document size is the same as the setting of the application.

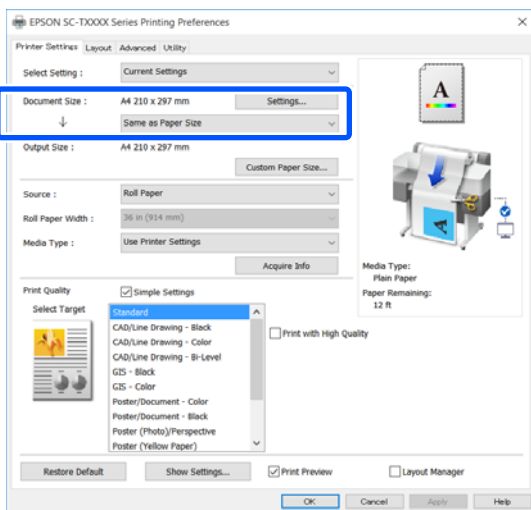

If it differs, click **Settings...** and specify the correct size in the Change Paper Size dialog box.

➤ “Basic Operating Procedures (Windows)” on page 49

Mac

Open the page setup screen of the application and check that this printer is selected in **Printer** and check the paper size.

Select a paper size that does not have (Retain Scale) or (Roll Paper Banner).

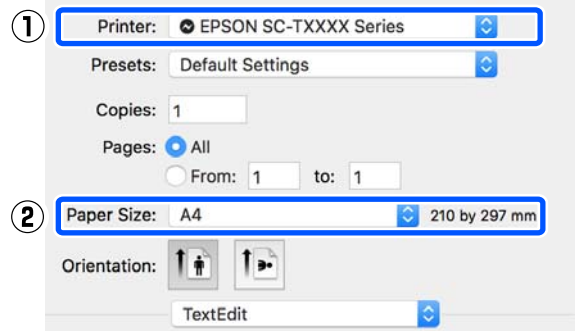

If the size is different, select the correct size from the pull-down menu.

➤ “Basic Operating Procedures (Mac)” on page 55

- 2 Select **Fit to Output Size** on the Printer Settings tab of the printer driver.

Windows

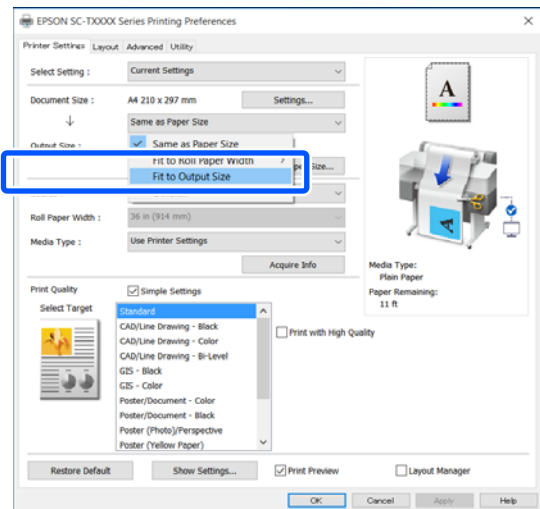

Printing with the Printer Driver from Your Computer

Mac

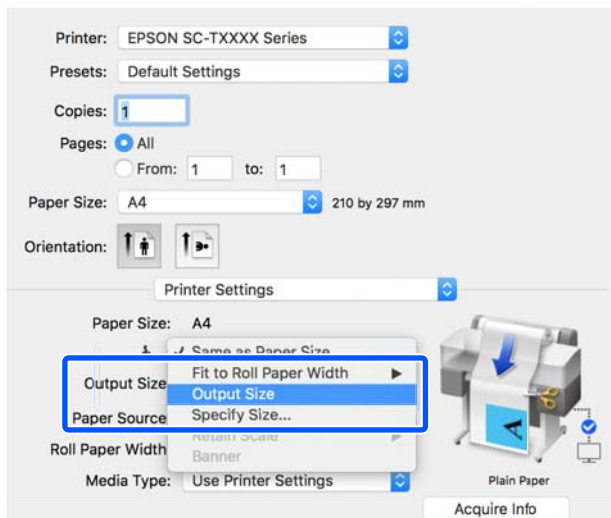

- 3 Select the desired size from the **Output Size** pull-down menu.

Windows

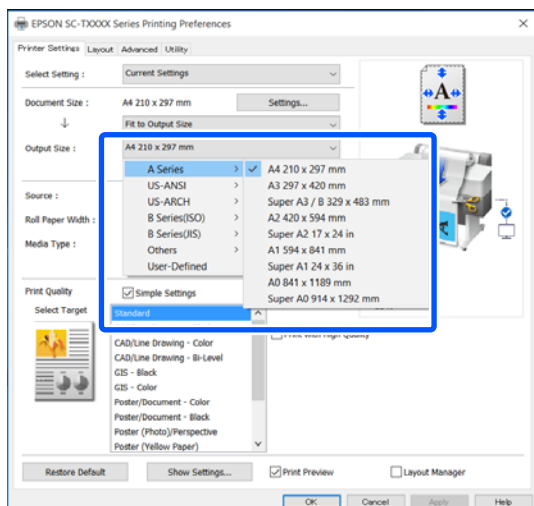

Mac

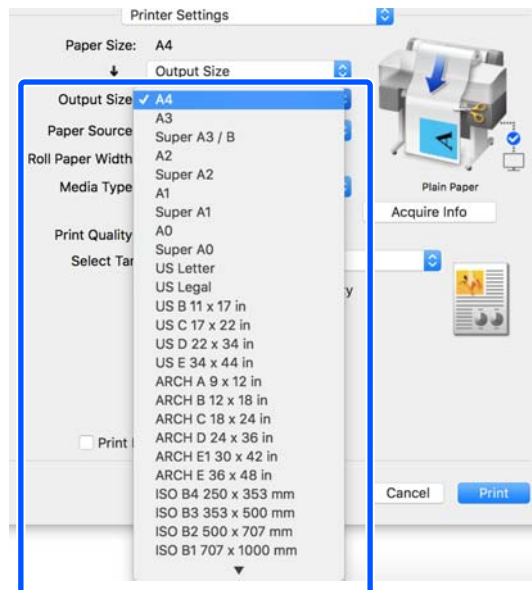

- 4 Check other settings, and then start printing.

Choosing a Print Size

- 1 Check the document size (or paper size) setting on the Printer Settings tab of the printer driver.

Windows

Display the Printer Settings tab of the printer driver from the application and check that the document size is the same as the setting of the application.

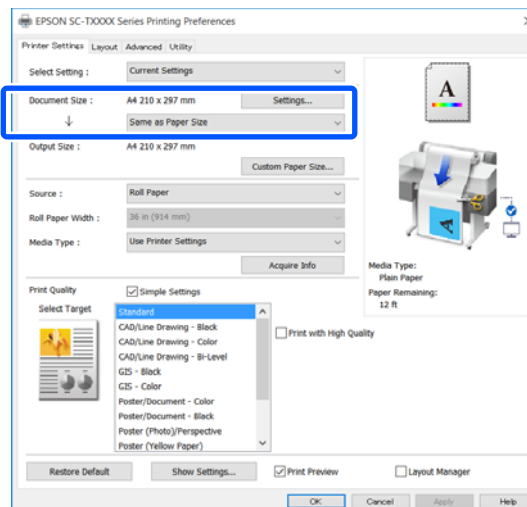

If it differs, click **Settings...** and specify the correct size in the Change Paper Size dialog box.

Printing with the Printer Driver from Your Computer

☞ “Basic Operating Procedures (Windows)” on page 49

Mac

Open the page setup screen of the application and check that this printer is selected in **Printer** and check the paper size.

Select a paper size that does not have (Retain Scale) or (Roll Paper Banner).

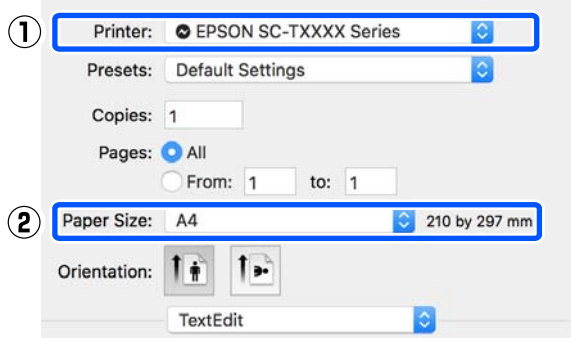

If the size is different, select the correct size from the pull-down menu.

☞ “Basic Operating Procedures (Mac)” on page 55

Note:

*In the case of an application without a page setup menu item, you can set the paper size if you open the Print dialog box from the **Print** menu item.*

2 Display the Output Size input screen from the Printer Settings tab of the printer driver.

Windows

Select **Others...** and then select **Specify Size** in the displayed Output Size dialog box.

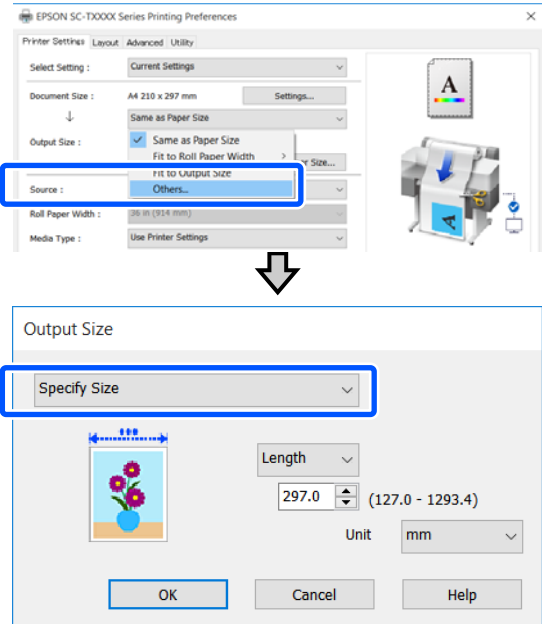

Mac

Select **Specify Size**.

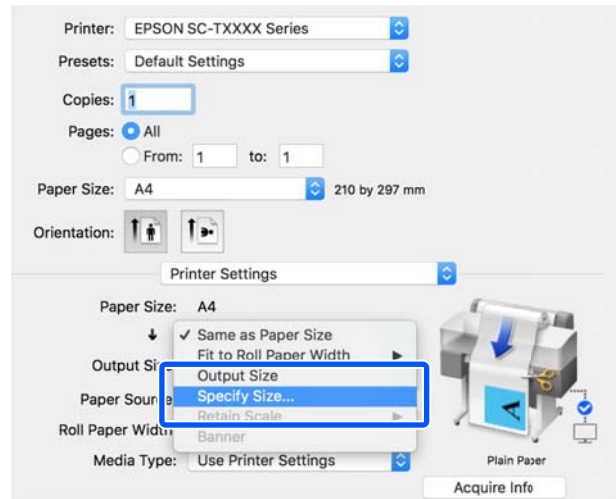

3 Select the size specification method from Width, Length, and Scale to and then enter the setting value.

The print image is enlarged or reduced so that it becomes the specified width, length, or scale while maintaining the aspect ratio of the print data.

Printing with the Printer Driver from Your Computer

Windows

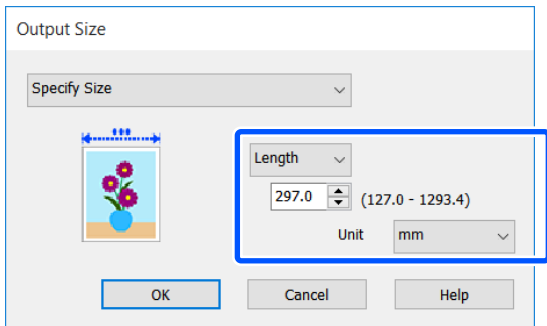

Mac

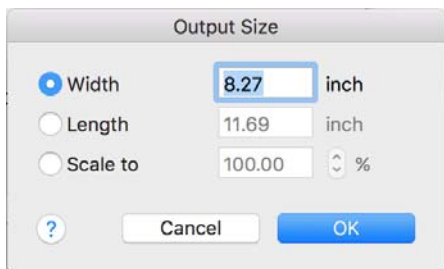

4 Check other settings, and then start printing.

Printing at Non-Standard Sizes

Before printing at non-standard sizes, including vertical or horizontal banners and documents with equal sides, save the desired paper size in the printer driver. Once they have been saved in the printer driver, custom sizes can be selected in the application **Page Setup** and other print dialogs.



The following sizes can be used.

Paper Width	SC-T5100M Series/ SC-T5100 Series/ SC-T5100N Series	89 to 914 mm
	SC-T3100M Series/ SC-T3100 Series/ SC-T3100N Series/ SC-T2100 Series	89 to 610 mm
Paper Length*	127 to 91000 mm	

*: The paper length can be longer when using an application that supports banner printing. However, the actual print size depends on the application, the paper size loaded in the printer, and the computer environment.

! Important:

- ❑ The smallest size supported by the printer is 89 mm wide × 127 mm long. When a smaller size than this is set in **Custom Paper Size...** of the printer driver, trim the unnecessary margins.
- ❑ For Custom Paper Sizes of a Mac, although you can specify a large paper size which cannot be loaded in this printer, it will not be printed properly.
- ❑ The available output size is limited depending on the application.

Printing with the Printer Driver from Your Computer

Settings in Windows

- 1 Display the Printer Settings tab of the printer driver from the application and then click **Custom Paper Size...**

The User-Defined Paper Size dialog box appears.

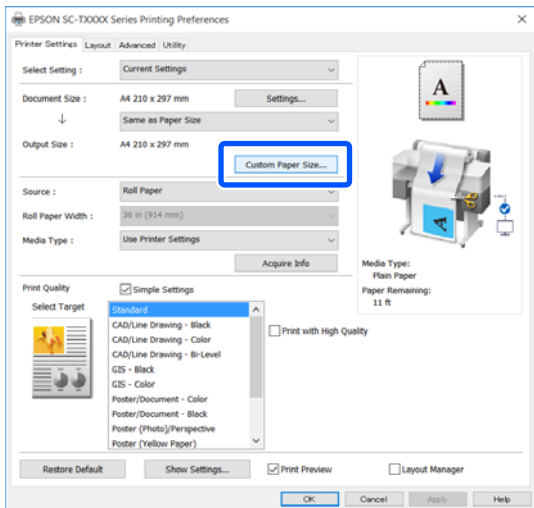

- 2 Set the paper size to use in the User-Defined Paper Size dialog box and then click **Save**.

- The **Paper Size Name** is displayed as a document size or output size option. Set a meaningful name such as "400x500mm" or "Horizontal Banner".
- To view the **Paper Width** and **Paper Height** values for a standard size close to the desired custom size, select the appropriate option in **Base Paper Size**.
- If you select an aspect ratio in **Fix Aspect Ratio** and select **Landscape** or **Portrait** for **Base**, you can set the size by just entering a value in either **Paper Width** or **Paper Height**.

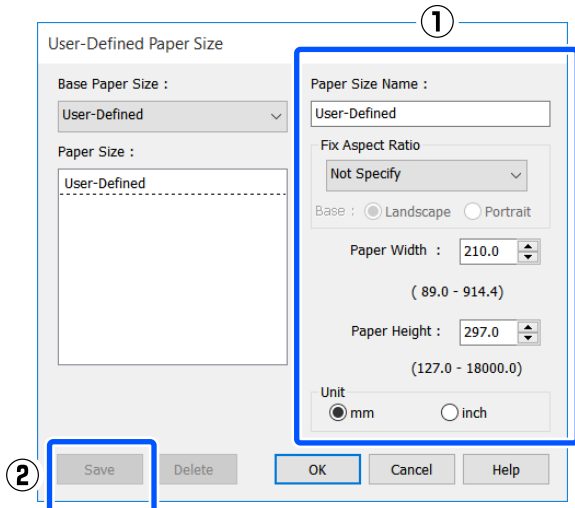

Note:

- To change the paper size you saved, select the paper size name from the list on the left.
- To delete a saved paper size, select the paper size name from the list on the left of the screen and then click **Delete**.
- You can save up to 100 paper sizes.

- 3 Click **OK** to close the User-Defined Paper Size dialog box. Also close the printer driver's dialog box.

Registration of the user-defined size is now complete.

- 4 Select the registered paper size in, for example, the page size settings of the application and then create the data.

Note:

If the registered paper size is not displayed in the application, check whether it exceeds the sizes supported by the application.

- 5 When you have finished creating the data, display the Printer Settings tab of the printer driver from the Print dialog box.

The registered paper size is displayed in Paper Size on the Printer Settings tab.

["Basic Operating Procedures \(Windows\)" on page 49](#)

- 6 Check other settings, and then start printing.

Printing with the Printer Driver from Your Computer

Settings in Mac

1 Open the page setup screen of the application and check that this printer is selected in **Printer** and then select **Manage Custom Sizes** from **Paper Size**.

“Basic Operating Procedures (Mac)” on page 55

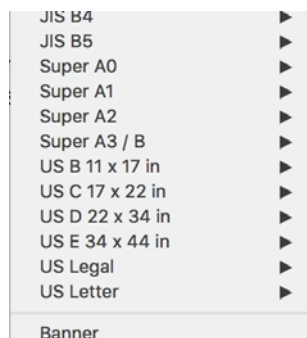
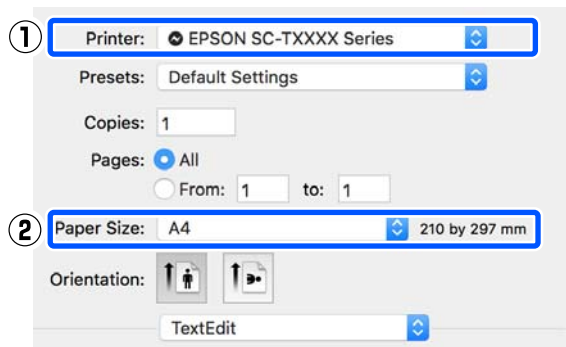

3 **Manage Custom Sizes...**

Note:

For applications without a page setup menu item, the paper size settings can be displayed by opening the **Print** dialog box from the **Print** menu.

2 Click **+** and then enter the paper size name.

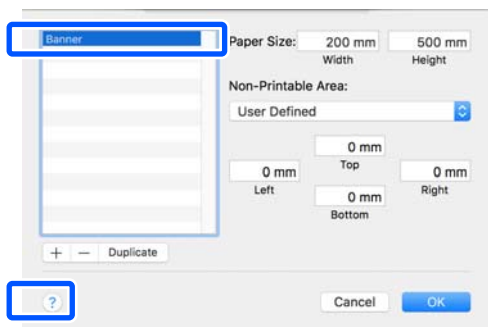

3 Enter values in **Width** and **Height** of the **Paper Size**, enter the margins, and then click **OK**.

The ranges of page sizes and margin sizes that can be specified differ depending on your printer model and the settings on the printer.

“Printable area” on page 215

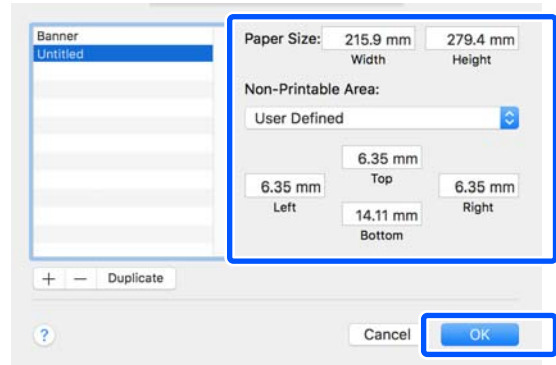

Note:

- To edit a saved custom size, choose its name from the list on the left.
- To duplicate a saved paper size, select its name from the list on the left of the screen and click **Duplicate**.
- To delete a saved paper size, select its name from the list on the left of the screen and click **-**.
- The custom paper size setting differs depending on the operating system version. See your operating system's documentation for details.

4 Click **OK** to close the Custom Paper Sizes dialog box. Also close the printer driver's dialog box by clicking **Cancel**.

Registration of the custom paper size is now complete.

5 Select the registered paper size in, for example, the page size settings of the application and then create the data.

Note:

If the registered paper size is not displayed in the application, check whether it exceeds the sizes supported by the application.

Printing with the Printer Driver from Your Computer

6 When you have finished creating the data, display the Printer Settings tab of the printer driver from the Print dialog box.

The registered paper size is displayed in Document Size on the Printer Settings tab.

 [“Basic Operating Procedures \(Mac\)” on page 55](#)

7 Check other settings, and then start printing.

Printing with the Printer Driver from Your Computer

Correct color and print

The optimal method is selected from the following color correction methods for each print target in the print quality settings of the printer driver.

- EPSON Standard (sRGB)
Optimizes the sRGB space and corrects the color.
- Business Graphics
Performs color correction to sharpen your images based on the sRGB space.
- Line Drawing
Optimizes color correction for line drawing by processing the border between lines and the background as discontinuous.
- GIS
Performs the optimal printing for topographic maps and other data of the geographic information system (GIS).
- ICM
Performs color management to match the colors in the image data to those in the printed output (Windows only).
[🔗 “Color Management Printing” on page 75](#)
- Off (No Color Adjustment)
Color correction is not performed by the printer driver. Choose if color management is performed by the application.
[🔗 “Color Management Printing” on page 75](#)

If you clear the **Simple Settings** check box, you can check which of the above color correction methods is used. **Standard of Select Target** is the most suitable setting for the currently selected paper type.

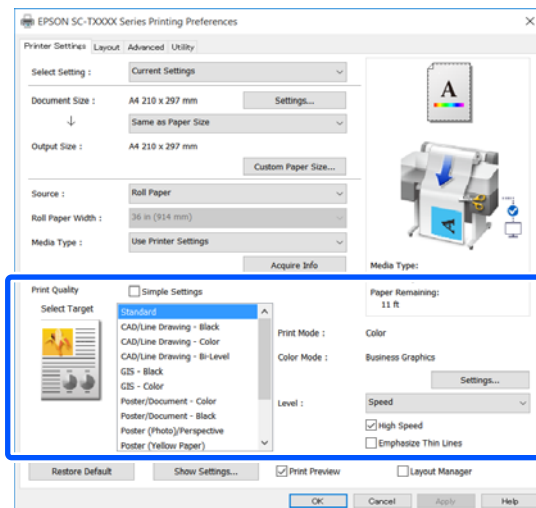

Clicking the **Settings** button allows you to, for example, finely adjust the Gamma, Brightness, Contrast, Saturation, and color balance.

Use this option when the application in use does not have a color correction function.

Note:

The color correction options available vary with the operating system and the type of paper used.

If you want to select the color correction method yourself, select **Custom** at the very bottom of the print target list.

Settings in Windows

- 1** When using applications featuring a color management function, specify how to adjust colors from these applications.

When using applications without a color management function, start from Step 2.

Depending on the type of the application, make the settings following the table below.

Adobe Photoshop CS3 or later
Adobe Photoshop Elements 6 or later
Adobe Photoshop Lightroom 1 or later

Printing with the Printer Driver from Your Computer

OS	Color Management Settings
Windows 10, Windows 8.1, Windows 8, Windows 7, Windows Vista	Printer Manages Colors
Windows XP (Service Pack 2 or later and .NET 3.0 or later)	
Windows XP (other than the above)	No Color Management

In other applications, set **No Color Management**.

Note:
For information on supported platforms, see the website for the application in question.

Setting example of Adobe Photoshop CC

Open the **Print** dialog box.

Select **Color Management**, then select **Printer Manages Colors** in **Color Handling**, and click **Print**.

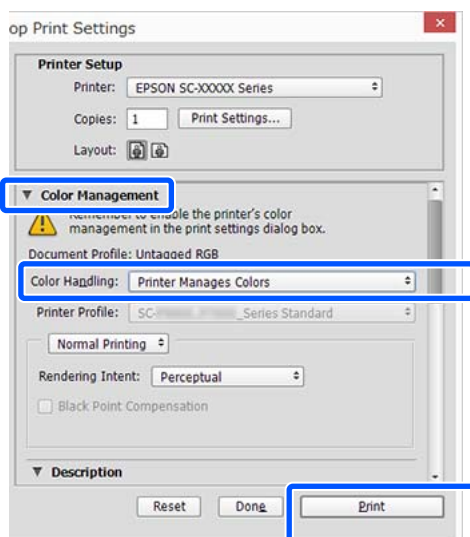

2 Display the Printer Settings tab of the printer driver and then clear the **Simple Settings** check box in the **Print Quality** area.

📖 [“Basic Operating Procedures \(Windows\)” on page 49](#)

3 Select the print target. If you want to select the color correction method yourself, select **Custom** at the very bottom of the list.

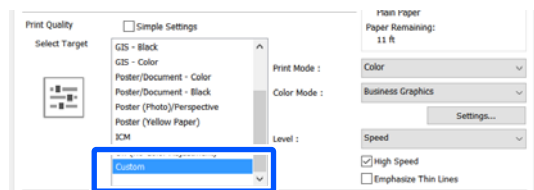

4 When **Custom** is selected for the print target, select the color and color correction method settings.

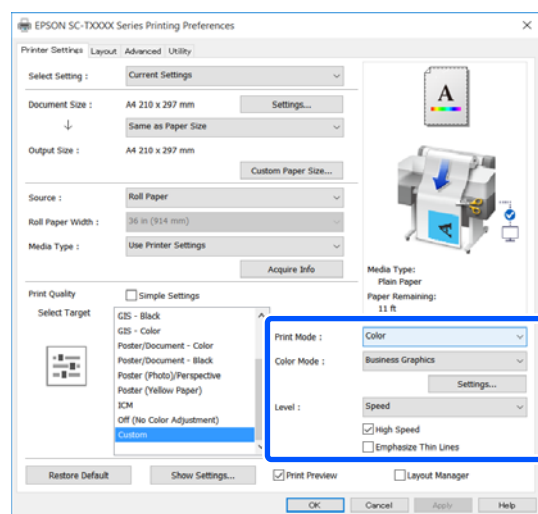

5 If necessary, click **Settings** and then adjust items such as the Gamma, Brightness, Contrast, Saturation, and color balance.

See the printer driver help for more details on each item.

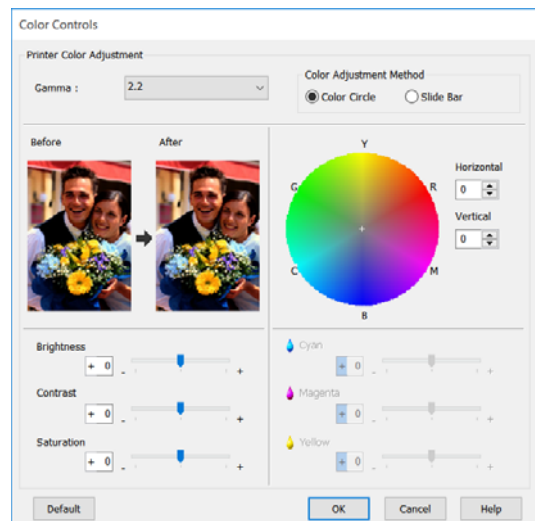

Printing with the Printer Driver from Your Computer

Note:
 You can adjust the correction value by checking the sample image on the left side of the screen.
 Furthermore, you can select **Color Circle** or **Slide Bar of Color Adjustment Method** and finely adjust the color balance.

6 Check other settings, and then start printing.

Settings in Mac

1 When using applications featuring a color management function, specify how to adjust colors from these applications.

When using applications without a color management function, start from Step 2.

When using the following applications, set the color management setting to **Printer Manages Colors**.

Adobe Photoshop CS3 or later
 Adobe Photoshop Elements 6 or later
 Adobe Photoshop Lightroom 1 or later

In other applications, set **No Color Management**.

Note:
 For information on supported platforms, see the website for the application in question.

Settings example of Adobe Photoshop CC
 Open the **Print** dialog box.

Select **Color Management**, then select **Printer Manages Colors** in **Color Handling**, and click **Print**.

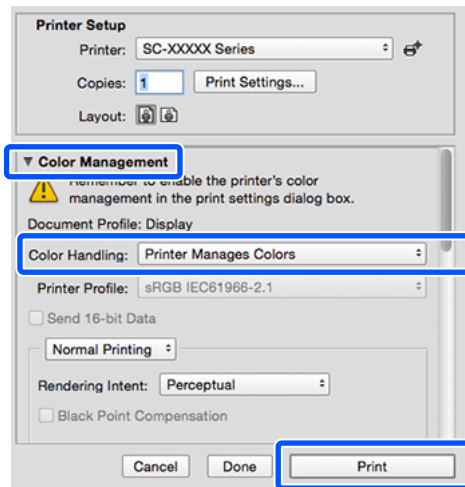

2 Display the Print screen.

📖 [“Basic Operating Procedures \(Mac\)”](#) on page 55

3 Select **Color Matching** from the list, and then click **EPSON Color Controls**.

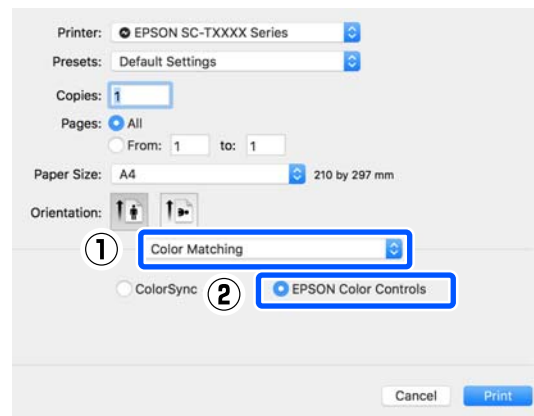

Note:
EPSON Color Controls will not be available in the following applications if Step 1 is omitted.

- Adobe Photoshop CS3 or later
- Adobe Photoshop Lightroom 1 or later
- Adobe Photoshop Elements 6 or later

Printing with the Printer Driver from Your Computer

- 4** Select **Printer Settings** from the list and then clear the **Simple Settings** check box in the **Print Quality** area.

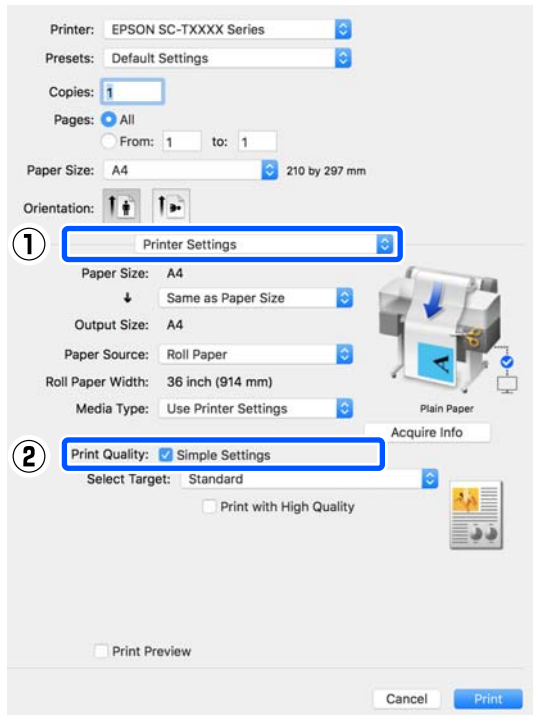

- 5** Select the print target. If you want to select the color correction method yourself, select **Custom** at the very bottom of the list.

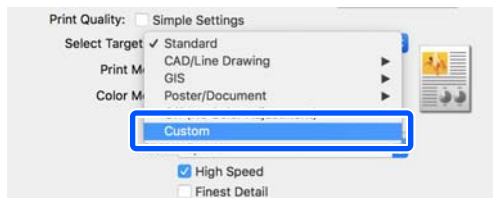

- 6** When **Custom** is selected for the print target, select the color and color correction method settings.

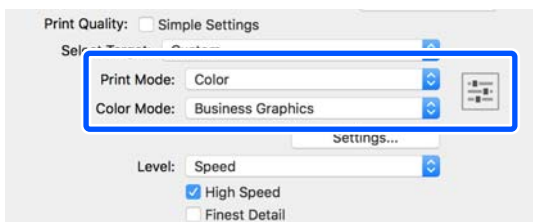

- 7** If necessary, click **Settings** and then adjust items such as the Gamma, Brightness, Contrast, Saturation, and color balance.

See the printer driver help for more details on each item.

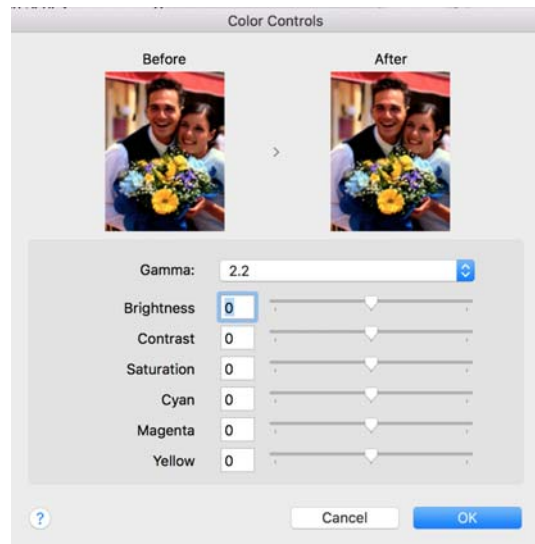

- 8** Check other settings, and then start printing.

Printing with the Printer Driver from Your Computer

Color Management Printing

About Color Management

Even when using the same image data, the original image and the displayed image may look different, and the printed results may look different to the image you see on the display. This occurs due to the difference in characteristics when input devices such as scanners and digital cameras capture colors as electronic data, and when output devices such as display screens and printers reproduce colors from the color data. The color management system is a means to adjust differences in color conversion characteristics among input and output devices. A color management system is included with operating systems such as Windows and Mac OS, in addition to image processing applications. Windows and Mac OS X include the ICM and ColorSync color management systems, respectively.

In a color management system, a color definition file called a "Profile" is used to perform color matching between devices. (This file is also called an ICC profile.) The profile of an input device is called an input profile (or source profile), and the profile of an output device, such as a printer, is called a printer profile (or output profile). A profile is prepared for each media type in this printer's driver.

The color conversion areas by the input device and the color reproduction area by the output device differ. As a result, there are color areas that do not match even when performing color matching using a profile. In addition to specifying profiles, the color management system also specifies conversion conditions for areas where color matching failed as "intent". The name and type of intent vary depending on the color management system you are using.

You cannot match the colors on the printed results and display by color management between the input device and the printer. To match both colors, you need to perform color management between the input device and the display as well.

Color Management Print Settings

You can perform color management printing using this printer's printer driver in the following two ways.

Choose the best method according to the application you are using, the operating system environment, the aim of the print out, and so on.



Setting color management with the applications

This method is for printing from applications that support color management. All color management processes are carried out by the application's color management system. This method is useful when you want to obtain the same color management print results using a common application among different operating system environments.

 ["Setting color management with the applications" on page 76](#)

Setting color management with the printer driver

The printer driver uses the operating system's color management system and carries out all color management processes. You can configure the color management settings in the printer driver using the following two methods.

- Host ICM (Windows) / ColorSync (Mac OS X)
Set when printing from applications that support color management. This is effective in producing similar print results from different applications under the same operating systems.
 ["Color Management Printing by Host ICM \(Windows\)" on page 78](#)
 ["Color Management Printing by ColorSync \(Mac\)" on page 79](#)
- Driver ICM (Windows only)
This allows you to perform color management printing from applications that do not support color management.
 ["Color Management Printing by Driver ICM\(Windows Only\)" on page 80](#)

Printing with the Printer Driver from Your Computer

Setting profiles

Settings for the input profile, printer profile, and intent (matching method) vary between three types of color management printing since their color management engines are used differently. This is because color management usage differs between the engines. Make settings in the printer driver or application as described in the following table.

	Input profile settings	Printer profile settings	Intent settings
Driver ICM (Windows)	Printer Driver	Printer Driver	Printer Driver
Host ICM (Windows)	Application	Printer Driver	Printer Driver
ColorSync (Mac OS X)	Application	Printer Driver	Application
Application	Application	Application	Application

Printer profiles for each paper type that is needed when performing color management are installed with the printer's printer driver. You can select the profile from the printer driver's settings screen.

You can select the profile from the printer driver's settings screen.

[“Color Management Printing by Driver ICM\(Windows Only\)”](#) on page 80

[“Color Management Printing by Host ICM \(Windows\)”](#) on page 78

[“Color Management Printing by ColorSync \(Mac\)”](#) on page 79

[“Setting color management with the applications”](#) on page 76

Setting color management with the applications

Print using applications with a color management function. Make the color management settings in the application and disable the printer driver's color adjustment function.

1 Make color management settings in the applications.

Settings example of Adobe Photoshop CC

Open the **Print** dialog box.

Select **Color Management**, select **Photoshop Manages Colors** in **Color Handling**, select **Printer Profile** and **Rendering Intent**, and click **Print**.

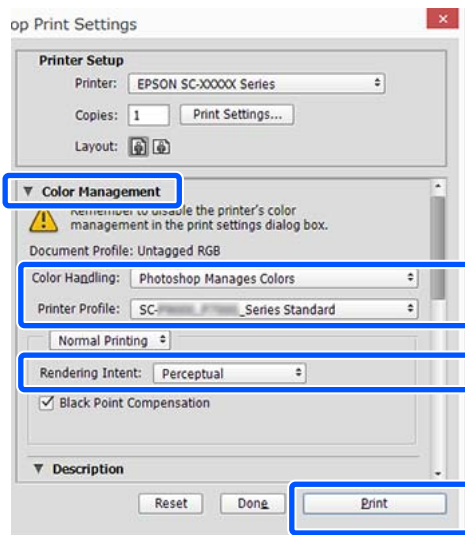

2 Display the printer driver's settings screen (Windows) or Print screen (Mac).

Make printer driver settings.

For Windows

[“Basic Operating Procedures \(Windows\)”](#) on page 49

For Mac

[“Basic Operating Procedures \(Mac\)”](#) on page 55

Printing with the Printer Driver from Your Computer

3 Set color management to off.

For Windows

Clear the **Simple Settings** check box in the Print Quality area of the **Printer Settings** tab and select **Off (No Color Adjustment)** from the print target list.

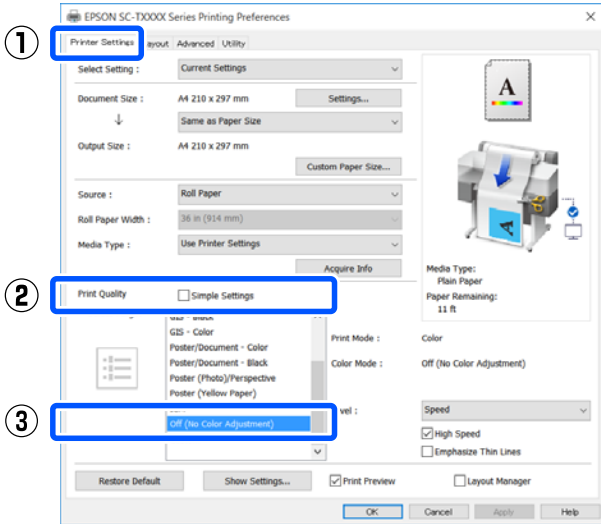

Note:
 In Windows 7, Windows Vista, and Windows XP (Service Pack 2 or later and .NET 3.0), **Off (No Color Adjustment)** is selected automatically.

For Mac

Select **Printer Settings** from the list and clear the **Simple Settings** check box in the Print Quality area, and select **Off (No Color Adjustment)** from the print target list.

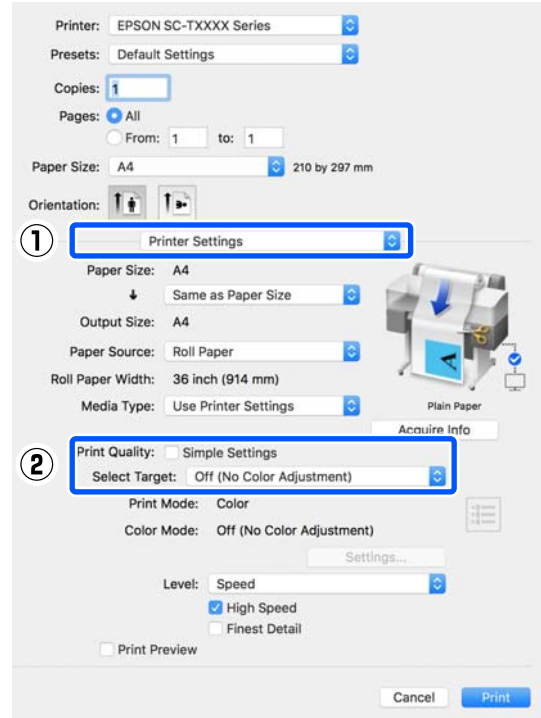

4 Check other settings, and then start printing.

Printing with the Printer Driver from Your Computer

Setting color management with the printer driver

Color Management Printing by Host ICM (Windows)

Use image data in which an input profile has been embedded. Also, the application must support ICM.

1 Make the settings for color adjustment using the application.

Depending on the type of the application, make the settings following the table below.

Adobe Photoshop CS3 or later
 Adobe Photoshop Elements 6.0 or later
 Adobe Photoshop Lightroom 1 or later

OS	Color Management Settings
Windows 8.1, Windows 8, Windows 7, Windows Vista	Printer Manages Colors
Windows XP (Service Pack 2 or later and .NET 3.0 or later)	Printer Manages Colors
Windows XP (other than the above)	No Color Management

In other applications, set **No Color Management**.

Note:
 For information on supported platforms, see the website for the application in question.

Settings example of Adobe Photoshop CC

Open the **Print** dialog box.

Select **Color Management**, then select **Printer Manages Colors** in **Color Handling**, and click **Print**.

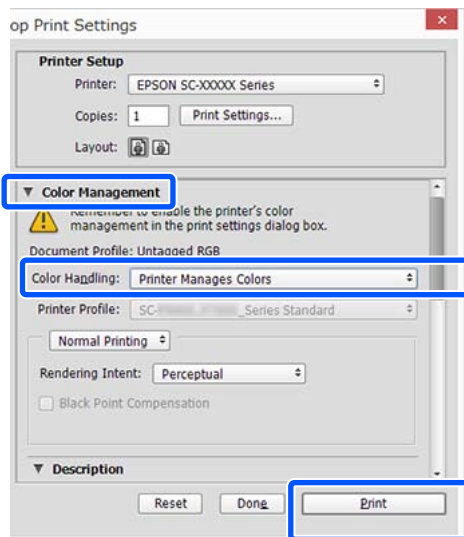

When using an application without a color management function, start from step 2.

2 Clear the **Simple Settings** check box in the Print Quality area on the **Printer Settings** tab of the printer driver and then select ICM from the Select Target list.

[“Basic Operating Procedures \(Windows\)” on page 49](#)

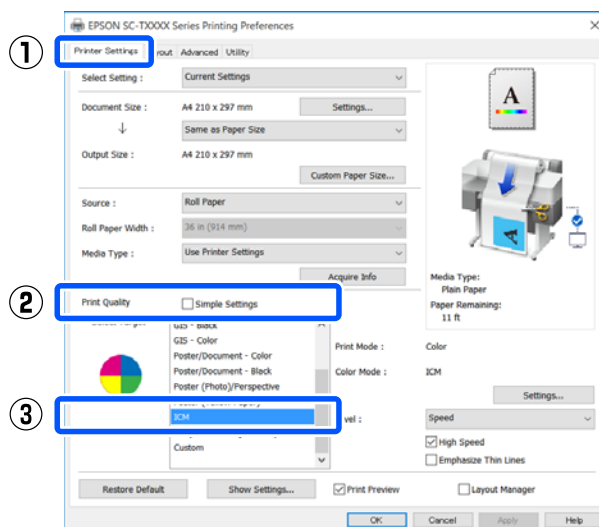

Printing with the Printer Driver from Your Computer

3 Click **Settings**.

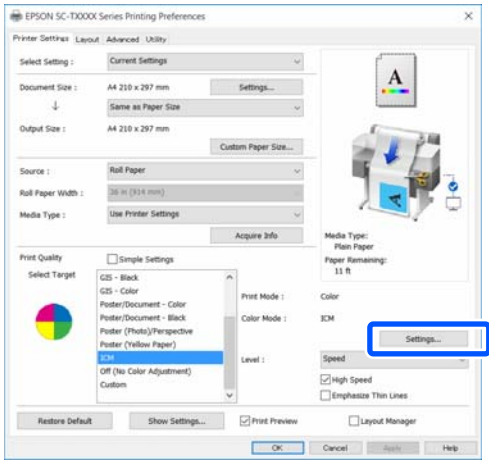

4 Select **Host ICM** in **ICM Mode**.
See the printer driver help for more details.

The printer profile corresponding to the **Media Type*** selected on the **Printer Settings** tab is set automatically and is displayed in the **Printer Profile Description** area.

To change the profile, select the **Show all profiles** check box.

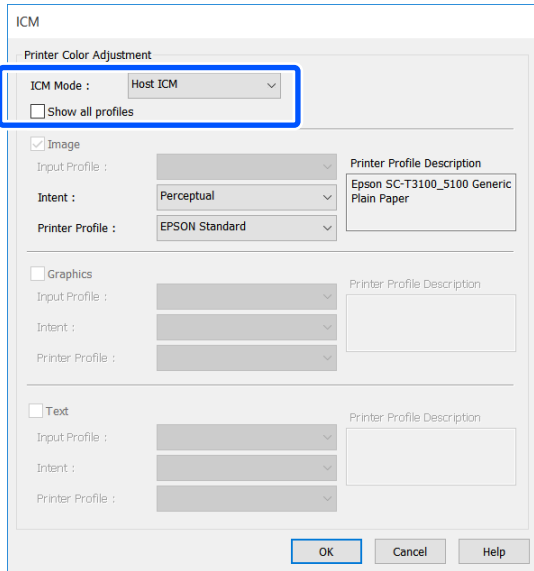

*: If **Source** is selected on the **Printer Settings** tab, the paper type set on the printer is set automatically. **Media Type** becomes **Use Printer Settings**, and the paper type name is displayed on the right side.

5 Check other settings, and then start printing.

Color Management Printing by ColorSync (Mac)

Use image data in which an input profile has been embedded. Also, the application must support ColorSync.

Note:
Depending on the application, color management printing by **ColorSync** may not be supported.

1 Disable the color management functions in the application.

2 Display the Print screen.
☞ [“Basic Operating Procedures \(Mac\)” on page 55](#)

3 Select **Color Matching** from the list, and then click **ColorSync**.

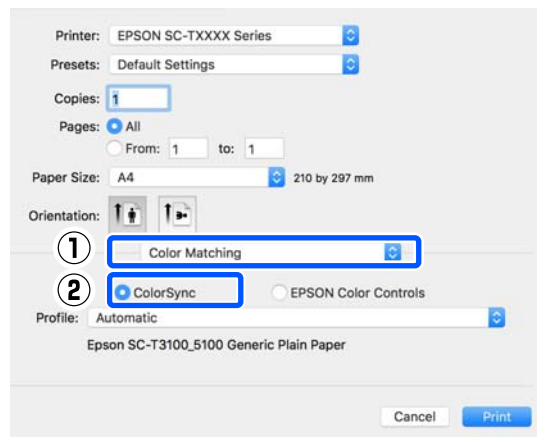

The printer profile corresponding to the currently selected paper type* is specified automatically and displayed at the bottom of the profile area. To change the profile, select the desired profile from the **Profile** pull-down menu.

*: It is set in the screen displayed by selecting **Printer Settings** from the list. If **Source** is selected, the paper type set on the printer is set automatically, and **Use Printer Settings** is displayed. The paper type name is displayed on the right side of it.

4 Check other settings, and then start printing.

Printing with the Printer Driver from Your Computer

Color Management Printing by Driver ICM (Windows Only)

The printer driver uses its own printer profiles to perform color management. You can use the following two color correction methods.

- Driver ICM (Basic)
Specify one type of profile and intent for processing the entire image data.
- Driver ICM (Advanced)
The printer driver distinguishes the image data into the **Image**, **Graphics**, and **Text** areas. Specify a different profile and intent for each of the three areas.

When using applications featuring a color management function

Make the settings for color processing using the application before making printer driver settings.

Depending on the type of the application, make the settings following the table below.

Adobe Photoshop CS3 or later
 Adobe Photoshop Elements 6.0 or later
 Adobe Photoshop Lightroom 1 or later

OS	Color Management Settings
Windows 8.1, Windows 8, Windows 7, Windows Vista	Printer Manages Colors
Windows XP (Service Pack 2 or later and .NET 3.0 or later)	Printer Manages Colors
Windows XP (other than the above)	No Color Management

In other applications, set **No Color Management**.

Note:
 For information on supported platforms, see the website for the application in question.

Settings example of Adobe Photoshop CC

Open the **Print** dialog box.

Select **Color Management**, then select **Printer Manages Colors in Color Handling**, and click **Print**.

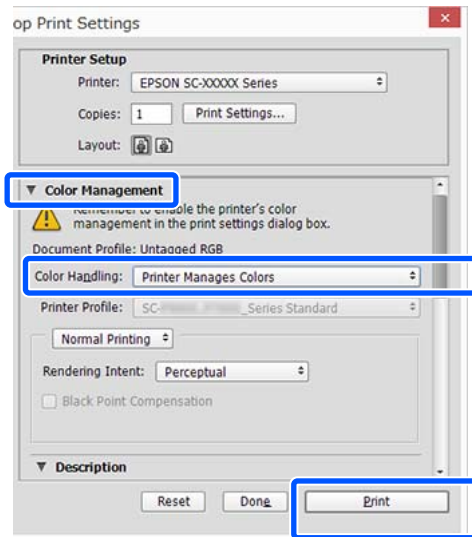

- 1 Clear the **Simple Settings** check box in the **Print Quality** area on the **Printer Settings** tab of the printer driver and then select **ICM** from the **Select Target** list.

[“Basic Operating Procedures \(Windows\)” on page 49](#)

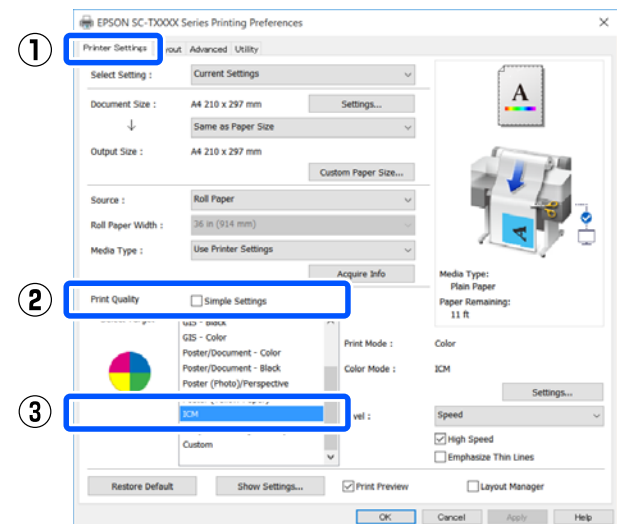

Printing with the Printer Driver from Your Computer

2 Click **Settings**.

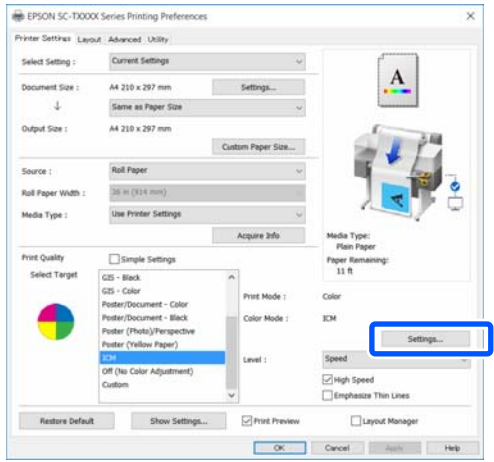

3 Select **Driver ICM (Basic)** or **Driver ICM (Advanced)** in ICM Mode from the ICM screen.

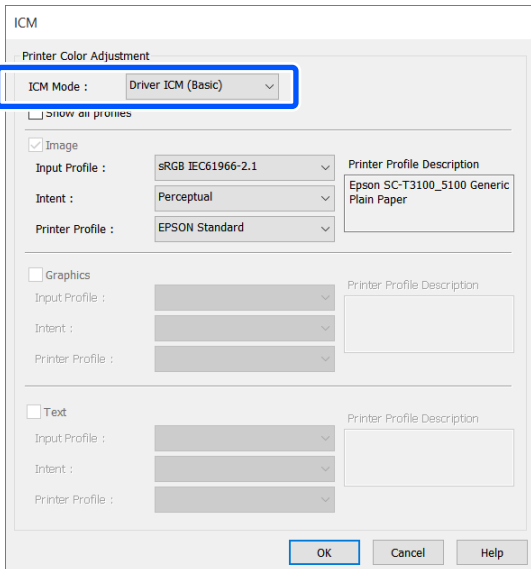

If you select **Driver ICM (Advanced)**, you can specify the profile and intent for each type of image data such as photos, graphics data, and text data.

Intent	Explanation
Saturation	Keeps the current saturation unchanged and converts the data.
Perceptual	Converts the data so that a more visually natural image is produced. This feature is used when a wider gamut of color is used for image data.

Intent	Explanation
Relative Colorimetric	Converts the data so that a set of color gamut and white point (or color temperature) coordinates in the original data match their corresponding print coordinates. This feature is used for many types of color matching.
Absolute Colorimetric	Assigns absolute color gamut coordinates to the original and print data and converts the data. Therefore, color tone adjustment is not performed on any white point (or color temperature) for the original or print data. This feature is used for special purposes such as logo color printing.

4 Check other settings, and then start printing.

Printing with the Printer Driver from Your Computer

Multi-Page Printing (N-up)

Two or four consecutive pages can be printed on a single sheet.

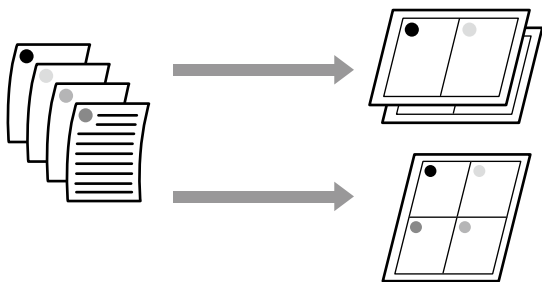

Settings in Windows

Note:

In Windows, you can use the Reduce/Enlarge function (Fit to Page) to print the data on different sizes of paper.

[“Printing at Non-Standard Sizes” on page 67](#)

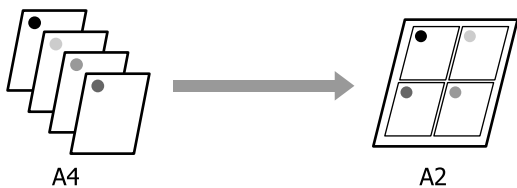

- 1 Display the Layout tab of the printer driver and select the **Page Layout** check box. Then, select **N-up** and click the **Settings** button.

[“Basic Operating Procedures \(Windows\)” on page 49](#)

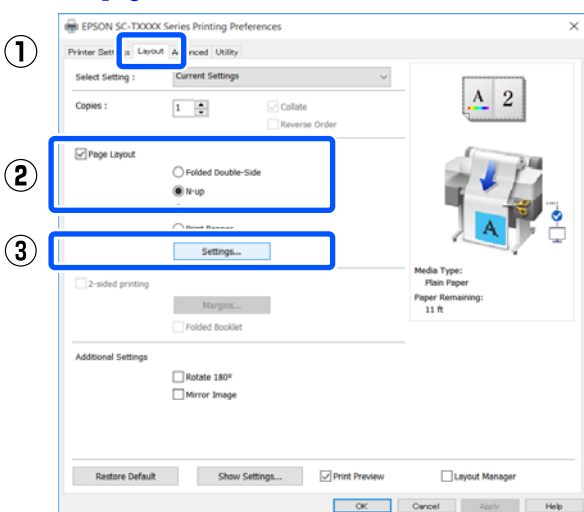

- 2 Set **Number of pages per sheet** and **Page Order** in the Print Layout dialog box.

If the **Print page frames** check box is selected, page frames are printed on each page.

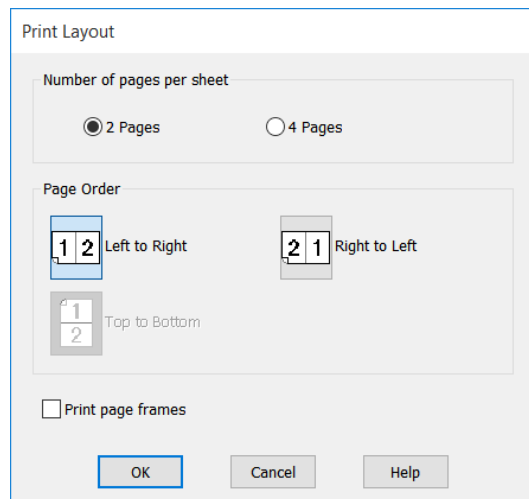

- 3 Check other settings, and then start printing.

Settings in Mac

- 1 Display the Print dialog box, select **Layout** from the list, and specify the number of pages per sheet and so on.

[“Basic Operating Procedures \(Mac\)” on page 55](#)

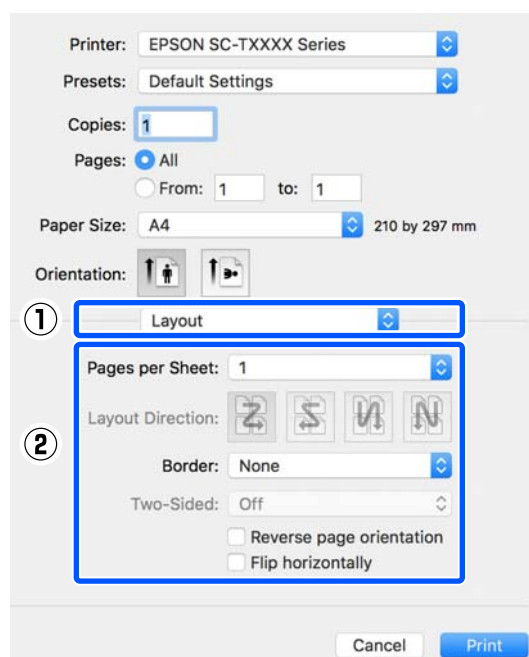

Printing with the Printer Driver from Your Computer

Note:

You can print frames around arranged pages using the **Border** function.

2

Check other settings, and then start printing.

Manual Double Sided Printing (Windows Only)

This function is only available when Auto Sheet Feeder is selected as the Source. This function cannot be used for Roll Paper or Sheet.

After you have finished printing even pages, you can turn the paper over, re-load it, and then print the odd pages to create double-sided prints.

Notes on double-sided printing

Note the following points when performing double-sided printing.

- Make sure you use paper that supports double-sided printing.
- Depending on the type of paper and the data being printed, the ink may smear on the back of the paper.
- Continuous double-sided printing can lead to a decline in print quality and paper jams. If print quality declines, lower the ink density in the printer driver or try printing one sheet at a time.
- If you perform double-sided printing continuously, the inside of the printer may be smeared with ink. Clean the rollers if the paper is smeared after printing.
 -  [“Smearing occurs when printing from the auto sheet feeder” on page 195](#)

Note:

Printing in combination with Multi-Page Printing (N-up) can help to save more paper.

 [“Multi-Page Printing \(N-up\)” on page 82](#)

Setting Procedures for Printing

1

Load the paper into the Auto Sheet Feeder.

 [“Loading paper into the auto sheet feeder” on page 36](#)

Printing with the Printer Driver from Your Computer

- 2 Display the Basic Settings screen for the printer driver, and then select **Auto Sheet Feeder** as the Source.

[“Basic Operating Procedures \(Windows\)” on page 49](#)

- 3 Display the Layout tab of the printer driver, and then select **2-sided printing**.

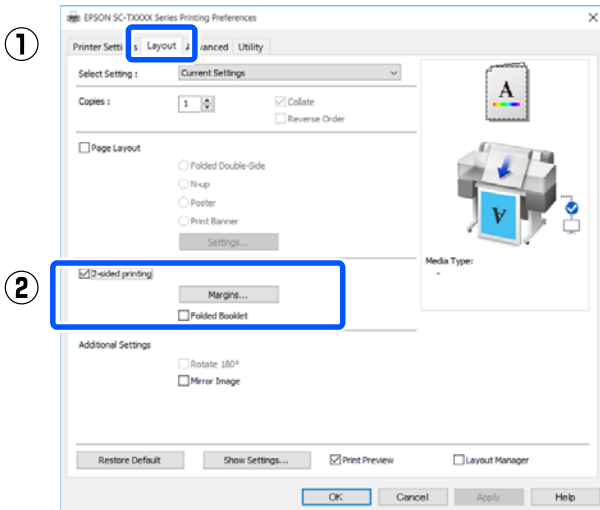

Note:

- Click **Binding Settings** to set the **Binding Edge** and **Binding Margin**. Depending on the software you are using, the width of the margin you set and the actual print results may differ, we therefore recommended that you perform a test print first.

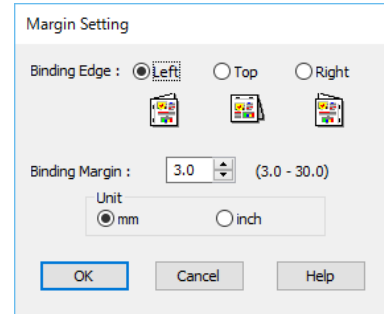

- Select **Folded Booklet** to print as a booklet. In the following example, when the paper is folded in two, the inner pages (pages 2, 3, 6, 7, 10, and 11) are printed first.

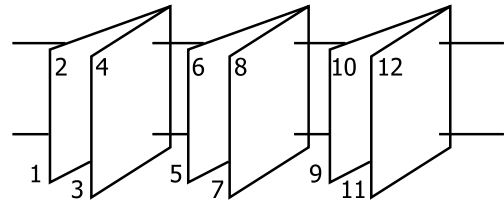

- 4 Check other settings, and then start printing.

- 5 When you have finished printing the odd pages and the instructions screen is displayed, follow the on-screen instructions to re-load the paper, and then click **Resume**.

Printing with the Printer Driver from Your Computer

Folded 2-Sided Printing (Windows only)

Two consecutive pages can be printed on a single sheet. The second page is flipped 180° and printed adjacent to the first page, allowing the paper to be folded to make a 2-sided document.

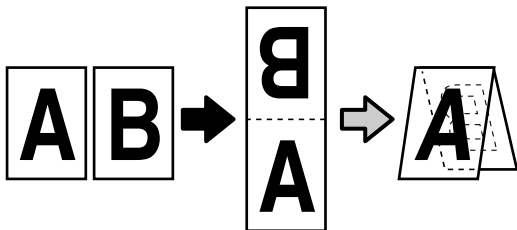

- 1 Display the Layout tab of the printer driver and select the **Page Layout** check box. Then, select **Folded Double-Side** and click the **Settings...** button.

[📖 “Basic Operating Procedures \(Windows\)” on page 49](#)

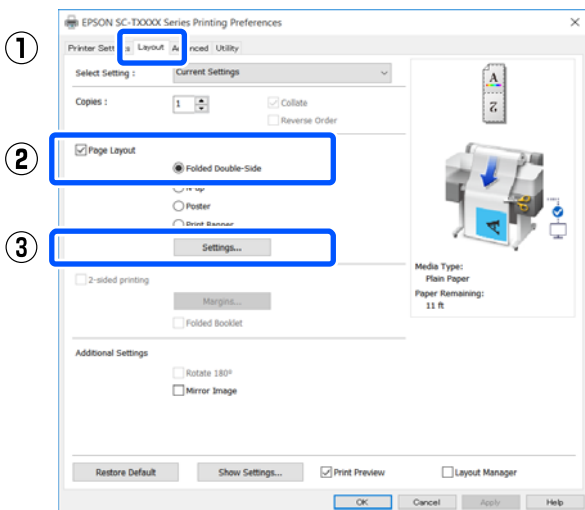

- 2 Set **Binding Edge** and **Binding Margin** in the Folded Double-Side Setting dialog box.

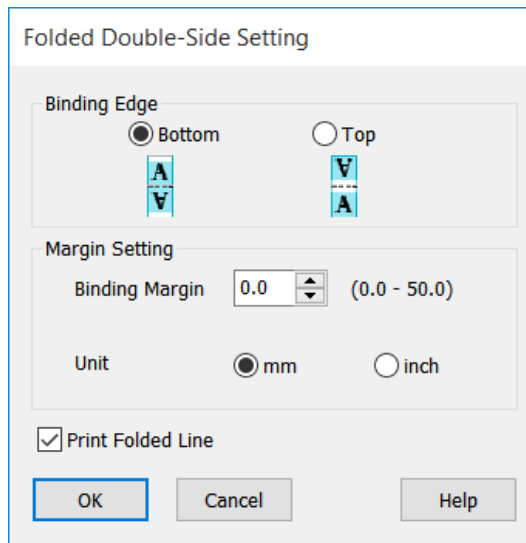

- 3 Check other settings, and then start printing.

Printing with the Printer Driver from Your Computer

Poster Printing (Windows Only)

A single page can be printed across multiple sheets. The sheets can then be joined together to form large posters (up to 16 times the original size).

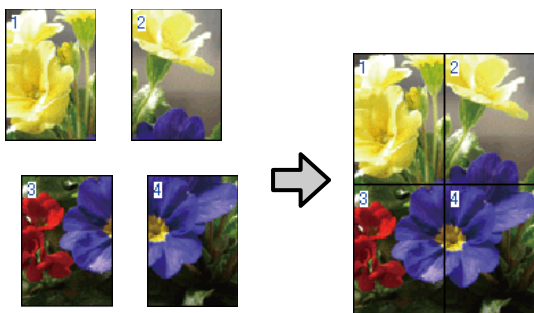

- 1 Display the Layout tab of the printer driver and select the **Page Layout** check box. Then, select **Poster** and click the **Settings...** button.

[“Basic Operating Procedures \(Windows\)” on page 49](#)

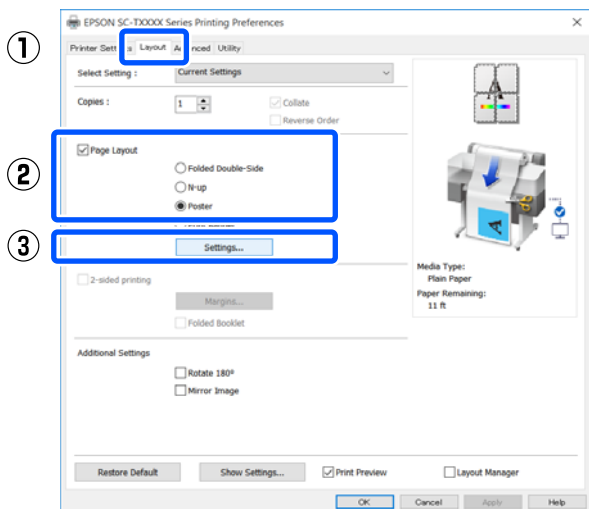

- 2 Set **Number of panels** in the Poster dialog box.

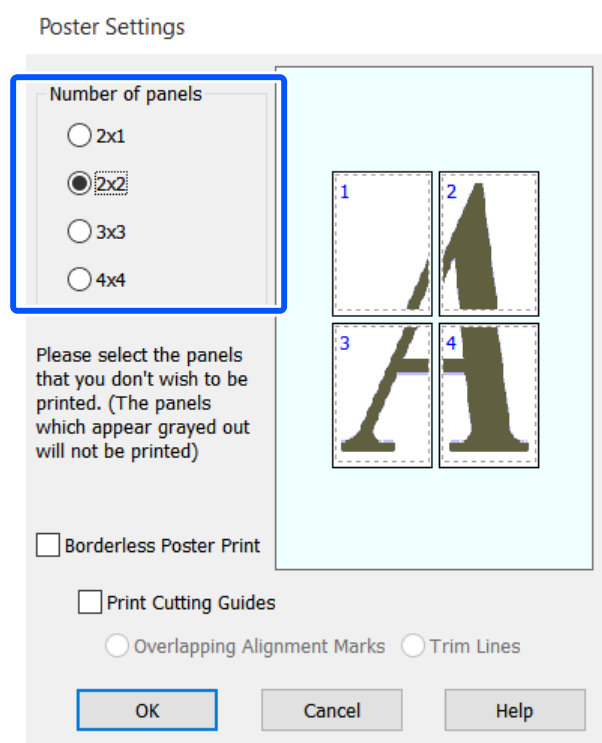

- 3 If you want to print marks to serve as a guide when joining together paper printed with poster printing, select the **Print Cutting Guides** check box.

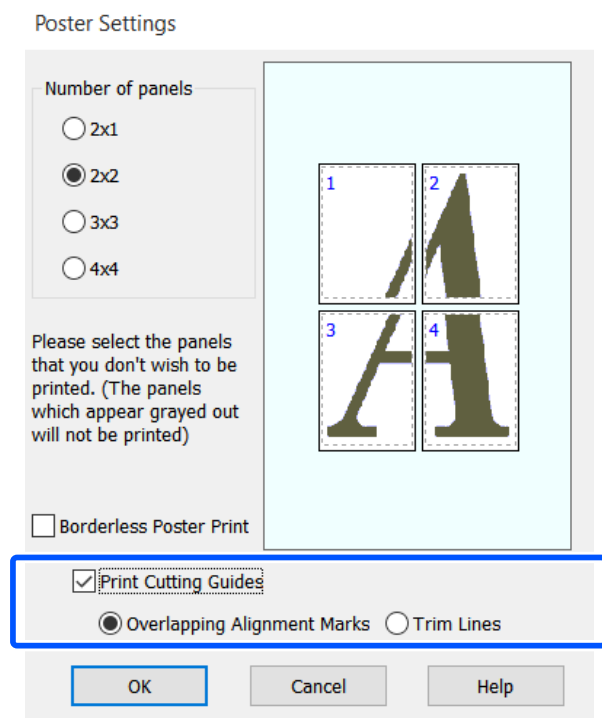

Printing with the Printer Driver from Your Computer

Overlapping Alignment Marks

Prints guides for joining the paper with overlapping. The finished size is smaller only for the overlapping portions.

Print page frames

Prints frames for joining the paper without overlapping.

- 4** Check other settings, and then start printing.

Joining poster sheets in multi-page printing

If **Overlapping Alignment Marks** is selected, join guides (indicated by the lines drawn through and around the X marks in the illustration below) will be printed on each sheet.

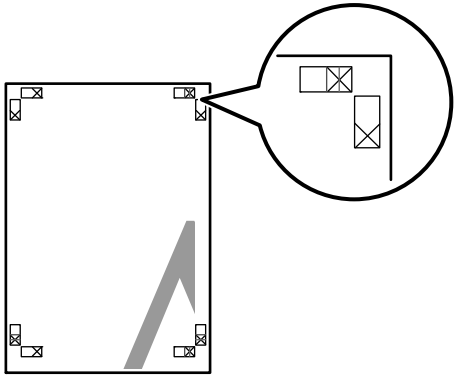

Note:
 If the output is in color, the join guides will be in blue and the cut guides in red; otherwise, all the guides will be printed in black.

The following section describes how to join four printed pages together.

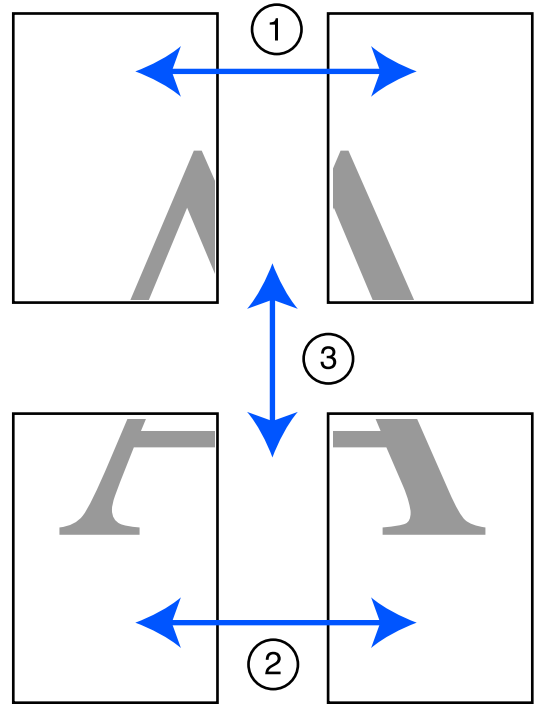

Printing with the Printer Driver from Your Computer

- 1 Ready the two top sheets and trim the excess from the left sheet by cutting along the line joining the two join guides (the centers of the X marks).

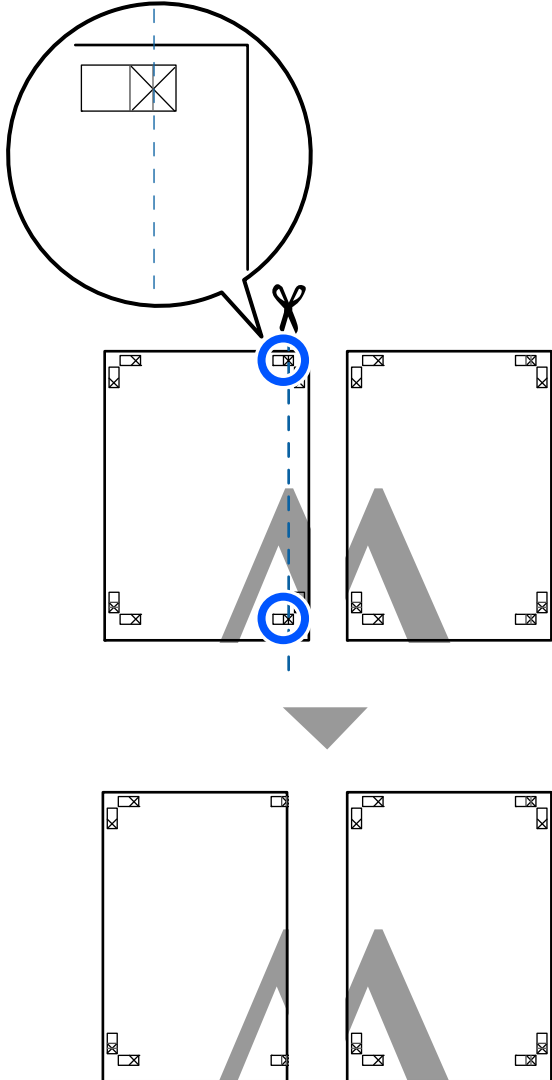

- 2 Lay the upper left sheet on top of upper right sheet. Lineup the X marks as shown in the illustration below, and temporarily fasten them using an adhesive tape on the back.

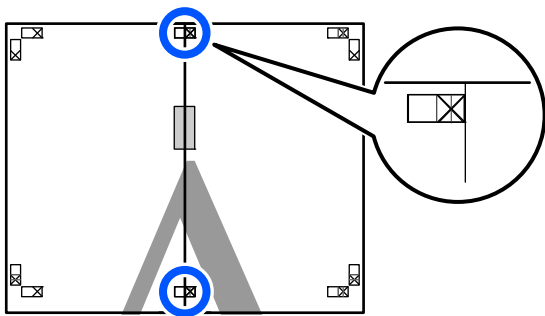

- 3 With the two sheets overlapping, trim the excess by cutting along the line joining the two cut guides (the lines to the left of the X marks).

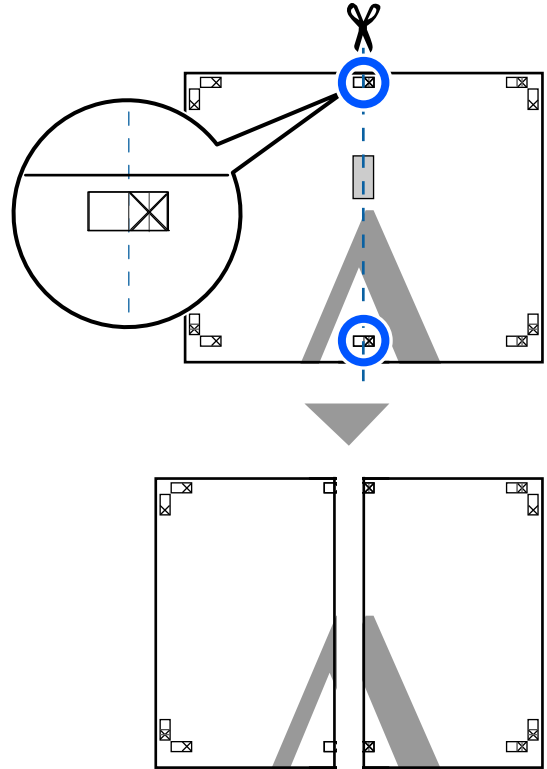

- 4 Rejoin the two sheets. Use an adhesive tape to stick the backs of the sheets together.

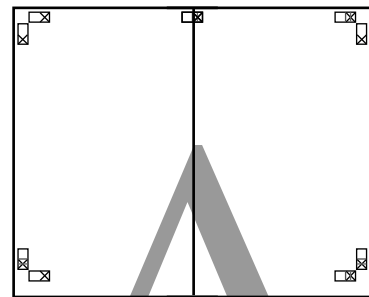

- 5 Repeat steps 1 to 4 for the lower two sheets.

Printing with the Printer Driver from Your Computer

- 6** Trim the bottom from the upper sheets by cutting along the line joining the two guides (the lines above the X marks).

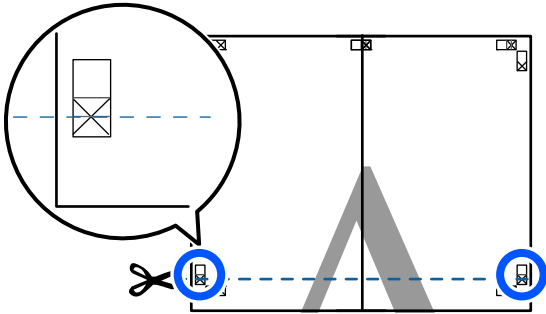

- 7** Lay the upper sheet on top of the lower sheet. Lineup the X marks as shown in the illustration below, and temporarily fasten them using an adhesive tape on the back.

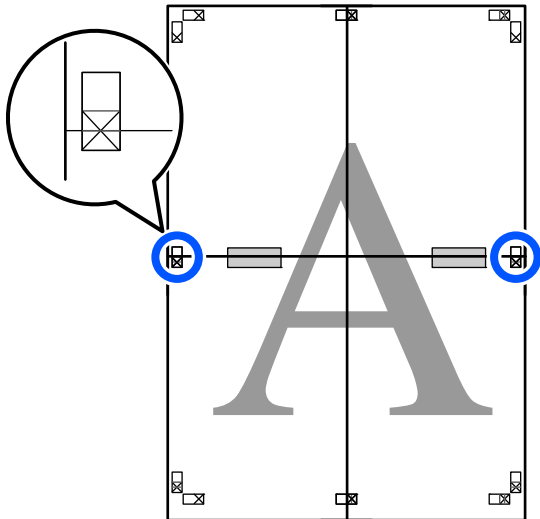

- 8** With the two sheets overlapping, trim the excess by cutting along the line joining the two cut guides (the lines above the X marks).

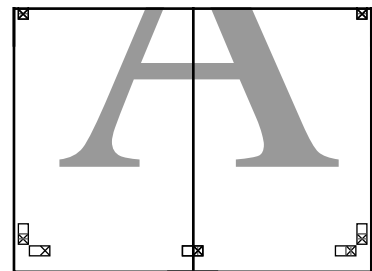
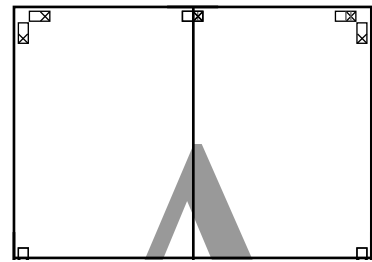
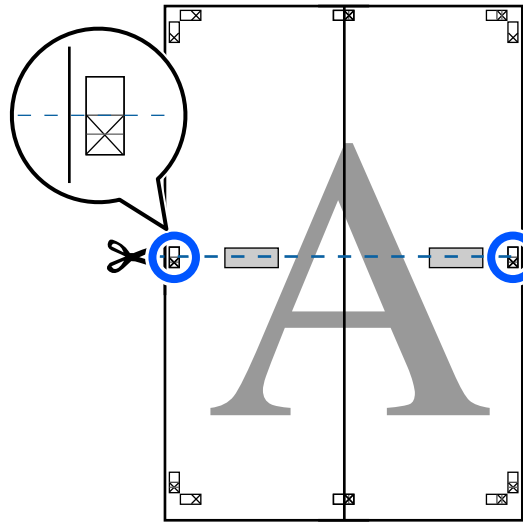

Printing with the Printer Driver from Your Computer

- 9** Join the upper and lower sheets together.
Use an adhesive tape to stick the backs of the sheets together.

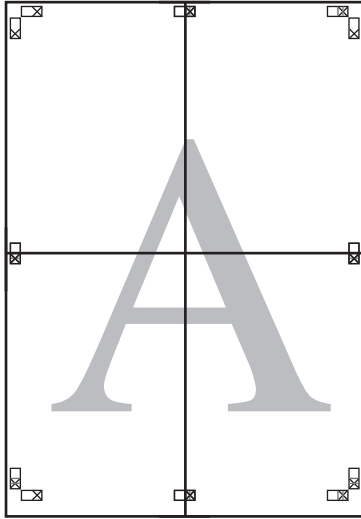

- 10** After joining all the sheets, trim off the borders by cutting along the cut guides (outside the X marks).

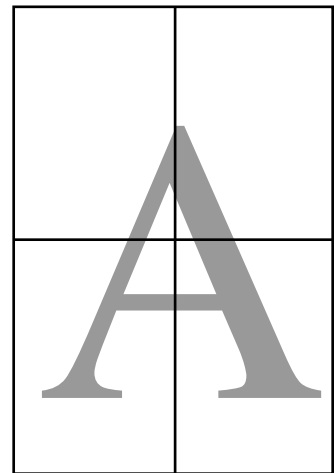
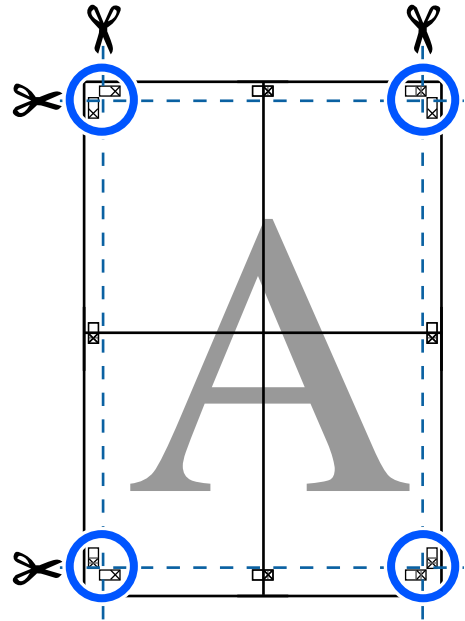

Printing with the Printer Driver from Your Computer

Printing Multiple Documents (Layout Manager) (Windows Only)

Documents created in different applications can be printed together in your choice of layout. This allows you to improve print work efficiency and conserve paper.

Sample Multi-Document Layout

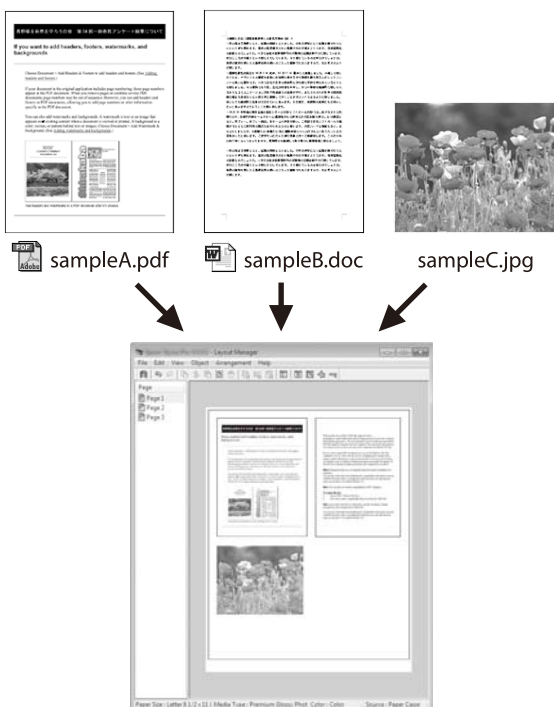

Sample Free Vertical/Horizontal Layout

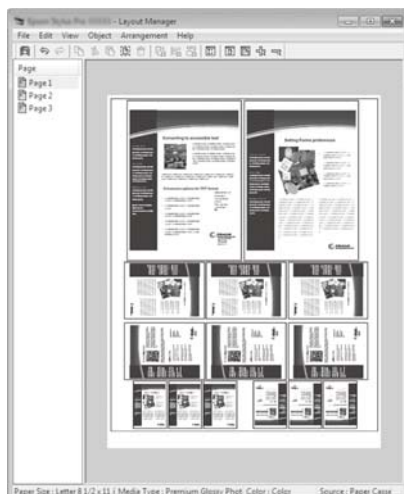

Setting Procedures for Printing

- 1 Open the file you want to print in your application.
- 2 Select the **Layout Manager** check box on the Printer Settings tab of the printer driver and check that the size set in the application is displayed in Document Size.

[“Basic Operating Procedures \(Windows\)” on page 49](#)

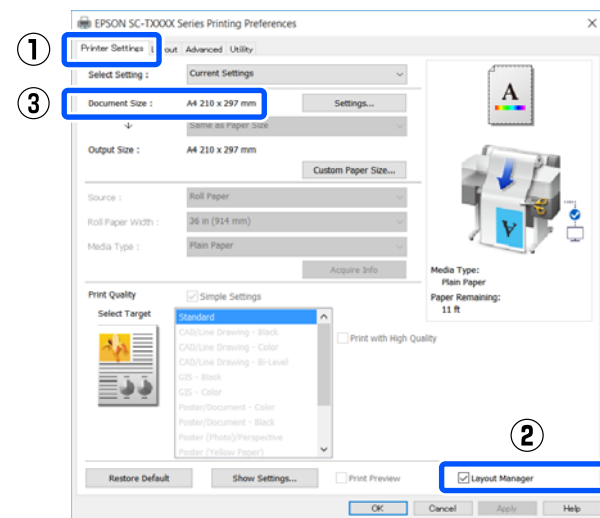

Note:
Document Size is the size of the document to be placed on the Layout Manager screen. The actual printing paper size is set in the screen in Step 6.

- 3 Click **OK**. When printing from an application, the Layout Manager screen opens.
 The print data is not printed, but one page is placed on the paper of the Layout Manager screen as one object.
- 4 Leaving the Layout Manager screen open, repeat steps 1 to 3 until all the print data has been added to the layout.
 The objects are added to the Layout Manager screen.
- 5 Arrange the objects on the Layout Manager screen.
 Objects can be moved or resized by dragging as well as rearranged or rotated using the tool buttons or the options in the **Object** menu.

Printing with the Printer Driver from Your Computer

The overall size and placement of the objects can be changed using the **Preferences** and **Arrangement** options in the **File** menu.

See the Layout Manager screen help for more details on each function.

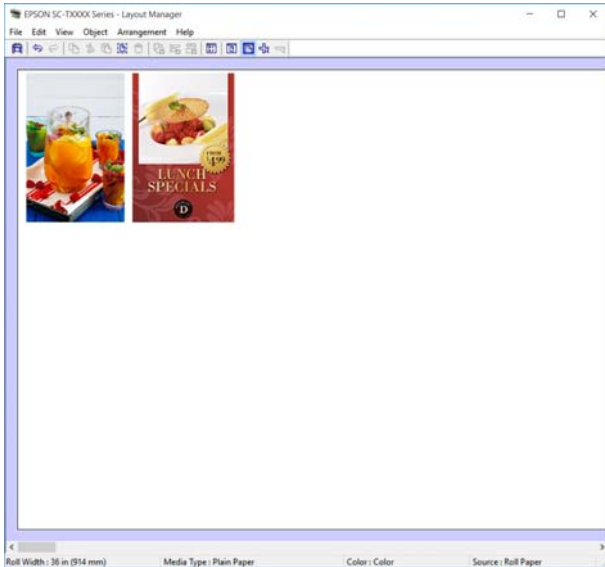

- 6 Click **Properties** in the **File** menu and set the print settings in the printer driver dialog box.

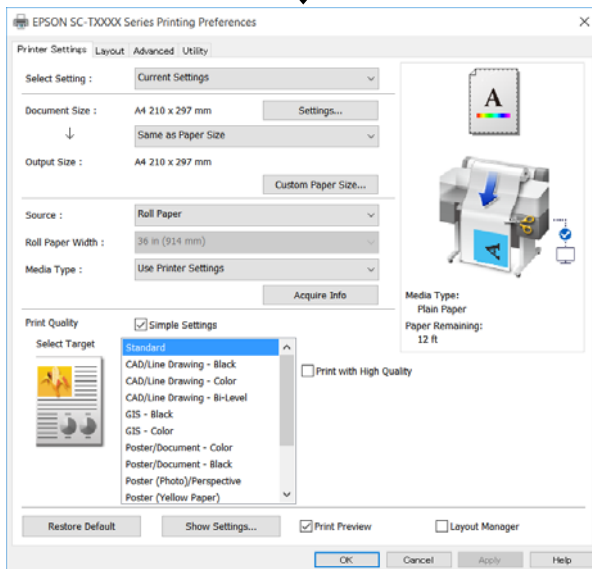
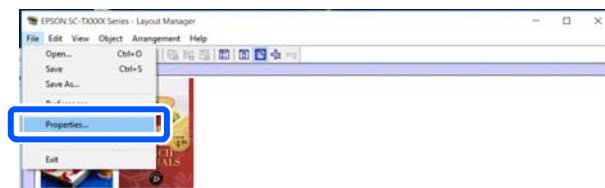

Check **Media Settings**, and set **Print Quality**.

- 7 Click the **File** menu in the Layout Manager screen, and then click **Print**.

Printing starts.

Saving and Recalling Settings

The layout and setting information on the Layout Manager screen can be saved as a file. If you need to close your application in the middle of a job, you can save it to a file and then open it later to continue your work.

Saving

- 1 Click the **File** menu on the Layout Manager screen, and then click **Save As...**
- 2 Enter the file name, select the location, and then click **Save**.
- 3 Close the Layout Manager screen.

Opening saved files

- 1 Right-click the printer icon () on the Windows taskbar, and then click **Layout Manager** in the displayed menu.

The Layout Manager screen appears.

Note:

When the printer icon is not displayed on the Windows taskbar

Open the **Utility** tab of the printer driver and click the **Monitoring Preferences**. Select **Register the shortcut icon to the taskbar** in the **Monitoring Preferences** dialog box.

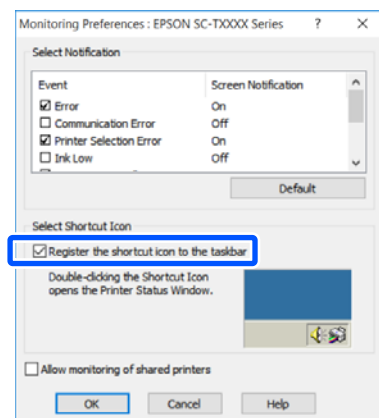

Printing with the Printer Driver from Your Computer

- 2 Click **Open** in the **File** menu on the Layout Manager screen.
- 3 Select the location and open the required file.

Printing Using the HP-GL/2 or HP RTL Mode from a Computer

Printing Using the HP-GL/2 or HP RTL Mode from a Computer

The printer can emulate* HP-GL/2 (compatible with HP Designjet 750C) and HP RTL. This section describes the settings of the printer and the settings in the CAD application for printing while emulating.

* Not all functions are supported. If you will use an untested application, test its output in advance.

Important:

The printer may not perform as expected if the size of the data to be printed is extremely large.

Note:

CAD drawings can also be printed using the CAD/ line drawing mode of the supplied printer driver. We recommend printing from the printer driver when you want to print with better image quality.

 ["Printing CAD Drawings" on page 60](#)

Printer Settings

Change the printer settings for printing in the HP-GL/2 or HP RTL mode as necessary in the control panel of the printer. The printer settings include basic print settings such as the paper source and margins (Universal Print Settings) and HP-GL/2 specific settings such as palette settings (HP-GL/2 Unique Settings).

Basic Print Settings

- 1 Touch **Settings - General Settings - Printer Settings - Universal Print Settings** from the Home screen.

- 2 Check **Paper Source** and change the setting if necessary.

The default setting is Roll Paper. When HP-GL/2 or HP RTL print data is sent, an error occurs if paper is not loaded for the paper source set here.

- 3 Check the other items and make changes if necessary.

See the following for more details on Universal Print Settings items.

 ["General Settings - Printer Settings" on page 141](#)

HP-GL/2 Specific Print Settings

If you want to change HP-GL2 specific settings such as rotating print data, merging lines, and changing the Define Palette set in the application, use the following procedure.

- 1 Touch **Settings - General Settings - Printer Settings - HP-GL/2 Unique Settings** from the Home screen.

- 2 Touch and change the settings of the desired items.

See the following for more details on HP-GL/2 Unique Settings items.

 ["General Settings - Printer Settings" on page 141](#)

Printing Using the HP-GL/2 or HP RTL Mode from a Computer

Note:

When HP-GL/2 or HP RTL printing is not performed properly

The printer automatically determines whether normal printing from the printer driver or emulation printing of HP-GL/2 or HP RTL from the sent print data and then switches the print mode accordingly. If mode switching is not performed correctly and printing is not performed properly, configure the setting as follows.

- ❑ When the computer and printer are connected via USB
Select **Settings - General Settings - Printer Settings - Printing Language - USB** from the Home screen and then change the setting from **Auto** to **HP-GL/2**.
- ❑ When the computer and printer are connected via a network
Select **Settings - General Settings - Printer Settings - Printing Language - Network** from the Home screen and then change the setting from **Auto** to **HP-GL/2**.

To print from the printer driver as usual after HP-GL/2 or HP RTL finishes, return the setting to **Auto**.

- ❑ SC-T3100M Series/SC-T3100 Series/
SC-T3100N Series/SC-T2100 Series:
HP Designjet 750C C3195A

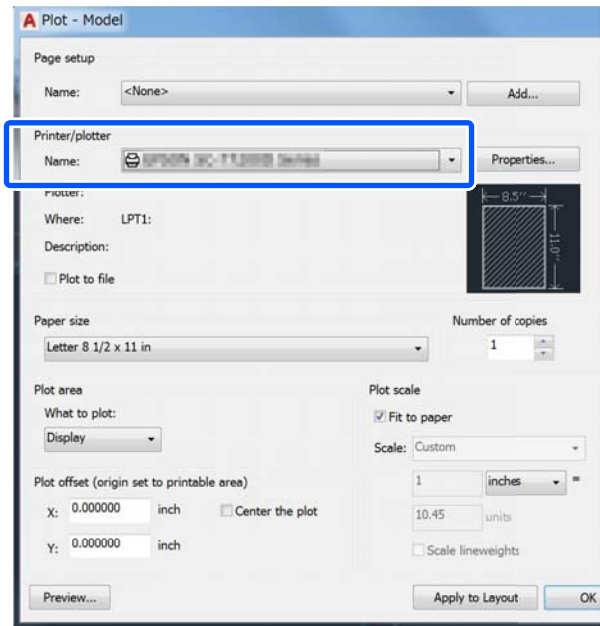

CAD Application Settings

Set the output device as follows according to your model. This explanation uses AutoCAD 2018 as an example.

- 1 Click **Plot**.

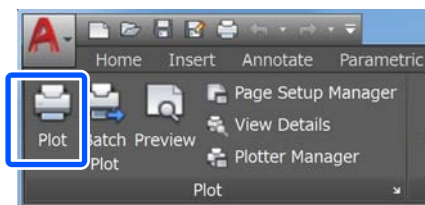

- 2 Set the plotter in **Printer/plotter**.

- ❑ SC-T5100M Series/SC-T5100 Series/
SC-T5100N Series:
HP Designjet 750C C3196A

Changing the Network Connection Methods

Changing the Network Connection Methods

The printer can connect to a wired LAN or a wireless LAN. Furthermore, it also supports Wi-Fi Direct (Simple AP) which allows a smart device or other device to directly connect wirelessly with the printer even when there is no wired LAN or wireless LAN environment.

The printer cannot connect to a wired LAN and wireless LAN at the same time. A Wi-Fi Direct connection is possible regardless of whether or not the printer is connected to a network.

This section describes the procedures to use to switch the connection method.

Note:

See the *Administrator's Guide (online manual)* for details on the network settings.

Switching to Wired LAN

- 1 Touch  on the Home screen.

Note:

The shape and color of the icon differ depending on the connection status.

 ["Understanding and Operating the Screen" on page 14](#)

- 2 Touch **Description**.
- 3 Touch **Wired LAN Connection Method**.
- 4 Touch **Start Setup**.

The process to disable the wireless LAN connection with the access point starts. Wait until the **The Wi-Fi connection is disabled** message appears.

- 5 Connect your router and the printer with a LAN cable.

See the following for the location of the printer's LAN port.

 ["Back" on page 12](#)

Switching to Wireless LAN

The SSID (network name) and password of the access point to which the printer is to be connected are required. Confirm them in advance. The printer can be connected to a wireless LAN while the LAN cable is still connected.

Note:

If your access point supports WPS (Wi-Fi Protected Setup), the printer can be connected using **Push Button Setup (WPS)** or **PIN Code Setup (WPS)** without using an SSID and password.

 ["General Settings - Network Settings" on page 151](#)

- 1 Touch  on the Home screen.

Note:

The shape and color of the icon differ depending on the connection status.

 ["Understanding and Operating the Screen" on page 14](#)

- 2 Touch **Router**.
- 3 Touch **Start Setup**.
Details of the wired LAN connection status are displayed.
- 4 Touch **Change to Wi-Fi connection.**, check the displayed message, and touch **Yes**.
- 5 Touch **Wi-Fi Setup Wizard**.
- 6 Select the desired SSID.
If the desired SSID is not displayed, touch **Search Again** to update the list. If it is still not displayed, touch **Enter Manually** and directly enter the SSID.

Changing the Network Connection Methods

7 Touch **Enter Password** and enter the password.

Note:

- Differentiate between uppercase and lowercase when entering the password.
- If the SSID was entered directly, set **Password** to **Available** before entering the password.

8 When input is finished, touch **OK**.

9 Check the settings and then touch **Start Setup**.

10 Touch **OK** to finish the procedure.

If the connection fails, select **Print Check Report** to print a network connection check report. You can check the action to take in the report.

11 Close the Network Connection Settings screen.

Directly Connecting Wirelessly (Wi-Fi Direct)

A direct connection with the printer can be established temporarily when, for example, the printer is not connected to a network or you do not have permission to log on to the network.

Wi-Fi Direct is disabled by default. The following describes the procedure from enabling Wi-Fi Direct to connecting.

Note:

The printer can connect with up to four smart devices or computers at the same time. If you want to connect another device when there are already four devices connected, disconnect the connection to the printer from a device that is already connected.

1 Touch  on the Home screen.

Note:

The shape and color of the icon differ depending on the connection status.

 [“Understanding and Operating the Screen” on page 14](#)

2 Touch **Wi-Fi Direct**.

When Wi-Fi Direct is already enabled, the network (SSID), password, number of connected devices, and so on are displayed. Proceed to step 5.

Note:

If a part of the displayed network (SSID) or device name, and so on cannot be seen because it is cut off at the right edge of the screen, touch the corresponding item to display the entire setting value.

3 Touch **Start Setup**.

4 Touch **Start Setup**.

Wi-Fi Direct is enabled, and the network (SSID) and password are displayed.

5 Open the Wi-Fi setting screen on the device you want to connect with the printer, select the SSID displayed on the screen of the printer, and enter the password just as it is displayed on the screen.

6 When a connection is established, touch **Close** to finish the procedure.

7 Touch **Close** on the screen of the printer to close the network connection settings screen.

When the printer driver is installed on the connected device, you can print using the printer driver.

Note:

When you turn off the power of the printer, the connections with connected devices are all disconnected. To reconnect after turning the printer back on, perform the procedure again from step 1.

Using AirPrint

Using AirPrint

AirPrint enables instant wireless printing from iPhone, iPad, iPod touch, and Mac without the need to install drivers or download software.



Note:

If you disabled paper configuration messages on your product control panel, you cannot use AirPrint. See the link below to enable the messages, if necessary.

- 1** Load paper in your product.
- 2** Set up your product for wireless printing. See the link below.
<http://epson.sn>
- 3** Connect your Apple device to the same wireless network that your product is using.
- 4** Print from your device to your product.

Note:

For details, see the AirPrint page on the Apple website.

Printing without Using the Printer Driver(SC-T5100M Series/SC-T3100M Series only)

Printing without Using the Printer Driver (SC-T5100M Series/SC-T3100M Series only)

This section explains how you can print, even if the printer driver is not installed on your computer, if you are connected to a network; it also explains how to connect a USB flash memory to the printer and print the files on the USB flash memory.

Printing Directly Over the Web (Upload and Print)

Function Summary

Upload and Print is a function that prints by running Web Config from a computer on which the printer driver is not installed.

☞ “How to Use Web Config” on page 26

You can print by simply selecting the file you want to print, and then uploading it to the printer. If the browser you are using supports drag and drop, you can upload multiple files in a batch and print them in order.

The following are files that can print from an upload.

- JPEG
- HP-GL/2
- TIFF
- PDF (Only data created using the scan function provided by Epson inkjet printers)

Upload and Print Procedure

- 1 Load the paper into the printer.
 - ☞ “Loading Roll Paper” on page 30
 - ☞ “Loading paper into the auto sheet feeder” on page 36
 - ☞ “Loading Cut Sheet(1 sheet)” on page 40
- 2 Start Web Config.
 - ☞ “How to Start” on page 26
- 3 The **Print** tab appears. Click **Upload and Print**.

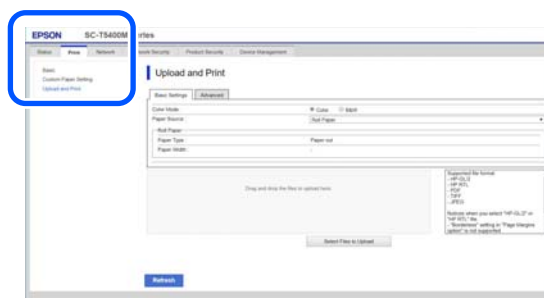

Note:

If the **Print** tab does not appear, contact your system administrator.

- 4 Do the settings for printing.
 - Select Color Mode and Paper Source in **Basic Settings**.

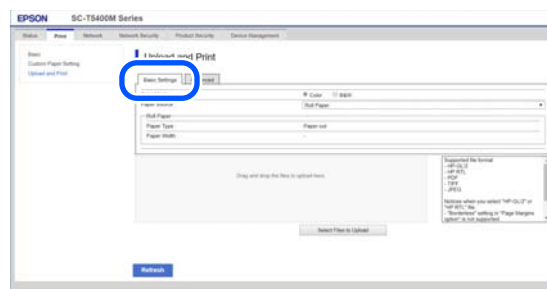

Printing without Using the Printer Driver(SC-T5100M Series/SC-T3100M Series only)

Do the settings, such as Quality, from **Advanced**.

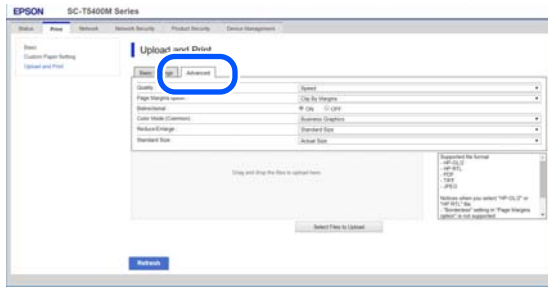

5 Start printing by dragging and dropping the data.

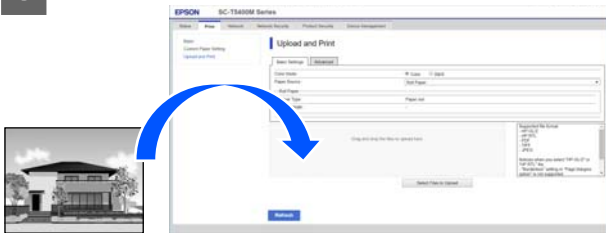

Printing Files from a Shared Folder (Print from Folder)

Function Summary

You can select and print a file from a shared folder on the network that has been setup in advance.

Do the settings for the shared folder on the printer's screen or on Web Config.

[“Preparing a Shared Folder” on page 100](#)

The following files can be printed from a network folder/FTP.

- JPEG
- HP-GL/2
- TIFF
- PDF (Only data created using the scan function provided by Epson inkjet printers)

Preparing a Shared Folder

Setup from the printer

- 1** Touch **Settings** on the Home screen.
- 2** Touch **General Settings - Network Settings - Advanced - Shared Folder**.

The shared folder settings screen appears.

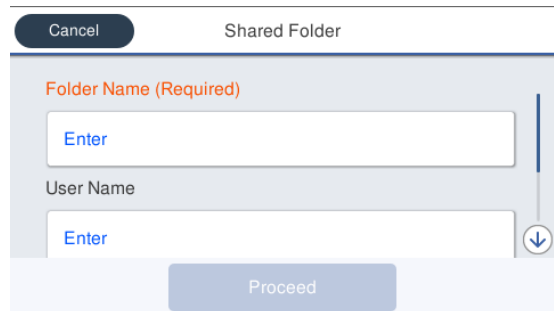

- 3** Enter each item.
 - Folder Name: Within 255 characters, enter the network path for the shared folder.
 - User Name: Enter the user name that you use to log into the computer.
 - Password: Enter the password that you use to log into the computer.
- 4** Touch **Proceed** to complete the settings for the shared folder.

Setup from Web Config

- 1** Start Web Config.
 - [“How to Start” on page 26](#)
- 2** The **Print** tab appears. Click **Basic**.



Printing without Using the Printer Driver(SC-T5100M Series/SC-T3100M Series only)

Note:

If the **Print** tab does not appear, contact your system administrator.

3 Enter each item for **Print from Folder**.

- Print from Folder: Select enable.
- Folder Name: Enter the network path for the shared folder.
- User Name: Enter the user name that you use to log into the computer.
- Password: Enter the password that you use to log into the computer.

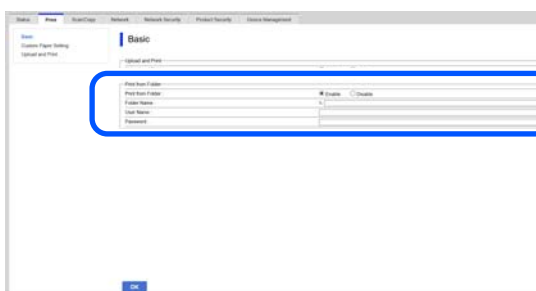

4 Click **OK** to complete the settings for the shared folder.

Print from Folder Procedure

The procedure to print from a folder from the printer's screen is as follows.

1 On the Home screen, touch **Network Folder**.

After a short while, a list of the files in the shared folder appears.

2 Select 1 file to print.

3 Select **Black/White** or **Color**.

Using advanced settings such as enlarging or reducing size

Proceed to step 4.

Printing at actual size without advanced settings

Proceed to step 5.

4 Touch the **Advanced** tab.

Enlarge/reduce settings can be configured in Reduce/Enlarge. If you set **Auto Fit Page** to **On**, printing is performed by automatically enlarging to fit the width of the roll paper or the size of the cut sheet paper loaded in the printer.

See the following for more details on other settings items.

[🔗 “Network Folder Menu \(SC-T5100M Series/SC-T3100M Series Only\)” on page 178](#)

Note:

- If **HP-GL/2** files are selected in **Page Margins option - Borderless**, either **Clip By Margins** or **Oversize** in **Settings - General Settings - Printer Settings - Universal Print Settings - Page Margins option** is applied.
- You can select **Reduce/Enlarge** in **HP-GL/2** files, but it is not applied.

5 Touch the **Print** button.

Printing Files on USB Flash Memory Directly

You can connect a USB flash memory* to this printer and print files stored on the memory directly from this printer.

* Be sure to use a USB flash memory that supports FAT and exFAT file systems. However, you cannot use USB flash memories with security functions such as password protected ones.

The following files can be printed directly.

- JPEG
- HP-GL/2
- TIFF
- PDF (Only data created using the scan function provided by Epson inkjet printers)

Printing without Using the Printer Driver(SC-T5100M Series/SC-T3100M Series only)

- 1** Connect the USB flash memory, in which the data to be printed is saved, to the printer.

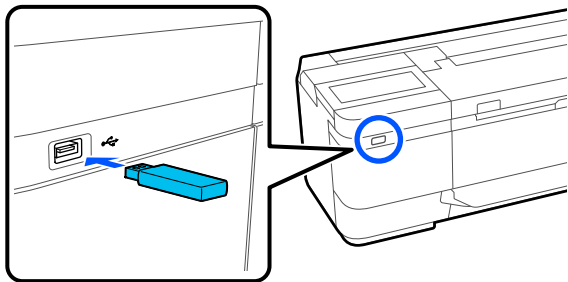

- 2** Touch **Memory Device** on the Home screen.

- 3** Touch the print menu that matches the file format you want to print.

- 4** Select 1 file to print.

When selecting JPEG

Touch to select the file image to print, then touch **Proceed to Print**.

This will add a check mark to the selected image. Touch **Single View** to enlarge the selected image to confirm. To change the display order of files, touch .

Except when selecting JPEG

From the list, touch a file name to select it. To change the display order of files, touch .

Note:

Any characters in the folder or file names that cannot be displayed by the printer will be displayed as "?".

- 5** Select **Black/White** or **Color**.

Using advanced settings such as enlarging or reducing size

Proceed to step 6.

Printing at actual size without advanced settings

Proceed to step 7.

- 6** Touch the **Advanced** tab.

Enlarge/reduce settings can be configured in Reduce/Enlarge. If you set **Auto Fit Page** to **On**, printing is performed by automatically enlarging to fit the width of the roll paper or the size of the cut sheet paper loaded in the printer.

See the following for more details on other settings items.

[“Memory Device menu \(SC-T5100M Series/SC-T3100M Series only\)”](#) on page 163

Note:

You can register and save frequently used settings as presets. See the following for more details.

[“Using your Presets”](#) on page 16

- 7** Touch the numeric value for the number of prints and then enter the number of prints in the keypad screen.

Note:

You can use the **Preview** button to check the print image (JPEG or TIFF only).

- 8** Touch the **Print** button.

Copy (SC-T5100M Series/SC-T3100M Series only)

Copy (SC-T5100M Series/SC-T3100M Series only)

Placing Documents in the Scanner

You can load one document.

The document sizes and paper types that can be loaded and the documents that cannot be loaded are as follows.

Important:

If a document covered in dust is loaded, the dust may adhere inside the scanner and decrease the quality of copied or scanned images. Before loading a document into the scanner, remove any dust from the document.

Loadable Document Sizes

Document width : SC-T5100M Series: 148 mm to 915 mm (36 inches)
SC-T3100M Series: 148 mm to 610 mm (24 inches)

Document length : 148 mm to 2720 mm*

Document thickness : 0.5 mm or less (or 0.25 mm or less with the optional carrier sheet)

* Maximum length of 2672 mm for scanning (600 dpi) and copying (Fine, Super Fine) only

Loadable Paper Types

- Plain paper
- Recycled

- Coated paper
- Tracing Paper
- Film
- Blueprint
- Actual printing stock
- Carrier sheet

Important:

*If tracing paper is loaded, the printer cannot automatically detect the width. On the control panel, set **Original Size** or **Scan Size**.*

 *“Copy Menu (SC-T5100M Series/SC-T3100M Series Only)” on page 166*

 *“Scan Menu (SC-T5100M Series/SC-T3100M Series Only)” on page 169*

Documents That Cannot Be Loaded

Do not load originals such as the following. Failure to observe this precaution could cause paper jams or damage the printer.

- Originals that are bound
- Originals that are bent
- Originals with carbon backing
- Originals that are attached with staples, paper clips, or glue
- Originals that have many holes, such as loose leaf paper
- Originals that are shaped irregularly or not cut at right angles
- Originals with photos, stickers, or labels attached
- Originals that are transparent
- Originals that are glossy
- Originals that have become deteriorated

Copy (SC-T5100M Series/SC-T3100M Series only)

- ❑ Originals that are torn

When loading documents that are thin, that are easily torn, or that you do not want to damage

Use the optional carrier sheet for thin documents and documents that you do not want to damage.

🔗 “Options and Consumable Products” on page 206

! Important:

Notes on Using the Carrier Sheet

When scanning using a carrier sheet, the paper color (background color) of the document may remain in the scan results, or wrinkle shadows may appear.

*If you are concerned about these issues, try making adjustments in **Remove Background**.*

Removing the background

- ❑ *When copying*
Select **Copy - Basic Settings - Image Quality - Remove Background - Auto - Off** on the Home screen, and then set the adjustment value to a positive value from -4 to 4.
🔗 “Copy Menu (SC-T5100M Series/SC-T3100M Series Only)” on page 166
- ❑ *When scanning and saving to an email or folder*
Select **Scan** on the Home screen, and then select **Email** or **Network Folder/FTP** depending on the target location.
Select **Scan Settings - Image Quality - Remove Background - Auto - Off**, and then set the adjustment value to a positive value from -4 to 4.
🔗 “Scan Menu (SC-T5100M Series/SC-T3100M Series Only)” on page 169
- ❑ *When saving scanned data to an external memory device*
Select **Scan - Advanced - Image Quality - Remove Background - Auto - Off** on the Home screen, and then set the adjustment value to a positive value from -4 to 4.
🔗 “Scan Menu (SC-T5100M Series/SC-T3100M Series Only)” on page 169

Documents That Need the Carrier Sheet

- ❑ Valuable documents that you do not want to damage (documents on loan, master copies, old drawings, antique maps, works of art, etc.)
- ❑ Documents with fragile surfaces and/or materials (collages, newspapers, rice paper, oil pastel drawings, etc.)
- ❑ Transparent and translucent film

Notes for When Putting Documents into the Carrier Sheet

Insert the document in the carrier sheet as shown.

- ❑ Insert the document with the side to be scanned facing the transparent sheet.
- ❑ Align the top edge of the document with part **A** of the carrier sheet.
- ❑ Align the side of the document with line **B**.

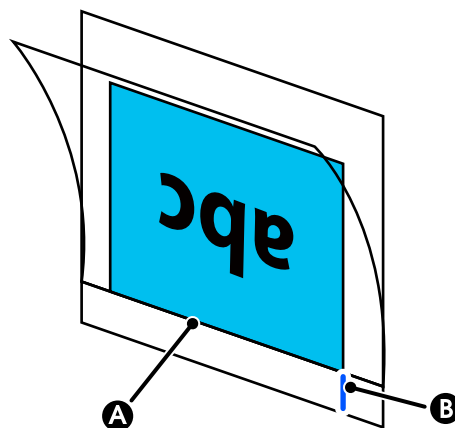

! Important:

*If the carrier sheet is loaded, the printer cannot automatically detect the width. On the control panel, set the **Original Size** or the **Scan Size** and **Top Offset**.*

🔗 “Copy Menu (SC-T5100M Series/SC-T3100M Series Only)” on page 166

🔗 “Scan Menu (SC-T5100M Series/SC-T3100M Series Only)” on page 169

Copy (SC-T5100M Series/SC-T3100M Series only)

How to Load Documents

Important:

- ❑ If the original tends to curl, load the original after straightening the curl.
- ❑ Smooth the creases in the original, and then load it.

Note:

For a document longer than 1 meter, support the document with your hand so it does not skew as it feeds.

- 1 Make sure the document guide is placed.

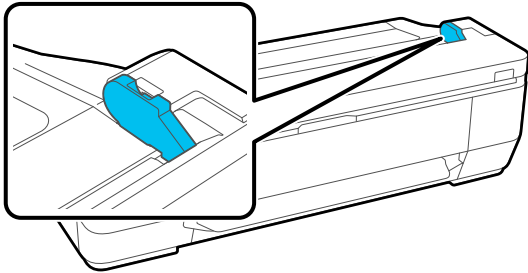

Remove the document guide when scanning using a carrier sheet.

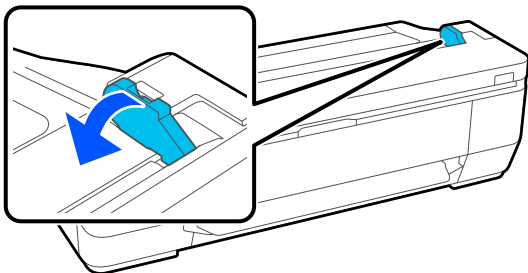

- 2 With the scanning side facing up, align the right edge of the document with the document guide, and then insert the leading edge of the document into the paper slot.

Load the document in the direction indicated by the illustration.

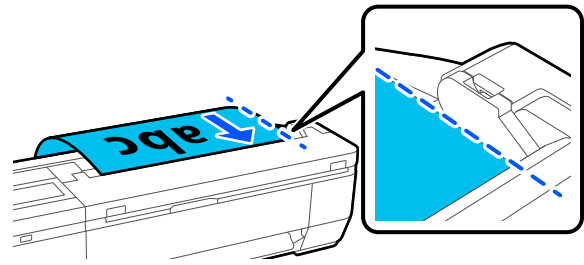

When the leading edge touches the back of the paper slot, the document is automatically fed to the scanning start position. When automatic paper feeding starts, let go of the document and do not interfere with the document feeding operation. When you hear a beep, feeding is complete.

Note:

- ❑ Make sure you insert the document straight while supporting the document with your hands on either side.
- ❑ If the document is thin paper, carefully stretch it to the left or right to smooth out any wrinkles, and then insert it.
- ❑ This printer comes with a document support that prevents documents from falling off the back.

If necessary, place the document support in the cable holder at the back.

If the power cable is attached to the cable holder, you must disconnect the power cable before attaching the document support.

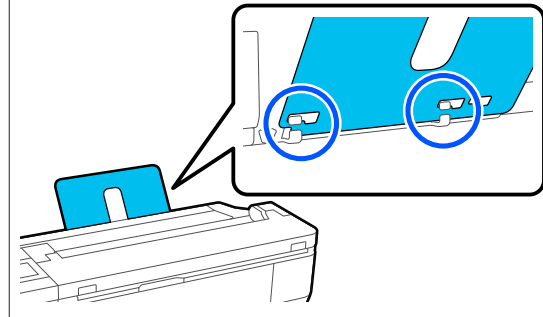

Procedure for Copying

- 1 Load the paper into the printer.
 ➤ [“Loading and Setting the Paper” on page 29](#)
- 2 Load the document into the printer.
 ➤ [“How to Load Documents” on page 105](#)

Copy (SC-T5100M Series/SC-T3100M Series only)

3 Touch **Copy** on the Home screen.

4 In **Basic Settings**, do the settings for Color, Quality, Density, and Reduce/Enlarge.

[☞](#) “Copy Menu (SC-T5100M Series/SC-T3100M Series Only)” on page 166

If you are doing detailed settings, such as Original Type, do the settings from **Advanced**.

[☞](#) “Copy Menu (SC-T5100M Series/SC-T3100M Series Only)” on page 166

If you are using the optional carrier sheet, you must do the following settings in **Advanced**.

- Specify a user defined size as the **Original Size**.
- Set **Top Offset** to 19 mm.

Note:

You can register and save frequently used settings as presets. See the following for more details.

[☞](#) “Using your Presets” on page 16

5 Touch the numeric value for the number of prints and then enter the number of prints in the keypad screen.

6 Press the **Copy** button to start scanning the document.

! Important:

Do not press down on the scanner cover or place anything on top of it while copying.

Otherwise, the copy results may be distorted or the original may get jammed.

While scanning, hold the original with both hands so that it does not skew.



7 Remove the original when scanning is complete.

While holding the original, press the **OK** button on the screen, and then remove the original.

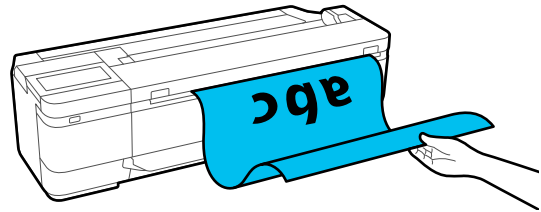

Printing starts when the original has been completely removed.

Scan (SC-T5100M Series/SC-T3100M Series only)

Scan (SC-T5100M Series/SC-T3100M Series only)

Function Summary

The following are 3 ways that you can save or send the data of scanned images.

Network Folder/FTP: Save the scanned image in a folder via the network. For the recipient, you can specify a shared folder (a folder that uses SMB protocol) that was created on a computer or a folder on the FTP server. You must do the settings for the shared folder or FTP server in advance.

Email: Attach the scanned image directly into an email to be able to send it from the printer. You must register an email server and do its settings in advance.

Memory Device: You can save the scanned image to a USB flash memory that is installed in the printer. You do not have to do any settings in advance.

Preparing to Scan

The following settings must be done in advance to save a scanned image to a folder or send a scanned image via email.

- Shared folder settings and FTP server settings
Do the settings in Web Config. See the *Administrator's Guide* for more details.
- Mail server settings
Do the settings in Web Config. See the *Administrator's Guide* for more details.

- Settings for the recipient email addresses and the contacts for the shared folder
Do the settings from the printer's screen or from Web Config. This section explains the contacts settings in the shared folder from the printer's screen.
See the *Administrator's Guide* for how to do settings in Web Config.

Creating Contacts

- 1** Touch **Settings** on the Home screen.
- 2** Touch, in order, **Contacts Manager - Register/Delete**.
- 3** Touch, in order, **Add Entry - Add Contact - Network Folder/FTP**.

The Add Entry screen appears.

The screenshot shows the 'Add Entry' screen with the following fields:

- Registry Number:** A text input field containing '0001'.
- Name:** A text input field with the placeholder text 'Enter Name.'
- Index Word:** A text input field with a downward arrow icon on the right side.

At the top of the screen, there are three buttons: 'Cancel', 'Add Entry', and 'OK'.

- 4** Check the details for each item and input any necessary information.
 - Registry Number:** Set a registry number for the address.
 - Name:** Name that appears in your contacts (up to 30 characters).
 - Index Word:** Use to search your contacts (up to 30 characters).
 - Communication Mode:** Select SMB.
 - Location:** Enter a shared folder's network path (within 255 characters). When you enter letters, numbers, and symbols, specify single-byte and double-byte characters correctly. If the setting for single-byte and double-byte characters is incorrect, you will not be able to save to the shared folder.
 - User Name:** Enter the user name that you use to log into the computer.
 - Password:** Enter the password that you use to log into the computer.

Scan (SC-T5100M Series/SC-T3100M Series only)

- ❑ Assign to Frequent Use: Register an address for frequent use. When an address is specified, it will appear on the top screen.

Note:

If you do not have a password set on your computer, you do not have to enter a user name or password.

- 5 Touch **OK** to finish registering a shared folder to your contacts.

Procedure for Scanning



These settings must be done in advance to save a scanned image to a folder or send a scanned image via email.

 [“Preparing to Scan” on page 107](#)

Scanning and Saving an Image to a Shared Folder or FTP Server

Note:

First, check that the printer's **Date/Time** and **Time Difference** are set correctly. From the control panel, select, in order, **Settings - General Settings - Basic Settings - Date/Time Settings**.

- 1 Load the original.
 -  [“Placing Documents in the Scanner” on page 103](#)
 -  [“How to Load Documents” on page 105](#)
- 2 Touch **Scan** on the Home screen.
- 3 Touch **Network Folder/FTP**.
A screen from which you specify a location appears.

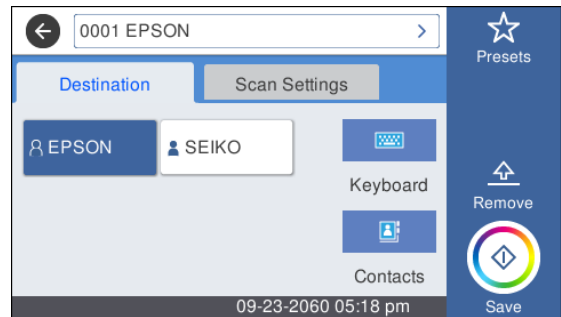

- 4 Specify the Location using one of the 3 following methods.
 - ❑ Select a recipient that is registered for frequent use: Touch the icon that is displayed.
 - ❑ Keyboard: Touch **Keyboard**. Select **Communication Mode** and enter the location in **Location (Required)**. Set any other locations as necessary.
Enter the Location in the following formats.
If the communication mode is SMB (when using a shared folder on a computer): \\host name (server name)\ folder path
If the communication mode is FTP (when using an FTP server): ftp://host name (server name)/folder path
 - ❑ Select from the contacts: Touch **Contacts**, select a recipient, and then touch **Close**. You can search the folders from your contacts. Enter search keywords into the search box at the top of the screen.

Note:

You can print a history of the saved folders by touching .

- 5 Touch **Scan Settings**, and then do the settings for scanning.
Select settings, such as the Color Mode and the File Format.
 -  [“Scan Menu \(SC-T5100M Series/SC-T3100M Series Only\)” on page 169](#)
 If you are using the optional carrier sheet, you must do the following settings.
 - ❑ Specify a user defined size as the **Scan Size**.
 - ❑ Set **Top Offset** to 19 mm.

Scan (SC-T5100M Series/SC-T3100M Series only)

Note:
 You can register and save frequently used settings as presets. See the following for more details.
 ☞ [“Using your Presets” on page 16](#)

6 Press the **Save** button to start scanning.

! Important:
 Do not press down on the scanner cover or place anything on top of it while scanning.
 Otherwise, the scan results may be distorted or the original may get jammed.

While scanning, hold the original with both hands so that it does not skew.



7 Remove the original when scanning is complete.

While holding the original, press the **OK** button on the screen, and then remove the original.

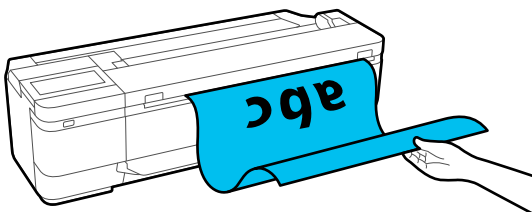

Scanning and Attaching an Image to an Email

1 Load the original.
 ☞ [“Placing Documents in the Scanner” on page 103](#)
 ☞ [“How to Load Documents” on page 105](#)

2 Touch **Scan** on the Home screen.

3 Touch **Email**.
 A screen from which you specify a recipient appears.

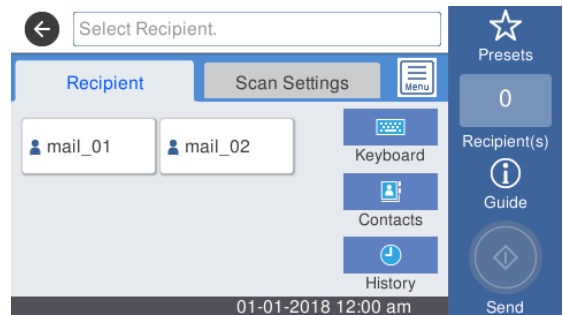

4 Specify the recipient using one of the 4 following methods.

- Select a recipient that is registered for frequent use: Touch the icon that is displayed.
- Keyboard: Touch **Keyboard** and enter a recipient. Touch **OK**.
- Select from your contacts: Touch **Contacts**, select a recipient or group, and then touch **Close**.
 You can search the recipients from your contacts. Enter search keywords into the search box at the top of the screen.
- Select from your history: Touch **History**, select a recipient, and then touch **Close**.

Note:

- The number of recipient that you have selected appears on the right side of the screen. You can send an email to up to 10 recipients (email addresses or groups).
 If you include a group in your recipients, you can also add the addresses in the group and send an email to up to 200 email addresses.
- You can check a list of the selected addresses by touching the box at the top of the screen.
- Touch  to change your email server settings.

5 Touch **Scan Settings**, and then do the settings for scanning.

Select settings, such as the Color Mode and the File Format.

☞ [“Scan Menu \(SC-T5100M Series/SC-T3100M Series Only\)” on page 169](#)

If you are using the optional carrier sheet, you must do the following settings.

- Specify the **Scan Size** from a standard size.
- Set **Top Offset** to 19 mm.

Scan (SC-T5100M Series/SC-T3100M Series only)

Note:
 You can register and save frequently used settings as presets. See the following for more details.
 ☞ “Using your Presets” on page 16

- 6** Press the **Save** button to start scanning.
- 7** Remove the original when scanning is complete.
 While holding the original, press the **OK** button on the screen, and then remove the original.

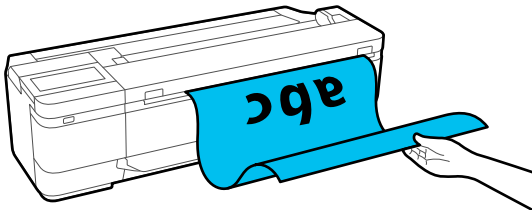

Scanning and Saving an Image to a Memory Device

- 1** Connect a USB flash memory to the printer.

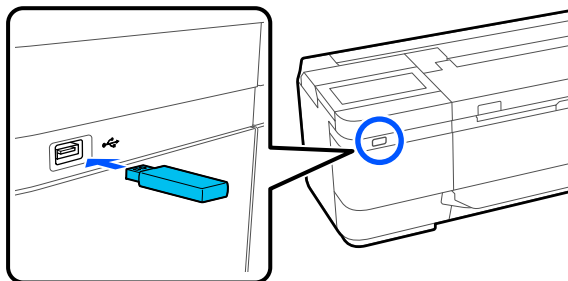

- 2** Load the original.
 ☞ “Placing Documents in the Scanner” on page 103
 ☞ “How to Load Documents” on page 105
- 3** Touch **Scan** on the Home screen.
- 4** Touch **Memory Device**.
- 5** In **Basic Settings**, select settings, such as Color Mode or File Format.
 ☞ “Scan Menu (SC-T5100M Series/SC-T3100M Series Only)” on page 169

If you are setting the scanning density, do the setting from **Advanced**.

☞ “Copy Menu (SC-T5100M Series/SC-T3100M Series Only)” on page 166

If you are using the optional carrier sheet, you must do the following settings.

- Specify the **Scan Size** from a standard size.
- Set **Top Offset** to 19 mm.

Note:
 You can register and save frequently used settings as presets. See the following for more details.
 ☞ “Using your Presets” on page 16

- 6** Press the **Save** button to start scanning.
- 7** Remove the original when scanning is complete.
 While holding the original, press the **OK** button on the screen, and then remove the original.

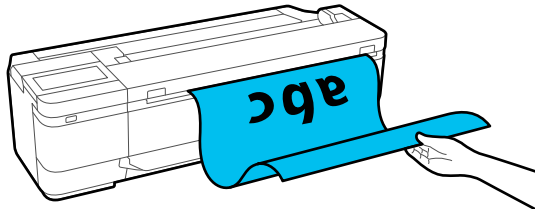

Making Enlarged Copies with an A3 or A4 Scanner (Except for the SC-T5100M Series/SC-T3100M Series)

Making Enlarged Copies with an A3 or A4 Scanner (Except for the SC-T5100M Series/SC-T3100M Series)

Connecting an Epson A3 or A4 scanner to the printer makes creating enlarged copies a snap; no computer is required.

Supported scanners

- DS-530
- DS-6500
- DS-60000

Check the Epson website for the latest information on supported scanners.

<https://www.epson.com>

Supported Sizes

Document Size ^{*1}	Output Size
5 x 7 inch	A2
Letter	US C (17x22in)
A5	JIS B2
B5	US D (22x34in)
A4	A1
B4	JIS B1 ^{*2}
A3	US E (34x44in) ^{*2}
	A0 ^{*2}
	User Defined ^{*3}

^{*1} Differs depending on the specifications of the scanner to be connected.

^{*2} Not supported by the SC-T3100 Series/SC-T3100N Series/SC-T2100 Series

^{*3} 89 to 914 mm width (up to 610 mm for the SC-T3100 Series/SC-T3100N Series/SC-T2100 Series)

Supported paper

Roll paper only. Enlarged copying to cut sheet is not possible.

Connecting the Scanner

- 1** Ready both the printer and the scanner.
For information on setting up the scanner, see the documentation supplied with the scanner.
- 2** Turn the printer and scanner off.

Making Enlarged Copies with an A3 or A4 Scanner (Except for the SC-T5100M Series/SC-T3100M Series)

- 3 Connect the scanner to the printer using the USB cable supplied with the scanner.

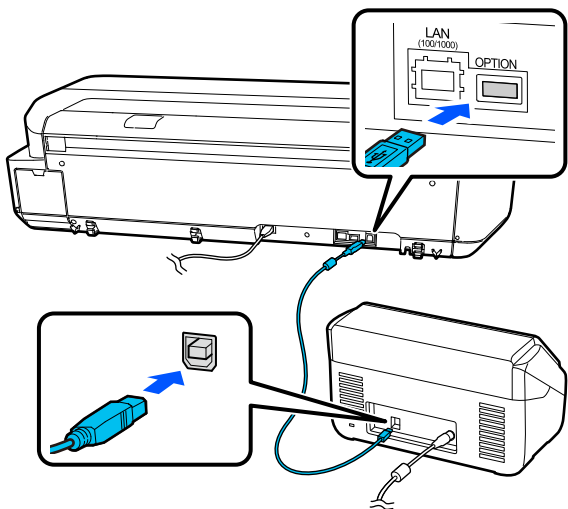

! Important:
 Connect the scanner directly to the printer. Enlarged copies are only available when the scanner is connected directly to the printer.

Making Enlarged Copies

- 1 Turn the printer and scanner on.
 The devices may be turned on in any order.
- 2 Load roll paper supported by the enlarged copying function into the printer.
[“Loading Roll Paper” on page 30](#)
- 3 Place the document on the scanner glass or in the auto document feeder (ADF).
[“Placing Documents in the Scanner” on page 113](#)
 For information on using the scanner, see the documentation supplied with the device.
- 4 Touch **Enlarged Copy** on the Home screen.
 The enlarged copy dialog box is displayed.

Note:
 If **Enlarged Copy** is not displayed on the Home screen, check the following.

- Are the connectors of the USB cable connecting the printer and scanner inserted firmly?
- Is the power of the scanner on?
- Is the scanner a model that supports enlarged copying?

- 5 Select the size of the document loaded in the scanner in **Original Size** and set the enlargement setting in **Reduce/Enlarge**.

If you set **Auto Fit Page** to **On**, printing is performed by automatically enlarging to fit the width of the roll paper loaded in the printer.

! Important:
 The image quality may decline or streaks may appear depending on the document or magnification.
 If streaks appear, try performing paper adjustment.
[“Optimizing Paper Settings \(Media Adjust\)” on page 46](#)
 If the problem is not resolved, refer to the scanner manual and then clean the inside of the scanner.

Note:
 You can register and save frequently used settings as presets. See the following for more details.
[“Using your Presets” on page 16](#)

- 6 Touch the numeric value for the number of copies and then enter the number of copies in the keypad screen.
- 7 Touch to start copying.
 Copying can also be started by touching the button of the scanner.

Making Enlarged Copies with an A3 or A4 Scanner (Except for the SC-T5100M Series/SC-T3100M Series)

Placing Documents in the Scanner

Failure to observe the following precautions when placing the original in the scanner may result in reduced print quality or scanning failures.

- ❑ DS-530 is a scanner that scans both sides simultaneously, but it cannot scan both sides of a document with enlarged copying. Place the side you want copying facing downward in the ADF.
- ❑ Be sure to insert the original in landscape (wide) orientation.

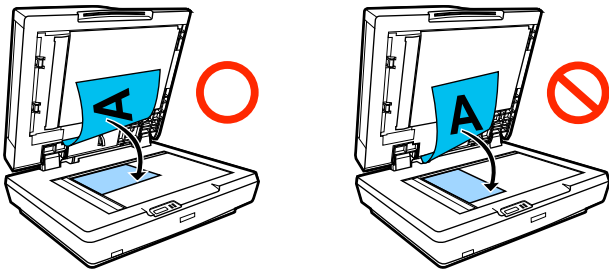

- ❑ If there are documents both on the glass and in the ADF, the document in the ADF will be scanned. Remove documents from the ADF before placing a document on the glass.
- ❑ The ADF can not be used when:
 - ❑ When **JIS B1** or **A0** is selected for Reduce/Enlarge and multiple copies will be made
 - ❑ The original is printed on thick stock (e.g., postcards or photographs)
- ❑ When multiple copies are made from an original placed on the glass, the original may be scanned once for each copy. Wait until all the copies have been printed before opening the scanner cover.
- ❑ Use the ADF to scan multi-page documents.

- ❑ If multiple copies are set for scanning multiple sheets continuously, the copies will be printed on a page basis as shown below.
Example: Order in which pages are output when the printer is used to make two copies of a two page document

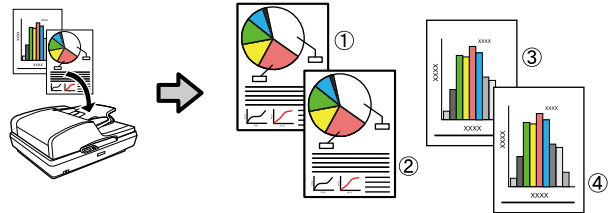

Using the Menu

Using the Menu

Menu List

The items and options available in the menu are described below. See the reference pages for more details on each item.

Paper Setting

The Paper Setting menu is displayed if paper is loaded.

Details of each item [↗](#) “Paper Setting menu” on page 132

Settings item	Settings value
Roll Paper	
Remove	Display the removal method
Feed/Cut Paper	Backward, Forward, Cut
Media Adjust	Start
Advanced Media Setting	
Platen Gap	1.6,2.1,2.6 (This is displayed when Custom Paper is selected in Paper Type.)
Top/Bottom Margins	Standard, Top 3 mm/Bottom 3 mm, Top 15 mm/Bottom 15 mm, Top 45 mm/Bottom 15 mm
Back Tension	Auto, Standard, High, Extra High
Drying Time	
Drying Time per Pass	0 to 10.0 sec
Drying Time per Page	0 to 60 min
Auto Cut	On, Off
Manage Remaining Amount	
Setup	On, Off
Remaining Amount	5.0 to 150.0 m
Remaining Alert	1.0 to 15.0 m

Using the Menu

Settings item	Settings value
Change Paper Type	
Paper Type	
Plain Paper	Display supported paper types
Coated Paper(Generic)	
Premium Glossy Sheet	
Others	
Auto Sheet Feeder	
Media Adjust	Start
Change Paper Type/Paper Size	
Paper Type	
Plain Paper	Display supported paper types
Coated Paper(Generic)	
Premium Glossy Sheet	
Others	
Paper Size	Display supported paper sizes
Cut Sheet(1 sheet)	

Using the Menu

Settings item	Settings value
Remove	Eject paper
Media Adjust	Start
Change Paper Type/Paper Size	
Paper Type	
Plain Paper	Display supported paper types
Coated Paper(Generic)	
Premium Glossy Sheet	
Others	
Paper Size	
A Series	Display supported paper sizes
US-ANSI	
US-ARCH	
B Series (ISO)	
B Series (JIS)	
Others	
User-Defined	

Printer Status

Details of each item [☞ “Printer Status menu” on page 137](#)

Settings item	Settings value
Supply Status	Display approximate remaining amounts, as well as product number of consumables
Message List	Display list of messages communicating printer status
Firmware Version	Display firmware version
Print Status Sheet	
Configuration Status Sheet	Print

Settings

Items marked with an asterisk (*) are displayed only for the SC-T5100M Series/SC-T3100M Series.

Settings item	Settings value
General Settings	

Using the Menu

Settings item	Settings value
Basic Settings (Details of each item ↗ "General Settings - Basic Settings" on page 138)	
LCD Brightness	1 to 9
Sound*	
Mute	On, Off
Button Press	0 to 10
Error Notice	0 to 10
Sound Type	Pattern1, Pattern2
Sound (except for the SC-T5100M Series/SC-T3100M Series)	
Mute	On, Off
Normal Mode	
Button Press	0 to 10
Error Notice	0 to 10
Sound Type	Pattern1, Pattern2
Sleep Timer	SC-T5100 Series/SC-T5100N Series/SC-T3100 Series/SC-T3100N Series/SC-T2100 Series: 1 to 210 mins. SC-T5100M Series/SC-T3100M Series: 1 to 60 mins.
Wake from Sleep	
Touch LCD Screen to Wake	On, Off, Scheduled (between 0:00 and 23:45 in 15 minute increments)
Power Off Timer	Off, 30minutes, 1h, 2h, 4h, 8h, 12h
Circuit Breaker Interlock Startup	On, Off
Date/Time Settings	
Date/Time	Date: yyyy.mm.dd, mm.dd.yyyy, dd.mm.yyyy Time: 12h, 24h
Time Difference	-12:45 to +13:45 (15 minute increments)
Language	Display supported languages
Operation Time Out	On, Off
Keyboard (except for the SC-T5100M Series/SC-T3100M Series)	QWERTY, AZERTY, QWERTZ
Length Unit	m, ft / in

Using the Menu

Settings item	Settings value
Printer Settings (Details of each item ↗ "General Settings - Printer Settings" on page 141)	
Paper Source Settings	
Error Notice	
Paper Size Notice	On, Off
Paper Type Notice	On, Off
Roll Paper Setup	
Detect Paper Meandering	On, Off
Print Cutting Guideline	On, Off
After-Print Options	Hold Paper, Eject Paper
Custom Paper Setting (Custom paper types 01 to 10 are displayed, and touching any of these will display settings items.)	
Change Name	Registered name input screen
Change Reference Paper	
Plain Paper	Display supported paper types
Matte Paper	
Photo Paper	
CAD	
Others	
Advanced Media Setting	
Platen Gap	1.6,2.1,2.6
Top/Bottom Margins	Standard, Top 3 mm/Bottom 3 mm, Top 15 mm/Bottom 15 mm, Top 45 mm/Bottom 15 mm
Back Tension	Auto, Standard, High, Extra High
Drying Time	
Drying Time per Pass	0.0 to 10.0 sec
Drying Time per Page	0.0 to 60 min
Auto Cut	On, Off
Restore Default	Yes, No
Printing Language	
USB	Auto, HP-GL/2
Network	Auto, HP-GL/2

Using the Menu

Settings item	Settings value
Universal Print Settings	
Paper Source	Roll Paper, Auto Sheet Feeder, Cut Sheet(1 sheet)
Quality	Standard, Speed, Fine, Super Fine
Color Mode	Color, Black/White
Page Margins option	Clip By Margins, Oversize
Page Margin	3 mm, 5 mm
Smoothing	On, Off
Base Output Size	
Auto	-
A Series	Display supported paper sizes
US-ANSI	
US-ARCH	
B Series (ISO)	
B Series (JIS)	
Others	
User-Defined	
Resolution	Standard, 300dpi, 600dpi, 1200dpi
Color Mode (Common)	EPSON Standard (sRGB), Business Graphics, GIS, Line Drawing, Off (No Color Management)
HP-GL/2 Unique Settings	
Rotate	0°,90°,180°,270°
Origin Setup	Left Edge, Center
Mirror Image	On, Off
Line Merge	On, Off
Color Mode (HP-GL/2)	EPSON Standard (sRGB), Business Graphics, GIS, Line Drawing, Off (No Color Management)
Select Palette	Software, Default, Palette A, Palette B
Print Color Palette	Print
Define Palette	
Palette A	Display screen to set pen width and pen color
Palette B	
Restore default HP-GL/2 Unique Settings	Yes, No

Using the Menu

Settings item	Settings value
Memory Device Interface*	
Memory Device	Enable, Disable
Thick Paper	Off, On
Bidirectional	On, Off
PC Connection via USB	Enable, Disable
USB I/F Timeout Setting	0 sec, or 5 to 300 sec
Network Settings (Details of each item ↗ "General Settings - Network Settings" on page 151)	
Wi-Fi Setup	
Router	
Connect via Wi-Fi	When wireless LAN connection disabled: Display Connect via Wi-Fi menu When wireless LAN connection connected: Display connection status and settings information
Wi-Fi Setup Wizard	
Push Button Setup(WPS)	
Others	
PIN Code Setup(WPS)	
Wi-Fi Auto Connect	
Disable Wi-Fi	
Wi-Fi Direct	
Wi-Fi Direct	When Wi-Fi Direct disabled: Display Wi-Fi Direct wizard When Wi-Fi Direct enabled: Display settings information and number of connected devices
Change Network Name*	
Change Password	
Disable Wi-Fi Direct	
Delete Registered Device (SC-T5100 Series/ SC-T5100N Series/SC-T3100 Series/ SC-T3100N Series/SC-T2100 Series only)	
Restore Default Settings*	
Wired LAN Setup	Start Setup (Displayed when connected to a wireless LAN.)
Network Status	
Wired LAN/Wi-Fi Status	Display current connection settings
Wi-Fi Direct Status	
Email Server Status*	Display setting items
Print Status Sheet	Print
Connection Check	Start network connection check

Using the Menu

Settings item	Settings value
Advanced	
Device Name	Display settings change screen
TCP/IP	
Proxy Server	
Email Server *	Display General Settings - Scan Settings - Email Server
Shared Folder *	Display settings change screen
IPv6 Address	Enable, Disable
Link Speed & Duplex	Auto, 10BASE-T Half Duplex, 10BASE-T Full Duplex, 100BASE-TX Half Duplex, 100BASE-TX Full Duplex
Redirect HTTP to HTTPS	Enable, Disable
Disable IPsec/IP Filtering	Proceed
Disable IEEE802.1X	(Displayed when enabled.)
iBeacon Transmission *	Enable, Disable
Scan Settings* (Details of Each Item  "General Settings - Scan Settings (SC-T5100M Series/SC-T3100M Series only)" on page 153)	
Confirm Recipient	On, Off
Email Server	
Server Settings	Off, POP before SMTP, SMTP-AUTH
Connection Check	Start a test
Scan Options	
Confirm Before Ejecting Scanned Document	On, Off
Correct Skewed Image	On, Off
Document Feed Adjustment	-1.00 to 1.00
Image Stitching Smoother	On, Off
Image Stitching Adjustment	-5 to 5

Using the Menu

Settings item	Settings value
System Administration (Details of each item  "General Settings - System Administration" on page 156)	
Contacts Manager *	
Register/Delete	Display the Register/Delete screen for Contacts
Frequent	
Email	Display the screen for registering frequently used addresses
Network Folder/FTP	Display the screen for registering frequently used addresses
Print Contacts	
List of all Contacts	Specify the print area, and then print
List of Email Contacts	Specify the print area, and then print
List of Folder/FTP Contacts	Specify the print area, and then print
View Options	Tile View, List View
Search Options	Begins with, Ends with, Includes
Security Settings	
Restrictions *	
Job log access	Off, On
Access to Register/Delete Contacts	Off, On
Access to Recent of Scan to Email	Off, On
Access to Show Sent History of Scan to Email	Off, On
Access to Language	Off, On
Access to Thick Paper	Off, On
Protection of Personal Data	Off, On
Access Control *	Off, On
Admin Settings	
Admin Password	Register, Change, Clear All Settings
Lock Setting	Off, On
Restore Default Settings	
Network Settings	Yes, No
Copy Settings*	Yes, No
Scan Settings*	Yes, No
Clear All Data and Settings	Yes, No

Using the Menu

Settings item	Settings value
Firmware Update	
Update	Start Checking
Notification	Off, On
Supply Status	Display approximate remaining amounts, as well as product number of consumables
Maintenance (Details of each item ↗ "Maintenance" on page 159)	
Print Quality Adjustment	Paper Source, Start
Print Head Nozzle Check	Paper Source, Start
Head Cleaning	Start
Paper Guide Cleaning	Start
Ink Cartridge(s) Replacement	Start
Replace Maintenance Box	Display procedure
Replace Cutter	Start
Powerful Cleaning	Start
Discharging/Charging Ink	Start
Language	Display supported languages
Printer Status/Print (Details of each item ↗ "Printer Status/Print" on page 160)	
Print Status Sheet	
Configuration Status Sheet	Print
Network	Display General Settings - Network Settings - Network Status
Contacts Manager *	Display General Settings - System Administration - Contacts Manager

Enlarged Copy (except for the SC-T5100M Series/SC-T3100M Series)

Displayed when an Epson A3 or A4 scanner is connected to the printer. Set scaling in this menu to enable enlarged printing of the scanned documents.

Details of each item [↗](#) "Enlarged Copy menu (except for the SC-T5100M Series/SC-T3100M Series)" on page 161

Settings item	Settings value
Copies	1 to 99
Color Mode	Black/White, Color
Original Size	A4, A5, A3, B5, B4, Letter, 13 x 18 cm (5 x 7 in)
Reduce/Enlarge	

Using the Menu

Settings item	Settings value
Auto Fit Page	On, Off
Custom Size	Actual Size, A0*, USE (34x44in)*, JIS B1*, A1, USD (22x34in), JIS B2, US C (17x22in), A2, User-Defined * Only displayed for the SC-T5100 Series/SC-T5100N Series.
Density	-4 to 4
Quality	Speed, Fine

Memory Device (SC-T5100M Series/SC-T3100M Series only)

Displayed when a USB flash memory is connected to the printer. The following are the **Basic Settings** and **Advanced** menus displayed after selecting the print menu for each file.

Details of each item [☞ “Memory Device menu \(SC-T5100M Series/SC-T3100M Series only\)” on page 163](#)

Settings item	Settings value
Basic Settings	
Copies	1 to 99
Paper Source	Roll Paper, Auto Sheet Feeder, Cut Sheet(1 sheet)
Color Mode	Black/White, Color
Advanced	
Quality	Standard, Speed, Fine, Super Fine
Page Margins option	Clip By Margins, Oversize
Bidirectional	On, Off
Reduce/Enlarge	
Auto Fit Page	On, Off
Custom Size	Actual Size, A4, A3, Super A3, A2, Super A2, A1, Super A1, Letter, Legal, US B (11x17in), US C (17x22in), US D (22x34in), ARCH A (9x12in), ARCH B (12x18in), ARCH C (18x24in), ARCH D (24x36in), ISO B4, ISO B3, ISO B2, JIS B4, JIS B3, JIS B2, 610 x 762 mm, 30 x 40 cm, 40 x 60 cm, 50 x 70 cm, 60 x 90 cm, User Defined
Color Mode (Common)	Poster(Photo)/Perspective, Poster/Document, GIS, CAD/Line Drawing, Off (No Color Management)

Copy (SC-T5100M Series/SC-T3100M Series only)

Details of each item [☞ “Copy Menu \(SC-T5100M Series/SC-T3100M Series Only\)” on page 166](#)

Settings item	Settings value
Basic Settings	

Using the Menu

Settings item	Settings value
Copies	1 to 99
Color Mode	Black/White, Color
Quality	Speed, Fine, Super Fine
Density	-4 to 4
Paper Source	Roll Paper, Auto Sheet Feeder, Cut Sheet(1 sheet)
Reduce/Enlarge	
Auto Fit Page	On, Off
Custom Size	Actual Size, ISO A4->A0, ISO A3->A0, ISO A4->A1, ISO A2->A0, ISO A3->A1, ISO A1->A0, ISO A2->A1, ISO A0->A1, ISO A1->A2, ISO A0->A2, ISO A1->A3, ISO A0->A3, ISO A1->A4, ISO A0->A4, US ANSI/ARCH A->E, US ANSI/ARCH B->E, US ANSI/ARCH A->D, US ANSI/ARCH C->E, US ANSI/ARCH B->D, US ANSI/ARCH D->E, US ANSI/ARCH C->D, US ANSI/ARCH E->D, US ANSI/ARCH D->C, US ANSI/ARCH E->C, US ANSI/ARCH D->B, US ANSI/ARCH E->B, US ANSI/ARCH D->A, US ANSI/ARCH E->A
Original Type	Text/Line Drawing, Tracing Paper, Blueprint
Advanced	

Using the Menu

Settings item	Settings value
Original Size	
Auto Detect	-
ISO A	Display supported sizes for originals
US-ANSI	
US-ARCH	
JIS B	
ISO B	
User-Defined	
Top Offset	0.0 to 100.0 mm 0.00 to 3.94 inch
Page Margins option	Clip By Margins, Oversize
Image Quality	
Contrast	-4 to 4
Sharpness	-4 to 4
Remove Background	
Auto	On, Off
-4 to 4	-
Bidirectional	On, Off
Clear All Settings	Yes, No

Scan (SC-T5100M Series/SC-T3100M Series only)

Details of each item  [“Scan Menu \(SC-T5100M Series/SC-T3100M Series Only\)”](#) on page 169

Settings item	Settings value
Network Folder/FTP	

Using the Menu

Settings item	Settings value
Destination	Display the Location Selection screen
Scan Settings	
Color Mode	Black/White, Color
File Format	
File Format	JPEG, PDF, PDF/A, TIFF (Multi Page)
Compression Ratio	High Compression, Standard Compression, Low Compression
PDF Settings	
Document Open Password	
Password Setting	Off, On
Password	Enter password
Permissions Password	
Password Setting	Off, On
Password	Enter password
Printing	Allowed, Not Allowed
Editing	Allowed, Not Allowed
Resolution	200dpi, 300dpi, 400dpi, 600dpi
Scan Size	
Auto Detect	-
ISO A	Display supported scan sizes
US-ANSI	
US-ARCH	
JIS B	
ISO B	
User-Defined	Display the Scan Size Input screen
Top Offset	0.0 to 100.0 mm 0.00 to 3.94 inch
Original Type	Text/Line Drawing, Tracing Paper, Blueprint
Density	-4 to 4

Using the Menu

Settings item	Settings value
Image Quality	
Contrast	-4 to 4
Sharpness	-4 to 4
Remove Background	
Auto	On, Off
-4 to 4	-
File Name	
Filename Prefix	Enter the filename prefix
Add Date	On, Off
Add Time	On, Off
Clear All Settings	Yes, No
Email	
Destination	Display the Recipient Selection screen
Scan Settings	
Color Mode	Black/White, Color
File Format	
File Format	JPEG, PDF, PDF/A, TIFF (Multi Page)
Compression Ratio	High Compression, Standard Compression, Low Compression
PDF Settings	
Document Open Password	
Password Setting	Off, On
Password	Enter password
Permissions Password	
Password Setting	Off, On
Password	Enter password
Printing	Allowed, Not Allowed
Editing	Allowed, Not Allowed
Resolution	200dpi, 300dpi, 400dpi, 600dpi

Using the Menu

Settings item	Settings value
Scan Size	
Auto Detect	-
ISO A	Display supported scan sizes
US-ANSI	
US-ARCH	
JIS B	
ISO B	
User-Defined	
Top Offset	0.0 to 100.0 mm 0.00 to 3.94 inch
Original Type	Text/Line Drawing, Tracing Paper, Blueprint
Density	-4 to 4
Image Quality	
Contrast	-4 to 4
Sharpness	-4 to 4
Remove Background	-4 to 4
Auto	On, Off
-4 to 4	-
Subject	Enter subject
Attached File Max Size	1MB, 2MB, 5MB, 10MB, 20MB, 30MB
File Name	
Filename Prefix	Enter the filename prefix
Add Date	On, Off
Add Time	On, Off
Clear All Settings	Yes, No
Memory Device	

Using the Menu

Settings item	Settings value
Basic Settings	
Color Mode	Black/White, Color
File Format	
File Format	JPEG, PDF, PDF/A, TIFF (Multi Page)
Compression Ratio	High Compression, Standard Compression, Low Compression
PDF Settings	
Document Open Password	
Password Setting	Off, On
Password	Enter password
Permissions Password	
Password Setting	Off, On
Password	Enter password
Printing	Allowed, Not Allowed
Editing	Allowed, Not Allowed
Resolution	200dpi, 300dpi, 400dpi, 600dpi
Scan Size	
Auto Detect	-
ISO A	Display supported scan sizes
US-ANSI	
US-ARCH	
JIS B	
ISO B	
User-Defined	Display the Scan Size Input screen
Top Offset	0.0 to 100.0 mm 0.00 to 3.94 inch
Original Type	Text/Line Drawing, Tracing Paper, Blueprint

Using the Menu

Settings item	Settings value
Advanced	
Density	-4 to 4
Image Quality	
Contrast	-4 to 4
Sharpness	-4 to 4
Remove Background	
Auto	On, Off
-4 to 4	-
File Name	
Filename Prefix	Enter the filename prefix
Add Date	On, Off
Add Time	On, Off
Clear All Settings	Yes, No

Network Folder (SC-T5100M Series/SC-T3100M Series only)

Details of each item  [“Network Folder Menu \(SC-T5100M Series/SC-T3100M Series Only\)”](#) on page 178

Settings item	Settings value
Basic Settings	
Paper Source	Roll Paper, Auto Sheet Feeder, Cut Sheet(1 sheet)
Color Mode	Black/White, Color
Advanced	
Quality	Speed, Fine, Super Fine
Page Margins option	Clip By Margins, Oversize
Bidirectional	On, Off
Color Mode (Common)	EPSON Standard (sRGB), Business Graphics, GIS, Line Drawing, Off (No Color Management)
Reduce/Enlarge	
Auto Fit Page	On, Off
Custom Size	25%-1024%
Standard Size	Actual Size, User-Defined



Using the Menu

Paper Setting menu



Roll Paper menu

- ❑ The Paper Setting menu is displayed if paper is loaded.
- ❑ **Media Adjust** adjustment results, and settings in **Advanced Media Setting** and **Manage Remaining Amount** are stored for each paper type in **Paper Type**. Changing adjustments and settings will save these as the currently selected paper type settings even if the power is turned off.



*Default setting

Settings item	Settings value	Explanation
Remove		Rewind the roll paper until it is ejected from inside the printer.  "Removing Roll Paper" on page 34
Feed/Cut Paper	Backward	Use Backward and Forward to move the paper to the desired position. Touch Cut to cut the paper using the built-in cutter.  "Cutting the Roll Paper" on page 32
	Forward	
	Cut	
Media Adjust	Start	Run this adjustment when there is a problem with print results, or after registering custom paper settings. Touch Start to print an adjustment pattern. Follow the on-screen instructions to make adjustments. The adjustment results are saved as settings for the selected paper type.  "Optimizing Paper Settings (Media Adjust)" on page 46
Advanced Media Setting		

Using the Menu

Settings item	Settings value	Explanation
Platen Gap	1.6	This is displayed when Custom Paper is selected in Paper Type . When registering Custom Paper, this is set to the Platen Gap (distance between print head and paper) for the paper selected in Change Reference Paper , so it does not normally need to be changed. Change this to a setting that will widen the gap (a higher value) if print results are smeared.
	2.1	
	2.6	
Top/Bottom Margins	Standard *	Setting this to Standard will set the top/bottom margins as follows depending on the printer driver print targets. <input type="checkbox"/> CAD/Line Drawing: 3 mm/3 mm <input type="checkbox"/> Others: 30 mm/30 mm Left and right margins will remain at 3 mm regardless of settings. If there is any soiling on the top section of the print results, increase the top margin.  "Printable area" on page 215
	Top 3 mm/Bottom 3 mm	
	Top 15 mm/Bottom 15 mm	
	Top 45 mm/Bottom 15 mm	
Back Tension	Auto *	If there is any wrinkling on the paper during printing, set this to High or Extra High .
	Standard	
	High	
	Extra High	
Drying Time		
Drying Time per Pass	0.0 to 10.0 seconds (0.0*)	Select the time the print head pauses to allow drying after each pass. Choose from values between 0.0 and 10.0 seconds. Depending on the paper type, the ink may take a while to dry. If the ink blurs on the paper, set a longer time for drying the ink. Increasing the drying time increases the time needed to print.
Drying Time per Page	0.0 to 60 minutes (0.0*)	Specify how long the printer pauses to allow the ink to dry after printing each page; choose from values between 0.0 and 60 minutes. Depending on the ink density or paper type, the ink may take a while to dry. If the ink blurs on the paper, set a longer time for drying the ink. The longer the drying time, the more time required for printing.
Auto Cut	On *	Select whether to automatically cut (On) or not cut (Off) using the built-in cutter as each page is printed on roll paper. Set to On to automatically cut the edge if it is not a horizontal cut when paper is loaded. The setting selected with the printer driver takes priority when the printer driver is used.  "Cutting the Roll Paper" on page 32
	Off	
Manage Remaining Amount		

Using the Menu

Settings item	Settings value	Explanation
Setup	On	Select whether to display/record (On) or not to display/ record (Off) the amount of remaining roll paper. Set to On to enable Remaining Amount and Remaining Alert .  "For Roll Paper" on page 42
	Off *	
Remaining Amount	5.0 to 150.0 m (30 [*])	Entering the total length of the loaded roll paper in Remaining Amount displays an estimate of remaining amount of roll paper on the printer's Home screen and on the printer driver screen.
Remaining Alert	1.0 to 15.0 m (5.0 [*])	In Remaining Alert , set the limit at which to display a warning when the amount of remaining roll paper drops below that limit. You can set in 0.1 m increments.
Change Paper Type		
Paper Type	Plain Paper *	Select the type of loaded paper. The most recently used paper type is displayed for the three options except for Others . When the desired paper type is not displayed, touch Others to display the other paper types and then select a paper type.  "For Roll Paper" on page 42
	Coated Paper(Generic)	
	Premium Glossy Sheet	
	Others	

Using the Menu

Auto Sheet Feeder menu

The Paper Setting menu is displayed if paper is loaded.

*Default setting

Settings item	Settings value	Explanation
Media Adjust	Start	<p>Run this adjustment when there is a problem with print results, or after registering custom paper settings.</p> <p>Touch Start to print an adjustment pattern. Follow the on-screen instructions to make adjustments.</p> <p>The adjustment results are saved as settings for the selected paper type.</p> <p>☞ "Optimizing Paper Settings (Media Adjust)" on page 46</p>
Change Paper Type/Paper Size		
Paper Type	Plain Paper *	<p>Select the type of loaded paper. The most recently used paper type is displayed for the three options except for Others. When the desired paper type is not displayed, touch Others to display the other paper types and then select a paper type.</p> <p>☞ "For Auto Sheet Feeder/Cut Sheet(1 sheet)" on page 44</p>
	Coated Paper(Generic)	
	Premium Glossy Sheet	
	Others	
Paper Size	A4	<p>Select the size of the loaded paper.</p> <p>If the desired size is not in the options, then select User-Defined, and enter the paper width and length.</p>
	A3	
	JIS B4	
	ISO B4	
	Letter (8 1/2x11in)	
	Legal (8 1/2x14in)	
	US B (11x17in)	
	ARCH A (9x12in)	
	User-Defined	

Using the Menu

Cut Sheet(1 sheet) menu

The Paper Setting menu is displayed if paper is loaded.



*Default setting

Settings item	Settings value	Explanation
Remove		Touch to eject the loaded cut sheet (1 sheet) without printing. Touch to eject to the front. ☞ "Removing Cut Sheet (1 Sheet)" on page 41
Media Adjust	Start	Run this adjustment when there is a problem with print results, or after registering custom paper settings. Touch Start to print an adjustment pattern. Follow the on-screen instructions to make adjustments. The adjustment results are saved as settings for the selected paper type. ☞ "Optimizing Paper Settings (Media Adjust)" on page 46
Change Paper Type/Paper Size		
Paper Type	Plain Paper *	Select the type of loaded paper. The most recently used paper type is displayed for the three options except for Others . When the desired paper type is not displayed, touch Others to display the other paper types and then select a paper type. ☞ "For Auto Sheet Feeder/Cut Sheet(1 sheet)" on page 44
	Coated Paper(Generic)	
	Premium Glossy Sheet	
	Others	
Paper Size	A Series	Select the size of the loaded paper. If the desired size is not in the options, then select User-Defined , and enter the paper width and length.
	US-ANSI	
	US-ARCH	
	B Series (ISO)	
	B Series (JIS)	
	Others	
	User-Defined	

Using the Menu

Printer Status menu

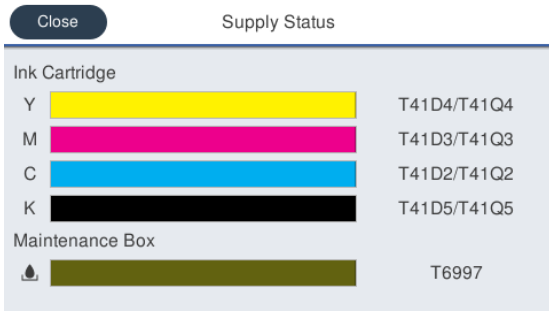
*Default setting

Settings item	Settings value	Explanation
Supply Status		<p>Display the approximate remaining amounts of each color in ink cartridge and its product number, and the approximate capacity in and product number of the Maintenance Box.</p>  <p>The shorter the bar is, the lower the remaining amount of space. Even if  is displayed, printing is possible until replacement is instructed. However, ensure that a new ink cartridge of that color, or a new Maintenance Box is readied in advance.</p> <p>Furthermore, the ink color codes beside the bars indicate the following.</p> <ul style="list-style-type: none"> <input type="checkbox"/> K: Black <input type="checkbox"/> M: Magenta <input type="checkbox"/> Y: Yellow <input type="checkbox"/> C: Cyan
Message List		Display a list of messages communicating printer status. Select a message from the list to display detailed information.
Firmware Version		Display the printer firmware version.
Print Status Sheet		
Configuration Status Sheet		Print a list of current printer settings. Use this to view all information at a glance.

Using the Menu

Settings menu

General Settings

General Settings - Basic Settings

*Default setting

Settings item	Settings value	Explanation
LCD Brightness	1 to 9(9*)	Adjust screen brightness.
Sound (SC-T5100M Series/SC-T3100M Series only)		
Mute	On	Setting this to On will mute the sound output when touching the menu or other items on the control panel screen, and the confirmation sound output when inserting paper into the paper slot when loading paper.
	Off *	
Button Press	0 to 10(5*)	Adjust the volume of the sound when touching the menu or other items on the control panel screen, and of the confirmation sound when inserting paper into the paper slot when loading paper.
Error Notice	0 to 10(5*)	Adjust the volume of the sound notifying of an error.
Sound Type	Pattern1 *	Adjust the type of the sound when touching the menu or other items on the control panel screen, and of the confirmation sound when inserting paper into the paper slot when loading paper.
	Pattern2	
Sound (except for the SC-T5100M Series/SC-T3100M Series)		
Mute	On	Setting this to On will mute the sound output when touching the menu or other items on the control panel screen, and the confirmation sound output when inserting paper into the paper slot when loading paper.
	Off *	
Normal Mode		
Button Press	0 to 10(5*)	Adjust the volume of the sound when touching the menu or other items on the control panel screen, and of the confirmation sound when inserting paper into the paper slot when loading paper.
Error Notice	0 to 10(5*)	Adjust the volume of the sound notifying of an error.
Sound Type	Pattern1 *	Adjust the type of the sound when touching the menu or other items on the control panel screen, and of the confirmation sound when inserting paper into the paper slot when loading paper.
	Pattern2	
Sleep Timer	SC-T5100 Series/ SC-T5100N Series/ SC-T3100 Series/ SC-T3100N Series/ SC-T2100 Series: 1 to 210 mins. (15*) SC-T5100M Series/ SC-T3100M Series: 1 to 60 mins. (15*)	The printer will enter sleep mode if no errors have occurred, no print jobs have been received, and no actions are performed on the control panel for an extended period of time. This setting selects the amount of time until the printer enters sleep mode.  "Saving Power" on page 22

Using the Menu

Settings item	Settings value	Explanation
Wake from Sleep		
Touch LCD Screen to Wake	On *	Sets whether or not to wake from sleep mode by screen operation during sleep mode. When Off is selected, press the power button to wake from sleep mode.
	Off	
	Scheduled (6:00 to 21:00*)	If you select Scheduled , you can specify the time period between 0:00 and 23:45 in 15 minute increments to allow the printer to wake from sleep mode by screen operation.
Power Off Timer	Off	You can select the time after which the printer will turn off automatically if no errors have occurred, no print jobs have been received, or no actions are performed on the control panel for an extended period of time.  "Saving Power" on page 22 The default setting differs as follows depending on the model. <input type="checkbox"/> SC-T5100M Series/SC-T3100M Series/SC-T5100 Series/SC-T5100N Series/SC-T3100 Series/SC-T3100N Series/SC-T2100 Series: 8h <input type="checkbox"/> Models other than the above: Off
	30minutes	
	1h	
	2h	
	4h	
	8h	
	12h	
Circuit Breaker Interlock Startup	On *	Select whether to turn the printer on (On) or off (Off) when the breaker switch is turned on.
	Off	
Date/Time Settings		
Date/Time	-	Enter the current date and time.
Time Difference	-12:45 to +13:45 (0.00*)	Set the difference with coordinated universal time (UTC) in 15 minute increments. In network environments with a time difference, set this as necessary when administrating the printer.

Using the Menu

Settings item	Settings value	Explanation
Language	Japanese	Select the language used on the control panel's screen.
	English	
	French	
	Italian	
	German	
	Portuguese	
	Spanish	
	Dutch	
	Russian	
	Polish	
	Korean	
	Simplified Chinese	
Traditional Chinese		
Operation Time Out	On *	Setting this to On will display a message and return to the Home screen if there is no operation within a certain amount of time while a screen other than the Home screen is displayed.
	Off	
Keyboard (Except for the SC-T5100M Series/ SC-T3100M Series)	QWERTY *	Select the key arrangement for the text input screen displayed when entering the name of Custom Paper or other name.
	AZERTY	
	QWERTZ	
Length Unit	m *	Select the units of length to use when displaying the length of roll paper and other items.
	ft / in	

Using the Menu

General Settings - Printer Settings

*Default setting

Settings item	Settings value	Explanation
Paper Source Settings		
Error Notice		
Paper Size Notice	On *	Setting this to On will display an error message when the output size or paper type settings of print jobs sent to the printer differ from those settings in the printer.
	Off	
Paper Type Notice	On *	
	Off	
Roll Paper Setup		
Detect Paper Meandering	On *	If On is selected, an error will be displayed in the control panel and printing will stop if the paper is skewed; select Off to disable this feature. On is recommended in most circumstances as skewed paper may cause the printer to jam.
	Off	
Print Cutting Guideline	On	If Auto Cut is Off, you can choose to print (On) or not print (Off) cut lines on roll paper. Cut lines are not printed if Auto Cut is On or when cut sheets are used. Note, however, that if the roll width selected with the computer is narrower than the paper loaded in the printer, cut lines will be printed regardless of the option selected for Auto Cut. The setting selected with the printer driver takes priority when the printer driver is used.
	Off *	
After-Print Options	Hold Paper *	After printing, select whether the printer should grip the trailing edge of the cut sheet or auto cut roll paper in the eject slot (Hold Paper), or allow it to be fully ejected (Eject Paper). To prevent the print surface from being scratched when the paper is ejected and it drops down, we normally recommend using Hold Paper . When using Hold Paper , manually pull the edge of the paper out of the printer so that the paper does not drop down.
	Eject Paper	

Using the Menu

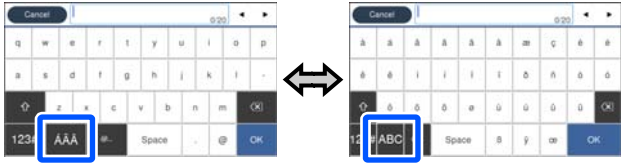
Settings item	Settings value	Explanation					
Custom Paper Setting (Touching any of the registry numbers from 01 to 10 will display settings items.)							
Change Name		<p>Register and change the name of the custom paper settings. The name registered here is displayed in the Paper Type list.</p> <p>Touch this to display the keypad screen. Up to 20 characters may be input for the name. The keypad screen can be switched as shown below with the button marked.</p>  <p>Touch the icons at bottom left to switch between input methods.</p> <p>ABC: Enters alphabet letters.</p> <p>123#: Enters numbers and symbols.</p> <p>To change the key layout of the full keyboard, use Keyboard in the Basic Settings menu.</p> <p>🔗 "General Settings - Basic Settings" on page 138</p>					
Change Reference Paper	<table border="1"> <tr> <td data-bbox="427 1032 730 1093">Plain Paper *</td> </tr> <tr> <td data-bbox="427 1093 730 1153">Matte Paper</td> </tr> <tr> <td data-bbox="427 1153 730 1214">Photo Paper</td> </tr> <tr> <td data-bbox="427 1214 730 1274">CAD</td> </tr> <tr> <td data-bbox="427 1274 730 1317">Others</td> </tr> </table>	Plain Paper *	Matte Paper	Photo Paper	CAD	Others	<p>You can select the media type that is the closest to the paper you are using.</p>
Plain Paper *							
Matte Paper							
Photo Paper							
CAD							
Others							

Using the Menu

Settings item	Settings value	Explanation
Advanced Media Setting		
Platen Gap	1.6	This is the Platen Gap (distance between print head and paper) for the paper selected in Change Reference Paper , so it does not normally need to be changed. Change this to a setting that will widen the gap (a higher value) if print results are smeared.
	2.1	
	2.6	
Top/Bottom Margins	Standard *	Setting this to Standard will set the top/bottom margins as follows depending on the printer driver print targets. <input type="checkbox"/> CAD Line Drawing: 3 mm/3 mm <input type="checkbox"/> Others: 30 mm/30 mm Left and right margins will remain at 3 mm regardless of settings. If there is any soiling on the top section of the print results, increase the top margin. 🔗 "Printable area" on page 215
	Top 3 mm/Bottom 3 mm	
	Top 15 mm/Bottom 15 mm	
	Top 45 mm/Bottom 15 mm	
Back Tension	Auto *	If there is any wrinkling on the paper during printing, select High or Extra High .
	Standard	
	High	
	Extra High	
Drying Time		
Drying Time per Pass	0.0 to 10.0 seconds (0.0*)	Select the time the print head pauses to allow drying after each pass. Choose from values between 0.0 and 10.0 seconds. Depending on the paper type, the ink may take a while to dry. If the ink blurs on the paper, set a longer time for drying the ink. Increasing the drying time increases the time needed to print.
Drying Time per Page	0.0 to 60 minutes (0.0*)	Specify how long the printer pauses to allow the ink to dry after printing each page; choose from values between 0 and 60 minutes. Depending on the ink density or paper type, the ink may take a while to dry. If the ink blurs on the paper, set a longer time for drying the ink. The longer the drying time, the more time required for printing.
Auto Cut	On *	Select whether to automatically cut (On) or not cut (Off) using the built-in cutter as each page is printed on roll paper. Set to On to automatically cut the edge if it is not a horizontal cut when paper is loaded. The setting selected with the printer driver takes priority when the printer driver is used. 🔗 "Cutting the Roll Paper" on page 32
	Off	
Restore Default		Restore the selected Custom Paper settings to default settings.
Printing Language		
USB	Auto *	Normally, leave the setting as Auto. If HP-GL/2 or HP RTL print data is sent from a CAD application or plotter, this is automatically determined, and switched to HP-GL/2 mode. If HP-GL/2 mode printing is not carried out normally, or if normally printing in HP-GL/2 or HP RTL, set as HP-GL/2 .
	HP-GL/2	
Network	Auto *	
	HP-GL/2	

Using the Menu

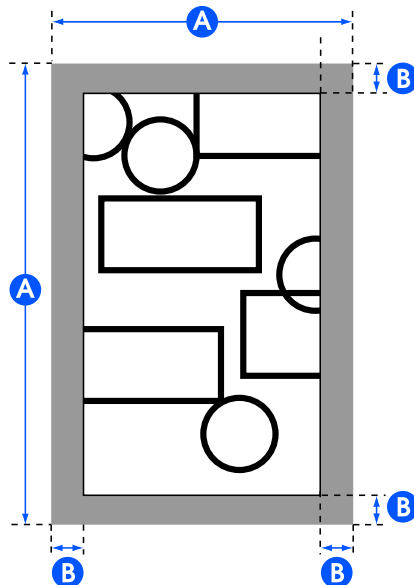
Settings item	Settings value	Explanation
Universal Print Settings		
Paper Source	Roll Paper *	Select the paper source. If the paper is not loaded as in the set paper source, then an error will occur during printing.
	Auto Sheet Feeder	
	Cut Sheet(1 sheet)	
Quality	Standard *	Select the print quality. Standard prints with the quality mode appropriate for the Paper Type setting for the paper selected in Paper Source .
	Speed	
	Fine	
	Super Fine	
Color Mode	Color *	Specify whether to print in color or switch to black and white and then print.
	Black/White	
Page Margins option	Clip By Margins *	<p>Depending on the base output size setting, adds the value selected for the page margin (area of B in the following illustration) inside the hard clip area of the PS command of the data or the size selected for base output size (area of A in the following illustration). When there is a print object in the margin section, it is clipped and not printed.</p> 

Using the Menu

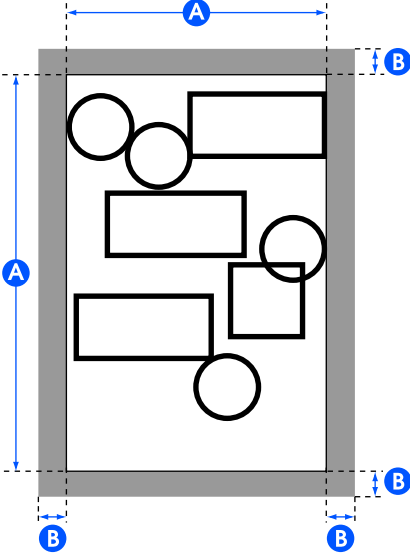
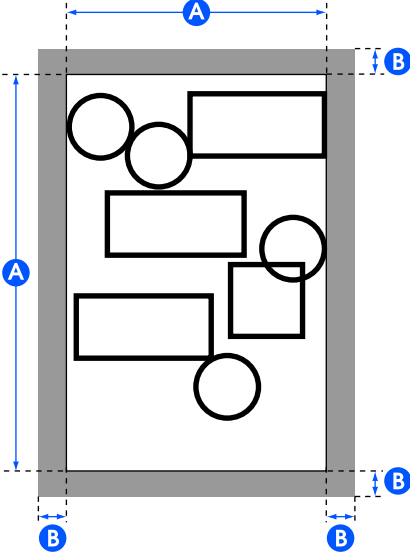
Settings item	Settings value	Explanation
	Oversize	<p>The position at which the margin is added depends on the base output size setting, as shown below.</p> <ul style="list-style-type: none"> <input type="checkbox"/> When set to Auto Adds the value selected for page margin (area of B in the following illustration) outside the hard clip area of the PS command of the data (area of A in the following illustration).  <ul style="list-style-type: none"> <input type="checkbox"/> When set to a standard size or user defined size Adds the value selected for page margin (area of B in the following illustration) outside the size selected for base output size (area of A in the following illustration). With the actual output size, the margin section becomes larger than the selected size (the area of A in the following illustration). 

Using the Menu

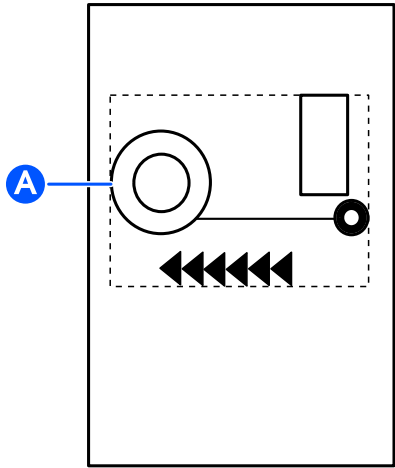

Settings item	Settings value	Explanation
Page Margin	3 mm *	Select the top, bottom, left, and right margin values.
	5 mm	For a cut sheet, the top, bottom, left, and right margin values are 3 mm regardless of the settings.
Smoothing	On	This setting is enabled when Resolution is set to Standard and there is no resolution specification in the sent print data. Setting this to On will print at the maximum resolution corresponding to the Paper Type setting for the paper selected in Paper Source , but depending on the data, this may result in a long print time, or failures in printing because of insufficient memory.
	Off *	
Base Output Size	Auto *	<p>The hard clip area of the PS command of the data becomes the base output size. The actual output size depends on the Page Margins option. When the data does not contain a PS command, the smallest rectangle area A of in the following illustration including the print object becomes the base output size.</p> 
	A Series	<p>The compatible standard sizes for the selected Paper Source are displayed, therefore select the Base Output Size. The actual output size depends on the Page Margins option.</p> <p>For a cut sheet, this setting is available only when the data does not contain a PS command. If the data contains a PS command, this setting is not available, and the hard clip area of the PS command becomes the Base Output Size.</p>
	US-ANSI	
	US-ARCH	
	B Series (ISO)	
	B Series (JIS)	
	Others	
User-Defined	<p>Select this option when outputting at non-standard sizes. After selecting this setting, set Paper Width and Paper Height. You can set in 0.1 mm increments.</p> <p>The actual output size depends on the Page Margins option.</p>	

Using the Menu

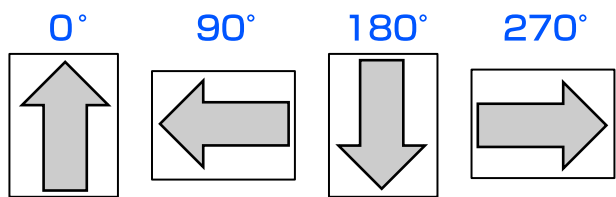
Settings item	Settings value	Explanation
Resolution	Standard *	This setting is enabled when the resolution is not specified in the sent print data. Standard prints at the resolution corresponding to the Paper Type setting for the paper selected in Paper Source and the Quality setting.
	300dpi	
	600dpi	
	1200dpi	
Color Mode (Common)	EPSON Standard (sRGB)	Optimize the sRGB space and correct the color.
	Business Graphics *	Perform color correction to sharpen your images based on the sRGB space.
	GIS	Perform color correction suitable for when printing GIS (Geographic Information System) topographical maps or similar.
	Line Drawing	Perform color correction suitable for CAD drawings and other line drawings.
	Off (No Color Management)	Do not perform color correction.
HP-GL/2 Unique Settings (Print settings unique to HP-GL/2 or HP RTL modes.)		
Rotate	0°	You can rotate the coordinates of the drawn data counterclockwise in units of 90° before printing. Note that objects drawn by RTL are not rotated. When both this setting and the RO command specify rotation, rotation is performed using the combined amount of both values. Note that rotation by the RO command is for objects only (the arrow section in the following illustration), and rotation is not performed for the drawn area (the square section in the following illustration). As a result, objects in a section that protrude from the drawn area are not printed.
	90°	
	180°	
	270°	
Origin Setup	Left Edge *	Set the data coordinate origin.
	Center	

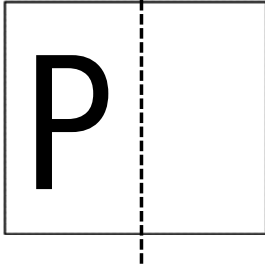
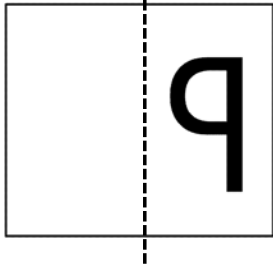
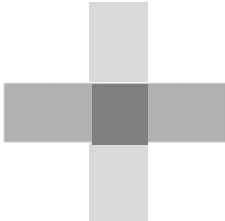

Using the Menu

Settings item	Settings value	Explanation
Mirror Image	On	<p>Select whether to flip horizontally (mirror) using the center of the output size width as the basis line and then print (On) or print without flipping horizontally (Off).</p> <div style="display: flex; justify-content: space-around; align-items: center;"> <div style="text-align: center;"> <p>OFF</p>  </div> <div style="text-align: center;"> <p>ON</p>  </div> </div> <p>If an angle is specified for rotate, the rotated result is flipped horizontally.</p>
	Off *	
Line Merge	On	<p>Select whether to merge the intersection of the overlapping lines within the image according to the MC command of the data (On), or move lines to be printed later to the front at intersections (Off).</p> <div style="display: flex; justify-content: space-around; align-items: center;"> <div style="text-align: center;"> <p>ON</p>  </div> <div style="text-align: center;"> <p>OFF</p>  </div> </div>
	Off *	
Color Mode (HP-GL/2)	EPSON Standard (sRGB)	Optimize the sRGB space and correct the color.
	Business Graphics	Perform color correction to sharpen your images based on the sRGB space.
	GIS	Perform color correction suitable for when printing GIS (Geographic Information System) topographical maps or similar.
	Line Drawing *	Perform color correction suitable for CAD drawings and other line drawings.
	Off (No Color Management)	Do not perform color correction.

Using the Menu

Settings item	Settings value	Explanation
Select Palette	Software *	<p>From the following selections, choose the palette that specifies the color and thickness of the logical pen.</p> <ul style="list-style-type: none"> <input type="checkbox"/> Software: Print according to the pen configuration set in the application, and ignore the built-in palette of the printer. <input type="checkbox"/> Default: Print according to the settings of the built-in palette of the printer specified in advance. The settings of the palette cannot be changed. The built-in palette specifies a logical pen with a pen width of 0.35 mm and 256 colors. <input type="checkbox"/> Palette A / Palette B: Print according to the settings of the built-in palette that you specified for Define Palette. If Define Palette setting is not set, the results are the same as when Default is selected. <p>When Default / Palette A / Palette B are set, the pen configuration set in the application is ignored.</p> <p>Selected palette settings can be printed with Print Color Palette and confirmed.</p>
	Default	
	Palette A	
	Palette B	
Print Color Palette	Print	Settings of the palette selected in Select Palette are printed as A3 size. You can check the colors corresponding to the color number for the pen colors.
Define Palette		
Palette A		
Pen 0 to Pen 15		
Pen Width	0.13 to 12.00 mm	<p>In Select Palette, selecting Palette A will print in accordance with the settings defined here.</p> <p>You can define a unique built-in palette by specifying the pen width and color for the 16 types of logical pen. Select the pen number, and then define the pen width and pen color for each pen.</p> <p>You can use Print Color Palette to print and check the colors corresponding to the color number for the pen colors.</p>
Pen Color	0 to 255	
Palette B		
Pen 0 to Pen 15		
Pen Width	0.13 to 12.00 mm	<p>In Select Palette, selecting Palette B will print in accordance with the settings defined here.</p> <p>Settings details are the same as for Palette A.</p>
Pen Color	0 to 255	
Restore default HP-GL/2 Unique Settings	No	Select Yes to restore all HP-GL/2 Unique Settings settings to the default settings.
	Yes	
Memory Device Interface (SC-T5100M Series/ SC-T3100M Series only)	Enable *	Select whether to permit (Enable) or not permit (Disable) connecting a USB flash memory to the printer and then directly printing the data in the memory.
	Disable	
Thick Paper	Off *	If the paper is thick, the print head may scuff the print surface. Choose On to prevent scuffing. If On is set, the platen gap, which is the distance between the print head and the paper, will widen. However, if the platen gap is already at its maximum, then setting this to On will have no effect.
	On	

Using the Menu

Settings item	Settings value	Explanation
Bidirectional	On *	Setting this to On will cause the print head to print while moving both left and right. Setting this to Off reduces ruled line misalignment, but printing takes more time.
	Off	
PC Connection via USB	Enable *	Setting this to Enable allows access from a USB-connected computer. Setting this to Disable does not allow access.
	Disable	
USB I/F Timeout Setting	0 sec, or 5 to 300 sec (60*)	If printing stops mid-way when the printer and computer are connected by a USB cable, set a longer time.



Using the Menu

General Settings - Network Settings

*Default setting

Settings item	Settings value	Explanation
Wi-Fi Setup		
Router (Connect via Wi-Fi)		<p>Disconnected or disabled</p> <p>This is displayed in gray. Touch this, and on the next screen touching Start Setup will display a Wi-Fi Setup Wizard menu, performing a connection operation.</p> <p>Connected</p> <p>Touch to display the connection status and settings information. Touch Change Settings to display Wi-Fi Setup Wizard and other menus that allow you to switch the access point.</p> <p> "Switching to Wireless LAN" on page 96</p>
Wi-Fi Setup Wizard		The list of SSIDs for the detected access points is displayed. From the list, select the SSID to connect to, and connect.
Push Button Setup(WPS)		If the access point to use supports WPS (Wi-Fi Protected Setup), then this menu item can be used for connection. Input of SSID and password is not required. After selecting this menu item, touch and hold the push button on the access point until it flashes, then again touch Start Setup on the printer screen to connect.
Others		
PIN Code Setup(WPS)		If the access point to use supports WPS (Wi-Fi Protected Setup), then this menu item can be used for connection. Touch this to display the PIN code and Start Setup . Input the displayed PIN code from a computer into the access point within 2 minutes, then touch Start Setup to connect.
Wi-Fi Auto Connect		The menu used after installing software from the Software Disc, and connecting to the printer by following the wizard.
Disable Wi-Fi		Selecting this means that the wireless LAN connection will be initialized and disconnected. In the event of problems with the wireless LAN connection, use this menu to reconnect and attempt to resolve the problem.

Using the Menu

Settings item	Settings value	Explanation
Wi-Fi Direct		<p>Disconnected or disabled</p> <p>This is displayed in gray. Touch this, and then touch Start Setup on the next screen to display Start Setup. Touch Start Setup to enable Wi-Fi Direct and display the printer's SSID and password.</p> <p>Connected</p> <p>Touch to display the printer SSID and password, as well as the number of connected devices. Touch Change Settings to display Change Password and other menus.</p> <p> "Directly Connecting Wirelessly (Wi-Fi Direct)" on page 97</p>
Change Network Name (SC-T5100M Series/SC-T3100M Series only)		Change the name of the Wi-Fi Direct connection (SSID) that is used to connect to the printer to any value. Changing the connection name (SSID) will disconnect all connected devices. If you change the connection name, you need to re-connect with the new connection name (SSID) from the device you want to connect to.
Change Password		You can change the Wi-Fi Direct password. Changing the password will disconnect all connected computers and smart devices.
Disable Wi-Fi Direct		Performing this operation will disconnect all connected computers and smart devices. To disconnect only a specific device, disconnect the connection from the device.
Delete Registered Device (SC-T5100 Series/SC-T5100N Series/SC-T3100 Series/SC-T3100N Series/SC-T2100 Series only)		Smart device menu item. When using the Wi-Fi Direct function on a smart device to connect to the printer, a message is displayed on the printer prompting you to accept or refuse the connection. If refuse is selected, then subsequent connection with this device will not be possible. To connect with devices for which connection has been refused, open this menu, and delete registered device information.
Restore Default Settings (SC-T5100M Series/SC-T3100M Series only)		Restores all Wi-Fi Direct settings to the manufacturer's settings. This also removes connection information stored by the printer that was registered using the Wi-Fi Direct feature of the smart device.
Wired LAN Setup		Touch to change a wireless LAN connection to a wired LAN connection. Touch Start Setup to disable the wireless LAN connection.  "Switching to Wired LAN" on page 96
Network Status		
Wired LAN/Wi-Fi Status		Display current communications status and connection settings such as IP address, etc.
Wi-Fi Direct Status		Display number of connected devices and connection settings such as SSID.
Email Server Status (SC-T5100M Series/SC-T3100M Series only)		The current method of authentication and authenticated accounts are displayed. The settings also can be changed.
Print Status Sheet		Print current network connection detailed information.
Connection Check		Confirm the network status of the printer, and print a network connection check report. In the event of problems, respond in accordance with the diagnostics results.

Using the Menu

Settings item	Settings value	Explanation
Advanced		
Device Name		Set the name of the printer to use on the network.
TCP/IP	Auto *	Automatically assign the printer IP address using DHCP functionality in the router.
	Manual	Select this to manually assign a fixed IP address, then input the IP address, subnet mask, and other required information. For details, see the <i>Administrator's Guide</i> .
Proxy Server	Use	When using a proxy server to directly connect from the intranet to the Internet so that the printer may directly access the Internet for firmware updates or similar, select Use , and set the server name and port number.
	Do Not Use *	
Email Server (SC-T5100M Series/SC-T3100M Series only)		The details are the same as displayed in General Settings - Scan Settings - Email Server .
Shared Folder (SC-T5100M Series/SC-T3100M Series only)		Used when you want to print from a folder. You must set up a shared folder before printing from a folder.  "Printing Files from a Shared Folder (Print from Folder)" on page 100
IPv6 Address	Enable *	Select whether to enable or disable the IPv6 function.
	Disable	
Link Speed & Duplex	Auto *	Normally, set this to Auto .
	10BASE-T Half Duplex	
	10BASE-T Full Duplex	
	100BASE-TX Half Duplex	
	100BASE-TX Full Duplex	
Redirect HTTP to HTTPS	Enable *	Select whether to enable or disable the function to auto-redirect HTTP to HTTPS.
	Disable	
Disable IPsec/IP Filtering	Enable	To enable IPsec/IP filtering functionality, use Web Config. For details, see the <i>Administrator's Guide</i> .
	Disable *	
Disable IEEE802.1X	Enable	To enable IEEE802.1X functionality, use Web Config. For details, see the <i>Administrator's Guide</i> .
	Disable *	
iBeacon Transmission (SC-T5100M Series/SC-T3100M Series only)	Enable *	Set whether to enable or disable iBeacon Transmission. Set to enable to be able to search from iBeacon-compatible devices.
	Disable	







General Settings - Scan Settings (SC-T5100M Series/SC-T3100M Series only)

*Default setting

Using the Menu

Settings item	Settings value	Explanation
Confirm Recipient	On	Set to On to be able to check the recipients before scanning the original.
	Off*	
Email Server		
Server Settings	Off	Select this when not setting an email server.
	POP before SMTP	Authenticates on the POP3 server (receiving mail server) before sending the email. When you select this item, set the POP3 server.
	SMTP-AUTH	Authenticates on the SMTP server (outgoing mail server) when sending the email. The mail server needs to support SMTP authentication.
Connection Check		Able to check the connection with the email server.
Scan Options		

Using the Menu

Settings item	Settings value	Explanation
Confirm Before Ejecting Scanned Document	On *	Set to On to keep the original at the paper eject slot after it is scanned and display the removal confirmation screen. If you want to eject the original right after scanning it, set this to Off .
	Off	
Correct Skewed Image	On *	Automatically corrects a scanned image that is skewed, and then saves it. The range of correction is from the origin to a width of 914.4 mm. Enable this only if the Original Size or Scan Size has been set to Auto Detect .
	Off	
Document Feed Adjustment	-1.00 to 1.00(0*)	If the length of the original and the print results of the copied or scanned files do not match, adjust the document feeding. If you want to shorten the length of the print out, press the minus button. If you want to lengthen it, press the plus button. Differences in length may occur due to the type of paper used for printing.  "Document Feed Adjustment" on page 204
Image Stitching Smoother	On	When scanning the same color, if you notice a difference in color on the left and right as shown in the following illustration, you may be able to reduce the difference by setting this to On . Off  On  When this is set to On , the lines between joints in the scans may be blurred or fuzzy as shown in the following illustration. If you are concerned about this issue, try setting this to Off or perform Image Stitching Adjustment .  "Image Stitching Adjustment" on page 204 Off  On 
	Off *	
Image Stitching Adjustment	-5 to 5(0*)	Correct the position for image stitching if the scanned results are misaligned.  "Image Stitching Adjustment" on page 204

Using the Menu

General Settings - System Administration

*Default setting

Settings item	Settings value	Explanation
Contacts Manager (SC-T5100M Series/SC-T3100M Series only)		
Register/Delete		Register or delete addresses that are used in Scan to Email and Scan to Network Folder/FTP.
Frequent		
Email		Register frequently used addresses for each item to be able to access them easily. You can also change the order of the addresses.
Network Folder/FTP		
Print Contacts		
List of all Contacts		Print the email addresses of your contacts.
List of Email Contacts		
List of Folder/FTP Contacts		
View Options	Tile View *	Change how to view your contacts.
	List View	
Search Options	Begins with *	Change how to search for contacts.
	Ends with	
	Includes	
Security Settings		

Using the Menu

Settings item	Settings value	Explanation
Restrictions (SC-T5100M Series/SC-T3100M Series only)		
Job log access	Off	Administrators can be permitted individually to view and change settings.
	On *	
Access to Register/ Delete Contacts	Off *	
	On	
Access to Recent of Scan to Email	Off	
	On *	
Access to Show Sent History of Scan to Email	Off	
	On *	
Access to Language	Off	
	On *	
Access to Thick Paper	Off *	
	On	
Protection of Personal Data	Off *	
	On	





Using the Menu

Settings item	Settings value	Explanation
Access Control (SC-T5100M Series/ SC-T3100M Series only)	Off*	<p>With Access Control, you can control the functions that users can use by linking the functions to the accounts registered to the users on the printer. If administrators want to restrict users, set this to On. User accounts must be created ahead of time.</p> <p>Do the settings for creating user accounts in Web Config. See the <i>Administrator's Guide</i> for more details.</p>
	On	
Admin Settings		
Admin Password	Register	<p>When using the Lock Setting function, touch Register and set the administrator password. If changing a password that has already been set, touch Change and set the new password.</p> <p>Set the password and set Lock Setting to On to ask for input of a password when displaying specific settings menus such as network configuration.</p> <p>These menus will only be displayed if the correct password is entered, preventing non-administrators from accidentally changing settings.</p> <p>Keep the password in a safe place.</p> <p>Should you forget the password, contact your dealer or Epson Support.</p>
	Change	
	Clear All Settings	
Lock Setting	Off*	<p>When this is set to On, you need to enter the administrator password when certain menu items are selected, and you cannot change the setting or run the function unless you enter the password. Lock Setting is normally enabled for the following items. Set the Admin Password before you select On.</p> <ul style="list-style-type: none"> <input type="checkbox"/> Sleep Timer <input type="checkbox"/> Power Off Timer <input type="checkbox"/> Circuit Breaker Interlock Startup <input type="checkbox"/> Date/Time Settings <input type="checkbox"/> Operation Time Out <input type="checkbox"/> Printing Language <input type="checkbox"/> Universal Print Settings <input type="checkbox"/> PC Connection via USB <input type="checkbox"/> USB I/F Timeout Setting <input type="checkbox"/> Network Settings <input type="checkbox"/> Powerful Cleaning <input type="checkbox"/> Discharging/Charging Ink
	On	
Restore Default Settings		





Using the Menu

Settings item	Settings value	Explanation
Network Settings	Yes	Touch Yes to restore all Wi-Fi/network settings to the manufacturer's settings.
	No	
Copy Settings (SC-T5100M Series/ SC-T3100M Series on- ly)	Yes	Touch Yes to restore Copy Settings to the default settings.
	No	
Scan Settings (SC-T5100M Series/ SC-T3100M Series on- ly)	Yes	Touch Yes to restore all Scan Settings to the default settings.
	No	
Clear All Data and Settings	Yes	Touch Yes to restore all settings with the exception of Date/Time Settings, Length Unit, and Language in the Settings menu to the default settings.
	No	
Firmware Update		
Update		Using this function requires that the printer be connected to a network that can be connected to the Internet. Touch Start Checking to access the Epson website, and to start a search for new firmware. If there is a display indicating that there is new firmware, then follow the on-screen instructions to update the firmware. Updating firmware takes approximately 5 minutes. However, this may take longer depending on the network environment. During update, do not turn off the printer or unplug the power cable from the outlet. Failure to observe this precaution could lead to damage.
Notification	Off*	Set On to automatically check periodically for new firmware. If new firmware is found, a message will be displayed when the power is turned on.
	On	

Maintenance

Settings item	Settings value	Explanation
Print Quality Adjustment	Paper Source	Perform the same adjustment as in Media Adjust in the Paper Setting menu. When carrying out this action from this menu, select the paper source from the first screen.  "Optimizing Paper Settings (Media Adjust)" on page 46
	Start	
Print Head Nozzle Check	Paper Source	Check for clogged nozzles by printing a check pattern.  "Checking the print head for clogging and then cleaning" on page 180
	Start	
Head Cleaning	Start	Perform if the printed check pattern has faint or missing areas.  "Checking the print head for clogging and then cleaning" on page 180
Paper Guide Cleaning	Start	Run this when the printing side of the paper is soiled when printing from the auto sheet feeder.  "Smearing occurs when printing from the auto sheet feeder" on page 195

Using the Menu

Settings item	Settings value	Explanation
Ink Cartridge(s) Replacement	Start	Touch Start to move the print head to the position at which the ink cartridge can be replaced. The replacement procedure is shown on the screen, so replace the ink cartridges while referring to this.  "Replacing Ink Cartridges" on page 181
Replace Maintenance Box	Display procedure	Select when replacing the Maintenance Box while confirming the procedure. If you are familiar with replacement and do not need to confirm the procedure, you can replace the Maintenance Box without selecting this menu item.  "Replacing Maintenance Box" on page 183
Replace Cutter	Start	Select to replace the cutter if the paper is not cut cleanly. Follow the on-screen instructions to replace.  "Replacing the Cutter" on page 184
Powerful Cleaning	Start	Run this when the faint or missing areas in the check pattern do not improve even after performing Head Cleaning three times in a row.  "Powerful Cleaning" on page 180
Discharging/Charging Ink	Start	The print head may fail if the environmental temperature becomes -10°C or lower. Perform this action if you expect to be transporting/storing the printer in an environment of -10°C or less. Touch Start , and follow the on-screen instructions to discharge the ink. When operations are complete, the power turns off automatically.  "Handling if Transporting/Leaving the Printer in an Environment of -10°C or Less" on page 218

Printer Status/Print

Settings item	Settings value	Explanation
Print Status Sheet		
	Configuration Status Sheet	Print a list of current printer settings. Use this to view all information at a glance.
Network		Display current network settings details. Displayed details are the same as displayed in General Settings - Network Settings - Network Status .

Using the Menu

Enlarged Copy menu (except for the SC-T5100M Series/SC-T3100M Series)

Displayed when an Epson A3 or A4 scanner is connected to the printer. Set scaling in this menu to enable enlarged printing of the scanned documents.

 [“Making Enlarged Copies with an A3 or A4 Scanner \(Except for the SC-T5100M Series/SC-T3100M Series\)” on page 111](#)

*Default setting

Settings item	Settings value	Explanation
Copies	1 to 99	Specify the number of copies.
Color Mode	Black/White	Choose whether to do enlarged copying in color or in black and white.
	Color *	
Original Size	A4	Select the document size loaded on the scanner. The sizes available vary with the scanner. Sizes other than those shown here cannot be used.
	A5	
	A3	
	B5	
	B4	
	Letter	
	13 x 18 cm (5 x 7 in)	
Reduce/Enlarge		
Auto Fit Page	On *	Set to On to enlarge the copy so that the short edge of the original fits the width of the roll paper currently loaded in the printer.
	Off	If the short edge of the document is wider than the roll paper, this will be printed at actual size. If the printer is unable to detect the width of the roll paper, then an error will occur when copying is started.
Custom Size	Actual Size	Select the output size. To the left of each size, the percentage of enlargement of the selected document size is displayed. A0, US E, and B1 are only displayed for the SC-T5100M Series/SC-T5100 Series/SC-T5100N Series. If the desired size is not in the list, set the desired size in User-Defined .
	A0	
	US E (34x44in)	
	JIS B1	
	A1	
	US D (22x34in)	
	JIS B2	
	US C (17x22in)	
A2		
User-Defined		
Density	-4 to 4(0*)	Choose copy density.

Using the Menu

Settings item	Settings value	Explanation
Quality	Speed	Choose Copy Quality in view of image quality and print speed.
	Fine	

Using the Menu

Memory Device menu (SC-T5100M Series/SC-T3100M Series only)

Displayed when a USB flash memory is connected to the printer. This section explains the **Basic Settings** and **Advanced** menus displayed after selecting the print menu for each file.

 [“Printing Files on USB Flash Memory Directly” on page 101](#)

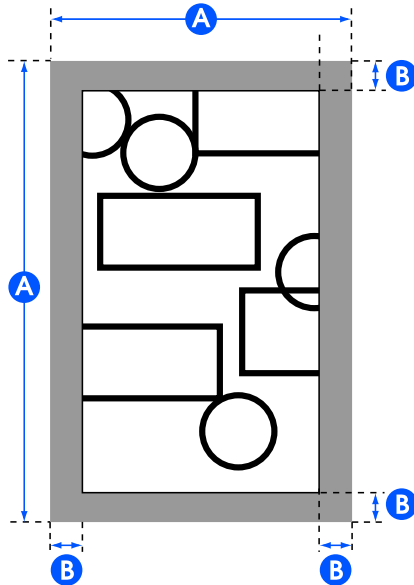
Settings item	Settings value	Explanation
Basic Settings		
Copies	1 to 99	Specify the number of copies.
Paper Source	Roll Paper *	Select the paper source. If the paper is not loaded as in the set paper source, then an error will occur during printing.
	Auto Sheet Feeder	
	Cut Sheet (1 sheet)	
Color Mode	Black/White	Select whether to print in color or black and white.
	Color *	
Advanced		
Quality	Standard	Select the print quality.
	Speed *	
	Fine	
	Super Fine	
Page Margins option	Clip By Margins *	<p>Add margins (areas of B in the following illustration) inside the output size (areas of A in the following illustration) set in the Reduce/Enlarge settings. When there is a print object in the margin section, it is clipped and not printed.</p> 

Using the Menu

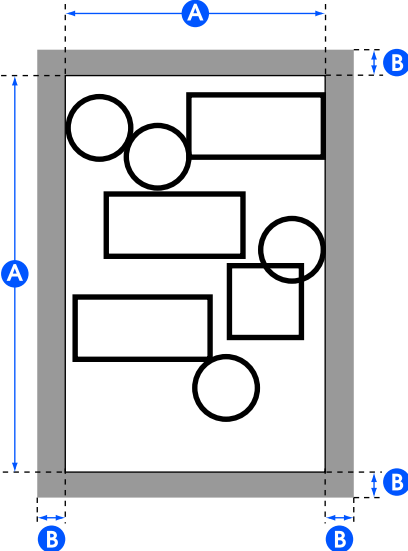
Settings item	Settings value	Explanation
	Oversize	<p>Add margins (areas of B in the following illustration) outside the output size (areas of A in the following illustration) set in the Reduce/Enlarge settings. With the actual output size, the margin sections become larger than the set output size (areas of A in the following illustration).</p> 
Bidirectional	On *	Setting this to On will cause the print head to print while moving both left and right. Setting this to Off reduces ruled line misalignment, but printing takes more time.
	Off	
Color Mode	Poster(Photo)/Perspective	Print posters and perspective drawings that use photos with their natural colors.
	Poster/Document *	Print posters that combine letters and illustrations with vivid colors.
	GIS	Print maps clearly.
	CAD/Line Drawing	Print letters and fine lines clearly.
	Off (No Color Management)	Do not perform color correction.

Using the Menu

Settings item	Settings value	Explanation
Reduce/Enlarge		
Auto Fit Page	On	Set to On to print so that the short edge of the original fits the width of the paper loaded in the printer.
	Off*	<p>If the short edge of the document is wider than the paper, printing will be at actual size.</p> <p>If paper is not loaded as set in Paper Source of Basic Settings, this cannot be set to On. Furthermore, if the Paper Source setting is changed without replacing or loading the paper after setting this to On, this setting is returned to Actual Size.</p> <p>If the printer is unable to detect the width of the paper, an error will occur when the Print button is touched.</p>
Custom Size	Actual Size*, A4, A3, Super A3, A2, Super A2, A1, Super A1, A0, Super A0, Letter, Legal, US B (11x17in), US C (17x22in), US D (22x34in), US E (34x44in), ARCH A (9x12in), ARCH B (12x18in), ARCH C (18x24in), ARCH D (24x36in), ARCH E1 (30x42in), ARCH E (36x48in), ISO B4, ISO B3, ISO B2, ISO B1, JIS B4, JIS B3, JIS B2, JIS B1, 610 x 762 mm, 762 x 1016 mm, 914 x 1118 mm, 30 x 40 cm, 40 x 60 cm, 50 x 70 cm, 60 x 90 cm, 70 x 100 cm, User-Defined	Select the output size. To the left of each size, the percentage of enlargement of the selected document size is displayed. If the desired size is not in the list, set the desired size in User-Defined .

Using the Menu

Copy Menu (SC-T5100M Series/SC-T3100M Series Only)

*Default setting

Settings item	Settings value	Explanation
Basic Settings		
Copies	1 to 99	Specify the number of copies.
Color Mode	Black/White	Select whether to copy in color or black and white.
	Color *	
Quality	Speed *	Select the print quality.
	Fine	
	Super Fine	
Density	-4 to 4(0*)	Choose the density for the copy results. Negative values (-) are lighter and positive values (+) are darker.
Paper Source	Roll Paper *	Select the paper source for copying and printing.
	Auto Sheet Feeder	
	Cut Sheet (1 sheet)	
Reduce/Enlarge		
Auto Fit Page	On	Set to On to enlarge the copy so that the short edge of the original fits the width of the roll paper currently loaded in the printer.
	Off *	If the short edge of the document is wider than the roll paper, this will be printed at actual size. If the printer is unable to detect the width of the roll paper, then an error will occur when copying is started.
Custom Size	Actual Size, ISO A4->A0, ISO A3->A0, ISO A4->A1, ISO A2->A0, ISO A3->A1, ISO A1->A0, ISO A2->A1, ISO A0->A1, ISO A1->A2, ISO A0->A2, ISO A1->A3, ISO A0->A3, ISO A1->A4, ISO A0->A4, US ANSI/ARCH A->E, US ANSI/ARCH B->E, US ANSI/ARCH A->D, US ANSI/ARCH C->E, US ANSI/ARCH B->D, US ANSI/ARCH D->E, US ANSI/ARCH C->D, US ANSI/ARCH E->D, US ANSI/ARCH D->C, US ANSI/ARCH E->C, US ANSI/ARCH D->B, US ANSI/ARCH E->B, US ANSI/ARCH D->A, US ANSI/ARCH E->A	Select the output size.

Using the Menu

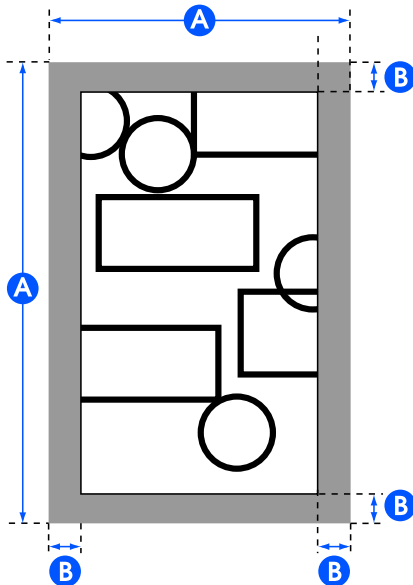
Settings item	Settings value	Explanation
Original Type	Text/Line Drawing *	Suitable for copying and scanning drawings printed on standard plain paper. This is also suitable for posters and so on that contain images.
	Tracing Paper	Suitable for copying and scanning drawings printed on tracing paper. This reduces the background color for tracing paper.
	Blueprint	Suitable for copying and scanning blueprints. This reduces the background color for blueprints.
Advanced		
Original Size		
Auto Detect	-	The default setting of Auto Detect is recommended in most situations. Note that, depending on the original, it may not be possible to detect the width correctly even when the setting is Auto Detect . Similarly, tracing paper and the optional carrier sheet are not detected automatically. In such cases, change from the standard size and specify a width of your choosing. If the desired size is not in the options, then select User-Defined, and enter the length and width of the original.
ISO A	Display supported sizes for originals	
US-ANSI		
US-ARCH		
JIS B		
ISO B		
User-Defined		
Top Offset	0.0 to 100.0mm (0.0*) 0.00 to 3.94inch (0.00*)	If you do not want to copy the top margin of the original, you can adjust the top, and then copy the original. Enter the value for the length from the top of where you want to start copying. If the carrier sheet is loaded, set the value to 19 mm.
Page Margins option	Clip By Margins *	Add margins (areas of B in the following illustration) inside the output size (areas of A in the following illustration) set in the Reduce/Enlarge settings. When there is a print object in the margin section, it is clipped and not printed. 

Using the Menu

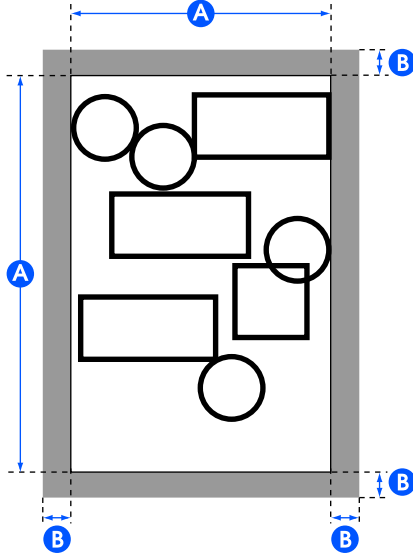
Settings item	Settings value	Explanation
	Oversize	<p>Add margins (areas of B in the following illustration) outside the output size (areas of A in the following illustration) set in the Reduce/Enlarge settings. With the actual output size, the margin sections become larger than the set output size (areas of A in the following illustration).</p> 
Image Quality		
Contrast	-4 to 4(0*)	Set the contrast. Negative values (-) are weaker and positive values (+) are stronger.
Sharpness	-4 to 4(0*)	Set the sharpness. Negative values (-) are weaker and positive values (+) are stronger.
Remove Background		
Auto	On *	When this is set to On , it removes the background from paper with a low whiteness level such as recycled paper.
	Off	If you want to remove the background when scanning color or thin paper documents, select Off , and then set the adjustment value from -4 to 4. Negative values (-) are weaker and positive values (+) are stronger.
-4 to 4	-	
Bidirectional	On *	Setting this to On will cause the print head to print while moving both left and right. Setting this to Off reduces ruled line misalignment, but printing takes more time.
	Off	
Clear All Settings	Yes	Touch Yes to restore all Basic Settings and Advanced to the default settings.
	No	

Using the Menu

Scan Menu (SC-T5100M Series/SC-T3100M Series Only)

*Default setting

Settings item	Settings value	Explanation
Network Folder/FTP		
Destination	Display the Location Selection screen	Specify the location for the scanned image. Specify the location from the recipients registered for frequent use or the recipients registered in your Contacts. If a recipient is not registered in your Contacts, touch Keyboard , and then edit the location.
Scan Settings		
Color Mode	Black/White	Select whether to scan in color or black and white.
	Color *	
File Format		
File Format	JPEG	Select the file format in which to save the scanned image.
	PDF*	
	PDF/A	
	TIFF (Multi Page)	
Compression Ratio	High Compression	Select the compression ratio for when you save the scanned image.
	Standard Compression *	
	Low Compression	

Using the Menu

Settings item	Settings value	Explanation
PDF Settings		
Document Open Password		Setting the file format to PDF allows you to set the security for the PDF. Set Document Open Password when you create a PDF that requires a password to be opened. To create a PDF file for which a password is needed to print or edit, set the Permissions Password.
Password Setting	Off *	
	On	
Password	Enter password	
Permissions Password		
Password Setting	Off *	
	On	
Password	Enter password	
Printing	Allowed *	
	Not Allowed	
Editing	Allowed *	
	Not Allowed	
Resolution	200 dpi	Select the resolution for scanning.
	300dpi *	
	400 dpi	
	600 dpi	
Scan Size		
Auto Detect	-	The default setting of Auto Detect is recommended in most situations. Note that, depending on the original, it may not be possible to detect the width correctly even when the setting is Auto Detect . Similarly, tracing paper and the optional carrier sheet are not detected automatically. In such cases, change from the standard size and specify a width of your choosing. If the desired size is not in the options, then select User-Defined, and enter the length and width of the original.
ISO A	Display supported scan sizes	
US-ANSI		
US-ARCH		
JIS B		
ISO B		
User-Defined		
Top Offset	0.0 to 100.0mm (0.0*)	If you do not want to scan the top margin of the original, you can adjust the top, and then scan. Enter the value for the length from the top of where you want to start scanning. If the carrier sheet is loaded, set the value to 19 mm.
	0.00 to 3.94inch (0.00*)	

Using the Menu

Settings item	Settings value	Explanation
Original Type	Text/Line Drawing *	Suitable for copying and scanning drawings printed on standard plain paper. This is also suitable for posters and so on that contain images.
	Tracing Paper	Suitable for copying and scanning drawings printed on tracing paper. This reduces the background color for tracing paper.
	Blueprint	Suitable for copying and scanning blueprints. This reduces the background color for blueprints.
Density	-4 to 4(0*)	Select the density for scanning. Negative values (-) are lighter and positive values (+) are darker.
Image Quality		
Contrast	-4 to 4(0*)	Set the contrast. Negative values (-) are weaker and positive values (+) are stronger.
Sharpness	-4 to 4(0*)	Set the sharpness. Negative values (-) are weaker and positive values (+) are stronger.
Remove Background		
Auto	On *	When this is set to On , it removes the background from paper with a low whiteness level such as recycled paper or newspapers. If you want to remove the background when scanning color or thin paper documents, select Off , and then set the adjustment value from -4 to 4. Negative values (-) are weaker and positive values (+) are stronger.
	Off	
-4 to 4	-	
File Name		
Filename Prefix	Enter the filename prefix	Use single-byte alphanumeric characters or symbols to enter the prefix for the file name of the image.
Add Date	On *	Add the date to the file name.
	Off	
Add Time	On *	Add the time to the file name.
	Off	
Clear All Settings	Yes	Touch Yes to restore all Scan Settings to the default settings.
	No	
Email		

Using the Menu

Settings item	Settings value	Explanation
Destination	Display the Location Selection screen	Specify the recipient of the scanned image. Specify a recipient from the recipients registered for frequent use or the recipients registered in your Contacts. If a recipient is not registered in your Contacts, touch Keyboard , and then enter the recipient.
Scan Settings		
Color Mode	Black/White	Select whether to scan in color or black and white.
	Color *	
File Format		
File Format	JPEG	Select the file format in which to save the scanned image.
	PDF*	
	PDF/A	
	TIFF (Multi Page)	
Compression Ratio	High Compression	Select the compression ratio for when you save the scanned image.
	Standard Compression *	
	Low Compression	

Using the Menu

Settings item	Settings value	Explanation
PDF Settings		
Document Open Password		Setting the file format to PDF allows you to set the security for the PDF. Set Document Open Password when you create a PDF that requires a password to be opened. To create a PDF file for which a password is needed to print or edit, set the Permissions Password.
Password Setting	Off *	
	On	
Password	Enter password	
Permissions Password		
Password Setting	Off *	
	On	
Password	Enter password	
Printing	Allowed *	
	Not Allowed	
Editing	Allowed *	
	Not Allowed	
Resolution	200 dpi	Select the resolution for scanning.
	300dpi *	
	400 dpi	
	600 dpi	
Scan Size		
Auto Detect	-	The default setting of Auto Detect is recommended in most situations. Note that, depending on the original, it may not be possible to detect the width correctly even when the setting is Auto Detect . Similarly, tracing paper and the optional carrier sheet are not detected automatically. In such cases, change from the standard size and specify a width of your choosing. If the desired size is not in the options, then select User-Defined, and enter the length and width of the original.
ISO A	Display supported scan sizes	
US-ANSI		
US-ARCH		
JIS B		
ISO B		
User-Defined	Display the Scan Size Input screen	
Top Offset	0.0 to 100.0mm (0.0*)	If you do not want to scan the top margin of the original, you can adjust the top, and then scan. Enter the value for the length from the top of where you want to start scanning. If the carrier sheet is loaded, set the value to 19 mm.
	0.00 to 3.94inch (0.00*)	

Using the Menu

Settings item	Settings value	Explanation
Original Type	Text/Line Drawing *	Suitable for copying and scanning drawings printed on standard plain paper. This is also suitable for posters and so on that contain images.
	Tracing Paper	Suitable for copying and scanning drawings printed on tracing paper. This reduces the background color for tracing paper.
	Blueprint	Suitable for copying and scanning blueprints. This reduces the background color for blueprints.
Density	-4 to 4(0*)	Select the density for scanning. Negative values (-) are lighter and positive values (+) are darker.
Image Quality		
Contrast	-4 to 4(0*)	Set the contrast. Negative values (-) are weaker and positive values (+) are stronger.
Sharpness	-4 to 4(0*)	Set the sharpness. Negative values (-) are weaker and positive values (+) are stronger.
Remove Background		
Auto	On *	When this is set to On , it removes the background from paper with a low whiteness level such as recycled paper or newspapers. If you want to remove the background when scanning color or thin paper documents, select Off , and then set the adjustment value from -4 to 4. Negative values (-) are weaker and positive values (+) are stronger.
	Off	
-4 to 4	-	
Subject	Enter subject	Use single-byte alphanumeric characters or symbols to enter the subject of the email.
Attached File Max Size	1MB	Select a maximum size for files that are attached to emails.
	2MB	
	5MB	
	10MB	
	20MB	
	30MB *	
File Name		
Filename Prefix	Enter the filename prefix	Use single-byte alphanumeric characters or symbols to enter the prefix for the file name of the image.
Add Date	On *	Add the date to the file name.
	Off	
Add Time	On *	Add the time to the file name.
	Off	
Clear All Settings	Yes	Touch Yes to restore all Scan Settings to the default settings.
	No	

Using the Menu

Settings item	Settings value	Explanation
Memory Device		
Basic Settings		
Color Mode	Black/White	Select whether to scan in color or black and white.
	Color *	
File Format		
File Format	JPEG	Select the file format in which to save the scanned image.
	PDF*	
	PDF/A	
	TIFF (Multi Page)	
Compression Ratio	High Compression	Select the compression ratio for when you save the scanned image.
	Standard Compression *	
	Low Compression	
PDF Settings		
Document Open Password		Setting the file format to PDF allows you to set the security for the PDF. Set Document Open Password when you create a PDF that requires a password to be opened. To create a PDF file for which a password is needed to print or edit, set the Permissions Password.
Password Setting	Off *	
	On	
Password	Enter password	
Permissions Password		
Password Setting	Off *	
	On	
Password	Enter password	
Printing	Allowed *	
	Not Allowed	
Editing	Allowed *	
	Not Allowed	
Resolution	200 dpi	Select the resolution for scanning.
	300dpi *	
	400 dpi	
	600 dpi	

Using the Menu

Settings item	Settings value	Explanation
Scan Size		
Auto Detect	-	The default setting of Auto Detect is recommended in most situations. Note that, depending on the original, it may not be possible to detect the width correctly even when the setting is Auto Detect . Similarly, tracing paper and the optional carrier sheet are not detected automatically. In such cases, change from the standard size and specify a width of your choosing. If the desired size is not in the options, then select User-Defined, and enter the length and width of the original.
ISO A	Display supported scan sizes	
US-ANSI		
US-ARCH		
JIS B		
ISO B		
User-Defined	Display the Scan Size Input screen	
Top Offset	0.0 to 100.0mm (0.0*) 0.00 to 3.94inch (0.00*)	If you do not want to scan the top margin of the original, you can adjust the top, and then scan. Enter the value for the length from the top of where you want to start scanning. If the carrier sheet is loaded, set the value to 19 mm.
Original Type	Text/Line Drawing *	Suitable for copying and scanning drawings printed on standard plain paper. This is also suitable for posters and so on that contain images.
	Tracing Paper	Suitable for copying and scanning drawings printed on tracing paper. This reduces the background color for tracing paper.
	Blueprint	Suitable for copying and scanning blueprints. This reduces the background color for blueprints.
Advanced		
Density	-4 to 4(0*)	Select the density for scanning. Negative values (-) are lighter and positive values (+) are darker.
Image Quality		
Contrast	-4 to 4(0*)	Set the contrast. Negative values (-) are weaker and positive values (+) are stronger.
Sharpness	-4 to 4(0*)	Set the sharpness. Negative values (-) are weaker and positive values (+) are stronger.
Remove Background		
Auto	On *	When this is set to On , it removes the background from paper with a low whiteness level such as recycled paper or newspapers.
	Off	
-4 to 4	-	If you want to remove the background when scanning color or thin paper documents, select Off , and then set the adjustment value from -4 to 4. Negative values (-) are weaker and positive values (+) are stronger.

Using the Menu

Settings item	Settings value	Explanation
File Name		
Filename Prefix	Enter the filename prefix	Use single-byte alphanumeric characters or symbols to enter the prefix for the file name of the image.
Add Date	On *	Add the date to the file name.
	Off	
Add Time	On *	Add the time to the file name.
	Off	
Clear All Settings	Yes	Touch Yes to restore all Basic Settings and Advanced to the default settings.
	No	

Using the Menu

Network Folder Menu (SC-T5100M Series/SC-T3100M Series Only)

*Default setting

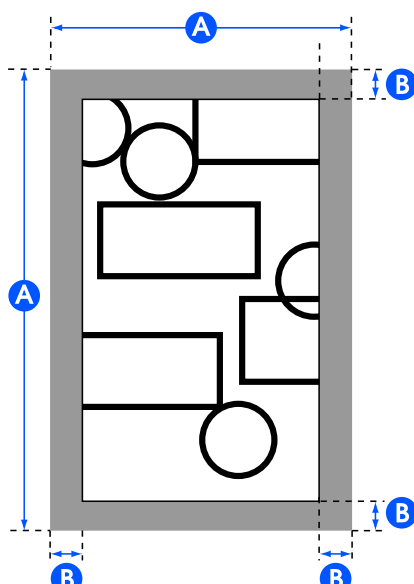
Settings item	Settings value	Explanation
Basic Settings		
Paper Source	Roll Paper *	Select the paper source. If the paper is not loaded as in the set paper source, then an error will occur during printing.
	Auto Sheet Feeder	
	Cut Sheet (1 sheet)	
Color Mode	Black/White	Select whether to print in color or black and white.
	Color *	
Advanced		
Quality	Speed *	Select the print quality.
	Fine	
	Super Fine	
Page Margins option	Clip By Margins *	<p>Add margins (areas of B in the following illustration) inside the output size (areas of A in the following illustration) set in the Reduce/Enlarge settings. When there is a print object in the margin section, it is clipped and not printed.</p> 

Using the Menu

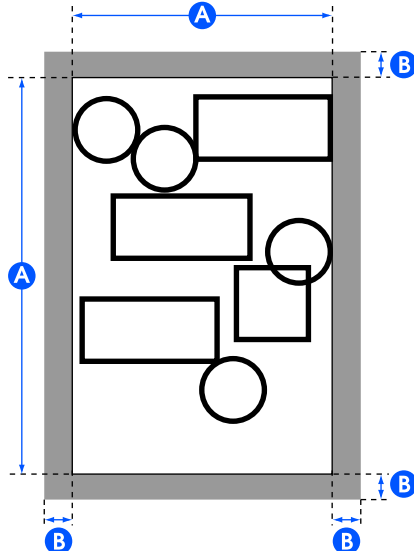
Settings item	Settings value	Explanation
	Oversize	<p>Add margins (areas of B in the following illustration) outside the output size (areas of A in the following illustration) set in the Reduce/Enlarge settings. With the actual output size, the margin sections become larger than the set output size (areas of A in the following illustration).</p> 
Bidirectional	On *	Setting this to On will cause the print head to print while moving both left and right. Setting this to Off reduces ruled line misalignment, but printing takes more time.
	Off	
Color Mode (Common)	EPSON Standard (sRGB)	Optimize the sRGB space and correct the color.
	Business Graphics *	Perform color correction to sharpen your images based on the sRGB space.
	GIS	Perform color correction suitable for when printing GIS (Geographic Information System) topographical maps or similar.
	Line Drawing	Perform color correction suitable for CAD drawings and other line drawings.
	Off (No Color Management)	Do not perform color correction.
Reduce/Enlarge		
Auto Fit Page	On	<p>Set to On to print so that the short edge of the original fits the width of the paper loaded in the printer.</p> <p>If the short edge of the document is wider than the paper, printing will be at actual size.</p> <p>If the paper is not loaded as set in Paper Source of Basic Settings, this cannot be set to On. Furthermore, if the settings for the Paper Source are changed without replacing or loading the paper after setting this to On, the settings return to the actual size in the default settings. If the printer is unable to detect the width of the paper, an error will occur when the Print button is touched.</p>
	Off *	
Custom Size	25%-1024%	Select the output size. If the Actual Size is not selected, set the desired size in User-Defined.
Standard Size	Actual Size *, User-Defined	

Maintenance

Maintenance

Clearing a Clogged Print Head

The print head nozzles may be clogged if the printouts have streaks, uneven colors, blurred text, or if the image is printed in an unexpected color. Check the nozzles and clean the print head if it is clogged. If clogging cannot be cleared after performing normal cleaning three times in a row, perform a powerful head cleaning.

Note the following points before cleaning.

- ❑ Cleaning the print head consumes ink. This is only necessary when there is a problem with the print results and a nozzle check has confirmed clogging. Powerful head cleaning consumes more ink than normal print head cleaning.
- ❑ If the ink levels are low, prepare new ink bottles in advance.
- ❑ If the amount of free space in the maintenance box is low, prepare a new maintenance box in advance.

Checking the print head for clogging and then cleaning

- 1 From the Home screen, touch **Settings - Maintenance - Print Head Nozzle Check**.
- 2 Touch **Start** to start printing a check pattern. When changing the paper source displayed on the start screen, touch **Paper Source**.
- 3 Refer to the following, and check the printed check pattern for clogging.

Example of clean nozzles

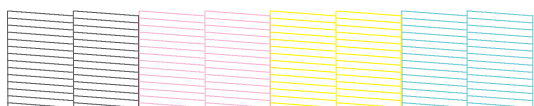

If none of the pattern is missing, the print head nozzles are not clogged. Touch **O** to end the nozzle clogging check.

Example of clogged nozzles

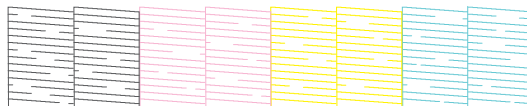

If the pattern has missing areas, touch **X** to display the **Head Cleaning** screen. Proceed to the next step.

- 4 Touch **Start** to start cleaning. When cleaning is complete, **Print the pattern?** is displayed. Touch **Yes** to return to step 2. Repeat steps 2 to 4, and check if the problem has been resolved.

If the nozzles are still clogged after performing print head cleaning three times in a row, then perform **Powerful Cleaning**.

Powerful Cleaning

Perform powerful head cleaning when normal head cleaning has been performed three times in a row and the clogging has not been cleared.

- 1 From the Home screen, touch **Settings - Maintenance - Powerful Cleaning**.
- 2 Touch **Start** to start cleaning. When cleaning is complete, **Print the pattern?** is displayed. Touch **Yes** and then touch **Start** on the next screen to print a check pattern. Check if the clogged nozzles have been cleared.

If the nozzles are still clogged after performing Powerful Cleaning, turn off the printer and leave it overnight or longer. When left for some time, the clogged ink may dissolve.

If the nozzles are still clogged, contact your dealer or Epson Support.

Maintenance

Replacing Consumables

Handling of Used Consumables

If using the printer in an office or other business, dispose of used consumables in accordance with laws and regulations, such as by contracting an industrial waste disposal company.

If using the printer in a domestic situation, place these in a plastic bag, then dispose of in accordance with laws and regulations as well as regional ordinances, and as directed by local government.

Replacing Ink Cartridges

If any of the ink colors remaining amount falls below the minimum amount, printing will not be possible.

If an ink cartridge remaining amount falls below the minimum amount, you can continue printing after replacing the ink cartridge.

If the remaining ink amount drops yet printing is continued, then replacement of an ink cartridge during printing may be required. When replacing ink during a print job, you may see a difference in color depending on the drying conditions. When this is not permissible, we recommend first replacing the ink cartridge with a new one before printing. The removed ink cartridge can be installed again and used until the remaining amount falls below the minimum amount. However, if an ink cartridge with not much ink remaining is removed and reinstalled, it may not be usable because some ink is consumed to ensure the reliability of the printer.

Supported ink cartridges  [“Options and Consumable Products” on page 206](#)

Caution:

When opening and closing the scanner unit, keep your hands away from the joint between the unit and the printer.

If your fingers or hands get caught, it could cause an injury.

Important:

Epson recommends the use of genuine Epson ink cartridges. Epson cannot guarantee the quality or reliability of non-genuine ink. The use of non-genuine ink may cause damage that is not covered by Epson's warranties, and under certain circumstances, may cause erratic printer behavior. Information about non-genuine ink levels may not be displayed, and use of non-genuine ink is recorded for possible use in service support.

1 From the Home screen, touch **Settings - Maintenance - Ink Cartridge(s) Replacement**.

2 Touch **Start** and open the front cover. For the SC-T5100M Series/SC-T3100M Series, press **Start** to open the scanner unit.

The print head moves to the position at which the ink cartridge can be replaced.

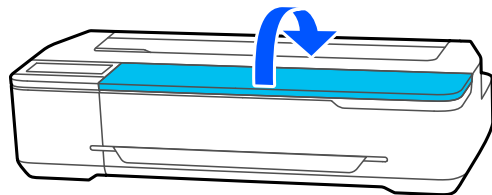

Important:

Do not move the print head by hand. Failure to observe this precaution could damage the printer.

3 Hold the new ink cartridge as shown below, and shake it up and down around 20 times (for 10 seconds).

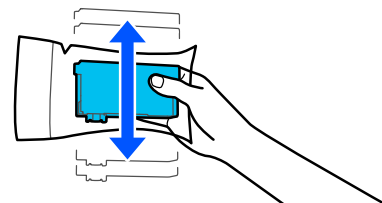

Maintenance

- 4** Remove the new ink cartridge from the package and then peel off only the yellow tape.

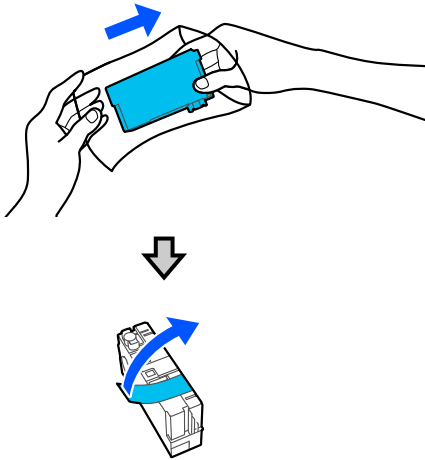

! Important:

Do not touch the parts shown in the illustration. You may not be able to print properly.

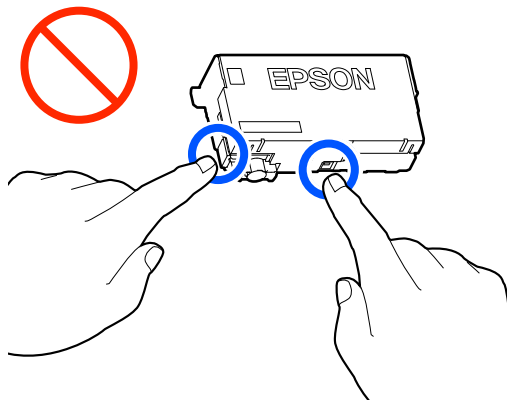

- 5** Open the cartridge cover.

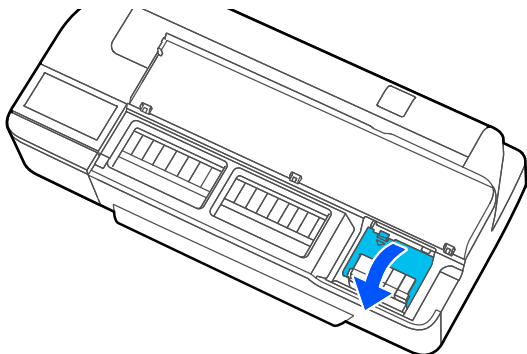

- 6** Remove the ink cartridge to replace.

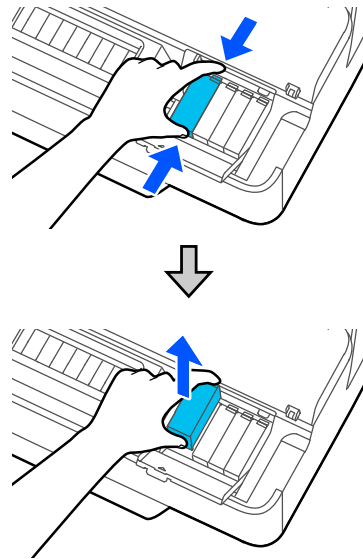

! Important:

Removed ink cartridges may have ink around the ink supply port, so be careful not to get any ink on the surrounding area when removing the cartridges.

- 7** Holding the new cartridge with the label facing up, and insert it perpendicularly. Push the area marked "Push" firmly.

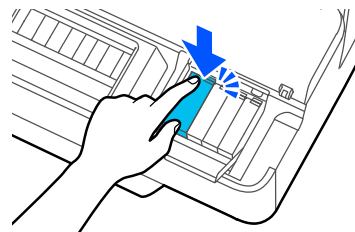

Repeat steps 3 to 7 (except step 5) to replace other ink cartridges.

! Important:

Install ink cartridges into all slots. You cannot print if any of the slots are empty.

Maintenance

8

Close the cartridge cover and front cover. For the SC-T5100M Series/SC-T3100M Series, close the cartridge cover and the scanner unit.

Ink charging starts. When the message **Replacement is complete.** is displayed, the procedure is complete.

! **Important:**

Do not turn off the printer during ink charging. Doing so cause insufficient ink charge resulting in printing faint image or nothing.

Replacing Maintenance Box

When the message **The Maintenance Box is at the end of its service life.** is displayed, you need to replace the maintenance box.

When the message **The Maintenance Box is nearing the end of its service life.** is displayed, prepare a new maintenance box. Printing is possible until replacement is instructed.

Supported maintenance box  [“Options and Consumable Products”](#) on page 206

! **Important:**

Do not replace the Maintenance Box while printing. Waste ink may leak.

Note:

*You can replace the Maintenance Box while viewing the procedure on the screen. To see the guide, from the Home screen, touch **Settings - Maintenance - Replace Maintenance Box.***

- 1 Open the Maintenance Box cover on the back of the printer.

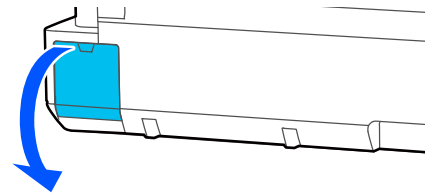

- 2 Pull out the Maintenance Box.

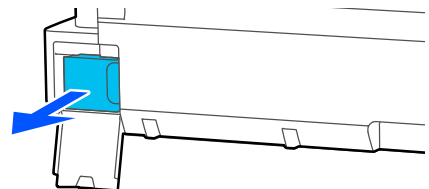

- 3 Place the used Maintenance Box in the clear bag included with the new Maintenance Box, and make sure that the zipper is closed tight.

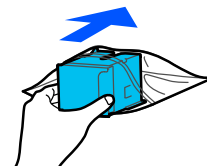

Maintenance

! **Important:**

Until the fastener is closed securely, do not tilt the Maintenance Box. Waste ink may leak.

4

Align the protruding lip of the new Maintenance Box with the rail at the insertion point, and insert the box until it cannot go any further.

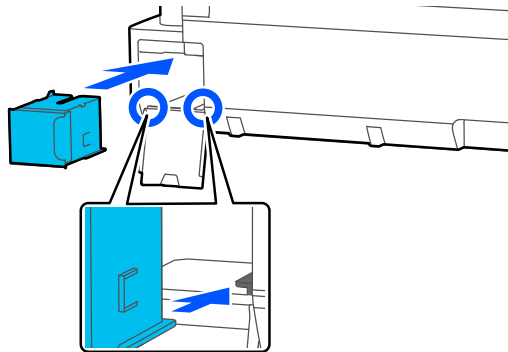

! **Important:**

Do not touch the IC chip on the Maintenance Box. Doing so may prevent normal operation and printing.

5

Close the Maintenance Box cover.

Replacing the Cutter

Replace the cutter when it is not cutting paper cleanly.

Supported cutter [“Options and Consumable Products” on page 206](#)

Use a cross-head screwdriver to replace the cutter. Make sure you have a cross-head screwdriver with you before you start work.

! **Caution:**

Store the cutter out of the reach of children. The cutter's blade could cause an injury. Pay careful attention when replacing the cutter.

! **Important:**

- Dropping the cutter, or knocking it against hard objects may chip the blade.
- The protective material and sheet inserted in the new cutter is to protect the blade. Do not remove it until you are instructed to do so.



1

From the Home screen, touch **Settings - Maintenance - Replace Cutter**.

The Replace Cutter screen appears.

2

Touch **Start** to open the cutter cover.

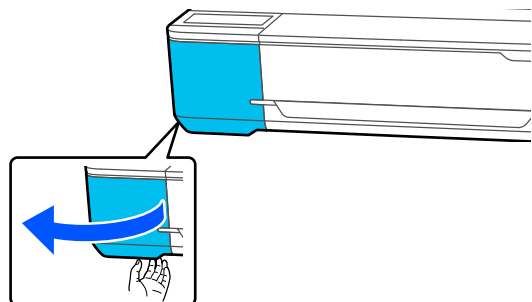

Maintenance

- 3** Loosen the screw holding the cutter in place using a cross-head screwdriver and pull the cutter straight out.

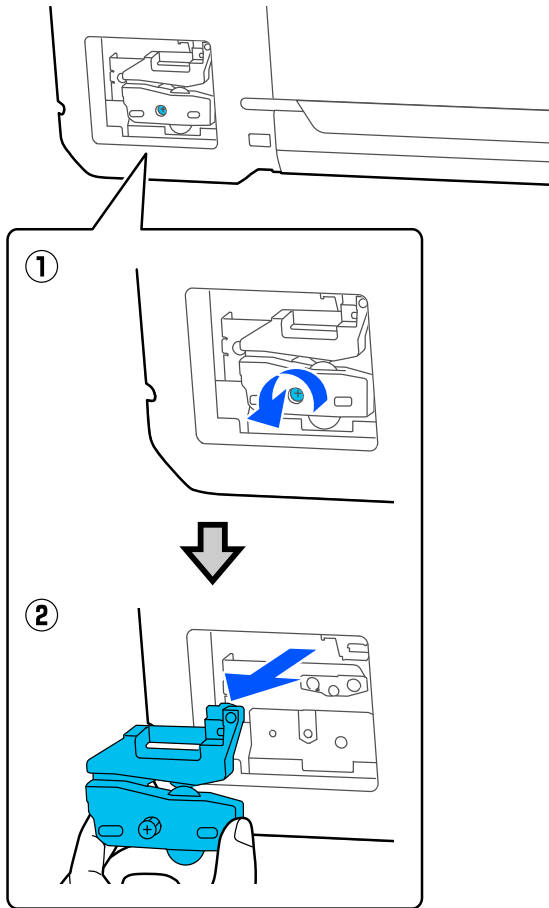

Note:
Place the used cutter in a plastic bag, then dispose of in accordance with regional ordinances, and as directed by local government.

- 4** Install the new cutter.
Insert the cutter so that the pin on the printer matches up with the hole on the cutter. Use a cross-head screwdriver to tighten down the screw to hold the cutter in place.

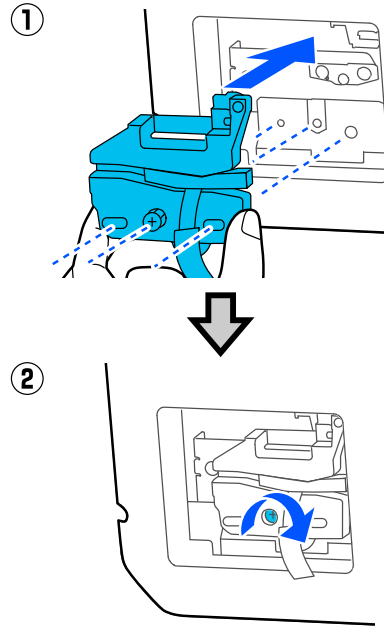

! Important:
Screw the cutter firmly, otherwise the cut position may be slightly shifted or skewed.

- 5** Remove the protective material shown in the figure.

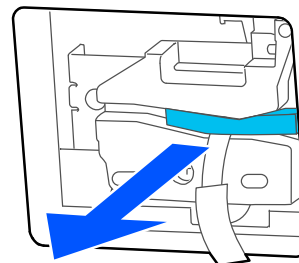

! Important:
Do not pull the protective sheet.

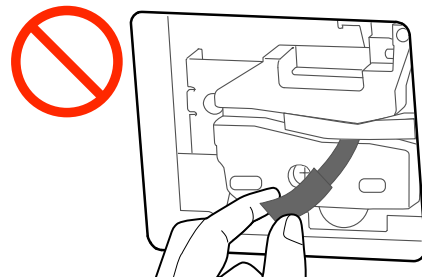

Maintenance

- 6** Touch **OK**.
The cutter moves and the protective sheet stuck to the blade comes off. Remove the protective sheet.
- 7** Close the cutter cover.

Problem Solver

Problem Solver

What to do When a Message is Displayed

If the printer displays one of the messages shown below, refer to the solution listed and take the necessary steps.

Messages	Solutions
Cannot recognize ink cartridges. Try installing again.	<ul style="list-style-type: none"> <input type="checkbox"/> Remove and reinsert the ink cartridge. If the message persists, insert a new ink cartridge (do not reinstall the cartridge that caused the error). ☞ "Replacing Ink Cartridges" on page 181 <input type="checkbox"/> Condensation may occur in the ink cartridge. Leave it at room temperature for at least three hours before installing the ink cartridge again. ☞ "Notes on handling ink cartridges" on page 20
Ink is low.	<p>The ink is low. Ready a new ink cartridge. Printing is possible until replacement is instructed.</p> <p>☞ "Options and Consumable Products" on page 206</p>
The maintenance box is not recognized. Install it correctly.	<p>Reinstall the Maintenance Box. If the message persists after reinstalling it, replace with a new Maintenance Box (do not reinstall the Maintenance Box that caused the error).</p> <p>☞ "Replacing Maintenance Box" on page 183</p>
Cannot start cleaning because the Maintenance Box is full. You can continue printing until replacement is required.	<p>The Maintenance Box does not have enough capacity to store ink discharged in print head cleaning, and therefore cannot perform cleaning. To perform cleaning, replace the Maintenance Box with a new one. The removed Maintenance Box may be reinstalled after cleaning is completed.</p> <p>☞ "Replacing Maintenance Box" on page 183</p>
The paper was skewed or the paper size could not be detected. Reload the paper.	<ul style="list-style-type: none"> <input type="checkbox"/> Make sure the original is not at an angle, and then reload it. <input type="checkbox"/> If the original is not rectangular or the leading edge is not straight, it cannot be detected automatically. Change Scan Size from Auto Detect to a standard size and so on. <input type="checkbox"/> Check the following items if the same error continues to occur. <ul style="list-style-type: none"> <input type="checkbox"/> If Original Size or Scan Size is set to Auto Detect, the size of the original may not be detected correctly. Set Original Size or Scan Size. <input type="checkbox"/> You may be using an original that cannot be placed. See the following for details on originals that cannot be placed. ☞ "Documents That Cannot Be Loaded" on page 103
Command Error Check the printer driver setting.	<p>Touch Cancel to stop printing. Confirm that the printer driver you are using supports this printer.</p>
Scanner Error Refer to manual for details.	<ul style="list-style-type: none"> <input type="checkbox"/> Release the scanner transportation lock and turn the printer and scanner off and then on again. <input type="checkbox"/> Turn the devices on and off several times. The scanner can be used after the message is no longer displayed. <p>If this message appears on the LCD panel again, contact your dealer or Epson Support.</p>

Problem Solver

Messages	Solutions
Recovery Mode	<p>The firmware update failed, so the printer has started in recovery mode. Use the procedure below to update the firmware again.</p> <p>(1) Connect a computer and the printer using a USB cable. (Updates during recovery mode cannot use a network connection.)</p> <p>(2) Download the latest firmware from the Epson website, and start the update. Refer to the firmware download page for update methods.</p>

When a Maintenance Call/Printer Error Occurs

Error messages	Solutions
<p>Maintenance Request</p> <p>Parts Service Life Ending/End Of Parts Service Life XXXXXXXX</p>	<p>A part used in the printer is nearing the end of its service life.</p> <p>Contact your dealer or Epson Support and tell them the maintenance request code.</p> <p>You cannot clear a maintenance error until the part is replaced. A service call occurs if you continue to use the printer.</p>
<p>Printer Error</p> <p>Printer error. Turn power off and on again. For details, see your documentation. XXXXXX</p>	<p>Turn off the printer, disconnect the power cable from the outlet and from the AC inlet on the printer, and then reconnect. Turn on the printer again multiple times.</p> <p>If the same printer error is displayed on the LCD panel, contact your dealer or Epson Support for assistance. Tell them the printer error code is "XXXXXX".</p>

Problem Solver

Troubleshooting

You cannot print (because the printer does not work)

The printer does not turn on.

■ **Is the power cable plugged into the electrical outlet or the printer?**

Make sure the power cable is securely plugged into the printer.

■ **Is there a problem with the power outlet?**

Make sure your outlet works by connecting the power cable for another electric product.

The printer turns off automatically.

■ **Is the automatic power off configured?**

To prevent the printer turning off automatically, select **Off**.

["General Settings - Basic Settings" on page 138](#)

The printer driver is not installed properly (Windows).

■ **Is the icon for this printer displayed in the Devices and Printers/ Printers/Printers and Faxes folder?**

- Yes
The printer driver is installed. See the "The printer is not communicating with the computer" section.
- No
The printer driver is not installed. Install the printer driver.

■ **Does the printer port setting match the printer connection port?**

Check the printer port.

Click the **Port** tab in the printer Properties dialog and check the option selected for **Print to the following port(s)**.

- USB: **USBxxx** (x stands for the port number) for the USB connection
- Network: The correct IP address for the network connection

If it is not indicated, the printer driver is not installed correctly. Delete and reinstall the printer driver.

["Uninstalling Software" on page 28](#)

The printer driver is not installed properly (Mac).

■ **Is the printer added to the printer list?**

Select **System Preferences > Printers & Scanners** (or **Print & Fax**) from the Apple menu.

If the printer name is not displayed, add the printer.

["How to Select the Dedicated Printer Driver for This Printer" on page 57](#)

The printer is not communicating with the computer.

■ **Is the cable plugged in properly?**

Confirm that the interface cable is securely connected to both the printer port and the computer. Also, make sure the cable is not broken nor bent. If you have a spare cable, try connecting with the spare cable.

■ **Do the interface cable specifications match the specifications for the computer?**

Make sure the interface cable specifications match the specifications for the printer and the computer.

["System Requirements" on page 220](#)

Problem Solver

■ When using a USB hub, is it being used correctly?

In the USB specification, daisy-chains of up to five USB hubs are possible. However, we recommend that you connect the printer to the first hub connected directly to the computer. Depending on the hub you are using, the operation of the printer may become unstable. If this should occur, plug the USB cable directly into your computer's USB port.

■ Is the USB hub recognized correctly?

Make sure the USB hub is recognized correctly on the computer. If the computer correctly detects the USB hub, disconnect all USB hubs from the computer and connect the printer directly to the computer USB port. Ask the USB hub manufacturer about USB hub operation.

You cannot print under the network environment.

■ Are the network settings correct?

Ask your network administrator for the network settings.

■ Connect the printer directly to the computer using a USB cable, and then try to print.

If you are able to print via USB, there is a problem with network settings.

Ask your system administrator, or refer to the manual for your network system.

Printing from iPhone or iPad is not possible.

■ Check printer settings.

- Connect the iPhone or iPad to the same network (SSID) as the printer.
- In Web Config, enable AirPrint settings.
[🔗 "How to Use Web Config" on page 26](#)

The printer has an error.

■ View the message displayed on the control panel.

[🔗 "What to do When a Message is Displayed" on page 187](#)

The printer stops printing.

■ Is the status of print queue Pause? (Windows)

If you stop printing or the printer stops printing because of an error, the print queue enters a **Pause** status. You cannot print in this status.

Double-click the printer icon in the **Devices and Printers, Printers**, or **Printers and Faxes** folder; if printing is paused, open the **Printer** menu and clear the **Pause** check box.

■ Does the current printer status show Paused? (Mac)

Open the status dialog for your printer and check whether printing is paused.

(1) Select **System Preferences > Printers & Scanners** (or **Print & Fax**) > **Open Print Queue** from the **Apple** menu.

(2) Double-click the icon for any printer that is **Paused**.

(3) Click **Resume Printer**.

Problem Solver

Your problem is not listed here.

■ **Decide whether the trouble is caused by the printer driver or the application. (Windows)**

Perform a test print from the printer driver so that you can check that the connection between the printer and computer is correct and the printer driver settings are correct.

(1) Make sure that the printer is turned on and in ready status, and load A4 or larger paper.

(2) Open the **Devices and Printers, Printers, or Printers and Faxes** folder.

(3) Right-click the printer icon, and select **Properties**.

(4) In the Properties dialog, select the **General** tab and click **Print Test Page**.

After a while the printer starts to print a test page.

If the test page is printed correctly, the connection between the printer and computer is correct. Go to the next section.

If the test page is not printed correctly, check the items above again.

 ["You cannot print \(because the printer does not work\)" on page 189](#)

The "Driver Version" shown on the test page is the version number of the Windows internal driver. This differs from the Epson printer driver version that you installed.

The printer operates, but nothing prints

Cannot print from the printer driver

■ **Have you selected "Print Preview" in the Mac printer driver?**

Depending on the application you are using, you may not be able to print when "Print Preview" is enabled. Depending on the application you are using, an error message may be displayed when you start printing.

Disable "Print Preview" on the print settings screen.

Others

■ **Confirm the printer operation.**

Print a nozzle check pattern.

 ["Checking the print head for clogging and then cleaning" on page 180](#)

If you can print the nozzle check pattern, the printer is not malfunctioning. Check the following section.

■ **Is the message Motor self adjustment running, displayed on the control panel's screen?**

The printer adjusts the internal motor. Wait for a while without turning off the printer.

Problem Solver

The prints are not what you expected

If the following problems with print quality occur, then respond by following the process flow on this page.

Horizontal or vertical banding



Double ruled lines or warped characters

enthalten sind
 1. Ausdruck. W
 ↓ 5008 "Regel

Wrinkling, smearing, or uneven colors



Check the paper	<ul style="list-style-type: none"> <input type="checkbox"/> Check that the paper is compatible with the printer, and that there are no wrinkles, folds, or bending. <ul style="list-style-type: none"> “Epson Special Media” on page 206 “Supported Commercially Available Paper” on page 212 “Notes on Loading the Paper” on page 29 <input type="checkbox"/> Check that the paper type setting matches the loaded paper, and if not, change it. <ul style="list-style-type: none"> “Setting Loaded Paper” on page 42
------------------------	--



If print results do not improve

Perform Media Adjust	<p>Paper settings are optimized for the paper loaded.</p> <p>“Optimizing Paper Settings (Media Adjust)” on page 46</p>
-----------------------------	--



If print results do not improve

Check for clogging in the print head and perform cleaning	<p>Check for print head nozzle clogging, and if they are clogged, perform cleaning.</p> <p>“Checking the print head for clogging and then cleaning” on page 180</p>
--	---



If the clogged nozzles did not improve after cleaning three times in a row

Run Powerful Cleaning	<p>Run Powerful Cleaning.</p> <p>“Powerful Cleaning” on page 180</p>
------------------------------	---

See the following pages for other print quality problems and solutions.

Problem Solver

Ink drips



■ Are the print head nozzles clogged?

Perform print head cleaning. From the printer's menu, touch **Settings - Maintenance - Head Cleaning**.

Fine lines in drawings are not printed

■ Is a suitable resolution set?

Try the following measures.

- In your application software, set the resolution to 600 dpi.
- Confirm that the data paper size is correctly set in the printer driver document size, and remedy if different.
- If PDF, print directly from the source data for that PDF.
- In the printer driver, select **Emphasize Thin Lines**. **Emphasize Thin Lines** is displayed by clearing the Simple Settings check box in the Print Quality section on the Printer Settings screen.

Vertical color unevenness occurs when printing from the auto sheet feeder

■ Are the rollers for the auto sheet feeder dirty?

Dirt on the rollers can cause vertical color unevenness in the printouts. Try cleaning the rollers. When vertical color unevenness occurs on glossy paper, we recommend feeding and printing one sheet at a time from Cut Sheet(1 sheet) instead of using the auto sheet feeder.

[☞ "Smearing occurs when printing from the auto sheet feeder" on page 195](#)

[☞ "Loading Cut Sheet\(1 sheet\)" on page 40](#)

Differences in color/light/dark

If there are differences in color/light/dark, then handle these by following the process below.

[☞ "The prints are not what you expected" on page 192](#)

If these measures do not resolve the issue, check the following items.

■ Is the Color Density setting appropriate?

If you feel that lines in drawings are too light, then on the printer driver Advanced screen, click **Paper Configuration**, and increase the ink density.

Conversely, if the ink density is too high on tracing paper, either reduce the ink density or select **Tracing Paper <LowDuty>** in the Paper Type settings of the printer, and then print.

■ Are you using a genuine Epson ink cartridge?

This printer is developed for use with Epson ink cartridges. If you use non-Epson ink cartridges, printouts may be faint, or the color of the printed image may be changed because the remaining ink level is not correctly detected. Be sure to use the correct ink cartridge.

■ Are you using an old ink cartridge?

The print quality drops when an old ink cartridge is used. Replace the old ink cartridge with a new one. We recommend using all the ink in the cartridge before the expiry date printed on the package (within 6 months of installation in the printer).

■ Have you tried changing the print quality settings?

In the printer driver **Printer Settings- Print Quality**, select **Print with High Quality** and try printing. If this is not selected, this places priority on speed, however this can adversely impact print quality to some extent.

■ Is color management enabled?

Enable color management.

[☞ "Color Management Printing" on page 75](#)

Problem Solver

■ Have you compared the printing result with the image on the display monitor?

Since the monitor and the printer produce colors differently, printed colors will not always match on-screen colors perfectly.

■ Did you open the front cover while printing?

If the front cover is opened while printing, the print head stops suddenly, causing unevenness in color. Do not open the front cover while printing.

The color is not exactly the same as another printer.

■ Colors vary depending on the printer type due to each printer's characteristics.

Because inks, printer drivers, and printer profiles are developed for each printer model, the colors printed by different printer models are not exactly the same.

You can achieve similar colors with the same color adjustment method or the same gamma setting by using the printer driver.

 ["Correct color and print" on page 71](#)

The print is not positioned properly on the media.

■ Have you specified the print area?

Check the print area in the settings of the application and the printer.

■ Is the Original Size setting correct?

If the size of the loaded paper does not match the printer driver settings for **Original Size** or **Paper Size**, the print may not be in the correct position or some of the data may not be printed. In this case, check the print settings.

■ Is the paper skewed?

If **Off** is selected for **Detect Paper Meandering** in the Printer Settings menu, printing will continue even if the paper is skewed, resulting in printing outside of the print area. In the Printer Settings menu, set **Detect Paper Meandering** to **On**.

 ["General Settings - Printer Settings" on page 141](#)

■ Is the roll paper margin set wide?

If margins narrower than the margins set in the roll paper **Advanced Media Setting - Top/Bottom Margins** menu are set in the application software, then priority is given to the printer settings.

 ["Roll Paper menu" on page 132](#)

Vertical ruled lines are misaligned.

■ Has Media Adjust been carried out?

Confirm that the paper type settings match the paper, and perform Media Adjust.

 ["Setting Loaded Paper" on page 42](#)

 ["Optimizing Paper Settings \(Media Adjust\)" on page 46](#)

■ After performing Media Adjust, does the same problem occur?

On the printer driver's Printer Settings screen, clear **Simple Settings** in the Print Quality field. Select **Level - Max Quality**, clear **High Speed Printing**, and then try printing.

However, printing may take some time.

Bidirectional printing moves the print head left and right while printing, so if the print head is misaligned (with gaps), ruled lines may be printed as misaligned.

The printed surface is scuffed or soiled.

■ Is the paper too thick or too thin?

Check that the paper specifications are compatible with this printer.

 ["Epson Special Media Table" on page 209](#)

 ["Supported Commercially Available Paper" on page 212](#)

■ Is the paper wrinkled or creased?

Do not use old paper or paper with creases in it. Always use new paper.

Problem Solver

■ Is the paper wavy or curled?

Changes in temperature and humidity may cause paper to become wavy or curled, which can cause scuffing.

Check the following points.

- Load the paper just before printing.
 - Do not use wavy or curled paper.
For roll paper, cut off the wavy or curled parts and then load it again.
For cut sheets, use new paper.
-  ["Notes on Loading the Paper" on page 29](#)

■ Is the print head scuffing the printed surface?

Enable the Thick Paper function, and try printing.
From the Home screen, touch **Settings - Printer Settings - Thick Paper - On**.

If the problem does not improve even after enabling the Thick Paper function, register it as custom paper, and try changing the Platen Gap to the maximum setting.

Register the custom paper in **Settings - General Settings - Printer Settings - Custom Paper Setting**.

 ["General Settings - Printer Settings" on page 141](#)

Perform Platen Gap settings from the Roll paper information area - **Advanced Media Setting - Platen Gap** on the home screen.

 ["Roll Paper menu" on page 132](#)

■ Is the print head scuffing the edge of the paper?

If smearing or soiling occurs on the edge of the roll paper, touch the Roll paper information area - **Advanced Media Setting - Top/Bottom Margins** from the Home screen, change the edge setting to 45 mm, and try printing.

■ Is the print head scuffing the trailing edge of the paper?

Depending on the paper usage, storage conditions, and the content of the print data, the bottom edge may be scuffed when printing. In this situation it is best to create your data with a wider bottom margin.

Roll paper and cut sheets are smeared in similar ways

Follow the steps below to clean the roller by feeding plain paper.

1 Turn on the printer, and load it with the widest available roll paper.

 ["Loading Roll Paper" on page 30](#)

2 Touch **Paper Setting - Roll Paper - Feed/Cut Paper** from the Home screen.

3 Touch and hold the  (Forward) button until the paper is no longer marked.

Paper is fed while the  (Forward) button is touched. If the paper is not soiled, cleaning is complete.

4 Touch the  (Cut) button to cut the paper.

Smearing occurs when printing from the auto sheet feeder

When feeding from the auto sheet feeder for printing, the printed side may be smeared or color unevenness may occur. This is more likely to occur when using glossy paper.

When vertical smearing occurs on glossy paper, we recommend feeding and printing one sheet at a time from Cut Sheet(1 sheet) instead of using the auto sheet feeder.

 ["Loading Cut Sheet\(1 sheet\)" on page 40](#)

Follow the steps below to clean the roller for the auto sheet feeder by feeding plain paper.

1 Turn on the printer and load a few sheets of A3-size plain paper in the auto sheet feeder.

 ["Loading paper into the auto sheet feeder" on page 36](#)

2 From the Home screen, touch **Settings - Maintenance - Paper Guide Cleaning**.

3 Touch **Start**.
The paper is ejected.

4 Check if the ejected paper is smeared.

- If it is smeared: Touch **Run Again** if the paper is smeared.
- If it is not smeared: Touch **Done** to finish cleaning the roller.

Problem Solver

The paper is wrinkled.

■ Are you using the printer at normal room temperature?

Epson special media should be used at normal room temperature (temperature: 15 to 25°C, humidity: 40 to 60%). For information about paper such as thin paper from other manufacturers that requires special handling, see the documentation supplied with the paper.

■ Is there a gap between both edges of the roll paper and the flanges?

Confirm that the spindle flanges are right up against both edges of the roll paper, with no gaps. If there are any gaps, then the paper is fed at an angle, and this may result in wrinkling.

 ["Loading Roll Paper" on page 30](#)

■ Has Media Adjust been carried out?

Confirm that paper type settings that match the paper being used, and perform Media Adjust.

 ["Setting Loaded Paper" on page 42](#)

 ["Optimizing Paper Settings \(Media Adjust\)" on page 46](#)

■ Is the roll paper tension weak?

If wrinkles occur on the roll paper, increase the paper tension settings. In the Roll paper information area - **Advanced Media Setting - Back Tension**, select **High** or **Extra High**.

The reverse side of the printed paper is soiled.

■ Is ink dry on the printed surface?

Depending on the printing density and paper type, the ink may take a while to dry. Do not stack the paper until the printed surface is dry.

Additionally, setting the drying time on the printer in **Roll Paper - Advanced Media Setting - Drying Time - Drying Time per Page** to a longer time will stop post-print processing (ejection, cutting), waiting for the paper to dry naturally.

 ["Roll Paper menu" on page 132](#)

Blurred text, lines, and images

■ Is the Media Type setting correct?

Confirm that the paper type selected with the printer matches the paper being used, and that the printer driver Media Type settings are **Use Printer Settings**. The amount of ink to be fired is controlled according to the media type. If the settings do not match the paper loaded, too much ink may be fired.

 ["Setting Loaded Paper" on page 42](#)

■ Is the Color Density setting appropriate?

On the printer driver Advanced screen, click **Paper Configuration**, and decrease the ink density. The printer may be printing with too much ink for some paper. We recommend that black and color densities be decreased similarly.

■ Are you printing on tracing paper?

If too much ink is discharged, on the printer driver Advanced screen, click **Paper Configuration**, and decrease the ink density. Alternatively, changing **Paper Type to Tracing Paper <LowDuty>** may result in an improvement.

Feeding or ejecting problems

Unable to feed or eject paper.

■ Is the paper loaded in the correct position?

See the following for the correct paper loading positions.

 ["Loading Roll Paper" on page 30](#)

 ["Loading paper into the auto sheet feeder" on page 36](#)

 ["Loading Cut Sheet\(1 sheet\)" on page 40](#)

■ Is the paper loaded in the correct direction?

Load cut sheets vertically. If they are not loaded in the correct direction, the paper may not be recognized and an error may occur.

 ["Loading paper into the auto sheet feeder" on page 36](#)

 ["Loading Cut Sheet\(1 sheet\)" on page 40](#)

Problem Solver

■ Is the paper wrinkled or creased?

Do not use old paper or paper with creases in it. Always use new paper.

■ Is the paper damp?

Do not use paper that is damp. Also, Epson special media should be left in the bag until you intend to use it. If it is left out for a long time, the paper curls up and gets damp so that it does not feed properly.

■ Is the paper wavy or curled?

If changes in temperature and humidity cause paper to become wavy or curled, the printer may not be able to recognize the paper size correctly.

Check the following points.

- Load the paper just before printing.
- Do not use wavy or curled paper. For roll paper, cut off the wavy or curled parts and then load it again. For cut sheets, use new paper.

 ["Notes on Loading the Paper" on page 29](#)

■ Are the edges of the roll paper uneven?

Loading roll paper with the right and left edges uneven may cause paper feeding problems or paper meandering may occur during printing. Rewind the paper to make the edges even before using roll paper, or use roll paper that has no problems.

 ["Notes on Loading the Paper" on page 29](#)

■ Is the paper too thick or too thin?

Check that the paper specifications are compatible with this printer.

 ["Epson Special Media" on page 206](#)

 ["Supported Commercially Available Paper" on page 212](#)

■ Are you using the printer at normal room temperature?

Epson special media should be used at normal room temperature (temperature: 15 to 25°C, humidity: 40 to 60%). For information about paper from other manufacturers, see the documentation supplied with the paper.

■ Is paper jammed in the printer?

Open the front cover of the printer and check that there are no paper jams or foreign objects in the printer. If paper is jammed, see "Roll paper jam" or "Cut sheets jam" below, and clear the jammed paper.

Paper does not collect in the paper basket, or is creased or folded

■ Does the print job require a lot of ink, or is the humidity of the work environment high?

Depending on the job and the work environment, paper may not collect in the paper basket. Take the following measures as appropriate.

- Paper does not collect in the paper basket: Use your hands to lightly press the paper into the paper basket as it is ejected from the printer.
- The paper folds after it has been cut automatically: Select manual cutting and take the paper in both hands after it is cut.
- The paper wrinkles and does not collect well in the paper basket: Resume printing after closing the paper basket. Before the paper ejected from the printer touches the floor, take it in both hands close to the paper eject slot and continue to lightly support it until printing is complete.

Roll paper jam

To remove jammed paper, follow the steps below:

- 1 Open the cut sheets cover.

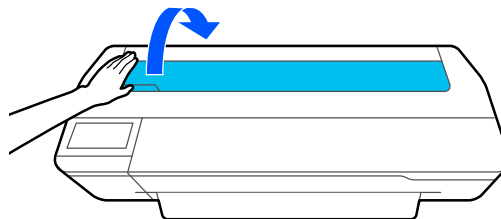

- 2 Unlock the center lock and open the roll paper cover.

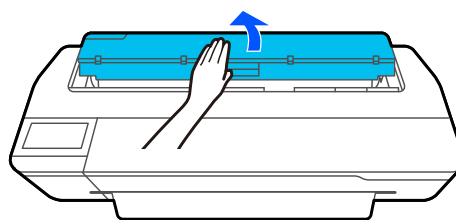

Problem Solver

- 3** Cut the top portion of any torn or wrinkled areas using a commercially available cutter.

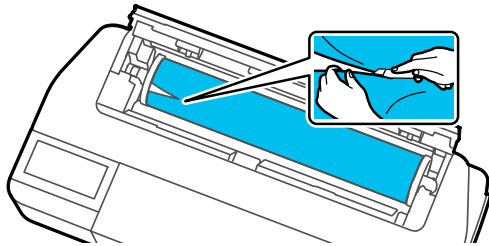

- 4** Close the roll paper cover and cut sheet cover.

- 5** When ejecting paper from the front, grasp the paper with both hands, and slowly pull it out towards you.

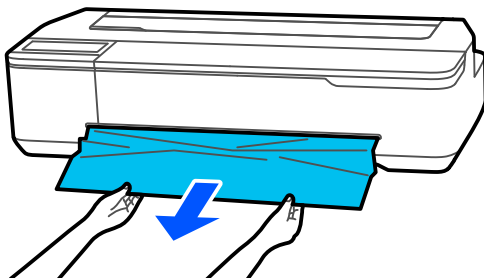

- 6** Open the front cover, remove the jammed paper, and then close the front cover.

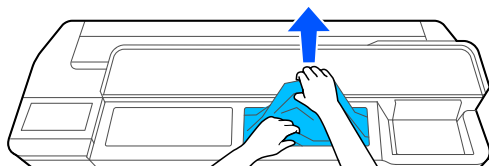

! Important:

Do not touch the print head. If you touch the print head with your hand, static electricity may cause a malfunction.

- 7** When the message **Then turn the power off and on again.** is displayed, turn off the printer and then turn it back on.

After removing the paper, reload the paper and restart printing.

[“Loading Roll Paper” on page 30](#)

! Important:

Before you reload the roll paper, cut the edge straight horizontally. Cut any wavy or wrinkled sections.

If there are any wrinkles on the edge, then paper may not be fed, or it may jam.

Cut sheets jam

To remove jammed paper, follow the steps below:

- 1** Open the front cover.

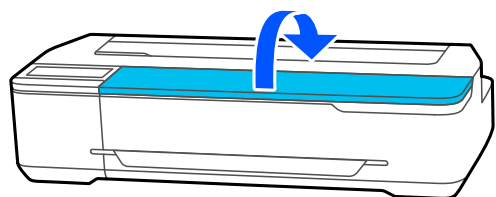

- 2** When ejecting paper from the front, grasp the paper with both hands, and slowly pull it out towards you.

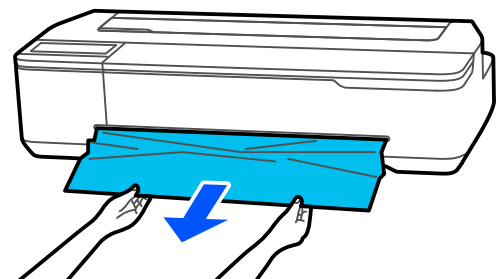

- 3** Remove the jammed paper, then close the front cover.

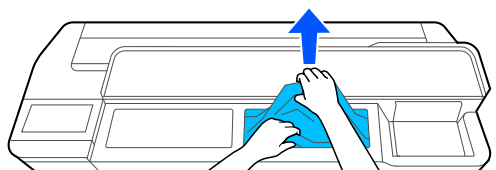

! Important:

Do not touch the print head. If you touch the print head with your hand, static electricity may cause a malfunction.

- 4** When the message **Then turn the power off and on again.** is displayed, turn off the printer and then turn it back on.

Problem Solver

After removing the paper, reload the paper and restart printing.

 [“Loading paper into the auto sheet feeder” on page 36](#)

 [“Loading Cut Sheet\(1 sheet\)” on page 40](#)

Original Is Jammed (SC-T5100M Series/SC-T3100M Series Only)

To remove a jammed original, follow the steps.

Caution:

When opening and closing the scanner cover, keep your hands away from the joint between the cover and the printer.

If your fingers or hands get caught, it could cause an injury.

- 1** Open the scanner cover.

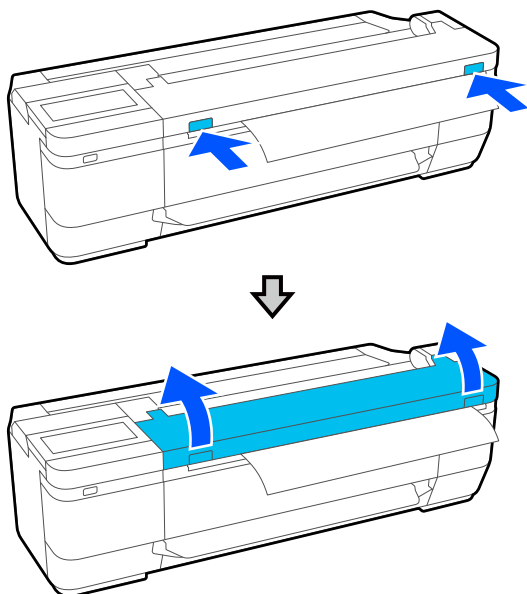

Important:

Do not lean against or place objects on the scanner cover.

- 2** Remove the jammed original.

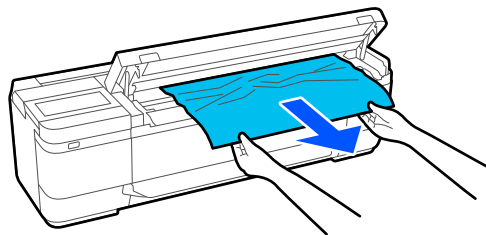

- 3** Close the scanner cover.

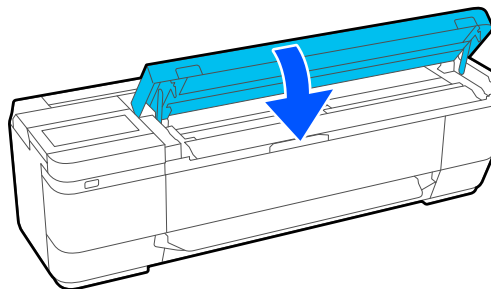

Others

The control panel display keeps turning off.

■ Is the printer in sleep mode?

Sleep mode is exited if a print job is received or the screen of the control panel is touched. The delay before entering sleep mode can be changed from the Basic Settings menu.

 [“General Settings - Basic Settings” on page 138](#)

Color ink runs out quickly even when printing in the Black&White mode or when printing black data.

- Color ink may be consumed even when printing in black and white mode, or when printing black data.

■ Color ink is also consumed during the print head cleaning process.

When performing **Head Cleaning** or **Powerful Cleaning**, ink of all colors will be consumed even if black and white mode is selected.

Problem Solver

The paper is not cut cleanly.

■ **Replace the cutter.**

If the paper is not cut cleanly, replace the cutter.

 ["Replacing the Cutter" on page 184](#)

A light is visible inside the printer.

■ **This is not a failure.**

The light is a light inside the printer.

The administrator password has been lost

- Should you forget the administrator password, contact your dealer or Epson Support.

Print head is automatically cleaned

- To ensure print quality, the printer may automatically perform head cleaning when the printer is turned on, or before starting printing.

The printer turned off due to a power cut

■ **Turn off the printer, and then turn it back on.**

When the printer is not turned off normally, the print head may not be capped correctly. If the print head is left uncapped for a long time, the print quality may decline.

When you turn on the printer, capping is performed automatically after a few minutes.

Copying or Scanning Problems (SC-T5100M Series/SC-T3100M Series Only)

Lines Appear on Scanned or Copied Documents

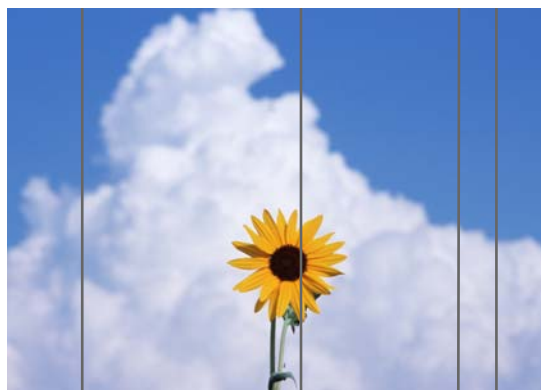

Follow the steps below to clean the inside of the scanner. Dust or dirt that is stuck to the scanner's glass surface or the white board may cause unwanted lines or marks on copy results and scanned images.

If the rollers or the scanner's glass surface is very dirty, use the optional cleaning kit. Add a small amount of cleaner to the cleaning cloth and wipe off the dirt.

 ["Options and Consumable Products" on page 206](#)

 **Caution:**

When opening and closing the scanner cover, keep your hands away from the joint between the cover and the printer.

If your fingers or hands get caught, it could cause an injury.

 **Important:**

Do not use volatile chemicals, such as alcohol or paint thinners. Deformation or discoloration could occur.

Do not apply liquids to or directly spray lubricant on the scanner. Otherwise the equipment and circuits may become damaged, so the printer may not operate correctly.

Problem Solver

1 Open the scanner cover.

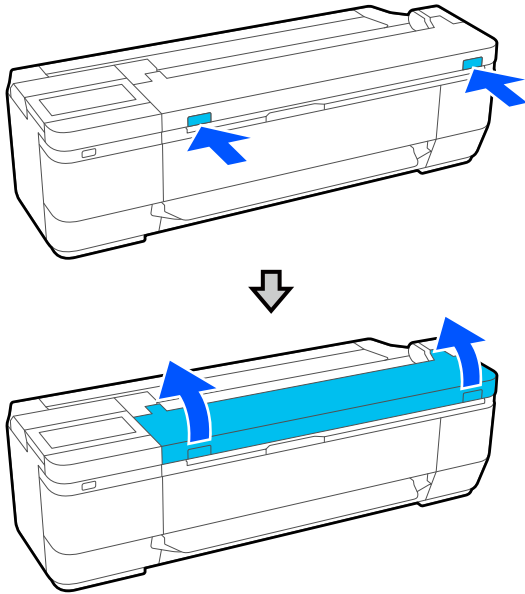

2 Using a soft cloth, wipe off any dust, dirt, or paper particles (resembles white powder).

Thoroughly wipe the area shown in blue in the illustration below.

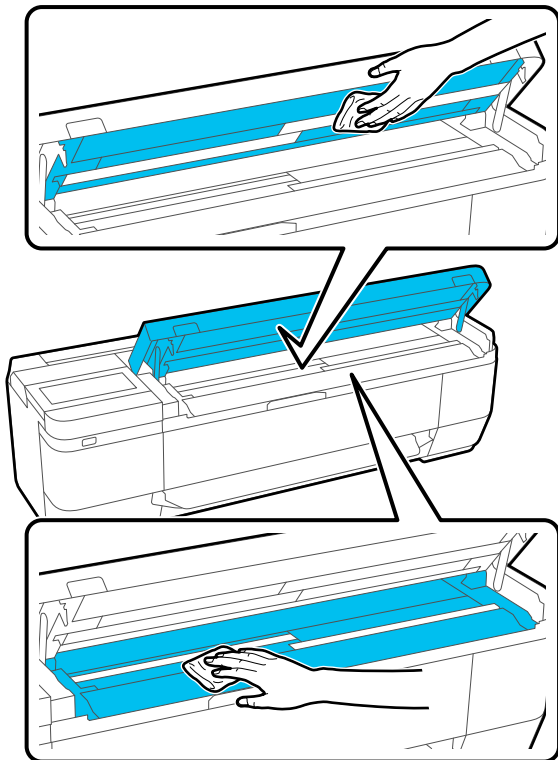

3 Use the cleaning kit, or the clean side of the soft cloth, to carefully wipe the white board (the area shown in blue in the illustration below).

The SC-T5100M Series has three white boards. Make sure you clean them all.

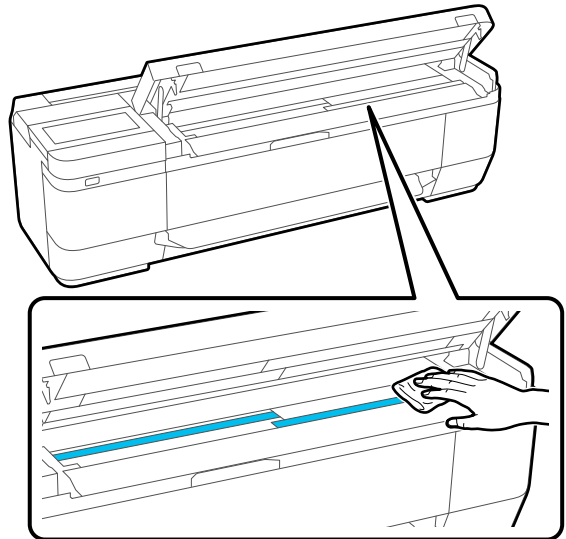

4 Use the cleaning kit, or the clean side of the soft cloth, to wipe the glass surface.

The SC-T5100M Series has three glass surfaces. Make sure you clean them all.

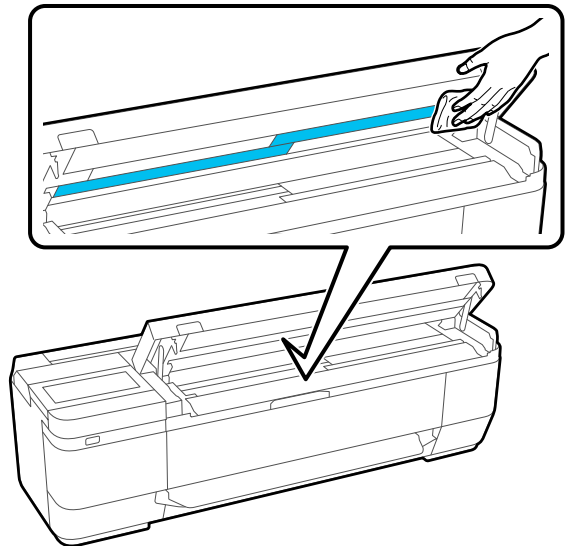

Problem Solver



Important:

- ❑ Do not apply excessive force to glass surfaces.
- ❑ Do not use brushes or hard objects. They may scratch the glass surface and affect the scan quality.
- ❑ Do not directly spray cleaner onto the glass surface.

5

After you have finished cleaning, close the scanner cover.



Important:

Close the scanner cover right after you have finished cleaning to prevent dust from getting inside.

Unable to Properly Feed Originals

If the right side of the original's loading position is incorrect, the original cannot be fed properly.

If you are not using the optional carrier sheet, you will need a document guide. Make sure the document guide is placed.

Remove the document guide when using the optional carrier sheet.

If you do not want to use the optional carrier sheet

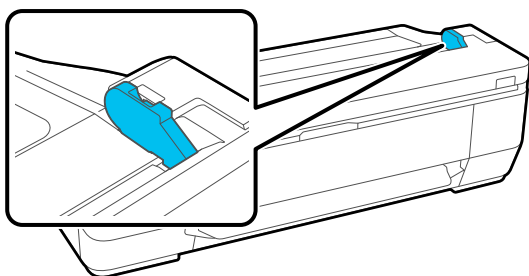

When the document guide has been placed, check the following items. If the original still cannot be fed properly, change **Original Size** or **Scan Size** to the standard size from **Auto Detect**.

■ **Is the original loaded with skew?**

Reload the original. If the original is loaded with skew, it cannot be fed properly.

■ **Is the original folded?**

Unfold the original.

If the original is folded while the printer is set to **Auto Detect** in **Original Size** or **Scan Size**, the width of the original may not be read correctly, which may cause the original to not feed properly.

■ **Clean inside of the scanner.**

If the printer is set to **Auto Detect** in **Original Size** or **Scan Size**, the width of the original may not be read correctly, which may cause the original to not feed properly.

How to Clean Inside the Scanner ↗ ["Lines Appear on Scanned or Copied Documents"](#) on page 200

■ **You may be using an original that cannot be placed.**

See the following for details on originals that cannot be placed.

↗ ["Documents That Cannot Be Loaded"](#) on page 103

If you are using the optional carrier sheet

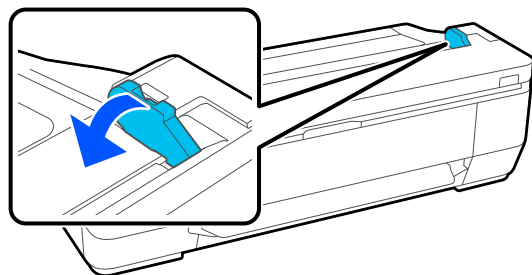

After removing the document guide, place the document.

■ **Is the original loaded with skew?**

Reload the original. If the original is loaded with skew, it cannot be fed properly.

Original Size or Scan Size are not recognized correctly

■ **Is Original Size or Scan Size set to Auto Detect?**

If **Original Size** or **Scan Size** is set to **Auto Detect**, the size of the original may not be detected correctly. Set **Original Size** or **Scan Size**.

Problem Solver

■ Clean inside of the scanner.

If there is dust or dirt stuck to the scanner's glass surface or the white board, the size of the original may not be detected correctly. See the item below and follow the same procedures for cleaning.

 ["Lines Appear on Scanned or Copied Documents" on page 200](#)

Copy Results are not Enlarged to the Width of the Roll Paper

■ Is the reduce/enlargement copy setting set to Auto Fit Page - On?

If **Auto Fit Page** is set to **On** in **Reduce/Enlarge** from the Copy menu, the scanner may not be able to detect the size of the original correctly, and the print result will not match the width of the roll paper. In **Advanced - Original Size**, specify the size of the original you loaded.

Scanned Image Is Misaligned

■ Change the direction that the original is loaded.

Changing the direction that the original is loaded may improve scan results.

■ Is the original curled?

If the original is curled, smooth out the original and place it flat. Then scan the original.

■ Try Image Stitching Adjustment.

Doing **Image Stitching Adjustment** may improve scan results.

 ["Image Stitching Adjustment" on page 204](#)

■ Try using the optional carrier sheet.

Putting the original into the carrier sheet smooths out any wrinkles and may improve scan results.

Scanned Image Is Blurred

■ Is Image Stitching Smoother set to On?

When **Image Stitching Smoother** is set to **On**, text and lines may be blurred at the points where the scans are joined.

If you are concerned about this issue, touch **Settings - Scan Settings - Scan Options - Image Stitching Smoother** from the Home screen, and set this to **Off**.

■ Try Image Stitching Adjustment.

If the stitching for the scanned images is not aligned, any text or lines on the stitching may be blurred or fuzzy.

 ["Image Stitching Adjustment" on page 204](#)

Problem Solver

Color of Original (Background Color) Remains in Scanned Image or Shadows of Wrinkles Appear in Scanned Image

■ Are you using the optional carrier sheet?

When scanning with a carrier sheet, the background color may remain in the scan results or wrinkles may appear.

If you are concerned about these issues, follow the steps below to try to make adjustments in **Remove Background**.

- ❑ When copying
Select **Copy - Basic Settings - Image Quality - Remove Background - Auto - Off** on the Home screen, and then set the adjustment value to a positive value from -4 to 4.
[☞ "Copy Menu \(SC-T5100M Series/SC-T3100M Series Only\)" on page 166](#)
- ❑ When scanning and saving to an email or folder
Select **Scan** on the Home screen, and then select **Email** or **Network Folder/FTP** depending on the target location.
Select **Scan Settings - Image Quality - Remove Background - Auto - Off**, and then set the adjustment value to a positive value from -4 to 4.
[☞ "Scan Menu \(SC-T5100M Series/SC-T3100M Series Only\)" on page 169](#)
- ❑ When saving scanned data to an external memory device
Select **Scan - Advanced - Image Quality - Remove Background - Auto - Off** on the Home screen, and then set the adjustment value to a positive value from -4 to 4.
[☞ "Scan Menu \(SC-T5100M Series/SC-T3100M Series Only\)" on page 169](#)

Document Feed Adjustment

If the print results and the length of the original of copied or scanned files do not match, use the following procedure to do Document Feed Adjustment. If you want to shorten the length of the print out, press the minus button. If you want to lengthen it, press the plus button. Differences in length may occur due to the type of paper used for printing.

- 1 Touch **Settings** on the Home screen.

- 2 Touch **General Settings - Scan Settings - Scan Options - Document Feed Adjustment**.

The adjustment value settings screen appears.
The adjustment values are shown in %.

- 3 Either touch - or + to show the intended adjustment values or touch the adjustment entry area to enter the adjustment values using the keypad screen.

Adjustment values are determined as shown below.

Example) When the length of the original is 50 cm and the print result is 50.1 cm:
 $50/50.1 \times 100 = -0.1996$, rounded at the second decimal.

Adjustment value: -0.2

- 4 Touch **OK**.

Image Stitching Adjustment

As for the original (**A**) shown in the figure below, if a misalignment occurs in the scanned image, such as in **B** , do Image Stitching Adjustment using the following procedure.

If the original has wrinkles or is an uneven thicknesses, the parts where the images join together may be misaligned even after performing **Image Stitching Adjustment**.

The arrow in **B** indicates the feed direction of the original.

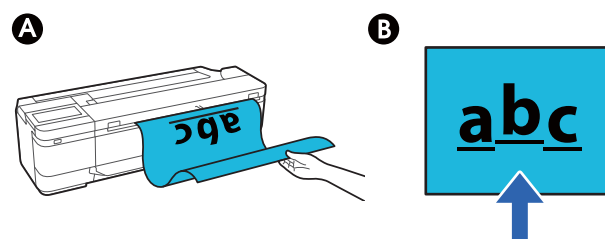

- 1 Touch **Settings** on the Home screen.

- 2 Touch **General Settings - Scan Settings - Scan Options - Image Stitching Adjustment**.

The adjustment value settings screen appears.

Problem Solver

3 Either touch - or + to show the intended adjustment values or touch the adjustment entry area to enter the adjustment values using the keypad screen.

Shifting the adjustment value by 1 will correct the misalignment by about 0.1 mm in the actual size.

When the Scan Results Are Shifted Up in Relation to the Feed Direction of the Original

Set the adjustment value toward the plus sign.

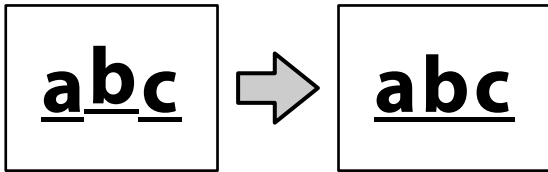

When the Scan Results Are Shifted Down in Relation to the Feed Direction of the Original

Set the adjustment value toward the minus sign.

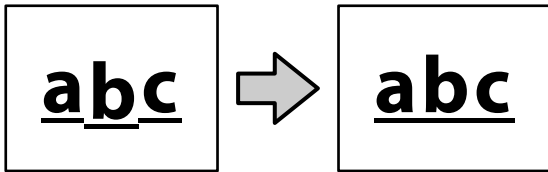

4 Touch OK.

Appendix

Appendix

Options and Consumable Products

The following options and consumable products are available for use with your printer. (As of July, 2019)

For the latest information, see the Epson Web site.

Epson Special Media

 [“Epson Special Media Table” on page 209](#)

Ink Cartridges

Epson recommends the use of genuine Epson ink cartridges. Epson cannot guarantee the quality or reliability of non-genuine ink. The use of non-genuine ink may cause damage that is not covered by Epson's warranties, and under certain circumstances, may cause erratic printer behavior.



Information about non-genuine ink levels may not be displayed, and use of non-genuine ink is recorded for possible use in service support.

Printer model	Ink color	Product Number		
		80 ml	50 ml	26 ml
SC-T5100M	Black	T40D1	T40C1	-
SC-T3100M	Cyan	-	T40D2	T40C2
SC-T5100	Magenta	-	T40D3	T40C3
SC-T3100	Yellow	-	T40D4	T40C4
SC-T5100N				
SC-T3100N				
SC-T2100				
SC-T5130M	Black	T40B1	T40A1	-
SC-T3130M	Cyan	-	T40B2	T40A2
SC-T5130	Magenta	-	T40B3	T40A3
SC-T3130	Yellow	-	T40B4	T40A4
SC-T3130N				
SC-T5160M	Black	T40U1	T40S1	-
SC-T3160M	Cyan	-	T40U2	T40S2
SC-T5160	Magenta	-	T40U3	T40S3
SC-T3160	Yellow	-	T40U4	T40S4
SC-T5160N				
SC-T3160N				

Appendix

Printer model	Ink color	Product Number		
		80 ml	50 ml	26 ml
SC-T5180M	Black	T40H1	T40G1	-
SC-T3180M	Cyan	-	T40H2	T40G2
SC-T5180	Magenta	-	T40H3	T40G3
SC-T5180N	Yellow	-	T40H4	T40G4

Others

Product	Part number	Explanation
Maintenance Box	S210057	Replacement Maintenance Box for when there is insufficient empty space in the Maintenance Box.  "Replacing Maintenance Box" on page 183
Auto Cutter Spare Blade (except for the SC-T5180M/SC-T3180M/ SC-T5180/SC-T5180N/SC-T3180N)	S210055	 "Replacing the Cutter" on page 184
Auto Cutter Spare Blade (for the SC-T5180M/SC-T3180M/SC-T5180/ SC-T5180N/SC-T3180N)	S210056	
Stand (36") (except for the SC-T5180N)	C12C933091	Dedicated stand with a paper basket for models without a stand. Select the width in accordance with a model you are using.
Stand (36") (for the SC-T5180N)	C12C933101	
Stand (24") (except for the SC-T3180M/SC-T3180N)	C12C933151	
Stand (24") (for SC-T3180M/SC-T3180N)	C12C933161	
Roll Feed Spindle (36") (except for the SC-T5180M/SC-T5180/ SC-T5180N)	C12C933131	This is the same as the roll paper spindle supplied with the printer. Select the width in accordance with a model you are using.
Roll Feed Spindle (36") (for the SC-T5180M/SC-T5180/SC-T5180N)	C12C933141	
Roll Feed Spindle (24") (except for the SC-T3180M/SC-T3180N)	C12C933701	
Roll Feed Spindle (24") (for SC-T3180M/SC-T3180N)	C12C933221	
Stacker (for the SC-T2100 Series only)	C12C936361	 "Installing and removing the paper stacker (for plain paper)" on page 36

Appendix

Product	Part number	Explanation
Document Carrier Sheet (A1+/628x935 mm) (for the SC-T3100M Series)	C12C936101/C12C936121	Used when loading thin originals and originals that you do not want to damage when copying or scanning.
Document Carrier Sheet (A0+/932 x 1,300 mm) (for the SC-T5100M Series)	C12C936461/C12C936471	✎ "When loading documents that are thin, that are easily torn, or that you do not want to damage" on page 104
Cleaning Kit	B12B819291	Use this to clean the inside of the scanner. ✎ "Lines Appear on Scanned or Copied Documents" on page 200

Appendix

Supported Media

We recommend you use the following Epson special media for high-quality printing results. Refer to the following for supported commercially available paper.

 [“Supported Commercially Available Paper” on page 212](#)

Epson Special Media Table

Epson paper supported by this printer is described below. (As of April, 2018).

Not all paper types and sizes are available in all countries or regions.

Note:

The paper names in the following table are displayed by the paper type settings in the menu of the printer driver or the printer. Some parts of paper names may be omitted.

Example: "Premium Glossy Photo Paper (170)" may be abbreviated to "Premium Glossy 170".

Roll Paper

Paper Name	Size
Singleweight Matte Paper	420 mm/A2 432 mm/17 in. 515 mm/B2 594 mm/A1 610 mm/24 in. 728 mm/B1* 914 mm/36 in.*
Doubleweight Matte Paper	594 mm/A1 610 mm/24 in. 728 mm/B1* 914 mm/36 in.*
Premium Glossy Photo Paper (170)	420 mm/A2 594 mm/A1 610 mm/24 in. 728 mm/B1* 914 mm/36 in.*
Premium Semigloss Photo Paper (170)	420 mm/A2 594 mm/A1 610 mm/24 in. 728 mm/B1* 914 mm/36 in.*

Appendix

Paper Name	Size
Enhanced Adhesive Synthetic Paper	610 mm/24 in. 914 mm/36 in.*
Enhanced Low Adhesive Synthetic Paper	610 mm/24 in. 914 mm/36 in.*

* Available only with the SC-T5100M Series/SC-T5100 Series/SC-T5100N Series.

Cut Sheet

Paper Name	Size*	Auto Sheet Feeder	
		Availability	Loadable Number of Sheets
Photo Quality Inkjet Paper	A4 Letter Legal A3	✓	5
	A3+ SuperB A2 US-C	-	-
Archival Matte Paper	A4 Letter A3	✓	5
	A3+ SuperB A2 US C	-	-
Photo paper Glossy	A4 Letter A3	✓	5
	A3+ SuperB US-B	-	-

Appendix

Paper Name	Size*	Auto Sheet Feeder	
		Availability	Loadable Number of Sheets
Premium Glossy Photo Paper	A4 Letter 11 x 14 in. A3	✓	5
	A3+ SuperB A2 US-C	-	-
Premium Semigloss Photo Paper	A4 Letter A3	✓	5
	A3+ SuperB A2 US-C	-	-
Premium Luster Photo Paper	A4 Letter A3	✓	5
	A2 US-C	-	-

Appendix

Supported Commercially Available Paper

This printer supports the following paper specifications for non-Epson media.

 **Important:**

- Do not use paper that is wrinkled, scuffed, torn, or dirty.
- Commercially available paper corresponding to the paper types in the table can be loaded in and fed through the printer as long as they meet the following specifications, however Epson cannot guarantee the print quality.
- Commercially available paper types not in the table can be loaded in the printer as long as they meet the following specifications, however Epson cannot guarantee the feed and print quality.

Roll Paper

Paper type	Plain paper, coated paper, photo paper, tracing paper, matte film, blueprint paper*
Roll core size	2 inches
Roll paper outer diameter	119 mm or less
Paper width	SC-T5100M Series/SC-T5100 Series/SC-T5100N Series: 297 to 914 mm (36 inches) SC-T3100M Series/SC-T3100 Series/SC-T3100N Series/SC-T2100 Series: 297 to 610 mm (24 inches)
Paper thickness	0.05 to 0.21 mm
Roll weight	SC-T5100M Series/SC-T5100 Series/SC-T5100N Series: 5.9 kg or less SC-T3100M Series/SC-T3100 Series/SC-T3100N Series/SC-T2100 Series: 4.2 kg or less

Cut sheets (Auto sheet feeder)

Media Type	Plain paper, coated paper, photo paper, blueprint paper*
Paper Size	A4 to A3
Paper thickness	0.12 to 0.27 mm

You can load up to 50 sheets of plain paper in the auto sheet feeder, or up to 5 sheets of other paper types.

However, depending on the thickness of the paper, feeding may fail even if you load less than the number of sheets mentioned above. In this situation, try loading fewer sheets of paper.

Cut Sheet (1 sheet)

Paper type	Plain paper, coated paper, photo paper, tracing paper, matte film, blueprint paper*
------------	---

Appendix

Paper width	SC-T5100M Series/SC-T5100 Series/SC-T5100N Series: 210 to 914 mm (36 inches) SC-T3100M Series/SC-T3100 Series/SC-T3100N Series/SC-T2100 Series: 210 to 610 mm (24 inches)
Length	279.4 mm (Letter) to 1,189 mm
Paper thickness	0.12 to 0.27 mm

*When blueprint paper is selected, the print data is converted to blue and then printed. You can perform blue printing (printing blue lines on a blue background).

For blue paper, use light blue, high quality paper (approximately 60 to 80 g/m²).

Appendix

Before Printing on Commercially Available Paper

When using commercially available paper, select the paper type setting that matches to the paper from the following settings.



- Plain Paper
- Coated Paper(Generic)
- Photo Paper(Generic)
- Tracing Paper
- Tracing Paper <LowDuty>
- Matte Film
- Blueprint Paper

Perform **Media Adjust** if there is banding, wrinkling, smearing, or uneven colors in the printing results.

 [“Optimizing Paper Settings \(Media Adjust\)” on page 46](#)

When using Commercially Available Synthetic, Canvas or Film-type Paper

Before printing, carry out one of the following.

- Add as a new paper type setting (register as custom paper), and carry out media adjust.
From the Home screen, touch **Settings - General Settings - Printer Settings - Custom Paper Setting**, and register a custom paper. After registering the paper, perform Media Adjust. Paper adjustment results will be saved as the newly added paper type settings.
Refer to the following menu for details on custom paper settings.
 [“General Settings - Printer Settings” on page 141](#)
- Select the paper type from the following Epson Special Media settings, and perform Media Adjust.
Enhanced Adhesive Syn., Enhanced Low Adh. Syn., Heavyweight Polyester, Glossy Film2
By performing the Media Adjust, paper settings for Epson Special Media will be overwritten by the settings for the paper you use.
 [“Optimizing Paper Settings \(Media Adjust\)” on page 46](#)

Note:

Test the print quality with this printer before purchasing a large amount of paper.

Appendix

Printable area

This section describes the printable areas for the printer.

If the print range settings in application software are larger than the following printer printable areas, sections beyond the specified margins are not printed.

Roll Paper

The gray area in the illustration below shows the printable area.

The arrow in the illustration indicates the direction that the paper is ejected.

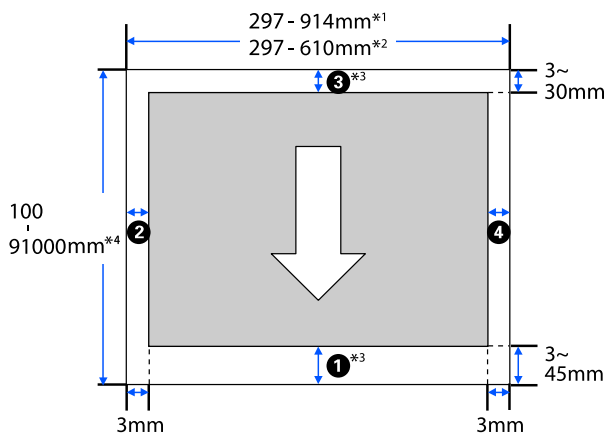

- *1 SC-T5100M Series/SC-T5100 Series/SC-T5100N Series
- *2 SC-T3100M Series/SC-T3100 Series/SC-T3100N Series/ SC-T2100 Series
- *3 In the printer driver **Layout** screen, selecting **Print Banner** sets the top and bottom margins of the paper to 0 mm.
- *4 However, the actual print size depends on the application, the paper size loaded in the printer, the printer driver settings, and the computer environment.

Margins for roll paper depend on the settings values for **Top/Bottom Margins** in the menu, as shown in the table below.

Settings for **Top/Bottom Margins**  "Roll Paper menu" on page 132

The default setting is **Standard**.

Settings of Top/Bottom Margins	Margin Values
Standard	①, ③ = 30 mm*
	②, ④ = 3 mm
Top 3 mm/Bottom 3 mm	①, ③ = 3 mm
	②, ④ = 3 mm
Top 15 mm/Bottom 15 mm	①, ③ = 15 mm
	②, ④ = 3 mm
Top 45 mm/Bottom 15 mm	① = 45 mm
	③ = 15 mm
	②, ④ = 3 mm
3 mm	①, ②, ③, ④ = 3 mm
5 mm	①, ②, ③, ④ = 5 mm

- * If **Standard** is selected when the following two conditions are met, then the top and bottom margins will be 3 mm.
 - The paper type settings are one of the following Singleweight Matte, Coated Paper(Generic), Plain Paper, Plain Paper Thin, Plain Paper Thick, Tracing Paper, Tracing Paper <LowDuty>, Matte Film, Blueprint Paper
 - The printer driver print targets are one of the following CAD/Line Drawing - Black, CAD/Line Drawing - Color, CAD/Line Drawing - Bi-Level

Appendix

Important:

- ❑ Printing is distorted when the trailing edge of the roll paper comes off the core. Make sure the trailing edge does not come inside the printing area.
- ❑ If the print range settings width **A** is smaller than the print data width **B**, then the sections beyond the printable width **C** will not be printed.

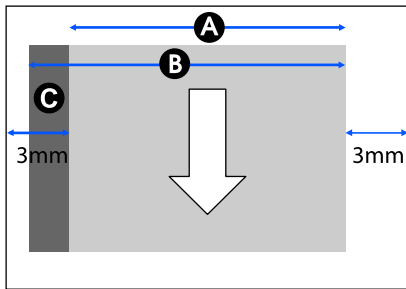

Cut sheets (Auto sheet feeder)

The gray area in the illustration below shows the printable area. The arrow in the illustration indicates the direction that the paper is ejected.

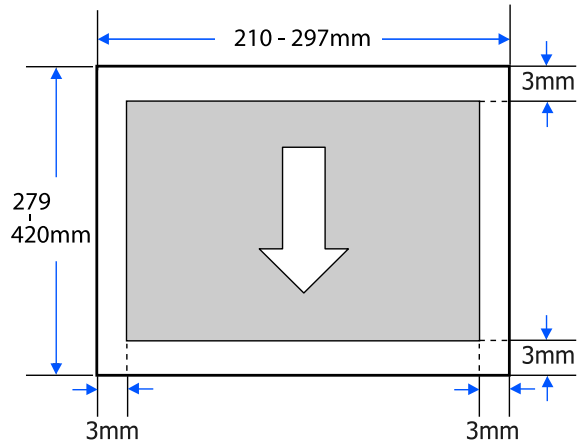

Cut Sheet (1 sheet)

The gray area in the illustration below shows the printable area. The arrow in the illustration indicates the direction that the paper is ejected.

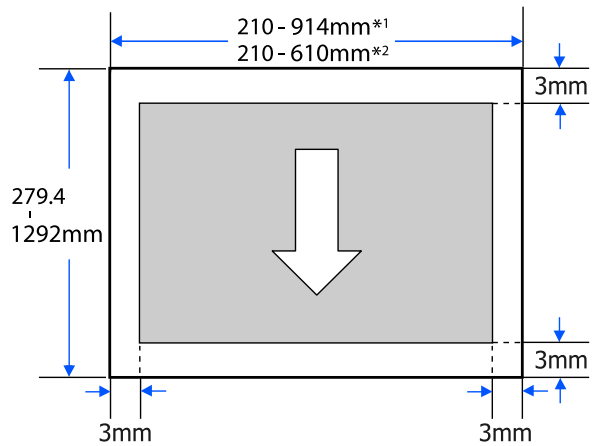

*1 SC-T5100M Series/SC-T5100 Series/SC-T5100N Series

*2 SC-T3100M Series/SC-T3100 Series/SC-T3100N Series/SC-T2100 Series

Appendix

Moving or Transporting the Printer

This section describes methods for moving and transporting the product.

Caution:

- ❑ The printer is heavy, so ensure more than one person is used for these actions. Make sure the product is carried by two people or more when packing or moving it.
- ❑ When you lift the printer, maintain a natural posture.
- ❑ When you lift the printer, place your hands at the specified locations on the left and right as indicated in the following illustration. If you lift the printer while holding other sections, you may be injured. For example, you may drop the printer or your fingers may be pinched when lowering the printer.

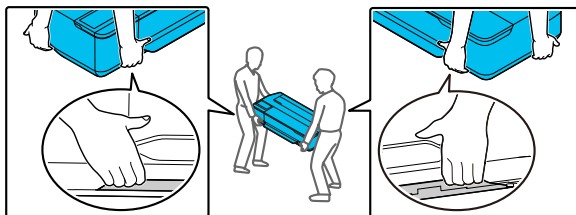

- ❑ Do not tilt the product more than 10 degrees forward, back, left, or right while moving it. Failure to observe this precaution could result in the printer falling over, causing accidents.

Important:

The print head may fail if the environmental temperature becomes -10°C or lower.

Eject the ink prior to turning off the power if you expect to be moving or transporting the printer in an environment of -10°C or below.

See the following procedure for detailed instructions.

 [“Handling if Transporting/Leaving the Printer in an Environment of \$-10^{\circ}\text{C}\$ or Less” on page 218](#)

Moving to a Different Location in the Same Building

Preparations for Moving

This explains preparations for moving the printer a short distance, for example within the same building. See the following section for information on moving the printer between floors or to another building.

 [“When Transporting” on page 218](#)

For models with stands, moving the printer on casters is possible providing there are no steps or unevenness in the floor along the route, however pay attention to the following points.

Caution:

For models with stands, ensure that you abide by the following points in order to prevent damage from falling over.

- ❑ Do not move the printer with casters locked
- ❑ Avoid areas with steps or unevenness
- ❑ After moving, ensure the casters are locked before use

Important:

Ensure you move and transport the printer with the ink cartridges installed. Do not remove the ink cartridges; otherwise, the nozzles may be clogged and make it impossible to print, or ink may leak.

- 1 Remove all paper from the printer. Make sure you remove the Paper Stacker if it is installed.
- 2 Close all covers on the printer. For models with stands, close the paper basket.
- 3 Turn off the printer, and unplug all cables, including the power cord and LAN cables, etc.
- 4 For models with stands, release the locks on the casters.

Appendix

Operations after Moving

This explains operations to prepare for use after moving the printer.

- 1 Connect the power cable, and turn the printer on.
- 2 Check for print head nozzle clogging, and if these are clogged, carry out print head cleaning.
 -  [“Checking the print head for clogging and then cleaning” on page 180](#)

When Transporting

Before transporting the printer, contact your dealer or Epson Support.

 [“Where To Get Help” on page 226](#)

Handling if Transporting/ Leaving the Printer in an Environment of -10°C or Less

The print head may fail if the environmental temperature becomes -10°C or lower. Discharge the ink following the procedures below if you expect the printer to encounter environments of -10°C or below.

Caution:

When opening and closing the scanner cover, keep your hands away from the joint between the cover and the printer.

If your fingers or hands get caught, it could cause an injury.

Important:

This procedure discharges ink into the Maintenance Box, therefore the Maintenance Box requires adequate remaining capacity. If the remaining capacity box is low, first prepare a new replacement Maintenance Box.

- 1 If paper is loaded, remove all paper.
 -  [“Removing Roll Paper” on page 34](#)

 [“Removing Cut Sheet \(1 Sheet\)” on page 41](#)

- 2 From the Home screen, touch **Settings - Maintenance - Discharging/Charging Ink**.
- 3 Touch **Start**.
Move the ink cartridge to the replacement position.
- 4 Open the front cover.
For the SC-T5100M Series/SC-T3100M Series, open the scanner unit.

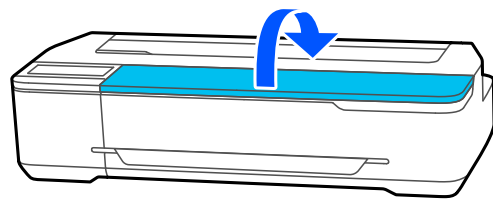

- 5 Open the cartridge cover, and remove all ink cartridges.

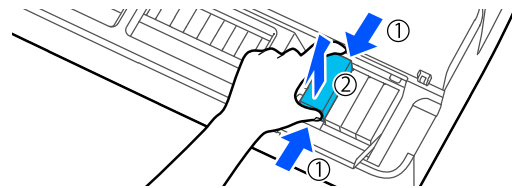

After ink discharge, reinstall the ink cartridges. Place the removed ink cartridges nearby with the ink supply port down, or laid horizontally.

- 6 Close the cartridge cover and front cover.
Close the front cover to start ink discharge.

Important:

Do not open the cover or turn the printer off during ink discharge.

- 7 If **Open the front cover and insert all the ink cartridges.** is displayed, open the front cover and cartridge cover again.
- 8 Set all ink cartridges removed in Step 5.

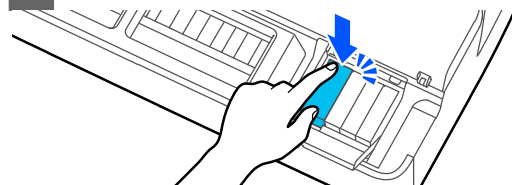

Appendix

9

Close the cartridge cover and front cover.
For the SC-T5100M Series/SC-T3100M Series,
close the cartridge cover and the scanner unit.

Closing the front cover automatically turns off
the power to the printer.

After this, refer to the following for preparations
for movement/transport.

 [“Moving to a Different Location in the Same Building” on page 217](#)

 [“When Transporting” on page 218](#)

 **Important:**

*When a **You will need a new xxx ink cartridge to start using the printer again.** message is displayed, prepare an ink cartridge of the color shown with XXX by the time the printer is next used.*

The next time the power is turned on, if the amount of ink required in order to perform ink charging (filling with ink until the print head nozzle section, readying the device for printing) is not available, then the printer will not be usable until the ink cartridge is replaced.

Appendix

System Requirements

Software for this printer can be used in the following environments. (As of November, 2020)

Supported OS and other elements may change.

For the latest information, see the Epson Web site.

Printer Driver

Windows

Operating system	Windows 10 / Windows 10 x64 Windows 8.1 / Windows 8.1 x64 Windows 8 / Windows 8 x64 Windows 7 / Windows 7 x64 Windows Vista / Windows Vista x64 Windows XP SP3 or later / Windows XP x64 SP2 or later Windows Server 2019 Windows Server 2016 Windows Server 2012 R2 Windows Server 2012 Windows Server 2008 R2 Windows Server 2008 Windows Server 2003 R2 Windows Server 2003 SP2 or later
CPU	Intel Core2 Duo 3.05 GHz or more
Available memory space	1 GB or more
Hard disk (Available volume to install)	32 GB or more
Display resolution	WXGA (1280×800) or better
Connection method with the printer*	USB, Ethernet, or Wi-Fi

* For details on the connection methods (interface specifications), see the following.

 ["Specifications Table" on page 222](#)

Mac

Operating system	Mac OS X v10.6.8 or later
CPU	Intel Core2 Duo 3.05 GHz or more
Available memory space	4 GB or more
Hard disk (Available volume to install)	32 GB or more
Display resolution	WXGA+ (1440×900) or better

Appendix

Connection method with the printer*	USB, Ethernet, or Wi-Fi
-------------------------------------	-------------------------

* For details on the connection methods (interface specifications), see the following.

 ["Specifications Table" on page 222](#)

Web Config

Windows

Browser	Internet Explorer 11, Microsoft Edge, Firefox* ¹ , Chrome* ¹
Connection method with the printer* ²	Ethernet or Wi-Fi

*¹ Use the latest version.

*² See the following for details on the network interfaces.

 ["Specifications Table" on page 222](#)

Mac

Browser	Safari* ¹ , Firefox* ¹ , Chrome* ¹
Connection method with the printer* ²	Ethernet or Wi-Fi

*¹ Use the latest version.

*² See the following for details on the network interfaces.

 ["Specifications Table" on page 222](#)

Appendix

Specifications Table

In the following table, model names are represented as shown below.

- (A): SC-T5100M Series
- (B): SC-T3100M Series
- (C): SC-T5100 Series
- (D): SC-T3100 Series
- (E): SC-T5100N Series
- (F): SC-T3100N Series/SC-T2100 Series

Printer Specifications	
Printing method	On-demand inkjet method
Nozzle configuration	800 nozzles x 4 colors (Black, Cyan, Magenta, Yellow)
Resolution (maximum)	2400 x 1200 dpi
Control code	ESC/P2, ESC/P raster (undisclosed command), HP-GL/2, HP RTL, PJI
Built-in memory	(A) and (B): 1.0 GB + 8.0 GB (for processing scanner data) Except for (A) and (B): 1.0 GB
Rated voltage	AC100-240 V
Rated frequency	50/60 Hz
Rated current	1.4 A
Power consumption	
Operating	(A): Approx. 26 W (B): Approx. 24 W Except for (A) and (B): Approx. 28 W
Ready mode	(A): Approx. 12 W (B): Approx. 11 W Except for (A) and (B): Approx. 8 W
Sleep mode	(A) and (B): Approx. 2.0 W Except for (A) and (B): Approx. 1.6 W
Power off	Approx. 0.2 W
Temperature	

Printer Specifications	
Operating	10 to 35°C
In storage (Before unpacking)	-20 to 60 °C (Within 120 hours at 60 °C, within a month at 40 °C)
In storage (After unpacking)	Ink charged: -10 to 40 °C (Within a month at 40 °C) Ink discharged*1: -20 to 25 °C (Within a month at 25 °C)
Humidity	
Operating	20 to 80% (40 to 60% is recommended. without condensation)
In storage	5 to 85% (without condensation)
Temperature and humidity operating range (the range shown by diagonal lines is recommended)	
Dimensions (Width x Depth x Height)	
Maximum*2	(A): 1268 x 982 x 1017 mm (B): 970 x 948 x 334 mm (C): 1268 x 982 x 913 mm (D): 970 x 982 x 913 mm (E): 1268 x 811 x 230 mm (F): 970 x 811 x 230 mm
Storage	(A): 1268 x 696 x 975 mm (B): 970 x 505 x 292 mm (C): 1268 x 696 x 913 mm (D): 970 x 696 x 913 mm (E): 1268 x 505 x 230 mm (F): 970 x 505 x 230 mm

Appendix

Printer Specifications	
Weight*3	(A): Approx. 55 kg (B): Approx. 34 kg (C): Approx. 46 kg (D): Approx. 38 kg (E): Approx. 33 kg (F): Approx. 27 kg

- *1 Use the **Discharging/Charging Ink** menu in the Maintenance menu to discharge ink from the printer.
User's Guide(online manual)
- *2 With the paper stacker attached and the paper basket open. With document support attached for the SC-T5100M Series/ SC-T3100M Series.
- *3 Not including the ink cartridges and the paper stacker

 **Important:**
Use the printer at an altitude of 2000 m or less.

Printer's Scanner Specifications*1		
Scanner type	Color Simplex Sheet-fed Scanner	
Sensor	CIS	
Number of effective pixels (main scanning direction)	SC-T5100M Series: 21600 pixels (600 dpi) SC-T3100M Series: 14400 pixels (600 dpi)	
Document size	Maximum	SC-T5100M Series: 914.4 mm x 2720 mm*2 SC-T3100M Series: 609.6 mm x 2720 mm*2
	Minimum	148.0 mm x 148.0 mm
Document thickness	0.06 mm to 0.50 mm	
Direction of feed	Printable side loaded facing up	
Direction of ejection	Scanned side ejected facing down	
Number of sheets that can be loaded	1 sheet	
Scan resolution	600 dpi (main scanning) 600 dpi (sub-scanning)	
Output resolution	200, 300, 400, 600 dpi	

Printer's Scanner Specifications*1	
Tone	Color
	<input type="checkbox"/> 30-bit input (10 bits per pixel per color internal)
	<input type="checkbox"/> 24-bit output (8 bits per pixel per color internal)
	Grayscale
	<input type="checkbox"/> 10-bit input
	<input type="checkbox"/> 8-bit output
	Black and white
	<input type="checkbox"/> 10-bit input
	<input type="checkbox"/> 1-bit output
Light source	RGB 3 color LED

- *1 SC-T5100M Series/SC-T3100M Series only
- *2 Maximum length for Scan (600dpi) and Copy (Fine, Super Fine) only: 2672mm

Interface Specifications	
USB port for a computer	SuperSpeed USB
Option port (for enlarged copy connections except for the SC-T5100M Series/ SC-T3100M Series)	Hi-Speed USB
USB Memory Port (SC-T5100M Series/SC-T3100M Series only)	
USB Flash Drive*1	Hi-Speed USB
File system	FAT, FAT32, exFAT
File format	JPEG, TIFF, PDF *2
Ethernet*3 Standards	IEEE802.3i (10BASE-T) IEEE802.3u (100BASE-TX) IEEE802.3ab (1000BASE-T) IEEE802.3az (Energy Efficient Ethernet)*4
Wi-Fi	

Appendix

Interface Specifications	
Standards	IEEE802.11b/g/n*5
Frequency Range	2.4 GHz
Coordination Modes	Infrastructure Wi-Fi Direct (Simple AP)*6
Wireless Securities*7	WEP (64/128bit) WPA-PSK (TKIP) WPA2-PSK (AES)*8 WPA3-SAE (AES) WPA2/WPA3-Enterprise
Network Printing Protocols/Functions*9	EpsonNet Print (Windows) Standard TCP/IP (Windows) WSD Printing (Windows) Bonjour (Mac) IPP Printing (Mac) AirPrint (iOS, Mac) Printing from FTP client
Security Standards/Protocols	SSL/TLS (HTTPS Server/Client, IPPS) IEEE802.1X IPsec/IP Filtering SMTPS (STARTTLS, SSL/TLS) SNMPv3 SMB3.1.1 FTPS (Explicit mode)*10

- *1 USB Flash Drive with security settings cannot be used.
- *2 SC-T5100M Series/SC-T3100M Series only. Only data created using the scan function provided by Epson inkjet printers is supported. However, the following files are not supported.
 - Data created in applications such as EPSON Scan and Epson Scan2.
 - Data that contains multiple pages with different orientations or sizes.
- *3 Use a category 5 or higher STP (shielded twisted pair) cable. However, for IEEE802.3ab (1000BASE-T), use a category 5e or higher STP (shielded twisted pair) cable.
- *4 The connected device should comply with IEEE802.3az standards.
- *5 IEEE802.11n is only available for the HT20.
- *6 Not supported for IEEE 802.11b.
- *7 Only SC-T5100M Series/SC-T3100M Series support WPA3-SAE(AES) and WPA3-Enterprise.
- *8 Complies with WPA2 standards with support for WPA/WPA2 Personal.
- *9 EpsonNet Print supports IPv4 only. The others support both IPv4 and IPv6.
- *10 SC-T5100M Series/SC-T3100M Series scanning function only.



Warning:

To prevent radio interference to the licensed service, this device is intended to be operated indoors and away from windows to provide maximum shielding. Equipment (or its transmit antenna) that is installed outdoors is subject to licensing.

For European users

Radio Equipment Information:

This product intentionally emit radio wave described as follows.

- (a) frequency band in which the radio equipment operates; 2.4 to 2.4835 GHz
- (b) maximum radio-frequency power transmitted in the frequency band in which the radio equipment operates; 20 dBm (eirp power)

ZICTA Type Approval for Users in Zambia

See the following website to check the information for ZICTA Type Approval.

<https://support.epson.net/zicta/>

Ink Specifications	
Type	Dedicated ink cartridges
Pigment ink	Black, Cyan, Magenta, Yellow
Use by date	See the expiration date printed on the ink cartridge package or on the cartridge (store at normal temperature)
Print quality guarantee expiry	Six months (after unpacking)
Storage temperature	
Uninstalled	-20 to 40°C (Within four days at -20 °C, within a month at 40 °C)
Installed	-20 to 40°C (Within four days at -20 °C, within a month at 40 °C)
Transporting	-20 to 60°C (Within four days at -20 °C, within a month at 40 °C, within 72 hours at 60 °C)
Cartridge Dimensions (Width x Depth x Height)	

Appendix

Ink Specifications	
80 ml	41.0×97.0×49.5* mm
50 ml / 26 ml	27.0×97.0×49.5* mm

* Not including the protruding portions

 **Important:**

- The ink freezes if left at below -13 °C for a long time. If it does freeze, leave it at room temperature (25 °C) for at least three hours.*
- Do not refill the ink cartridges.*

Where To Get Help

Where To Get Help

Technical Support Web Site

Epson's Technical Support Web Site provides help with problems that cannot be solved using the troubleshooting information in your product documentation. If you have a Web browser and can connect to the Internet, access the site at:

<https://support.epson.net/>

If you need the latest drivers, FAQs, manuals, or other downloadables, access the site at:

<https://www.epson.com>

Then, select the support section of your local Epson Web site.

Contacting Epson Support

Before Contacting Epson

If your Epson product is not operating properly and you cannot solve the problem using the troubleshooting information in your product documentation, contact Epson support services for assistance. If Epson support for your area is not listed below, contact the dealer where you purchased your product.

Epson support will be able to help you much more quickly if you give them the following information:

- Product serial number
(The serial number label is usually on the back of the product.)
- Product model
- Product software version
(Click **About**, **Version Info**, or similar button in the product software.)
- Brand and model of your computer
- Your computer operating system name and version
- Names and versions of the software applications you normally use with your product

Where To Get Help

Help for Users in North America

Epson provides the technical support services listed below.

Internet Support

Visit Epson's support website at <https://epson.com/support> and select your product for solutions to common problems. You can download drivers and documentation, get FAQs and troubleshooting advice, or e-mail Epson with your questions.

Speak to a Support Representative

Dial: (562) 276-1300 (U.S.), or (905) 709-9475 (Canada), 6 am to 6 pm, Pacific Time, Monday through Friday. Days and hours of support are subject to change without notice. Toll or long distance charges may apply.

Before you call Epson for support, please have the following information ready:

- Product name
- Product serial number
- Proof of purchase (such as a store receipt) and date of purchase
- Computer configuration
- Description of the problem

Note:

For help using any other software on your system, see the documentation for that software for technical support information.

Purchase Supplies and Accessories

You can purchase genuine Epson ink cartridges, ribbon cartridges, paper, and accessories from an Epson authorized reseller. To find the nearest reseller, call 800-GO-EPSON (800-463-7766). Or you can purchase online at <http://www.epsonstore.com> (U.S. sales) or <http://www.epson.ca> (Canadian sales).

Help for Users in Europe

Check your **Pan-European Warranty Document** for information on how to contact Epson support.

Help for Users in Taiwan

Contacts for information, support, and services are:

World Wide Web (<https://www.epson.com.tw>)

Information on product specifications, drivers for download, and products enquiry are available.

Epson HelpDesk (Phone: +0800212873)

Our HelpDesk team can help you with the following over the phone:

- Sales inquiries and product information
- Product usage questions or problems
- Inquiries on repair service and warranty

Repair service center:

Telephone number	Fax number	Address
02-23416969	02-23417070	No.20, Beiping E. Rd., Zhongzheng Dist., Taipei City 100, Taiwan
02-27491234	02-27495955	1F., No.16, Sec. 5, Nanjing E. Rd., Songshan Dist., Taipei City 105, Taiwan
02-32340688	02-32340699	No.1, Ln. 359, Sec. 2, Zhongshan Rd., Zhonghe City, Taipei County 235, Taiwan
039-605007	039-600969	No.342-1, Guangrong Rd., Luodong Township, Yilan County 265, Taiwan
038-312966	038-312977	No.87, Guolian 2nd Rd., Hualien City, Hualien County 970, Taiwan
03-4393119	03-4396589	5F., No.2, Nandong Rd., Pingzhen City, Taoyuan County 32455, Taiwan (R.O.C.)

Where To Get Help

Telephone number	Fax number	Address
03-5325077	03-5320092	1F., No.9, Ln. 379, Sec. 1, Jingguo Rd., North Dist., Hsinchu City 300, Taiwan
04-23011502	04-23011503	3F., No.30, Dahe Rd., West Dist., Taichung City 40341, Taiwan (R.O.C.)
04-23805000	04-23806000	No.530, Sec. 4, Henan Rd., Nantun Dist., Taichung City 408, Taiwan
05-2784222	05-2784555	No.463, Zhongxiao Rd., East Dist., Chiayi City 600, Taiwan
06-2221666	06-2112555	No.141, Gongyuan N. Rd., North Dist., Tainan City 704, Taiwan
07-5520918	07-5540926	1F., No.337, Minghua Rd., Gushan Dist., Kaohsiung City 804, Taiwan
07-3222445	07-3218085	No.51, Shandong St., Sanmin Dist., Kaohsiung City 807, Taiwan
08-7344771	08-7344802	1F., No.113, Shengli Rd., Pingtung City, Pingtung County 900, Taiwan

Help for Users in Australia/New Zealand

Epson Australia/New Zealand wishes to provide you with a high level of customer service. In addition to your product documentation, we provide the following sources for obtaining information:

Your Dealer

Don't forget that your dealer can often help identify and resolve problems. The dealer should always be the first call for advise on problems; they can often solve problems quickly and easily as well as give advise on the next step to take.

Internet URL

Australia

<https://www.epson.com.au>

New Zealand

<https://www.epson.co.nz>

Access the Epson Australia/New Zealand World Wide Web pages.

The site provides a download area for drivers, Epson contact points, new product information and technical support (e-mail).

Epson Helpdesk

Epson Helpdesk is provided as a final backup to make sure our clients have access to advice. Operators on the Helpdesk can aid you in installing, configuring and operating your Epson product. Our Pre-sales Helpdesk staff can provide literature on new Epson products and advise where the nearest dealer or service agent is located. Many types of queries are answered here.

The Helpdesk numbers are:

Australia	Phone:	1300 361 054
	Fax:	(02) 8899 3789
New Zealand	Phone:	0800 237 766

We encourage you to have all the relevant information on hand when you ring. The more information you prepare, the faster we can help solve the problem. This information includes your Epson product documentation, type of computer, operating system, application programs, and any information you feel is required.

Help for Users in Singapore

Sources of information, support, and services available from Epson Singapore are:

World Wide Web

<https://www.epson.com.sg>

Information on product specifications, drivers for download, Frequently Asked Questions (FAQ), Sales Enquiries, and Technical Support via e-mail are available.

Where To Get Help

Epson HelpDesk

Toll Free: 800-120-5564

Our HelpDesk team can help you with the following over the phone:

- Sales enquiries and product information
- Product usage questions or problems
- Enquiries on repair service and warranty

Help for Users in Thailand

Contacts for information, support, and services are:

World Wide Web

<https://www.epson.co.th>

Information on product specifications, drivers for download, Frequently Asked Questions (FAQ), and e-mail are available.

Epson Hotline

(Phone: (66)2685-9899)

Our Hotline team can help you with the following over the phone:

- Sales inquiries and product information
- Product usage questions or problems
- Inquiries on repair service and warranty

Help for Users in Vietnam

Contacts for information, support, and services are:

Epson Hotline (Phone): +84 28 3925 5545

Service Center: 68 Nam Ky Khoi Nghia Street, Nguyen Thai Binh Ward, District 1, Ho Chi Minh City Vietnam

Help for Users in Indonesia

Contacts for information, support, and services are:

World Wide Web

<https://www.epson.co.id>

- Information on product specifications, drivers for download
- Frequently Asked Questions (FAQ), Sales Enquiries, questions through e-mail

Epson Hotline

- Sales inquiries and product information
- Technical support
 - Phone (62) 21-572 4350
 - Fax (62) 21-572 4357

Epson Service Center

Jakarta Mangga Dua Mall 3rd floor No 3A/B
Jl. Arteri Mangga Dua,
Jakarta

Phone/Fax: (62) 21-62301104

Bandung Lippo Center 8th floor
Jl. Gatot Subroto No.2
Bandung

Phone/Fax: (62) 22-7303766

Surabaya Hitech Mall It IIB No. 12
Jl. Kusuma Bangsa 116 – 118
Surabaya

Phone: (62) 31-5355035
Fax: (62)31-5477837

Yogyakarta Hotel Natour Garuda
Jl. Malioboro No. 60
Yogyakarta

Phone: (62) 274-565478

Where To Get Help

Medan	Wisma HSBC 4th floor Jl. Diponegoro No. 11 Medan
	Phone/Fax: (62) 61-4516173
Makassar	MTC Karebosi Lt. Ill Kav. P7-8 Jl. Ahmad Yani No.49 Makassar
	Phone: (62)411-350147/411-350148

Help for Users in Hong Kong

To obtain technical support as well as other after-sales services, users are welcome to contact Epson Hong Kong Limited.

Internet Home Page

Epson Hong Kong has established a local home page in both Chinese and English on the Internet to provide users with the following information:

- Product information
- Answers to Frequently Asked Questions (FAQs)
- Latest versions of Epson product drivers

Users can access our World Wide Web home page at:

<https://www.epson.com.hk>

Technical Support Hotline

You can also contact our technical staff at the following telephone and fax numbers:

Phone: (852) 2827-8911

Fax: (852) 2827-4383

Help for Users in Malaysia

Contacts for information, support, and services are:

World Wide Web

(<https://www.epson.com.my>)

- Information on product specifications, drivers for download
- Frequently Asked Questions (FAQ), Sales Enquiries, questions through e-mail

Epson Trading (M) Sdn. Bhd.

Head Office.

Phone: 603-56288288

Fax: 603-56288388/399

Epson Helpdesk

- Sales enquiries and product information (Infoline)
Phone: 603-56288222
- Enquiries on repair services & warranty, product usage and technical support (Techline)
Phone: 603-56288333

Help for Users in India

Contacts for information, support, and services are:

World Wide Web

(<https://www.epson.co.in>)

Information on product specifications, drivers for download, and products enquiry are available.

Helpline

For Service, Product info or to order a cartridge - 18004250011 (9AM - 6PM) - This is a Toll-free number.

For Service (CDMA & Mobile Users) - 3900 1600 (9AM - 6PM) Prefix local STD code

Where To Get Help

Help for Users in the Philippines

To obtain technical support as well as other after sales services, users are welcome to contact the Epson Philippines Corporation at the telephone and fax numbers and e-mail address below:

Trunk Line: (63-2) 706 2609

Fax: (63-2) 706 2665

Helpdesk (63-2) 706 2625

Direct Line:

E-mail: epchelpdesk@epc.epson.com.ph

World Wide Web

(<https://www.epson.com.ph>)

Information on product specifications, drivers for download, Frequently Asked Questions (FAQ), and E-mail Inquiries are available.

Toll-Free No. 1800-1069-EPSON(37766)

Our Hotline team can help you with the following over the phone:

- Sales inquiries and product information
- Product usage questions or problems
- Inquiries on repair service and warranty