



POWER STEEL™ RECTANGULAR POOLS OWNER'S MANUAL

www.bestwaycorp.com

Visit Bestway YouTube channel 





WARNING

smooth out the bottom

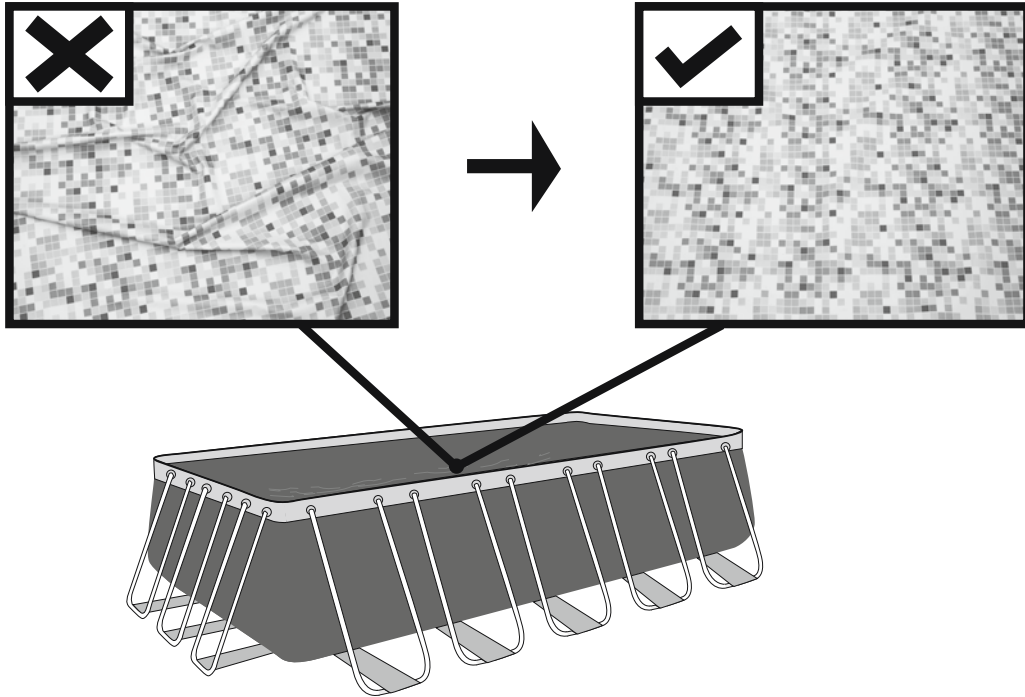

Put 1" to 2" water in the pool to cover the floor. Once pool floor is slightly covered, gently smooth out all wrinkles. Start in the center of the pool and work your way clockwise to the outside.

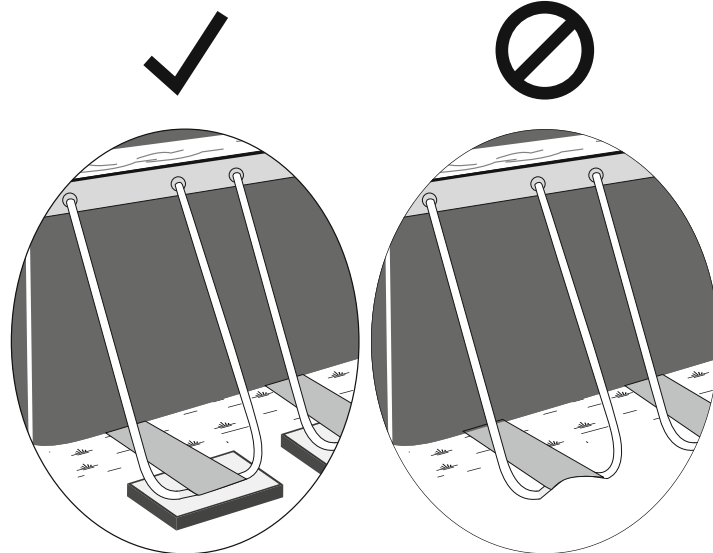

Do not assemble on soft lawn. If you must assemble the pool on a soft surface, timber boards must be placed under the feet of the vertical supports to spread the load.

WARNING

Carefully read, understand, and follow all information in this user manual before installing and using the swimming pool. These warnings, instructions, and safety guidelines address some common risks of water recreation, but they cannot cover all risks and dangers in all cases. Always use caution, common sense, and good judgment when enjoying any water activity. Retain this information for future use.

Non Swimmers safety

- Continuous, active, and vigilant supervision of weak swimmers and non-swimmers by a competent adult is required at all times (remembering that children under five are at the highest risk of drowning).
- Designate a competent adult to supervise the pool each time it is being used.
- Weak swimmers or non-swimmers should wear personal protection equipment when using the pool.
- When the pool is not in use, or unsupervised, remove all toys from the swimming pool and its surrounding to avoid attracting children to the pool.

Safety devices

- In order to prevent children from drowning, it is recommended to secure the access to the pool with a protection device. In order to prevent children climbing from the inlet and outlet valve, it is recommended to install a barrier (and secure all doors and windows, where applicable) to prevent unauthorized access to the swimming pool.
- Barriers, pool covers, pool alarms, or similar safety devices are helpful aids, but they are not substitutes for continuous and competent adult supervision.

Safety equipment

- It is recommended to keep rescue equipment (e.g. a ring buoy) by the pool.
- Keep a working phone and a list of emergency phone numbers near the pool.

Safe use of the pool

- Encourage all users especially children to learn how to swim
- Learn Basic Life Support (Cardiopulmonary Resuscitation - CPR) and refresh this knowledge regularly. This can make a life-saving difference in the event of an emergency.
- Instruct all pool users, including children, what to do in case of an emergency.
- Never dive into any shallow body of water. This can lead to serious injury or death.
- Do not use the swimming pool when using alcohol or medication that may impair your ability to safely use the pool.
- When pool covers are used, remove them completely from the water surface before entering the pool.
- Protect pool occupants from water related illnesses by keeping the pool water treated and practicing good hygiene. Consult the water treatment guidelines in the user's manual.
- Store chemicals (e.g. water treatment, cleaning or disinfection products) out of the reach of children.
- Use the signage as outlined below. Signage is to be displayed in a prominent position within 2m of the pool.



Keep children under supervision in the aquatic environment. No diving.

Removable ladders shall be placed on a horizontal surface.

- Irrespective of materials used for swimming pool construction, accessible surfaces have to be checked regularly to avoid injuries.
- Regularly monitor bolts and screws. Remove splinters or any sharp edges to avoid injuries.
- **ATTENTION:** Do not leave the drained pool outside. The empty pool is liable to become deformed and/or displaced due to wind.

- If you have a filter pump, refer to the pump's manual for instructions.

WARNING! The pump cannot be used while people are inside the pool!

- If you have a ladder, refer to the ladder's manual for instructions.

- **WARNING!** The use of a swimming pool implies compliance with the safety instructions described in the operating and maintenance guide. In order to prevent drowning or other serious injuries, pay particular attention to the possibility of unexpected access to the swimming pool by children under 5 years by securing the access to it, and, during the bathing period, keep them under constant adult supervision.

Installation usually takes approximately 20-30 minutes with 2-3 people excluding earthworks and filling.

See below for part descriptions.

Components list:

NOTE: Some parts already have been installed on the pool.

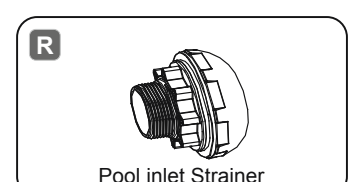
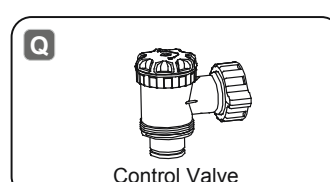
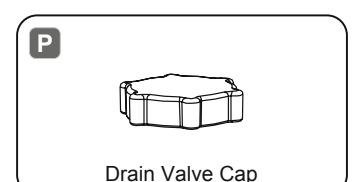
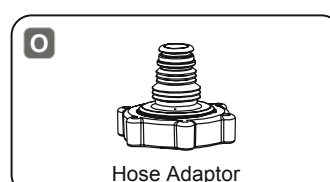
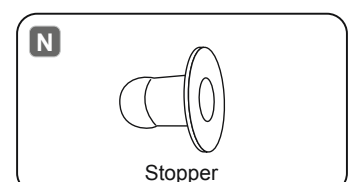
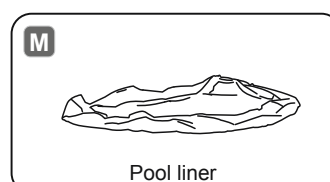
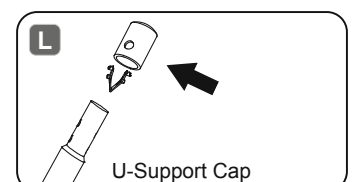
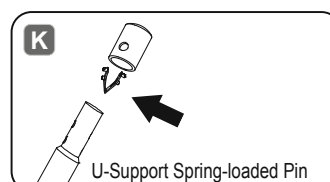
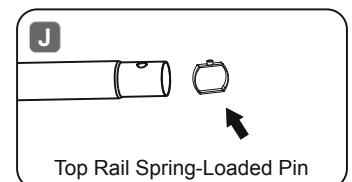
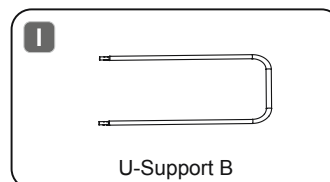
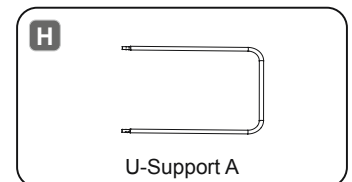
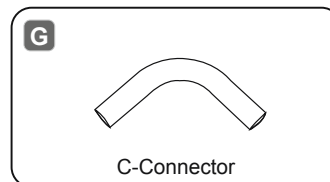
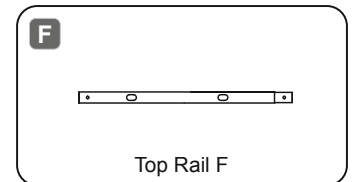
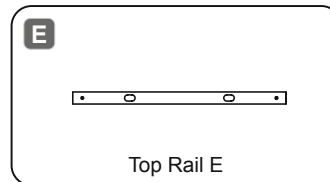
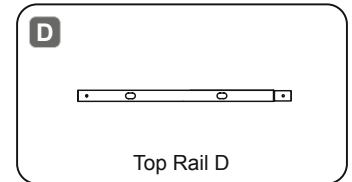
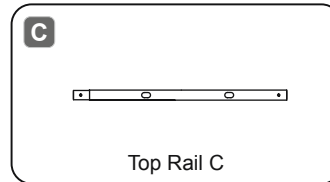
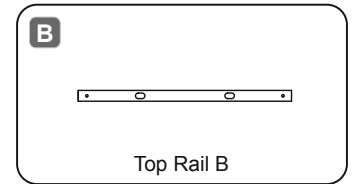
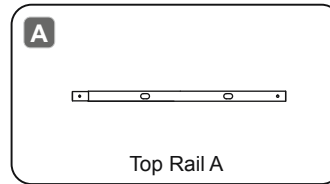

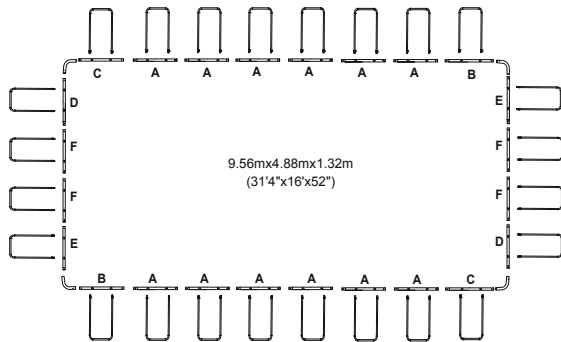
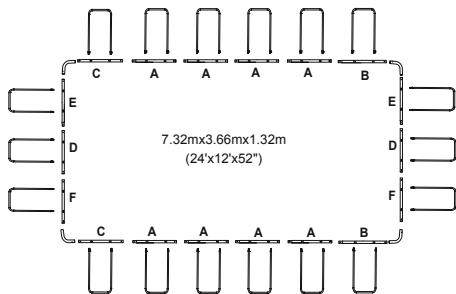
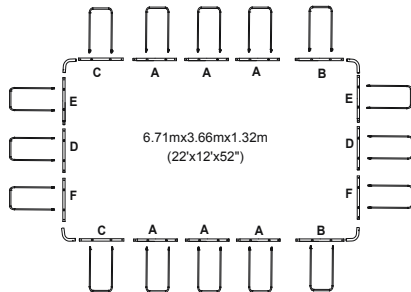
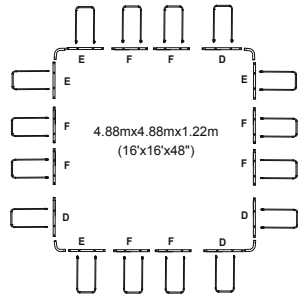
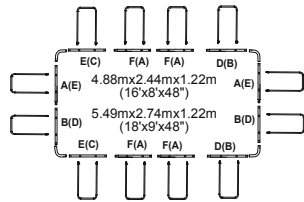
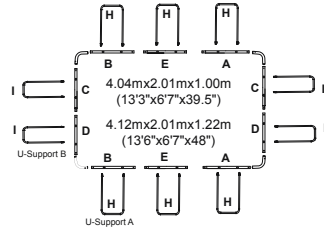
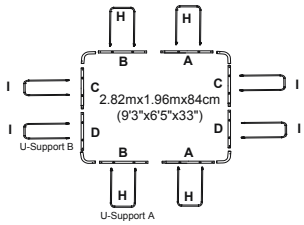

PLEASE READ CAREFULLY AND RETAIN FOR FUTURE REFERENCE.

CHOOSE THE CORRECT LOCATION

NOTE: The pool must be set up on a completely flat and level surface. Please do not install the pool if the surface is inclined or sloped.

Correct conditions to set up the pool:

- The selected location has to be capable of uniformly supporting the weight for the entire time the pool is installed, moreover the location must be flat and must be cleared of all objects and debris including stones and twigs.
- We recommend positioning the pool away from any objects children could use to climb into the pool.
- **NOTE:** Position the pool near an adequate drainage system to deal with overflow or to discharge the pool.

Incorrect conditions to set up the pool:

- On uneven ground the pool may collapse causing serious personal injury and/or damage to personal property and will void the warranty and prevent any service claims.
- Sand should not be used to create a level base; the ground must be dug out if necessary.
- Directly under overhead power lines or trees. Be sure the location does not contain underground utility pipes, lines or cables of any kind.
- Do not set up the pool on driveways, decks, platforms, gravel or asphalt surfaces. The selected location should be firm enough to withstand the pressure of the water; Mud, sand, soft / loose soil or tar are not suitable.
- Grass or other vegetation under the pool will die and may cause odors and slime to develop, therefore we recommend removing all grass from the selected pool location.

• Avoid areas prone to aggressive plant and weed species that may grow through the ground cloth or liner.

NOTE: Check with your local city council for by-laws relating to fencing, barriers, lighting and safety requirements and ensure you comply with all laws.

NOTE: If have a filter pump, refer to the pump's manual for instructions.

NOTE: The ladder must match the pool size and should be used only for entering and exiting the pool. It is forbidden to exceed the permitted payload of the ladder. Check regularly if the ladder is properly assembled.

Installation

Assembly of the Rectangular Frame Pool can be completed without tools.

Bestway Inflatables will not be responsible for damage caused to the pool due to mishandling or failure to follow these instructions.

1. Lay out all parts and check that you have the correct quantities as listed in the components list. If you are missing any part do not assemble the pool, contact Bestway Customers Service.
2. Spread out the pool and make sure the pool is right side up, let it sit exposed to direct sunlight for 1 hour or more so that the pool is more flexible during set up.
3. Place the pool near an adequate drainage system to deal with overflow water and ensure the pool's inlet A and outlet B are correctly positioned to allow your filter pump to connect to a power source. **NOTE:** Do not use extension power cords to power your pump. **ATTENTION:** Do not drag the pool on the ground, this can damage the pool.

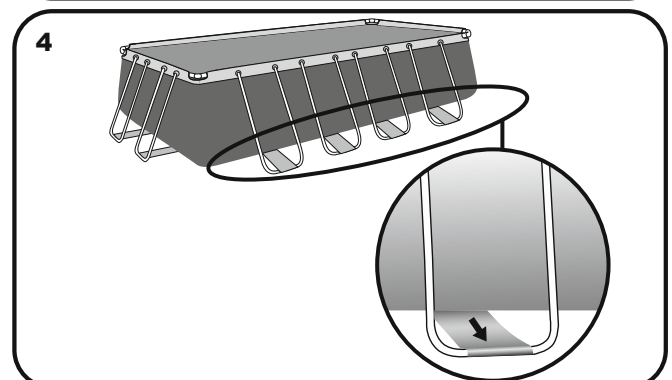
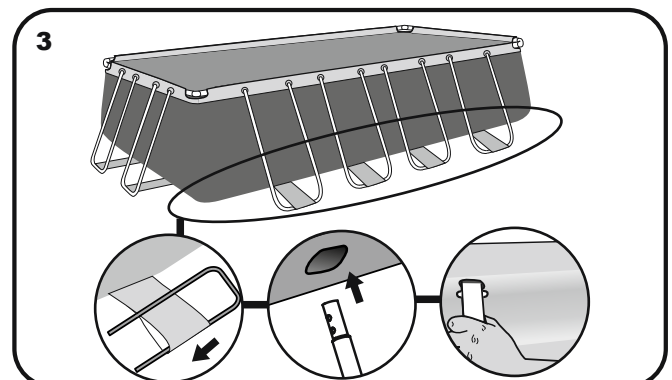
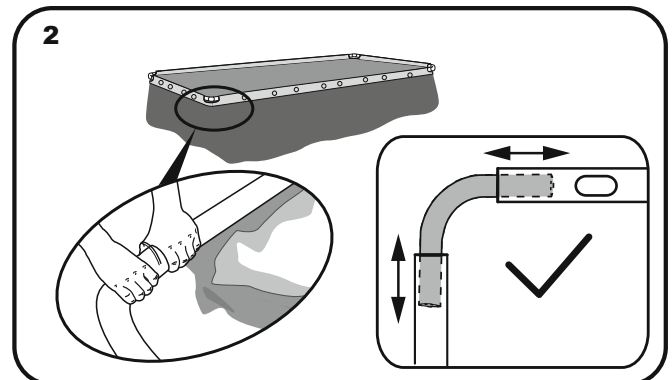
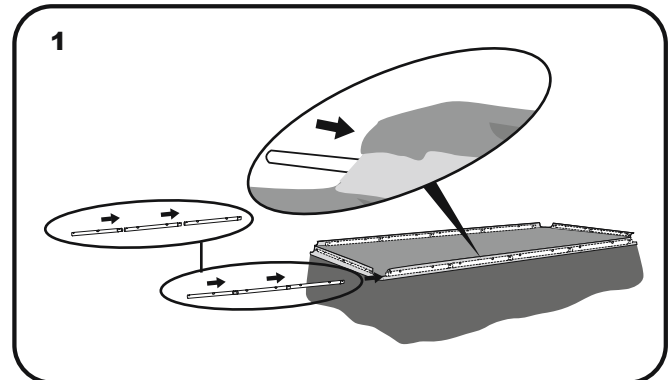

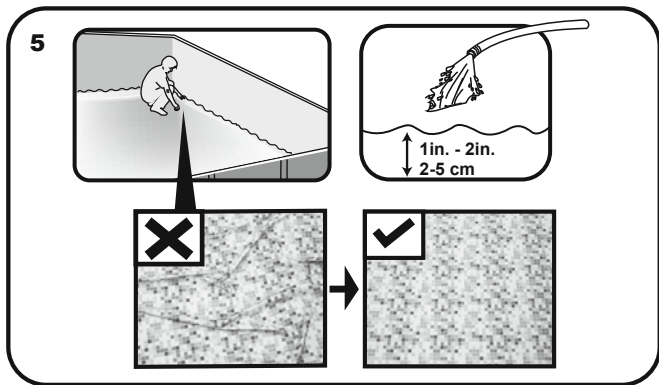

Connection Valve Assembly
For pool with connection valve

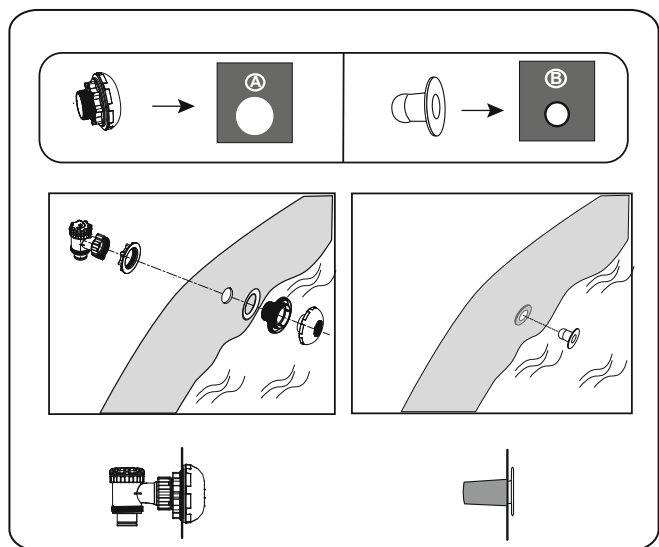

Filling Pool with Water

ATTENTION: Do not leave pool unattended while filling with water.

1. Fill pool until water capacity is 90%, **DO NOT OVERFILL** as this could cause the pool to collapse. In times of heavy rainfall you may need to empty some of the water to ensure the level is correct.
2. When filling the pool is completed, check that the water is not collecting on any side to ensure the pool is level.

IMPORTANT: If pool is not level, drain water and re-level ground by digging out.

Never attempt to move the pool with water in it, serious personal injury or damage to the pool may result.

WARNING: Your pool may contain a great deal of pressure. If your pool has any bulge or uneven side then the pool is not level, the sides may burst and the water may discharge suddenly causing serious personal injury and/or damage to property.

3. Check pool for any leaks at valves or seams, check ground cloth for any evident water loss. Do not add chemicals until this has been done.

NOTE: In the event of a leak, patch your pool using the underwater adhesive repair patch provided. Refer to the FAQ's for further information.

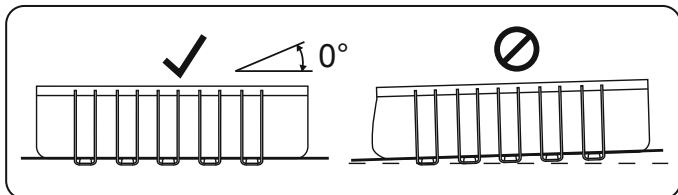
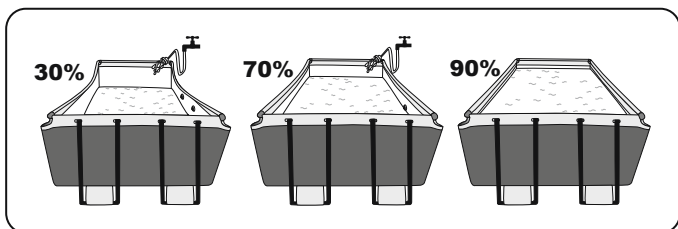

Pool Maintenance

If you do not adhere to the maintenance guidelines below, your health might be at risk, especially that of your children.

IMPORTANT: If you don't respect the ideal values of the water chemicals the PVC can be damaged and become discolored.

The following table lists the sequence of the tests that should be carried out for the ideal values and possible actions. Regularly check the pH value and chlorine concentration weekly and adjust to the ideal values.

TEST	IDEAL VALUES
pH value	7.4 – 7.6
Cyanuric acid	30 – 50 ppm
Free chlorine	2 – 4 ppm
Chlorine compound	0
Algae	None visible
Calcium hardness	200 – 400 ppm

To keep your pool clean:

1. Contact your local pool supply shop for advice and purchase of chemicals and pH kits. One of the most important factors to increase the life of the liner is to keep continuously clean and healthy water. Please strictly follow the instructions from professional technicians for the water treatment through the use of chemicals.
2. Locate a bucket of water next to pool to clean users' feet before entering pool.
3. Cover the pool when not in use.
4. Skim pool regularly to avoid settled dirt.
5. Check and wash the filter cartridge regularly.
6. Gently clean any scum from below the top ring with a clean cloth.
7. Please be careful in case of rain water, kindly check that the water level is not higher than the expected. If so, **YOU HAVE TO DISCHARGE THE EXCESS WATER**

Proper maintenance can maximize the life of your pool.

During the season of use of the swimming pool, the filtration system must be necessarily put into service every day, enough time to assure at least a complete renewal of the volume of water.

ATTENTION: Do not use pump when pool is in use.

During the season of use of the swimming pool, the filtration system must be necessarily put into service every day, enough for a long time to assure at least a complete renewal of the volume of water.

Repair

Check pool for any leaks from valves or seams, check the ground cloth for any evident water loss. Do not add chemicals until this has been done.

NOTE: In the event of a leak, patch your pool using the Heavy-duty repair patch provided. Refer to the FAQs for further information.

Dismantling

1. Unscrew the drain valve cap on the outside of the pool counter clockwise and remove.
2. Connect the adaptor to the hose and put the other end of the hose in the area where you are going to drain your pool. (Check local regulations for drainage by-laws).
3. Screw the control ring of the hose adaptor clockwise onto the drain valve. The drain valve will be open and water will start to drain automatically.
ATTENTION: Water flow can be controlled with the control ring.
4. When draining is finished, unscrew the control ring to close the valve.
5. Disconnect the hose.
6. Screw the cap back onto the drain valve.
7. Air dry pool.

ATTENTION: Do not leave the drained pool outside.

Storage and Winterization

1. Please remove all the accessories and spare parts of the pool and store them clean and dry.
2. Once pool is completely dry, sprinkle with talcum powder to prevent pool from sticking together, fold pool carefully. If pool is not completely dry, mold may result and will damage the pool liner.
3. Store liner and accessories in a dry place with a moderate temperature between 5°C / 41°F and 38°C / 100°F.
4. During the rainy season, pool and accessories should be stored as per above instructions also.
5. Improper draining of the pool might cause serious personal injury and/or damage to personal property.
6. We strongly recommend the pool is disassembled during the off season (winter months). Store in a dry location out of children's reach.



For support please visit us at:
www.bestwaycorp.com/support

©2018 Bestway Inflatables & Material Corp.

All rights reserved/Tous droits réservés/Todos los derechos reservados/Alle Rechte vorbehalten/Tutti i diritti riservati

®™ Trademarks used in some countries under license to/

Marques ®™ utilisées dans certains pays sous la licence de/

Marcas comerciales ®™ utilizadas en algunos países bajo la licencia de/

®™ Die Warenzeichen werden in einigen Ländern verwendet unter Lizenz der/

®™ Marchi utilizzati in alcuni paesi concessi in licenza a

Bestway Inflatables & Material Corp., No.3065 Cao An Road, Shanghai, 201812, China.

Manufactured, distributed and represented in the European Union by/

Fabriqué, distribué et représenté dans l'Union Européenne par/Fabricado, distribuido y representado en la Unión Europea por/

Hergestellt, vertrieben und in der Europäischen Union vertreten von/Prodotto, distribuito e rappresentato nell'Unione Europea da

Bestway (Europe) S.r.l., Via Resistenza, 5, 20098 San Giuliano Milanese (Milano), Italy

Distributed in North America by/Distribué en Amérique du Nord par/Distribuido en Norteamérica por

Bestway (USA) Inc., 3411 E. Harbour Drive, Phoenix, Arizona 85034, United States of America Tel:1-855-838-3888 (For U.S. and Canada)

Distributed in Latin America by/Distribué en Amérique latine par/Distribuido en Latinoamérica por/Distribuido na América Latina por

Bestway Central & South America Ltda, Salar Ascotan 1282, Parque Enea, Pudahuel, Santiago, Chile

Distributed in Australia & New Zealand by **Bestway Australia Pty Ltd, 98-104 Carnarvon Street, Silverwater, NSW 2128, Australia**

www.bestwaycorp.com

Made in China / Fabriqué en Chine / Fabricado en China / Hergestellt in China / Prodotto in Cina