

Dell EMC PowerEdge R640

Installation and Service Manual

Notes, cautions, and warnings

 **NOTE:** A NOTE indicates important information that helps you make better use of your product.

 **CAUTION:** A CAUTION indicates either potential damage to hardware or loss of data and tells you how to avoid the problem.

 **WARNING:** A WARNING indicates a potential for property damage, personal injury, or death.

© 2017 - 2019 Dell Inc. or its subsidiaries. All rights reserved. Dell, EMC, and other trademarks are trademarks of Dell Inc. or its subsidiaries. Other trademarks may be trademarks of their respective owners.

1 Dell EMC PowerEdge R640 overview.....	8
Supported configurations for PowerEdge R640.....	8
Front view of the system.....	10
Left control panel view.....	13
Right control panel view.....	16
Back view of the system.....	17
NIC indicator codes.....	20
Power supply unit indicator codes.....	21
Drive indicator codes.....	23
LCD panel.....	23
Viewing Home screen.....	24
Setup menu.....	24
View menu.....	25
Locating the Service Tag of your system.....	25
System information label.....	26
2 Documentation resources.....	29
3 Technical specifications.....	31
System dimensions.....	31
Chassis weight.....	32
Processor specifications.....	32
Supported operating systems.....	32
Cooling fan specifications.....	32
PSU specifications.....	32
System battery specifications.....	33
Expansion bus specifications.....	33
Memory specifications.....	33
Storage controller specifications.....	34
Drives.....	34
Hard drive specifications.....	34
Optical drive.....	35
Ports and connectors specifications.....	35
USB ports.....	35
NIC ports.....	35
Serial port.....	36
VGA ports.....	36
iDSDM or vFlash card.....	36
Environmental specifications.....	36
Standard operating temperature.....	38
Expanded operating temperature.....	38
Particulate and gaseous contamination specifications.....	41
4 Initial system setup and configuration.....	42

Setting up your system.....	42
iDRAC configuration.....	42
Options to set up iDRAC IP address.....	42
Log in to iDRAC.....	43
Options to install the operating system.....	43
Methods to download firmware and drivers.....	43
Downloading drivers and firmware.....	44
5 Pre-operating system management applications.....	45
Options to manage the pre-operating system applications.....	45
System Setup.....	45
Viewing System Setup.....	45
System Setup details.....	45
System BIOS.....	46
iDRAC Settings utility.....	65
Device Settings.....	65
Dell Lifecycle Controller.....	65
Embedded system management.....	65
Boot Manager.....	65
Viewing Boot Manager.....	65
Boot Manager main menu.....	66
One-shot UEFI boot menu.....	66
System Utilities.....	66
PXE boot.....	66
6 Installing and removing system components	67
Safety instructions.....	67
Before working inside your system.....	67
After working inside your system.....	67
Recommended tools.....	67
Optional front bezel.....	68
Removing the front bezel.....	68
Installing the front bezel.....	69
System cover.....	69
Removing the system cover.....	69
Installing the system cover.....	70
Drives.....	71
Removing a drive blank.....	71
Installing a drive blank.....	72
Removing a drive carrier.....	72
Installing a drive carrier.....	73
Removing the drive from the drive carrier.....	74
Installing a drive into the drive carrier.....	75
Backplane cover.....	76
Removing the backplane cover.....	76
Installing the backplane cover.....	77
Inside the system.....	77
Air shroud.....	80
Removing the air shroud.....	80

Installing the air shroud.....	81
Cooling fans.....	82
Removing a cooling fan.....	82
Installing a cooling fan.....	83
System memory.....	84
System memory guidelines.....	84
General memory module installation guidelines.....	85
NVDIMM-N memory module installation guidelines	86
DCPMM installation guidelines	88
Mode-specific guidelines.....	89
Removing a memory module.....	91
Installing a memory module.....	92
NVDIMM-N battery.....	93
Removing the NVDIMM-N battery.....	93
Installing the NVDIMM-N battery.....	94
Processors and heat sinks.....	95
Removing a processor and heat sink module.....	95
Removing the processor from the processor and heat sink module.....	96
Installing the processor into a processor and heat sink module.....	97
Installing a processor and heat sink module.....	99
Expansion cards and expansion card risers.....	100
Expansion bus specifications.....	100
Removing an expansion card riser.....	105
Installing an expansion card riser.....	107
Removing expansion card from the expansion card riser.....	109
Installing an expansion card into expansion card riser.....	111
M.2 SSD module.....	114
Removing the M.2 SSD module.....	114
Installing the M.2 SSD module.....	115
Optional IDSDM or vFlash module.....	116
Removing the optional IDSDM or vFlash card.....	116
Installing optional IDSDM or vFlash card.....	117
Optional IDSDM or vFlash module.....	118
Removing the MicroSD card.....	118
Installing the MicroSD card.....	119
Network daughter card.....	120
Removing the network daughter card.....	120
Installing the network daughter card.....	121
Integrated storage controller card.....	122
Removing the integrated storage controller card.....	122
Installing the integrated storage controller card.....	123
Backplane.....	125
Backplane details.....	125
Removing the backplane cover.....	126
Installing the backplane.....	126
Removing the 2.5 inch drive rear backplane.....	127
Installing the 2.5 inch drive rear backplane.....	128
Cable routing.....	130
SAS expander card.....	134
Removing the SAS expander card.....	134

Installing the SAS expander card.....	135
Rear drive cage.....	136
Removing the rear drive cage.....	136
Installing the rear drive cage.....	137
System battery.....	138
Replacing the system battery.....	138
USB module.....	139
Removing the USB module.....	139
Installing the USB module.....	139
VGA module.....	140
Removing the VGA module.....	140
Installing the VGA module.....	141
Optional internal USB memory key.....	142
Replacing the optional internal USB memory key.....	142
Optical drive (optional).....	143
Removing the optical drive.....	143
Installing the optical drive.....	143
Power supply units.....	144
Hot spare feature.....	144
Removing a power supply unit blank.....	145
Installing a power supply unit blank.....	145
Removing a power supply unit.....	146
Installing a power supply unit.....	147
Removing a DC power supply unit.....	147
Installing DC power supply unit.....	148
Wiring instructions for a DC power supply unit.....	148
System board.....	149
Removing the system board.....	149
Installing the system board.....	150
Trusted Platform Module.....	152
Upgrading the Trusted Platform Module.....	152
Initializing TPM for BitLocker users.....	153
Initializing the TPM 1.2 for TXT users.....	154
Control panel.....	154
Removing the left control panel.....	154
Installing the left control panel.....	155
Removing the right control panel.....	156
Installing the right control panel.....	157
7 System diagnostics.....	159
Dell Embedded System Diagnostics.....	159
Running the Embedded System Diagnostics from Boot Manager.....	159
Running the Embedded System Diagnostics from the Dell Lifecycle Controller.....	159
System diagnostic controls.....	160
8 Jumpers and connectors	161
System board jumpers and connectors.....	161
System board jumper settings.....	163
Disabling forgotten password.....	163

9 Getting help.....	164
Contacting Dell EMC.....	164
Documentation feedback.....	164
Accessing system information by using QRL.....	164
Quick Resource Locator for R640.....	165
Receiving automated support with SupportAssist	165
Recycling or End-of-Life service information.....	165

Dell EMC PowerEdge R640 overview

The Dell EMC PowerEdge R640 system is a 1U rack server that supports up to:

- Two Intel Xeon Scalable Processors
- 24 DIMM slots
- 8 x 2.5-inch hard drives or 4 x 3.5-inch hard drives on the front panel, or 10 x 2.5-inch hard drives on the front panel with optional support for 2 X 2.5-inch hard drives on the back panel
- Two AC or DC redundant power supply units

NOTE: All instances of SAS, SATA hard drives, SSDs, NVMe drives are referred to as drives in this document, unless specified otherwise.

Topics:

- [Supported configurations for PowerEdge R640](#)
- [Front view of the system](#)
- [Back view of the system](#)
- [Drive indicator codes](#)
- [LCD panel](#)
- [Locating the Service Tag of your system](#)
- [System information label](#)

Supported configurations for PowerEdge R640

The PowerEdge R640 system supports the following configurations:

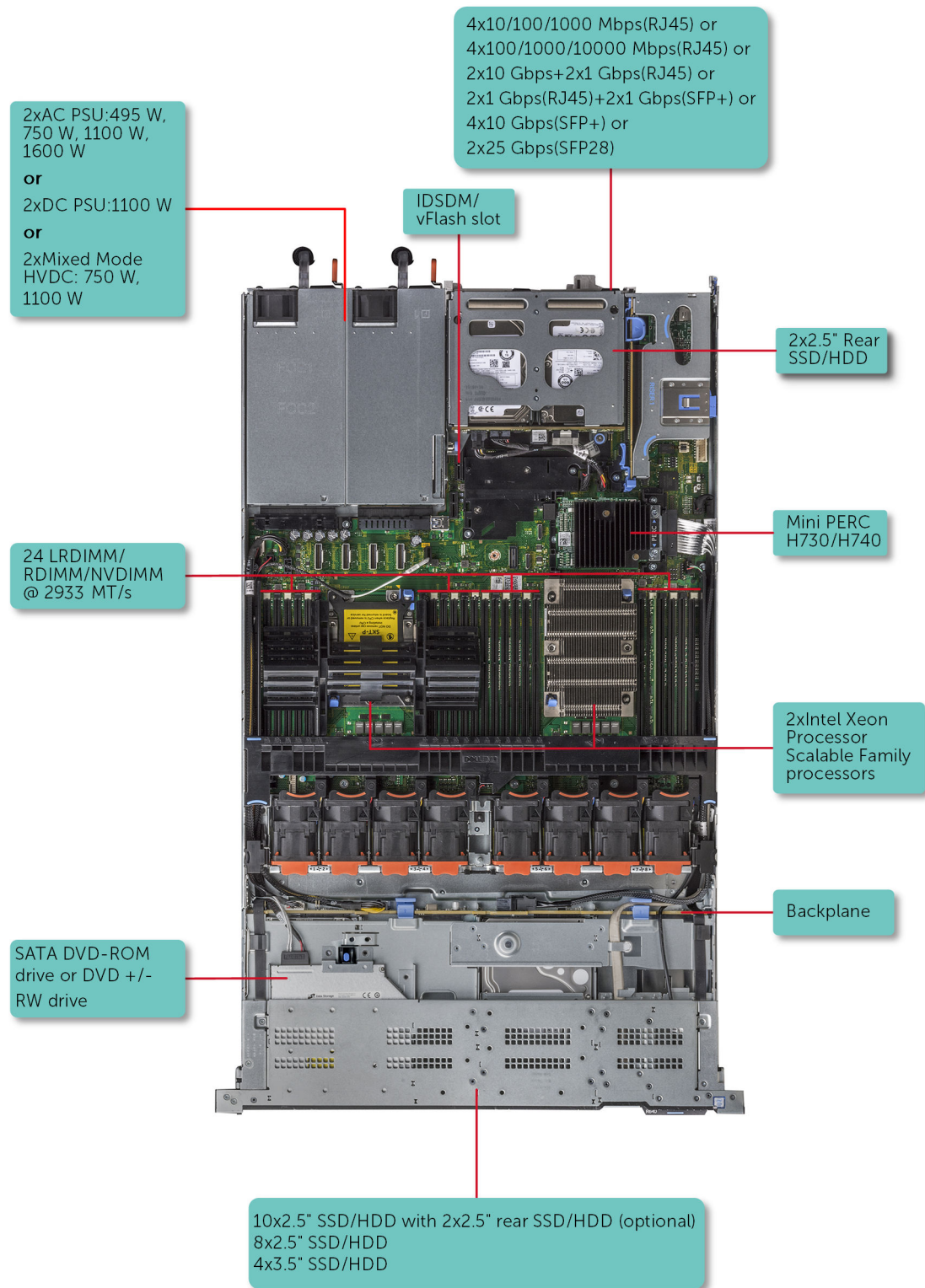

Figure 1. Supported configurations for PowerEdge R640

Front view of the system

The front view displays the features available on the front of the system.

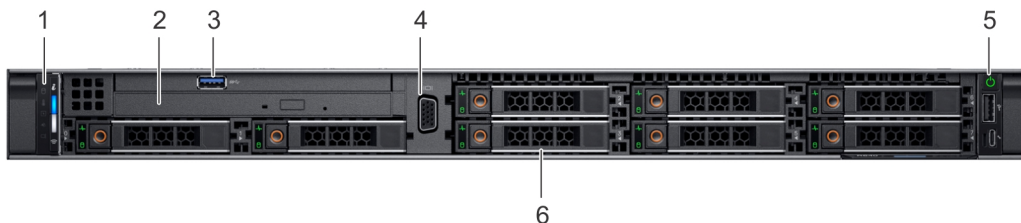

Figure 2. Front view of 8 x 2.5-inch drive system

Table 1. Features available on the front of the system

Item	Ports, panels, and slots	Icon	Description
1	Left control panel	N/A	<p>Contains the system health and system ID, status LED, and the iDRAC Quick Sync 2 (wireless) indicator.</p> <p>NOTE: The iDRAC Quick Sync 2 indicator is available only on certain configurations.</p> <ul style="list-style-type: none"> Status LED: Enables you to identify any failed hardware components. There are up to five status LEDs and an overall system health LED (Chassis health and system ID) bar. For more information, see the Status LED indicators section. Quick Sync 2 (wireless): Indicates a Quick Sync enabled system. The Quick Sync feature is optional. This feature allows management of the system by using mobile devices. This feature aggregates hardware or firmware inventory and various system level diagnostic and error information that can be used in troubleshooting the system. For more information, see the <i>Integrated Dell Remote Access Controller User's Guide</i> at www.dell.com/poweredgemanuals.
2	Optical drive (optional)	N/A	<p>One optional slim SATA DVD-ROM drive or DVD+/-RW drive.</p> <p>NOTE: DVD devices are data only.</p>



Item	Ports, panels, and slots	Icon	Description
3	USB port (optional)		The USB port is USB 3.0 compliant.
4	VGA port		Enables you to connect a display device to the system. For more information, see the Technical specifications section.
5	Right control panel	N/A	Contains the power button, USB port, iDRAC Direct micro port, and the iDRAC Direct status LED.
6	Drive slots	N/A	Enable you to install drives that are supported on your system. For more information about drives, see the Technical specifications section.



Figure 3. Front view of 4 x 3.5-inch drive system

Table 2. Features available on the front of the system

Item	Ports, panels, and slots	Icon	Description
1	Left control panel	N/A	<p>Contains the system health and system ID, status LED, and the iDRAC Quick Sync 2 (wireless) indicator.</p> <p>NOTE: The iDRAC Quick Sync 2 indicator is available only on certain configurations.</p> <ul style="list-style-type: none"> Status LED: Enables you to identify any failed hardware components. There are up to five status LEDs and an overall system health LED (Chassis health and system ID) bar. For more information, see the Status LED indicators section. Quick Sync 2 (wireless): Indicates a Quick Sync enabled system. The Quick Sync feature is optional. This feature allows management of the system by using mobile devices. This feature aggregates hardware or firmware inventory and various system level



Item	Ports, panels, and slots	Icon	Description
			diagnostic and error information that can be used in troubleshooting the system. For more information, see the <i>Integrated Dell Remote Access Controller User's Guide</i> at www.dell.com/poweredgemanuals .
2	Drive slots	N/A	Enable you to install drives that are supported on your system. For more information about drives, see the Technical specifications section.
3	Optical drive (optional)	N/A	One optional slim SATA DVD-ROM drive or DVD+/-RW drive. NOTE: DVD devices are data only.
4	VGA port		Enables you to connect a display device to the system. For more information, see the Technical specifications section.
5	USB port (optional)		The USB port is USB 3.0 compliant.
6	Right control panel	N/A	Contains the power button, USB port, iDRAC Direct micro port, and the iDRAC Direct status LED.
7	Information tag	N/A	The Information Tag is a slide-out label panel that contains system information such as Service Tag, NIC, MAC address, and so on. If you have opted for the secure default access to iDRAC, the Information tag also contains the iDRAC secure default password.



Figure 4. Front view of 10 x 2.5-inch drive system

Table 3. Features available on the front of the system

Item	Ports, panels, and slots	Icon	Description
1	Left control panel	N/A	Contains the system health and system ID, status LED, and the iDRAC Quick Sync 2 (wireless) indicator. NOTE: The iDRAC Quick Sync 2 indicator is available only on certain configurations.

Item	Ports, panels, and slots	Icon	Description
			<ul style="list-style-type: none"> Status LED: Enables you to identify any failed hardware components. There are up to five status LEDs and an overall system health LED (Chassis health and system ID) bar. For more information, see the Status LED indicators section. Quick Sync 2 (wireless): Indicates a Quick Sync enabled system. The Quick Sync feature is optional. This feature allows management of the system by using mobile devices. This feature aggregates hardware or firmware inventory and various system level diagnostic and error information that can be used in troubleshooting the system. For more information, see the <i>Integrated Dell Remote Access Controller User's Guide</i> at www.dell.com/poweredgemanuals.
2	Drive slots	N/A	Enable you to install drives that are supported on your system. For more information about drives, see the Technical specifications section.
3	VGA port		Enables you to connect a display device to the system. For more information, see the Technical specifications section.
4	Right control panel	N/A	Contains the power button, USB port, iDRAC Direct micro port, and the iDRAC Direct status LED.
5	Information tag	N/A	The Information Tag is a slide-out label panel that contains system information such as Service Tag, NIC, MAC address, and so on. If you have opted for the secure default access to iDRAC, the Information tag also contains the iDRAC secure default password.

Left control panel view

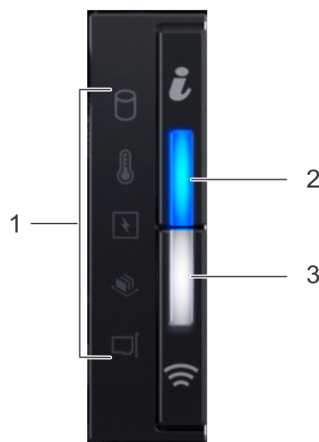



Figure 5. Left control panel with optional iDRAC Quick Sync 2.0 indicator

Table 4. Left control panel

Item	Indicator or button	Icon	Description
1	Status LED indicators	N/A	Indicate the status of the system. For more information, see the Status LED indicators section.
2	System health and system ID indicator		Indicates the system health. For more information, see the System health and system ID indicator codes section.
3	iDRAC Quick Sync 2 wireless indicator (optional)		Indicates if the iDRAC Quick Sync 2 wireless option is activated. The Quick Sync 2 feature allows management of the system using mobile devices. This feature aggregates hardware/firmware inventory and various system level diagnostic/error information that can be used in troubleshooting the system. You can access system inventory, Dell





NOTE: iDRAC Quick Sync 2 wireless indicator is available

Item	Indicator or button	Icon	Description
	only on certain configurations.		EMC Lifecycle Controller logs or system logs, system health status, and also configure iDRAC, BIOS, and networking parameters. You can also launch the virtual Keyboard, Video, and Mouse (KVM) viewer and virtual Kernel based Virtual Machine (KVM), on a supported mobile device. www.dell.com/poweredgemanuals

Status LED indicators

NOTE: The indicators display solid amber if any error occurs.

Table 5. Status LED indicators and descriptions

Icon	Description	Condition	Corrective action
	Drive indicator	The indicator turns solid amber if there is a drive error.	<ul style="list-style-type: none"> Check the System Event Log to determine if the drive has an error. Run the appropriate Online Diagnostics test. Restart the system and run embedded diagnostics (ePSA). If the drives are configured in a RAID array, restart the system, and enter the host adapter configuration utility program.
	Temperature indicator	The indicator turns solid amber if the system experiences a thermal error (for example, the ambient temperature is out of range or there is a fan failure).	Ensure that none of the following conditions exist: <ul style="list-style-type: none"> A cooling fan has been removed or has failed. System cover, air shroud, memory module blank, or back filler bracket is removed. Ambient temperature is too high. External airflow is obstructed. If the problem persists, see Getting help .
	Electrical indicator	The indicator turns solid amber if the system experiences an electrical error (for example, voltage out of range, or a failed power supply unit (PSU) or voltage regulator).	Check the System Event Log or system messages for the specific issue. If it is due to a problem with the PSU, check the LED on the PSU. Reseat the PSU. If the problem persists, see Getting help .
	Memory indicator	The indicator turns solid amber if a memory error occurs.	Check the System Event Log or system messages for the location of the failed memory. Reseat the memory module. If the problem persists, see Getting help .
	PCIe indicator	The indicator turns solid amber if a PCIe card experiences an error.	Restart the system. Update any required drivers for the PCIe card. Reinstall the card. If the problem persists, see Getting help .

System health and system ID indicator codes

The system health and system ID indicator is located on the left control panel of your system.

System health and system ID indicators



Table 6. System health and system ID indicator codes

System health and system ID indicator code	Condition
Solid blue	Indicates that the system is turned on, system is healthy, and system ID mode is not active. Press the system health and system ID button to switch to system ID mode.
Blinking blue	Indicates that the system ID mode is active. Press the system health and system ID button to switch to system health mode.
Solid amber	Indicates that the system is in fail-safe mode. If the problem persists, see the Getting help section.
Blinking amber	Indicates that the system is experiencing a fault. Check the System Event Log or the LCD panel, if available on the bezel, for specific error messages. For information about the event and error messages generated by the system firmware and agents that monitor system components, go to qrl.dell.com > Look Up > Error Code , type the error code, and then click Look it up .

iDRAC Quick Sync 2 indicator codes

iDRAC Quick Sync 2 module (optional) is located on the left control panel of your system.

iDRAC Quick Sync 2 indicators



Table 7. iDRAC Quick Sync 2 indicators and descriptions

iDRAC Quick Sync 2 indicator code	Condition	Corrective action
Off (default state)	Indicates that the iDRAC Quick Sync 2 feature is turned off. Press the iDRAC Quick Sync 2 button to turn on the iDRAC Quick Sync 2 feature.	If the LED fails to turn on, reseal the left control panel flex cable and check. If the problem persists, see the Getting help section.
Solid white	Indicates that iDRAC Quick Sync 2 is ready to communicate. Press the iDRAC Quick Sync 2 button to turn off.	If the LED fails to turn off, restart the system. If the problem persists, see the Getting help section.
Blinks white rapidly	Indicates data transfer activity.	If the indicator continues to blink indefinitely, see the Getting help section.
Blinks white slowly	Indicates that firmware update is in progress.	If the indicator continues to blink indefinitely, see the Getting help section.
Blinks white five times rapidly and then turns off	Indicates that the iDRAC Quick Sync 2 feature is disabled.	Check if iDRAC Quick Sync 2 feature is configured to be disabled by iDRAC. If the problem persists, see the Getting help section. www.dell.com/poweredgemanuals or <i>Dell OpenManage Server Administrator User's Guide</i> at www.dell.com/openmanagemanuals .
Solid amber	Indicates that the system is in fail-safe mode.	Restart the system. If the problem persists, see the Getting help section.
Blinking amber	Indicates that the iDRAC Quick Sync 2 hardware is not responding properly.	Restart the system. If the problem persists, see the Getting help section.

Right control panel view

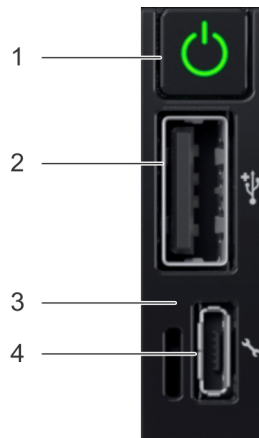





Figure 6. Right control panel

Table 8. Right control panel

Item	Indicator or button	Icon	Description
1	Power button		Indicates if the system is powered on or off. Press the power button to manually power on or off the system. NOTE: Press the power button to gracefully shut down an ACPI-compliant operating system.
2	USB port		The USB ports are 4-pin, 2.0-compliant. This port enables you to connect USB devices to the system.
3	iDRAC Direct LED	N/A	The iDRAC Direct LED indicator lights up to indicate that the iDRAC Direct port is actively connected to a device. For more information, see the iDRAC Quick Sync 2 indicator codes section.
4	iDRAC Direct port (Micro-AB USB)		The iDRAC Direct (Micro-AB USB) port enables you to access the iDRAC Direct (Micro-AB) features. For more information, see the <i>Integrated Dell Remote Access Controller User's Guide</i> at www.dell.com/poweredgemanuals .

iDRAC Direct LED indicator codes

The iDRAC Direct LED indicator lights up to indicate that the port is connected and is being used as a part of the iDRAC subsystem.

You can configure iDRAC Direct by using a USB to micro USB (type AB) cable, which you can connect to your laptop or tablet. The following table describes iDRAC Direct activity when the iDRAC Direct port is active:

Table 9. iDRAC Direct LED indicator codes

iDRAC Direct LED indicator code	Condition
Solid green for two seconds	Indicates that the laptop or tablet is connected.
Flashing green (on for two seconds and off for two seconds)	Indicates that the laptop or tablet connected is recognized.
Turns off	Indicates that the laptop or tablet is unplugged.

Back view of the system

The back view displays the features available on the back of the system.

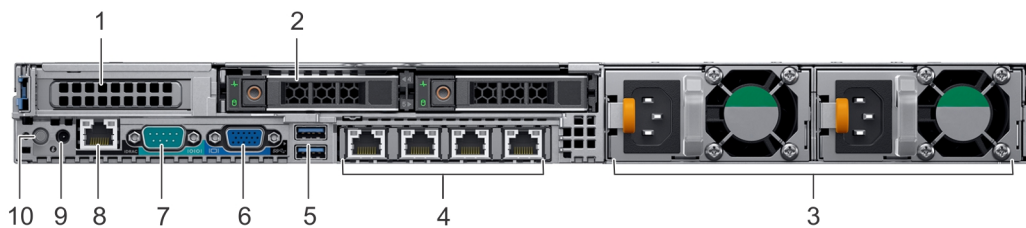







Figure 7. Back view of 2 x 2.5-inch drives with 1 PCIe expansion slot

Table 10. 2 X 2.5-inch drive system with 1 PCIe expansion slot

Item	Ports, panels, or slots	Icon	Description
1	PCIe expansion card slot	N/A	The expansion slot(s) enable you to connect PCI Express expansion cards. For more information on the expansion cards that are supported on your system, see the Expansion card guidelines .
2	Drive slot (2)	N/A	Enable you to install drives that are supported on your system. For more information about drives, see the Technical specifications section.
3	Power supply unit (2)	N/A	For more information about the PSU configurations, see the Technical specifications section
4	NIC port (4)		The NIC ports that are integrated on the network daughter card (NDC) provide network connectivity. For more information about the supported configurations, see the Technical specifications section.
5	USB 3.0 port (2)		The USB ports are 9-pin and 3.0-compliant. These ports enable you to connect USB devices to the system.
6	VGA port		Enables you to connect a display device to the system. For more information, see the Technical specifications section.

Item	Ports, panels, or slots	Icon	Description
7	Serial port	IOIOI	Enables you to connect a serial device to the system. For more information, see the Technical specifications section.
8	iDRAC9 dedicated network port		Use the iDRAC9 dedicated network port to securely access the embedded iDRAC on a separate management network, see the <i>Integrated Dell Remote Access Controller User's Guide</i> at www.dell.com/poweredgemanuals
9	System status indicator cable port	N/A	Enables you to connect the status indicator cable and view system status when the CMA is installed.
10	System identification button		The System Identification (ID) button is available on the front and back of the systems. Press the button to identify a system in a rack by turning on the system ID button. You can also use the system ID button to reset iDRAC and to access BIOS using the step through mode.

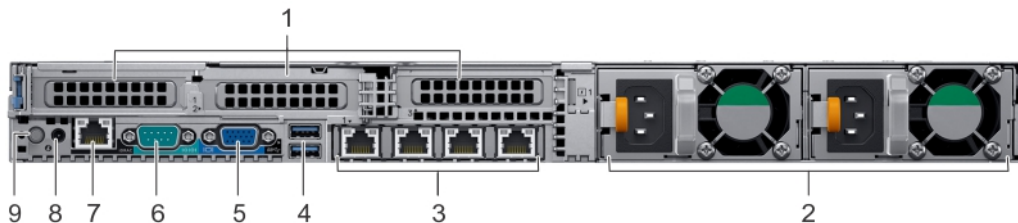







Figure 8. Back view of system with 3 PCIe expansion slots

Table 11. 2 X 2.5-inch drive system with 3 PCIe expansion slot

Item	Ports, panels, or slots	Icon	Description
1	PCIe expansion card slot(3)	N/A	The expansion slot(s) enable you to connect PCI Express expansion cards. For more information on the expansion cards that are supported on your system, see the Expansion card guidelines .
2	Power supply unit (2)	N/A	For more information about the PSU configurations, see the Technical specifications section
3	NIC port (4)		The NIC ports that are integrated on the network daughter card (NDC) provide network connectivity. For more information about the supported configurations, see the Technical specifications section.

Item	Ports, panels, or slots	Icon	Description
4	USB 3.0 port (2)		The USB ports are 9-pin and 3.0-compliant. These ports enable you to connect USB devices to the system.
5	VGA port		Enables you to connect a display device to the system. For more information, see the Technical specifications section.
6	Serial port		Enables you to connect a serial device to the system. For more information, see the Technical specifications section.
7	iDRAC9 dedicated network port		Use the iDRAC9 dedicated network port to securely access the embedded iDRAC on a separate management network, see the www.dell.com/poweredgemanuals
8	System status indicator cable port	N/A	Enables you to connect the status indicator cable and view system status when the CMA is installed.
9	System identification button		The System Identification (ID) button is available on the front and back of the systems. Press the button to identify a system in a rack by turning on the system ID button. You can also use the system ID button to reset iDRAC and to access BIOS using the step through mode.

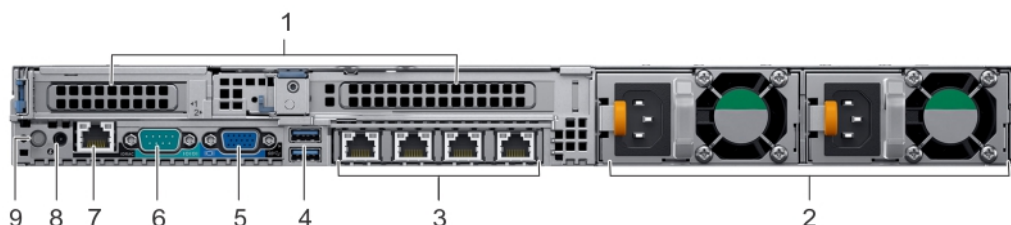







Figure 9. Back view of system with 2 PCIe expansion slots

Table 12. 2 X 2.5-inch drive system with 2 PCIe expansion slot

Item	Ports, panels, or slots	Icon	Description
1	PCIe expansion card slot (2)	N/A	The expansion slot(s) enable you to connect PCI Express expansion cards. For more information on the expansion cards that are supported on your system, see the Expansion card guidelines .
2	Power supply unit (2)	N/A	For more information about the PSU configurations, see the Technical specifications section

Item	Ports, panels, or slots	Icon	Description
3	NIC port (4)		The NIC ports that are integrated on the network daughter card (NDC) provide network connectivity. For more information about the supported configurations, see the Technical specifications section.
4	USB 3.0 port (2)		The USB ports are 9-pin and 3.0-compliant. These ports enable you to connect USB devices to the system.
5	VGA port		Enables you to connect a display device to the system. For more information, see the Technical specifications section.
6	Serial port		Enables you to connect a serial device to the system. For more information, see the Technical specifications section.
7	iDRAC9 dedicated network port		Use the iDRAC9 dedicated network port to securely access the embedded iDRAC on a separate management network, see the www.dell.com/poweredgemanuals
8	System status indicator cable port	N/A	Enables you to connect the status indicator cable and view system status when the CMA is installed.
9	System identification button		The System Identification (ID) button is available on the front and back of the systems. Press the button to identify a system in a rack by turning on the system ID button. You can also use the system ID button to reset iDRAC and to access BIOS using the step through mode.

NIC indicator codes

Each NIC on the back of the system has indicators that provide information about the activity and link status. The activity LED indicator indicates if data is flowing through the NIC, and the link LED indicator indicates the speed of the connected network.

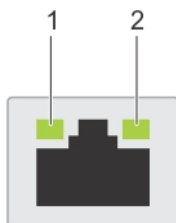

Figure 10. NIC indicator codes

1. Link LED indicator
2. Activity LED indicator

Table 13. NIC indicator codes

Status	Condition
Link and activity indicators are off.	The NIC is not connected to the network.
Link indicator is green, and activity indicator is blinking green.	The NIC is connected to a valid network at its maximum port speed, and data is being sent or received.
Link indicator is amber, and activity indicator is blinking green.	The NIC is connected to a valid network at less than its maximum port speed, and data is being sent or received.
Link indicator is green, and activity indicator is off.	The NIC is connected to a valid network at its maximum port speed, and data is not being sent or received.
Link indicator is amber, and activity indicator is off.	The NIC is connected to a valid network at less than its maximum port speed, and data is not being sent or received.
Link indicator is blinking green, and activity is off.	NIC identify is enabled through the NIC configuration utility.

Power supply unit indicator codes

AC power supply units (PSUs) have an illuminated translucent handle that serves as an indicator. The DC PSUs have an LED that serves as an indicator. The indicator shows whether power is present or if a power fault has occurred.

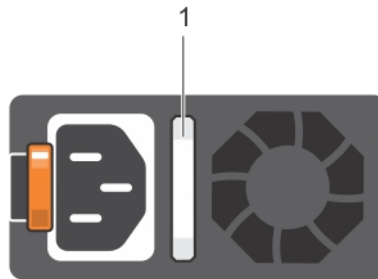

Figure 11. AC PSU status indicator

1. AC PSU status indicator/handle

Table 14. AC PSU status indicator codes

Power indicator codes	Condition
Green	A valid power source is connected to the PSU and the PSU is operational.
Blinking amber	Indicates a problem with the PSU.
Not illuminated	Power is not connected to the PSU.
Blinking green	When the firmware of the PSU is being updated, the PSU handle blinks green. ⚠ CAUTION: Do not disconnect the power cord or unplug the PSU when updating firmware. If firmware update is interrupted, the PSUs do not function.
Blinking green and turns off	When hot-plugging a PSU, the PSU handle blinks green five times at a rate of 4 Hz and turns off. This indicates a PSU mismatch with respect to efficiency, feature set, health status, or supported voltage. If two PSUs are installed, both the PSUs must have the same type of label; for example, Extended Power Performance (EPP) label. Mixing PSUs from previous generations of PowerEdge servers is not supported, even if the PSUs have the same power rating. This results in a PSU mismatch condition or failure to turn the system on. ⚠ CAUTION: When correcting a PSU mismatch, replace only the PSU with the blinking indicator. Swapping the PSU to make a matched pair can result in an error condition and unexpected system shutdown. To change from a high output configuration to a low output configuration or vice versa, you must turn off the system. AC PSUs support both 240 V and 120 V input voltages with the exception of Titanium PSUs, which support only 240 V. When two identical PSUs receive different input voltages, they can output different wattages, and trigger a mismatch.

Power indicator codes	Condition
-----------------------	-----------

CAUTION: If two PSUs are used, they must be of the same type and have the same maximum output power. Combining AC and DC PSUs is not supported and triggers a mismatch.

DC PSU status indicator

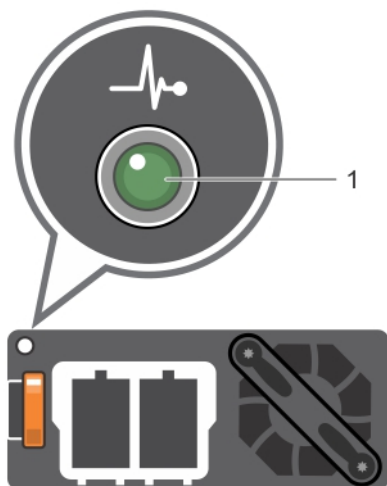

1. DC PSU status indicator

Table 15. DC PSU status indicator codes

Power indicator codes	Condition
Green	A valid power source is connected to the PSU and the PSU is operational.
Blinking amber	Indicates a problem with the PSU.
Not illuminated	Power is not connected to the PSU.
Blinking green	<p>When hot-plugging a PSU, the PSU indicator blinks green. This indicates that there is a PSU mismatch with respect to efficiency, feature set, health status, or supported voltage.</p> <p>CAUTION: If two PSUs are installed, both the PSUs must have the same type of label; for example, Extended Power Performance (EPP) label. Mixing PSUs from previous generations of PowerEdge servers is not supported, even if the PSUs have the same power rating. This results in a PSU mismatch condition or failure to turn the system on.</p> <p>CAUTION: When correcting a PSU mismatch, replace only the PSU with the blinking indicator. Swapping the PSU to make a matched pair can result in an error condition and unexpected system shutdown. To change from a High Output configuration to a Low Output configuration or vice versa, you must turn off the system.</p> <p>CAUTION: If two PSUs are used, they must be of the same type and have the same maximum output power.</p> <p>CAUTION: Combining AC and DC PSUs is not supported and triggers a mismatch.</p>

Drive indicator codes

Each drive carrier has an activity LED indicator and a status LED indicator. The indicators provide information about the current status of the drive. The activity LED indicator indicates whether the drive is currently in use or not. The status LED indicator indicates the power condition of the drive.

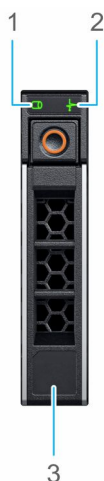

Figure 12. Drive indicators on the drive and the mid drive tray backplane

1. Drive activity LED indicator
2. Drive status LED indicator
3. Drive capacity label

NOTE: If the drive is in the Advanced Host Controller Interface (AHCI) mode, the status LED indicator does not turn on.

Table 16. Drive indicator codes

Drive status indicator code	Condition
Flashes green twice per second	Identifying drive or preparing for removal.
Off	Drive ready for removal. NOTE: The drive status indicator remains off until all drives are initialized after the system is turned on. Drives are not ready for removal during this time.
Flashes green, amber, and then turns off	Predicted drive failure.
Flashes amber four times per second	Drive failed.
Flashes green slowly	Drive rebuilding.
Solid green	Drive online.
Flashes green for three seconds, amber for three seconds, and then turns off after six seconds	Rebuild stopped.

LCD panel

The LCD panel provides system information, status, and error messages to indicate if the system is functioning correctly or requires attention. The LCD panel can also be used to configure or view the system's iDRAC IP address. For information about the event and error messages generated by the system firmware and agents that monitor system components, go to qrl.dell.com > **Look Up** > **Error Code**, type the error code, and then click **Look it up**.

The LCD panel is available only on the optional front bezel. The optional front bezel is hot pluggable.

The statuses and conditions of the LCD panel are outlined here:

- The LCD backlight is white during normal operating conditions.
- When the system needs attention, the LCD backlight turns amber, and displays an error code followed by descriptive text.

NOTE: If the system is connected to a power source and an error is detected, the LCD turns amber regardless of whether the system is turned on or off.

- When the system turns off and there are no errors, LCD enters the standby mode after five minutes of inactivity. Press any button on the LCD to turn it on.
- If the LCD panel stops responding, remove the bezel and reinstall it.
If the problem persists, see [Getting help](#).
- The LCD backlight remains off if LCD messaging is turned off using the iDRAC utility, the LCD panel, or other tools.

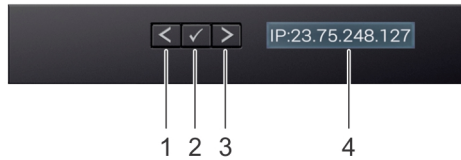

Figure 13. LCD panel features



Table 17. LCD panel features

Item	Button or display	Description
1	Left	Moves the cursor back in one-step increments.
2	Select	Selects the menu item highlighted by the cursor.
3	Right	Moves the cursor forward in one-step increments. During message scrolling: <ul style="list-style-type: none"> Press and hold the right button to increase scrolling speed. Release the button to stop. <p>NOTE: The display stops scrolling when the button is released. After 45 seconds of inactivity, the display starts scrolling.</p>
4	LCD display	Displays system information, status, and error messages or iDRAC IP address.

Viewing Home screen

The **Home** screen displays user-configurable information about the system. This screen is displayed during normal system operation when there are no status messages or errors. When the system turns off and there are no errors, LCD enters the standby mode after five minutes of inactivity. Press any button on the LCD to turn it on.

Steps

- To view the **Home** screen, press one of the three navigation buttons (Select, Left, or Right).
- To navigate to the **Home** screen from another menu, complete the following steps:
 - Press and hold the navigation button until the up arrow  is displayed.
 - Navigate to the **Home** icon  using the up arrow .
 - Select the **Home** icon.
 - On the **Home** screen, press the **Select** button to enter the main menu.

Setup menu

NOTE: When you select an option in the Setup menu, you must confirm the option before proceeding to the next action.

Option	Description
iDRAC	Select DHCP or Static IP to configure the network mode. If Static IP is selected, the available fields are IP , Subnet (Sub) , and Gateway (Gtw) . Select Setup DNS to enable DNS and to view domain addresses. Two separate DNS entries are available.

Option	Description
Set error	Select SEL to view LCD error messages in a format that matches the IPMI description in the SEL. This enables you to match an LCD message with an SEL entry. Select Simple to view LCD error messages in a simplified user-friendly description. For information about the event and error messages generated by the system firmware and agents that monitor system components, go to qrl.dell.com > Look Up > Error Code , type the error code, and then click Look it up .
Set home	Select the default information to be displayed on the Home screen. See View menu section for the options and option items that can be set as the default on the Home screen.

View menu

NOTE: When you select an option in the View menu, you must confirm the option before proceeding to the next action.

Option	Description
iDRAC IP	Displays the IPv4 or IPv6 addresses for iDRAC9. Addresses include DNS (Primary and Secondary) , Gateway , IP , and Subnet (IPv6 does not have Subnet).
MAC	Displays the MAC addresses for iDRAC , iSCSI , or Network devices.
Name	Displays the name of the Host , Model , or User String for the system.
Number	Displays the Asset tag or the Service tag for the system.
Power	Displays the power output of the system in BTU/hr or Watts. The display format can be configured in the Set home submenu of the Setup menu.
Temperature	Displays the temperature of the system in Celsius or Fahrenheit. The display format can be configured in the Set home submenu of the Setup menu.

Locating the Service Tag of your system

You can identify your system using the unique Express Service Code and Service Tag. Pull out the information tag in front of the system to view the Express Service Code and Service Tag. Alternatively, the information may be on a sticker on the chassis of the system. The mini Enterprise Service Tag (EST) is found on the back of the system. This information is used by Dell EMC to route support calls to the appropriate personnel.

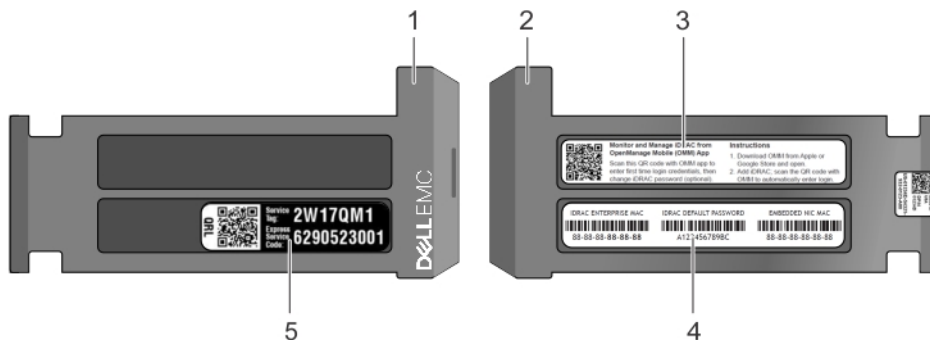

Figure 14. Locating Service Tag of your system

1. information tag (front view)
2. information tag (back view)
3. OpenManage Mobile (OMM) label
4. iDRAC MAC address and iDRAC secure password label
5. Service Tag

System information label

PowerEdge R640 – Front system information label

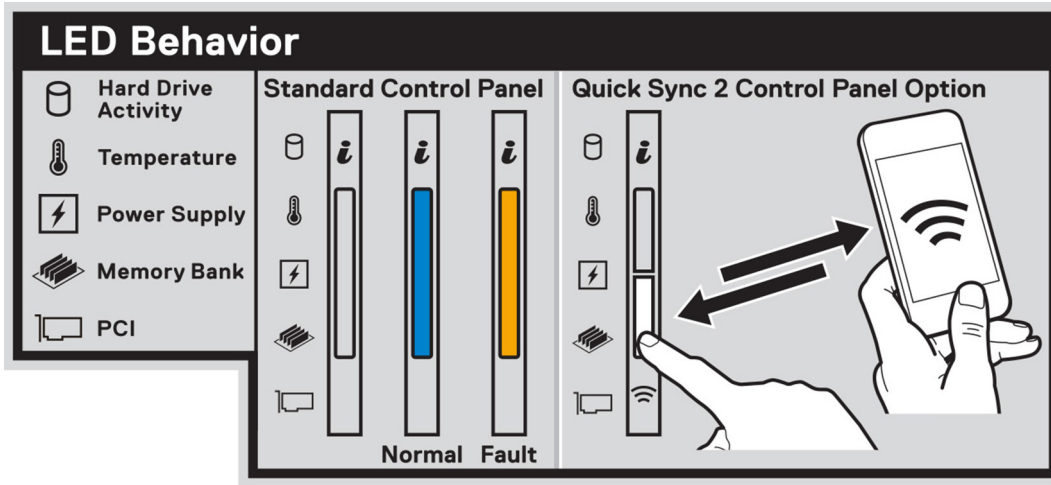

Figure 15. LED behavior

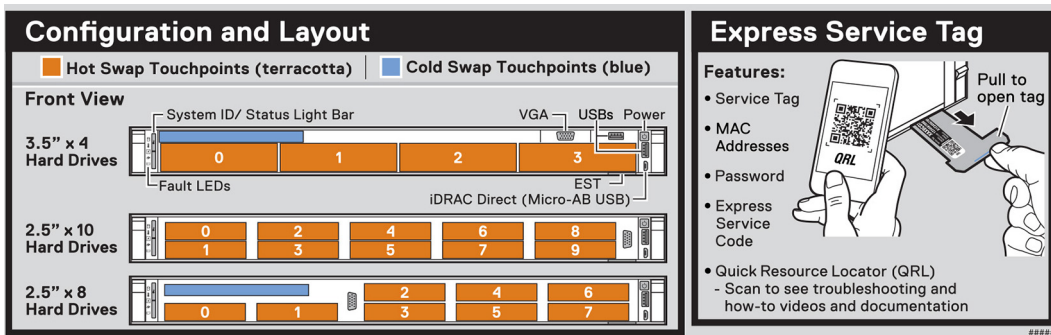

Figure 16. Configuration and layout and express service tag

PowerEdge R640 – Service information

Service Information

System Touchpoints

- Hot swap touchpoints: Components with terracotta touchpoints can be serviced while the system is running.
- Cold swap touchpoints: Components with blue touchpoints require a full system shutdown before servicing.

Mechanical Overview

Top View

Front of system

Electrical Overview

System Board Connections

<ul style="list-style-type: none"> 1 Riser 1 2 TPM Docking 3 Coin Cell Battery 4 Rear Backplane Signal 5 Rear Backplane Power 6 Jumpers 7 VGA 8 MiniPERC 9 USB 2.0 10 PCH SATA-B 11 PCH SATA-D 12 DIMMs for CPU 1 Channels 0, 1, 2 13 CPU 1 14 DIMMs for CPU 1 Channels 3, 4, 5 15 Right CP 16 Fan 8 17 Fan 7 18 Fan 6 19 Fan 5 20 Fan 4 21 Fan 3 22 Fan 2 23 Fan 1 24 NVDIMM Battery Signal 	<ul style="list-style-type: none"> 25 NVDIMM Battery Power 26 Left CP 27 DIMMs for CPU 2 Channels 3, 4, 5 28 CPU 2 29 DIMMs for CPU 2 Channels 0, 1, 2 30 EXP Power 31 ODD Power 32 Backplane Signal 33 Backplane Power 34 PSU 2 35 Backplane HDDs 2-3 36 Backplane HDDs 4-5 37 Backplane HDDs 6-7 38 Backplane HDDs 8-9 39 PSU 1 40 ODD Signal 41 Riser 2 42 NDC 43 IDSDM + vFlash 44 Internal USB 3.0 45 PCH SATA-A
--	--

Rear View PCIe Configurations

Rear View Hard Drive Configurations

Caution: Many repairs may only be done by a certified service technician. You should only perform troubleshooting and simple repairs as authorized in your product documentation, or as directed by the online or telephone service and support team. Damage due to servicing that is not authorized by Dell is not covered by your warranty. Read and follow the safety instructions that came with the product.

System Tasks







Network Daughter Card Installation

MiniPERC

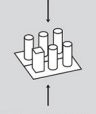
Copyright © 2017 Dell Inc. or its subsidiaries. All Rights Reserved. Rev A00-01. Label Part No. 8MNJ4.

Figure 17. Service information, electrical overview, network daughter card and miniPERC installation

Jumper Settings

Jumper	Setting	Description
 PWRD_EN	 (default)	BIOS password is enabled.
		BIOS password is disabled. iDRAC local access unlocked at next AC power cycle. iDRAC password reset is enabled in F2 iDRAC settings menu.
	 (default)	BIOS configuration settings retained at system boot.
 NVRAM_CLR	 (default)	BIOS configuration settings cleared at system boot.

Scan to see hardware servicing and software setup videos, how-to's, and documentation.



Quick Resource Locator
Dell.com/GRL/Server/PER640

To learn more about this Dell product or to order additional or replacement parts, go to Dell.com/support

Memory Information

⚠ Caution: Memory (DIMMs) and CPUs may be hot during servicing.

B6 B5 B4
↓ B12 B11 B10



B1 B2 B3 A6 A5 A4
↓ B7 B8 B9 ↓ A12 A11 A10

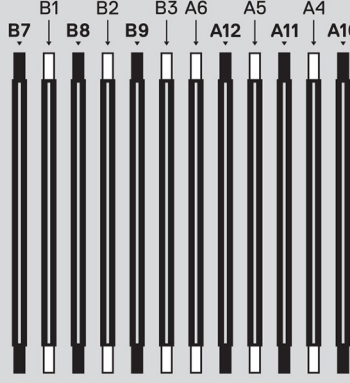

A1 A2 A3
↓ A7 A8 A9

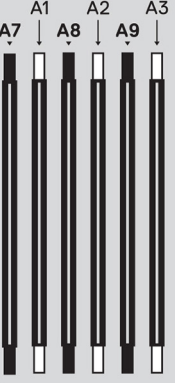

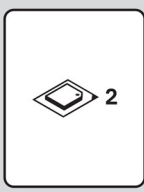

2

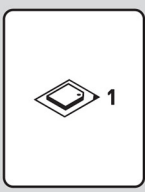

1

Configuration	Sequence
Memory-Optimized	1, 2, 3, 4, 5, 6, 7, 8, 9, 10, 11, 12
Mirroring	(1,2) (3,4) (5,6) (7,8) (9,10) (11,12)

Memory Sparring details are documented in the *Installation and Service Manual*.

NVDIMM Battery

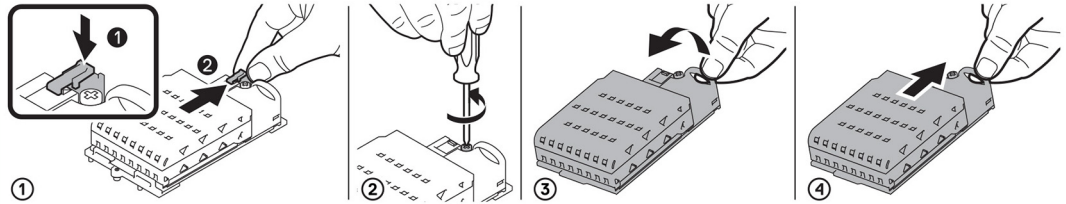

1. Push down the battery latch.
2. Turn the battery counter-clockwise.
3. Lift the battery out of the slot.
4. Push the battery up to release it.

Figure 18. Memory information, jumper setting and NVDIMM battery removal

Documentation resources

This section provides information about the documentation resources for your system.

To view the document that is listed in the documentation resources table:

- From the Dell EMC support site:
 1. Click the documentation link that is provided in the Location column in the table.
 2. Click the required product or product version.
 3. On the Product Support page, click **Manuals & documents**.
- Using search engines:
 - Type the name and version of the document in the search box.

NOTE: To locate the product name and model, see the front of your system.

Table 18. Additional documentation resources for your system

Task	Document	Location
Setting up your system	For more information about installing and securing the system into a rack, see the Rail Installation Guide included with your rack solution. For information about setting up your system, see the <i>Getting Started Guide</i> document that is shipped with your system.	www.dell.com/poweredgemanuals
Configuring your system	For information about the iDRAC features, configuring and logging in to iDRAC, and managing your system remotely, see the Integrated Dell Remote Access Controller User's Guide. For information about understanding Remote Access Controller Admin (RACADM) subcommands and supported RACADM interfaces, see the RACADM CLI Guide for iDRAC. For information about Redfish and its protocol, supported schema, and Redfish Eventing are implemented in iDRAC, see the Redfish API Guide. For information about iDRAC property database group and object descriptions, see the Attribute Registry Guide.	www.dell.com/poweredgemanuals
	For information about earlier versions of the iDRAC documents, see the iDRAC documentation. To identify the version of iDRAC available on your system, on the iDRAC web interface, click ? > About .	www.dell.com/idracmanuals
	For information about installing the operating system, see the operating system documentation.	www.dell.com/operatingsystemmanuals
	For information about updating drivers and firmware, see the Methods to download firmware and drivers section in this document.	www.dell.com/support/drivers
Managing your system	For information about systems management software offered by Dell, see the Dell	www.dell.com/poweredgemanuals

Task	Document	Location
	OpenManage Systems Management Overview Guide.	
	For information about setting up, using, and troubleshooting OpenManage, see the Dell OpenManage Server Administrator User's Guide.	www.dell.com/openmanagemanuals > OpenManage Server Administrator
	For information about installing, using, and troubleshooting Dell OpenManage Essentials, see the Dell OpenManage Essentials User's Guide.	www.dell.com/openmanagemanuals > OpenManage Essentials
	For information about installing, using, and troubleshooting Dell OpenManage Enterprise, see the Dell OpenManage Enterprise User's Guide.	www.dell.com/openmanagemanuals > OpenManage Enterprise
	For information about installing and using Dell SupportAssist, see the Dell EMC SupportAssist Enterprise User's Guide.	www.dell.com/serviceabilitytools
	For information about partner programs enterprise systems management, see the OpenManage Connections Enterprise Systems Management documents.	www.dell.com/openmanagemanuals
Working with the Dell PowerEdge RAID controllers	For information about understanding the features of the Dell PowerEdge RAID controllers (PERC), Software RAID controllers, or BOSS card and deploying the cards, see the Storage controller documentation.	www.dell.com/storagecontrollermanuals
Understanding event and error messages	For information about the event and error messages that are generated by the system firmware and agents that monitor system components, see the Error Code Lookup.	www.dell.com/qrl
Troubleshooting your system	For information about identifying and troubleshooting the PowerEdge server issues, see the Server Troubleshooting Guide.	www.dell.com/poweredgemanuals

Technical specifications

System dimensions

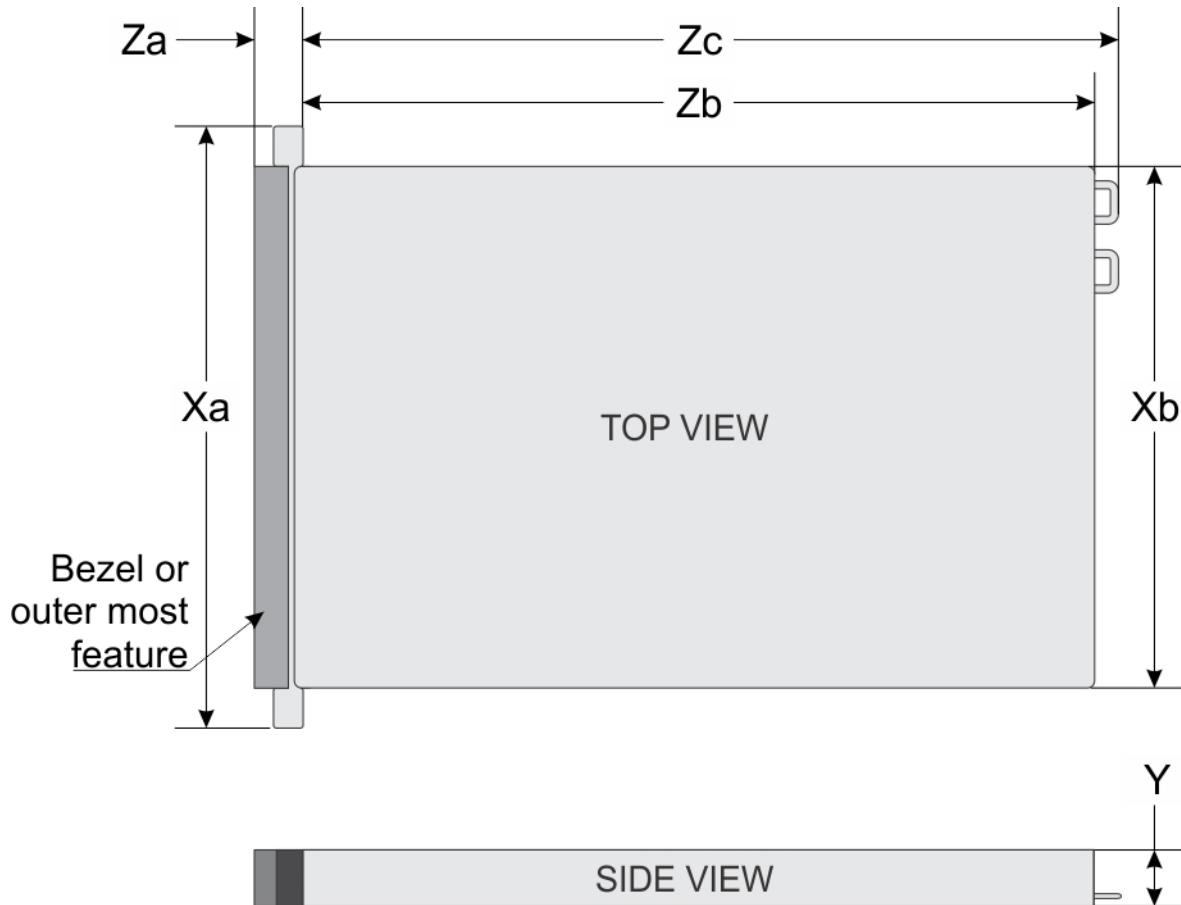

Figure 19. System dimensions

Table 19. Dimensions

System	Xa	Xb	Y	Za (with bezel)	Za (without bezel)	Zb*	Zc
4 x 3.5-inches or 10 x 2.5-inches	482.0 mm (18.97-inches)	434.0 mm (17.08-inches)	42.8 mm (1.68-inches)	35.84 mm (1.41-inches)	22.0 mm (0.87-inches)	733.82 mm (29.61-inches)	772.67 mm (30.42-inches)
8 x 2.5-inches	482.0 mm (18.97-inches)	434.0 mm (17.08-inches)	42.8 mm (1.68-inches)	35.84 mm (1.41-inches)	22.0 mm (0.87-inches)	683.05 mm (26.89-inches)	721.91 mm (28.42-inches)

Chassis weight

Table 20. Chassis weight

System	Maximum weight (with all hard drives/SSDs)
PowerEdge R640	21.9 kg (48.28 lbs)

Processor specifications

The PowerEdge R640 system supports two Intel Xeon Scalable Processors, up to 28 cores per processor.

Supported operating systems

The Dell EMC PowerEdge R640 supports the following operating systems:

- Canonical Ubuntu LTS
- Citrix XenServer
- Enterprise Linux
- Microsoft Windows Server with Hyper-V Red Hat
- SUSE Linux Enterprise Server VMware ESXi

NOTE: For more information about the specific versions and additions, go to Dell.com/support/home/Drivers/SupportedOS/poweredge-r640.

Cooling fan specifications

The cooling fans are integrated into the system to dissipate the heat generated by the functioning of the system. These fans provide cooling for the processors, expansion cards, and memory modules.

Your system supports up to eight standard or high performance cooling fans.

NOTE:

- **High performance fans can be identified by a blue label on top of the cooling fan.**
- **Mixing of standard and high performance cooling fans is not supported.**
- **Each fan is listed in the systems management software, referenced by the respective fan number. If there is a problem with a particular fan, you can easily identify and replace the proper fan by noting the fan number on the system.**

PSU specifications

The PowerEdge R640 system supports up to two AC or DC power supply units (PSUs).

Table 21. PSU specifications

PSU	Class	Heat dissipation (maximum)	Frequency	Voltage
495 W AC	Platinum	1908 BTU/hr	50/60 Hz	100–240 V AC, autoranging
750 W AC	Platinum	2891 BTU/hr	50/60 Hz	100–240 V AC, autoranging
750 W Mixed Mode AC	Platinum	2902 BTU/hr	50/60 Hz	100–240 V AC, 10 A - 5 A
750 W AC	Titanium	2843 BTU/hr	50/60 Hz	200–240 V AC, autoranging

PSU	Class	Heat dissipation (maximum)	Frequency	Voltage
750 W Mixed Mode HVDC (for China only)		2891 BTU/hr	50/60 Hz	100–240 V AC and 240 V DC
750 W Mixed Mode DC (for China only)	Platinum	2902 BTU/hr	50/60 Hz	240 V DC, 4.5 A
1100 W DC	Gold	4416 BTU/hr	50/60 Hz	–(48–60) V DC
1100 W Mixed Mode HVDC (for China and Japan only)	Platinum	4100 BTU/hr	50/60 Hz	100–240 V AC and 200–380 V DC
1100 W AC	Platinum	4100 BTU/hr	50/60 Hz	100–240 V AC, autoranging
1600 W AC		6000 BTU/hr	50/60 Hz	100–240 V AC, autoranging

- NOTE:** If a system with 1100 W AC or HVDC PSU operates from 100 to 120V, the power rating per PSU is derated to 1050 W.
- NOTE:** If a system with 1600 W PSUs operates from 100 to 120 V, then the power rating per PSU is derated to 800 W.
- NOTE:** Heat dissipation is calculated using the PSU wattage rating.
- NOTE:** This system is also designed to connect to the IT power systems with a phase to phase voltage not exceeding 230 V.
- NOTE:** PSUs rated for 1600 W and higher require high-line voltage (200-240 V) to supply their rated capacity.

System battery specifications

The PowerEdge R640 system supports CR 2032 lithium coin cell system battery.

Expansion bus specifications

The PowerEdge R640 system supports PCI express (PCIe) generation 3 expansion cards, which are installed on the system, using expansion card risers. This system supports 1A, 2A, 1B, and 2B expansion card risers.

Memory specifications

Table 22. Memory specifications

DIMM type	DIMM rank	DIMM capacity	Single processor		Dual processors	
			Minimum RAM	Maximum RAM	Minimum RAM	Maximum RAM
LRDIMM	Octa rank	512 GB	512 GB	6 TB	1024 GB	12 TB
		256 GB	256 GB	3 TB	512 GB	6 TB
		128 GB	128 GB	1.5 TB	256 GB	3 TB
RDIMM	Quad rank	64 GB	64 GB	768 GB	128 GB	1.5 TB
	Single rank	8 GB	8 GB	96 GB	16 GB	192 GB
		16 GB	16 GB	192 GB	32 GB	384 GB
		32 GB	32 GB	384 GB	64 GB	768 GB
Dual rank	64 GB	64 GB	768 GB	128 GB	1536 GB	

DIMM type	DIMM rank	DIMM capacity	Single processor		Dual processors	
			Minimum RAM	Maximum RAM	Minimum RAM	Maximum RAM
NVDIMM-N	Single rank	16 GB	Not supported with single processor	Not supported with single processor	RDIMM: 192 GB	RDIMM: 384 GB
					NVDIMM-N: 16 GB	NVDIMM-N: 192 GB
DCPMM	NA	128 GB	RDIMM: 192GB	RDIMM: 384 GB	RDIMM: 384 GB	LRDIMM: 1536 GB
			DCPMM: 128 GB	DCPMM: 128 GB	DCPMM: 1536 GB	DCPMM: 1536 GB
	NA	256 GB	NA	NA	RDIMM: 384 GB	LRDIMM: 1536 GB
			NA	NA	DCPMM: 2048 GB	DCPMM: 3072 GB
	NA	512 GB	NA	NA	RDIMM: 384 GB	RDIMM: 1536 GB
			NA	NA	DCPMM: 4096 GB	DCPMM: 6144 GB

- NOTE: 8 GB RDIMMs and NVDIMM-N must not be mixed.**
- NOTE: Minimum of two CPUs are required for any configurations that support NVDIMM-N.**
- NOTE: DCPMM can be mixed with RDIMMs and LRDIMMs.**
- NOTE: Mixing of DDR4 DIMM Types (RDIMM, LRDIMM), within channel, integrated memory controller, socket, or across sockets is not supported.**
- NOTE: x4 and X8 DDR4 DIMM can be mixed within channel.**
- NOTE: Mix of Intel DCPMM operating modes (App Direct, Memory Mode) is not supported within socket or across sockets.**

Storage controller specifications

The PowerEdge R640 system supports:

- **Internal storage controller cards:** PowerEdge RAID Controller (PERC) H330, H730p, H740p, Software RAID (SWRAID) S140.
- **Boot Optimized Storage Subsystem:** HWRAID 2 x M.2 SSDs 120GB, 240 GB.
 - The card supports up to two 6 Gbps M.2 SATA drives. The BOSS adapter card has a x8 connector using PCIe gen 2.0 x2 lanes, available only in the low-profile and half-height form factor.
- **External PERC (RAID):** H840
- **12Gbps SAS HBAs (non-RAID):**
 - External- 12Gbps SAS HBA (non-RAID)
 - Internal- HBA330 (non-RAID)

Drives

Hard drive specifications

The PowerEdge R640 supports:

- Up to ten 2.5 inch, hot swappable SAS, SATA, SAS/SATA SSD, NVMe (up to 8x) or Nearline SAS hard drives with up to 2 x 2.5 inch hot swappable SAS, SATA, SAS/SATA SSD, NVMe or Nearline SAS hard drives supported at the back of the system
- Up to eight 2.5 inch, hot swappable SAS, SATA, SAS/SATA SSD, or Nearline SAS hard drives
- Up to four 3.5 inch, hot swappable hard drives with up to 2 x 2.5 inch hot swappable SAS, SATA, SAS/SATA SSD, or Nearline SAS hard drives supported at the back of the system

Optical drive

Certain configurations of the system support one optional SATA DVD-ROM drive or DVD+/-RW drive.

NOTE: The optical drive is supported in both 4 x 3.5 and 8 x 2.5 inch hard drive systems.

Ports and connectors specifications

USB ports

The PowerEdge R640 system supports:

The following table provides more information about the USB specifications:

Table 23. USB specifications

System	Front panel	Back panel	Internal
Four hard drive systems	One 4-pin, USB 2.0-compliant ports	Two 9-pin, USB 3.0-compliant ports	One 9-pin, USB 3.0-compliant ports
	One 5-pin micro USB 2.0 management port	N/A	N/A
	NOTE: The micro USB 2.0-compliant port on the front panel can only be used as an iDRAC Direct or a management port.		
Eight hard drive systems	One 4-pin, USB 2.0-compliant ports	Two 9-pin, USB 3.0-compliant ports	One 9-pin, USB 3.0-compliant ports
	One 5-pin micro USB 2.0 management port	N/A	N/A
	NOTE: One optional USB 3.0-compliant port on the front panel for 4 x 3.5 and 8 x 2.5 inch hard drive systems.		
Ten hard drive systems	One 4-pins, USB 2.0-compliant port	Two 9-pin, USB 3.0-compliant ports	One 9-pin, USB 3.0-compliant ports
	One 5-pin micro USB 2.0 management port	N/A	N/A

NIC ports

The PowerEdge R640 system supports four Network Interface Controller (NIC) ports on the back panel, which are available in the following configurations:

- Four RJ-45 ports that support 10, 100 and 1000 Mbps
- Four RJ-45 ports that support 100 M, 1 G and 10 Gbps
- Four RJ-45 ports, where two ports support maximum of 10 G and the other two ports maximum of 1 Gbps
- Two RJ-45 ports that support up to 1 Gbps and 2 SFP+ ports that support up to 10 Gbps
- Four SFP+ ports that support up to 10 Gbps
- Two SFP28 ports that support up to 25 Gbps

NOTE: You can install up to three PCIe add-on NIC cards.

Serial port

The PowerEdge R640 system supports one serial port on the back panel. This port is a 9-pin connector, Data Terminal Equipment (DTE), 16550-compliant.

VGA ports

The Video Graphic Array (VGA) port enables you to connect the system to a VGA display. The PowerEdge R640 system supports one 15-pin VGA port on the front and back of system.

Video specifications

The PowerEdge R640 system supports integrated Matrox G200eW3 graphics controller with 16 MB of video frame buffer .

Table 24. Supported video resolution options

Resolution	Refresh rate (Hz)	Color depth (bits)
640 x 480	60, 70	8, 16, 32
800 x 600	60, 75, 85	8, 16, 32
1024 x 768	60, 75, 85	8, 16, 32
1152 x 864	60, 75, 85	8, 16, 32
1280 x 1024	60, 75	8, 16, 32
1440 x 900	60	8, 16, 32
1920 x 1200	60	8, 16, 32

IDSDM or vFlash card

The PowerEdge R640 system supports Internal Dual SD module (IDSDM) and vFlash card. In the 14th generation of PowerEdge servers, IDSDM and vFlash card are combined into a single module, and are available in the following options:

- vFlash or
- vFlash and IDSDM

The IDSDM/vFlash card can be connected in a Dell-proprietary PCIe x1 slot using a USB 3.0 interface to host. IDSDM/vFlash module supports two MicroSD cards for IDSDM and one card for vFlash. The MicroSD card capacity for IDSDM are 16, 32, or 64 GB, while for vFlash the MicroSD card capacity is 16 GB. The IDSDM or vFlash module combines the IDSDM or vFlash features into a single module.

NOTE: There are two dip switches on the IDSDM/vFlash card for write-protection.

NOTE: One IDSDM card slot is dedicated for redundancy.

NOTE: It is recommended to use Dell branded MicroSD cards associated with the IDSDM/vFlash configured systems.

Environmental specifications

NOTE: For additional information about environmental certifications, please refer to the Product Environmental Datasheet located with the Manuals & Documents on www.dell.com/poweredgemanuals

Table 25. Temperature specifications

Temperature	Specifications
Storage	–40°C to 65°C (–40°F to 149°F)
Continuous operation (for altitude less than 950 m or 3117 ft)	10°C to 35°C (50°F to 95°F) with no direct sunlight on the equipment.

Temperature

Specifications

	<p>i NOTE: Maximum of 205 W, 28 core processor is supported in systems with eight 2.5 inch processor direct attached PCIe SSD drives, and three PCIe slot chassis.</p> <p>i NOTE: Certain configurations may have ambient temperature restrictions. For more information see the Ambient temperature limitations section.</p>
Fresh air	For information about fresh air, see Expanded Operating Temperature section.
Maximum temperature gradient (operating and storage)	20°C/h (68°F/h)

Table 26. Relative humidity specifications

Relative humidity	Specifications
Storage	5% to 95% RH with 33°C (91°F) maximum dew point. Atmosphere must be non-condensing at all times.
Operating	10% to 80% relative humidity with 29°C (84.2°F) maximum dew point.

Table 27. Maximum vibration specifications

Maximum vibration	Specifications
Operating	0.26 G _{rms} at 5 Hz to 350 Hz (all operation orientations).
Storage	1.88 G _{rms} at 10 Hz to 500 Hz for 15 min (all six sides tested).

Table 28. Maximum shock specifications

Maximum shock	Specifications
Operating	Six consecutively executed shock pulses in the positive and negative x, y, and z axes of 6 G for up to 11 ms.
Storage	Six consecutively executed shock pulses in the positive and negative x, y, and z axes (one pulse on each side of the system) of 71 G for up to 2 ms.

Table 29. Maximum altitude specifications

Maximum altitude	Specifications
Operating	3048 m (10,000 ft)
Storage	12,000 m (39,370 ft)

Table 30. Operating temperature de-rating specifications

Operating temperature de-rating	Specifications
Up to 35°C (95°F)	Maximum temperature is reduced by 1°C/300 m (1°F/547 ft) above 950 m (3,117 ft).
35°C to 40°C (95°F to 104°F)	Maximum temperature is reduced by 1°C/175 m (1°F/319 ft) above 950 m (3,117 ft).
40°C to 45°C (104°F to 113°F)	Maximum temperature is reduced by 1°C/125 m (1°F/228 ft) above 950 m (3,117 ft).

Standard operating temperature

Table 31. Standard operating temperature specifications

Standard operating temperature	Specifications
Continuous operation (for altitude less than 950 m or 3117 ft)	10°C to 35°C (50°F to 95°F) with no direct sunlight on the equipment.

Expanded operating temperature

Table 32. Expanded operating temperature specifications

Expanded operating temperature	Specifications
Continuous operation	5°C–40°C at 5% to 85% RH with 29°C dew point. i NOTE: Outside the standard operating temperature (10°C–35°C), the system can operate continuously in temperatures as low as 5°C and as high as 40°C. For temperatures between 35°C–40°C, de-rate maximum allowable temperature by 1°C per 175 m above 950 m (1°F per 319 ft).
≤ 1% of annual operating hours	–5°C–45°C at 5% to 90% RH with 29°C dew point. i NOTE: Outside the standard operating temperature (10°C–35°C), the system can operate down to –5°C or up to 45°C for a maximum of 1% of its annual operating hours. For temperatures between 40°C and 45°C, de-rate maximum allowable temperature by 1°C per 125 m above 950 m (1°F per 228 ft).

i **NOTE: When operating in the expanded temperature range, system performance may be impacted.**

i **NOTE: When operating in the expanded temperature range, ambient temperature warnings may be reported on the LCD panel and in the System Event Log.**

Expanded operating temperature restrictions

- Do not perform a cold startup below 5°C.
- The operating temperature specified is for a maximum altitude of 3050 m (10,000 ft).
- 150 W/8 C, 165 W/12 C and higher wattage processor(TDP>165 W) are not supported.
- Redundant power supply unit is required.
- Non-Dell qualified peripheral cards and/or peripheral cards greater than 25 W are not supported.
- NVDIMM-Ns are not supported.
- DCPMMs are not supported.
- GPU is not supported.
- PCIe SSD is not supported.
- Rear installed drives are not supported
- Tape backup unit is not supported.

Thermal restrictions

The following table lists the configurations required for efficient cooling.

Table 33. Thermal restrictions configuration

Configuration	Number of processors	Heatsink	Processor/DIMM blank	DIMM blanks	Maximum number of DIMM blanks	Fan
PowerEdge R640 (2.5 inch hard drives x 10)	1	One 1U standard heat sink for CPU ≤ 165 W	Not required			Five standard fans
		One 1U 2-pipe heat sink for CPU=200/205 W and 150 W/165 W FO*	Required	Required for processor 1	11 blanks	Eight high performance fans
	2	Two 1U standard heat sink for CPU ≤ 165 W				Eight standard fans
PowerEdge R640 (2.5 inch hard drives x 10 with NVMe drives)	2	Two 1U 2-pipe heat sink for CPU=200/205 W and 150 W/165 W FO*	Not required	Required	22 blanks	Eight high performance fans
		Two 1U standard heat sink for CPU ≤ 165 W				
PowerEdge R640 (2.5 inch hard drives x 8) (3.5 inch hard drives x 4)	1	One 1U standard heat sink for CPU ≤ 165 W	Not required			Five standard fans
		One 1U 2-pipe heat sink for CPU=150 W/165 W FO*	Required			
	2	One 1U 2-pipe heat sink for CPU=200/205 W		Required for processor 1	11 blanks	Eight high performance fans
		Two 1U standard heat sink for CPU ≤ 165 W	Required			Eight standard fans
PowerEdge R640 (3.5 inch hard drives x 4 with NVMe drives x 2 in the rear)	2	Two 1U 2-pipe heat sink for CPU=150 W/165 W FO*	Not required			Eight high performance fans
		Two 1U 2-pipe heat sink for CPU=200/205 W	Not required	Required	22 blanks	
		Two 1U standard heat sink for CPU ≤ 165 W				
		Two 1U 2-pipe heat sink for CPU=155 W/165 W FO*	Not required	Required	22 blanks	Eight standard fans
		Two 1U 2-pipe heat sink for CPU=200/205W				

NOTE: *165 W and 150 W FO includes Intel Xeon Gold 6146, 6144, 6244 and 6246 processors.

Table 34. DCPMM thermal restrictions configuration

Configuration	TDP	Maximum ambient temperature	Fan requirement	Heatsink Requirement
PowerEdge R640		30°C		
2.5 inch x10 hard drives (PCIe x3)	200/205 W 155/165 W FO*	35°C		
3.5 inch x4 hard drives (PCIe x2/x3)	165 W Gold 6146 150 W 6144 and 6244	35°C	High performance fans	High performance heat sink
2.5 inch x8 hard drives (PCIe x3/x2)	150 W Gold 6240Y	35°C		
PowerEdge R640				
2.5 inch x10 hard drives (PCIe x3)				
3.5 inch x4 hard drives (PCIe x2/x3)	70 to 165 W	35°C	High performance fans	High performance heat sink
2.5 inch x8 hard drives (PCIe x3/x2)				

NOTE: When installing DCPMMs for systems that support 200W or higher wattage processors, the ambient temperature of 30°C must be adhered to ensure proper cooling and to avoid excess processor throttling, which may impact system performance.

Table 35. GPU thermal restrictions configuration

TDP(Watts)	PowerEdge R640 2.5 inch hard drives x 10 x2GPU in slot 1,3		PowerEdge R640 (2.5 inch hard drives x 8 x3GPU)	
	Thermal restriction at 30°C	Thermal restriction at 35°C	Thermal restriction at 30°C	Thermal restriction at 35°C
200/205 W				
155/165 W FO*	High performance fans and High performance heat sink required	Not supported	High performance fans and High performance heat sink required	Not supported
165 W Gold 6146				
150 W 6144 and 6244				
150 W Gold 6240Y				
70 to 165 W	High performance fans and standard heat sink required	Not supported	High performance fans and standard heat sink required	Not supported

NOTE: PowerEdge R640 does not support x3 GPU T4 (PPGXG) in 2.5 inch x10 hard drive chassis.

Ambient temperature limitations

The following table lists configurations that require ambient temperature less than 35°C.

NOTE: The ambient temperature limit must be adhered to ensure proper cooling and to avoid excess processor throttling, which may impact system performance.

Table 36. Configuration based ambient temperature restrictions

System	Front Backplane	Processor Thermal Design Power	Processor Heat Sink	Fan Type	Ambient Restriction
PowerEdge R640	10 x 2.5 inch SAS/SATA hard drives	200 W, 205 W	2 pipe 1U high performance	High performance fan	30°C

System	Front Backplane	Processor Thermal Design Power	Processor Heat Sink	Fan Type	Ambient Restriction
	8 x 2.5 inch SAS/ SATA hard drives				
	4 x 3.5 inch SAS/ SATA hard drives				
	10 x 2.5 inch SAS/ SATA and NVMe drives(4, 8, or 10)	165 W 200 W, 205 W	2 pipe 1U standard 2 pipe 1U high performance	High performance fan	30°C

Particulate and gaseous contamination specifications

The following table defines the limitations that help avoid any equipment damage or failure from particulate and gaseous contamination. If the levels of particulate or gaseous pollution exceed the specified limitations and result in equipment damage or failure, you may need to rectify the environmental conditions. Remediation of environmental conditions is the responsibility of the customer.

Table 37. Particulate contamination specifications

Particulate contamination	Specifications
Air filtration	Data center air filtration as defined by ISO Class 8 per ISO 14644-1 with a 95% upper confidence limit. <i>i</i> NOTE: This condition applies to data center environments only. Air filtration requirements do not apply to IT equipment designed to be used outside a data center, in environments such as an office or factory floor. <i>i</i> NOTE: Air entering the data center must have the MERV11 or MERV13 filtration.
Conductive dust	Air must be free of conductive dust, zinc whiskers, or other conductive particles. <i>i</i> NOTE: This condition applies to data center and non-data center environments.
Corrosive dust	<ul style="list-style-type: none"> Air must be free of corrosive dust. Residual dust present in the air must have a deliquescent point less than 60% relative humidity. <i>i</i> NOTE: This condition applies to data center and non-data center environments.

Table 38. Gaseous contamination specifications

Gaseous contamination	Specifications
Copper coupon corrosion rate	<300 Å/month per Class G1 as defined by ANSI/ISA71.04-1985.
Silver coupon corrosion rate	<200 Å/month as defined by AHSRAE TC9.9.

i **NOTE: Maximum corrosive contaminant levels measured at ≤50% relative humidity.**

Initial system setup and configuration

Setting up your system

Perform the following steps to set up your system:

Steps

1. Unpack the system.
2. Install the system into the rack. For more information about installing the system into the rack, see the *Rail Installation Guide* at www.dell.com/poweredgemanuals.
3. Connect the peripherals to the system.
4. Connect the system to its electrical outlet.
5. Power on the system by pressing the power button or by using iDRAC.
6. Power on the attached peripherals.

For more information about setting up your system, see the *Getting Started Guide* that shipped with your system.

iDRAC configuration

The Integrated Dell Remote Access Controller (iDRAC) is designed to make system administrators more productive and improve the overall availability of Dell systems. iDRAC alerts administrators about system issues and enables them to perform remote system management. This reduces the need for physical access to the system.

Options to set up iDRAC IP address

To enable communication between your system and iDRAC, you must first configure the network settings based on your network infrastructure.

NOTE: For static IP configuration, you must request for it at the time of purchase.

This option is set to **DHCP** by Default. You can set up the IP address by using one of the following interfaces:

Interfaces	Document/Section
iDRAC Settings utility	<i>Dell Integrated Dell Remote Access Controller User's Guide</i> at www.dell.com/poweredgemanuals
Dell Deployment Toolkit	<i>Dell Deployment Toolkit User's Guide</i> at www.dell.com/openmanagemanuals > OpenManage Deployment Toolkit
Dell Lifecycle Controller	<i>Dell Lifecycle Controller User's Guide</i> at www.dell.com/poweredgemanuals
Server LCD panel	LCD panel section
iDRAC Direct and Quick Sync 2 (optional)	See <i>Dell Integrated Dell Remote Access Controller User's Guide</i> at www.dell.com/poweredgemanuals

NOTE: To access iDRAC, ensure that you connect the ethernet cable to the iDRAC9 dedicated network port. You can also access iDRAC through the shared LOM mode, if you have opted for a system that has the shared LOM mode enabled.

Log in to iDRAC

You can log in to iDRAC as:

- iDRAC user
- Microsoft Active Directory user
- Lightweight Directory Access Protocol (LDAP) user

If you have opted for secure default access to iDRAC, you must use the iDRAC secure default password available on the system Information tag. If you have not opted for secure default access to iDRAC, then use the default user name and password `-root` and `ca1v1n`. You can also log in by using your Single Sign-On or Smart Card.

NOTE: You must have the iDRAC credentials to log in to iDRAC.

NOTE: Ensure that you change the default username and password after setting up the iDRAC IP address.

For more information about logging in to the iDRAC and iDRAC licenses, see the latest *Integrated Dell Remote Access Controller User's Guide* at www.dell.com/poweredgemanuals.

You can also access iDRAC by using RACADM. For more information, see the *RACADM Command Line Interface Reference Guide* at www.dell.com/poweredgemanuals.

Options to install the operating system

If the system is shipped without an operating system, install a supported operating system by using one of the following resources:

Table 39. Resources to install the operating system

Resources	Location
iDRAC	www.dell.com/idracmanuals
Lifecycle Controller	www.dell.com/idracmanuals > Lifecycle Controller
OpenManage Deployment Toolkit	www.dell.com/openmanagemanuals > OpenManage Deployment Toolkit
Dell certified VMware ESXi	www.dell.com/virtualizationsolutions
Installation and How-to videos for supported operating systems on PowerEdge systems	Supported Operating Systems for Dell EMC PowerEdge systems

Methods to download firmware and drivers

You can download the firmware and drivers by using any of the following methods:

Table 40. Firmware and drivers

Methods	Location
From the Dell EMC support site	www.dell.com/support/home
Using Dell Remote Access Controller Lifecycle Controller (iDRAC with LC)	www.dell.com/idracmanuals
Using Dell Repository Manager (DRM)	www.dell.com/openmanagemanuals > Repository Manager
Using Dell OpenManage Essentials	www.dell.com/openmanagemanuals > OpenManage Essentials
Using Dell OpenManage Enterprise	www.dell.com/openmanagemanuals > OpenManage Enterprise
Using Dell Server Update Utility (SUU)	www.dell.com/openmanagemanuals > Server Update Utility
Using Dell OpenManage Deployment Toolkit (DTK)	www.dell.com/openmanagemanuals > OpenManage Deployment Toolkit
Using iDRAC virtual media	www.dell.com/idracmanuals

Downloading drivers and firmware

Dell EMC recommends that you download and install the latest BIOS, drivers, and systems management firmware on your system.

Prerequisites

Ensure that you clear the web browser cache before downloading the drivers and firmware.

Steps

1. Go to www.dell.com/support/home.
2. In the **Drivers & Downloads** section, type the Service Tag of your system in the **Enter a Service Tag or product ID** box, and then click **Submit**.



NOTE: If you do not have the Service Tag, select Detect Product to allow the system to automatically detect the Service Tag, or click View products, and navigate to your product.

3. Click **Drivers & Downloads**.
The drivers that are applicable to your system are displayed.
4. Download the drivers to a USB drive, CD, or DVD.

Pre-operating system management applications

You can manage basic settings and features of a system without booting to the operating system by using the system firmware.

Topics:

- [Options to manage the pre-operating system applications](#)
- [System Setup](#)
- [Dell Lifecycle Controller](#)
- [Boot Manager](#)
- [PXE boot](#)

Options to manage the pre-operating system applications

Your system has the following options to manage the pre-operating system applications:

- System Setup
- Dell Lifecycle Controller
- Boot Manager
- Preboot Execution Environment (PXE)

System Setup

By using the **System Setup** screen, you can configure the BIOS settings, iDRAC settings, and device settings of your system.

i **NOTE:** Help text for the selected field is displayed in the graphical browser by default. To view the help text in the text browser, press F1.

You can access system setup by one of the following:

- Standard graphical browser—The browser is enabled by default.
- Text browser—The browser is enabled by using Console Redirection.

Viewing System Setup

To view the **System Setup** screen, perform the following steps:

Steps

1. Power on, or restart your system.
2. Press F2 immediately after you see the following message:

```
F2 = System Setup
```

i **NOTE:** If your operating system begins to load before you press F2, wait for the system to finish booting, and then restart your system and try again.

System Setup details

The **System Setup Main Menu** screen details are explained as follows:

Option	Description
System BIOS	Enables you to configure BIOS settings.
iDRAC Settings	Enables you to configure the iDRAC settings. The iDRAC settings utility is an interface to set up and configure the iDRAC parameters by using UEFI (Unified Extensible Firmware Interface). You can enable or disable various iDRAC parameters by using the iDRAC settings utility. For more information about this utility, see <i>Integrated Dell Remote Access Controller User's Guide</i> at www.dell.com/poweredgemanuals .
Device Settings	Enables you to configure device settings.

System BIOS

You can use the **System BIOS** screen to edit specific functions such as boot order, system password, and setup password, set the SATA and PCIe NVMe RAID mode, and enable or disable USB ports.

Viewing System BIOS

To view the **System BIOS** screen, perform the following steps:

Steps

1. Power on, or restart your system.
2. Press F2 immediately after you see the following message:

```
F2 = System Setup
```

NOTE: If the operating system begins to load before you press F2, wait for the system to finish booting, and then restart the system and try again.

3. On the **System Setup Main Menu** screen, click **System BIOS**.

System BIOS Settings details

About this task

The **System BIOS Settings** screen details are explained as follows:

Option	Description
System Information	Provides information about the system such as the system model name, BIOS version, and Service Tag.
Memory Settings	Provides information and options related to the installed memory.
Processor Settings	Provides information and options related to the processor such as speed and cache size.
SATA Settings	Provides options to enable or disable the integrated SATA controller and ports.
NVMe Settings	Provides options to change the NVMe settings. If the system contains the NVMe drives that you want to configure in a RAID array, you must set both this field and the Embedded SATA field on the SATA Settings menu to RAID mode. You might also need to change the Boot Mode setting to UEFI . Otherwise, you should set this field to Non-RAID mode.
Boot Settings	Provides options to specify the Boot mode (BIOS or UEFI). Enables you to modify UEFI and BIOS boot settings.
Network Settings	Provides options to manage the UEFI network settings and boot protocols. Legacy network settings are managed from the Device Settings menu.
Integrated Devices	Provides options to manage integrated device controllers and ports, specifies related features and options.
Serial Communication	Provides options to manage the serial ports, their related features and options.

Option	Description
System Profile Settings	Provides options to change the processor power management settings, and memory frequency.
System Security	Provides options to configure the system security settings, such as system password, setup password, Trusted Platform Module (TPM) security, and UEFI secure boot. It also manages the power button on the system.
Redundant OS Control	Sets the redundant OS information for redundant OS control.
Miscellaneous Settings	Provides options to change the system date and time.

System Information

You can use the **System Information** screen to view system properties such as Service Tag, system model name, and BIOS version.

Viewing System Information

To view the **System Information** screen, perform the following steps:

Steps

1. Power on, or restart your system.
2. Press F2 immediately after you see the following message:

```
F2 = System Setup
```

NOTE: If your operating system begins to load before you press F2, wait for the system to finish booting, and then restart your system and try again.

3. On the **System Setup Main Menu** screen, click **System BIOS**.
4. On the **System BIOS** screen, click **System Information**.

System Information details

About this task

The **System Information** screen details are explained as follows:

Option	Description
System Model Name	Specifies the system model name.
System BIOS Version	Specifies the BIOS version installed on the system.
System Management Engine Version	Specifies the current version of the Management Engine firmware.
System Service Tag	Specifies the system Service Tag.
System Manufacturer	Specifies the name of the system manufacturer.
System Manufacturer Contact Information	Specifies the contact information of the system manufacturer.
System CPLD Version	Specifies the current version of the system complex programmable logic device (CPLD) firmware.

Option	Description
UEFI Compliance Version	Specifies the UEFI compliance level of the system firmware.

Memory Settings

You can use the **Memory Settings** screen to view all the memory settings and enable or disable specific memory functions, such as system memory testing and node interleaving.

Viewing Memory Settings

To view the **Memory Settings** screen, perform the following steps:

Steps

1. Power on, or restart your system.
2. Press F2 immediately after you see the following message:

```
F2 = System Setup
```

NOTE: If the operating system begins to load before you press F2, wait for the system to finish booting, and then restart the system and try again.

3. On the **System Setup Main Menu** screen, click **System BIOS**.
4. On the **System BIOS** screen, click **Memory Settings**.

Memory Settings details

About this task

The **Memory Settings** screen details are explained as follows:

Option	Description
System Memory Size	Specifies the memory size in the system.
System Memory Type	Specifies the type of memory that is installed in the system.
System Memory Speed	Specifies the system memory speed.
System Memory Voltage	Specifies the system memory voltage.
Video Memory	Specifies the amount of video memory.
System Memory Testing	Specifies whether the system memory tests are run during system boot. Options are Enabled and Disabled . This option is set to Disabled by default.
Memory Operating Mode	Specifies the memory operating mode. The options available are Optimizer Mode , Single Rank Spare Mode , Multi Rank Spare Mode , Mirror Mode , and Dell Fault Resilient Mode . This option is set to Optimizer Mode by default. <p>NOTE: The Memory Operating Mode option can have different default and available options based on the memory configuration of your system.</p> <p>NOTE: The Dell Fault Resilient Mode option establishes an area of memory that is fault resilient. This mode can be used by an operating system that supports the feature to load critical applications or enables the operating system kernel to maximize system availability.</p>
Current State of Memory Operating Mode	Specifies the current state of the memory operating mode.

Option	Description
Node Interleaving	Specifies if Non-Uniform Memory Architecture (NUMA) is supported. If this field is set to Enabled , memory interleaving is supported if a symmetric memory configuration is installed. If this field is set to Disabled , the system supports NUMA (asymmetric) memory configurations. This option is set to Disabled by default.
ADDDC Setting	Enables or disables ADDDC Setting feature. When Adaptive Double DRAM Device Correction (ADDDC) is enabled, failing DRAM's are dynamically mapped out. When set to Enabled it can have some impact to system performance under certain workloads. This feature is applicable for x4 DIMMs only. This option is set to Enabled by default.
Native tRFC Timing for 16Gb DIMMs	Enables 16 Gb density DIMMs to operate at their programmed Row Refresh Cycle Time (tRFC). Enabling this feature may improve system performance for some configurations. However, enabling this feature has no effect on configurations with 16 Gb 3DS/TSV DIMMs. This option is set to Disabled by default.
Opportunistic Self-Refresh	Enables or disables opportunistic self-refresh feature. This option is set to Disabled by default.
Persistent Memory	This field controls Persistent Memory on the system. This option is only available if the persistent memory module is installed in the system.

Persistent Memory details

About this task

The **Persistent Memory** screen details can be found in the *NVDIMM-N User Guide* and *DCPMM User Guide* at www.dell.com/poweredge/manuals.

Processor Settings

You can use the **Processor Settings** screen to view the processor settings and perform specific functions such as enabling virtualization technology, hardware prefetcher, logical processor idling.

Viewing Processor Settings

To view the **Processor Settings** screen, perform the following steps:

Steps

1. Power on, or restart your system.
2. Press F2 immediately after you see the following message:

```
F2 = System Setup
```

NOTE: If your operating system begins to load before you press F2, wait for the system to finish booting, and then restart your system and try again.



3. On the **System Setup Main Menu** screen, click **System BIOS**.
4. On the **System BIOS** screen, click **Processor Settings**.

Processor Settings details

About this task

The **Processor Settings** screen details are explained as follows:

Option	Description
Logical Processor	Enables or disables the logical processors and displays the number of logical processors. If this option is set to Enabled , the BIOS displays all the logical processors. If this option is set to Disabled , the BIOS displays only one logical processor per core. This option is set to Enabled by default.
CPU Interconnect Speed	Enables you to govern the frequency of the communication links among the processors in the system. NOTE: The standard and basic bin processors support lower link frequencies.

Option	Description
	<p>The options available are Maximum data rate, 10.4 GT/s, and 9.6 GT/s. This option is set to Maximum data rate by default.</p> <p>Maximum data rate indicates that the BIOS runs the communication links at the maximum frequency that is supported by the processors. You can also select specific frequencies that the processors support, which can vary.</p> <p>For best performance, you should select Maximum data rate. Any reduction in the communication link frequency affects the performance of non-local memory accesses and cache coherency traffic. In addition, it can slow access to non-local I/O devices from a particular processor.</p> <p>However, if power saving considerations outweigh performance, you might want to reduce the frequency of the processor communication links. If you do this, you should localize memory and I/O accesses to the nearest NUMA node to minimize the impact to system performance.</p>
Virtualization Technology	Enables or disables the virtualization technology for the processor. This option is set to Enabled by default.
Adjacent Cache Line Prefetch	Optimizes the system for applications that need high utilization of sequential memory access. This option is set to Enabled by default. You can disable this option for applications that need high utilization of random memory access.
Hardware Prefetcher	Enables or disables the hardware prefetcher. This option is set to Enabled by default.
Software Prefetcher	Enables or disables the software prefetcher. This option is set to Enabled by default.
DCU Streamer Prefetcher	Enables or disables the Data Cache Unit (DCU) streamer prefetcher. This option is set to Enabled by default.
DCU IP Prefetcher	Enables or disables the Data Cache Unit (DCU) IP prefetcher. This option is set to Enabled by default.
Sub NUMA Cluster	Enables or disables the Sub NUMA Cluster. This option is set to Disabled by default.
UPI Prefetch	Enables you to get the memory that is read started early on DDR bus. The Ultra Path Interconnect (UPI) Rx path will spawn the speculative memory that is read to Integrated Memory Controller (iMC) directly. This option is set to Enabled by default.
Logical Processor Idling	Enables you to improve the energy efficiency of a system. It uses the operating system core parking algorithm and parks some of the logical processors in the system which in turn allows the corresponding processor cores to transition into a lower power idle state. This option can only be enabled if the operating system supports it. It is set to Disabled by default.
Configurable TDP	Enables you to configure the TDP level. The available options are Nominal , Level 1 , and Level 2 . This option is set to Nominal by default.  NOTE: This option is only available on certain stock keeping units (SKUs) of the processors.
SST-Performance Profile	Enables you to reconfigure the processor using Speed Select Technology.
x2APIC Mode	Enables or disables the x2APIC mode. This option is set to Enabled by default.
Dell Controlled Turbo	Controls the turbo engagement. Enable this option only when System Profile is set to Disabled .  NOTE: Depending on the number of installed processors, there might be up to two processor listings.
Dell AVX Scaling Technology	Enables you to configure the Dell AVX scaling technology. This option is set to 0 by default.
Number of Cores per Processor	Controls the number of enabled cores in each processor. This option is set to All by default.
Processor Core Speed	Specifies the maximum core frequency of the processor.
Processor Bus Speed	Displays the bus speed of the processor.

Option	Description
Processor n	 NOTE: Depending on the number of processors, there might be up to two processors listed.
The following settings are displayed for each processor that is installed in the system:	
Option	Description
Family-Model-Stepping	Specifies the family, model, and stepping of the processor as defined by Intel.
Brand	Specifies the brand name.
Level 2 Cache	Specifies the total L2 cache.
Level 3 Cache	Specifies the total L3 cache.
Number of Cores	Specifies the number of cores per processor.
Maximum Memory Capacity	Specifies the maximum memory capacity per processor.
Microcode	Specifies the microcode.

SATA Settings

You can use the **SATA Settings** screen to view the settings of SATA devices and enable SATA and PCIe NVMe RAID mode on your system.

Viewing SATA Settings

To view the **SATA Settings** screen, perform the following steps:

Steps

1. Power on, or restart your system.
2. Press F2 immediately after you see the following message:

```
F2 = System Setup
```

 **NOTE:** If your operating system begins to load before you press F2, wait for the system to finish booting, and then restart your system and try again.

3. On the **System Setup Main Menu** screen, click **System BIOS**.
4. On the **System BIOS** screen, click **SATA Settings**.

SATA Settings details

About this task

The **SATA Settings** screen details are explained as follows:

Option	Description
Embedded SATA	Enables the embedded SATA option to be set to AHCI Mode , or RAID Mode . This option is set to AHCI Mode by default.
Security Freeze Lock	Enables you to send Security Freeze Lock command to the embedded SATA drives during POST. This option is applicable only for AHCI mode. This option is set to Enabled by default.
Write Cache	Enables or disables the command for the embedded SATA drives during POST. This option is set to Disabled by default.
Port n	Enables you to set the drive type of the selected device. For AHCI Mode or RAID Mode , BIOS support is always enabled.

Option	Description
Option	Description
Model	Specifies the drive model of the selected device.
Drive Type	Specifies the type of drive attached to the SATA port.
Capacity	Specifies the total capacity of the drive. This field is undefined for removable media devices such as optical drives.

NVMe Settings

The NVMe settings enable you to set the NVMe drives to either **RAID** mode or **Non-RAID** mode.

NOTE: To configure these drives as RAID drives, you must set the NVMe drives and the Embedded SATA option in the SATA Settings menu to RAID mode. If not, you must set this field to Non-RAID mode.

Viewing NVMe Settings

To view the **NVMe Settings** screen, perform the following steps:

Steps

1. Power on, or restart your system.
2. Press F2 immediately after you see the following message:

```
F2 = System Setup
```

NOTE: If your operating system begins to load before you press F2, wait for the system to finish booting, and then restart your system and try again.

3. On the **System Setup Main Menu** screen, click **System BIOS**.
4. On the **System BIOS** screen, click **NVMe Settings**.

NVMe Settings details

About this task

The NVMe Settings screen details are explained as follows:

Option	Description
NVMe Mode	Enables you to set the NVMe mode. This option is set to Non RAID by default.

Boot Settings

You can use the **Boot Settings** screen to set the boot mode to either **BIOS** or **UEFI**. It also enables you to specify the boot order.

- **UEFI:** The Unified Extensible Firmware Interface (UEFI) is a new interface between operating systems and platform firmware. The interface consists of data tables with platform related information, boot and runtime service calls that are available to the operating system and its loader. The following benefits are available when the **Boot Mode** is set to **UEFI**:
 - Support for drive partitions larger than 2 TB.
 - Enhanced security (e.g., UEFI Secure Boot).
 - Faster boot time.
 - **BIOS:** The **BIOS Boot Mode** is the legacy boot mode. It is maintained for backward compatibility.
- NOTE:** You must use only the UEFI boot mode in order to boot from NVMe drives.

Viewing Boot Settings

To view the **Boot Settings** screen, perform the following steps:

Steps

1. Power on, or restart your system.
2. Press F2 immediately after you see the following message:

```
F2 = System Setup
```

NOTE: If your operating system begins to load before you press F2, wait for the system to finish booting, and then restart your system and try again.

3. On the **System Setup Main Menu** screen, click **System BIOS**.
4. On the **System BIOS** screen, click **Boot Settings**.

Boot Settings details

About this task

The **Boot Settings** screen details are explained as follows:

Option	Description
Boot Mode	<p>Enables you to set the boot mode of the system.</p> <p>CAUTION: Switching the boot mode may prevent the system from booting if the operating system is not installed in the same boot mode.</p> <p>If the operating system supports UEFI, you can set this option to UEFI. Setting this field to BIOS enables compatibility with non-UEFI operating systems. This option is set to UEFI by default.</p> <p>NOTE: Setting this field to UEFI disables the BIOS Boot Settings menu.</p>
Boot Sequence Retry	<p>Enables or disables the Boot Sequence Retry feature. If this option is set to Enabled and the system fails to boot, the system re-attempts the boot sequence after 30 seconds. This option is set to Enabled by default.</p>
Hard-Disk Failover	<p>Specifies the drive that is booted in the event of a drive failure. The devices are selected in the Hard-Disk Drive Sequence on the Boot Option Setting menu. When this option is set to Disabled, only the first drive in the list is attempted to boot. When this option is set to Enabled, all drives are attempted to boot in the order selected in the Hard-Disk Drive Sequence. This option is not enabled for UEFI Boot Mode. This option is set to Disabled by default.</p>
Generic USB Boot	<p>Enables or disables the USB boot option. This option is set to Disabled by default.</p>
Hard-disk Drive Placeholder	<p>Enables or disables the Hard-disk drive placeholder option. This option is set to Disabled by default.</p>
BIOS Boot Settings	<p>Enables or disables BIOS boot options.</p> <p>NOTE: This option is enabled only if the boot mode is BIOS.</p>
UEFI Boot Settings	<p>Enables or disables UEFI Boot options.</p> <p>The Boot options include IPv4 PXE and IPv6 PXE. This option is set to IPv4 by default.</p> <p>NOTE: This option is enabled only if the boot mode is UEFI.</p>
UEFI Boot Sequence	<p>Enables you to change the boot device order.</p>
Boot Options Enable/Disable	<p>Enables you to select the enabled or disabled boot devices.</p>

Choosing system boot mode

System Setup enables you to specify one of the following boot modes for installing your operating system:

- BIOS boot mode is the standard BIOS-level boot interface.
- UEFI boot mode (the default), is an enhanced 64-bit boot interface.

If you have configured your system to boot to UEFI mode, it replaces the system BIOS.

1. From the **System Setup Main Menu**, click **Boot Settings**, and select **Boot Mode**.
2. Select the UEFI boot mode you want the system to boot into.

 **CAUTION: Switching the boot mode may prevent the system from booting if the operating system is not installed in the same boot mode.**

3. After the system boots in the specified boot mode, proceed to install your operating system from that mode.

 **NOTE: Operating systems must be UEFI-compatible to be installed from the UEFI boot mode. DOS and 32-bit operating systems do not support UEFI and can only be installed from the BIOS boot mode.**

 **NOTE: For the latest information about supported operating systems, go to www.dell.com/ossupport.**

Changing boot order

About this task

You may have to change the boot order if you want to boot from a USB key or an optical drive. The following instructions may vary if you have selected **BIOS** for **Boot Mode**.

Steps

1. On the **System Setup Main Menu** screen, click **System BIOS** > **Boot Settings** > **UEFI/BIOS Boot Settings** > **UEFI/BIOS Boot Sequence**.
2. Click **Boot Option Settings** > **BIOS** > **Boot Sequence**.
3. Click **Exit**, and then click **Yes** to save the settings on exit.

Network Settings

You can use the **Network Settings** screen to modify UEFI PXE, iSCSI, and HTTP boot settings. The network settings option is available only in the UEFI mode.

 **NOTE: BIOS does not control network settings in the BIOS mode. For the BIOS boot mode, the option ROM of the network controllers handles the network settings.**

Viewing Network Settings

To view the **Network Settings** screen, perform the following steps:

Steps

1. Power on, or restart your system.
2. Press F2 immediately after you see the following message:

```
F2 = System Setup
```

 **NOTE: If your operating system begins to load before you press F2, wait for the system to finish booting, and then restart your system and try again.**

3. On the **System Setup Main Menu** screen, click **System BIOS**.
4. On the **System BIOS** screen, click **Network Settings**.

Network Settings screen details

The **Network Settings** screen details are explained as follows:

About this task

Option	Description				
UEFI PXE Settings	<table border="1"> <thead> <tr> <th>Options</th> <th>Description</th> </tr> </thead> <tbody> <tr> <td>PXE Device n (n = 1 to 4)</td> <td>Enables or disables the device. When enabled, a UEFI PXE boot option is created for the device.</td> </tr> </tbody> </table>	Options	Description	PXE Device n (n = 1 to 4)	Enables or disables the device. When enabled, a UEFI PXE boot option is created for the device.
Options	Description				
PXE Device n (n = 1 to 4)	Enables or disables the device. When enabled, a UEFI PXE boot option is created for the device.				
PXE Device n Settings (n = 1 to 4)	Enables you to control the configuration of the PXE device.				
UEFI HTTP Settings	<table border="1"> <thead> <tr> <th>Options</th> <th>Description</th> </tr> </thead> <tbody> <tr> <td>HTTP Device (n = 1 to 4)</td> <td>Enables or disables the device. When enabled, a UEFI HTTP boot option is created for the device.</td> </tr> </tbody> </table>	Options	Description	HTTP Device (n = 1 to 4)	Enables or disables the device. When enabled, a UEFI HTTP boot option is created for the device.
Options	Description				
HTTP Device (n = 1 to 4)	Enables or disables the device. When enabled, a UEFI HTTP boot option is created for the device.				
HTTP Device n Settings (n = 1 to 4)	Enables you to control the configuration of the HTTP device.				
UEFI iSCSI Settings	Enables you to control the configuration of the iSCSI device.				

Table 41. UEFI iSCSI Settings screen details

Option	Description
iSCSI Initiator Name	Specifies the name of the iSCSI initiator in IQN format.
iSCSI Device1	Enables or disables the iSCSI device. When disabled, a UEFI boot option is created for the iSCSI device automatically. This is set to Disabled by default.
iSCSI Device1 Settings	Enables you to control the configuration of the iSCSI device.

TLS Authentication Configuration	View and/or modify this device's boot TLS authentication mode. None means the HTTP server and the client will not authenticate each other for this boot. One way means the HTTP server will be authenticated by the client, while the client will not be authenticated by the server. This option is set to None by default.
---	---

Integrated Devices

You can use the **Integrated Devices** screen to view and configure the settings of all integrated devices including the video controller, integrated RAID controller, and the USB ports.

Viewing Integrated Devices

To view the **Integrated Devices** screen, perform the following steps:

Steps

1. Power on, or restart your system.
2. Press F2 immediately after you see the following message:

```
F2 = System Setup
```

NOTE: If your operating system begins to load before you press F2, wait for the system to finish booting, and then restart your system and try again.

3. On the **System Setup Main Menu** screen, click **System BIOS**.
4. On the **System BIOS** screen, click **Integrated Devices**.

Integrated Devices details

About this task

The **Integrated Devices** screen details are explained as follows:

Option	Description
User Accessible USB Ports	<p>Configures the user accessible USB ports. Selecting Only Back Ports On disables the front USB ports; selecting All Ports Off disables all front and back USB ports; selecting All Ports Off (Dynamic) disables all front and back USB ports during POST and front ports can be enabled or disabled dynamically by an authorized user or authorized users without resetting the system.</p> <p>The USB keyboard and mouse function in certain USB ports during the boot process, depending on the selection. After the boot process is complete, the USB ports will be enabled or disabled as per the setting.</p>
Internal USB Port	<p>Enables or disables the internal USB port. This option is set to On or Off. This option is set to On by default.</p> <p>NOTE: The Internal SD Card Port on the PCIe riser is controlled by Internal USB Port.</p>
iDRAC Direct USB Port	<p>The iDRAC Direct USB port is managed by iDRAC exclusively with no host visibility. This option is set to ON or OFF. When set to OFF, iDRAC does not detect any USB devices installed in this managed port. This option is set to On by default.</p>
Integrated RAID Controller	<p>Enables or disables the integrated RAID controller. This option is set to Enabled by default.</p>
Integrated Network Card 1	<p>Enables or disables the integrated network card (NDC). When set to Disabled, the NDC is not available to the operating system (OS). This option is set to Enabled by default.</p> <p>NOTE: If set to Disabled (OS), the Integrated NICs might still be available for shared network access by iDRAC.</p>
I/OAT DMA Engine	<p>Enables or disables the I/O Acceleration Technology (I/OAT) option. I/OAT is a set of DMA features designed to accelerate network traffic and lower CPU utilization. Enable only if the hardware and software support the feature. This option is set to Disabled by default.</p>
Embedded Video Controller	<p>Enables or disables the use of Embedded Video Controller as the primary display. When set to Enabled, the Embedded Video Controller is used as the primary display even if add-in graphic cards are installed. When set to Disabled, an add-in graphics card is used as the primary display. BIOS will output displays to both the primary add-in video and the embedded video during POST and pre-boot environment. The embedded video is disabled before the operating system boots. This option is set to Enabled by default.</p> <p>NOTE: When there are multiple add-in graphic cards installed in the system, the first card discovered during PCI enumeration is selected as the primary video. You might have to re-arrange the cards in the slots in order to control which card is the primary video.</p>
Current State of Embedded Video Controller	<p>Displays the current state of the embedded video controller. The Current State of Embedded Video Controller option is a read-only field. If the Embedded Video Controller is the only display capability in the system (that is, no add-in graphics card is installed), then the Embedded Video Controller is automatically used as the primary display even if the Embedded Video Controller setting is set to Enabled.</p>
SR-IOV Global Enable	<p>Enables or disables the BIOS configuration of Single Root I/O Virtualization (SR-IOV) devices. This option is set to Disabled by default.</p>
Internal SD Card Port	<p>Enables or disables the internal SD card port of the Internal Dual SD Module (IDSMD). This option is set to On by default.</p>
Internal SD Card Redundancy	<p>Configures the redundancy mode of the Internal Dual SD Module (IDSMD). When set to Mirror Mode, data is written on both SD cards. After failure of either card and replacement of the failed card, the data of the active card is copied to the offline card during the system boot.</p> <p>When Internal SD Card Redundancy is set to Disabled, only the primary SD card is visible to the OS. This option is set to Disabled by default.</p>
Internal SD Primary Card	<p>By default, the primary SD card is selected to be SD Card 1. If SD Card 1 is not present, then the controller selects SD Card 2 to be the primary SD card.</p>
OS Watchdog Timer	<p>If your system stops responding, this watchdog timer aids in the recovery of your operating system. When this option is set to Enabled, the operating system initializes the timer. When this option is set to Disabled (the default), the timer does not have any effect on the system.</p>

Option	Description
Empty Slot Unhide	Enables or disables the root ports of all the empty slots that are accessible to the BIOS and OS. This option is set to Disabled by default.
Memory Mapped I/O above 4 GB	Enables or disables the support for the PCIe devices that need large amounts of memory. Enable this option only for 64-bit operating systems. This option is set to Enabled by default.
Memory Mapped I/O Base	When set to 12 TB , the system maps the MMIO base to 12 TB. Enable this option for an OS that requires 44 bit PCIe addressing. When set to 512 GB , the system maps the MMIO base to 512 GB, and reduces the maximum support for memory to less than 512 GB. Enable this option only for the 4 GPU DGMA issue. This option is set to 56 TB by default.
Slot Disablement	Enables or disables the available PCIe slots on your system. The slot disablement feature controls the configuration of the PCIe cards installed in the specified slot. Slots must be disabled only when the installed peripheral card prevents booting into the operating system or causes delays in system startup. If the slot is disabled, both the Option ROM and UEFI drivers are disabled. Only slots that are present on the system are available for control.

Table 42. Slot Disablement

Option	Description
Slot 1	Enables or disables the PCIe slot 1. This option is set to Enabled by default.

Slot Bifurcation	Allows Platform Default Bifurcation , Auto Discovery of Bifurcation and Manual Bifurcation Control . The default is set to Platform Default Bifurcation . The slot bifurcation field is accessible when set to Manual Bifurcation Control and is disabled when set to Platform Default Bifurcation or Auto Discovery of Bifurcation .
-------------------------	--

Table 43. Slot Bifurcation

Option	Description
Auto Discovery Bifurcation Settings	Platform Default Bifurcation , Auto Bifurcation, and Manual bifurcation
Slot 1 Bifurcation	x16 Bifurcation

Serial Communication

You can use the **Serial Communication** screen to view the properties of the serial communication port.

Viewing Serial Communication

To view the **Serial Communication** screen, perform the following steps:

Steps

1. Power on, or restart your system.
2. Press F2 immediately after you see the following message:

```
F2 = System Setup
```



NOTE: If your operating system begins to load before you press F2, wait for the system to finish booting, and then restart your system and try again.

3. On the **System Setup Main Menu** screen, click **System BIOS**.
4. On the **System BIOS** screen, click **Serial Communication**.

Serial Communication details

About this task

The **Serial Communication** screen details are explained as follows:

Option	Description
Serial Communication	Enables you to select serial communication devices (Serial Device 1 and Serial Device 2) in BIOS. BIOS console redirection can also be enabled, and the port address can be specified. This option is set to Auto by default.
Serial Port Address	Enables you to set the port address for serial device. This field sets the serial port address to either COM1 or COM2 (COM1=0x3F8, COM2=0x2F8). This option is set to Serial Device1=COM2 or Serial Device 2=COM1 by default. NOTE: You can use only Serial Device 2 for the Serial Over LAN (SOL) feature. To use console redirection by SOL, configure the same port address for console redirection and the serial device. NOTE: Every time the system boots, the BIOS syncs the serial MUX setting saved in iDRAC. The serial MUX setting can independently be changed in iDRAC. Loading the BIOS default settings from within the BIOS setup utility may not always revert the serial MUX setting to the default setting of Serial Device 1.
External Serial Connector	Enables you to associate the External Serial Connector to Serial Device 1 , Serial Device 2 , or the Remote Access Device by using this option. This option is set to Serial Device 1 by default. NOTE: Only Serial Device 2 can be used for Serial Over LAN (SOL). To use console redirection by SOL, configure the same port address for console redirection and the serial device. NOTE: Every time the system boots, the BIOS syncs the serial MUX setting saved in iDRAC. The serial MUX setting can independently be changed in iDRAC. Loading the BIOS default settings from within the BIOS setup utility may not always revert this setting to the default setting of Serial Device 1.
Failsafe Baud Rate	Specifies the failsafe baud rate for console redirection. The BIOS attempts to determine the baud rate automatically. This failsafe baud rate is used only if the attempt fails, and the value must not be changed. This option is set to 115200 by default.
Remote Terminal Type	Enables you to set the remote console terminal type. This option is set to VT100/VT220 by default.
Redirection After Boot	Enables or disables the BIOS console redirection when the operating system is loaded. This option is set to Enabled by default.

System Profile Settings

You can use the **System Profile Settings** screen to enable specific system performance settings such as power management.

Viewing System Profile Settings

To view the **System Profile Settings** screen, perform the following steps:

Steps

1. Power on, or restart your system.
2. Press F2 immediately after you see the following message:

```
F2 = System Setup
```

NOTE: If your operating system begins to load before you press F2, wait for the system to finish booting, and then restart your system and try again.

3. On the **System Setup Main Menu** screen, click **System BIOS**.
4. On the **System BIOS** screen, click **System Profile Settings**.

System Profile Settings details

About this task

The **System Profile Settings** screen details are explained as follows:

Option	Description
System Profile	<p>Sets the system profile. If you set the System Profile option to a mode other than Custom, the BIOS automatically sets the rest of the options. You can only change the rest of the options if the mode is set to Custom. This option is set to Performance Per Watt Optimized (DAPC) by default. DAPC is Dell Active Power Controller.</p> <p>NOTE: All the parameters on the system profile setting screen are available only when the System Profile option is set to Custom.</p>
CPU Power Management	<p>Sets the CPU power management. This option is set to System DBPM (DAPC) by default. DBPM is Demand-Based Power Management.</p>
Memory Frequency	<p>Sets the speed of the system memory. You can select Maximum Performance, Maximum Reliability, or a specific speed. This option is set to Maximum Performance by default.</p>
Turbo Boost	<p>Enables or disables the processor to operate in the turbo boost mode. This option is set to Enabled by default.</p>
C1E	<p>Enables or disables the processor to switch to a minimum performance state when it is idle. This option is set to Enabled by default.</p>
C States	<p>Enables or disables the processor to operate in all available power states. This option is set to Enabled by default.</p>
Write Data CRC	<p>Enables or disables the Write Data CRC. This option is set to Disabled by default.</p>
Memory Patrol Scrub	<p>Sets the memory patrol scrub frequency. This option is set to Standard by default.</p>
Memory Refresh Rate	<p>Sets the memory refresh rate to either 1x or 2x. This option is set to 1x by default.</p>
Uncore Frequency	<p>Enables you to select the Processor Uncore Frequency option. Dynamic mode enables the processor to optimize power resources across cores and uncores during runtime. The optimization of the uncore frequency to either save power or optimize performance is influenced by the setting of the Energy Efficiency Policy option.</p>
Energy Efficient Policy	<p>Enables you to select the Energy Efficient Policy option.</p> <p>The CPU uses the setting to manipulate the internal behavior of the processor and determines whether to target higher performance or better power savings. This option is set to Balanced Performance by default.</p>
Number of Turbo Boost Enabled Cores for Processor 1	<p>NOTE: If there are two processors installed in the system, you will see an entry for Number of Turbo Boost Enabled Cores for Processor 2.</p> <p>Controls the number of turbo boost enabled cores for Processor 1. The maximum number of cores is enabled by default.</p>
Monitor/Mwait	<p>Enables the Monitor/Mwait instructions in the processor. This option is set to Enabled for all system profiles, except Custom by default.</p> <p>NOTE: This option can be disabled only if the C States option in the Custom mode is set to disabled.</p> <p>NOTE: When C States is set to Enabled in the Custom mode, changing the Monitor/Mwait setting does not impact the system power or performance.</p>
CPU Interconnect Bus Link Power Management	<p>Enables or disables the CPU Interconnect Bus Link Power Management. This option is set to Enabled by default.</p>
PCI ASPM L1 Link Power Management	<p>Enables or disables the PCI ASPM L1 Link Power Management. This option is set to Enabled by default.</p>

System Security

You can use the **System Security** screen to perform specific functions such as setting the system password, setup password and disabling the power button.

Viewing System Security

To view the **System Security** screen, perform the following steps:

Steps

1. Power on, or restart your system.
2. Press F2 immediately after you see the following message:

F2 = System Setup

NOTE: If your operating system begins to load before you press F2, wait for the system to finish booting, and then restart your system and try again.

3. On the **System Setup Main Menu** screen, click **System BIOS**.
4. On the **System BIOS** screen, click **System Security**.

System Security Settings details

About this task

The **System Security Settings** screen details are explained as follows:

Option	Description
CPU AES-NI	Improves the speed of applications by performing encryption and decryption by using the Advanced Encryption Standard Instruction Set (AES-NI). This option is set to Enabled by default.
System Password	Enables you to set the system password. This option is set to Enabled by default and is read-only if the password jumper is not installed in the system.
Setup Password	Enables you to set the system setup password. This option is read-only if the password jumper is not installed in the system.
Password Status	Enables you to lock the system password. This option is set to Unlocked by default.
TPM Security	<p>NOTE: The TPM menu is available only when the TPM module is installed.</p> <p>Enables you to control the reporting mode of the TPM. The TPM Security option is set to Off by default. You can only modify the TPM Status TPM Activation, and the Intel TXT fields if the TPM Status field is set to either On with Pre-boot Measurements or On without Pre-boot Measurements.</p>
TPM Information	Enables you to change the operational state of the TPM. This option is set to No Change by default.
TPM Status	Specifies the TPM status.
TPM Command	<p>Controls the Trusted Platform Module (TPM). When set to None, no command is sent to the TPM. When set to Activate, the TPM is enabled and activated. When set to Deactivate, the TPM is disabled and deactivated. When set to Clear, all the contents of the TPM are cleared. This option is set to None by default.</p> <p>CAUTION: Clearing the TPM results in the loss of all keys in the TPM. The loss of TPM keys may affect booting to the operating system.</p> <p>This field is read-only when TPM Security is set to Off. The action requires an additional reboot before it can take effect.</p>
TPM Advanced Settings	This setting is enabled only when TPM Security is set to ON.
Intel(R) TXT	Enables you to set the Intel Trusted Execution Technology (TXT) option. To enable the Intel TXT option, virtualization technology and TPM Security must be enabled with Pre-boot measurements. This option is set to Off by default.
Power Button	Enables you to set the power button on the front of the system. This option is set to Enabled by default.

Option	Description								
AC Power Recovery	Sets how the system behaves after AC power is restored to the system. This option is set to Last by default.								
AC Power Recovery Delay	Enables you to set the time that the system should take to turn on after AC power is restored to the system. This option is set to Immediate by default.								
User Defined Delay (60 s to 600 s)	Enables you to set the User Defined Delay option when the User Defined option for AC Power Recovery Delay is selected.								
UEFI Variable Access	Provides varying degrees of securing UEFI variables. When set to Standard (the default), UEFI variables are accessible in the operating system per the UEFI specification. When set to Controlled , selected UEFI variables are protected in the environment, and new UEFI boot entries are forced to be at the end of the current boot order.								
In-Band Manageability Interface	When set to Disabled , this setting hides the Management Engine's (ME), HECI devices, and the system's IPMI devices from the operating system. This prevents the operating system from changing the ME power capping settings, and blocks access to all in-band management tools. All management should be managed through out-of-band. This option is set to Enabled by default.  NOTE: BIOS update requires HECI devices to be operational and DUP updates require IPMI interface to be operational. This setting needs to be set to Enabled to avoid updating errors.								
Secure Boot	Enables Secure Boot, where the BIOS authenticates each pre-boot image by using the certificates in the Secure Boot Policy. Secure Boot is set to Disabled by default.								
Secure Boot Policy	When Secure Boot policy is set to Standard , the BIOS uses the system manufacturer key and certificates to authenticate pre-boot images. When Secure Boot policy is set to Custom , the BIOS uses the user-defined key and certificates. Secure Boot policy is set to Standard by default.								
Secure Boot Mode	Enables you to configure how the BIOS uses the Secure Boot Policy Objects (PK, KEK, db, dbx). If the current mode is set to Deployed Mode , the available options are User Mode and Deployed Mode . If the current mode is set to User Mode , the available options are User Mode , Audit Mode , and Deployed Mode .								
	<table border="1"> <thead> <tr> <th>Options</th> <th>Description</th> </tr> </thead> <tbody> <tr> <td>User Mode</td> <td>In User Mode, PK must be installed, and BIOS performs signature verification on programmatic attempts to update policy objects. BIOS allows unauthenticated programmatic transitions between modes.</td> </tr> <tr> <td>Audit Mode</td> <td>In Audit mode, PK is not present. BIOS does not authenticate programmatic updates to the policy objects, and transitions between modes. Audit Mode is useful for programmatically determining a working set of policy objects. BIOS performs signature verification on pre-boot images. BIOS also logs the results in the image Execution Information Table, but approves the images whether they pass or fail verification.</td> </tr> <tr> <td>Deployed Mode</td> <td>Deployed Mode is the most secure mode. In Deployed Mode, PK must be installed and the BIOS performs signature verification on programmatic attempts to update policy objects. Deployed Mode restricts the programmatic mode transitions.</td> </tr> </tbody> </table>	Options	Description	User Mode	In User Mode , PK must be installed, and BIOS performs signature verification on programmatic attempts to update policy objects. BIOS allows unauthenticated programmatic transitions between modes.	Audit Mode	In Audit mode , PK is not present. BIOS does not authenticate programmatic updates to the policy objects, and transitions between modes. Audit Mode is useful for programmatically determining a working set of policy objects. BIOS performs signature verification on pre-boot images. BIOS also logs the results in the image Execution Information Table, but approves the images whether they pass or fail verification.	Deployed Mode	Deployed Mode is the most secure mode. In Deployed Mode , PK must be installed and the BIOS performs signature verification on programmatic attempts to update policy objects. Deployed Mode restricts the programmatic mode transitions.
Options	Description								
User Mode	In User Mode , PK must be installed, and BIOS performs signature verification on programmatic attempts to update policy objects. BIOS allows unauthenticated programmatic transitions between modes.								
Audit Mode	In Audit mode , PK is not present. BIOS does not authenticate programmatic updates to the policy objects, and transitions between modes. Audit Mode is useful for programmatically determining a working set of policy objects. BIOS performs signature verification on pre-boot images. BIOS also logs the results in the image Execution Information Table, but approves the images whether they pass or fail verification.								
Deployed Mode	Deployed Mode is the most secure mode. In Deployed Mode , PK must be installed and the BIOS performs signature verification on programmatic attempts to update policy objects. Deployed Mode restricts the programmatic mode transitions.								
Secure Boot Policy Summary	Specifies the list of certificates and hashes that secure boot uses to authenticate images.								
Secure Boot Custom Policy Settings	Configures the Secure Boot Custom Policy. To enable this option, set the Secure Boot Policy to Custom .								

Creating a system and setup password

Prerequisites

Ensure that the password jumper is enabled. The password jumper enables or disables the system password and setup password features. For more information, see the System board jumper settings section.

 **NOTE:** If the password jumper setting is disabled, the existing system password and setup password are deleted and you need not provide the system password to boot the system.

Steps

1. To enter System Setup, press F2 immediately after turning on or rebooting your system.
2. On the **System Setup Main Menu** screen, click **System BIOS > System Security**.
3. On the **System Security** screen, verify that **Password Status** is set to **Unlocked**.
4. In the **System Password** field, type your system password, and press Enter or Tab. A message prompts you to reenter the system password.
5. Reenter the system password, and click **OK**.
6. In the **Setup Password** field, type your setup password and press Enter or Tab. A message prompts you to reenter the setup password.
7. Reenter the setup password, and click **OK**.
8. Press Esc to return to the System BIOS screen. Press Esc again. A message prompts you to save the changes.

 **NOTE:** Password protection does not take effect until the system reboots.

Using your system password to secure the system

About this task

If you have assigned a setup password, the system accepts your setup password as an alternate system password.

Steps

1. Power on or reboot your system.
2. Type the system password and press Enter.

Next steps

When **Password Status** is set to **Locked**, type the system password and press Enter when prompted at reboot.

 **NOTE:** If an incorrect system password is typed, the system displays a message and prompts you to reenter your password. You have three attempts to type the correct password. After the third unsuccessful attempt, the system displays an error message that the system has stopped functioning and must be turned off. Even after you turn off and restart the system, the error message is displayed until the correct password is entered.

Deleting or changing system and setup password

Prerequisites

 **NOTE:** You cannot delete or change an existing system or setup password if the Password Status is set to Locked.

Steps

1. To enter System Setup, press F2 immediately after turning on or restarting your system.
2. On the **System Setup Main Menu** screen, click **System BIOS > System Security**.
3. On the **System Security** screen, ensure that **Password Status** is set to **Unlocked**.
4. In the **System Password** field, change or delete the existing system password, and then press Enter or Tab.
5. In the **Setup Password** field, alter or delete the existing setup password, and then press Enter or Tab.

NOTE: If you change the system password or setup password, a message prompts you to reenter the new password. If you delete the system password or setup password, a message prompts you to confirm the deletion.

6. Press Esc to return to the **System BIOS** screen. Press Esc again, and a message prompts you to save the changes.

Operating with setup password enabled

If **Setup Password** is set to **Enabled**, type the correct setup password before modifying the system setup options.

If you do not type the correct password in three attempts, the system displays the following message:

```
Invalid Password! Number of unsuccessful password attempts: <x> System Halted! Must power down.
```

Even after you restart the system, the error message is displayed until the correct password is typed. The following options are exceptions:

- If **System Password** is not set to **Enabled** and is not locked through the **Password Status** option, you can assign a system password. For more information, see the [System Security Settings details](#) section.
- You cannot disable or change an existing system password.

NOTE: You can use the password status option with the setup password option to protect the system password from unauthorized changes.

Redundant OS Control

In the **Redundant OS Control** screen you can set the redundant OS information. This enables you to set up a physical recovery disk on the system.

Viewing Redundant OS Control

To view the **Redundant OS Control** screen, perform the following steps:

Steps

1. Power on, or restart your system.
2. Press F2 immediately after you see the following message:

```
F2 = System Setup
```

NOTE: If your operating system begins to load before you press F2, wait for the system to finish booting, and then restart your system and try again.

3. On the **System Setup Main Menu** screen, click **System BIOS**.
4. On the **System BIOS** screen, click **Redundant OS Control**.

Redundant OS Control screen details

The **Redundant OS Control** screen details are explained as follows:

About this task

Option	Description
Redundant OS Location	Enables you to select a backup disk from the following devices: <ul style="list-style-type: none">• None• IDSDM• SATA Ports in AHCI mode• BOSS PCIe Cards (Internal M.2 Drives)• Internal USB <p>NOTE: RAID configurations and NVMe cards not are included as BIOS does not have the ability to distinguish between individual drives in those configurations.</p>

Option	Description
Redundant OS State	<p>NOTE: This option is disabled if Redundant OS Location is set to None.</p> <p>When set to Visible, the backup disk is visible to the boot list and OS. When set to Hidden, the backup disk is disabled and is not visible to the boot list and OS. This option is set to Visible by default.</p> <p>NOTE: BIOS will disable the device in hardware, so it cannot be accessed by the OS.</p>
Redundant OS Boot	<p>NOTE: This option is disabled if Redundant OS Location is set to None or if Redundant OS State is set to Hidden.</p> <p>When set to Enabled, BIOS boots to the device specified in Redundant OS Location. When set to Disabled, BIOS preserves the current boot list settings. This option is set to Disabled by default.</p>

Miscellaneous Settings

You can use the **Miscellaneous Settings** screen to perform specific functions such as updating the asset tag and changing the system date and time.

Viewing Miscellaneous Settings

To view the **Miscellaneous Settings** screen, perform the following steps:

Steps

1. Power on, or restart your system.
2. Press F2 immediately after you see the following message:

```
F2 = System Setup
```

NOTE: If your operating system begins to load before you press F2, wait for the system to finish booting, and then restart your system and try again.

3. On the **System Setup Main Menu** screen, click **System BIOS**.
4. On the **System BIOS** screen, click **Miscellaneous Settings**.

Miscellaneous Settings details

About this task

The **Miscellaneous Settings** screen details are explained as follows:

Option	Description
System Time	Enables you to set the time on the system.
System Date	Enables you to set the date on the system.
Asset Tag	Specifies the asset tag and enables you to modify it for security and tracking purposes.
Keyboard NumLock	Enables you to set whether the system should boot with the NumLock enabled or disabled. This option is set to On by default. NOTE: This option does not apply to 84-key keyboards.
F1/F2 Prompt on Error	Enables or disables the F1/F2 prompt on error. This option is set to Enabled by default. The F1/F2 prompt also includes keyboard errors.
Load Legacy Video Option ROM	Enables you to determine whether the system BIOS loads the legacy video (INT 10H) option ROM from the video controller. Selecting Enabled in the operating system does not support UEFI video output standards. This field is available only for UEFI boot mode. You cannot set the option to Enabled if UEFI Secure Boot mode is enabled. This option is set to Disabled by default.
Dell Wyse P25/P45 BIOS Access	Enables or disables the Dell Wyse P25/P45 BIOS Access. This option is set to Enabled by default.

Option	Description
Power Cycle Request	Enables or disables the Power Cycle Request. This option is set to None by default.

iDRAC Settings utility

The iDRAC settings utility is an interface to set up and configure the iDRAC parameters by using UEFI. You can enable or disable various iDRAC parameters by using the iDRAC settings utility.

NOTE: Accessing some of the features on the iDRAC settings utility needs the iDRAC Enterprise License upgrade.

For more information about using iDRAC, see *Dell Integrated Dell Remote Access Controller User's Guide* at www.dell.com/poweredgemanuals.

Device Settings

Device Settings enables you to configure the below device parameters:

- Controller Configuration Utility
- Embedded NIC Port1-X Configuration
- NICs in slotX, Port1-X Configuration
- BOSS Card configuration

Dell Lifecycle Controller

Dell Lifecycle Controller (LC) provides advanced embedded systems management capabilities including system deployment, configuration, update, maintenance, and diagnosis. LC is delivered as part of the iDRAC out-of-band solution and Dell system embedded Unified Extensible Firmware Interface (UEFI) applications.

Embedded system management

The Dell Lifecycle Controller provides advanced embedded system management throughout the lifecycle of the system. The Dell Lifecycle Controller can be started during the boot sequence and can function independently of the operating system.

NOTE: Certain platform configurations may not support the full set of features provided by the Dell Lifecycle Controller.

For more information about setting up the Dell Lifecycle Controller, configuring hardware and firmware, and deploying the operating system, see the Dell Lifecycle Controller documentation at www.dell.com/poweredgemanuals.

Boot Manager

The **Boot Manager** screen enables you to select boot options and diagnostic utilities.

Viewing Boot Manager

About this task

To enter Boot Manager:

Steps

1. Power on, or restart your system.
2. Press F11 when you see the following message:

```
F11 = Boot Manager
```

If your operating system begins to load before you press F11, allow the system to complete the booting, and then restart your system and try again.

Boot Manager main menu

Menu item	Description
Continue Normal Boot	The system attempts to boot to devices starting with the first item in the boot order. If the boot attempt fails, the system continues with the next item in the boot order until the boot is successful or no more boot options are found.
One-shot Boot Menu	Enables you to access boot menu, where you can select a one-time boot device to boot from.
Launch System Setup	Enables you to access System Setup.
Launch Lifecycle Controller	Exits the Boot Manager and invokes the Dell Lifecycle Controller program.
System Utilities	Enables you to launch System Utilities menu such as System Diagnostics and UEFI shell.

One-shot UEFI boot menu

One-shot UEFI boot menu enables you to select a boot device to boot from.

System Utilities

System Utilities contains the following utilities that can be launched:

- Launch Diagnostics
- BIOS Update File Explorer
- Reboot System







PXE boot

You can use the Preboot Execution Environment (PXE) option to boot and configure the networked systems, remotely.

To access the **PXE boot** option, boot the system and then press F12 during POST instead of using standard Boot Sequence from BIOS Setup. It does not pull any menu or allows managing of network devices.

Installing and removing system components

Safety instructions

-  **NOTE:** Whenever you need to lift the system, get others to assist you. To avoid injury, do not attempt to lift the system by yourself.
-  **WARNING:** Opening or removing the system cover while the system is powered on may expose you to a risk of electric shock.
-  **CAUTION:** Do not operate the system without the cover for a duration exceeding five minutes. Operating the system without the system cover can result in component damage.
-  **CAUTION:** Many repairs may only be done by a certified service technician. You should only perform troubleshooting and simple repairs as authorized in your product documentation, or as directed by the online or telephone service and support team. Damage due to servicing that is not authorized by Dell is not covered by your warranty. Read and follow the safety instructions that are shipped with your product.
-  **NOTE:** It is recommended that you always use an antistatic mat and antistatic strap while working on components inside the system.
-  **CAUTION:** To ensure proper operation and cooling, all bays in the system and system fans must be always populated with a component or a blank.

Before working inside your system

Prerequisites

Follow the safety guidelines listed in [Safety instructions](#).

Steps

1. Turn off the system, including all attached peripherals.
2. Disconnect the system from the electrical outlet and disconnect the peripherals.
3. If applicable, remove the system from the rack.
For more information, see the *Rack Installation Guide* at www.dell.com/poweredge/manuals.
4. Remove the system cover.

After working inside your system

Prerequisites

Follow the safety guidelines listed in [Safety instructions](#).

Steps

1. Reconnect the peripherals and connect the system to the electrical outlet.
2. Turn on the attached peripherals and then turn on the system.

Recommended tools

You need the following tools to perform the removal and installation procedures:

- Key to the bezel lock

The key is needed only if your system includes a bezel.

- Phillips #1 screwdriver
- Phillips #2 screwdriver
- 1/4 inch flat head screwdriver
- Torx #T30 screwdriver
- Wrist grounding strap

You need the following tools to assemble the cables for a DC power supply unit.

- AMP 90871-1 hand-crimping tool or equivalent
- Tyco Electronics 58433-3 or equivalent
- Wire-stripper pliers to remove insulation from size 10 AWG solid or stranded, insulated copper wire

NOTE: Use alpha wire part number 3080 or equivalent (65/30 stranding).

Optional front bezel

Removing the front bezel

The procedure to remove the front bezel with and without the LCD panel is the same.

Prerequisites

Follow the safety guidelines listed in [Safety instructions](#).

Steps

1. Unlock the bezel by using the bezel key.
2. Press the release button, and pull the left end of the bezel.
3. Unhook the right end, and remove the bezel.

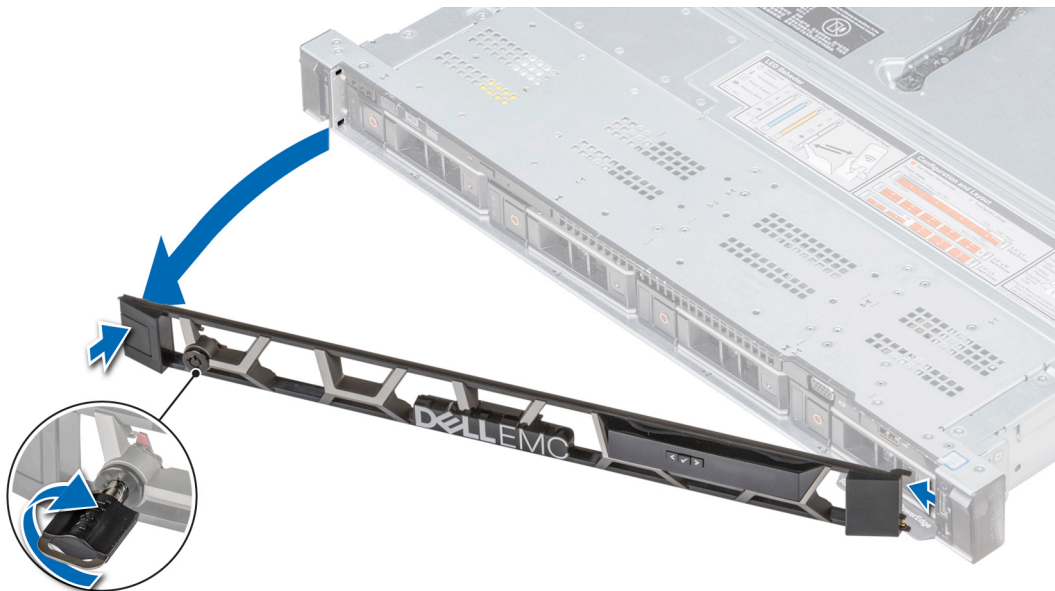

Figure 20. Removing the optional front bezel with the LCD panel

Installing the front bezel

The procedure to install the front bezel with and without the LCD panel is the same.

Prerequisites

Follow the safety guidelines listed in [Safety instructions](#).

Steps

1. Locate and remove the bezel key.
- i** **NOTE: The bezel key is part of the LCD bezel package.**
2. Align and insert the right end of the bezel onto the system.
3. Press the bezel until the button clicks in place and fit the left end of the bezel onto the system.
4. Lock the bezel by using the key.

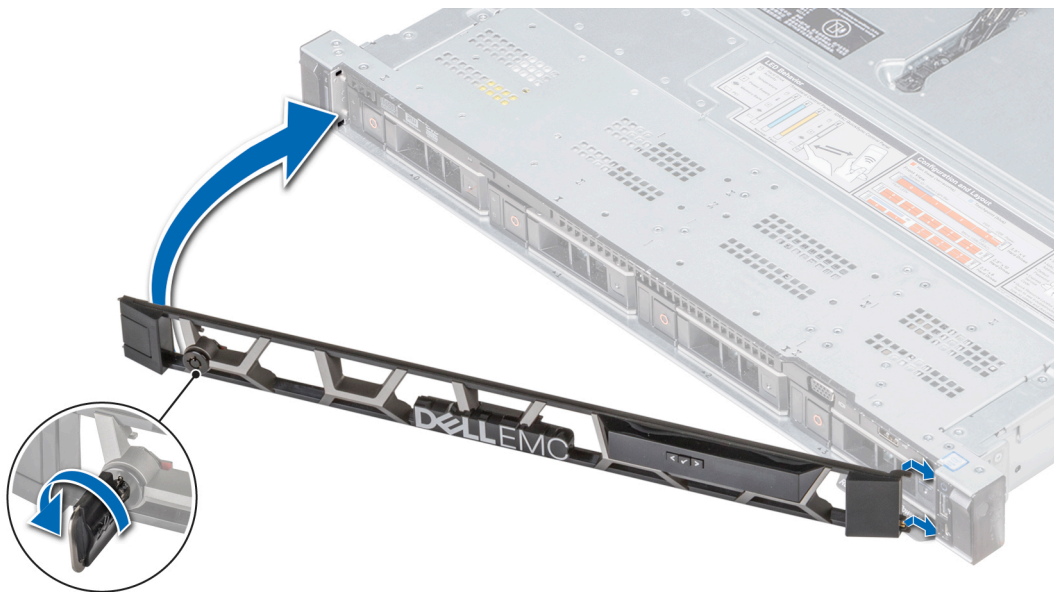

Figure 21. Installing the optional front bezel with the LCD panel

System cover

Removing the system cover

Prerequisites

1. Follow the safety guidelines listed in [Safety instructions](#).
2. Turn off the system, including any attached peripherals.
3. Disconnect the system from the electrical outlet and disconnect the peripherals.

Steps

1. Using a 1/4 inch flat head or a Phillips #2 screwdriver, rotate the latch release lock counter clockwise to the unlocked position.
2. Lift the latch till the system cover slides back and the tabs on the system cover disengage from the guide slots on the system.
3. Hold the cover on both sides, and lift the cover away from the system.



Figure 22. Removing the system cover

Installing the system cover

Prerequisites

1. Follow the safety guidelines listed in [Safety instructions](#).
2. Ensure that all internal cables are routed correctly and connected, and no tools or extra parts are left inside the system.

Steps

1. Align the tabs on the system cover with the guide slots on the system.
2. Push the system cover latch down.
The system cover slides forward, the tabs on the system cover engage with the guide slots on the system and the system cover latch locks into place.
3. Using a 1/4 inch flat head or Phillips #2 screwdriver, rotate the latch release lock clockwise to the locked position.



Figure 23. Installing the system cover

Next steps

1. Reconnect the peripherals and connect the system to the electrical outlet.
2. Turn on the system, including any attached peripherals.

Drives

Removing a drive blank

The procedure for removing 2.5 inch and 3.5 inch drive blanks is identical.

Prerequisites

1. Follow the safety guidelines listed in [Safety instructions](#).
2. If installed, [remove the front bezel](#).

CAUTION: To maintain proper system cooling, drive blanks must be installed in all empty drive slots.

CAUTION: Mixing drive blanks from previous generations of PowerEdge servers is not supported.

Steps

Press the release button, and slide the drive blank out of the drive slot.

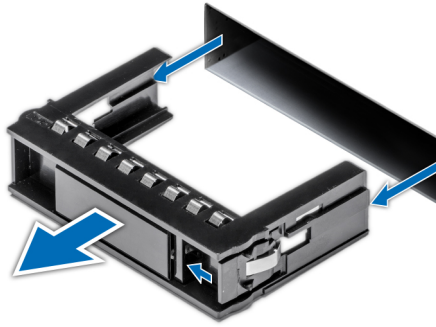

Figure 24. Removing a drive blank

Next steps

1. Install a drive or a drive blank.

Installing a drive blank

The procedure for installing 2.5 inch and 3.5 inch drive blanks is identical.

Prerequisites

1. Follow the safety guidelines listed in [Safety instructions](#).
2. If installed, [remove the front bezel](#).

CAUTION: Mixing drive blanks from previous generations of PowerEdge servers is not supported.

Steps

Insert the drive blank into the drive slot, and push the blank until the release button clicks into place.

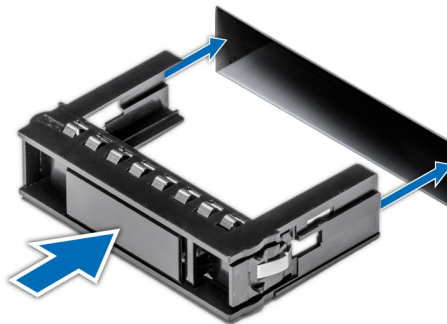

Figure 25. Installing a drive blank

Next steps

If removed, [install the front bezel](#).

Removing a drive carrier

Prerequisites

1. Follow the safety guidelines listed in [Safety instructions](#).
2. If applicable, [remove the front bezel](#).
3. Using the management software, prepare the drive for removal.

If the drive is online, the green activity or fault indicator flashes while the drive is turning off. When the drive indicators are off, the drive is ready for removal. For more information, see the documentation for the storage controller.

CAUTION: Before attempting to remove or install a drive while the system is running, see the documentation for the storage controller card to ensure that the host adapter is configured correctly to support drive removal and insertion.

CAUTION: Mixing drives from previous generations of PowerEdge servers is not supported.

CAUTION: To prevent data loss, ensure that your operating system supports drive installation. See the documentation supplied with your operating system.

Steps

1. Press the release button to open the drive carrier release handle.
2. Holding the handle, slide the drive carrier out of the drive slot.



Figure 26. Removing a drive carrier

Next steps

1. Follow the procedure listed in [After working inside your system](#).
2. [Install a drive carrier](#).
3. If you are not replacing the drive immediately, insert a drive blank in the empty drive slot to maintain proper system cooling.

Installing a drive carrier

Prerequisites

CAUTION: Before attempting to remove or install a drive while the system is running, see the documentation for the storage controller card to ensure that the host adapter is configured correctly to support drive removal and insertion.

CAUTION: Mixing drives from previous generations of PowerEdge servers is not supported.

CAUTION: Combining SAS and SATA drives in the same RAID volume is not supported.

CAUTION: When installing a drive, ensure that the adjacent drives are fully installed. Inserting a drive carrier and attempting to lock its handle next to a partially installed carrier can damage the partially installed carrier's shield spring and make it unusable.

CAUTION: To prevent data loss, ensure that your operating system supports hot-swap drive installation. See the documentation supplied with your operating system.

CAUTION: When a replacement hot swappable drive is installed and the system is powered on, the drive automatically begins to rebuild. Ensure that the replacement drive is blank or contains data that you wish to overwrite. Any data on the replacement drive is immediately lost after the drive is installed.

1. Follow the safety guidelines listed in [Safety instructions](#).
2. If applicable, [remove the drive blank](#).

Steps

1. Press the release button on the front of the drive carrier to open the release handle.
2. Insert the drive carrier into the drive slot and slide until the drive connects with the backplane.
3. Close the drive carrier release handle to lock the drive in place.



Figure 27. Installing a drive carrier

Next steps

If applicable, [install the front bezel](#).

Removing the drive from the drive carrier

Prerequisites

Follow the safety guidelines listed in [Safety instructions](#).

CAUTION: Mixing drives from previous generations of PowerEdge servers is not supported.

Steps

1. Using a Phillips #1 screwdriver, remove the screws from the slide rails on the drive carrier.
2. Lift the drive out of the drive carrier.



Figure 28. Removing the drive from the drive carrier

Next steps

If applicable, [install the drive into the drive carrier](#).

Installing a drive into the drive carrier

Prerequisites

Follow the safety guidelines listed in [Safety instructions](#).

CAUTION: Mixing drive carriers from other generations of PowerEdge servers is not supported.

NOTE: When installing a drive into the drive carrier, ensure that the screws are torqued to 4 in-lbs.

Steps

1. Insert the drive into the drive carrier with the connector end of the drive towards the back of the carrier.
2. Align the screw holes on the drive with the screws holes on the drive carrier.
When aligned correctly, the back of the drive is flush with the back of the drive carrier.
3. Using a Phillips #1 screwdriver, secure the drive to the drive carrier with screws.



Figure 29. Installing a drive into the drive carrier

Backplane cover

Removing the backplane cover

Prerequisites

1. Follow the safety guidelines listed in [Safety instructions](#).
2. Follow the procedure listed in [Before working inside your system](#).
3. [Remove the system cover](#).

Steps

1. Slide the backplane cover in the direction of the arrows marked on the backplane cover.
2. Lift the backplane cover away from the system.

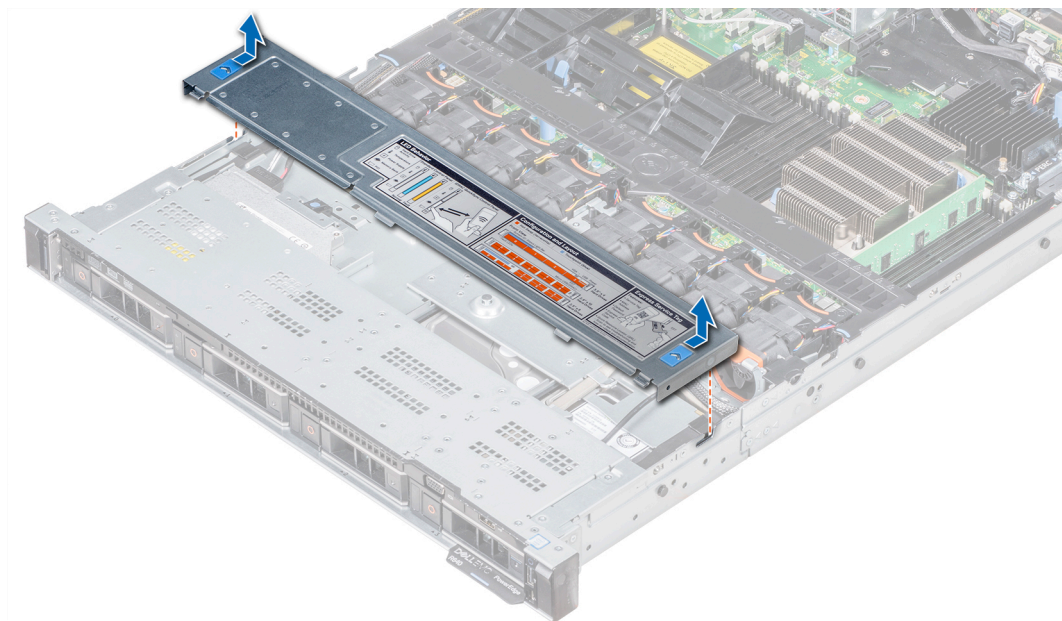

Figure 30. Removing the backplane cover

Installing the backplane cover

Prerequisites

1. Follow the safety guidelines listed in [Safety instructions](#).
2. Follow the procedure listed in [Before working inside your system](#).
3. [Install the system cover](#).

Steps

1. Align the tabs on the backplane cover with the guide slots on the system.
2. Slide the backplane cover toward the front of the system until the cover locks into place.

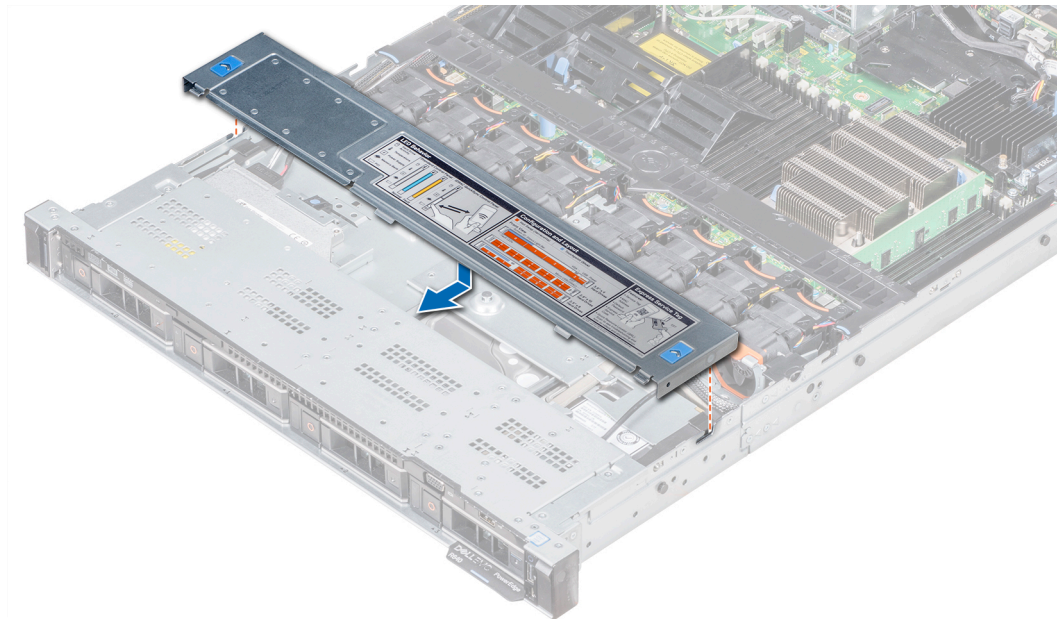

Figure 31. Installing the backplane cover

Next steps

Follow the procedure listed in [After working inside your system](#).

Inside the system

CAUTION: Many repairs may only be done by a certified service technician. You should only perform troubleshooting and simple repairs as authorized in your product documentation, or as directed by the online or telephone service and support team. Damage due to servicing that is not authorized by Dell is not covered by your warranty. Read and follow the safety instructions that are shipped with your product.

NOTE: Components that are hot swappable are marked orange and touch points on the components are marked blue.

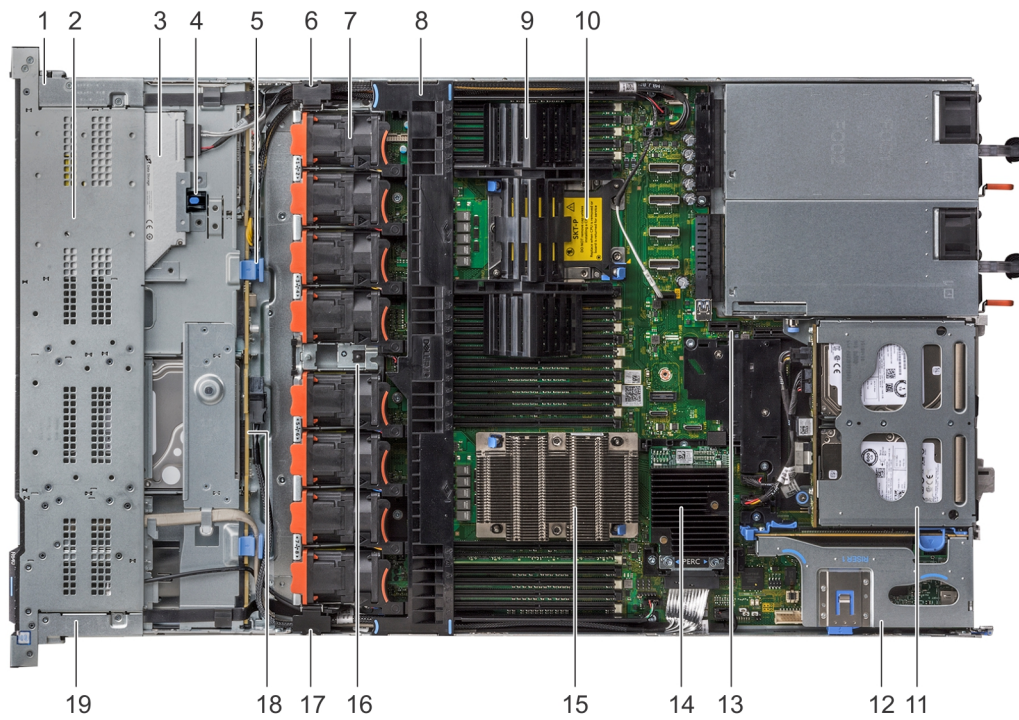

Figure 32. Inside the system - 1 PCIe expansion riser

- | | |
|------------------------------------|--|
| 1. right control panel cable cover | 2. hard drive cage |
| 3. optical drive | 4. optical drive release latch |
| 5. backplane release latch | 6. cabling latch |
| 7. cooling fan (8) | 8. air shroud |
| 9. processor and DIMM blank | 10. processor 2 slot |
| 11. rear hard drive module | 12. expansion riser 1 |
| 13. IDSDM/vFlash module slot | 14. integrated storage controller card |
| 15. processor 1 | 16. intrusion switch |
| 17. cabling latch | 18. hard drive backplane |
| 19. left control panel cable cover | |

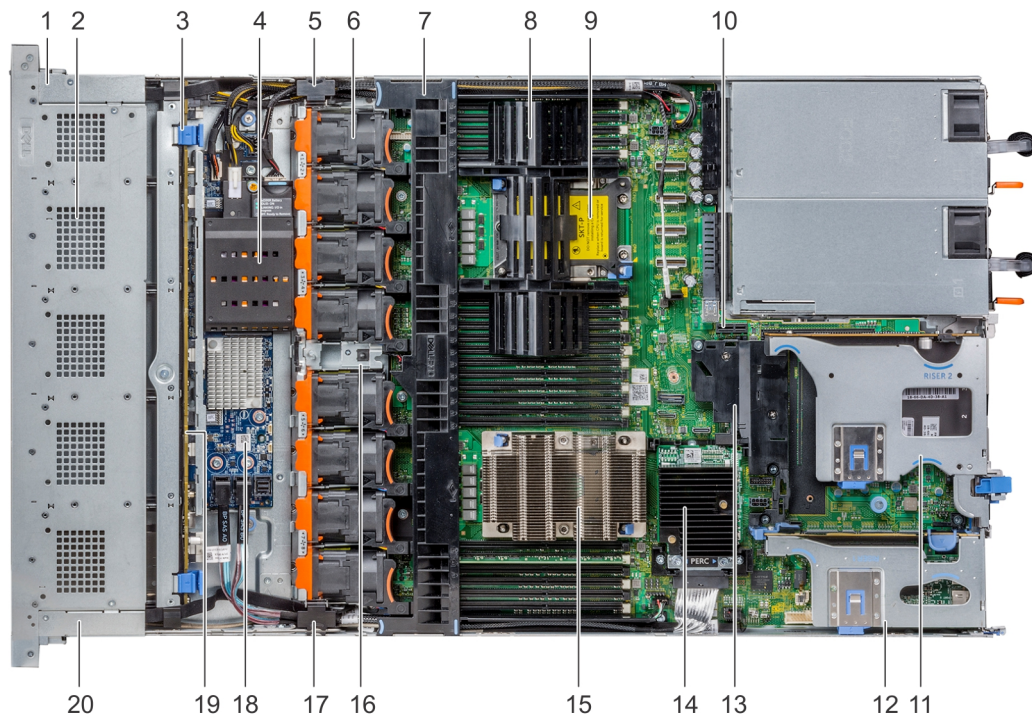

Figure 33. Inside the system - 2 PCIe expansion risers

- | | |
|------------------------------------|--|
| 1. right control panel cable cover | 2. hard drive cage |
| 3. backplane release latch | 4. NVDIMM-N battery |
| 5. cabling latch | 6. cooling fan (8) |
| 7. air shroud | 8. processor and DIMM blank |
| 9. processor 2 slot | 10. IDSDM/vFlash module slot |
| 11. expansion riser 2 B | 12. expansion riser 1 B |
| 13. PCIe shroud | 14. integrated storage controller card |
| 15. processor 1 | 16. intrusion switch |
| 17. cabling latch | 18. SAS expander board |
| 19. hard drive backplane | 20. left control panel cable cover |

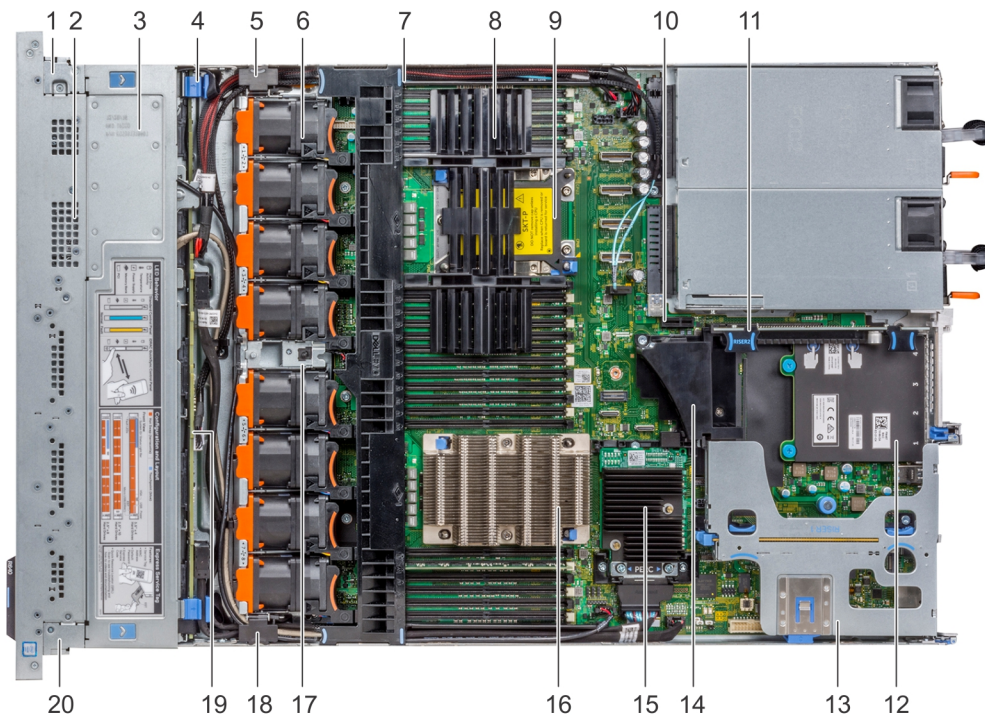

Figure 34. Inside the system - 3 PCIe expansion risers

- | | |
|--|------------------------------------|
| 1. right control panel cable cover | 2. hard drive cage |
| 3. backplane cover | 4. backplane release latch |
| 5. cabling latch | 6. cooling fan (8) |
| 7. air shroud | 8. processor and DIMM blank |
| 9. processor 2 slot | 10. IDSDM/vFlash module slot |
| 11. expansion riser 2 A | 12. network daughter card |
| 13. expansion riser 1 A | 14. PCIe shroud |
| 15. integrated storage controller card | 16. processor 1 |
| 17. intrusion switch | 18. cabling latch |
| 19. hard drive backplane | 20. left control panel cable cover |

Air shroud

Removing the air shroud

Prerequisites

CAUTION: Never operate your system with the air shroud removed. The system may get overheated quickly, resulting in shutdown of the system and loss of data.

1. Follow the safety guidelines listed in [Safety instructions](#).
2. Follow the procedure listed in [Before working inside your system](#).

Steps

Hold the air shroud at both ends and lift it away from the system.

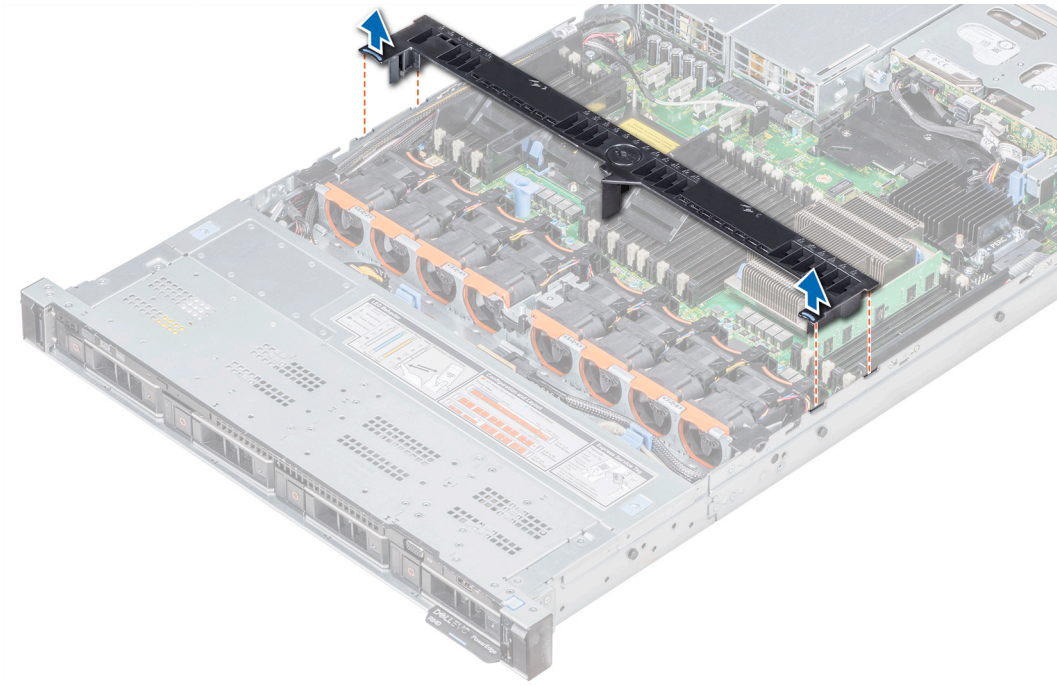

Figure 35. Removing the air shroud

Next steps

1. If applicable, [install the air shroud](#).
2. Follow the procedure listed in [After working inside your system](#).

Installing the air shroud

Prerequisites

1. Follow the safety guidelines listed in [Safety instructions](#).
2. Follow the procedure listed in [Before working inside your system](#).
3. If applicable, route the cables inside the system along the system wall and secure the cables by using the cable latch.

Steps

1. Align the tabs on the air shroud with the slots on the system.
2. Lower the air shroud into the system until it is firmly seated.
When firmly seated, the memory socket numbers marked on the air shroud align with the respective memory sockets.

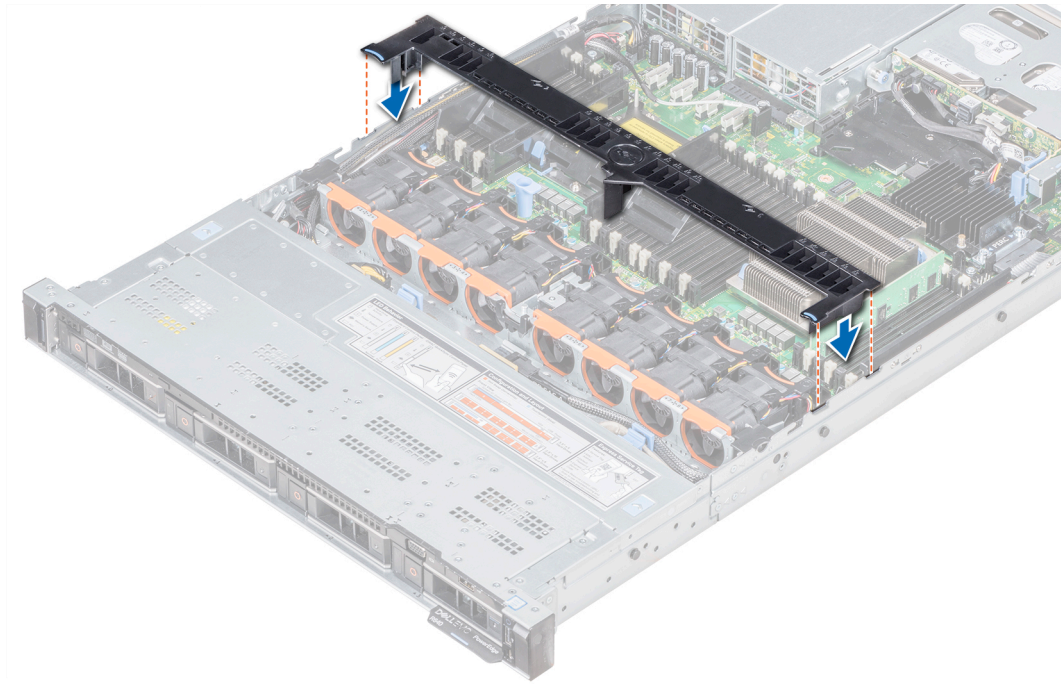

Figure 36. Installing the air shroud

Next steps

1. Follow the procedure listed in [After working inside your system](#).

Cooling fans

Removing a cooling fan

The procedure for removing standard and high performance fans is identical.

Prerequisites

NOTE: Opening or removing the system cover when the system is on may expose you to a risk of electric shock. Exercise utmost care while removing or installing cooling fans.

CAUTION: The cooling fans are hot swappable. To maintain proper cooling while the system is on, replace only one fan at a time.

1. Follow the safety guidelines listed in [Safety instructions](#).
2. [Remove the air shroud](#).

Steps

1. Holding the touch points on the cooling fan, lift the fan to disconnect the connector on the fan from the connector on the system board.
2. Lift the fan out of the system.

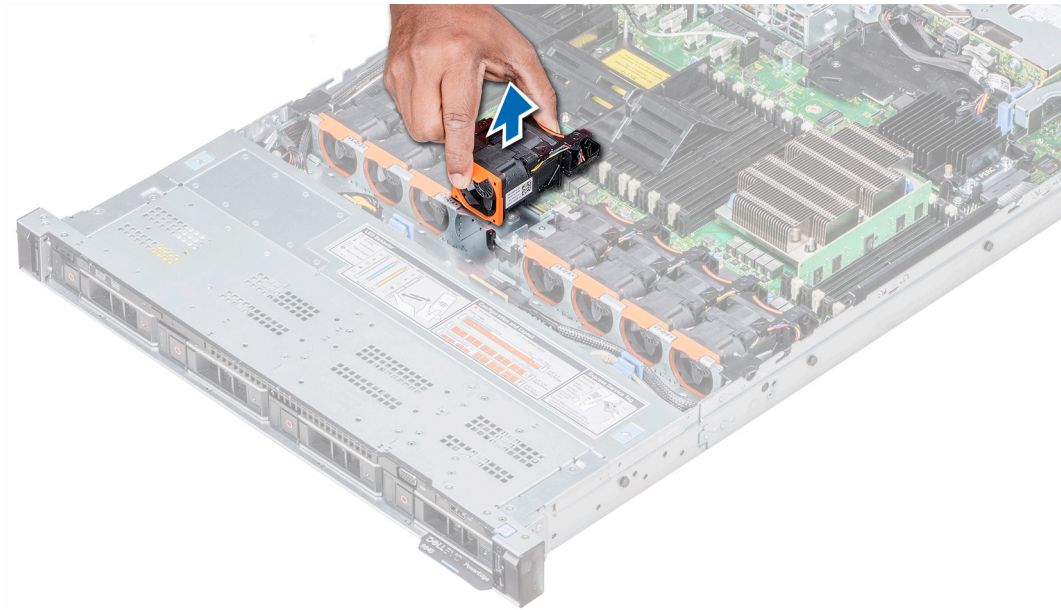

Figure 37. Removing the cooling fan

Next steps

If applicable, [install the cooling fan](#).

Installing a cooling fan

The procedure for installing standard and high performance fans is identical.

Prerequisites

NOTE: Opening or removing the system cover when the system is on may expose you to a risk of electric shock. Exercise utmost care while removing or installing cooling fans.

CAUTION: The cooling fans are hot swappable. To maintain proper cooling while the system is on, replace only one fan at a time.

Follow the safety guidelines listed in [Safety instructions](#).

Steps

1. Holding the touch points on the cooling fan, align the connector on the cooling fan with the connector on the system board.
2. Push the cooling fan, by pressing on the touch point, till the fan is firmly seated on the connector.

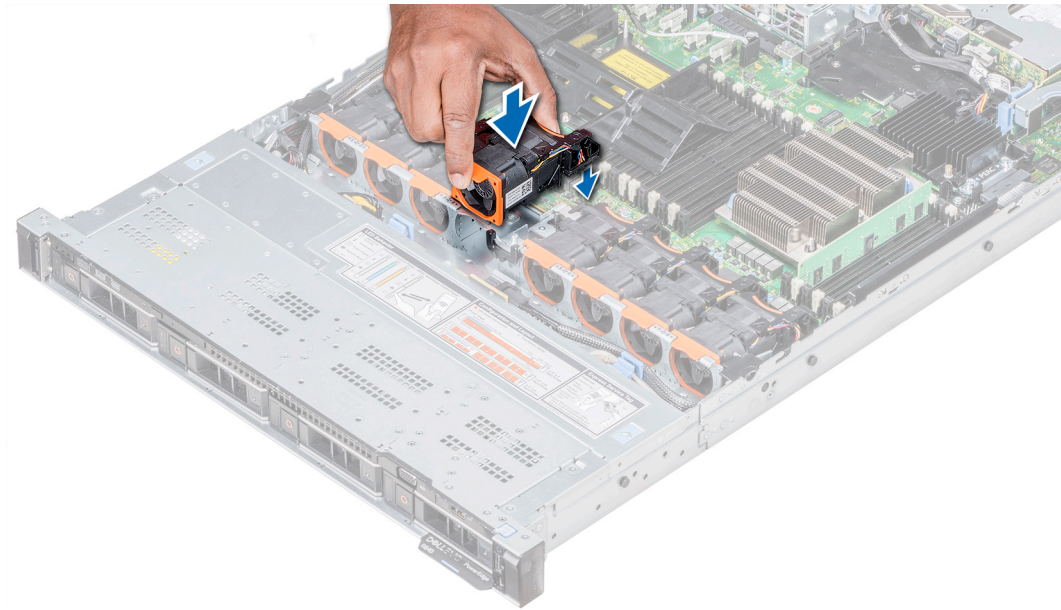

Figure 38. Installing the cooling fan

Next steps

1. [Install the air shroud.](#)
2. Follow the procedure listed in [After working inside your system.](#)

System memory

System memory guidelines

The PowerEdge systems support DDR4 Registered DIMMs (RDIMMs), Load Reduced DIMMs (LRDIMMs), Non-Volatile DIMMs (NVDIMM-Ns), and Intel Optane Data Center Persistent Memory Modules (DCPMMs). System memory holds the instructions that are executed by the processor.

Your system contains 24 memory sockets split into two sets of 12 sockets, one set per processor. Each 12-socket set is organized into six channels. Six memory channels are allocated to each processor. In each channel, the release tabs of the first socket are marked white, and the second socket black.

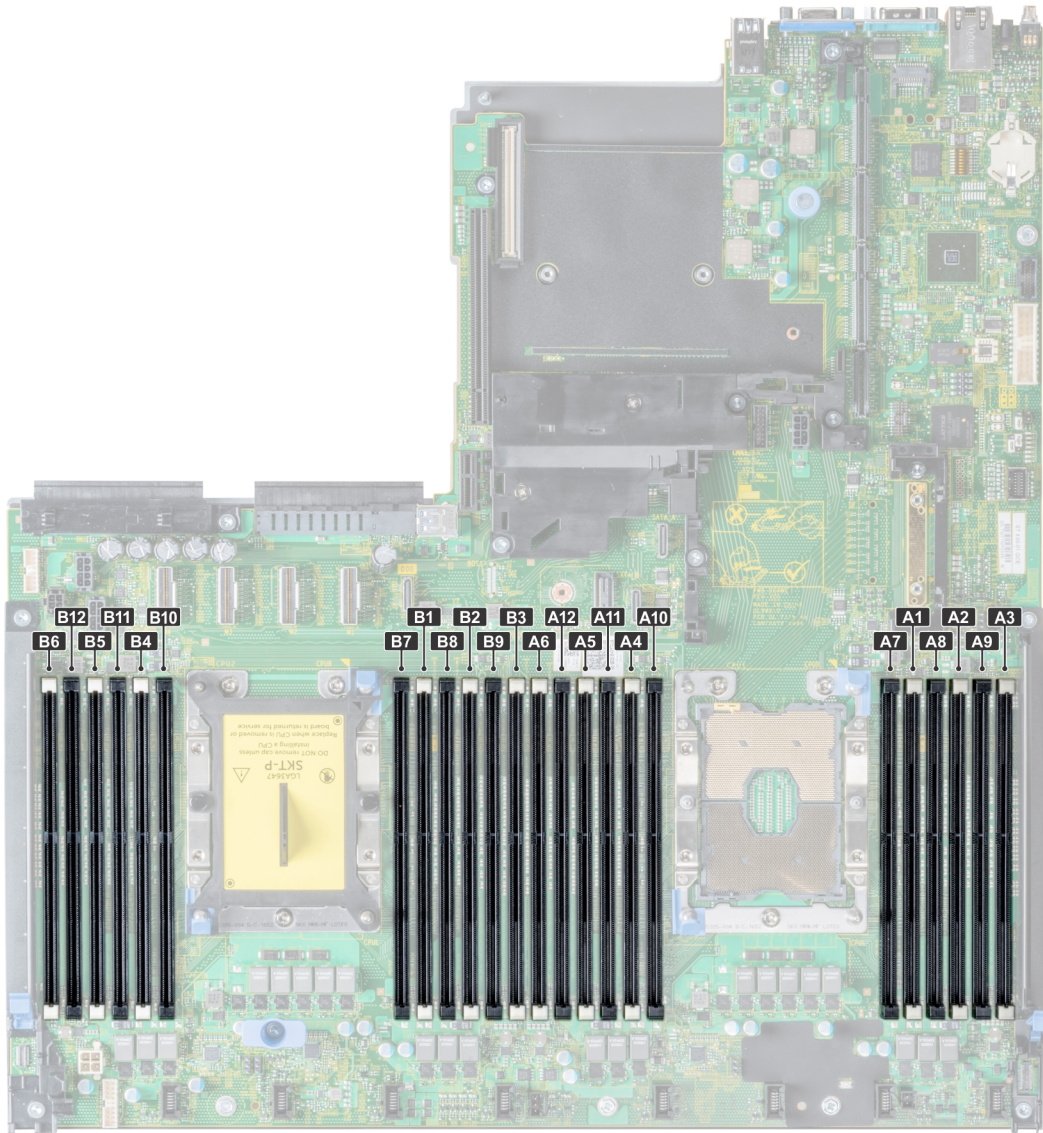

Figure 39. System memory view

Memory channels are organized as follows:

Table 44. Memory channels

Processor	Channel 0	Channel 1	Channel 2	Channel 3	Channel 4	Channel 5
Processor 1	Slots A1 and A7	Slots A2 and A8	Slots A3 and A9	Slots A4 and A10	Slots A5 and A11	Slots A6 and A12
Processor 2	Slots B1 and B7	Slots B2 and B8	Slots B3 and B9	Slots B4 and B10	Slots B5 and B11	Slots B6 and B12

General memory module installation guidelines

To ensure optimal performance of your system, observe the following general guidelines when configuring your system memory. If your system's memory configurations fail to observe these guidelines, your system might not boot, stop responding during memory configuration, or operate with reduced memory.

The memory bus may operate at frequency can be 2933 MT/s, 2666 MT/s, 2400 MT/s, or 2133 MT/s depending on the following factors:

- System profile selected (for example, Performance Optimized, or Custom [can be run at high speed or lower])
- Maximum supported DIMM speed of the processors. For memory frequency of 2933 MT/s, one DIMM per channel is supported.
- Maximum supported speed of the DIMMs

NOTE: MT/s indicates DIMM speed in MegaTransfers per second.

The system supports Flexible Memory Configuration, enabling the system to be configured and run in any valid chipset architectural configuration. The following are the recommended guidelines for installing memory modules:

- All DIMMs must be DDR4.
- RDIMMs and LRDIMMs must not be mixed.
- NVDIMMs and LRDIMMs must not be mixed.
- NVDIMMs and RDIMMs can be mixed.
- 64 GB LRDIMMs that are DDP (Dual Die Package) LRDIMMs must not be mixed with 128 GB LRDIMMs that are TSV (Through Silicon Via/3DS) LRDIMMs.
- x4 and x8 DRAM based memory modules can be mixed.
- Up to two RDIMMs can be populated per channel regardless of rank count.
- Up to two LRDIMMs can be populated per channel regardless of rank count.
- A maximum of two different ranked DIMMs can be populated in a channel regardless of rank count.
- If memory modules with different speeds are installed, they will operate at the speed of the slowest installed memory module(s).
- Populate memory module sockets only if a processor is installed.
 - For single-processor systems, sockets A1 to A12 are available.
 - For dual-processor systems, sockets A1 to A12 and sockets B1 to B12 are available.
- Populate all the sockets with white release tabs first, followed by the black release tabs.
- When mixing memory modules with different capacities, populate the sockets with memory modules with the highest capacity first.

For example, if you want to mix 8 GB and 16 GB memory modules, populate 16 GB memory modules in the sockets with white release tabs and 8 GB memory modules in the sockets with black release tabs.
- Memory modules of different capacities can be mixed provided other memory population rules are followed.

For example, 8 GB and 16 GB memory modules can be mixed.
- In a dual-processor configuration, the memory configuration for each processor must be identical.

For example, if you populate socket A1 for processor 1, then populate socket B1 for processor 2, and so on.
- Mixing of more than two memory module capacities in a system is not supported.
- Unbalanced memory configurations will result in a performance loss so always populate memory channels identically with identical DIMMs for best performance.
- Populate six identical memory modules per processor (one DIMM per channel) at a time to maximize performance.

DIMM population update for Performance Optimized mode with quantity of 4 and 8 DIMMs per processor.

- When the DIMM quantity is 4 per processor, the population is slot 1, 2, 4, 5.
- When the DIMM quantity is 8 per processor, the population is slot 1, 2, 4, 5, 7, 8, 10, 11.

NVDIMM-N memory module installation guidelines

The following are the recommended guidelines for installing NVDIMM-N memory modules:

- Each system supports memory configurations with 1, 2, 4, 6, or 12 NVDIMM-Ns.
- Supported configurations have dual processors and a minimum of 12x RDIMMs.
- Maximum of 12 NVDIMM-Ns can be installed in a system.
- NVDIMM-Ns or RDIMMs must not be mixed with LRDIMMs.
- DDR4 NVDIMM-Ns must be populated only on the black release tabs on processor 1 and 2.
- All slots on configurations 3, 6, 9, and 12 can be used, but a maximum of 12 NVDIMM-Ns can be installed in a system.

For more information on the supported NVDIMM-N configurations, see the *NVDIMM-N User Guide* at www.dell.com/poweredge manuals.

Table 45. Supported NVDIMM-N for dual processor configurations

Configuration	Description	Memory population rules	
		RDIMMs	NVDIMM-N
Configuration 1	12x 16 GB RDIMMs, 1x NVDIMM-N	Processor1 {A1, 2, 3, 4, 5, 6} Processor2 {B1, 2, 3, 4, 5, 6}	Processor1 {A7}
Configuration 2	12x 32 GB RDIMMs, 1x NVDIMM-N	Same for all 12x RDIMM configurations. See Configuration 1.	Processor1 {A7}
Configuration 3	23x 32 GB RDIMMs, 1x NVDIMM-N	Processor1 {A1, 2, 3, 4, 5, 6, 7, 8, 9, 10, 11, 12} Processor2 {B1, 2, 3, 4, 5, 6, 7, 8, 9, 10, 11}	Processor2 {B12}
Configuration 4	12x 16 GB RDIMMs, 2x NVDIMM-Ns	Same for all 12x RDIMM configurations. See Configuration 1.	Processor1 {A7} Processor2 {B7}
Configuration 5	12x 32 GB RDIMMs, 2x NVDIMM-Ns	Same for all 12x RDIMM configurations. See Configuration 1.	Processor1 {A7} Processor2 {B7}
Configuration 6	22x 32 GB RDIMMs, 2x NVDIMM-Ns	Processor1 {A1, 2, 3, 4, 5, 6, 7, 8, 9, 10, 11} Processor2 {B1, 2, 3, 4, 5, 6, 7, 8, 9, 10, 11}	Processor1 {A12} Processor2 {B12}
Configuration 7	12x 16 GB RDIMMs, 4x NVDIMM-Ns	Same for all 12x RDIMM configurations. See Configuration 1.	Processor1 {A7, A8} Processor2 {B7, B8}
Configuration 8	22x 32 GB RDIMMs, 4x NVDIMM-Ns	Same for all 12x RDIMM configurations. See Configuration 1.	Processor1 {A7, A8} Processor2 {B7, B8}
Configuration 9	20x 32 GB RDIMMs, 4x NVDIMM-Ns	Processor1 {A1, 2, 3, 4, 5, 6, 7, 8, 9, 10} Processor2 {B1, 2, 3, 4, 5, 6, 7, 8, 9, 10}	Processor1 {A11, 12} Processor2 {B11, 12}
Configuration 10	12x 16 GB RDIMMs, 6x NVDIMM-Ns	Same for all 12x RDIMM configurations. See Configuration 1.	Processor1 {A7, 8, 9} Processor2 {B7, 8, 9}
Configuration 11	12x 32 GB RDIMMs, 6x NVDIMM-Ns	Same for all 12x RDIMM configurations. See Configuration 1.	Processor1 {A7, 8, 9} Processor2 {B7, 8, 9}
Configuration 12	18x 32 GB RDIMMs, 6x NVDIMM-Ns	Processor1 {1, 2, 3, 4, 5, 6, 7, 8, 9} Processor2 {1, 2, 3, 4, 5, 6, 7, 8, 9}	Processor1 {A10, 11, 12} Processor2 {B10, 11, 12}
Configuration 13	12x 16 GB RDIMMs, 12x NVDIMM-Ns	Same for all 12x RDIMM configurations. See Configuration 1.	Processor1 {A7, 8, 9, 10, 11, 12} Processor2 {B7, 8, 9, 10, 11, 12}

Configuration	Description	Memory population rules	
		RDIMMs	NVDIMM-N
Configuration 14	12x 32 GB RDIMMs, 12x NVDIMM-Ns	Same for all 12x RDIMM configurations. See Configuration 1.	Processor1 {A7, 8, 9, 10, 11, 12} Processor2 {B7, 8, 9, 10, 11, 12}

DCPMM installation guidelines

The following are the recommended guidelines for installing data center persistent memory module (DCPMM) memory modules:

- Each system supports maximum of one DCPMM memory module per channel.
- NOTE:** If two different DCPMM capacities are mixed, an F1/F2 warning is displayed as the configuration is not supported.
- DCPMM can be mixed with RDIMM, LRDIMM, and 3DS LRDIMM.
- Mixing of DDR4 DIMM types (RDIMM, LRDIMM, and 3DS LRDIMM), within channels, for Integrated Memory Controller (iMC), or across sockets are not supported.
- Mixing of DCPMM operating modes (App Direct, Memory Mode) is not supported.
- If only one DIMM is populated on a channel, it should always go to the first slot in that channel (white slot).
- If a DCPMM and a DDR4 DIMM are populated on the same channel, always plug DCPMM on second slot (black slot).
- If the DCPMM is configured in Memory Mode, the recommended DDR4 to DCPMM capacity ratio is 1:4 to 1:16 per iMC.
- DCPMMs cannot be mixed with other DCPMMs or NVDIMMs.
- Mixing different capacities of RDIMMs and LRDIMMs are not allowed when DCPMM is installed.
- DCPMMs of different capacities are not allowed.

For more information about the supported DCPMM configurations, see the *Dell EMC DCPMM User 's Guide* at https://www.dell.com/support/home/us/en/19/products/server_int/server_int_poweredge.

Table 46. Memory Mode configurations (Dual and Quad socket)

Optane DIMMs per CPU	DRAM DIMMs per CPU	Total capacity per CPU	2 Socket OS Memory capacity	4 Socket OS Memory capacity	DDR:DCPMM ratio
6 X 128 GB	6 X 32 GB	960 GB	1.5 TB	3 TB	1:4
6 X 256 GB	6 X 32 GB	1728 GB	3 TB	6 TB	1:8
6 X 256 GB	6 X 64 GB	1920 GB	3 TB	6 TB	1:4
6 X 512 GB	6 X 64 GB	3456 GB	6 TB	12 TB	1:8
6 X 512 GB	6 X 128 GB	3840 GB	6 TB	12 TB	1:4

Table 47. App Direct Mode configurations (Dual and Quad socket)

Optane DIMMs per CPU	DRAM DIMMs per CPU	Total capacity per CPU	2 Socket OS Memory capacity	4 Socket OS Memory capacity	2 Socket App Direct Optane capacity	4 Socket App Direct Optane capacity
6 X 128 GB	6 X 32 GB	960 GB	384 GB	768 GB	1.5 TB	3 TB
6 X 128 GB	6 X 64 GB	1152 GB	768 GB	1.5 TB	1.5 TB	3 TB
6 X 128 GB	6 X 128 GB	1536 GB	1.5 TB	3 TB	1.5 TB	3 TB
4 X 256 GB	6 X 32 GB	1216 GB	384 GB	768 GB	2 TB	4 TB
6 X 256 GB	6 X 32 GB	1728 GB	384 GB	768 GB	3 TB	6 TB
4 X 256 GB	6 X 64 GB	1408 GB	768 GB	1.5 TB	2 TB	4 TB
6 X 256 GB	6 X 64 GB	1920 GB	768 GB	1.5 TB	3 TB	6 TB
6 X 256 GB	6 X 128 GB	2304 GB	1.5 TB	3 TB	3 TB	6 TB
4 X 512 GB	6 X 32 GB	2240 GB	384 GB	768 GB	4 TB	8 TB
6 X 512 GB	6 X 32 GB	3264 GB	384 GB	768 GB	6 TB	12 TB
4 X 512 GB	6 X 64 GB	2432 GB	768 GB	1.5 TB	4 TB	8 TB

Optane DIMMs per CPU	DRAM DIMMs per CPU	Total capacity per CPU	2 Socket OS Memory capacity	4 Socket OS Memory capacity	2 Socket App Direct Optane capacity	4 Socket App Direct Optane capacity
6 X 512 GB	6 X 64 GB	3456 GB	768 GB	1.5 TB	6 TB	12 TB
6 X 512 GB	6 X 128 GB	3840 GB	1.5 TB	3 TB	6 TB	12 TB

Table 48. App Direct Mode configurations (Single CPU in Dual Socket Systems)

Optane DIMMs	DRAM DIMMs	Total capacity	OS Memory capacity	App Direct Optane capacity
1 X 128 GB	6 X 32 GB	320 GB	192 GB	128 GB
1 X 128 GB	6 X 64 GB	512 GB	384 GB	128 GB

NOTE: There are limited configurations available for Dual Socket Servers with only one CPU populated.

Mode-specific guidelines



The configurations allowed depend on the memory mode selected in the System BIOS.

Table 49. Memory operating modes

Memory Operating Mode	Description
Optimizer Mode	<p>The Optimizer Mode if enabled, the DRAM controllers operate independently in the 64-bit mode and provide optimized memory performance.</p> <p>NOTE: DCPMM supports only Optimizer mode.</p>
Mirror Mode	<p>The Mirror Mode if enabled, the system maintains two identical copies of data in memory, and the total available system memory is one half of the total installed physical memory. Half of the installed memory is used to mirror the active memory modules. This feature provides maximum reliability and enables the system to continue running even during a catastrophic memory failure by switching over to the mirrored copy. The installation guidelines to enable Mirror Mode require that the memory modules be identical in size, speed, and technology, and they must be populated in sets of 6 per processor.</p>
Single Rank Spare Mode	<p>Single Rank Spare Mode allocates one rank per channel as a spare. If excessive correctable errors occur in a rank or channel, while the operating system is running, they are moved to the spare area to prevent errors from causing an uncorrectable failure. Requires two or more ranks to be populated in each channel.</p>
Multi Rank Spare Mode	<p>Multi Rank Spare Mode allocates two ranks per channel as a spare. If excessive correctable errors occur in a rank or channel, while the operating system is running, they are moved to the spare area to prevent errors from causing an uncorrectable failure. Requires three or more ranks to be populated in each channel.</p> <p>With single rank memory sparing enabled, the system memory available to the operating system is reduced by one rank per channel.</p> <p>For example, in a dual-processor configuration with 24x 16 GB dual-rank memory modules, the available system memory is: $\frac{3}{4}$ (ranks/channel) \times 24 (memory modules) \times 16 GB = 288 GB, and not 24 (memory modules) \times 16 GB = 384 GB. For multi rank sparing, the multiplier changes to $\frac{1}{2}$ (ranks/channel).</p>



Memory Operating Mode

Description

-  **NOTE: To use memory sparing, this feature must be enabled in the BIOS menu of System Setup.**
-  **NOTE: Memory sparing does not offer protection against a multi-bit uncorrectable error.**

Dell Fault Resilient Mode

The **Dell Fault Resilient Mode** if enabled, the BIOS creates an area of memory that is fault resilient. This mode can be used by an OS that supports the feature to load critical applications or enables the OS kernel to maximize system availability.

-  **NOTE: This feature is only supported in Gold and Platinum Intel processors.**
-  **NOTE: Memory configuration has to be of same size DIMM, speed, and rank.**

Optimizer Mode

This mode supports Single Device Data Correction (SDDC) only for memory modules that use x4 device width. It does not impose any specific slot population requirements.

- Dual processor: Populate the slots in round robin sequence starting with processor 1.

 **NOTE: Processor 1 and processor 2 population should match.**

Table 50. Memory population rules

Processor	Configuration	Memory population	Memory population information
Single processor	Optimizer (Independent channel) population order	1, 2, 3, 4, 5, 6, 7, 8, 9, 10, 11, 12	<ul style="list-style-type: none"> • DIMMs must be populated in the order specified. • Odd number of DIMM population is allowed  NOTE: Odd number of DIMMs will result in unbalanced memory configurations, which in turn will result in performance loss. It is recommended to populate all memory channels identically with identical DIMMs for best performance. • Optimizer population order is not traditional for 4 and 8 DIMM installations of single processor. <ul style="list-style-type: none"> • For 4 DIMMs: A1, A2, A4, A5 • For 8 DIMMs: A1, A2, A4, A5, A7, A8, A10, A11
	Mirror population order	{1, 2, 3, 4, 5, 6} {7, 8, 9, 10, 11, 12}	Mirroring is supported with 6 or 12 DIMMs per processor.
	Single rank sparing population order	1, 2, 3, 4, 5, 6, 7, 8, 9, 10, 11, 12	<ul style="list-style-type: none"> • DIMMs must be populated in the order specified. • Requires two ranks or more per channel.
	Multi rank sparing population order	1, 2, 3, 4, 5, 6, 7, 8, 9, 10, 11, 12	<ul style="list-style-type: none"> • DIMMs must be populated in the order specified. • Requires three ranks or more per channel.
	Fault resilient population order	{1, 2, 3, 4, 5, 6} {7, 8, 9, 10, 11, 12}	Supported with 6 or 12 DIMMs per processor.
Dual processor (Start with processor1. processor1 and	Optimized (Independent channel) population order	A{1}, B{1}, A{2}, B{2},	Odd number of DIMM population per processor is allowed.

Processor	Configuration	Memory population	Memory population information
processor 2 population should match)		A{3}, B{3}, A{4}, B{4}, A{5}, B{5}, A{6}, B{6}	<p>NOTE: Odd number of DIMMs will result in unbalanced memory configurations, which in turn will result in performance loss. It is recommended to populate all memory channels identically with identical DIMMs for best performance.</p> <p>Optimizer population order is not traditional for 8 and 16 DIMMs installations for dual processor.</p> <ul style="list-style-type: none"> For 8 DIMMs: A1, A2, A4, A5, B1, B2, B4, B5 For 16 DIMMs: A1, A2, A4, A5, A7, A8, A10, A11 B1, B2, B4, B5, B7, B8, B10, B11
	Mirroring population order	A{1, 2, 3, 4, 5, 6}, B{1, 2, 3, 4, 5, 6}, A{7, 8, 9, 10, 11, 12}, B{7, 8, 9, 10, 11, 12}	Mirroring is supported with 6 or 12 DIMMs per processor.
	Single rank sparing population order	A{1}, B{1}, A{2}, B{2}, A{3}, B{3}, A{4}, B{4}, A{5}, B{5}, A{6}, B{6}	<ul style="list-style-type: none"> DIMMs must be populated in the order specified. Requires two ranks or more per channel.
	Multi rank sparing population order	A{1}, B{1}, A{2}, B{2}, A{3}, B{3}, A{4}, B{4}, A{5}, B{5}, A{6}, B{6}	<ul style="list-style-type: none"> DIMMs must be populated in the order specified. Requires three ranks or more per channel.
	Fault resilient population order	A{1, 2, 3, 4, 5, 6}, B{1, 2, 3, 4, 5, 6}, A{7, 8, 9, 10, 11, 12}, B{7, 8, 9, 10, 11, 12}	Supported with 6 or 12 DIMMs per processor.

Removing a memory module

The procedure for removing a DIMM module, an NVDIMM-N module, and a DCPMM are identical.

Prerequisites

1. Follow the safety guidelines listed in [Safety instructions](#).
2. Follow the procedure listed in [Before working inside your system](#).
 **CAUTION:** To prevent data loss and potential damage to your system, ensure that your system, LEDs on system, LEDs on NVDIMM-N and LEDs on NVDIMM-N battery are turned off before removing the NVDIMM-N battery.
3. If applicable, [remove the air shroud](#).

 **WARNING:** Allow the memory modules to cool after you power off the system. Handle the memory modules by the card edges and avoid touching the components or metallic contacts on the memory module.

 **CAUTION:** To ensure proper system cooling, memory module blanks must be installed in any memory socket that is not occupied. Remove memory module blanks only if you intend to install memory modules in those sockets.

Steps

1. Locate the appropriate memory module socket.

CAUTION: Handle each memory module only by the card edges, ensuring not to touch the middle of the memory module or metallic contacts.

2. Push the ejectors outward on both ends of the memory module socket to release the memory module from the socket.
3. Lift and remove the memory module from the system.

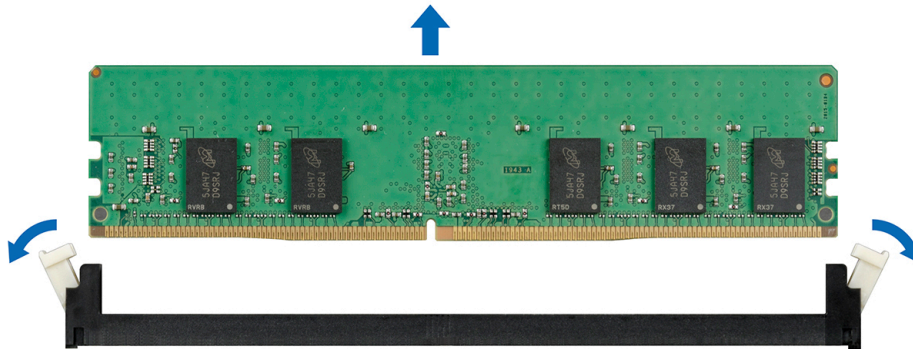

Figure 40. Removing a memory module

Next steps

1. [Install the memory module.](#)
2. If you are removing the memory module permanently, install a memory module blank. The procedure to install a memory module blank is similar to that of the memory module.

Installing a memory module

The procedure for installing a DIMM module, an NVDIMM-N module, and a DCPMM are identical.

Prerequisites

Follow the safety guidelines listed in [Safety instructions](#).

CAUTION: Ensure that you install the NVDIMM-N battery if you are using NVDIMM-N.

CAUTION: To prevent data loss and potential damage to your system, ensure that your system, LEDs on system, LEDs on NVDIMM-N and LEDs on NVDIMM-N battery are turned off before installing the NVDIMM-N battery.

CAUTION: To ensure proper system cooling, memory module blanks must be installed in any memory socket that is not occupied. Remove memory module blanks only if you intend to install memory modules in those sockets.

Steps

1. Locate the appropriate memory module socket.

CAUTION: Handle each memory module only by the card edges, ensuring not to touch the middle of the memory module or metallic contacts.

CAUTION: To prevent damage to the memory module or the memory module socket during installation, do not bend or flex the memory module. You must insert both ends of the memory module simultaneously.

2. Open the ejectors on the memory module socket outward to allow the memory module to be inserted into the socket.
3. Align the edge connector of the memory module with the alignment key of the memory module socket, and insert the memory module in the socket.

CAUTION: Do not apply pressure at the center of the memory module; apply pressure at both ends of the memory module evenly.

NOTE: The memory module socket has an alignment key that enables you to install the memory module in the socket in only one orientation.

4. Press the memory module with your thumbs until the socket levers firmly click into place.

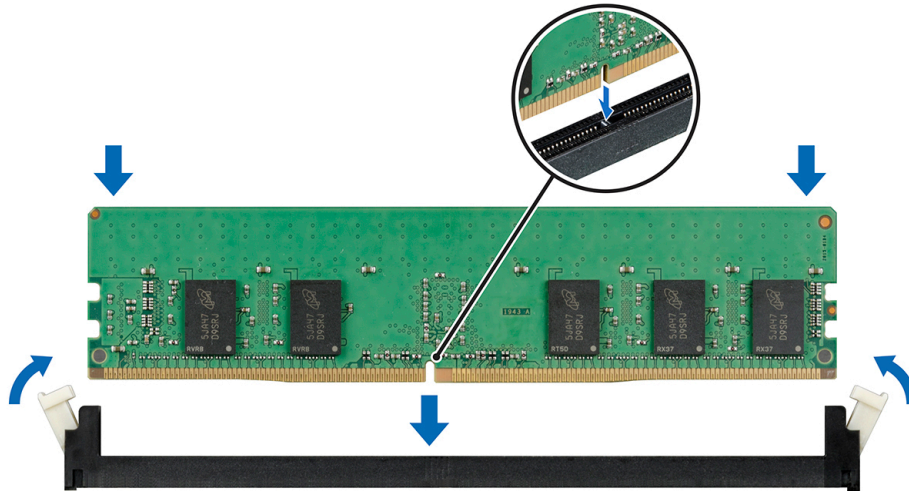

Figure 41. Installing a memory module

Next steps

1. [Install the air shroud.](#)
2. Follow the procedure listed in [After working inside your system.](#)
3. To verify if the memory module has been installed properly, press F2 and go to **System Setup Main Menu > System BIOS > Memory Settings**. In the **Memory Settings** screen, the System Memory Size must reflect the updated capacity of the installed memory.
4. If the value is incorrect, one or more of the memory modules may not be installed properly. Ensure that the memory module is firmly seated in the memory module socket.
5. Run the system memory test in system diagnostics.

NVDIMM-N battery

Removing the NVDIMM-N battery

Prerequisites

1. Follow the safety guidelines listed in [Safety instructions.](#)
2. Follow the procedure listed in [Before working inside your system.](#)
 - ⚠ **CAUTION:** To prevent data loss, ensure that your system and LEDs on NVDIMM-N and NVDIMM-N battery are turned off before removing the NVDIMM-N battery.
 - ⚠ **CAUTION:** To avoid damage to the battery connector, you must firmly support the connector while installing or removing a battery.
3. Disconnect the cables from the NVDIMM-N battery.

Steps

1. Using the Phillips #2 screwdriver, loosen the screw securing the NVDIMM-N battery.
2. Holding the edges, lift the NVDIMM-N battery away from the system.

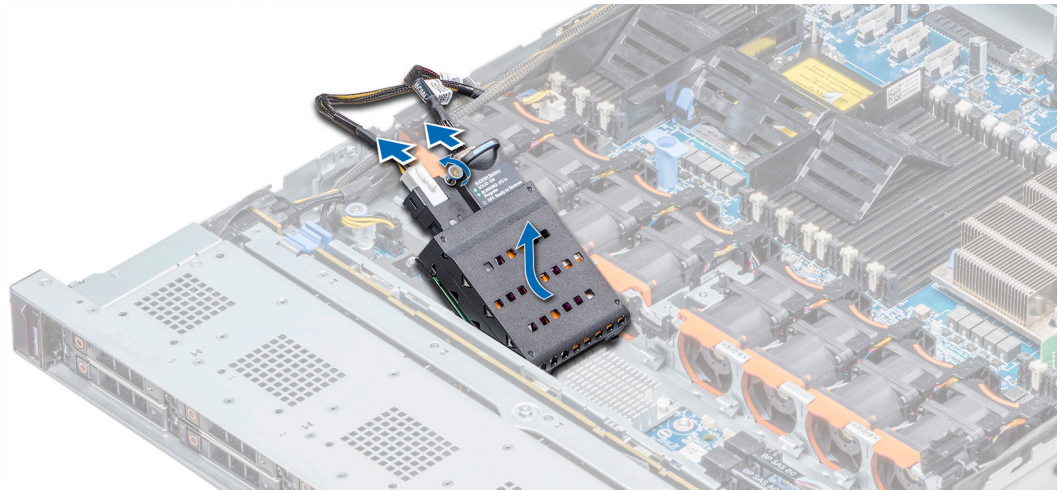

Figure 42. Removing the NVDIMM-N battery

Next steps

1. [Install the NVDIMM-N battery.](#)

Installing the NVDIMM-N battery

Prerequisites

1. Follow the safety guidelines listed in [Safety instructions](#).

CAUTION: To prevent data loss, ensure that your system and LEDs on NVDIMM-N and NVDIMM-N battery are turned off before removing the NVDIMM-N battery.

CAUTION: To avoid damage to the battery connector, you must firmly support the connector while installing or removing a battery.

Steps

1. Holding the edges, align the NVDIMM-N battery with the battery connector on the system board
2. Connect the cables to the NVDIMM-N battery.
3. Using the Phillips #2 screwdriver, tighten the screw to secure the NVDIMM-N battery.

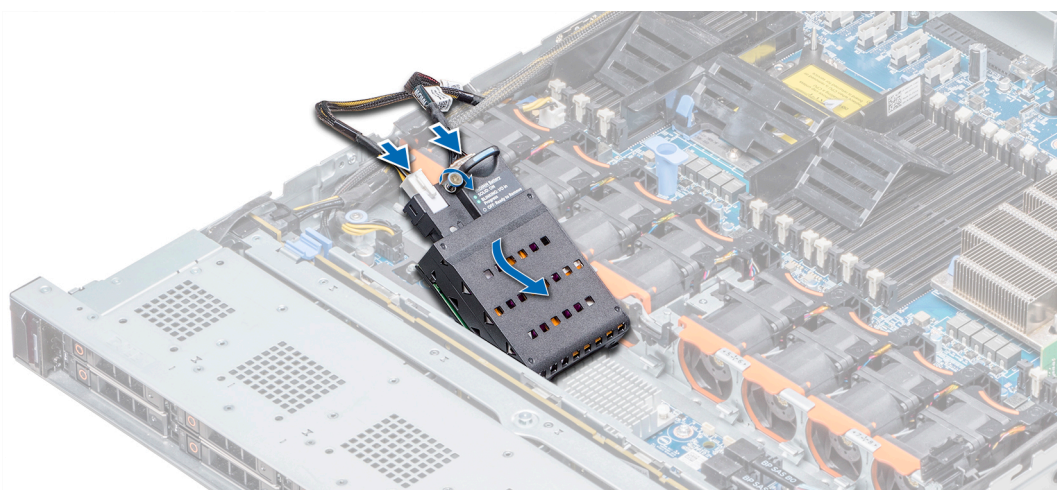

Figure 43. Installing the NVDIMM-N battery

Next steps

1. Follow the procedure listed in [After working inside your system](#).

Processors and heat sinks

Removing a processor and heat sink module

Prerequisites

⚠ WARNING: The heat sink may be hot to touch for some time after the system is powered down. Allow the heat sink to cool before removing it.

1. Follow the safety guidelines listed in [Safety instructions](#).
2. Follow the procedure listed in [Before working inside your system](#).
3. If applicable, [remove the air shroud](#).

Steps

1. Using a Torx #T30 screwdriver, loosen the screws on the heat sink in the order below:
 - a) Loosen the first screw three turns.
 - b) Loosen the second screw completely.
 - c) Return to the first screw and loosen it completely.
2. Pushing both blue retention clips simultaneously, lift the processor and heat sink module (PHM) processor and heat sink module
3. Set the PHM aside with the processor side facing up.

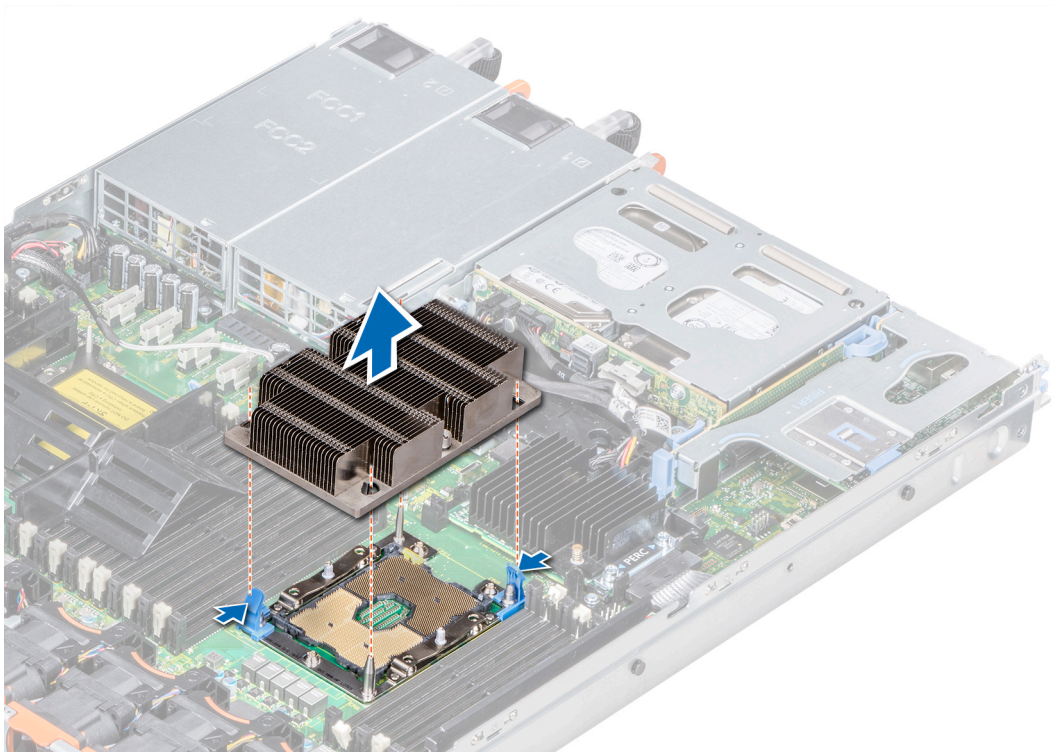

Figure 44. Removing the processor and heat sink module

Next steps

[Install the PHM.](#)

Removing the processor from the processor and heat sink module

Prerequisites

NOTE: Only remove the processor from the processor and heat sink module if you are replacing the processor or heat sink. This procedure is not required when replacing a system board.

1. Follow the safety guidelines listed in [Safety instructions](#).
2. Follow the procedure listed in [Before working inside your system](#).
3. [Remove the air shroud](#).
4. [Remove the processor and heat sink module](#).

Steps

1. Place the heat sink with the processor side facing up.
2. Insert a flat blade screwdriver into the release slot marked with a yellow label. Twist (do not pry) the screwdriver to break the thermal paste seal.
3. Push the retaining clips on the processor bracket to unlock the bracket from the heat sink.

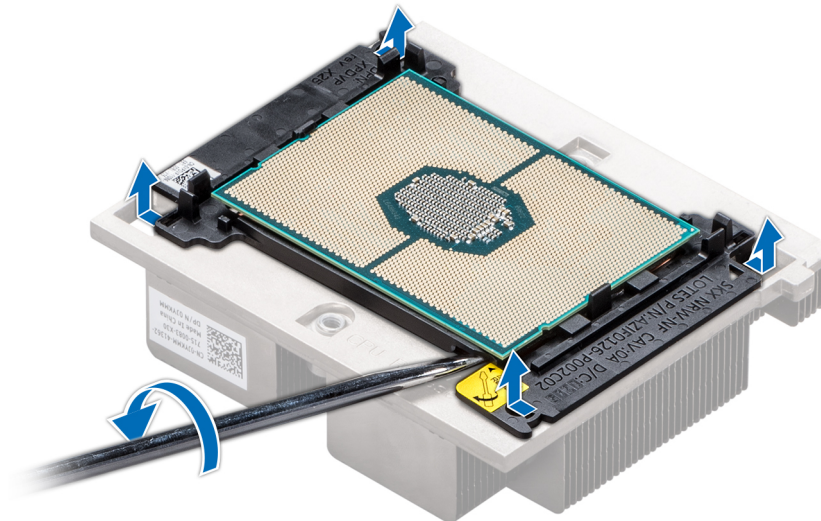

Figure 45. Loosening the processor bracket

4. Lift the bracket and the processor away from the heat sink, and place the processor connector side down on the processor tray.
5. Flex the outer edges of the bracket to release the bracket from the processor.

NOTE: Ensure that the processor and the bracket are placed in the tray after you remove the heat sink.



Figure 46. Removing the processor bracket

Next steps

Install the processor into the processor and heat sink module.

Installing the processor into a processor and heat sink module

Prerequisites

Follow the safety guidelines listed in [Safety instructions](#).

Steps

1. Place the processor in the processor tray.

NOTE: Ensure that the pin 1 indicator on the processor tray is aligned with the pin 1 indicator on the processor.

2. Flex the outer edges of the bracket around the processor ensuring that the processor is locked into the clips on the bracket.

NOTE: Ensure that the pin 1 indicator on the bracket is aligned with the pin 1 indicator on the processor before placing the bracket on the processor.

NOTE: Ensure that the processor and the bracket are placed in the tray before you install the heat sink.

Figure 47. Installing the processor bracket

3. If you are using an existing heat sink, remove the thermal grease from the heat sink by using a clean lint-free cloth.
4. Use the thermal grease syringe included with your processor kit to apply the grease in a quadrilateral design on the top of the processor.

CAUTION: Applying too much thermal grease can result in excess grease coming in contact with and contaminating the processor socket.

NOTE: The thermal grease syringe is intended for single use only. Dispose the syringe after you use it.

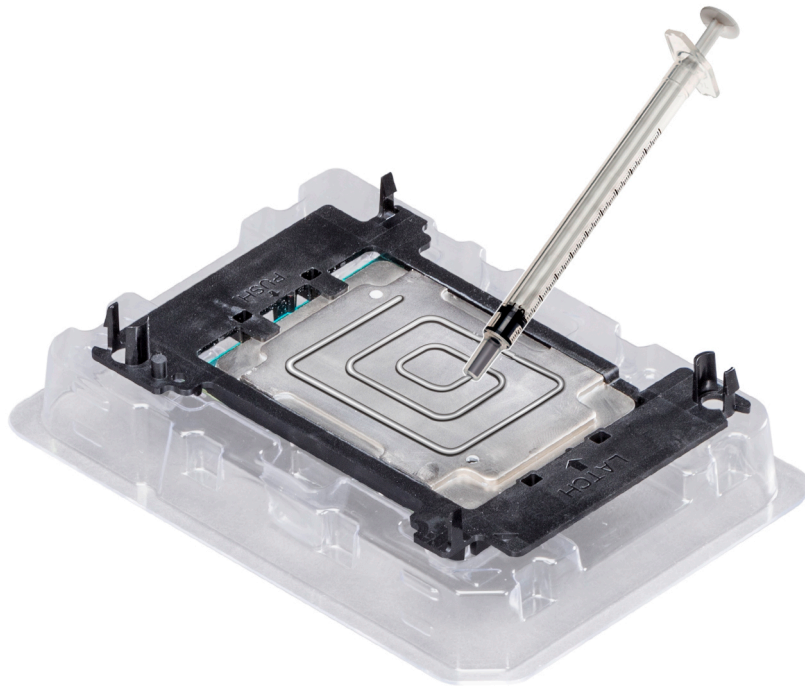

Figure 48. Applying thermal grease on top of the processor

5. Place the heat sink on the processor and push down on the base of the heat sink until the bracket locks onto the heat sink.

i NOTE:

- Ensure that the two guide pin holes on the bracket match the guide holes on the heat sink.
- Do not press on the heat sink fins.
- Ensure that the pin 1 indicator on the heat sink is aligned with the pin 1 indicator on the bracket before placing the heat sink onto the processor and bracket.

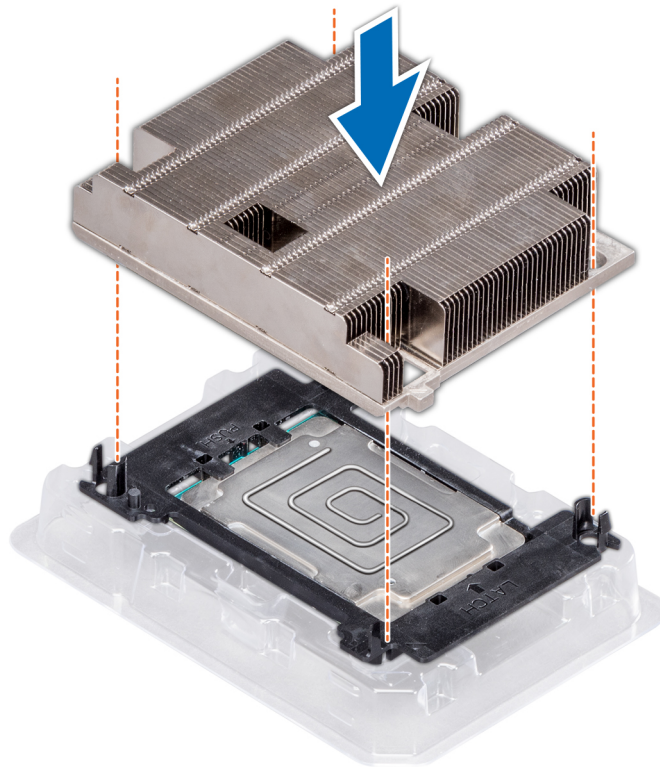

Figure 49. Installing the heat sink onto the processor

Next steps

1. [Install the processor and heat sink module.](#)
2. [Install the air shroud.](#)
3. Follow the procedure listed in [After working inside your system.](#)

Installing a processor and heat sink module

Prerequisites

⚠ CAUTION: Never remove the heat sink from a processor unless you intend to replace the processor. The heat sink is necessary to maintain proper thermal conditions.

1. Follow the safety guidelines listed in [Safety instructions.](#)
2. If installed, remove the processor blank and CPU dust cover.

Steps

1. Align the pin 1 indicator of the heat sink to the system board and then place the processor and heat sink module (PHM) on the processor socket.

⚠ CAUTION: To avoid damaging the fins on the heat sink, do not press down on the heat sink fins.

i NOTE: Ensure that the PHM is held parallel to the system board to prevent damaging the components.

2. Push the blue retention clips inward to allow the heat sink to drop into place.
3. Using the Torx #T30 screwdriver, tighten the screws on the heat sink in the order below:
 - a) Partially tighten the first screw (approximately 3 turns).
 - b) Tighten the second screw completely.
 - c) Return to the first screw and tighten it completely.

If the PHM slips off the blue retention clips when the screws are partially tightened, follow these steps to secure the PHM:

- a. Loosen both the heat sink screws completely.

- b. Lower the PHM on to the blue retention clips, following the procedure described in step 2.
- c. Secure the PHM to the system board, following the replacement instructions listed in this step above. 4.

NOTE: The processor and heat sink module retention screws should not be tightened to more than 0.13 kgf-m (1.35 N.m or 12 in-lbf).

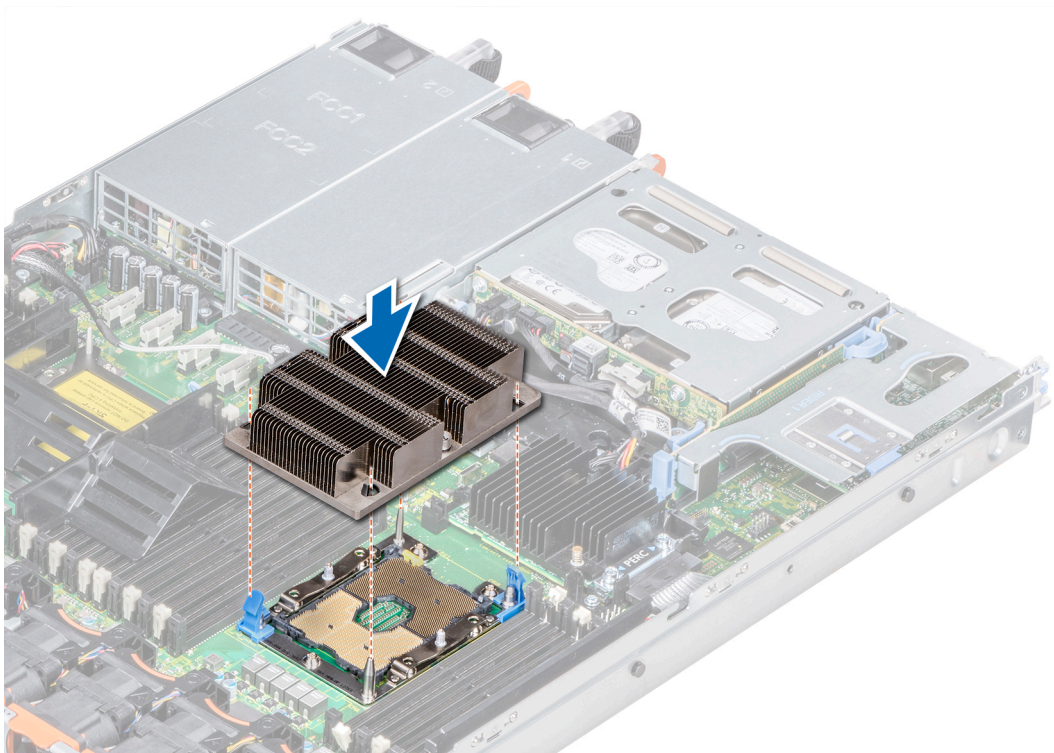

Figure 50. Installing a processor and heat sink module

Next steps

1. Follow the procedure listed in [After working inside your system](#).

Expansion cards and expansion card risers

NOTE: A System Event Log (SEL) event is logged if an expansion card riser is not supported or missing. It does not prevent your system from turning on. However, if a F1/F2 pause occurs and an error message is displayed.

Expansion bus specifications

The PowerEdge R640 system supports PCI express (PCIe) generation 3 expansion cards, which are installed on the system, using expansion card risers. This system supports 1A, 2A, 1B, and 2B expansion card risers.

Expansion card installation guidelines

Depending on your system configuration, the following PCI Express (PCIe) generation 3 expansion cards are supported:

Table 51. Expansion card riser configurations

Expansion card riser	PCIe slots on the riser	Processor connection	Height	Length	Slot width
Riser 1A	Slot 1	Processor 1	Low Profile	Half Length	x16
	Slot 2	Processor 1	Low Profile	Half Length	x16
Riser 2A	Slot 3	Processor 2	Low Profile	Half Length	x16

Expansion card riser	PCIe slots on the riser	Processor connection	Height	Length	Slot width
Riser 1B	Slot 1	Processor 1	Low Profile	Half Length	x16
Riser 2B	Slot 2	Processor 2	Full Height	Three-fourth Length	x16
Riser 1B	Slot 1	Processor 1	Low Profile	Half Length	x16

NOTE: The expansion card slots are not hot-swappable.

The following table provides guidelines for installing expansion cards to ensure proper cooling and mechanical fit. The expansion cards with the highest priority should be installed first using the slot priority indicated. All the other expansion cards should be installed in the card priority and slot priority order.

Table 52. Riser configurations: 1B

Card Type	Slot Priority	Form Factor
HWRAID BOSS (ODM)	1	Low Profile
NVMe PCIe SSD (Dell design)	1	Low Profile
Infiniband HCA EDR (Mellanox)	1	Low Profile
100G NICs (Mellanox)	1	Low Profile
Omni-Path HFI (Intel)	1	Low Profile
Infiniband HCA FDR (Mellanox)	1	Low Profile
40G NICs (Intel)	1	Low Profile
40G NICs (Mellanox)	1	Low Profile
FC32 HBA (QLogic)	1	Low Profile
FC32 HBA (Emulex)	1	Low Profile
25G NICs (Broadcom)	1	Low Profile
25G NICs (Mellanox)	1	Low Profile
25G NICs (QLogic)	1	Low Profile
FC16 HBA (QLogic)	1	Low Profile
FC16 HBA (Emulex)	1	Low Profile
10Gb NICs (Broadcom)	1	Low Profile
10Gb NICs (Intel)	1	Low Profile
10Gb NICs (Mellanox)	1	Low Profile
10Gb NICs (QLogic)	1	Low Profile
10Gb NICs (Solarflare)	1	Low Profile
FC8 HBA (Emulex)	1	Low Profile
FC8 HBA (QLogic)	1	Low Profile
1Gb NICs (Broadcom)	1	Low Profile
1Gb NICs (Intel)	1	Low Profile
Adapter RAID (Dell design)	1	Low Profile
External RAID (Dell design)	1	Low Profile
Non-RAID (Dell design)	1	Low Profile
Integrated RAID (Dell design)	Integrated Slot	NONE
rNDC (Broadcom)	Integrated Slot	NONE
rNDC (Intel)	Integrated Slot	NONE
rNDC (Mellanox)	Integrated Slot	NONE

Card Type	Slot Priority	Form Factor
rNDC (QLogic)	Integrated Slot	NONE

Table 53. Riser configurations: 1A + 2A

Card type	Slot priority	Form factor
Graphics processing unit (GPU)	2	Low Profile
Adapter RAID (Dell design)	1, 3	Low Profile
HWRAID BOSS (ODM)	1, 2, 3	Low Profile
NVMe PCIe SSD (Dell design)	3, 1	Low Profile
Infiniband HCA EDR (Mellanox)	1, 2, 3	Low Profile
100G NICs (Mellanox)	1, 2, 3	Low Profile
Omni-Path HFI (Intel)	1, 2, 3	Low Profile
Infiniband HCA FDR (Mellanox)	1, 2, 3	Low Profile
40G NICs (Intel)	1, 2, 3	Low Profile
40G NICs (Mellanox)	1, 2, 3	Low Profile
FC32 HBA (QLogic)	1, 2, 3	Low Profile
FC32 HBA (Emulex)	1, 2, 3	Low Profile
25G NICs (Broadcom)	1, 2, 3	Low Profile
25G NICs (Mellanox)	1, 2, 3	Low Profile
25G NICs (QLogic)	1, 2, 3	Low Profile
FC16 HBA (QLogic)	1, 2, 3	Low Profile
FC16 HBA (Emulex)	1, 2, 3	Low Profile
10Gb NICs (Broadcom)	1, 2, 3	Low Profile
10Gb NICs (Intel)	1, 2, 3	Low Profile
10Gb NICs (Mellanox)	1, 2, 3	Low Profile
10Gb NICs (QLogic)	1, 2, 3	Low Profile
10Gb NICs (Solarflare)	1, 2, 3	Low Profile
FC8 HBA (Emulex)	1, 3	Low Profile
FC8 HBA (QLogic)	1, 2, 3	Low Profile
1Gb NICs (Broadcom)	1, 2, 3	Low Profile
1Gb NICs (Intel)	1, 2, 3	Low Profile
External RAID (Dell design)	1, 2, 3	Low Profile
Non-RAID (Dell design)	1, 3	Low Profile
Integrated RAID (Dell design)	Integrated Slot	NONE
rNDC (Broadcom)	Integrated Slot	NONE
rNDC (Intel)	Integrated Slot	NONE
rNDC (Mellanox)	Integrated Slot	NONE
rNDC (QLogic)	Integrated Slot	NONE

Table 54. Riser configurations: 1B + 2B

Card type	Slot priority	Form factor
GPU (NVIDIA)	2	Full Height
HWRAID BOSS (ODM)	1	Low Profile

Card type	Slot priority	Form factor
NVMe PCIe SSD (Dell design)	1	Low Profile
Infiniband HCA EDR (Mellanox)	1	Low Profile
100G NICs (Mellanox)	1	Low Profile
Omni-Path HFI (Intel)	1	Low Profile
Infiniband HCA FDR (Mellanox)	1	Low Profile
40G NICs (Intel)	1	Low Profile
40G NICs (Mellanox)	1	Low Profile
FC32 HBA (QLogic)	1	Low Profile
FC32 HBA (Emulex)	1	Low Profile
25G NICs (Broadcom)	1	Low Profile
25G NICs (Mellanox)	1	Low Profile
25G NICs (QLogic)	1	Low Profile
FC16 HBA (QLogic)	1	Low Profile
FC16 HBA (Emulex)	1	Low Profile
10Gb NICs (Broadcom)	1	Low Profile
10Gb NICs (Intel)	1	Low Profile
10Gb NICs (Mellanox)	1	Low Profile
10Gb NICs (QLogic)	1	Low Profile
10Gb NICs (Solarflare)	1	Low Profile
FC8 HBA (Emulex)	1	Low Profile
FC8 HBA (QLogic)	1	Low Profile
1Gb NICs (Broadcom)	1	Low Profile
1Gb NICs (Intel)	1	Low Profile
Adapter RAID (Dell design)	1	Low Profile
External RAID (Dell design)	1	Low Profile
Non-RAID (Dell design)	1	Low Profile
HWRAID BOSS (ODM)	2	Full Height
Infiniband HCA EDR (Mellanox)	2	Full Height
100G NICs (Mellanox)	2	Full Height
Omni-Path HFI (Intel)	2	Full Height
40G NICs (Intel)	2	Full Height
40G NICs (Mellanox)	2	Full Height
FC32 HBA (QLogic)	2	Full Height
FC32 HBA (Emulex)	2	Full Height
25G NICs (Broadcom)	2	Full Height
25G NICs (Mellanox)	2	Full Height
25G NICs (QLogic)	2	Full Height
FC16 HBA (QLogic)	2	Full Height
FC16 HBA (Emulex)	2	Full Height
10Gb NICs (Broadcom)	2	Full Height

Card type	Slot priority	Form factor
10Gb NICs (Intel)	2	Full Height
10Gb NICs (Mellanox)	2	Full Height
10Gb NICs (QLogic)	2	Full Height
10Gb NICs (Solarflare)	2	Full Height
FC8 HBA (Emulex)	2	Full Height
FC8 HBA (QLogic)	2	Full Height
1Gb NICs (Broadcom)	2	Full Height
1Gb NICs (Intel)	2	Full Height
External RAID (Dell design)	2	Full Height
Non-RAID (Dell design)	2	Full Height
Low-end Video (Dell design)	2	Full Height
Integrated RAID (Dell design)	Integrated Slot	NONE
rNDC (Broadcom)	Integrated Slot	NONE
rNDC (Intel)	Integrated Slot	NONE
rNDC (Mellanox)	Integrated Slot	NONE
rNDC (QLogic)	Integrated Slot	NONE

Table 55. Riser configurations:1A

Card type	Slot priority	Form factor
Adapter RAID (Dell design)	1	Low Profile
Non-RAID (Dell design)	1	Low Profile
HWRAID BOSS (ODM)	1, 2	Low Profile
NVMe PCIe SSD (Dell design)	1	Low Profile
Infiniband HCA EDR (Mellanox)	1, 2	Low Profile
100G NICs (Mellanox)	1, 2	Low Profile
Omni-Path HFI (Intel)	1, 2	Low Profile
Infiniband HCA FDR (Mellanox)	1, 2	Low Profile
40G NICs (Intel)	1, 2	Low Profile
40G NICs (Mellanox)	1, 2	Low Profile
FC32 HBA (QLogic)	1, 2	Low Profile
FC32 HBA (Emulex)	1, 2	Low Profile
25G NICs (Broadcom)	1, 2	Low Profile
25G NICs (Mellanox)	1, 2	Low Profile
25G NICs (QLogic)	1, 2	Low Profile
FC16 HBA (QLogic)	1, 2	Low Profile
FC16 HBA (Emulex)	1, 2	Low Profile
10Gb NICs (Broadcom)	1, 2	Low Profile
10Gb NICs (Intel)	1, 2	Low Profile
10Gb NICs (Mellanox)	1, 2	Low Profile
10Gb NICs (QLogic)	1, 2	Low Profile
10Gb NICs (Solarflare)	1, 2	Low Profile

Card type	Slot priority	Form factor
FC8 HBA (Emulex)	1	Low Profile
FC8 HBA (QLogic)	1, 2	Low Profile
1Gb NICs (Broadcom)	1, 2	Low Profile
1Gb NICs (Intel)	1, 2	Low Profile
External RAID (Dell design)	1, 2	Low Profile
Integrated RAID (Dell design)	Integrated Slot	NONE
rNDC (Broadcom)	Integrated Slot	NONE
rNDC (Intel)	Integrated Slot	NONE
rNDC (Mellanox)	Integrated Slot	NONE
rNDC (QLogic)	Integrated Slot	NONE

Removing an expansion card riser

Prerequisites

1. Follow the safety guidelines listed in [Safety instructions](#).
2. Follow the procedure listed in [Before working inside your system](#).
3. Before removing the expansion card riser 2A, remove the expansion card from the riser, if installed.
4. Disconnect any cables connected to the expansion card.

Steps

Hold the touch points, and lift the expansion card riser, from the riser connector, on the system board.

NOTE: While removing the riser 1B, press the tabs and hold the touch point to lift the expansion card riser from the system board.

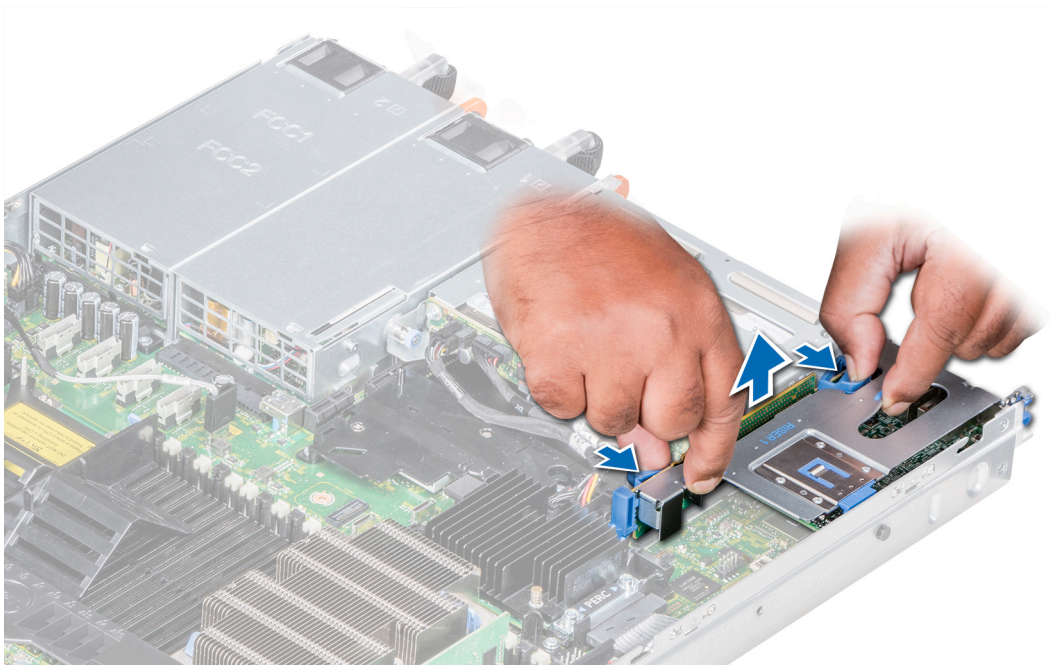

Figure 51. Removing the expansion riser 1B

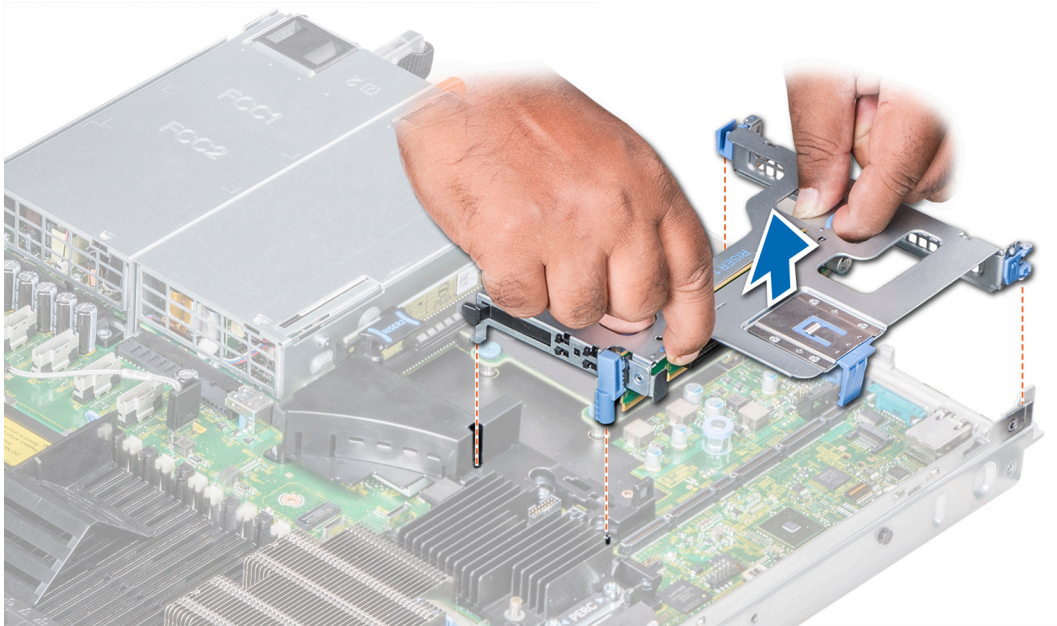

Figure 52. Removing the expansion riser 1A



Figure 53. Removing the expansion riser 2A

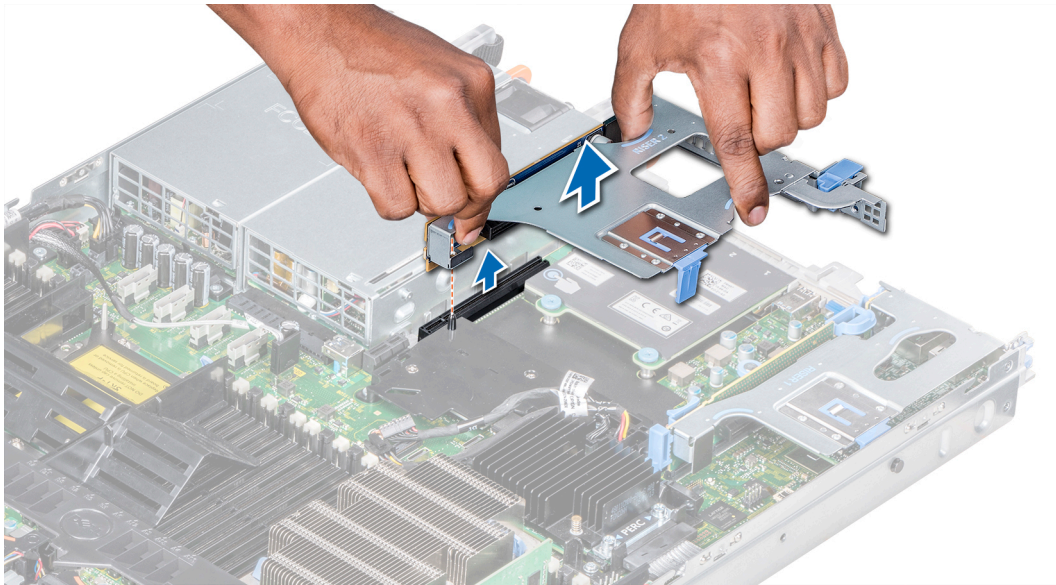

Figure 54. Removing the expansion riser 2B

Next steps

Install the expansion card riser.

Installing an expansion card riser

Prerequisites

1. Follow the safety guidelines listed in [Safety instructions](#).
2. Before installing the expansion card riser 2A, install an expansion card into the riser, if applicable.

Steps

1. If removed, [install the expansion cards into the expansion card riser](#).
2. Holding the touch points, align the expansion card riser with the connector and the riser guide pin on the system board.

NOTE: While installing riser 1B, press the tabs and hold the touch point to align the expansion card riser and the riser guide pin on the system board.

3. Lower the expansion card riser into place until the expansion card riser connector is fully seated in the connector.

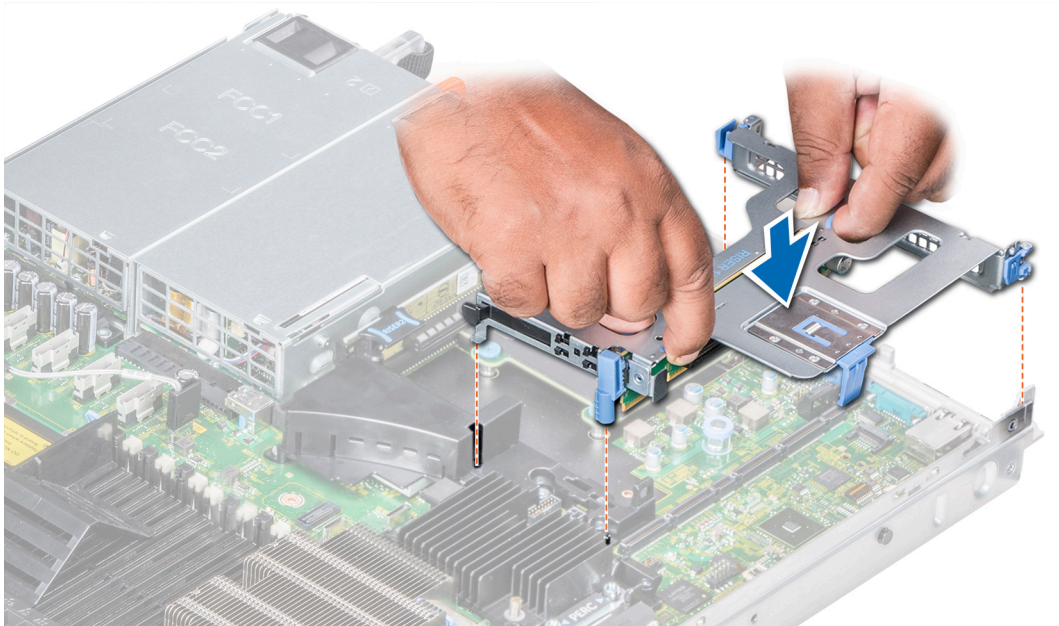

Figure 55. Installing the expansion riser 1A

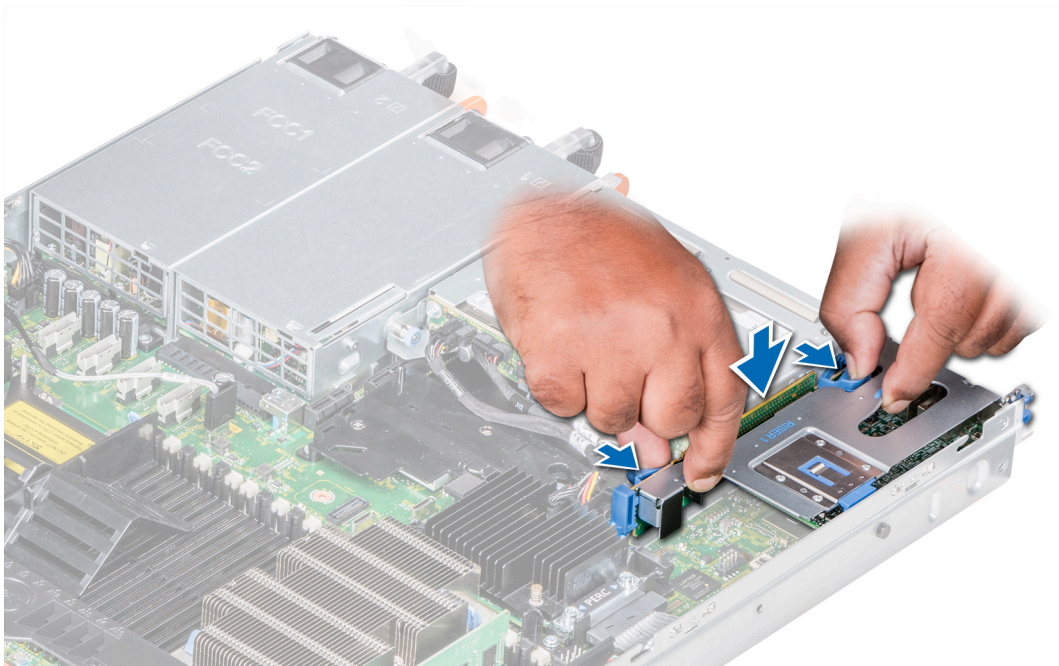

Figure 56. Installing the expansion riser 1B

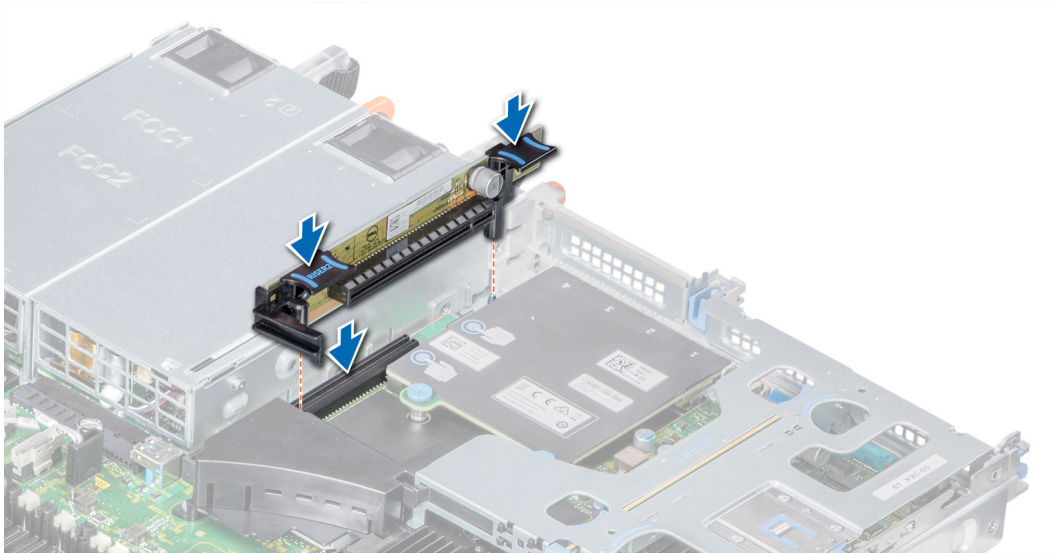

Figure 57. Installing the expansion riser 2A

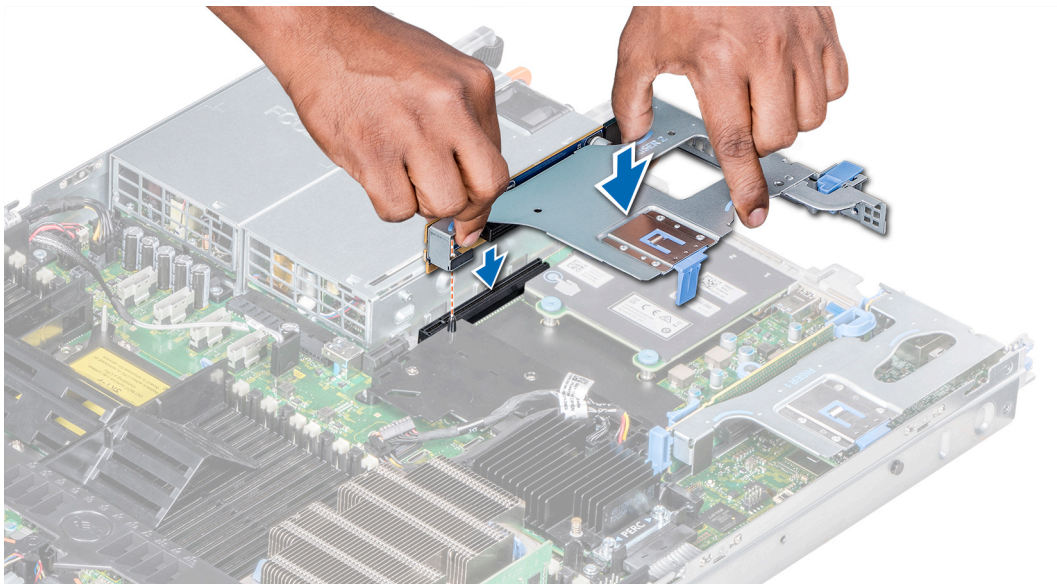

Figure 58. Installing the expansion riser 2B

Next steps

1. Follow the procedure listed in [After working inside your system](#).
2. Install any device drivers required for the card as described in the documentation for the card.

Removing expansion card from the expansion card riser

Prerequisites

1. Follow the safety guidelines listed in [Safety instructions](#).
2. Follow the procedure listed in [Before working inside your system](#).
3. If applicable, [remove the air shroud](#).
4. If applicable, disconnect the cables from the expansion card.
5. When removing a card from riser 2 or 3, ensure that the PCIe card holder latch is closed.

Steps

1. Pull the expansion card latch out of the slot.
2. Hold the expansion card by its edges, and pull the card until the card edge connector disengages from the expansion card connector on the riser.

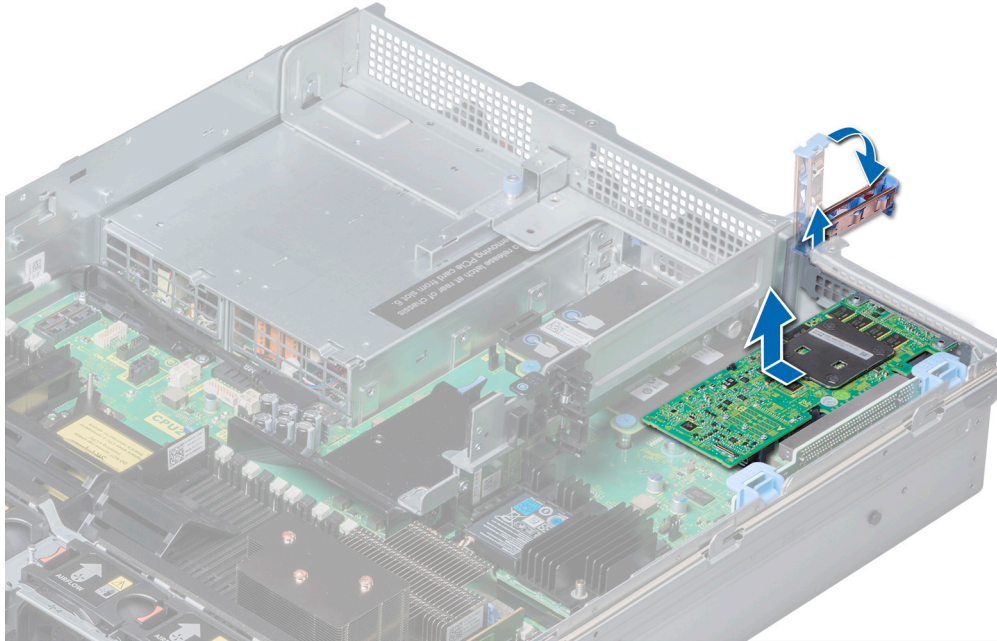

Figure 59. Removing the expansion card from expansion card riser 1

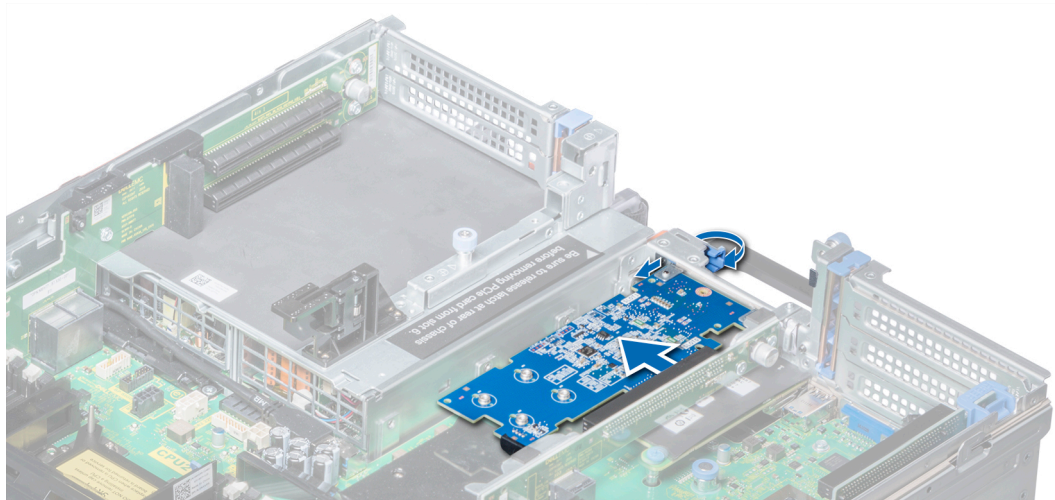

Figure 60. Removing the expansion card from expansion card riser 2B

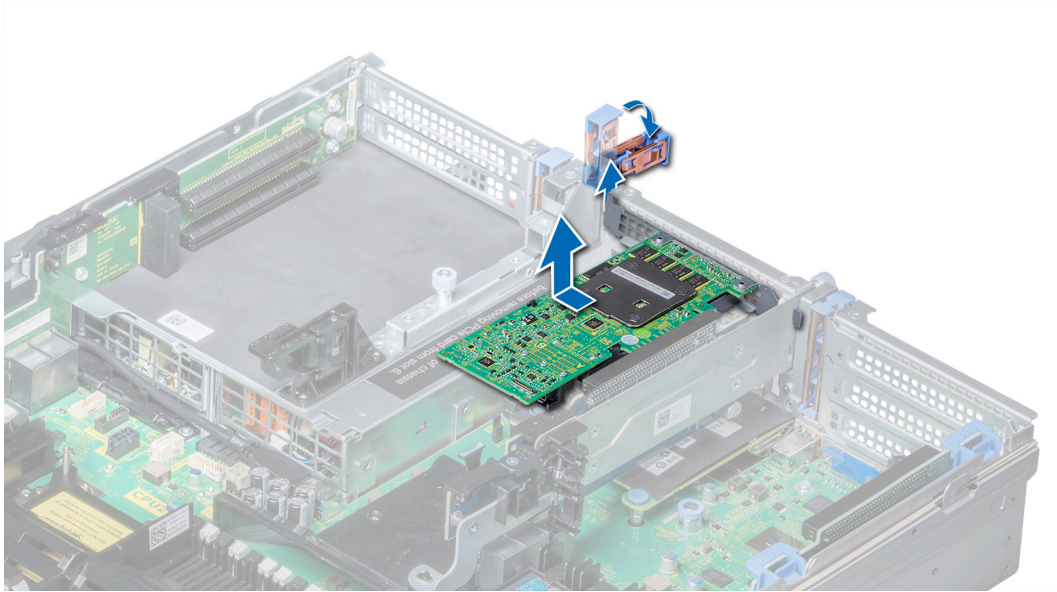

Figure 61. Removing the expansion card from expansion card riser 2

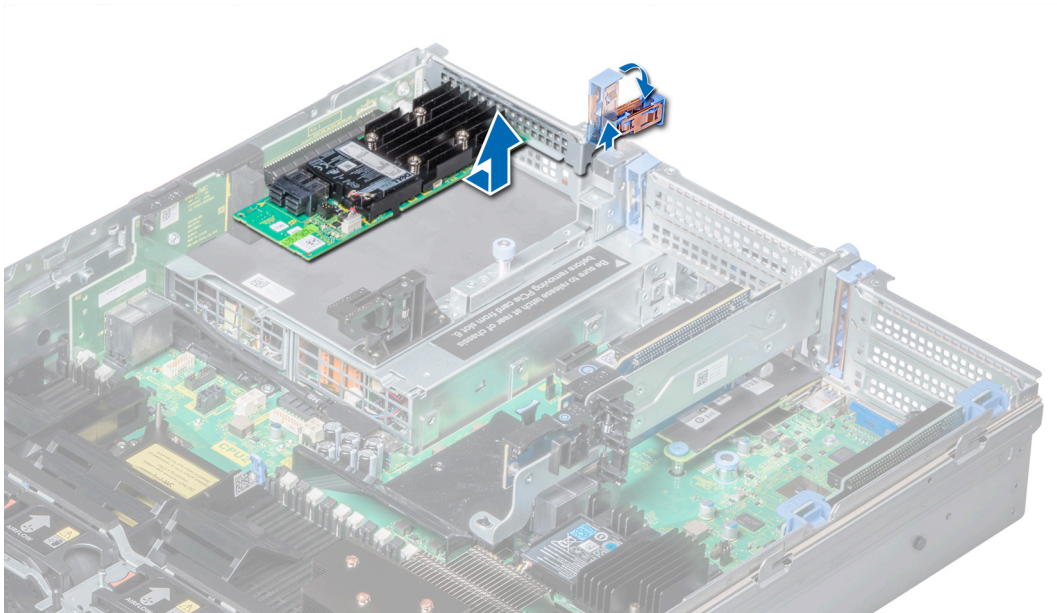

Figure 62. Removing the expansion card from expansion card riser 3

Next steps

1. Install expansion card into the expansion card riser.
2. If you are removing the card permanently, install a metal filler bracket over the empty expansion slot opening and push the expansion card latch.

NOTE: You must install a filler bracket over an empty expansion card slot to maintain Federal Communications Commission (FCC) certification of the system. The brackets also keep dust and dirt out of the system and aid in proper cooling and airflow inside the system.

Installing an expansion card into expansion card riser

Prerequisites

1. Follow the safety guidelines listed in [Safety instructions](#).
2. Unpack the expansion card and prepare it for installation.

NOTE: For instructions, see the documentation accompanying the card.

NOTE: When installing a card into the riser 1, open the PCIe card holder latch. If applicable, open the PCIe guide and then install the expansion card.

Steps

1. If applicable, lift the expansion card latch and remove the filler bracket.

NOTE: Store the filler bracket for future use. Filler brackets must be installed in empty expansion card slots to maintain Federal Communications Commission (FCC) certification of the system. The brackets also keep dust and dirt out of the system and aid in proper cooling and airflow inside the system.

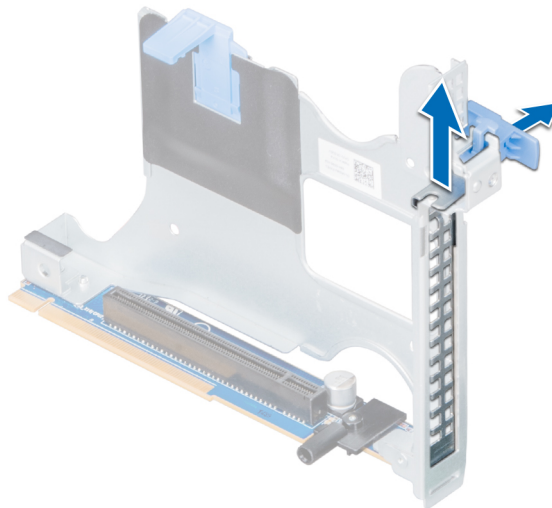

Figure 63. Removing the metal filler bracket on Riser 2B

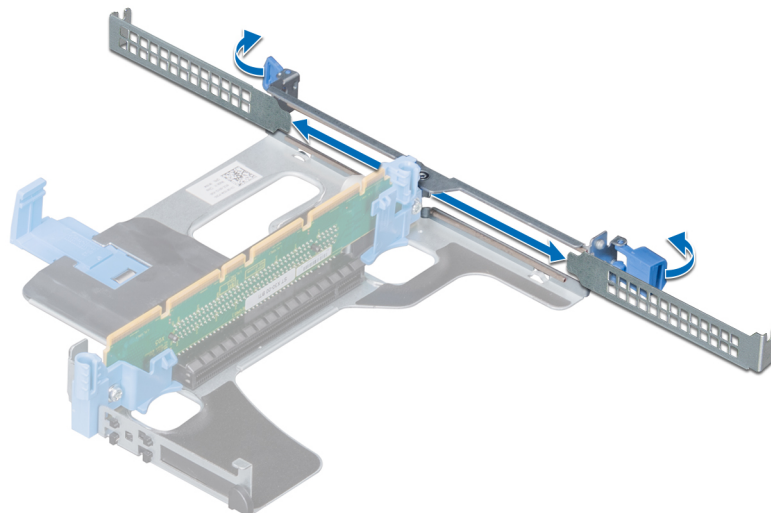

Figure 64. Removing the metal filler bracket on Riser 1A

2. Hold the card by its edges, and align the card edge connector with the expansion card connector on the riser.
3. Insert the card edge connector firmly into the expansion card connector until the card is fully seated.
4. Close the expansion card latch.

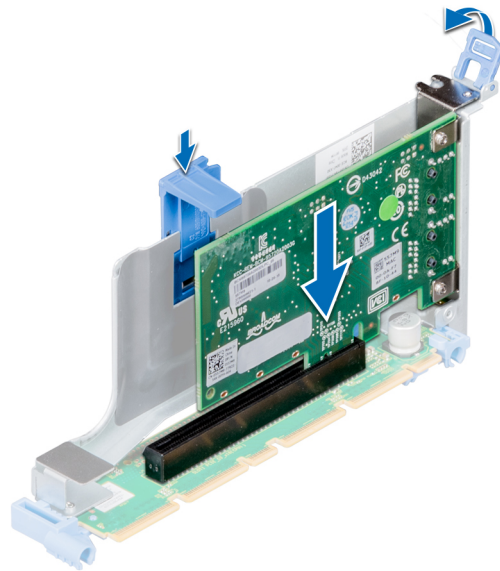

Figure 65. Installing an expansion card into the expansion riser 1B

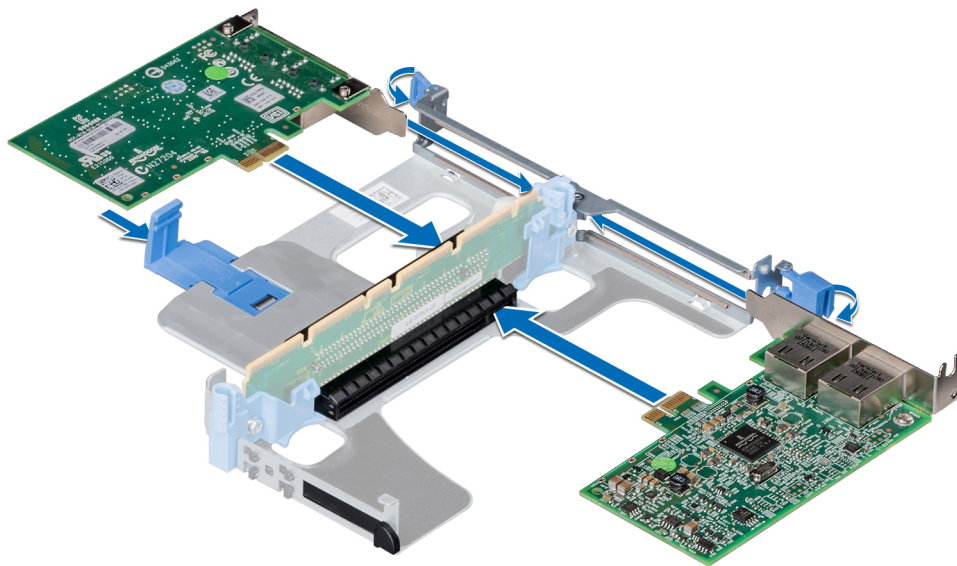

Figure 66. Installing expansion cards into the expansion riser 1A

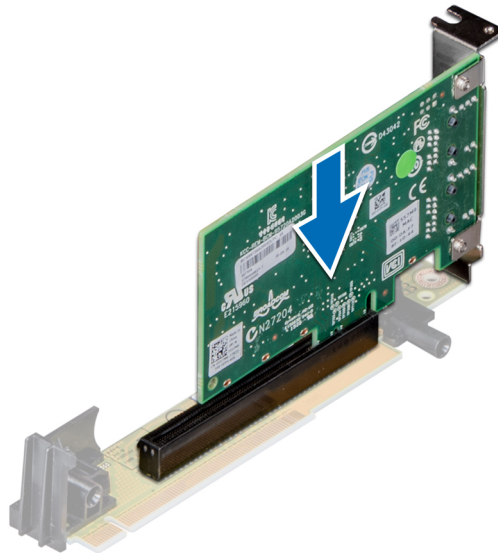

Figure 67. Installing an expansion card into the expansion riser 2A

Next steps

1. After installing a card into the riser 1, close the PCIe card holder latch. If applicable, close the PCIe guide after installing the expansion card.
2. Follow the procedure listed in [After working inside your system](#).
3. Install any device drivers required for the card as described in the documentation for the card.

M.2 SSD module

Removing the M.2 SSD module

Prerequisites

1. Follow the safety guidelines listed in [Safety instructions](#).
2. Follow the procedure listed in [Before working inside your system](#).
3. [Remove the air shroud](#).
4. Remove the BOSS card.

NOTE: Removing the BOSS card is similar to the procedure for removing an expansion card riser.

Steps

1. Loosen the screws and lift the retention straps that secure the M.2 SSD module on the BOSS card.
2. Pull the M.2 SSD module away from the BOSS card.

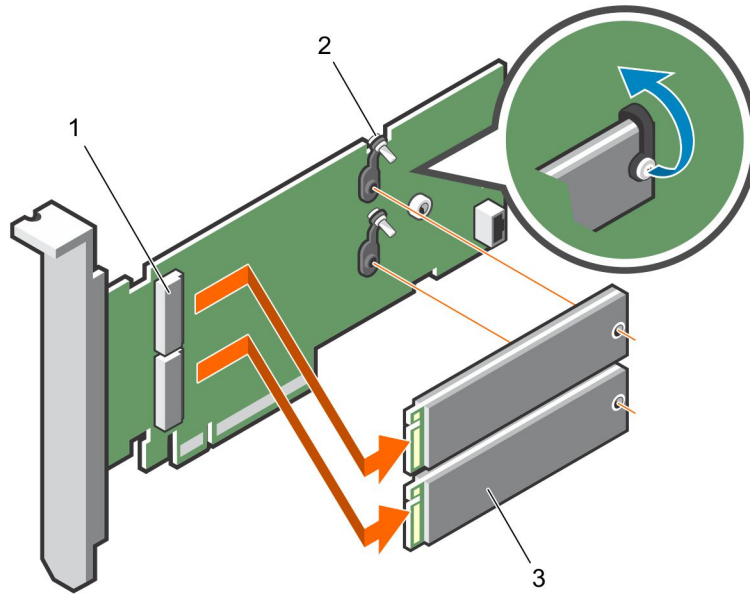

Figure 68. Removing the M.2 SSD module

- a. module connector (2)
- b. screws (2)
- c. module (2)

Next steps

Install the M.2 SSD module.

Installing the M.2 SSD module

Prerequisites

1. Follow the safety guidelines listed in [Safety instructions](#).

Steps

1. Align the M.2 SSD module connectors with the connectors on the BOSS card.
2. Push the M.2 SSD module until the module is seated firmly on the BOSS card.
3. Secure the M.2 SSD module on the BOSS card with the retention straps and screws.

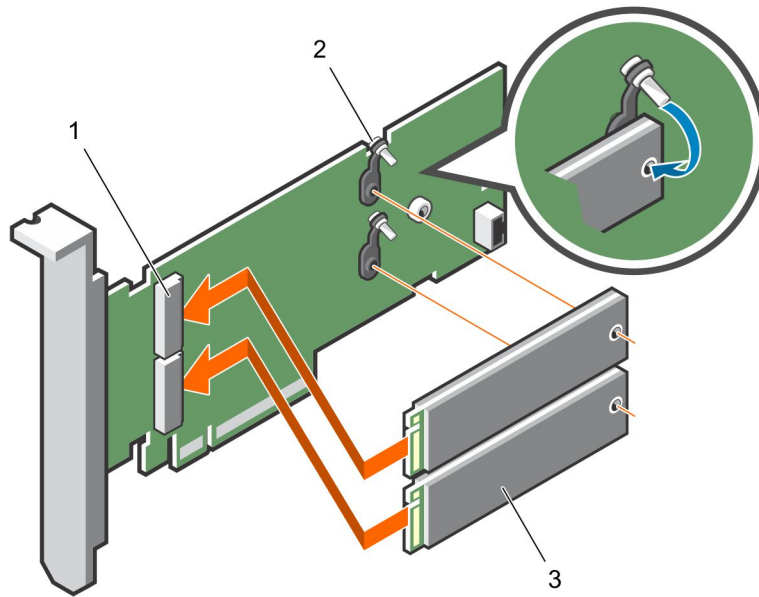

Figure 69. Installing the M.2 SSD module

- a. module connector (2)
- b. screws (2)
- c. modules (2)

Next steps

1. Install the BOSS card.
 - NOTE:** Installing the BOSS card is similar to installing the expansion card riser.
2. Install the air shroud.
3. Follow the procedure listed in [After working inside your system](#).

Optional IDSDM or vFlash module

NOTE: The write-protect switch is on the IDSDM or vFlash module.

Removing the optional IDSDM or vFlash card

Prerequisites

1. Follow the safety guidelines listed in [Safety instructions](#).
2. Follow the procedure listed in [After working inside your system](#).
3. If you are replacing the IDSDM/vFlash card, remove the MicroSD cards.
 - NOTE:** Temporarily label each MicroSD card with its corresponding slot number after removal.

Steps

1. Locate the IDSDM/vFlash connector on the system board.
To locate IDSDM/vFlash connector, see the [System board jumpers and connectors](#) section.
2. Holding the pull tab, lift the IDSDM/vFlash card out of the system.

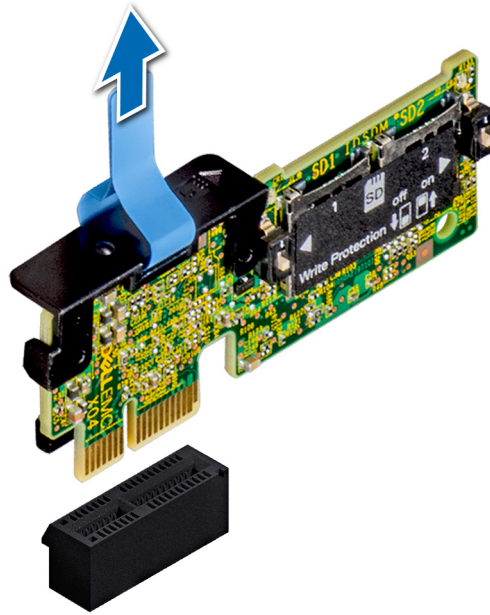

Figure 70. Removing the optional IDSDM module

NOTE: There are two dip switches on the IDSDM module for write-protection.

Next steps

Install the optional IDSDM/vFlash card.

Installing optional IDSDM or vFlash card

Prerequisites

Follow the safety guidelines listed in [Safety instructions](#).

Steps

1. Locate the IDSDM/vFlash connector on the system board.
To locate IDSDM/vFlash connector, see the [Jumpers and connectors](#) section.
2. Align the IDSDM/vFlash card with the connector on the system board.
3. Push the IDSDM/vFlash card until it is firmly seated on the system board.

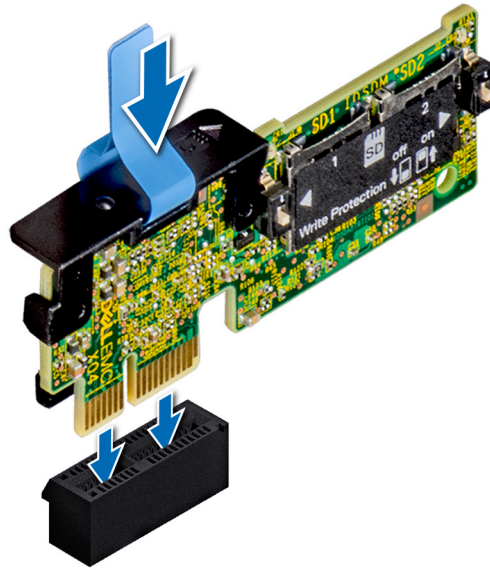

Figure 71. Installing optional IDSDM module

Next steps

1. [Install the MicroSD cards.](#)

NOTE: Reinstall the MicroSD cards into the same slots based on the labels you had marked on the cards during removal.

2. Follow the procedure listed in [After working inside your system.](#)

Optional IDSDM or vFlash module

NOTE: The write-protect switch is on the IDSDM or vFlash module.

Removing the MicroSD card

Prerequisites

1. Follow the safety guidelines listed in [Safety instructions.](#)
2. Follow the procedure listed in [Before working inside your system.](#)

Steps

1. Locate the MicroSD card slot on the vFlash/IDSDM module, and press the card to partially release it from the slot. To locate IDSDM/vFlash module, see the System board jumpers and connectors section.
2. Hold the MicroSD card and remove it from the slot.

NOTE: Temporarily label each MicroSD card with its corresponding slot number after removal.

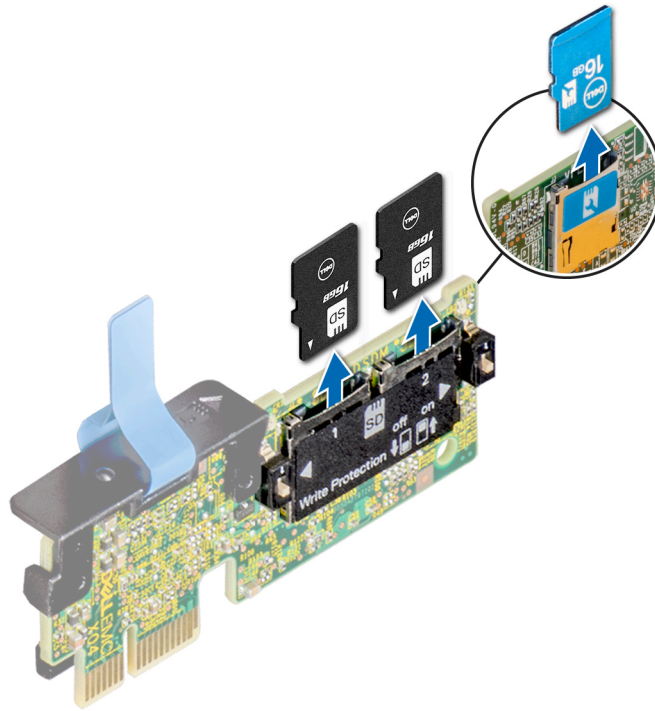

Figure 72. Removing the MicroSD card

Next steps

1. Follow the procedure listed in [After working inside your system](#).
2. [Install a MicroSD card](#).

Installing the MicroSD card

Prerequisites

Follow the safety guidelines listed in [Safety instructions](#).

NOTE: To use an MicroSD card with your system, ensure that the Internal SD Card Port is enabled in System Setup.

NOTE: If reinstalling, ensure that you install the MicroSD cards into the same slots based on the labels you had marked on the cards during removal.

Steps

1. Locate the MicroSD card connector on the IDSDM/vFlash module. Orient the MicroSD card appropriately and insert the contact-pin end of the card into the slot. To locate IDSDM/vFlash, see the [System board jumpers and connectors](#) section.

NOTE: The slot is keyed to ensure correct insertion of the card.

2. Press the card into the card slot to lock it into place.

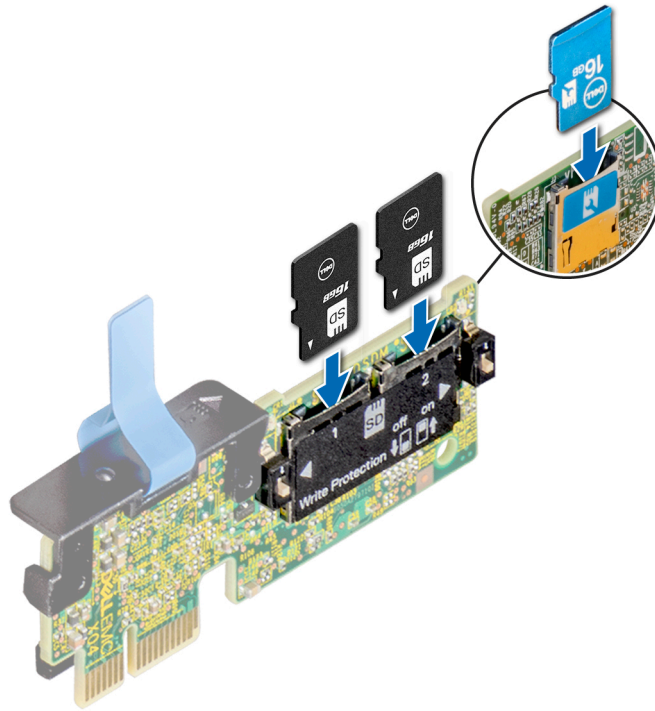

Figure 73. Installing the MicroSD card

Next steps

Follow the procedure listed in [After working inside your system](#).

Network daughter card

Removing the network daughter card

Prerequisites

1. Follow the safety guidelines listed in [Safety instructions](#).
2. Follow the procedure listed in [After working inside your system](#).
3. Remove the expansion card riser 2 or the rear drive cage, depending on the configuration of your system.

Steps

1. Using a Phillips #2 screwdriver, loosen the captive screws that secure the network daughter card (NDC) to the system board.
2. Hold the NDC by the edges on either side of the touch points, and lift to remove it from the connector on the system board.
3. Slide the NDC towards the front of the system until the Ethernet connectors are clear of the slot in the back panel.

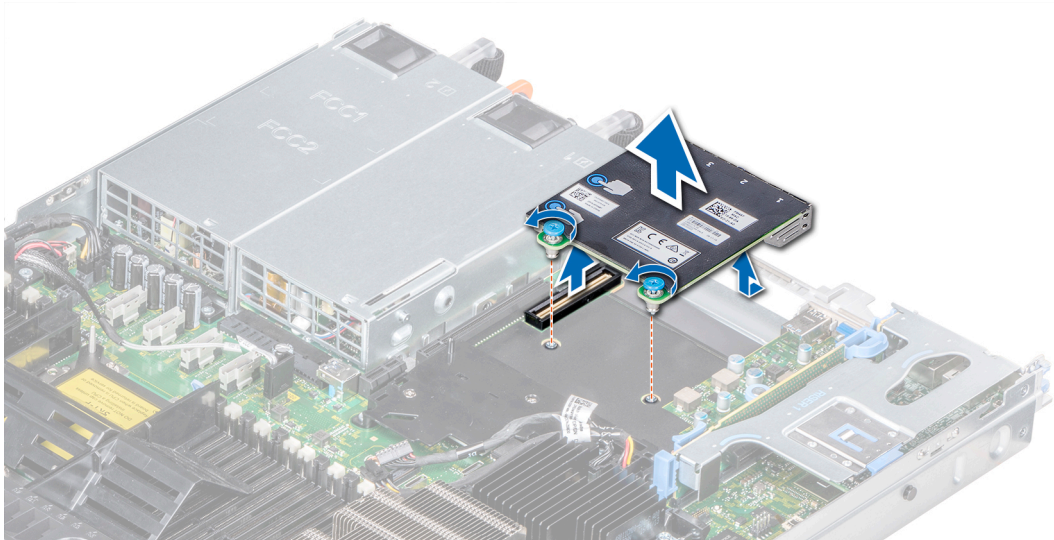

Figure 74. Removing the network daughter card

Next steps

Install the Network Daughter Card.

Installing the network daughter card

Prerequisites

Follow the safety guidelines listed in [Safety instructions](#).

Steps

1. Orient the NDC so that the Ethernet connectors fit through the slot in the chassis.
2. Align the captive screws at the back-end of the card with the screw holes on the system board.
3. Press the touch points on the card until the card connector is firmly seated on the system board connector.
4. Using a Phillips #2 screwdriver, tighten the captive screws to secure the NDC to the system board.

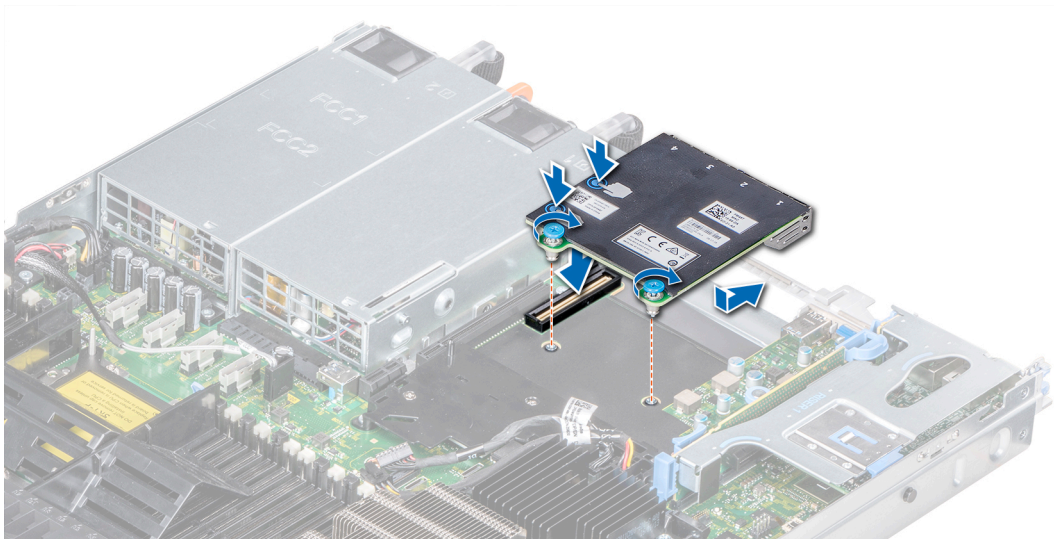

Figure 75. Installing the network daughter card

Next steps

1. Install the expansion card riser 2 or the rear drive cage, depending on the configuration of your system.

2. Follow the procedure listed in [After working inside your system](#).

Integrated storage controller card

Removing the integrated storage controller card

Prerequisites

1. Follow the safety guidelines listed in [Safety instructions](#).
2. Follow the procedure listed in [After working inside your system](#).
3. [Remove the air shroud](#).

Steps

1. Using Phillips #2 screwdriver, loosen the screws that secure the integrated storage controller cable to the connector on the system board.
2. Lift the integrated storage controller cable to disconnect it from the connector on the system board.

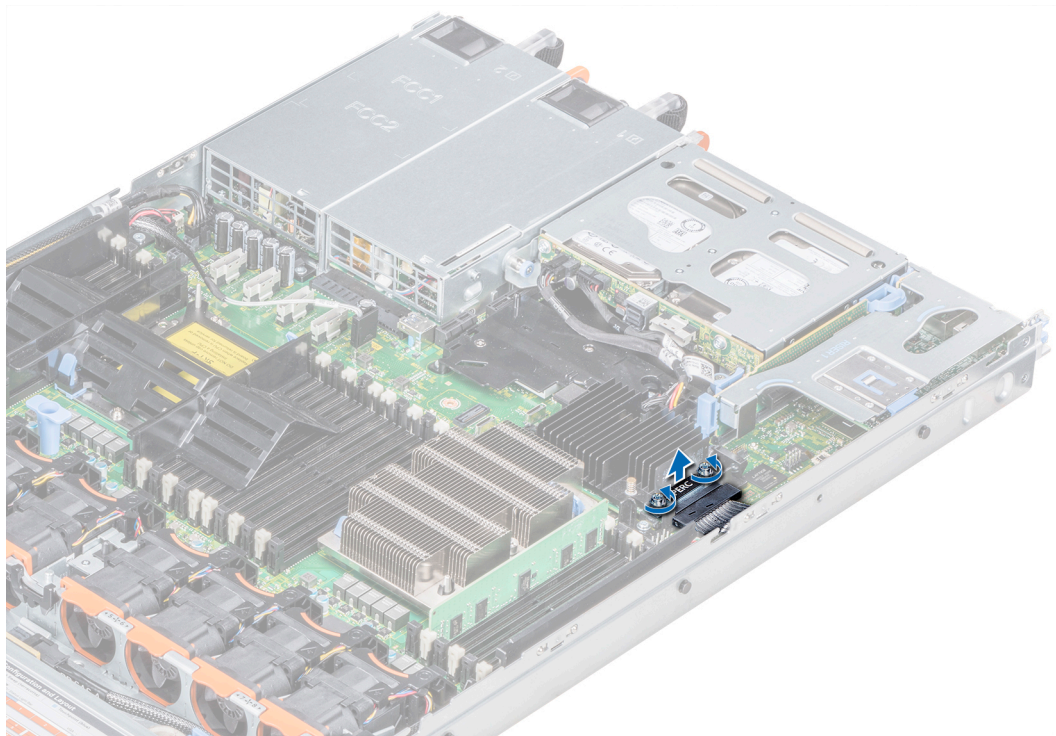

Figure 76. Removing the integrated storage controller cable

3. Lift one end of the card and angle it to disengage the card from the card holder on the system board.
4. Lift the card out of the system.

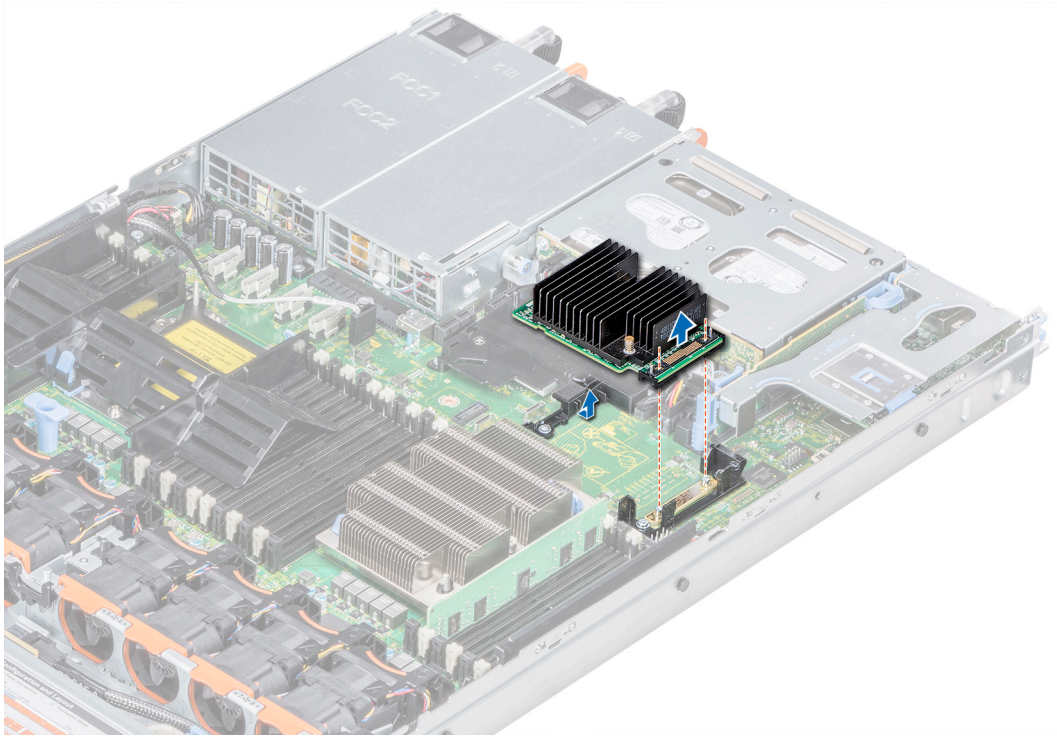

Figure 77. Removing the integrated storage controller card

Next steps

Install the integrated storage controller card.

Installing the integrated storage controller card

Prerequisites

Follow the safety guidelines listed in [Safety instructions](#).

Steps

1. Angle the integrated storage controller card and align the end of the card with the controller card connector on the system board.
2. Lower the connector side of the integrated storage controller card into the integrated storage controller card connector on the system board.

NOTE: Ensure that the slots on the system board align with the screw holes on the integrated storage controller card connector.

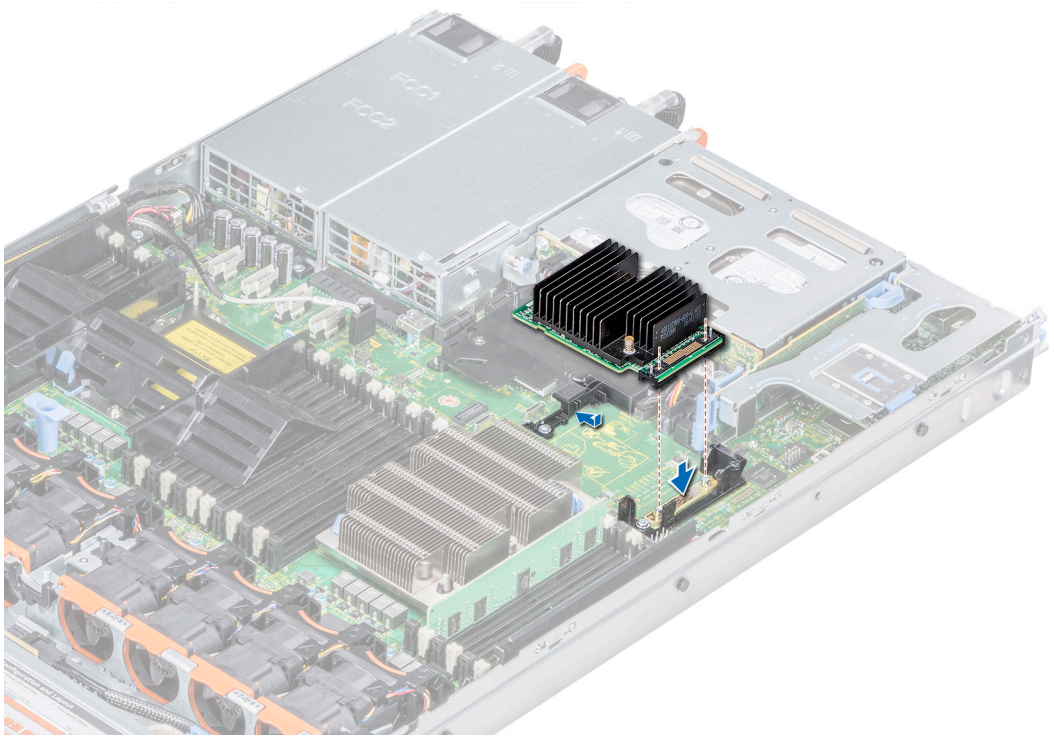

Figure 78. Installing the integrated storage controller card

3. Route the integrated storage controller card cable along the wall of the system.
4. Align the screws on the integrated storage controller card cable with the screw holes on the connector.
5. Using Phillips #2 screwdriver, tighten the screws to secure the integrated storage controller card cable to the card connector on the system board.

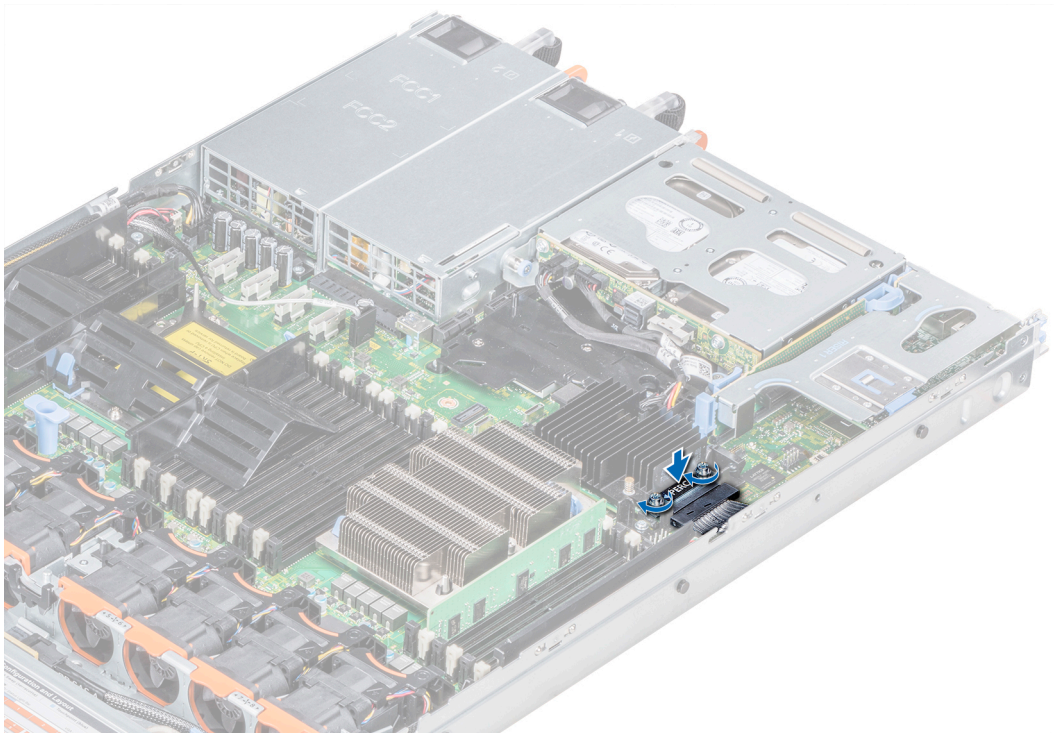

Figure 79. Installing the integrated storage controller card cable

Next steps

1. [Install the air shroud.](#)
2. Follow the procedure listed in [After working inside your system.](#)

Backplane

Backplane details

Depending on your system configuration, the drive backplanes supported in PowerEdge R640 are listed here:

Table 56. Supported backplane options for PowerEdge R640 systems

System	Supported drives options
PowerEdge R640	2.5 inch (x8) SAS or SATA backplane
	2.5 inch (x10) SAS, SATA, or NVMe backplane
	2.5 inch (x10) SAS, SATA, or NVMe backplane and 2.5 inch (x2) SAS or SATA backplane (back)
	3.5 inch (x4) SAS or SATA backplane

NOTE: Mixing of 2.5 inch 10K or 15K SAS drives with 2.5 inch 7.2K SATA or Nearline SAS drives on the same backplane is not supported. You can mix solid state drives with hard drives on the same backplane.

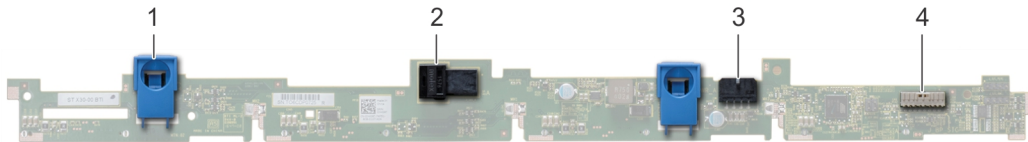

Figure 80. 4 X 3.5 drive backplane

1. release tab (2)
2. SAS cable A connector
3. SAS cable B connector
4. backplane signal cable connector

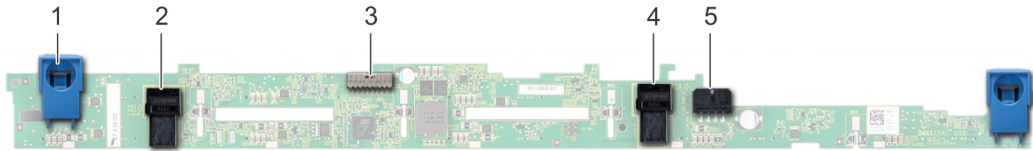

Figure 81. 8 X 2.5 drive backplane

1. release tab (2)
2. SAS cable A connector
3. backplane signal cable connector
4. backplane
5. SAS cable B connector
6. power cable connector

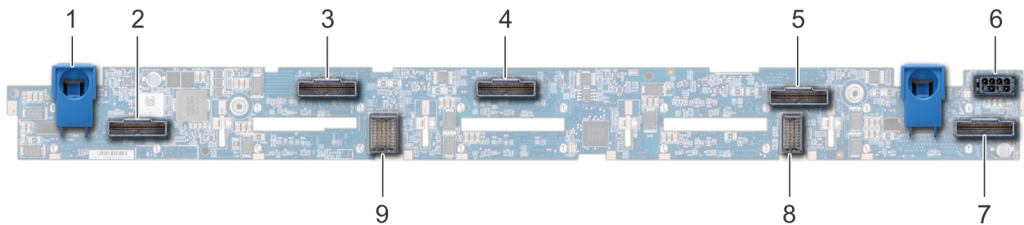

Figure 82. 10 X 2.5 drive backplane

1. release tab (2)
2. NVMe cable connector
3. NVMe cable connector
4. NVMe cable connector
5. NVMe cable connector
6. power cable connector
7. NVMe cable connector
8. backplane to expander board cable connector
9. backplane to expander board cable connector

Removing the backplane cover

Prerequisites

1. Follow the safety guidelines listed in [Safety instructions](#).
2. Follow the procedure listed in [Before working inside your system](#).
3. [Remove the system cover](#).

Steps

1. Slide the backplane cover in the direction of the arrows marked on the backplane cover.
2. Lift the backplane cover away from the system.

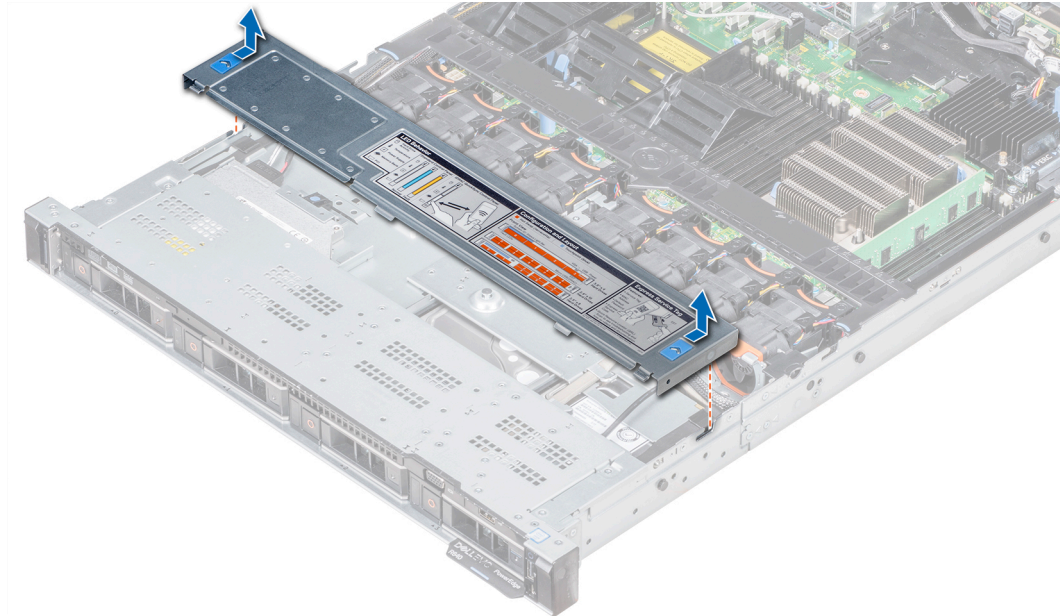

Figure 83. Removing the backplane cover

Installing the backplane

Prerequisites

Follow the safety guidelines listed in [Safety instructions](#).

NOTE: The procedure to install the backplane is similar for all backplane configurations.

Steps

1. Use the hooks on the system as guides to align the slots on the backplane with the guides on the system.
2. Lower the drive backplane until the blue release tabs snap into place.

NOTE: If you are installing a backplane with an expander board, then tighten the captive screws after installing the backplane.

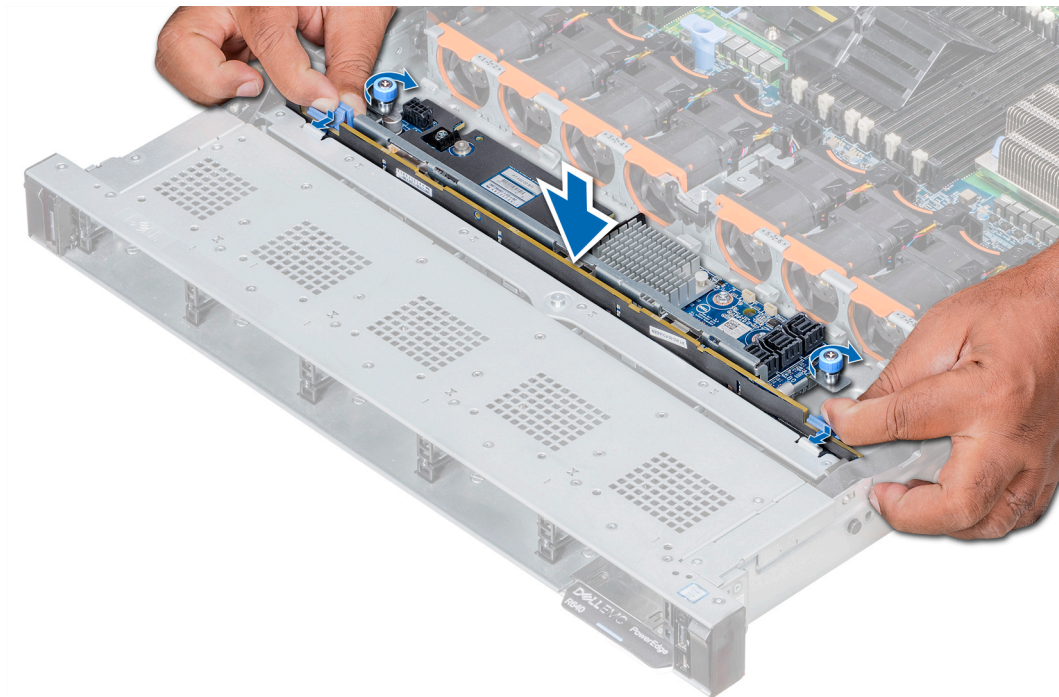

Figure 84. Installing the backplane

Next steps

1. Connect all the cables to the backplane.
2. Install all the drives.
3. Install the backplane cover.
4. [Install the air shroud.](#)
5. Follow the procedure listed in [After working inside your system.](#)

Removing the 2.5 inch drive rear backplane

Prerequisites

CAUTION: To prevent damage to the drives and backplane, you must remove the drives from the system before removing the backplane.

CAUTION: You must note the number of each drive and temporarily label them before removal so that you can replace them in the same locations.

1. Follow the safety guidelines listed in [Safety instructions.](#)
2. Follow the procedure listed in [Before working inside your system.](#)
3. Remove all the drives from the rear drive cage.
4. Disconnect all the cables from the backplane.
5. [Remove the rear drive cage.](#)

Steps

1. Using Phillips #2 screwdriver, remove the screws that secure the drive backplane to the rear drive cage.
2. Disengage the backplane from the hooks on the rear drive cage, and remove it from the rear drive cage.

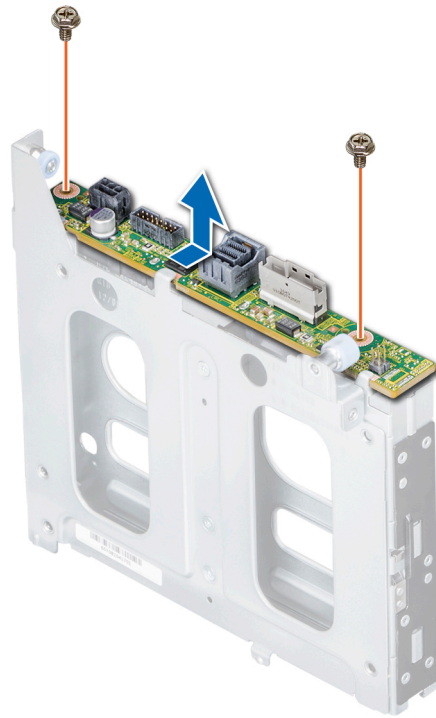

Figure 85. Removing the 2.5 inch drive rear backplane

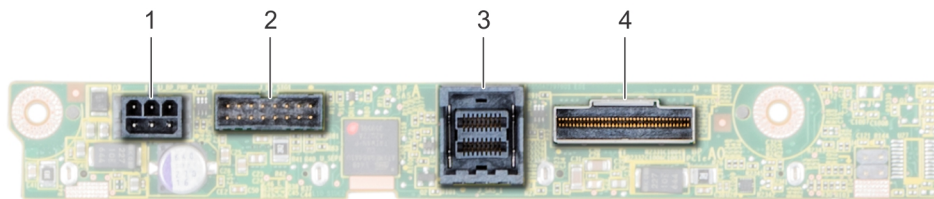

Figure 86. 2 X 2.5 rear drive backplane

- | | |
|------------------------|-------------------------------|
| 1. power connector | 2. backplane signal connector |
| 3. SAS cable connector | 4. NVMe cable connector |

Next steps

Install the 2.5 inch drive rear backplane.

Installing the 2.5 inch drive rear backplane

Prerequisites

Follow the safety guidelines listed in [Safety instructions](#).

Steps

1. Use the hooks on the rear drive cage as guides to align the drive backplane.
2. Lower the backplane into the system until it is firmly seated.
3. Using Phillips #2 screwdriver, replace the screws to secure the backplane to the rear drive cage.

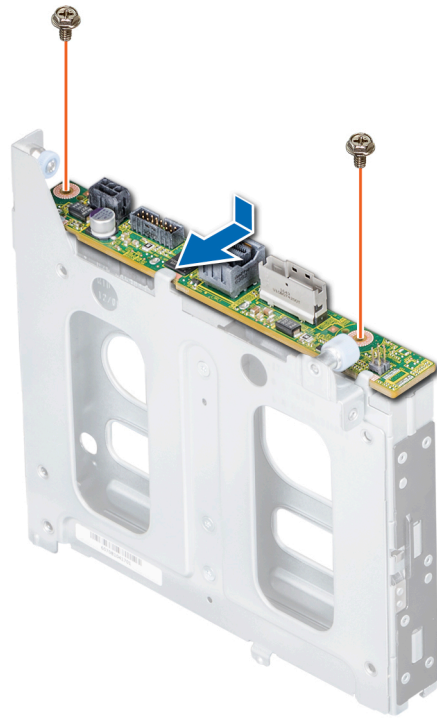

Figure 87. Installing the 2.5 inch drive rear backplane

Next steps

1. [Install the rear drive cage.](#)
2. Install all the drives.
3. Connect all the cables to the backplane.
4. Follow the procedure listed in [Before working inside your system.](#)

Cable routing

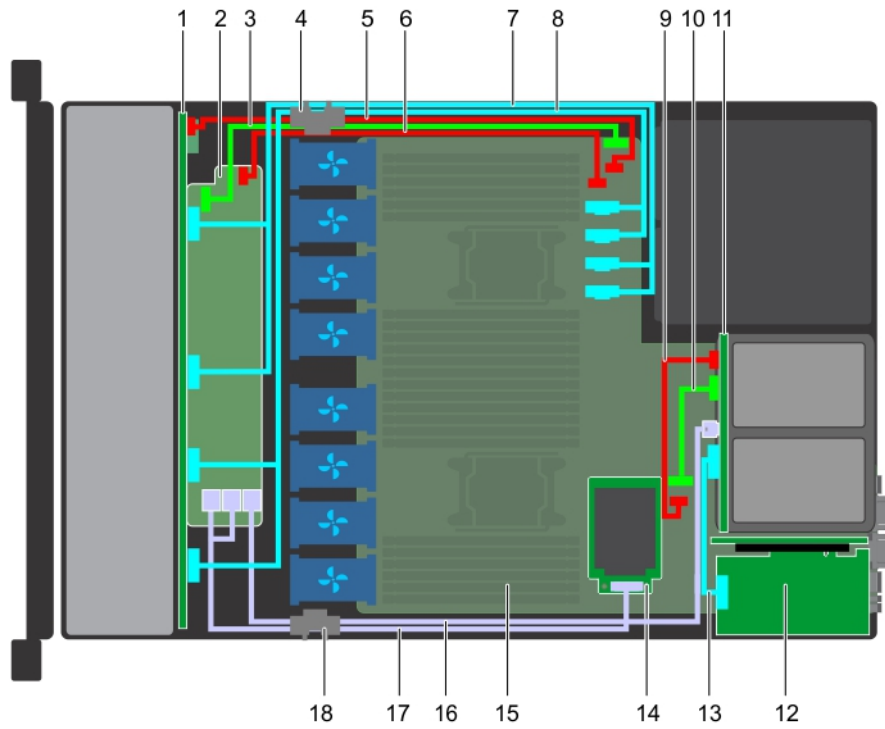

Figure 88. Cable routing - 10 x 2.5 drive backplane and 2 x 2.5 rear drive backplane with mini PERC

- | | |
|---|---|
| 1. backplane | 2. backplane expander |
| 3. backplane signal cable (BP: J_BP_SIG to MB: J_BP_SIG1) | 4. cable routing clip |
| 5. backplane power cable(BP: J_BP_PWR_A1 to MB: J_BP1) | 6. backplane expander power cable |
| 7. NVMe cable (BP PCIe B1 and BP PCIe A1) | 8. NVMe cable (BP PCIe B0 and BP PCIe A0) |
| 9. rear backplane power cable(Rear BP: J_BP_BPO to MB: J_BP_PWR_A1) | 10. rear backplane signal cable (Rear BP: J_BP_SIG0 to MB: J_BP_SIG1) |
| 11. rear backplane | 12. PCIe expansion card |
| 13. PCIe cable | 14. mini PERC card |
| 15. system board | 16. SAS cable (BP: MiniSAS HD A2 to MB: J_SAS_1) |
| 17. SAS cable (BP: BP SAS A0, BP SAS B0 to MP: J_STORAGE1) | 18. cable routing clip |

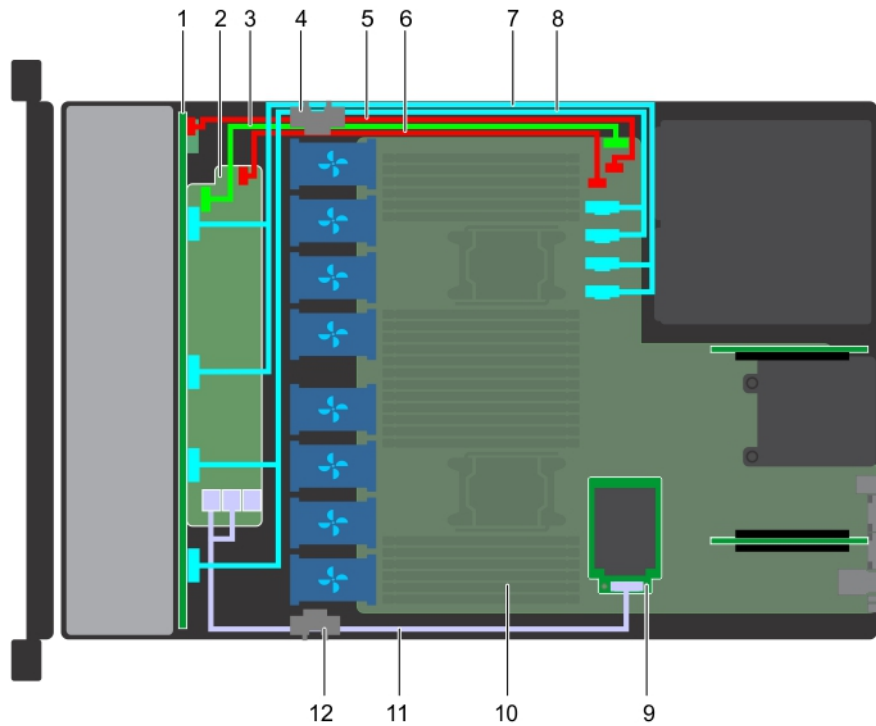

Figure 89. Cable routing - 10 x 2.5 drive backplane with mini PERC

- | | |
|--|---|
| 1. backplane | 2. backplane expander |
| 3. backplane signal cable (BP: J_BP_SIG to MB: J_BP_SIG1) | 4. cable routing clip |
| 5. backplane power cable (BP: J_BP_PWR_A1 to MB: J_BP1) | 6. backplane expander power cable (BP: J_BP_PWR_A to MB: J_BP1) |
| 7. NVMe cable (BP PCIe B1 and BP PCIe A1) | 8. NVMe cable (BP PCIe B0 and BP PCIe A0) |
| 9. mini PERC card | 10. system board |
| 11. SAS cable (BP: BP SAS A0, BP SAS B0 to MP: J_STORAGE1) | 12. cable routing clip |

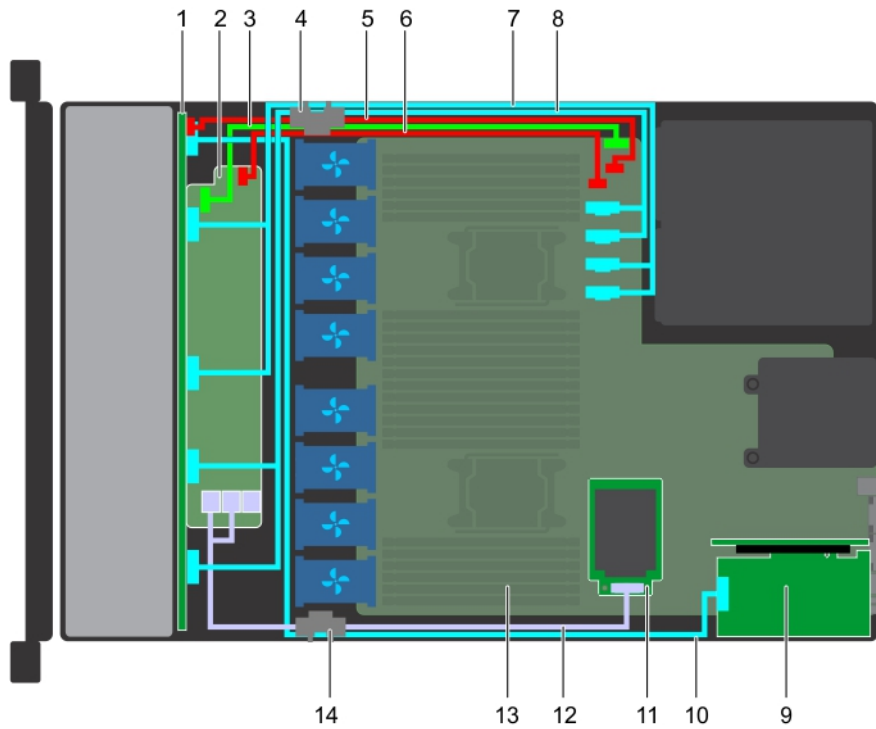

Figure 90. Cable routing - 10 x 2.5 drive backplane with NVMe

- | | |
|---|---|
| 1. backplane | 2. backplane expander |
| 3. backplane signal cable (BP: J_BP_SIG to MB: J_BP_SIG1) | 4. cable routing clip |
| 5. backplane power cable (BP: J_BP_PWR_A1 to MB: J_BP1) | 6. backplane expander power cable (BP: J_BP_PWR_A to MB: J_BP1) |
| 7. NVMe cable (BP PCIe B1 and BP PCIe A1) | 8. NVMe cable (BP PCIe B0 and BP PCIe A0) |
| 9. PCIe expansion card | 10. NVMe signal cable (PCIe card to BP PCIe A2) |
| 11. mini PERC card | 12. SAS cable (BP: BP SAS A0, BP SAS B0 to MP: J_STORAGE1) |
| 13. system board | 14. cable routing clip |

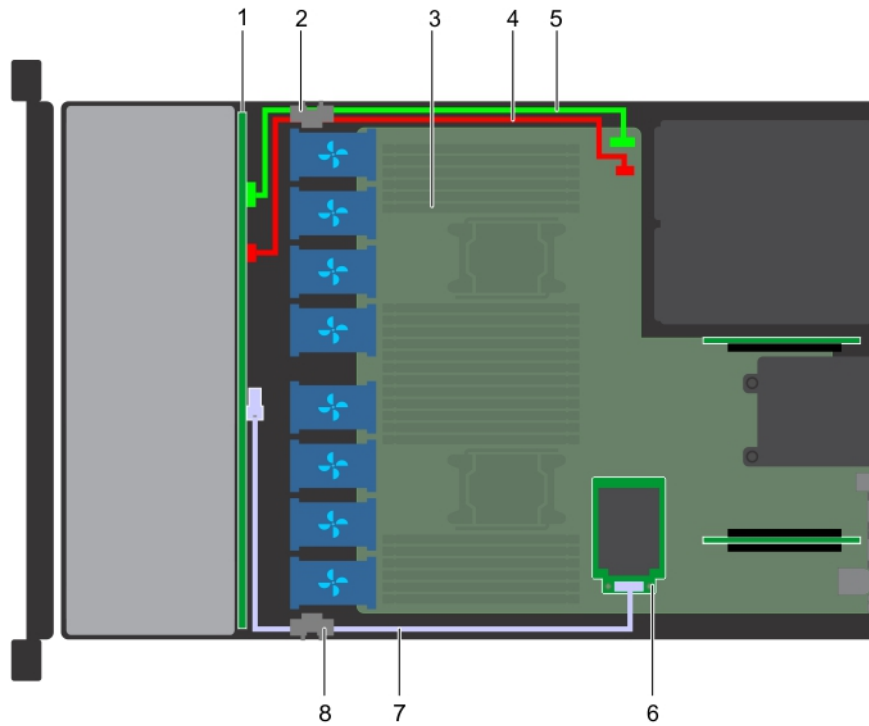

Figure 91. Cable routing - 4 x 3.5 drive backplane with mini PERC

- | | |
|--|---|
| 1. drive backplane | 2. cable routing clip |
| 3. system board | 4. backplane power cable(BP: J_BP_SIG to MB: J_BP_SIG1) |
| 5. backplane signal cable(BP: J_BP_SIG to MB: J_BP_SIG1) | 6. mini PERC card |
| 7. SAS cable(BP: J_SAS_A to MB: J_STORAGE1) | 8. cable routing clip |

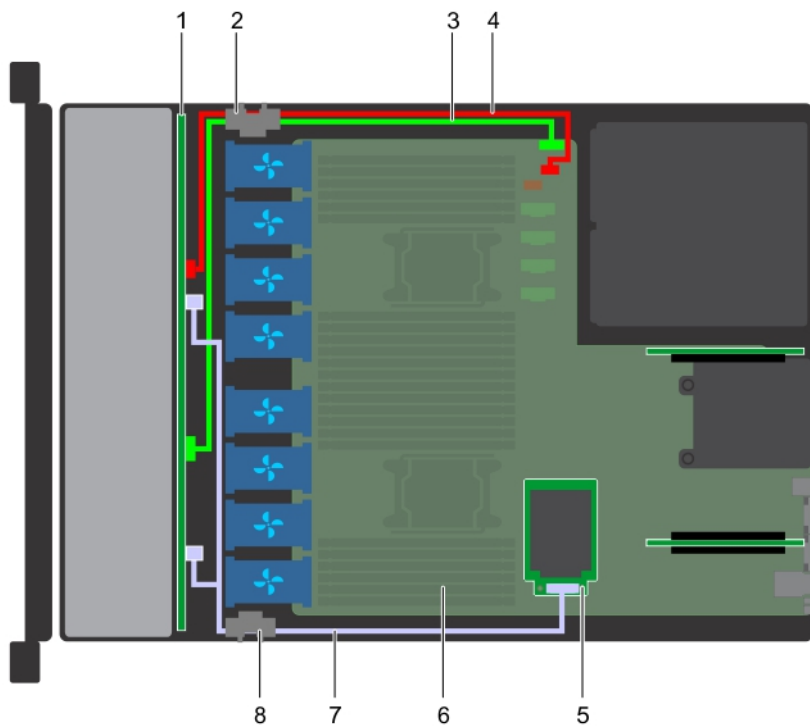

Figure 92. Cable routing - 8 x 2.5 drive backplane with mini PERC

- | | |
|--|--|
| 1. drive backplane | 2. cable routing clip |
| 3. backplane signal cable(BP: J_BP_SIG to MB: J_BP_SIG1) | 4. backplane power cable(BP: J_BP_PWR_A1 to MB: J_BP1) |
| 5. mini PERC card | 6. system board |

7. SAS cable(BP: J_SAS_A to MP: J_STORAGE1)

8. cable routing clip

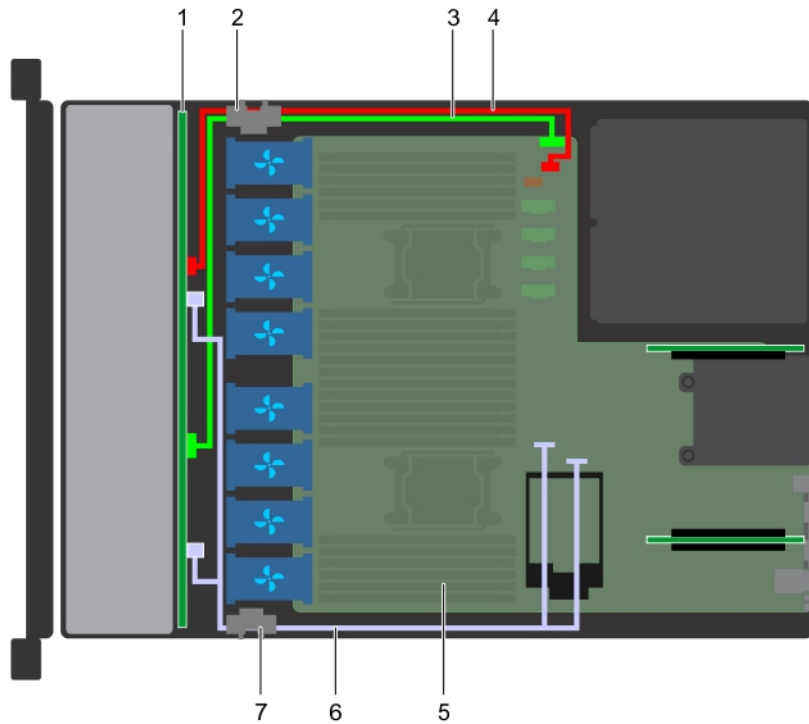

Figure 93. Cable routing - 8 x 2.5 drive backplane with onboard SATA

1. drive backplane

2. cable routing clip

3. backplane signal cable(BP: J_BP_SIG to MB: J_BP_SIG1)

4. backplane power cable(BP: J_BP_PWR_A1 to MB: J_BP1)

5. system board

6. SATA cable(BP: J_SAS_A0, J_SAS_B0 to MB: SATA_A, SATA_B)

7. cable routing clip

SAS expander card

Removing the SAS expander card

Prerequisites

1. Follow the safety guidelines listed in [Safety instructions](#).
2. Follow the procedure listed in [Before working inside your system](#).
3. [Remove the cooling shroud](#).
4. Remove the cooling fan assembly.
5. [Remove the backplane cover](#).
6. Disconnect the SAS cables from the SAS expander card.

Steps

1. Using Philips #2 screwdriver, loosen the screws that secure the SAS expander card to the expander card tray.
2. Pull the SAS expander card to disengage the connectors on SAS expander from the SAS connectors on backplane.

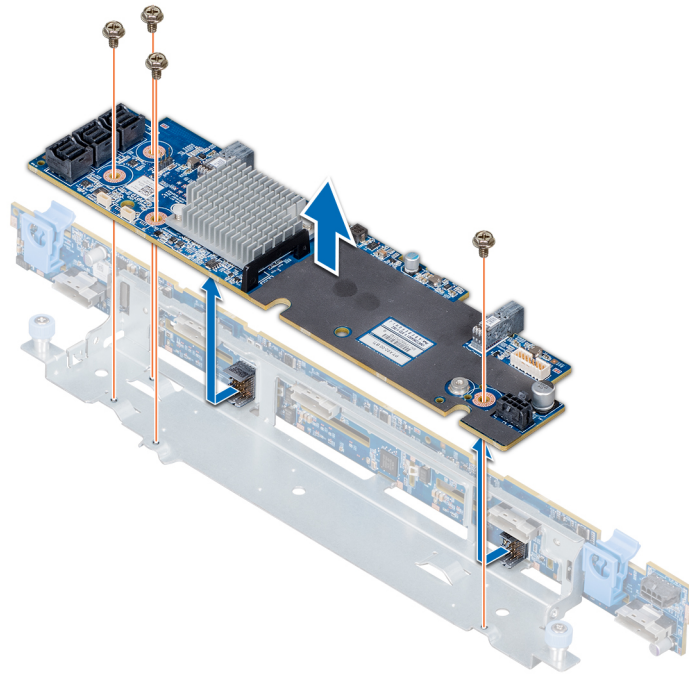

Figure 94. Removing the SAS expander card

Next steps

Install the SAS expander card.

Installing the SAS expander card

Prerequisites

Follow the safety guidelines listed in [Safety instructions](#).

Steps

1. Align the slots on the SAS expander card with the standoffs on the expander card tray.
2. Slide the SAS expansion card until the connectors on the SAS expander card engage with the SAS connectors on the backplane.
3. Using Philips #2 screwdriver, tighten the screws to secure the SAS expander card to the expander card tray.

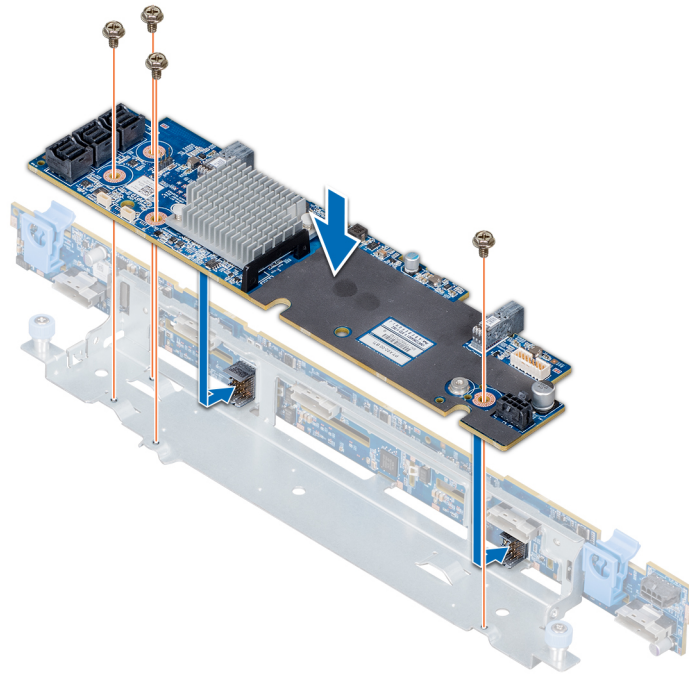

Figure 95. Installing the SAS expander card

Next steps

1. Connect the SAS cables to the SAS expander card.
2. [Install the backplane cover.](#)
3. Install the cooling fan assembly.
4. [Install the cooling shroud.](#)
5. Follow the procedure listed in [After working inside your system.](#)

Rear drive cage

Removing the rear drive cage

Prerequisites

1. Follow the safety guidelines listed in [Safety instructions.](#)
2. Follow the procedure listed in [Before working inside your system.](#)
3. Remove all the drives.
4. Disconnect all the cables from the rear drive backplane.

Steps

1. Using Phillips #2 screwdriver, loosen the screws that secure the drive cage to the system.
2. Pull and hold the screws to lift the drive cage away from the system.

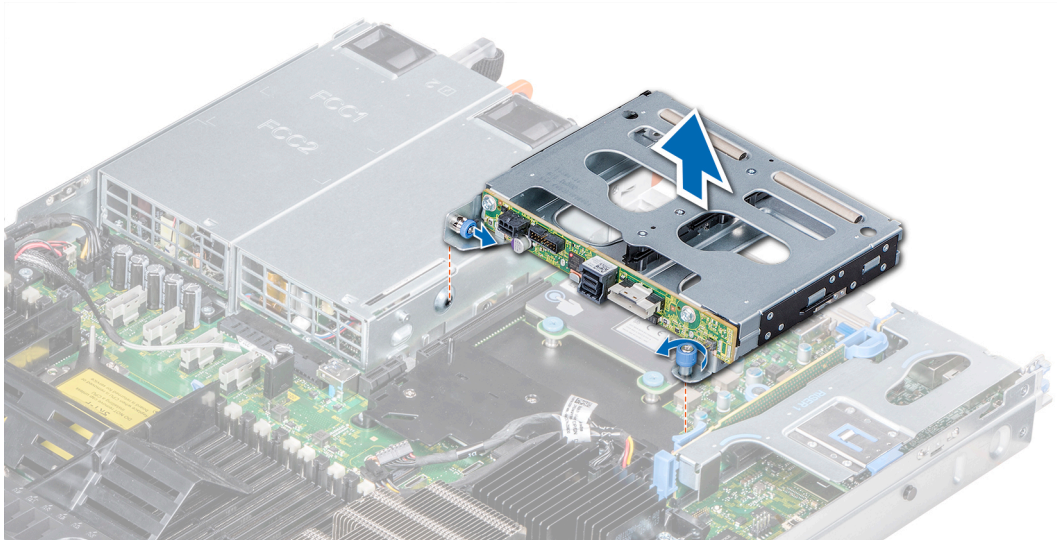

Figure 96. Removing the rear drive cage

Next steps

Install the rear drive cage.

Installing the rear drive cage

Prerequisites

Follow the safety guidelines listed in [Safety instructions](#).

Steps

1. Align the screws on the drive cage with the screw holes on the system chassis.
2. Lower the drive cage into the system until it is firmly seated and the screws lock into place.
3. Using Phillips #2 screwdriver, tighten the screws.

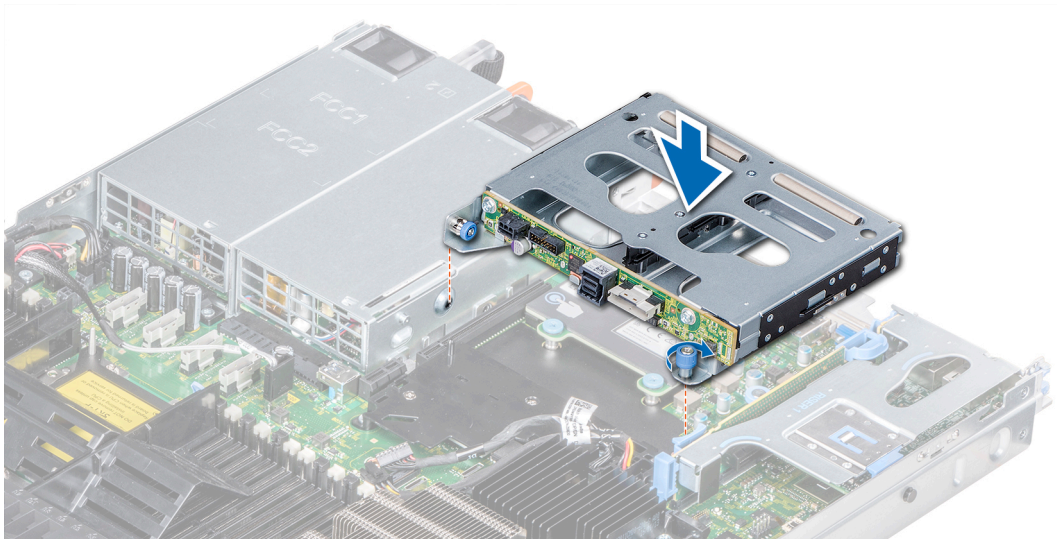

Figure 97. Installing the rear drive cage

Next steps

1. Reconnect all the disconnected cables to the rear drive backplane.
2. Install all the drives.

3. Follow the procedure listed in [After working inside your system](#).

System battery

Replacing the system battery

Prerequisites

⚠ WARNING: There is a danger of a new battery exploding if it is incorrectly installed. Replace the battery only with the same or equivalent type recommended by the manufacturer. For more information, see the safety information that shipped with your system.

1. Follow the safety guidelines listed in [Safety instructions](#).
2. Follow the procedure listed in [Before working inside your system](#).
3. If applicable, disconnect the power or data cables from expansion card(s) in the expansion card riser 1A.
4. [Remove the low profile or full height X1 expansion card riser 1A](#).

Steps

1. Locate the battery socket. For more information, see the [System board jumpers and connectors](#) section.

⚠ CAUTION: To avoid damage to the battery connector, you must firmly support the connector while installing or removing a battery.

2. Use a plastic scribe to pry out the system battery.

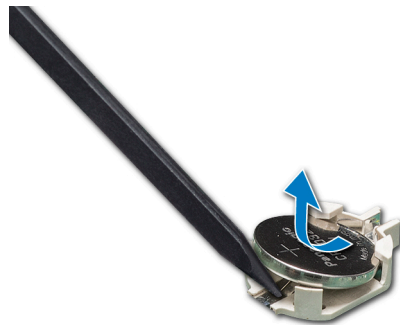

Figure 98. Removing the system battery

3. To install a new system battery, hold the battery with the positive side facing up and slide it under the securing tabs.
4. Press the battery into the connector until it snaps into place.

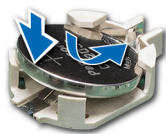

Figure 99. Installing the system battery

Next steps

1. [Install the expansion card riser 1A](#).
2. If applicable, connect the cables to the expansion card(s) in the expansion card riser 1A.
3. Follow the procedure listed in [After working inside your system](#).
4. While booting, press F2 to enter the System Setup and ensure that the battery is operating properly.
5. Enter the correct time and date in the System Setup **Time** and **Date** fields.
6. Exit the System Setup.

USB module

Removing the USB module

Prerequisites

1. Follow the safety guidelines listed in [Safety instructions](#).
2. Follow the procedure listed in [Before working inside your system](#).
3. [Remove the backplane cover](#).
4. [Remove the air shroud](#).

NOTE: Ensure that you note the routing of the cables as you remove them from the system board. Route these cables properly when you replace them to prevent them from being pinched or crimped.

NOTE: The procedure to remove the USB 3.0 and USB 2.0 modules is similar.

Steps

1. Disconnect the USB cable from the USB connector on the system board. For more information, see the System board jumpers and connectors section.
2. Using Phillips #1 screwdriver, remove the screws on the USB module.
3. Slide the module out of the system until it is free of the USB module slot on the front panel.

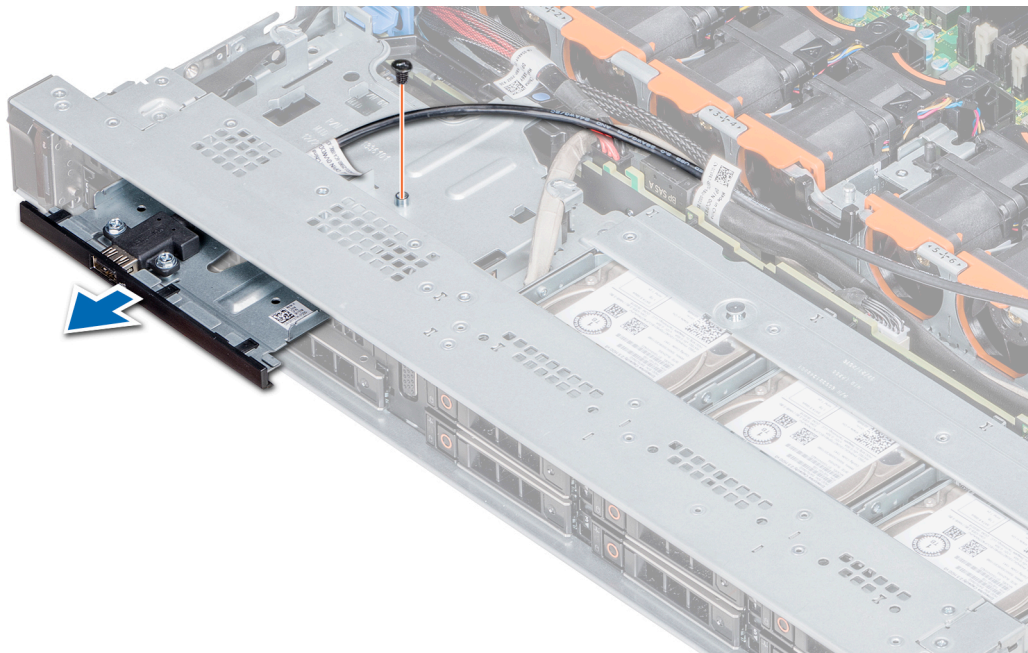

Figure 100. Removing the USB module

Next steps

Install the USB module.

Installing the USB module

Prerequisites

Follow the safety guidelines listed in [Safety instructions](#).

NOTE: The procedure to install the USB 3.0 and USB 2.0 modules is similar.

Steps

1. Route the USB cable on the USB module, through the USB slot on the front panel.
2. Insert the USB module into the slot on the front panel.
3. Align the screw on the module with the screw hole on the system.
4. Using the Phillips #1 screwdriver, replace the screw to secure the module to the system.
5. Route the USB cable and connect it to the USB connector on the system board. For more information, see the System board jumpers and connectors section.

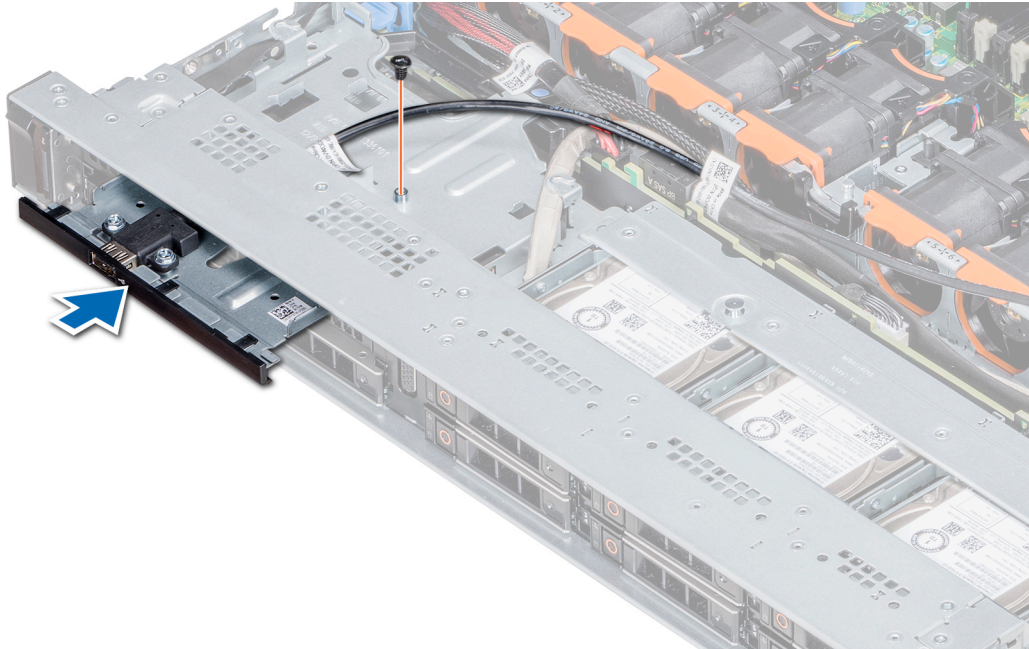

Figure 101. Installing the USB module

Next steps

1. [Install the air shroud.](#)
2. [Install the backplane cover.](#)
3. Follow the procedure listed in [After working inside your system.](#)

VGA module

Removing the VGA module

Prerequisites

1. Follow the safety guidelines listed in [Safety instructions.](#)
2. Follow the procedure listed in [Before working inside your system.](#)
3. [Remove the front bezel](#)
4. [Remove the backplane cover.](#)
5. [Remove the air shroud.](#)
6. Disconnect the VGA cable from the VGA connector on the system board. For locating the connector, see the [System board jumpers and connectors](#) section.

i **NOTE:** Ensure that you note the routing of the cables as you remove them from the system board. Route these cables properly when you replace them to prevent them from being pinched or crimped.

Steps

1. Using Phillips #1 screwdriver, remove the screw on the VGA module.

2. Slide the module out of the system.

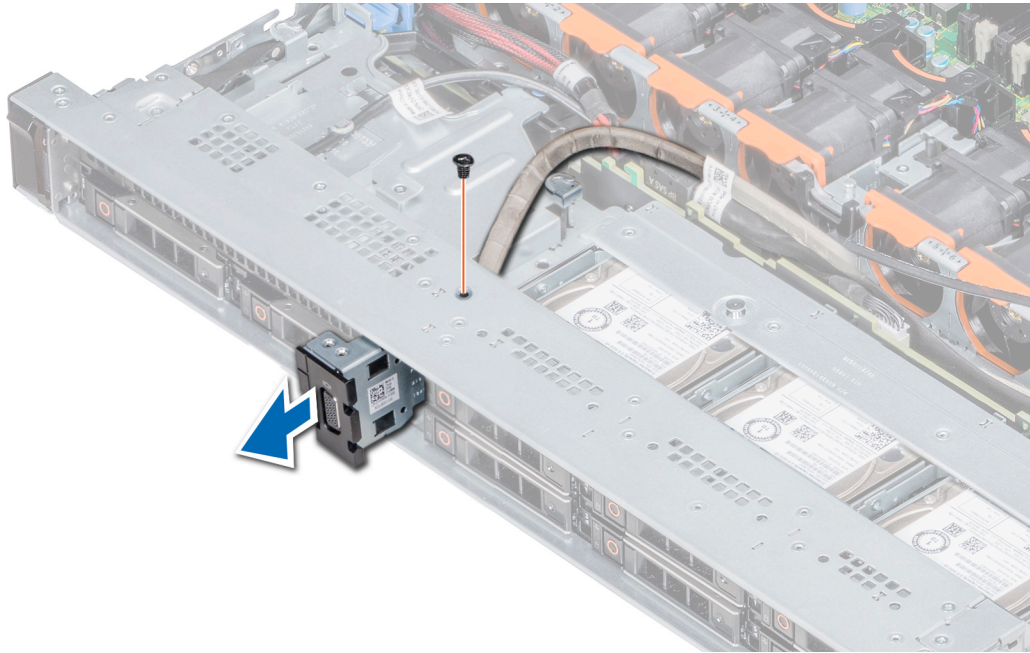

Figure 102. Removing the VGA module

Next steps

1. [Install the VGA module.](#)

Installing the VGA module

Prerequisites

1. Follow the safety guidelines listed in [Safety instructions](#).
2. Follow the procedure listed in [Before working inside your system](#).
3. [Remove the front bezel](#).
4. [Remove the backplane cover](#).
5. [Remove the air shroud](#).

NOTE: Ensure that you note the routing of the cables as you remove them from the system board. Route these cables properly when you replace them to prevent them from being pinched or crimped.

Steps

1. Route the VGA cable through the VGA module slot on the front of the system and slide the VGA module into the slot.
2. Align the hole on the module with the screw hole on the system.
3. Using the Phillips #1 screwdriver, secure the VGA module to the system with the screw.

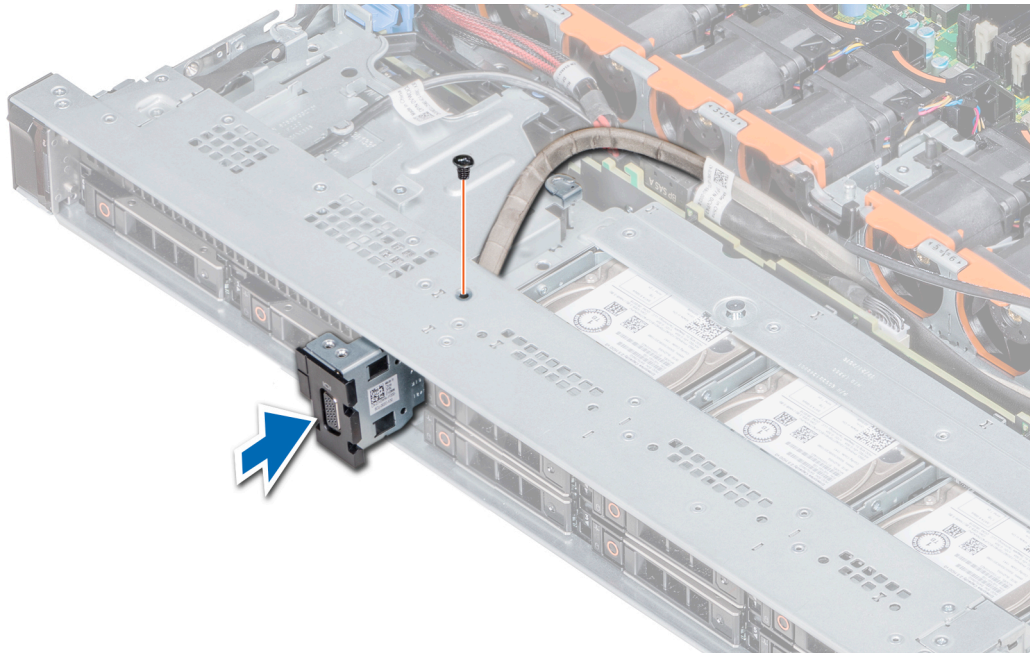

Figure 103. Installing the VGA module

Next steps

1. Route the VGA cable and connect it to the VGA connector on the system board. For locating the connector, see the [System board jumpers and connectors](#) section.
2. [Install the air shroud.](#)
3. [Install the backplane cover.](#)
4. [Install the front bezel.](#)
5. Follow the procedure listed in [After working inside your system.](#)

Optional internal USB memory key

An optional USB memory key can be installed in the internal USB 3.0 port.

NOTE: To locate the internal USB port on the system board, see the [System board jumpers and connectors](#) section.

For configurations that support USB 3.0 module, the USB 3.0 module cable connects to the internal USB port on the system board. In this scenario, the default internal USB port is available under the backplane cover. The position of the default internal USB port may vary depending on the configuration of your system.

Replacing the optional internal USB memory key

Prerequisites

CAUTION: To avoid interference with other components in the server, the maximum permissible dimensions of the USB memory key are 15.9 mm wide x 57.15 mm long x 7.9 mm high.

1. Follow the safety guidelines listed in [Safety instructions.](#)
2. Follow the procedure listed in [Before working inside your system.](#)

Steps

1. Locate the USB port or USB memory key on the system board.
To locate the USB port, see the [Jumpers and connectors](#) .
2. If installed, remove the USB memory key from the USB port.

3. Insert the replacement USB memory key into the USB port.

Next steps

1. Follow the procedure listed in [After working inside your system](#).
2. While booting, press F2 to enter **System Setup** and verify that the system detects the USB memory key.

Optical drive (optional)

Removing the optical drive

Prerequisites

1. Follow the safety guidelines listed in [Safety instructions](#).
2. Follow the procedure listed in [Before working inside your system](#).
3. If applicable, [remove the front bezel](#).
4. Disconnect the power and data cables from the connectors on the optical drive.

NOTE: Ensure that you note the routing of the power and data cable on the side of the system and drive. Route these cables properly when you replace them to prevent them from being pinched or crimped.

Steps

1. Press the release tab to release the optical drive.
2. Slide the optical drive out of the system until it is out of the optical drive slot.
3. If you are not adding a new optical drive, install the optical drive blank. The procedure to install the optical drive blank is the same as the optical drive.

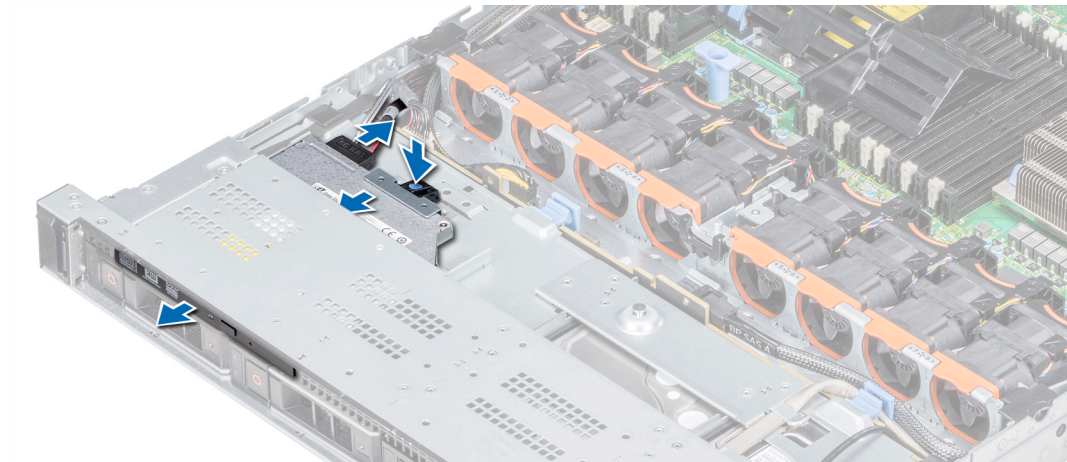

Figure 104. Removing optical drive

Next steps

[Install an optical drive](#).

Installing the optical drive

Prerequisites

Follow the safety guidelines listed in [Safety instructions](#).

Steps

1. Align the optical drive with the optical drive slot on the front of the system.
2. Slide in the optical drive until the release tab snaps into place.



Figure 105. Installing the optical drive

Next steps

1. Connect the power and data cables to the connector on the optical drive and the connector on the system board.
NOTE: Route the cable properly on the side of the system to prevent it from being pinched or crimped.
2. Follow the procedure listed in [After working inside your system](#).

Power supply units

The power supply unit (PSU) is an internal hardware component which supplies power to the components in the system.

Your system supports one of the following:

- Two 1600 W, 1100 W, 750 W, 750 W Mixed Mode, or 495 W AC PSUs
- Two 1100 W DC PSUs
- Two 1100 W or 750 W Mixed Mode HVDC PSUs

NOTE: For more information, see the [Technical specifications](#) section.

CAUTION: If two PSUs are installed, both the PSUs must have the same type of label. For example, Extended Power Performance (EPP) label. Mixing PSUs from previous generations of PowerEdge servers is not supported, even if the PSUs have the same power rating. Mixing PSUs will result in mismatch condition or failure to turn the system on.

NOTE: Titanium PSU is nominally rated for 200 V AC to 240 V AC input only.

NOTE: When two identical PSUs are installed, power supply redundancy (1+1 – with redundancy or 2+0 – without redundancy) is configured in system BIOS. In redundant mode, power is supplied to the system equally from both PSUs when Hot Spare is disabled. When Hot Spare is enabled, one of the PSUs is put into the sleep mode when system utilization is low in order to maximize efficiency.

NOTE: If two PSUs are used, they must be of the same maximum output power.

Hot spare feature

Your system supports the hot spare feature that significantly reduces the power overhead associated with power supply unit (PSU) redundancy.

When the hot spare feature is enabled, one of the redundant PSUs is switched to the sleep state. The active PSU supports 100 percent of the system load, thus operating at higher efficiency. The PSU in the sleep state monitors output voltage of the active PSU. If the output voltage of the active PSU drops, the PSU in the sleep state returns to an active output state.

If having both PSUs active is more efficient than having one PSU in the sleep state, the active PSU can also activate the sleeping PSU.

The default PSU settings are as follows:

- If the load on the active PSU is more than 50 percent of PSU rated power wattage, then the redundant PSU is switched to the active state.
- If the load on the active PSU falls below 20 percent of PSU rated power wattage, then the redundant PSU is switched to the sleep state.

You can configure the hot spare feature by using the iDRAC settings. www.dell.com/poweredgemanuals.

Removing a power supply unit blank

Prerequisites

Follow the safety guidelines listed in [Safety instructions](#).

Steps

If you are installing a second power supply unit, remove the power supply unit blank in the bay by pulling the blank outward.

CAUTION: To ensure proper system cooling, the power supply unit blank must be installed in the second power supply unit bay in a non-redundant configuration. Remove the power supply unit blank only if you are installing a second power supply unit.

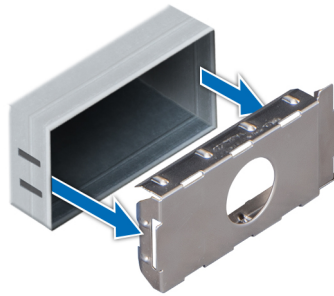

Figure 106. Removing a power supply unit blank

Next steps

Install the second power supply unit blank.

Installing a power supply unit blank

Prerequisites

1. Follow the safety guidelines listed in [Safety instructions](#).

NOTE: Install the power supply unit (PSU) blank only in the second PSU bay.

Steps

Align the PSU blank with the PSU slot and push it into the PSU slot until it clicks into place.

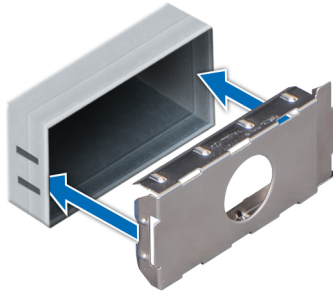

Figure 107. Installing a power supply unit blank

Next steps

Follow the procedure listed in [After working inside your system](#).

Removing a power supply unit

The procedure for removing AC and DC PSUs is identical.

Prerequisites

CAUTION: The system needs one power supply unit (PSU) for normal operation. On power-redundant systems, remove and replace only one PSU at a time in a system that is powered on.

1. Follow the safety guidelines listed in [Safety instructions](#).
2. Disconnect the power cable from the power source and from the PSU you intend to remove, and then remove the cable from the strap on the PSU handle.
3. Unlatch and lift the optional cable management arm if it interferes with the PSU removal.

For information about the cable management arm, see the system's rack documentation at www.dell.com/poweredgemanuals.

Steps

Press the orange release latch and slide the PSU out of the system by using the PSU handle.

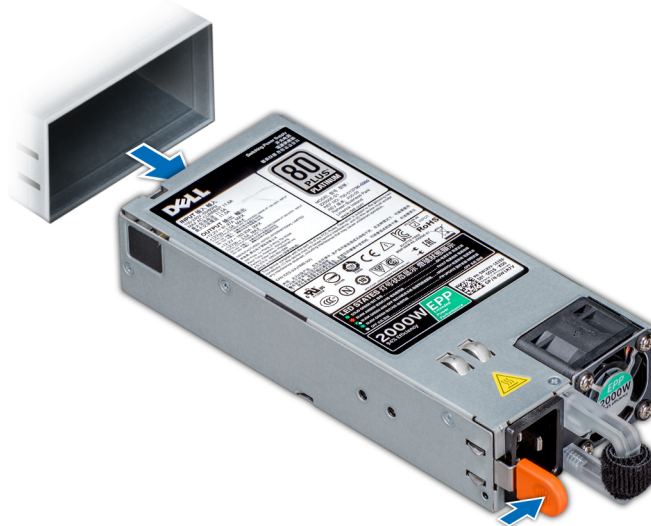

Figure 108. Removing a power supply unit

Next steps

Install the PSU or the PSU blank.

Installing a power supply unit

The procedure for installing AC and DC PSUs is identical.

Prerequisites

1. Follow the safety guidelines listed in [Safety instructions](#).
2. For systems that support redundant PSU, ensure that both the PSUs are of the same type and have the same maximum output power.

NOTE: The maximum output power (shown in watts) is listed on the PSU label.

Steps

Slide the PSU into the system until the PSU is fully seated and the release latch snaps into place.

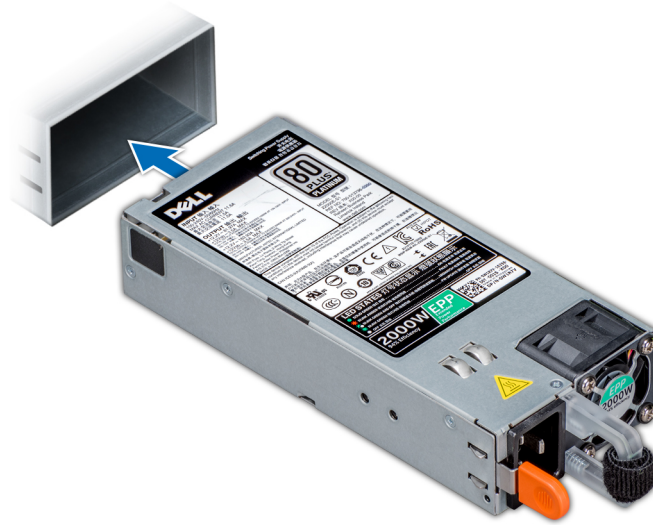

Figure 109. Installing a power supply unit

Next steps

1. If you have unlatched the cable management arm, relatch it. For information about the cable management arm, see the system's rack documentation at www.dell.com/poweredgemanuals.
2. Connect the power cable to the PSU, and plug the cable into a power outlet.

CAUTION: When connecting the power cable to the PSU, secure the cable to the PSU with the strap.

NOTE: When installing, hot swapping, or hot adding a new PSU, wait for 15 seconds for the system to recognize the PSU and determine its status. The PSU redundancy may not occur until discovery is complete. Wait until the new PSU is discovered and enabled before you remove the other PSU. The PSU status indicator turns green to signify that the PSU is functioning properly.

Removing a DC power supply unit

Prerequisites

NOTE: For equipment using $-(48-60)$ V DC power supply units (PSUs), a qualified electrician must perform all connections to DC power and to safety grounds. Do not attempt connecting to DC power or installing grounds yourself. All electrical wiring must comply with applicable local or national codes and practices. Damage due to servicing that is not authorized by Dell is not covered by your warranty. Read and follow all safety instructions that came with the product.

CAUTION: The system needs one PSU for normal operation. On power-redundant systems, remove and replace only one PSU at a time in a system that is powered on.

1. Follow the safety guidelines listed in [Safety instructions](#).
2. Disconnect the power wires from the power source and the connector from the PSU you intend to remove.
3. Disconnect the safety ground wire.
4. Unlatch and lift the optional cable management arm if it interferes with PSU removal. For information about the cable management arm, see the system's rack documentation at www.dell.com/poweredgemanuals.

Steps

Press the release latch and slide the PSU out of the system by using the PSU handle.

Next steps

[Install the DC PSU](#).

Installing DC power supply unit

Prerequisites

NOTE: For equipment using $-(48-60)$ V DC power supply units (PSUs), a qualified electrician must perform all connections to DC power and to safety grounds. Do not attempt connecting to DC power or installing grounds yourself. All electrical wiring must comply with applicable local or national codes and practices. Damage due to servicing that is not authorized by Dell is not covered by your warranty. Read and follow all safety instructions that came with the product.

1. Follow the safety guidelines listed in [Safety instructions](#).
2. For systems that support redundant power supply units (PSUs), ensure that both the PSUs are of the same type and have the same maximum output power.

NOTE: The maximum output power (shown in watts) is listed on the PSU label.

Steps

Slide the PSU into the system until the PSU is fully seated and the release latch snaps into place.

Next steps

1. If you have unlatched the cable management arm, relatch it. For information about the cable management arm, see the system's rack documentation at www.dell.com/poweredgemanuals.
2. Connect the safety ground wire.
3. Install the DC power connector in the PSU.

CAUTION: When connecting the power wires, ensure that you secure the wires with the strap to the PSU handle.

4. Connect the wires to a DC power source.

NOTE: When installing, hot-swapping, or hot-adding a new PSU, wait for 15 seconds for the system to recognize the PSU and determine its status. The PSU status indicator turns green to signify that the PSU is functioning properly.

Wiring instructions for a DC power supply unit

Your system supports up to two $-(48-60)$ V DC power supply units (PSUs).

NOTE: For equipment using $-(48-60)$ V DC power supply units (PSUs), a qualified electrician must perform all connections to DC power and to safety grounds. Do not attempt connecting to DC power or installing grounds yourself. All electrical wiring must comply with applicable local or national codes and practices. Damage due to servicing that is not authorized by Dell is not covered by your warranty. Read and follow all safety instructions that came with the product.

CAUTION: Wire the unit with copper only, unless otherwise specified, use only 10 American Wire Gauge (AWG) wire rated minimum 90°C for source and return. Protect the -(48-60) V DC (1 wire) with a branch circuit over-current protection rated 50 A for DC with a high interrupt current rating.

CAUTION: Connect the equipment to a -(48-60) V DC supply source that is electrically isolated from the AC source (reliably grounded -(48-60) V DC SELV source). Ensure that the -(48-60) V DC source is efficiently secured to earth (ground).

NOTE: A readily accessible disconnect device that is suitably approved and rated shall be incorporated in the field wiring.

Input requirements

- Supply voltage: -(48-60) V DC
- Current consumption: 32 A (maximum)

Kit contents

- Dell part number 6RYJ9 terminal block or equivalent (1)
- #6-32 nut equipped with lock washer (1)

Required tools

Wire-stripper pliers capable of removing insulation from size 10 AWG solid or stranded, insulated copper wire.

NOTE: Use alpha wire part number 3080 or equivalent (65/30 stranding).

Required wires

- One UL 10 AWG, 2 m maximum (stranded) black wire [-(48-60) V DC].
- One UL 10 AWG, 2 m maximum (stranded) red wire (V DC return).
- One UL 10 AWG, 2 m maximum, green with a yellow stripe, stranded wire (safety ground).

System board

Removing the system board

Prerequisites

CAUTION: If you are using the Trusted Platform Module (TPM) with an encryption key, you may be prompted to create a recovery key during program or System Setup. Be sure to create and safely store this recovery key. If you replace this system board, you must supply the recovery key when you restart your system or program before you can access the encrypted data on your drives.

CAUTION: Do not attempt to remove the TPM plug-in module from the system board. Once the TPM plug-in module is installed, it is cryptographically bound to that specific system board. Any attempt to remove an installed TPM plug-in module breaks the cryptographic binding, and it cannot be re-installed or installed on another system board.

1. Follow the safety guidelines listed in [Safety instructions](#).
2. Follow the procedure listed in [Before working inside your system](#).
3. Remove the following:

CAUTION: Do not lift the system board by holding a memory module, processor, or other components.

- a. [Air shroud](#)
- b. [All expansion cards and risers](#)
- c. [Integrated storage controller card](#)
- d. [Internal USB key \(if applicable\)](#)
- e. [Internal USB key \(if applicable\)](#)

- f. [USB 3.0 module](#) (if applicable))
- g. [Processors and heat sink modules](#)
- h. Processors blanks (if installed)

CAUTION: To prevent damage to the processor socket when replacing a faulty system board, ensure that you cover the processor socket with the processor dust cover.

- i. [Memory modules](#) and memory module blanks
- j. [Network daughter card](#)

Steps

1. Disconnect all cables from the system board.

CAUTION: Take care not to damage the system identification button while removing the system board from the chassis.

2. Holding the post, lift the blue release pin, and slide the system board toward the front of the system to disengage the connectors from the slots on the chassis.
3. Incline the system board at an angle, and lift the system board out of the chassis.

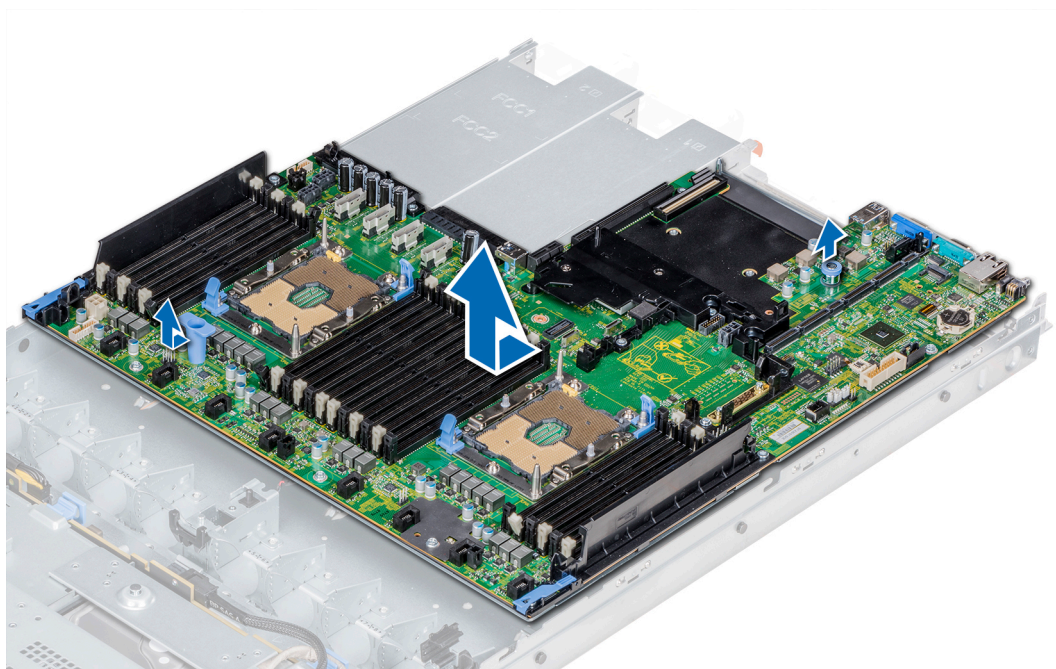

Figure 110. Removing the system board

Next steps

Install the system board.

Installing the system board

Prerequisites

Follow the safety guidelines listed in [Safety instructions](#).

Steps

1. Unpack the new system board assembly.

CAUTION: Do not lift the system board by holding a memory module, processor, or other components.

CAUTION: Take care not to damage the system identification button while placing the system board into the chassis.

2. Holding the post and release pin, incline the system board, and lower the system board into the chassis.

3. Slide the system board toward the back of the system until the release pin clicks into place.

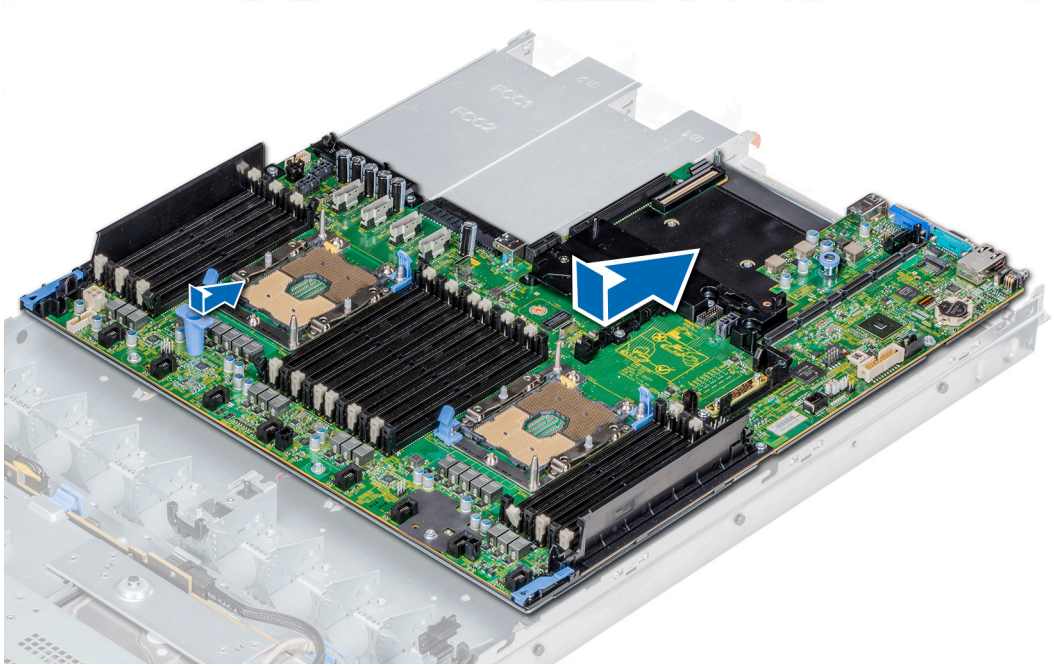

Figure 111. Installing the system board

Next steps

1. Replace the following:
 - a. Trusted Platform Module (TPM)
 - b. Integrated storage controller card
 - c. Internal USB key (if applicable)
 - d. USB 3.0 module (if applicable)
 - e. Internal USB key (if applicable)
 - f. All expansion cards and risers
 - g. Processors and heat sink modules
 - h. Processors blanks (if applicable)
 - i. Memory modules and memory module blanks
 - j. Network daughter card
 - k. Air shroud
2. Reconnect all cables to the system board.
i **NOTE:** Ensure that the cables inside the system are routed along the chassis wall and secured using the cable securing bracket.
3. Follow the procedure listed in [After working inside your system](#).
4. Ensure that you:
 - a. Use the Easy Restore feature to restore the Service Tag. For more information, see the [Restoring the Service Tag by using the Easy Restore](#) feature section.
 - b. If the Service Tag is not backed up in the backup flash device, [enter the Service Tag](#) manually.
 - c. Update the BIOS and iDRAC versions.
 - d. Re-enable the Trusted Platform Module (TPM). For more information, see the [Upgrading the Trusted Platform Module](#) section.
5. Import your new or existing iDRAC Enterprise license.

For more information, see *Integrated Dell Remote Access Controller User's Guide*, at www.dell.com/poweredge/manuals.

Restoring the system using Easy Restore

The easy restore feature enables you to restore your service tag, license, UEFI configuration, and the system configuration data after replacing the system board. All data is backed up in a backup flash device automatically. If BIOS detects a new system board, and the service tag in the backup flash device, BIOS prompts the user to restore the backup information.

About this task

Below is a list of options available:

- Restore the service tag, license, and diagnostics information, press **Y**
- Navigate to the Lifecycle Controller based restore options, press **N**.
- Restore data from a previously created **Hardware Server Profile**, press **F10**

i **NOTE:** When the restore process is complete, BIOS prompts to restore the system configuration data.

- To restore the system configuration data, press **Y**
- To use the default configuration settings, press **N**

i **NOTE:** After the restore process is complete, system reboots.

Manually update the Service Tag

After replacing a system board, if Easy Restore fails, follow this process to manually enter the Service Tag, using **System Setup**.

About this task

If you know the system service tag, use the **System Setup** menu to enter the service tag.

Steps

1. Power on the system.
2. To enter the **System Setup**, press **F2**.
3. Click **Service Tag Settings**.
4. Enter the service tag.

i **NOTE:** You can enter the service tag only when the Service Tag field is empty. Ensure that you enter the correct service tag. Once the service tag is entered, it cannot be updated or changed.

5. Click **OK**.

Entering the system Service Tag by using System Setup

If Easy Restore fails to restore the Service Tag, use System Setup to enter the Service Tag.

Steps

1. Turn on the system.
2. Press F2 to enter System Setup.
3. Click **Service Tag Settings**.
4. Enter the Service Tag.

i **NOTE:** You can enter the Service Tag only when the Service Tag field is empty. Ensure that you enter the correct Service Tag. After the Service Tag is entered, it cannot be updated or changed.

5. Click **OK**.
6. Import your new or existing iDRAC Enterprise license.

For more information, see the *Integrated Dell Remote Access Controller User's Guide* at www.dell.com/poweredge/manuals.

Trusted Platform Module

Upgrading the Trusted Platform Module

Prerequisites

1. Follow the safety guidelines listed in [Safety instructions](#).
2. Follow the procedure listed in [Before working inside your system](#).

i **NOTE:**

- Ensure that your operating system supports the version of the TPM module being installed.

- Ensure that you download and install the latest BIOS firmware on your system.
- Ensure that the BIOS is configured to enable UEFI boot mode.

About this task

CAUTION: If you are using the Trusted Platform Module (TPM) with an encryption key, you may be prompted to create a recovery key during program or System Setup. Work with the customer to create and safely store this recovery key. When replacing this system board, you must supply the recovery key when you restart your system or program before you can access the encrypted data on your hard drives.

CAUTION: Once the TPM plug-in module is installed, it is cryptographically bound to that specific system board. Any attempt to remove an installed TPM plug-in module breaks the cryptographic binding, the removed TPM cannot be reinstalled or installed on another system board.

Removing the TPM

Steps

1. Locate the TPM connector on the system board.
2. Press to hold the module down and remove the screw using the security Torx 8-bit shipped with the TPM module.
3. Slide the TPM module out from its connector.
4. Push the plastic rivet away from the TPM connector and rotate it 90° counterclockwise to release it from the system board.
5. Pull the plastic rivet out of its slot on the system board.

Installing the TPM

Steps

1. To install the TPM, align the edge connectors on the TPM with the slot on the TPM connector.
2. Insert the TPM into the TPM connector such that the plastic rivet aligns with the slot on the system board.
3. Press the plastic rivet until the rivet snaps into place.

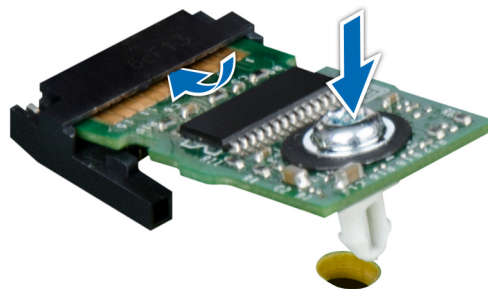

Figure 112. Installing the TPM

Next steps

1. [Install the system board.](#)
2. Follow the procedure listed in [After working inside your system.](#)

Initializing TPM for BitLocker users

Steps

Initialize the TPM.

For more information, see <http://technet.microsoft.com/en-us/library/cc753140.aspx>

The **TPM Status** changes to **Enabled, Activated**.

Initializing the TPM 1.2 for TXT users

Steps

1. While booting your system, press F2 to enter System Setup.
2. On the **System Setup Main Menu** screen, click **System BIOS > System Security Settings**.
3. From the **TPM Security** option, select **On with Pre-boot Measurements**.
4. From the **TPM Command** option, select **Activate**.
5. Save the settings.
6. Restart your system.
7. Enter **System Setup** again.
8. On the **System Setup Main Menu** screen, click **System BIOS > System Security Settings**.
9. From the **Intel TXT** option, select **On**.

Control panel

Removing the left control panel

Prerequisites

1. Follow the safety guidelines listed in [Safety instructions](#).
2. Follow the procedure listed in [Before working inside your system](#).
3. [Remove the air shroud](#).
4. For ease of removal of the left control panel, [remove the cooling fan #1](#) to access the cable latch.

Steps

1. Pull the cable latch and disconnect the control panel cable from the system board connector.
2. Pull the cable latch and disconnect the control panel cable from the system board connector.
3. Using a Phillips #1 screwdriver, remove the screws that secure the cable cover.



Figure 113. Removing the cable cover

4. Using a Phillips #1 screwdriver, remove the screws that connect the control panel to the system.

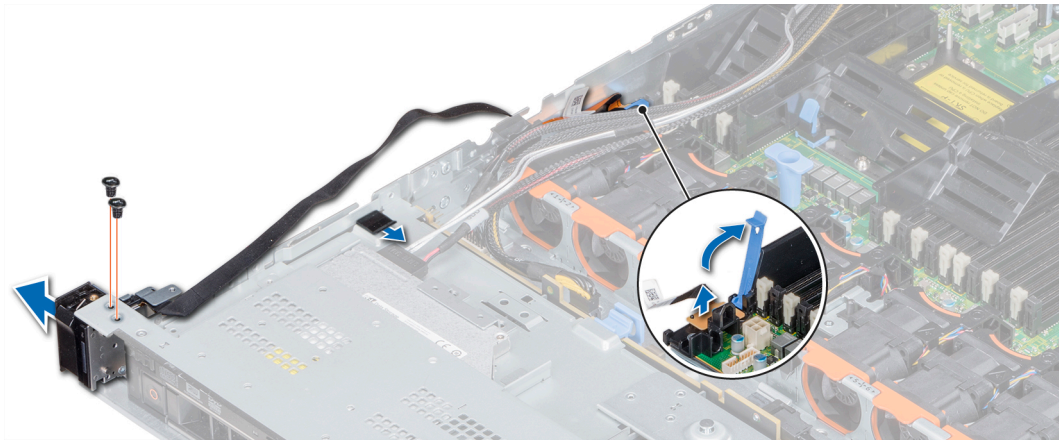

Figure 114. Removing left control panel

5. Holding the control panel by its sides, remove the control panel away from the system.

Next steps

Install the left control panel.

Installing the left control panel

Prerequisites

Follow the safety guidelines listed in [Safety instructions](#).

Steps

1. Route the control panel cable through the side wall of the system.
2. Align the left control panel assembly with the control panel slot on the system and place the assembly in the slot on the system.
3. Connect the control panel cable to the system board connector and secure it using cable latch.
4. Using a Phillips #1 screwdriver, install the screws that secure the control panel to the system.

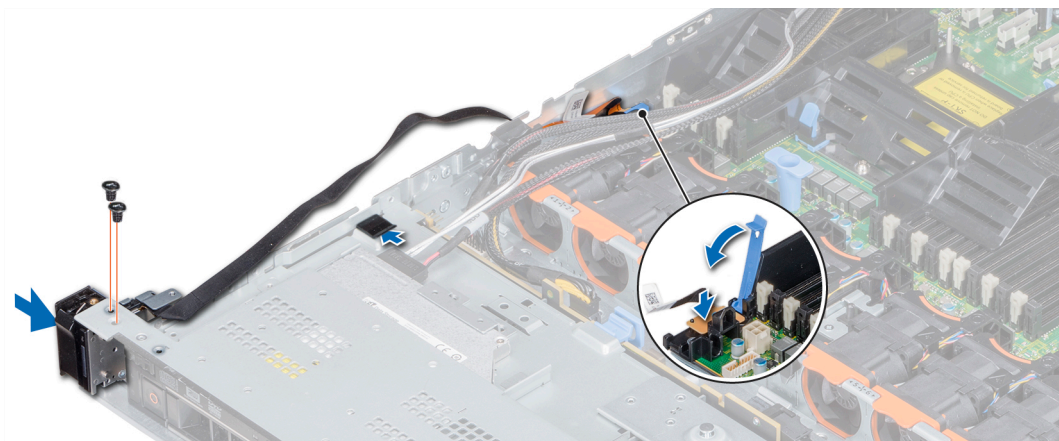

Figure 115. Installing the left control panel

5. Using Phillips #1 screwdriver, install the screws that secure the cable cover to the system.

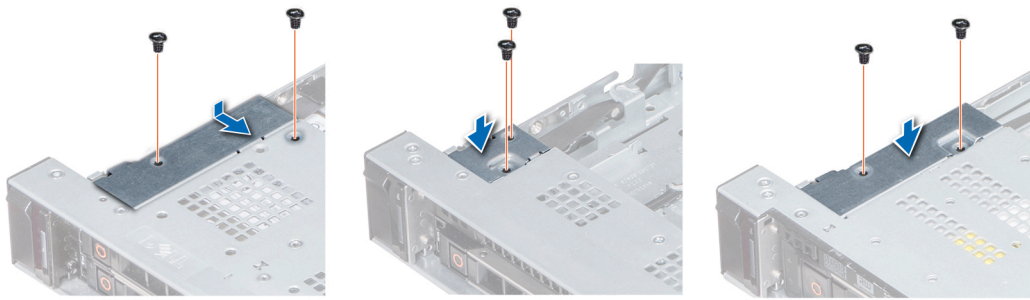

Figure 116. Installing the cable cover

Next steps

1. [Install the air shroud.](#)
2. If applicable, [install the cooling fan #1.](#)
3. Follow the procedure listed in [After working inside your system.](#)

Removing the right control panel

Prerequisites

1. Follow the safety guidelines listed in [Safety instructions.](#)
2. Follow the procedure listed in [Before working inside your system.](#)
3. For ease of removal of the right control panel, [remove the cooling fan #8](#) to access the cable latch.

Steps

1. Lift the cable latch and disconnect the control panel cable from the connector on the system board.

NOTE: Ensure that you note the routing of the cables as you remove them from the system board. You must route the cables properly when you replace them to prevent the cables from being pinched or crimped.

2. Using a Phillips #1 screwdriver, remove the screws that secure the cable cover to the system.



Figure 117. Removing the cable cover

3. Using a Phillips #1 screwdriver, remove the screw that secures the control panel to the system.

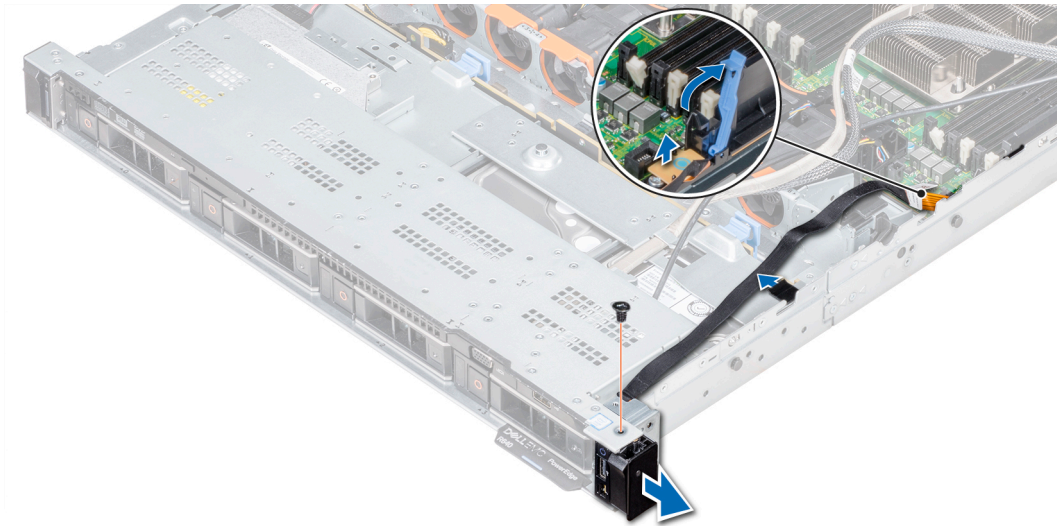

Figure 118. Removing right control panel

4. Holding by the sides, remove the right control panel away from the system.
5. Holding the control panel by its sides, remove the control panel away from the system.

Next steps

Install the right control panel.

Installing the right control panel

Prerequisites

Follow the safety guidelines listed in [Safety instructions](#).

Steps

1. Route the control panel cable through the side wall of the system.
2. Align the right control panel assembly with the control panel slot on the system.
3. Connect the control panel cable to the connector on the system board and lower the cable latch to secure the cable in place.
4. Using a Phillips #1 screwdriver, install the screw that secures the control panel to the system.

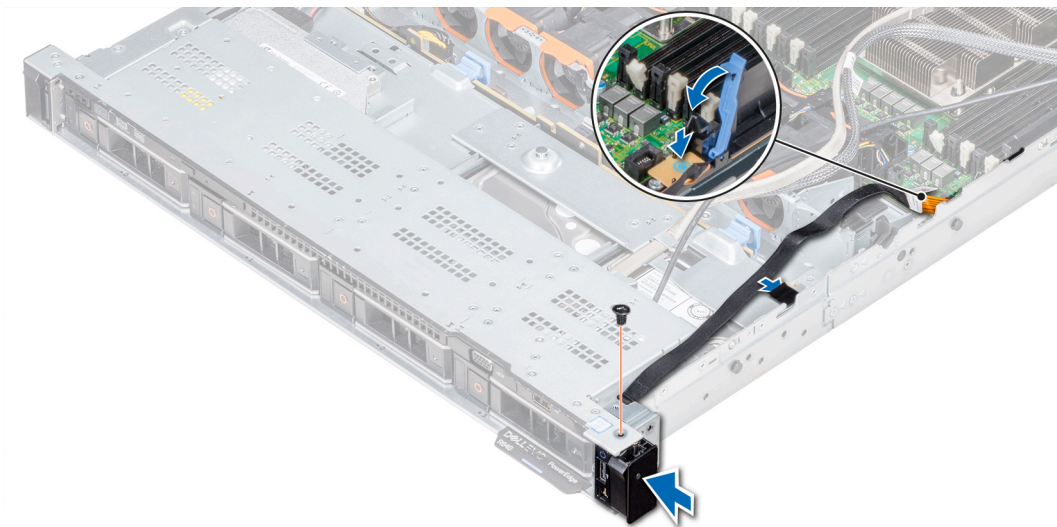

Figure 119. Installing the right control panel

5. Using a Phillips #1 screwdriver, install the screws that secure the cable cover to the system.



Figure 120. Installing the cable cover

Next steps

1. If applicable, [install the cooling fan #8](#).
2. Follow the procedure listed in [After working inside your system](#).

System diagnostics

If you experience a problem with your system, run the system diagnostics before contacting Dell for technical assistance. The purpose of running system diagnostics is to test your system hardware without using additional equipment or risking data loss. If you are unable to fix the problem yourself, service and support personnel can use the diagnostics results to help you solve the problem.

Topics:

- [Dell Embedded System Diagnostics](#)

Dell Embedded System Diagnostics

 **NOTE:** The Dell Embedded System Diagnostics is also known as Enhanced Pre-boot System Assessment (ePSA) diagnostics.

The Embedded System Diagnostics provides a set of options for particular device groups or devices allowing you to:

- Run tests automatically or in an interactive mode
- Repeat tests
- Display or save test results
- Run thorough tests to introduce additional test options to provide extra information about the failed device(s)
- View status messages that inform you if tests are completed successfully
- View error messages that inform you of problems encountered during testing

Running the Embedded System Diagnostics from Boot Manager

Run the Embedded System Diagnostics (ePSA) if your system does not boot.

Steps

1. When the system is booting, press F11.
2. Use the up arrow and down arrow keys to select **System Utilities > Launch Diagnostics**.
3. Alternatively, when the system is booting, press F10, select **Hardware Diagnostics > Run Hardware Diagnostics**.
The **ePSA Pre-boot System Assessment** window is displayed, listing all devices detected in the system. The diagnostics starts executing the tests on all the detected devices.

Results

Running the Embedded System Diagnostics from the Dell Lifecycle Controller

Steps

1. As the system boots, press F10.
2. Select **Hardware Diagnostics → Run Hardware Diagnostics**.
The **ePSA Pre-boot System Assessment** window is displayed, listing all devices detected in the system. The diagnostics starts executing the tests on all the detected devices.

System diagnostic controls

Menu	Description
Configuration	Displays the configuration and status information of all detected devices.
Results	Displays the results of all tests that are run.
System health	Provides the current overview of the system performance.
Event log	Displays a time-stamped log of the results of all tests run on the system. This is displayed if at least one event description is recorded.

Jumpers and connectors

This topic provides specific information about the jumpers. It also provides some basic information about jumpers and switches and describes the connectors on the various boards in the system. Jumpers on the system board help to disable the system and setup passwords. You must know the connectors on the system board to install components and cables correctly.

Topics:

- [System board jumpers and connectors](#)
- [System board jumper settings](#)
- [Disabling forgotten password](#)

System board jumpers and connectors

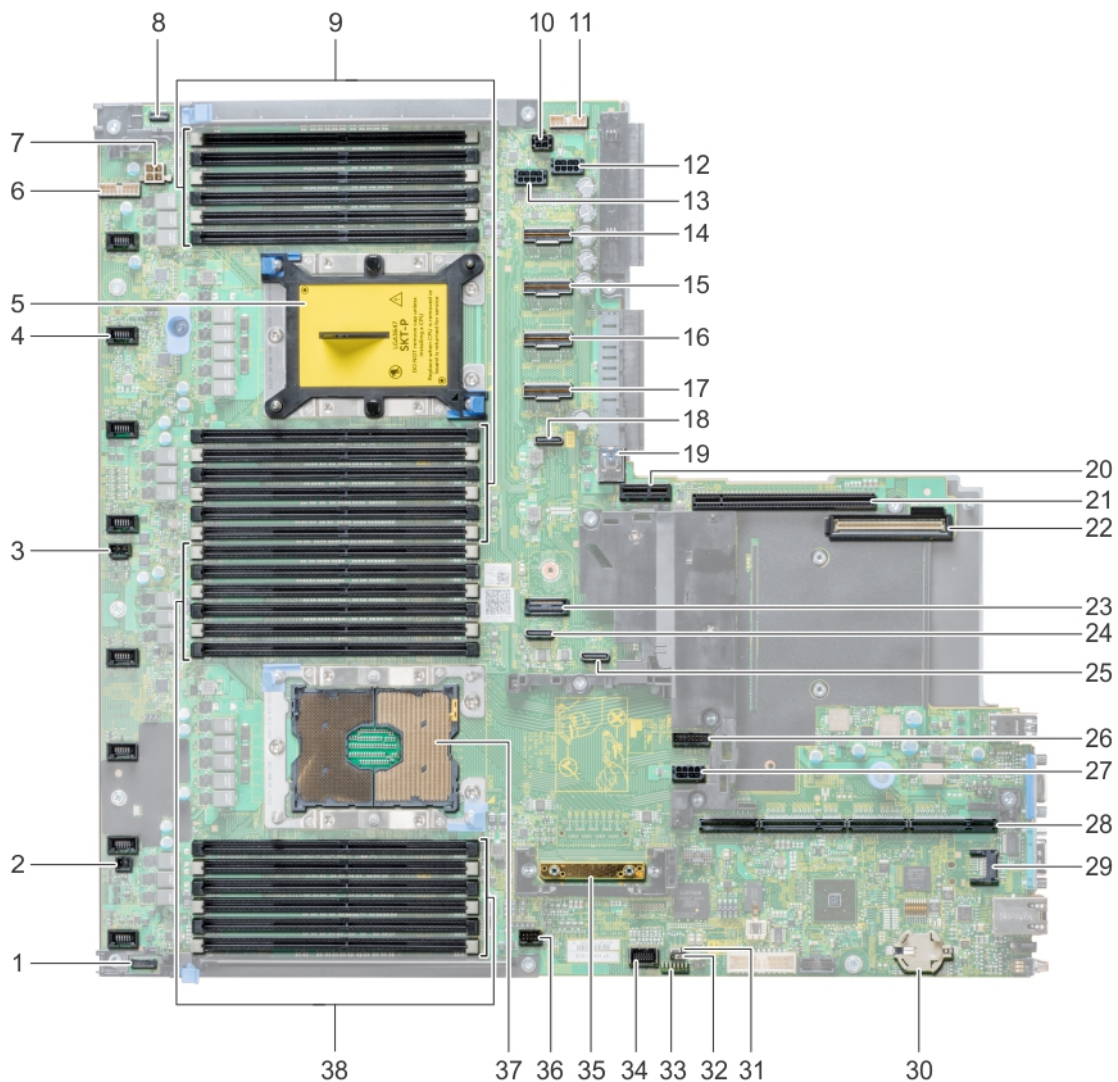

Figure 121. System board jumpers and connectors

Table 57. System board jumpers and connectors

Item	Connector	Description
1.	P_RG1_CP	Right panel connector
2.	J_WS_PWRBTN	Power button connector
3.	J_INTRUSION_DET1	Intrusion switch connector
4.	J_FAN1U_2	Cooling fan connector
5.	CPU2	Processor socket 2
6.	J_BATT_SIG	Battery signal connector
7.	J_BATT_PWR	Battery power connector
8.	CP	Left control panel connector
9.	B6, B12, B5, B11, B4, B10, B7, B1, B8, B2, B9, B3	Memory module sockets
10.	J_ODD	Optical drive connector
11	J_BP_SIG1	Backplane signal connector 1
12	J_BP1	Backplane connector 1
13	J_BP2	Backplane connector 2
14	J_STORAGE_M4	SAS connector 4
15	J_STORAGE_M3	SAS connector 3
16	J_STORAGE_M2	SAS connector 2
17	J_STORAGE_M1	SAS connector 1
18	J_SATA_C	SATA connector
19	J_USB_INT	Internal USB port
20	J_IDSDM_vFLASH	IDS DM/vFlash module connector
21	J_RISER2	Riser 2 connector
22	J_NDC	Network Daughter Card connector
23	J1	SATA connector
24	J_SATA_B	SATA connector
25	J_SATA_A	SATA connector
26	J_BP_SIG0	Backplane signal connector 0
27	J_BPO	Backplane power connector
28	J_R1_SS82_2	Riser 1 connector
29	J_TPM_MODULE1	TPM module connector
30	BATTERY	Battery connector
31	NVRAM_CLR	Clear NVRAM
32	PWRD_EN	Reset BIOS password
33	LED's	System board diagnostic LED indicators
34	J_VGA	VGA connector
35	J_STORAGE1	Mini PERC controller connector
36	J_USB_INT1	USB connector
37	CPU1	Processor socket 1
38	A6, A12, A5, A11, A4, A10, A7, A1, A8, A2, A9, A3	Memory module sockets

System board jumper settings

For information on resetting the password jumper to disable a password, see the [Disabling a forgotten password](#) section.

Disabling forgotten password

The software security features of the system include a system password and a setup password. The password jumper enables or disables password features and clears any password(s) currently in use.

Prerequisites

CAUTION: Many repairs may only be done by a certified service technician. You should only perform troubleshooting and simple repairs as authorized in your product documentation, or as directed by the online or telephone service and support team. Damage due to servicing that is not authorized by Dell is not covered by your warranty. Read and follow the safety instructions that are shipped with your product.

Steps

1. Power off the system, including any attached peripherals, and disconnect the system from the electrical outlet.
2. Remove the system cover.
3. Move the jumper on the system board jumper from pins 2 and 4 to pins 4 and 6.
4. Install the system cover.

The existing passwords are not disabled (erased) until the system boots with the jumper on pins 4 and 6. However, before you assign a new system and/or setup password, you must move the jumper back to pins 2 and 4.

NOTE: If you assign a new system and/or setup password with the jumper on pins 4 and 6, the system disables the new password(s) the next time it boots.

5. Reconnect the system to its electrical outlet and power on the system, including any attached peripherals.
6. Power off the system, including any attached peripherals, and disconnect the system from the electrical outlet.
7. Remove the system cover.
8. Move the jumper on the system board jumper from pins 4 and 6 to pins 2 and 4.
9. Install the system cover.
10. Reconnect the system to its electrical outlet and power on the system, including any attached peripherals.
11. Assign a new system and/or setup password.

Getting help

Topics:

- [Contacting Dell EMC](#)
- [Documentation feedback](#)
- [Accessing system information by using QRL](#)
- [Receiving automated support with SupportAssist](#)
- [Recycling or End-of-Life service information](#)

Contacting Dell EMC

Dell EMC provides several online and telephone based support and service options. If you do not have an active internet connection, you can find contact information about your purchase invoice, packing slip, bill, or Dell EMC product catalog. Availability varies by country and product, and some services may not be available in your area. To contact Dell EMC for sales, technical assistance, or customer service issues:

Steps

1. Go to www.dell.com/support/home.
2. Select your country from the drop-down menu on the lower right corner of the page.
3. For customized support:
 - a) Enter your system Service Tag in the **Enter your Service Tag** field.
 - b) Click **Submit**.
The support page that lists the various support categories is displayed.
4. For general support:
 - a) Select your product category.
 - b) Select your product segment.
 - c) Select your product.
The support page that lists the various support categories is displayed.
5. For contact details of Dell EMC Global Technical Support:
 - a) Click [Global Technical Support](#).
 - b) The **Contact Technical Support** page is displayed with details to call, chat, or e-mail the Dell EMC Global Technical Support team.

Documentation feedback

You can rate the documentation or write your feedback on any of our Dell EMC documentation pages and click **Send Feedback** to send your feedback.

Accessing system information by using QRL

You can use the Quick Resource Locator (QRL) located on the information tag in the front of the R640, to access the information about the Dell EMC PowerEdge R640.

Prerequisites

Ensure that your smartphone or tablet has the QR code scanner installed.

The QRL includes the following information about your system:

- How-to videos
- Reference materials, including the Installation and Service Manual, LCD diagnostics, and mechanical overview
- Your system service tag to quickly access your specific hardware configuration and warranty information

- A direct link to Dell to contact technical assistance and sales teams

Steps

1. Go to www.dell.com/qrl and navigate to your specific product or
2. Use your smartphone or tablet to scan the model-specific Quick Resource (QR) code on your system or in the Quick Resource Locator section.

Quick Resource Locator for R640



Figure 122. Quick Resource Locator for PowerEdge R640

Receiving automated support with SupportAssist

Dell EMC SupportAssist is an optional Dell EMC Services offering that automates technical support for your Dell EMC server, storage, and networking devices. By installing and setting up a SupportAssist application in your IT environment, you can receive the following benefits:

- **Automated issue detection** — SupportAssist monitors your Dell EMC devices and automatically detects hardware issues, both proactively and predictively.
- **Automated case creation** — When an issue is detected, SupportAssist automatically opens a support case with Dell EMC Technical Support.
- **Automated diagnostic collection** — SupportAssist automatically collects system state information from your devices and uploads it securely to Dell EMC. This information is used by Dell EMC Technical Support to troubleshoot the issue.
- **Proactive contact** — A Dell EMC Technical Support agent contacts you about the support case and helps you resolve the issue.

The available benefits vary depending on the Dell EMC Service entitlement purchased for your device. For more information about SupportAssist, go to www.dell.com/supportassist.

Recycling or End-of-Life service information

Take back and recycling services are offered for this product in certain countries. If you want to dispose of system components, visit www.dell.com/recyclingworldwide and select the relevant country.