

Inspiron 3671

Service Manual

Notes, cautions, and warnings

 **NOTE:** A NOTE indicates important information that helps you make better use of your product.

 **CAUTION:** A CAUTION indicates either potential damage to hardware or loss of data and tells you how to avoid the problem.

 **WARNING:** A WARNING indicates a potential for property damage, personal injury, or death.

© 2019 Dell Inc. or its subsidiaries. All rights reserved. Dell, EMC, and other trademarks are trademarks of Dell Inc. or its subsidiaries. Other trademarks may be trademarks of their respective owners.

| | |
|---|-----------|
| 1 Working inside your computer | 7 |
| Safety instructions..... | 7 |
| Before working inside your computer..... | 7 |
| Before you begin | 7 |
| Electrostatic discharge—ESD protection..... | 8 |
| ESD field service kit | 8 |
| Transporting sensitive components..... | 9 |
| After working inside your computer..... | 9 |
| 2 Recommended tools | 10 |
| 3 Screw list | 11 |
| 4 Inside view of your computer | 13 |
| 5 System-board components | 14 |
| 6 Removing the computer cover | 15 |
| Procedure..... | 15 |
| 7 Replacing the computer cover | 16 |
| Procedure..... | 16 |
| 8 Removing the front bezel | 17 |
| Procedure..... | 17 |
| Prerequisites..... | 18 |
| 9 Replacing the front bezel | 19 |
| Procedure..... | 19 |
| Post-requisites..... | 19 |
| 10 Removing the memory module | 20 |
| Prerequisites..... | 20 |
| Procedure..... | 20 |
| 11 Replacing the memory module | 21 |
| Procedure..... | 21 |
| Post-requisites..... | 21 |
| 12 Removing the solid-state drive/Intel Optane | 22 |
| Prerequisites..... | 22 |
| Procedure..... | 22 |

| | |
|---|-----------|
| 13 Replacing the solid-state drive/Intel Optane..... | 23 |
| Procedure..... | 23 |
| Post-requisites..... | 23 |
| 14 Removing the coin-cell battery..... | 24 |
| Procedure..... | 24 |
| Prerequisites..... | 24 |
| 15 Replacing the coin-cell battery..... | 25 |
| Procedure..... | 25 |
| Post-requisites..... | 25 |
| 16 Removing the wireless card..... | 26 |
| Procedure..... | 26 |
| Prerequisites..... | 27 |
| 17 Replacing the wireless card..... | 28 |
| Procedure..... | 28 |
| Post-requisites..... | 28 |
| 18 Removing the power-supply unit..... | 29 |
| Prerequisites..... | 29 |
| Procedure..... | 29 |
| 19 Replacing the power-supply unit..... | 30 |
| Procedure..... | 30 |
| Post-requisites..... | 30 |
| 20 Removing the 3.5-inch hard drive..... | 31 |
| Prerequisites..... | 31 |
| Procedure..... | 31 |
| 21 Replacing the 3.5-inch hard drive..... | 32 |
| Procedure..... | 32 |
| Post-requisites..... | 32 |
| 22 Removing the 2.5-inch hard drive..... | 33 |
| Prerequisites..... | 33 |
| Procedure..... | 33 |
| 23 Replacing the 2.5-inch hard drive..... | 35 |
| Procedure..... | 35 |
| Post-requisites..... | 36 |
| 24 Removing the optical drive..... | 37 |
| Procedure..... | 37 |
| Prerequisites..... | 38 |









| | |
|---|-----------|
| 25 Replacing the optical drive..... | 39 |
| Procedure..... | 39 |
| Post-requisites..... | 39 |
| 26 Removing the graphics card..... | 40 |
| Prerequisites..... | 40 |
| Procedure..... | 40 |
| 27 Replacing the graphics card..... | 41 |
| Procedure..... | 41 |
| Post-requisites..... | 41 |
| 28 Removing the processor fan and heat-sink assembly..... | 42 |
| Prerequisites..... | 42 |
| Procedure..... | 42 |
| 29 Replacing the processor fan and heat-sink assembly..... | 44 |
| Procedure..... | 44 |
| Post-requisites..... | 45 |
| 30 Removing the processor..... | 46 |
| Prerequisites..... | 46 |
| Procedure..... | 46 |
| 31 Replacing the processor..... | 47 |
| Procedure..... | 47 |
| Post-requisites..... | 47 |
| 32 Removing the antenna modules..... | 48 |
| Prerequisites..... | 48 |
| Procedure..... | 48 |
| 33 Replacing the antenna modules..... | 49 |
| Procedure..... | 49 |
| Post-requisites..... | 49 |
| 34 Removing the system board..... | 50 |
| Prerequisites..... | 50 |
| Procedure..... | 50 |
| 35 Replacing the system board..... | 54 |
| Procedure..... | 54 |
| Post-requisites..... | 56 |
| 36 System setup..... | 58 |
| BIOS overview..... | 58 |
| Entering BIOS setup program..... | 58 |

| | |
|---|-----------|
| Navigation keys..... | 58 |
| Boot Sequence..... | 58 |
| System setup options..... | 59 |
| Clearing Forgotten Passwords..... | 67 |
| Prerequisites..... | 67 |
| Procedure..... | 67 |
| Post-requisites..... | 67 |
| Clearing CMOS Settings..... | 67 |
| Prerequisites..... | 68 |
| Procedure..... | 68 |
| Post-requisites..... | 68 |
| 37 Troubleshooting..... | 69 |
| Enhanced Pre-Boot System Assessment (ePSA) diagnostics..... | 69 |
| Running the ePSA diagnostics..... | 69 |
| Diagnostics..... | 69 |
| Recovering the operating system..... | 70 |
| Flashing BIOS (USB key)..... | 70 |
| Flashing the BIOS..... | 70 |
| Enabling Intel Optane memory..... | 71 |
| Disabling Intel Optane memory..... | 71 |
| WiFi power cycle..... | 71 |
| Flea power release..... | 71 |
| 38 Getting help and contacting Dell..... | 73 |

Working inside your computer

Safety instructions



Use the following safety guidelines to protect your computer from potential damage and to ensure your personal safety. Unless otherwise noted, each procedure included in this document assumes that you have read the safety information that shipped with your computer.

-  **NOTE:** Before working inside your computer, read the safety information that shipped with your computer. For more safety best practices, see the Regulatory Compliance home page at www.dell.com/regulatory_compliance.
-  **NOTE:** Disconnect all power sources before opening the computer cover or panels. After you finish working inside the computer, replace all covers, panels, and screws before connecting to the electrical outlet.
-  **CAUTION:** To avoid damaging the computer, ensure that the work surface is flat and clean.
-  **CAUTION:** Handle components and cards with care. Do not touch the components or contacts on a card. Hold a card by its edges or by its metal mounting bracket. Hold a component such as a processor by its edges, not by its pins.
-  **CAUTION:** You should only perform troubleshooting and repairs as authorized or directed by the Dell technical assistance team. Damage due to servicing that is not authorized by Dell is not covered by your warranty. See the safety instructions that shipped with the product or at www.dell.com/regulatory_compliance.
-  **CAUTION:** Before touching anything inside your computer, ground yourself by using a wrist grounding strap or by periodically touching an unpainted metal surface, such as the metal at the back of the computer. While you work, periodically touch an unpainted metal surface to dissipate static electricity, which could harm internal components.
-  **CAUTION:** When you disconnect a cable, pull on its connector or on its pull tab, not on the cable itself. Some cables have connectors with locking tabs or thumb-screws that you must disengage before disconnecting the cable. When disconnecting cables, keep them evenly aligned to avoid bending any connector pins. When connecting cables, ensure that the ports and connectors are correctly oriented and aligned.
-  **CAUTION:** Press and eject any installed card from the media-card reader.
-  **NOTE:** The color of your computer and certain components may appear differently than shown in this document.

Before working inside your computer

-  **NOTE:** The images in this document may differ from your computer depending on the configuration you ordered.

Before you begin

1. Save and close all open files and exit all open applications.
2. Shut down your computer. Click **Start** >  **Power** > **Shut down**.
 -  **NOTE:** If you are using a different operating system, see the documentation of your operating system for shut-down instructions.
3. Disconnect your computer and all attached devices from their electrical outlets.
4. Disconnect all attached network devices and peripherals, such as keyboard, mouse, and monitor from your computer.
5. Remove any media card and optical disc from your computer, if applicable.
6. After the computer is unplugged, press and hold the power button for 5 seconds to ground the system board.

Electrostatic discharge—ESD protection

ESD is a major concern when you handle electronic components, especially sensitive components such as expansion cards, processors, memory DIMMs, and system boards. Very slight charges can damage circuits in ways that may not be obvious, such as intermittent problems or a shortened product life span. As the industry pushes for lower power requirements and increased density, ESD protection is an increasing concern.

Due to the increased density of semiconductors used in recent Dell products, the sensitivity to static damage is now higher than in previous Dell products. For this reason, some previously approved methods of handling parts are no longer applicable.

Two recognized types of ESD damage are catastrophic and intermittent failures.

- **Catastrophic** – Catastrophic failures represent approximately 20 percent of ESD-related failures. The damage causes an immediate and complete loss of device functionality. An example of catastrophic failure is a memory DIMM that has received a static shock and immediately generates a "No POST/No Video" symptom with a beep code emitted for missing or nonfunctional memory.
- **Intermittent** – Intermittent failures represent approximately 80 percent of ESD-related failures. The high rate of intermittent failures means that most of the time when damage occurs, it is not immediately recognizable. The DIMM receives a static shock, but the tracing is merely weakened and does not immediately produce outward symptoms related to the damage. The weakened trace may take weeks or months to melt, and in the meantime may cause degradation of memory integrity, intermittent memory errors, etc.

The more difficult type of damage to recognize and troubleshoot is the intermittent (also called latent or "walking wounded") failure.

Perform the following steps to prevent ESD damage:

- Use a wired ESD wrist strap that is properly grounded. The use of wireless anti-static straps is no longer allowed; they do not provide adequate protection. Touching the chassis before handling parts does not ensure adequate ESD protection on parts with increased sensitivity to ESD damage.
- Handle all static-sensitive components in a static-safe area. If possible, use anti-static floor pads and workbench pads.
- When unpacking a static-sensitive component from its shipping carton, do not remove the component from the anti-static packing material until you are ready to install the component. Before unwrapping the anti-static packaging, ensure that you discharge static electricity from your body.
- Before transporting a static-sensitive component, place it in an anti-static container or packaging.

ESD field service kit

The unmonitored Field Service kit is the most commonly used service kit. Each Field Service kit includes three main components: anti-static mat, wrist strap, and bonding wire.

Components of an ESD field service kit

The components of an ESD field service kit are:

- **Anti-Static Mat** – The anti-static mat is dissipative and parts can be placed on it during service procedures. When using an anti-static mat, your wrist strap should be snug and the bonding wire should be connected to the mat and to any bare metal on the system being worked on. Once deployed properly, service parts can be removed from the ESD bag and placed directly on the mat. ESD-sensitive items are safe in your hand, on the ESD mat, in the system, or inside a bag.
- **Wrist Strap and Bonding Wire** – The wrist strap and bonding wire can be either directly connected between your wrist and bare metal on the hardware if the ESD mat is not required, or connected to the anti-static mat to protect hardware that is temporarily placed on the mat. The physical connection of the wrist strap and bonding wire between your skin, the ESD mat, and the hardware is known as bonding. Use only Field Service kits with a wrist strap, mat, and bonding wire. Never use wireless wrist straps. Always be aware that the internal wires of a wrist strap are prone to damage from normal wear and tear, and must be checked regularly with a wrist strap tester in order to avoid accidental ESD hardware damage. It is recommended to test the wrist strap and bonding wire at least once per week.
- **ESD Wrist Strap Tester** – The wires inside of an ESD strap are prone to damage over time. When using an unmonitored kit, it is a best practice to regularly test the strap prior to each service call, and at a minimum, test once per week. A wrist strap tester is the best method for doing this test. If you do not have your own wrist strap tester, check with your regional office to find out if they have one. To perform the test, plug the wrist-strap's bonding-wire into the tester while it is strapped to your wrist and push the button to test. A green LED is lit if the test is successful; a red LED is lit and an alarm sounds if the test fails.
- **Insulator Elements** – It is critical to keep ESD sensitive devices, such as plastic heat sink casings, away from internal parts that are insulators and often highly charged.
- **Working Environment** – Before deploying the ESD Field Service kit, assess the situation at the customer location. For example, deploying the kit for a server environment is different than for a desktop or portable environment. Servers are typically installed in a rack within a data center; desktops or portables are typically placed on office desks or cubicles. Always look for a large open flat work area that is free of clutter and large enough to deploy the ESD kit with additional space to accommodate the type of system that is

being repaired. The workspace should also be free of insulators that can cause an ESD event. On the work area, insulators such as Styrofoam and other plastics should always be moved at least 12 inches or 30 centimeters away from sensitive parts before physically handling any hardware components

- **ESD Packaging** – All ESD-sensitive devices must be shipped and received in static-safe packaging. Metal, static-shielded bags are preferred. However, you should always return the damaged part using the same ESD bag and packaging that the new part arrived in. The ESD bag should be folded over and taped shut and all the same foam packing material should be used in the original box that the new part arrived in. ESD-sensitive devices should be removed from packaging only at an ESD-protected work surface, and parts should never be placed on top of the ESD bag because only the inside of the bag is shielded. Always place parts in your hand, on the ESD mat, in the system, or inside an anti-static bag.
- **Transporting Sensitive Components** – When transporting ESD sensitive components such as replacement parts or parts to be returned to Dell, it is critical to place these parts in anti-static bags for safe transport.

ESD protection summary

It is recommended that all field service technicians use the traditional wired ESD grounding wrist strap and protective anti-static mat at all times when servicing Dell products. In addition, it is critical that technicians keep sensitive parts separate from all insulator parts while performing service and that they use anti-static bags for transporting sensitive components.

Transporting sensitive components

When transporting ESD sensitive components such as replacement parts or parts to be returned to Dell, it is critical to place these parts in anti-static bags for safe transport.

Lifting equipment

Adhere to the following guidelines when lifting heavy weight equipment:

 **CAUTION: Do not lift greater than 50 pounds. Always obtain additional resources or use a mechanical lifting device.**

1. Get a firm balanced footing. Keep your feet apart for a stable base, and point your toes out.
2. Tighten stomach muscles. Abdominal muscles support your spine when you lift, offsetting the force of the load.
3. Lift with your legs, not your back.
4. Keep the load close. The closer it is to your spine, the less force it exerts on your back.
5. Keep your back upright, whether lifting or setting down the load. Do not add the weight of your body to the load. Avoid twisting your body and back.
6. Follow the same techniques in reverse to set the load down.

After working inside your computer

 **CAUTION: Leaving stray or loose screws inside your computer may severely damage your computer.**

1. Replace all screws and ensure that no stray screws remain inside your computer.
2. Connect any external devices, peripherals, or cables you removed before working on your computer.
3. Replace any media cards, discs, or any other parts that you removed before working on your computer.
4. Connect your computer and all attached devices to their electrical outlets.
5. Turn on your computer.

Recommended tools

The procedures in this document may require the following tools:

- Phillips screwdriver #1
- Flat-head screwdriver
- Plastic scribe











Screw list

NOTE: When removing screws from a component, it is recommended to note the screw type, the quantity of screws, and then place them in a screw storage box. This is to ensure that the correct number of screws and correct screw type is restored when the component is replaced.

NOTE: Some computers have magnetic surfaces. Ensure that the screws are not left attached to such surface when replacing a component.

NOTE: Screw color may vary with the configuration ordered.

Table 1. Screw list

| Component | Secured to | Screw type | Quantity | Screw image |
|---|--------------|------------|----------|---|
| Computer cover | Chassis | #6-32x6.35 | 2 |  |
| Solid-state drive/Intel Optane memory | System board | M2x3.5 | 1 |  |
| Card-retention bracket | Chassis | #6-32x6.35 | 1 |  |
| Wireless card | System board | M2x3.5 | 1 |  |
| Power-supply unit | Chassis | #6-32x6.35 | 4 |  |
| 3.5-inch hard drive | Chassis | #6-32x3.6 | 4 |  |
| 2.5-inch hard drive(s) | Chassis | M3x3.5 | 2-4 |  |
| NOTE: Depending on the configuration ordered, there may be up to two 2.5-inch hard drives installed. | | | | |
| Optical drive | Chassis | M2x2 | 2 |  |
| Front-I/O bracket | Chassis | #6-32x6.35 | 1 |  |
| System board | Chassis | #6-32x6.35 | 8 |  |

| Component | Secured to | Screw type | Quantity | Screw image |
|------------------|-------------------|---------------------|-----------------|---|
| System board | Chassis | #6-32x4.8, standoff | 1 |  |

Inside view of your computer

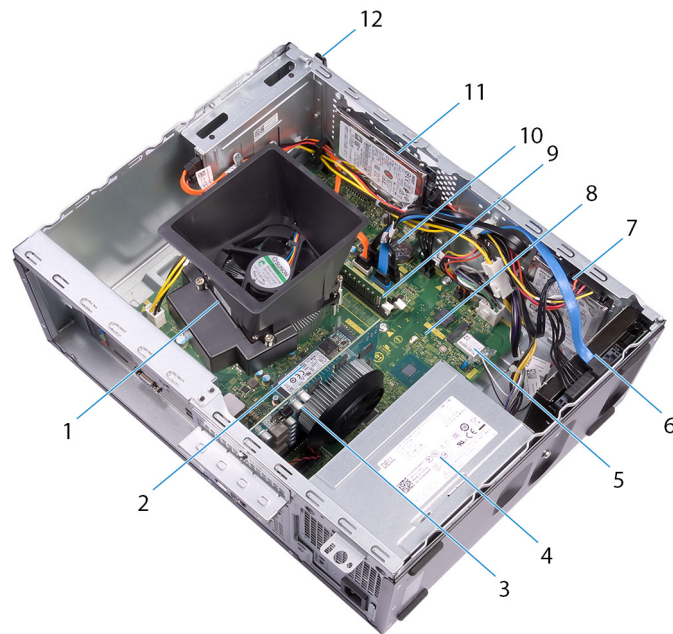
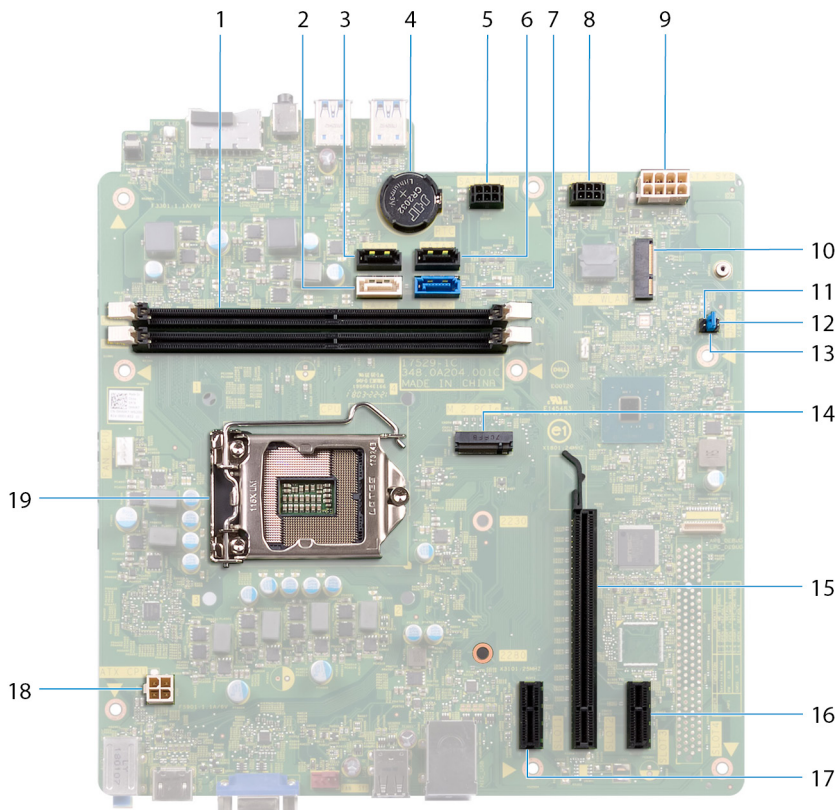

Figure 1. Inside view of your computer

1. processor fan and heat-sink assembly
2. solid-state drive/Intel Optane memory
3. graphics card
4. power-supply unit
5. wireless card
6. 3.5-inch hard drive
7. 2.5-inch hard drive
8. system board
9. memory module(s)
10. coin-cell battery
11. 2.5-inch hard drive
12. optical-disk drive

System-board components



- | | |
|--|--|
| 1. memory-module slots (2) | 2. SATA 2 cable connector (SATA 2) |
| 3. SATA 1 cable connector (SATA 1) | 4. coin-cell battery |
| 5. hard-drive power cable connector (SATA PWR) | 6. SATA 3 cable connector (SATA 3) |
| 7. SATA 0 cable connector (SATA 0) | 8. hard-drive power cable connector (SATA PWR) |
| 9. power-supply unit cable connector (ATX PWR) | 10. wireless-card slot |
| 11. service mode jumper | 12. CMOS clear jumper |
| 13. password clear jumper | 14. M.2 PCIe connector |
| 15. PCI-Express x16 slot | 16. PCI-Express X1 slot |
| 17. PCI-Express X1 slot | 18. processor-power cable connector (ATX CPU) |
| 19. processor socket | |

Removing the computer cover

NOTE: Before working inside your computer, read the safety information that shipped with your computer and follow the steps in [Before working inside your computer](#). After working inside your computer, follow the instructions in [After working inside your computer](#). For more safety best practices, see the Regulatory Compliance home page at www.dell.com/regulatory_compliance.

Procedure

1. Place the computer on its side.
2. Remove the two screws (#6-32x6.35) that secure the computer cover to the chassis.
3. Slide the computer cover towards the back of the computer and lift the computer cover off the chassis.



Replacing the computer cover

NOTE: Before working inside your computer, read the safety information that shipped with your computer and follow the steps in [Before working inside your computer](#). After working inside your computer, follow the instructions in [After working inside your computer](#). For more safety best practices, see the Regulatory Compliance home page at www.dell.com/regulatory_compliance.

Procedure

1. Align the tabs on the computer cover with the slots on the chassis and slide it towards the front of the computer until it snaps into position.
2. Replace the two screws (#6-32x6.35) that secure the computer cover to the chassis.



3. Place the computer in an upright position.

Removing the front bezel

NOTE: Before working inside your computer, read the safety information that shipped with your computer and follow the steps in [Before working inside your computer](#). After working inside your computer, follow the instructions in [After working inside your computer](#). For more safety best practices, see the Regulatory Compliance home page at www.dell.com/regulatory_compliance.

Procedure

1. Place the computer in an upright position.
2. Pry and release the tabs on the front bezel away from the chassis.



3. Rotate and pull the front bezel away from the computer to release the tabs on the front bezel from the slots on the chassis.

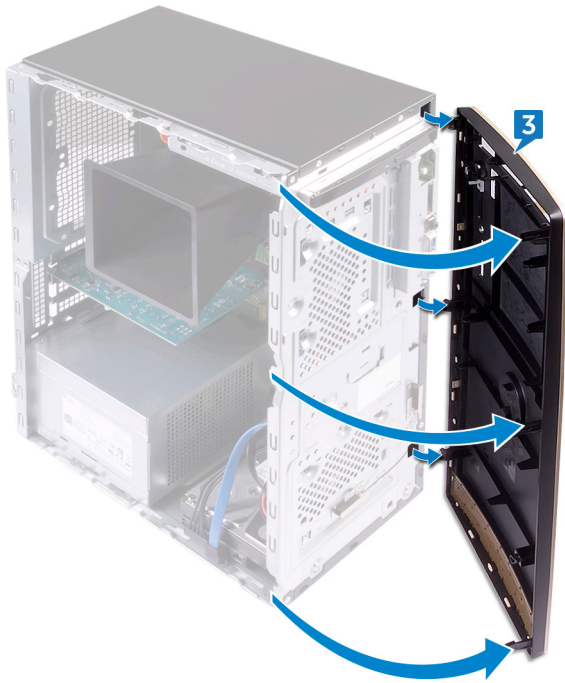

Prerequisites

Remove the [computer cover](#).

Replacing the front bezel

NOTE: Before working inside your computer, read the safety information that shipped with your computer and follow the steps in [Before working inside your computer](#). After working inside your computer, follow the instructions in [After working inside your computer](#). For more safety best practices, see the Regulatory Compliance home page at www.dell.com/regulatory_compliance.

Procedure

1. Align the tabs on the front bezel with the slots on the chassis, and then rotate the front bezel towards the chassis until it snaps into place.

NOTE: Ensure that the front-bezel slot is aligned correctly with the optical drive.

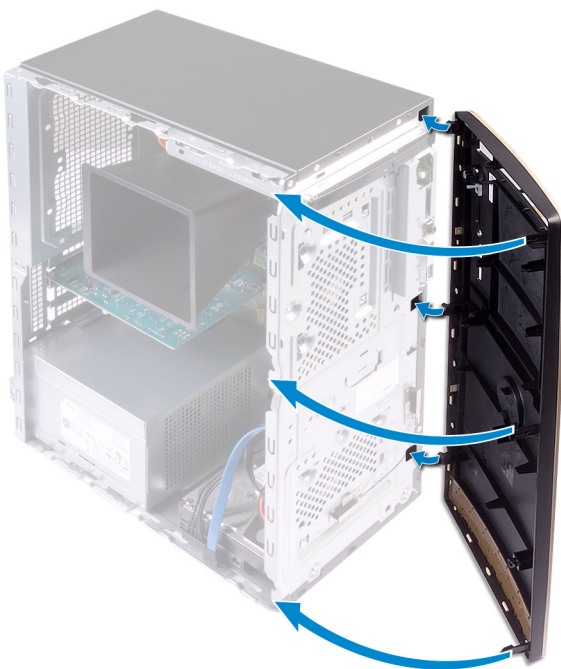

2. Place the computer on its side.

Post-requisites

Replace the [computer cover](#).

Removing the memory module

NOTE: Before working inside your computer, read the safety information that shipped with your computer and follow the steps in [Before working inside your computer](#). After working inside your computer, follow the instructions in [After working inside your computer](#). For more safety best practices, see the Regulatory Compliance home page at www.dell.com/regulatory_compliance.

Prerequisites

Remove the [computer cover](#).

Procedure

NOTE: Depending on the configuration ordered, your computer may have up to two memory modules installed on the system board.

1. Using the fingertips, spread apart the securing clip at each end of the memory-module slot until the memory module pops up.
2. Lift the memory module out of the memory-module slot.

NOTE: If the memory module is difficult to remove, gently ease the memory module back and forth alongside the memory-module slot to remove it.

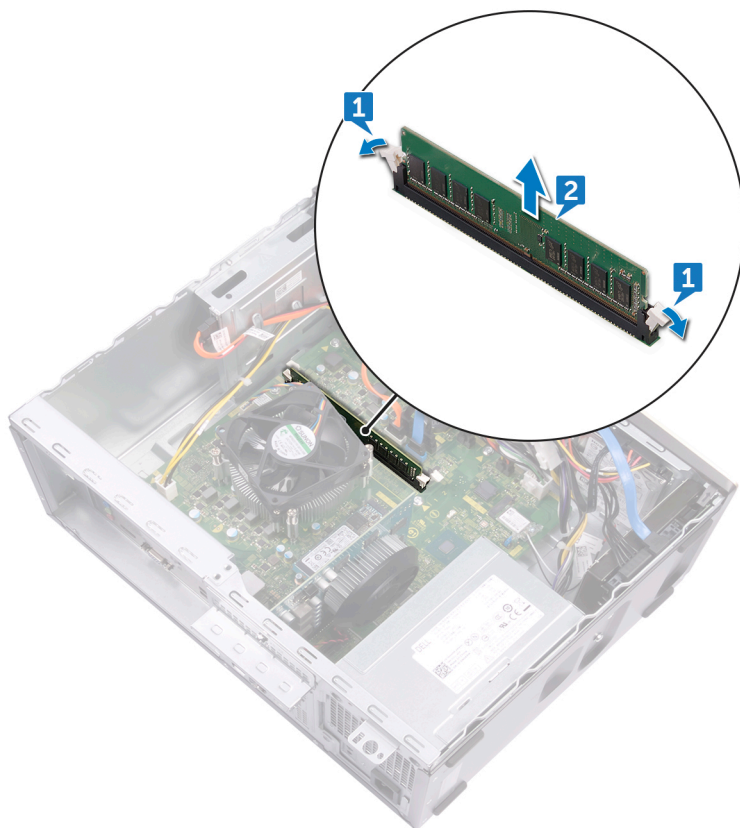

Replacing the memory module

NOTE: Before working inside your computer, read the safety information that shipped with your computer and follow the steps in [Before working inside your computer](#). After working inside your computer, follow the instructions in [After working inside your computer](#). For more safety best practices, see the Regulatory Compliance home page at www.dell.com/regulatory_compliance.

Procedure

1. Align the notch on the memory module with the tab on the memory-module slot.
NOTE: Ensure that the securing clips are extended away from the memory-module slot.
2. Insert the memory module into the memory-module slot, and then press the memory module down until the securing clips lock in place.

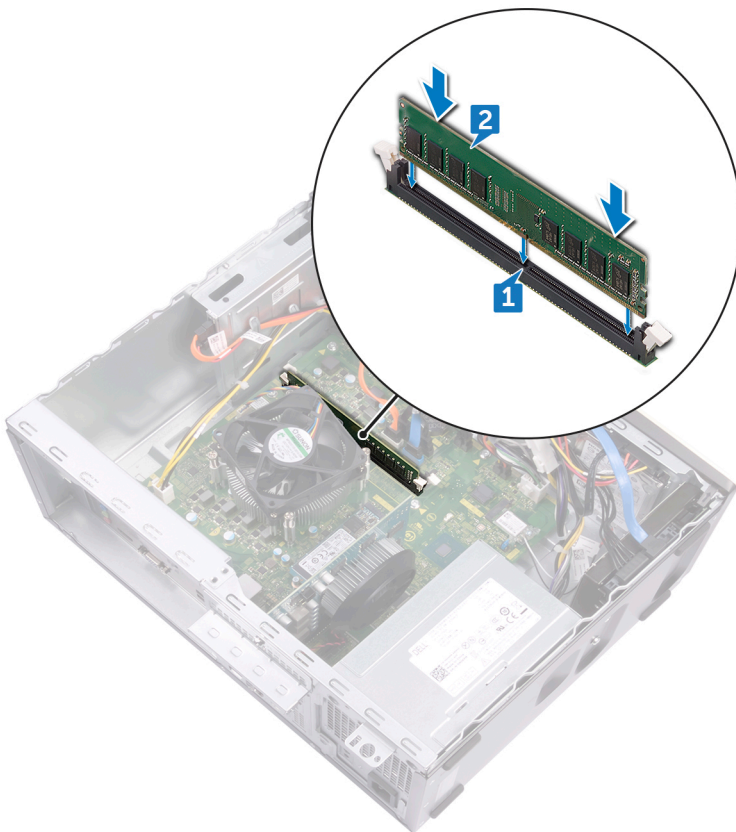

Post-requisites

Replace the [computer cover](#).

Removing the solid-state drive/Intel Optane

You need to disable the Intel Optane device before removing it from your computer. For more information about disabling the Intel Optane device, see [Disabling Intel Optane memory](#).

NOTE: Before working inside your computer, read the safety information that shipped with your computer and follow the steps in [Before working inside your computer](#). After working inside your computer, follow the instructions in [After working inside your computer](#). For more safety best practices, see the Regulatory Compliance home page at www.dell.com/regulatory_compliance.

Prerequisites

Remove the [computer cover](#).

Procedure

1. Locate the solid-state drive or Intel Optane memory on the system board.



2. Remove the screw (M2x3.5) that secures the solid-state drive or Intel Optane memory to the system board.
3. Slide and remove the solid-state drive or Intel Optane memory from the M.2 card slot on the system board.

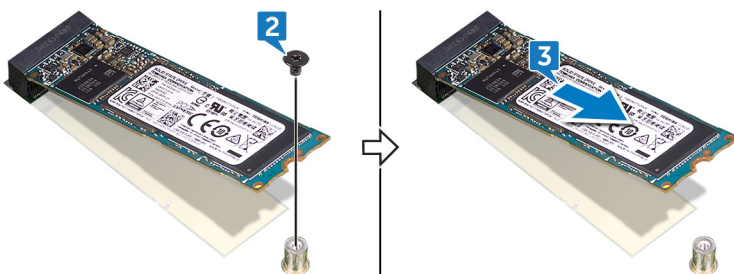

Replacing the solid-state drive/Intel Optane

Enable the Intel Optane device after you replace it. For more information about enabling the Intel Optane device, see [Enabling Intel Optane memory](#).

NOTE: Before working inside your computer, read the safety information that shipped with your computer and follow the steps in [Before working inside your computer](#). After working inside your computer, follow the instructions in [After working inside your computer](#). For more safety best practices, see the Regulatory Compliance home page at www.dell.com/regulatory_compliance.

CAUTION: Solid-state drives are fragile. Exercise care when handling the solid-state drive.

Procedure

1. Align the notch on the solid-state drive or Intel Optane memory with the tab on the M.2 card slot.
2. Slide the solid-state drive or Intel Optane memory into the M.2 card slot on the system board.
3. Replace the screw (M2x3.5) that secures the solid-state drive or Intel Optane memory to the system board.

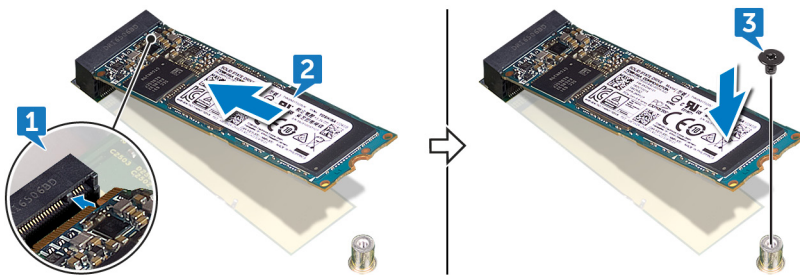

Post-requisites

Replace the [computer cover](#).

Removing the coin-cell battery

NOTE: Before working inside your computer, read the safety information that shipped with your computer and follow the steps in [Before working inside your computer](#). After working inside your computer, follow the instructions in [After working inside your computer](#). For more safety best practices, see the Regulatory Compliance home page at www.dell.com/regulatory_compliance.

CAUTION: Removing the coin-cell battery resets the BIOS setup program's settings to default. It is recommended that you note the BIOS setup program's settings before removing the coin-cell battery.

Procedure

1. Press on the edge of the coin-cell battery to release it from the battery socket on the system board.
2. Lift the coin-cell battery out of the battery socket on the system board.

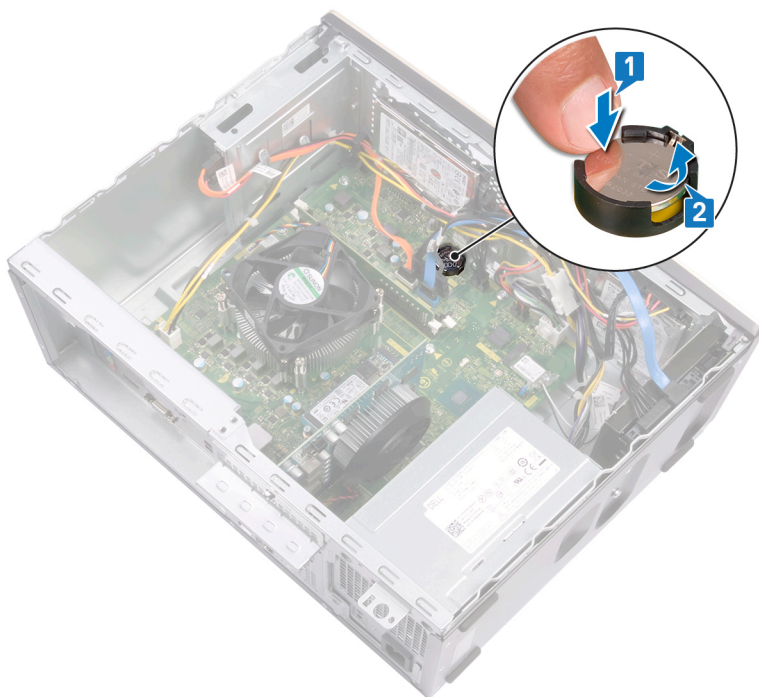

Prerequisites

Remove the [computer cover](#).

Replacing the coin-cell battery

NOTE: Before working inside your computer, read the safety information that shipped with your computer and follow the steps in [Before working inside your computer](#). After working inside your computer, follow the instructions in [After working inside your computer](#). For more safety best practices, see the Regulatory Compliance home page at www.dell.com/regulatory_compliance.

Procedure

Insert the coin-cell battery into the battery socket with the positive side facing up, and snap the battery into place.

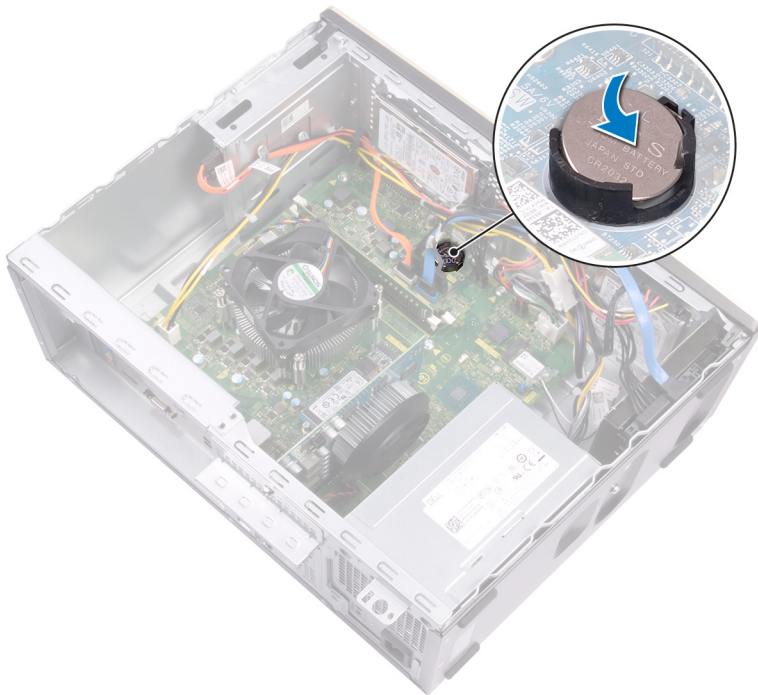

Post-requisites

Replace the [computer cover](#).

Removing the wireless card

NOTE: Before working inside your computer, read the safety information that shipped with your computer and follow the steps in [Before working inside your computer](#). After working inside your computer, follow the instructions in [After working inside your computer](#). For more safety best practices, see the Regulatory Compliance home page at www.dell.com/regulatory_compliance.

Procedure

1. Locate the wireless card on the system board.



2. Remove the screw (M2x3.5) that secures the wireless card to the system board.
3. Lift the wireless-card bracket off the wireless card.
4. Disconnect the antenna cables from the wireless card.
5. Slide and remove the wireless card from the wireless-card slot on the system board.

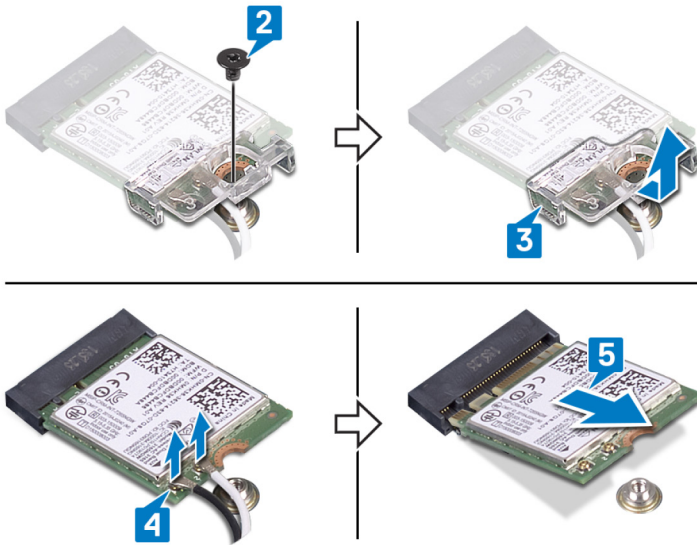

Prerequisites

Remove the [computer cover](#).

Replacing the wireless card

NOTE: Before working inside your computer, read the safety information that shipped with your computer and follow the steps in [Before working inside your computer](#). After working inside your computer, follow the instructions in [After working inside your computer](#). For more safety best practices, see the Regulatory Compliance home page at www.dell.com/regulatory_compliance.

Procedure

1. Connect the antenna cables to the wireless card.
2. Slide the wireless-card bracket on the wireless card, and align the screw hole on the bracket with the screw hole on the wireless card.
The following table provides the antenna-cable color scheme for the wireless card supported by your computer.

Table 2. Antenna-cable color scheme

| Connectors on the wireless card | Antenna-cable color |
|---------------------------------|---------------------|
| Main (white triangle) | White |
| Auxiliary (black triangle) | Black |

3. Align the notch on the wireless card with the tab on the wireless-card slot, then slide the wireless card at an angle into the wireless-card slot.
4. Replace the screw (M2x3.5) that secures the wireless card to the system board.

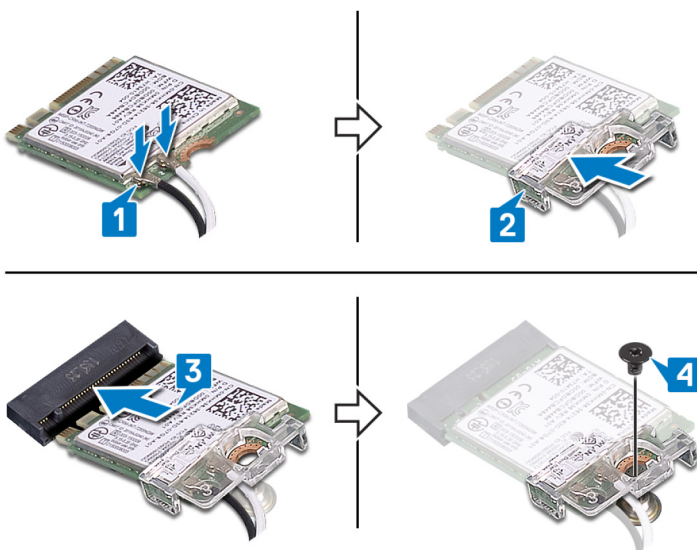

Post-requisites

Replace the [computer cover](#).

Removing the power-supply unit

NOTE: Before working inside your computer, read the safety information that shipped with your computer and follow the steps in [Before working inside your computer](#). After working inside your computer, follow the instructions in [After working inside your computer](#). For more safety best practices, see the Regulatory Compliance home page at www.dell.com/regulatory_compliance.

Prerequisites

Remove the [computer cover](#).

Procedure

1. Press the securing clip and disconnect the power-supply unit cable (P1) from the system board (ATX SYS).
2. Press the securing clip and disconnect the power-supply unit cable (P2) from the processor-power cable (ATX CPU).
3. Remove the power-supply unit cable (P1) from the routing guide on the chassis.
4. Remove the four screws (#6-32x6.35) that secure the power-supply unit to the chassis.
5. Lift the power-supply unit along with the cables off the chassis.

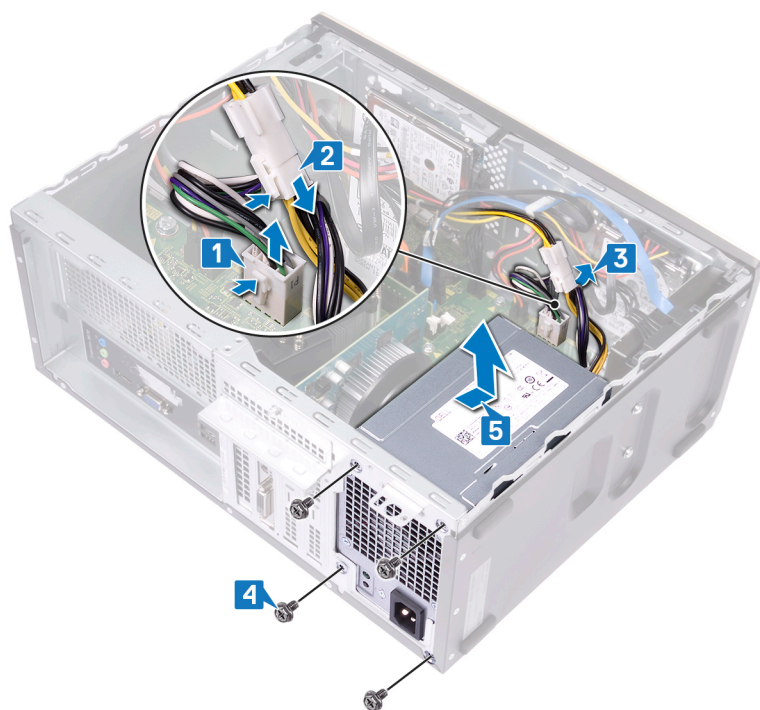

Replacing the power-supply unit

NOTE: Before working inside your computer, read the safety information that shipped with your computer and follow the steps in [Before working inside your computer](#). After working inside your computer, follow the instructions in [After working inside your computer](#). For more safety best practices, see the Regulatory Compliance home page at www.dell.com/regulatory_compliance.

Procedure

1. Place the power-supply unit on the chassis, aligning the screw holes on the power-supply unit to the screw holes on the chassis.
2. Replace the four screws (#6-32x6.35) that secure the power-supply unit to the chassis.
3. Route the power-supply unit cable (ATX SYS) through the routing guide on the chassis.
4. Connect the power-supply unit cable (P1) to the system board (ATX SYS).
5. Connect the power-supply unit cable (P2) to the processor-power cable (ATX CPU).

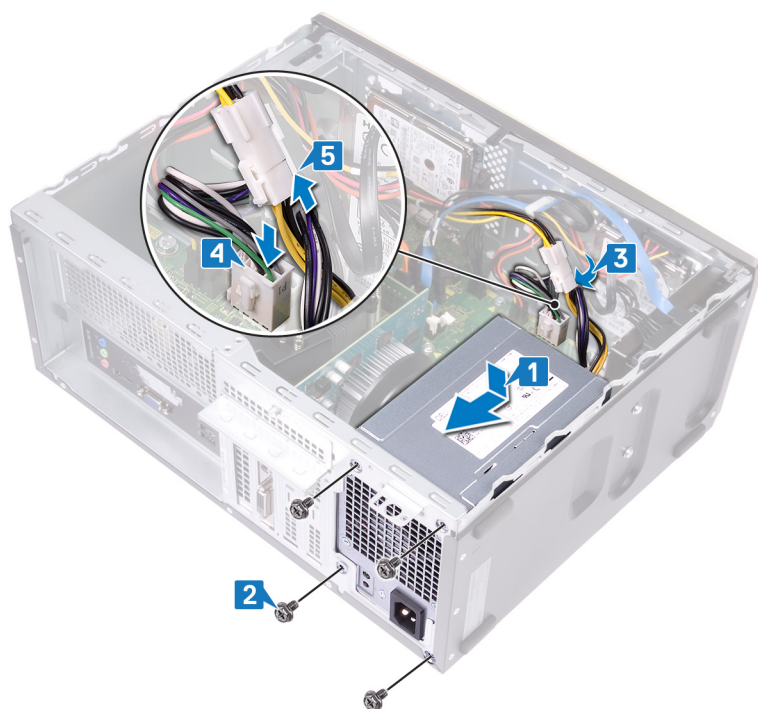

Post-requisites

Replace the [computer cover](#).

Removing the 3.5-inch hard drive

NOTE: Before working inside your computer, read the safety information that shipped with your computer and follow the steps in [Before working inside your computer](#). After working inside your computer, follow the instructions in [After working inside your computer](#). For more safety best practices, see the Regulatory Compliance home page at www.dell.com/regulatory_compliance.

Prerequisites

1. Remove the [computer cover](#).
2. Remove the [front bezel](#).

Procedure

1. Disconnect the hard-drive data cable and power cable from the hard drive.
2. Remove the four screws (#6-32x3.6) that secure the hard drive to the chassis.
3. Lift the hard drive off the chassis.

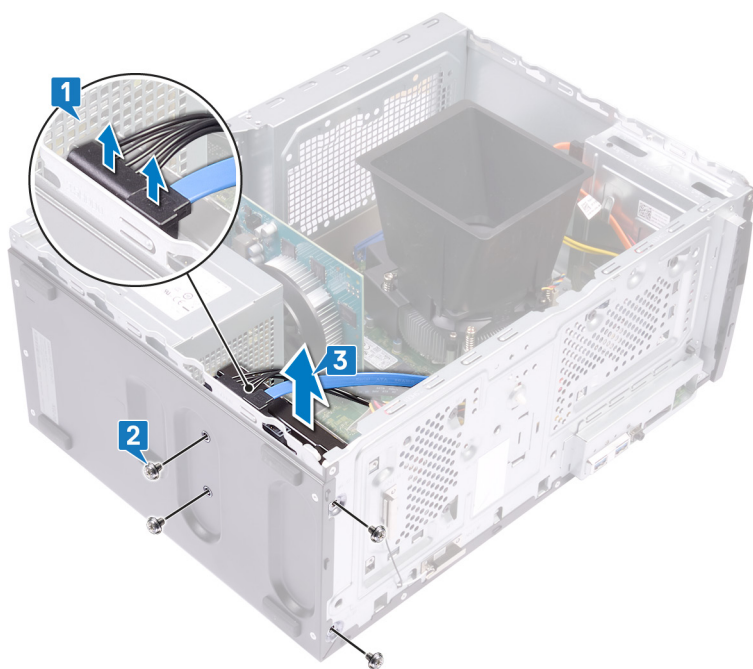

Replacing the 3.5-inch hard drive

NOTE: Before working inside your computer, read the safety information that shipped with your computer and follow the steps in [Before working inside your computer](#). After working inside your computer, follow the instructions in [After working inside your computer](#). For more safety best practices, see the Regulatory Compliance home page at www.dell.com/regulatory_compliance.

Procedure

1. Place the hard drive on the chassis and align the screw holes on the hard drive with the screw holes on the chassis.
2. Replace the four screws (#6-32x3.6) that secure the hard drive to the chassis.
3. Connect the hard-drive data cable and power cable to the hard drive.

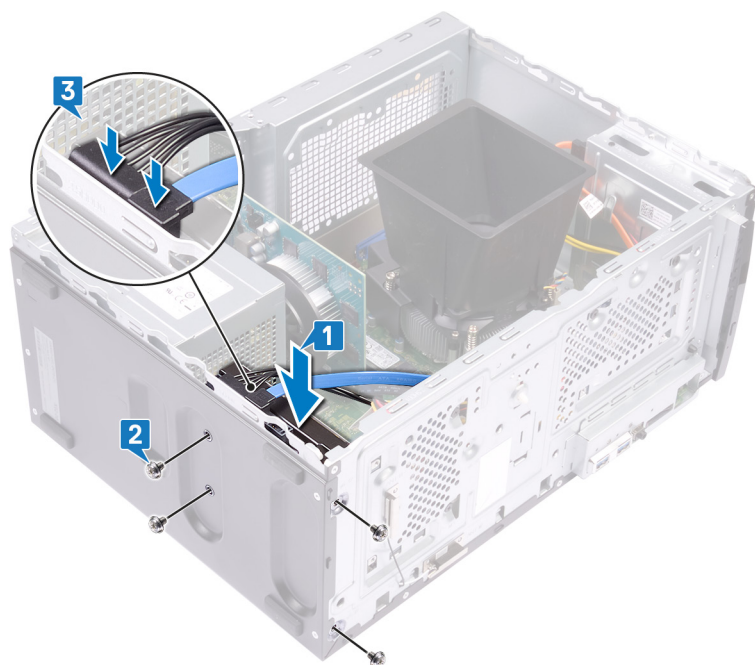

Post-requisites

1. Replace the [front bezel](#).
2. Replace the [computer cover](#).

Removing the 2.5-inch hard drive

-  **NOTE:** Before working inside your computer, read the safety information that shipped with your computer and follow the steps in [Before working inside your computer](#). After working inside your computer, follow the instructions in [After working inside your computer](#). For more safety best practices, see the Regulatory Compliance home page at www.dell.com/regulatory_compliance.

Prerequisites

1. Remove the [computer cover](#).
2. Remove the [front bezel](#).

Procedure

-  **NOTE:** Depending on the configuration ordered there may be up to two 2.5-inch hard drives installed in your computer. The following procedure enables you to remove the 2.5-inch hard drive(s) in either or both locations.

1. Disconnect the hard-drive data cable and power cable from the hard drive.
2. Remove the two screws (M3x3.5) that secure the hard drive to the chassis.



CAUTION: To prevent damage to the other components inside the computer, hold the hard drive in place before removing the screws that secure it to the chassis.

3. Lift the hard drive off the chassis.

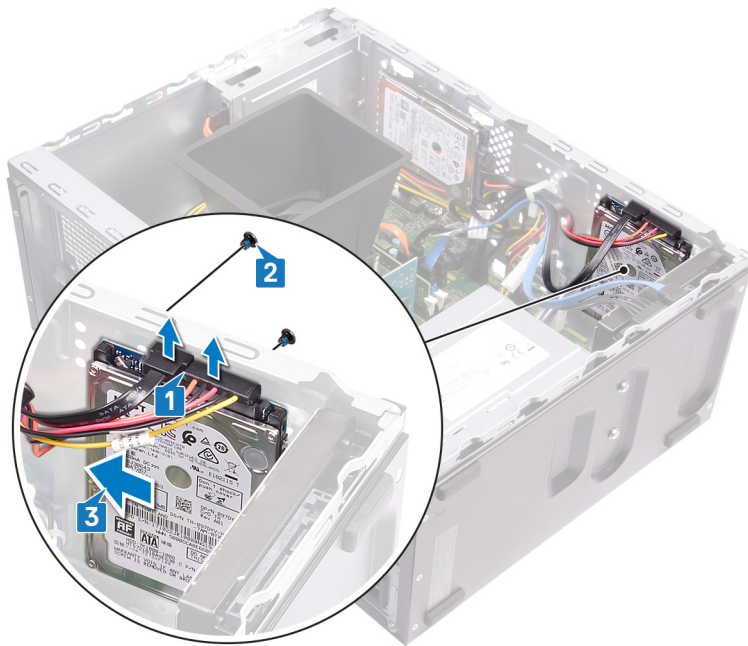
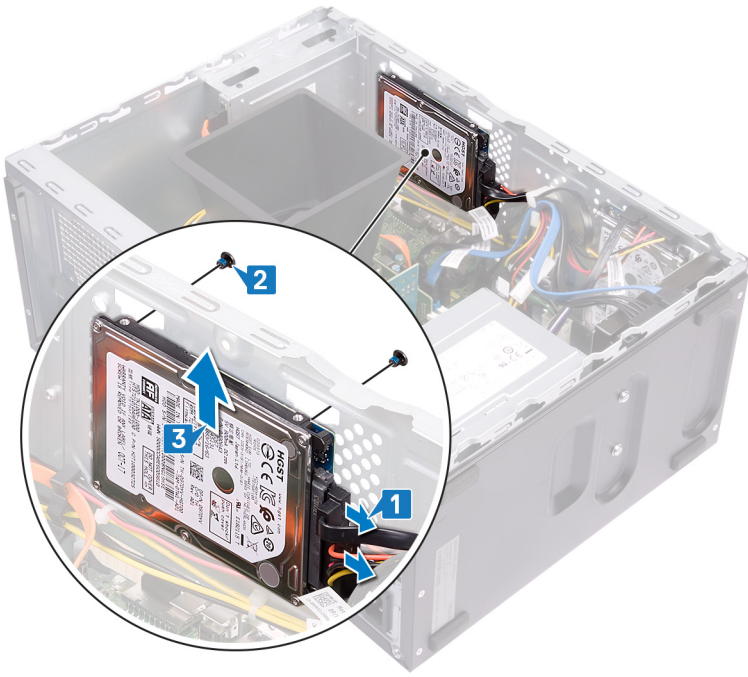

Replacing the 2.5-inch hard drive

NOTE: Before working inside your computer, read the safety information that shipped with your computer and follow the steps in [Before working inside your computer](#). After working inside your computer, follow the instructions in [After working inside your computer](#). For more safety best practices, see the Regulatory Compliance home page at www.dell.com/regulatory_compliance.

Procedure

NOTE: Depending on the configuration ordered there may be up to two 2.5-inch hard drives installed in your computer. The following procedure lists the steps to remove the 2.5-inch hard drive(s) in either or both locations.

1. Align and place the slots on the hard drive with the posts on the chassis, then hold the hard drive in place.

NOTE: Ensure that the hard drive is seated correctly with the posts on the chassis before replacing the screws.

2. Replace the two screws (M3x3.5) that secure the hard drive to the chassis.

3. Connect the hard-drive data cable and power cable to the hard drive.

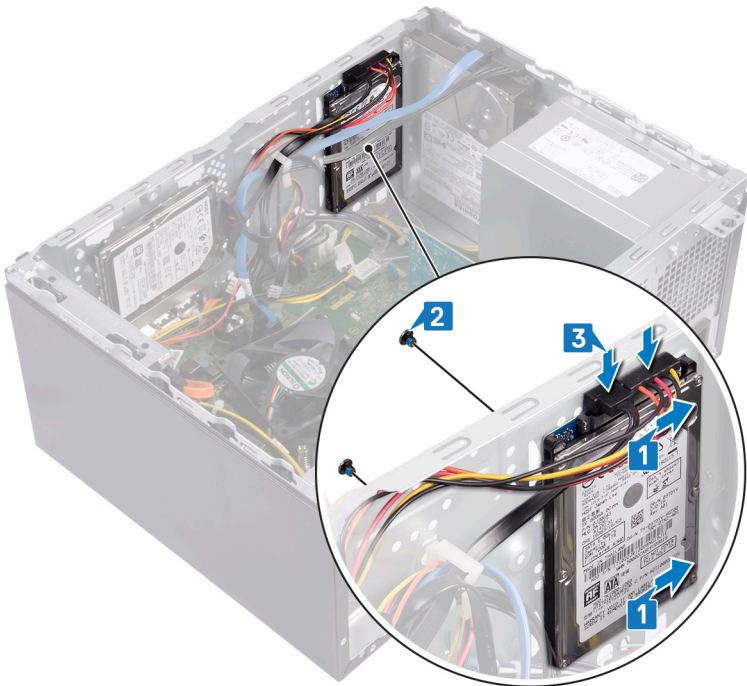
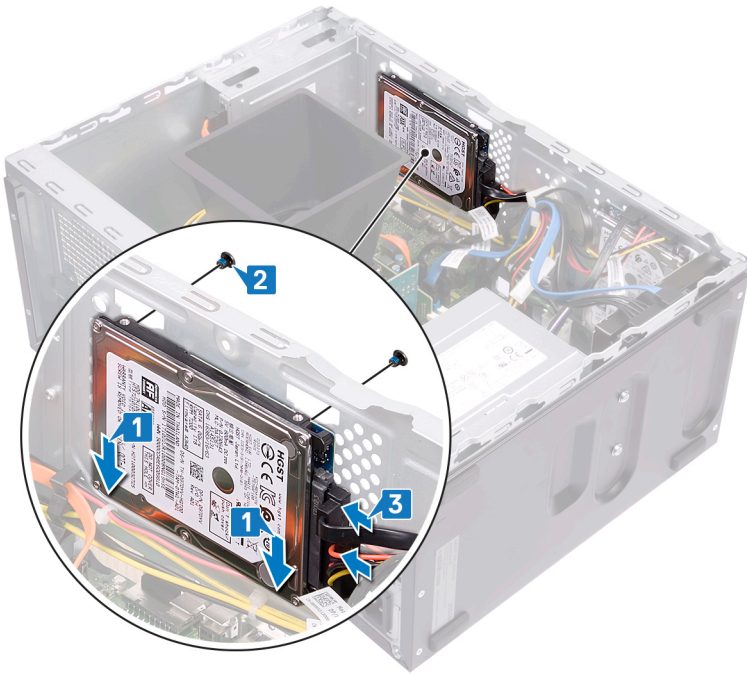

Post-requisites

1. Replace the [front bezel](#).
2. Replace the [computer cover](#).

Removing the optical drive

NOTE: Before working inside your computer, read the safety information that shipped with your computer and follow the steps in [Before working inside your computer](#). After working inside your computer, follow the instructions in [After working inside your computer](#). For more safety best practices, see the Regulatory Compliance home page at www.dell.com/regulatory_compliance.

Procedure

1. Disconnect the optical-drive data cable and power cable from the optical-drive assembly.
2. Remove the two screws (M2x2) that secure the optical-drive assembly to the chassis.
3. Slide and remove the optical-drive assembly from its slot on the chassis.

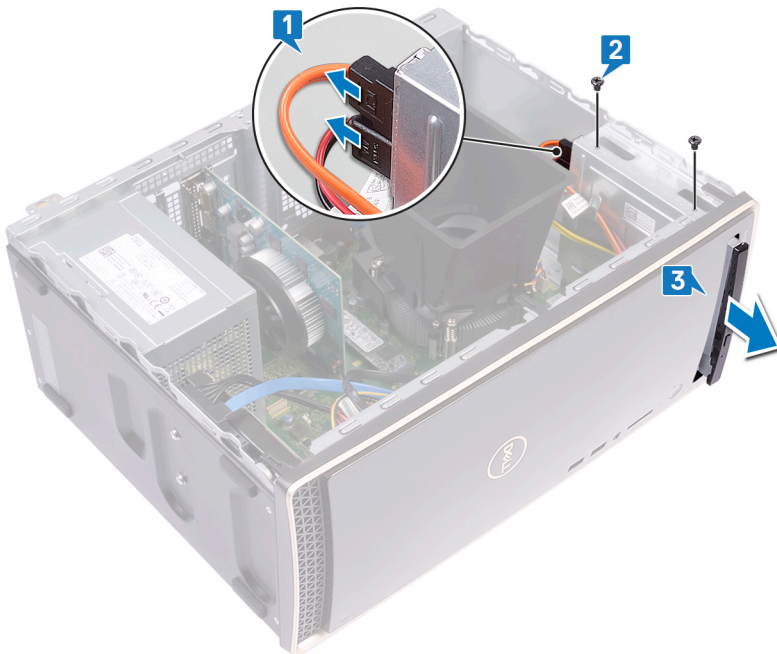

4. Insert a pin into the optical-drive emergency eject pinhole to release the optical-drive tray.
5. Gently pull to open the optical-drive tray from the optical-drive assembly.

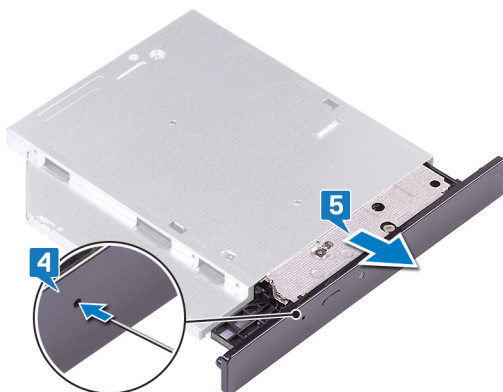

6. Using a plastic scribe, push the tabs to release the optical-drive bezel from the optical drive.
7. Gently pull and disconnect the optical-drive bezel from the optical drive.

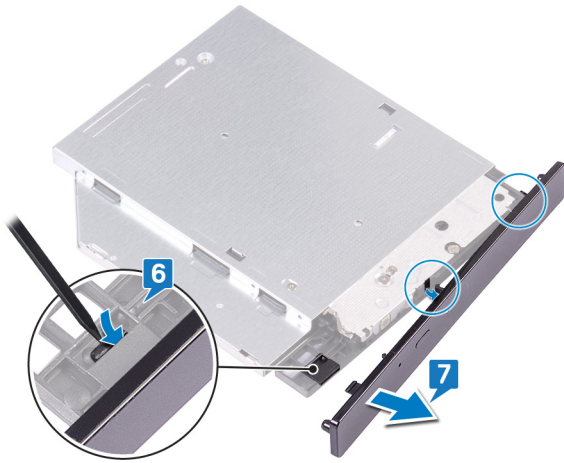

Prerequisites

Remove the [computer cover](#).

Replacing the optical drive

NOTE: Before working inside your computer, read the safety information that shipped with your computer and follow the steps in [Before working inside your computer](#). After working inside your computer, follow the instructions in [After working inside your computer](#). For more safety best practices, see the Regulatory Compliance home page at www.dell.com/regulatory_compliance.

Procedure

1. Align and replace the optical-drive bezel to the optical-drive tray.



2. Slide the optical-drive assembly into its slot on the chassis and align the screw holes on the optical-drive assembly to the screw holes on the chassis.
3. Replace the screws (M2x2) that secures the optical-drive assembly to the chassis.
4. Connect the optical-drive data cable and power cable to the optical-drive assembly.



Post-requisites

Replace the [computer cover](#).

Removing the graphics card

NOTE: Before working inside your computer, read the safety information that shipped with your computer and follow the steps in [Before working inside your computer](#). After working inside your computer, follow the instructions in [After working inside your computer](#). For more safety best practices, see the Regulatory Compliance home page at www.dell.com/regulatory_compliance.

Prerequisites

Remove the [computer cover](#).

Procedure

1. Remove the screw (#6-32x6.35) that secures the card-retention bracket to the chassis.
2. Rotate the card-retention bracket away from the chassis to access the expansion cards.
3. Push and hold the securing tab on the graphics-card slot.
4. Hold firmly on the edge of the graphics card and lift it out of the slot on the graphics-card slot.

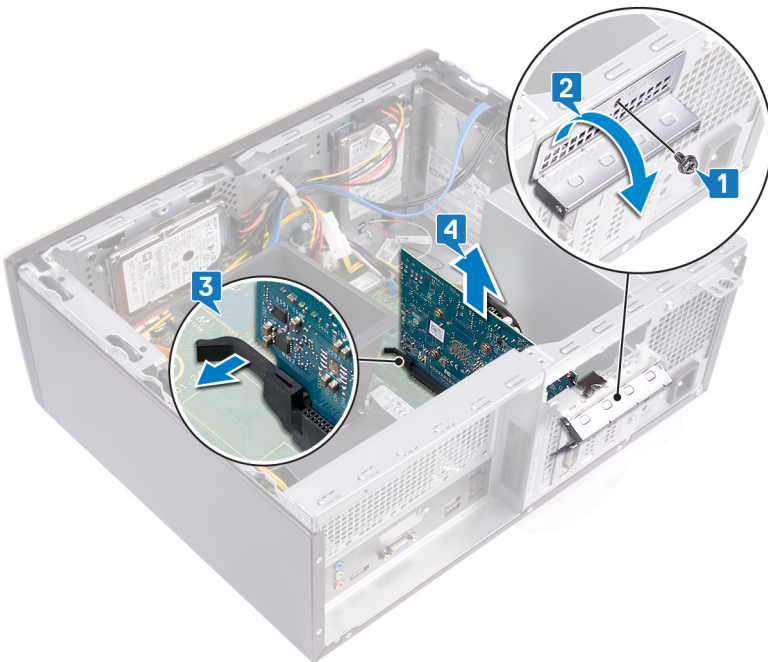

Replacing the graphics card

NOTE: Before working inside your computer, read the safety information that shipped with your computer and follow the steps in [Before working inside your computer](#). After working inside your computer, follow the instructions in [After working inside your computer](#). For more safety best practices, see the Regulatory Compliance home page at www.dell.com/regulatory_compliance.

Procedure

1. Ensure the securing tab on the system board is pushed away from the graphics-card slot.
2. Align the notch on the graphics card with the tab on the graphics card slot, and then press down firmly until the graphics card snaps into place.

NOTE: The securing tab will move to a closed position when the graphics card is replaced correctly. Remove the graphics card and repeat the procedure if the securing tab does not close.

3. Rotate the card-retention bracket and align the screw hole on the card-retention bracket with the screw hole on the chassis.
4. Replace the screw (#6-32x6.35) that secures the card-retention bracket to the chassis.

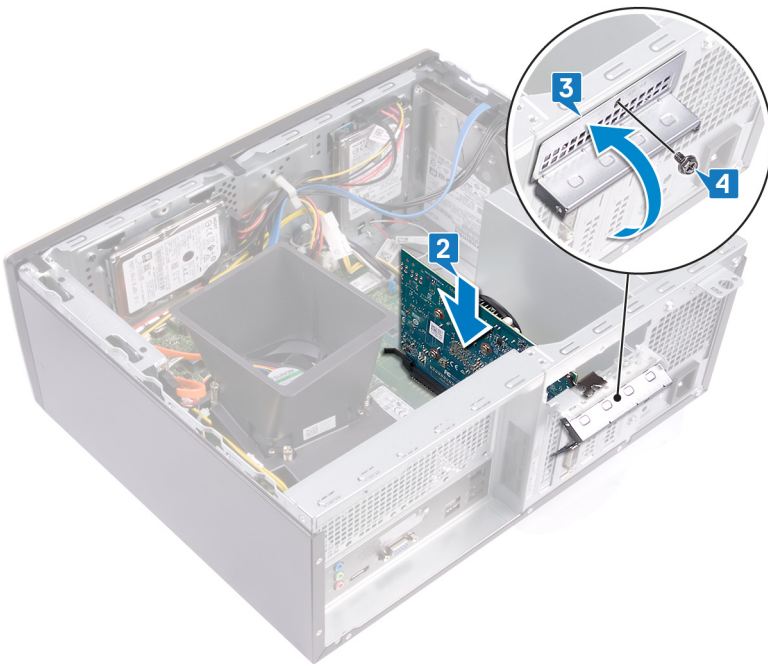

Post-requisites

Replace the [computer cover](#).

Removing the processor fan and heat-sink assembly

- NOTE:** Before working inside your computer, read the safety information that shipped with your computer and follow the steps in [Before working inside your computer](#). After working inside your computer, follow the instructions in [After working inside your computer](#). For more safety best practices, see the Regulatory Compliance home page at www.dell.com/regulatory_compliance.
- NOTE:** The heat sink may become hot during normal operation. Allow sufficient time for the heat sink to cool before you touch it.
- CAUTION:** For maximum cooling of the processor, do not touch the heat transfer areas on the heat sink. The oils in your skin can reduce the heat transfer capability of the thermal grease.

Prerequisites

Remove the [computer cover](#).

Procedure

1. Pry and release the tabs that secure the fan shroud to the processor fan and heat-sink assembly.
2. Lift the fan shroud off the processor fan and heat-sink assembly.

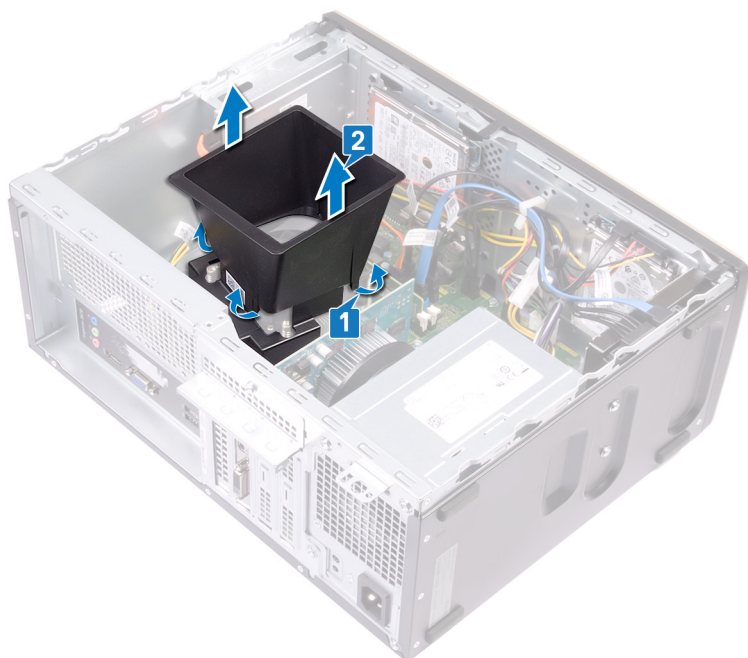

3. Disconnect the processor-fan cable from the system board. (FAN CPU)
4. In reversed order (as indicated on the system board), loosen the four captive screws that secure the processor fan and heat-sink assembly to the system board.
5. Lift the processor fan and heat-sink assembly along with its cable off the system board.



Replacing the processor fan and heat-sink assembly

NOTE: Before working inside your computer, read the safety information that shipped with your computer and follow the steps in [Before working inside your computer](#). After working inside your computer, follow the instructions in [After working inside your computer](#). For more safety best practices, see the Regulatory Compliance home page at www.dell.com/regulatory_compliance.

Procedure

1. Place and align the captive screws on the processor fan and heat-sink assembly with the screw holes on the system board.

NOTE: As shown in the image, ensure that the processor-fan cable faces the front of the computer before tightening the captive screws.

2. In sequential order (as indicated on the system board), tighten the four captive screws that secure the processor fan and heat-sink assembly to the system board.

3. Connect the processor-fan cable to the system board (FAN CPU).



4. Place the fan shroud on the processor fan and heat-sink assembly. Then press down on the fan shroud and snap it into place.

NOTE: Ensure that the "Rear Facing" etching on the fan shroud faces the back of the computer before snapping the fan shroud into place.

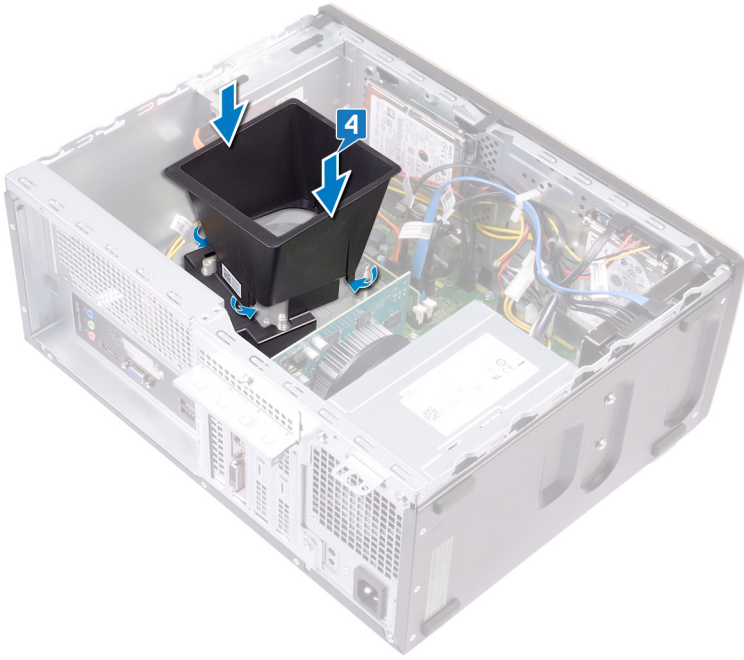

Post-requisites

Replace the [computer cover](#).

Removing the processor

NOTE: Before working inside your computer, read the safety information that shipped with your computer and follow the steps in [Before working inside your computer](#). After working inside your computer, follow the instructions in [After working inside your computer](#). For more safety best practices, see the Regulatory Compliance home page at www.dell.com/regulatory_compliance.

Prerequisites

1. Remove the [computer cover](#).
2. Remove the [processor fan and heat-sink assembly](#).

Procedure

1. Press the release-lever down and then push it away from the processor to release it from the securing bracket.
2. Pull the release-lever up completely to unlock the processor.
3. Gently lift the processor and remove it from the processor socket.

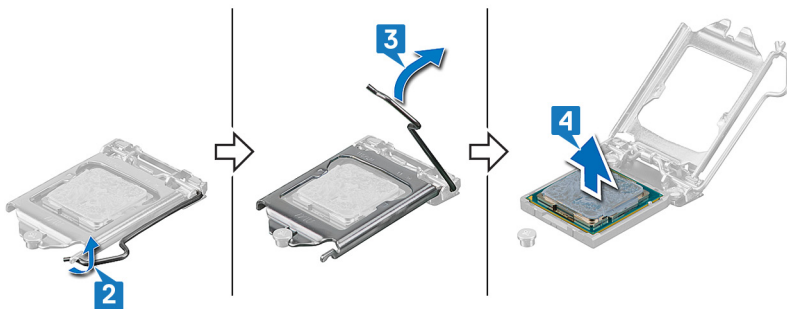

Replacing the processor

NOTE: Before working inside your computer, read the safety information that shipped with your computer and follow the steps in [Before working inside your computer](#). After working inside your computer, follow the instructions in [After working inside your computer](#). For more safety best practices, see the Regulatory Compliance home page at www.dell.com/regulatory_compliance.

CAUTION: If either the processor or the heat sink is replaced, use the thermal grease provided in the kit to ensure that thermal conductivity is achieved.

NOTE: A new processor ships with a thermal pad in the package. In some cases, the processor may ship with the thermal pad attached to it.

Procedure

1. Ensure that the release lever on the processor socket is fully extended in the open position. Then align the notches on the processor with the tabs on the processor socket and place the processor in the processor socket.

CAUTION: The pin-1 corner of the processor is marked with a triangle that must align with the triangle marking on the pin-1 corner on the processor socket to ensure that the processor is properly seated. When the processor is properly seated, all four corners are aligned at the same height. If one or more corners of the processor are higher than the others, the processor is not seated properly and closing the securing bracket may permanently damage the processor.

CAUTION: Ensure that the securing-bracket notch is positioned underneath the alignment post.

2. When the processor is fully seated in the socket, close the securing bracket.
3. Pivot the release-lever down and place it under the tab on the securing bracket.

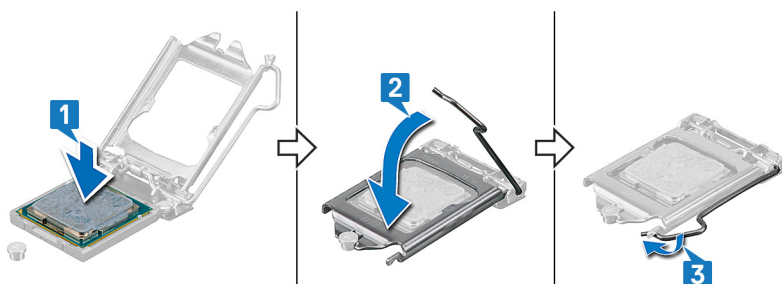

Post-requisites

1. Replace the [processor fan and heat-sink assembly](#).
2. Replace the [computer cover](#).

Removing the antenna modules

NOTE: Before working inside your computer, read the safety information that shipped with your computer and follow the steps in [Before working inside your computer](#). After working inside your computer, follow the instructions in [After working inside your computer](#). For more safety best practices, see the Regulatory Compliance home page at www.dell.com/regulatory_compliance.

Prerequisites

1. Remove the [computer cover](#).
2. Remove the [front bezel](#).
3. Follow the procedure from step 1 to step 4 in "[Removing the wireless card](#)".

Procedure

1. Using a plastic scribe, pry and peel the antenna modules (2) from the locations on the chassis.
2. Pull and route the antenna cables through the antenna-cable slot on the chassis.

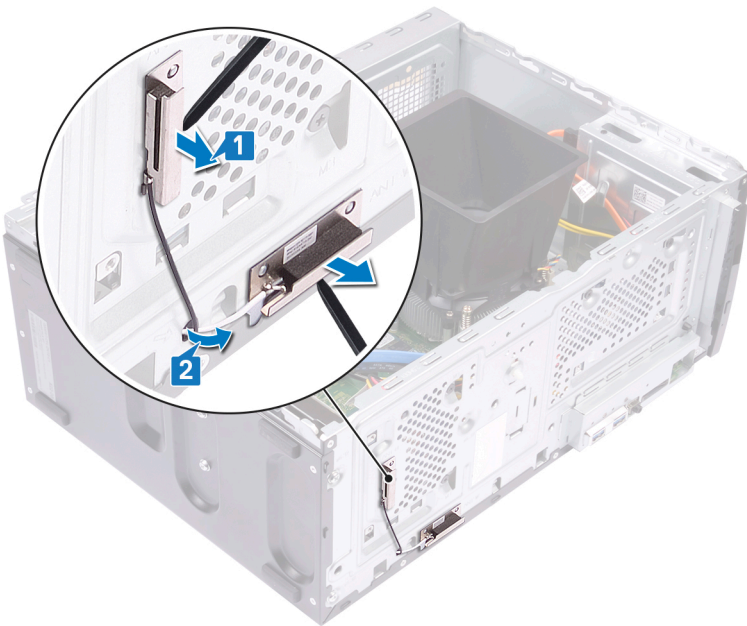

Replacing the antenna modules

NOTE: Before working inside your computer, read the safety information that shipped with your computer and follow the steps in [Before working inside your computer](#). After working inside your computer, follow the instructions in [After working inside your computer](#). For more safety best practices, see the Regulatory Compliance home page at www.dell.com/regulatory_compliance.

Procedure

1. Using the alignment posts, adhere the antenna modules (2) to the chassis.

NOTE: Ensure the antenna modules (ANT-W and ANT-B) are replaced in the correct locations on the chassis.

2. Slide and route the antenna cables through the antenna-cable slot on the chassis.

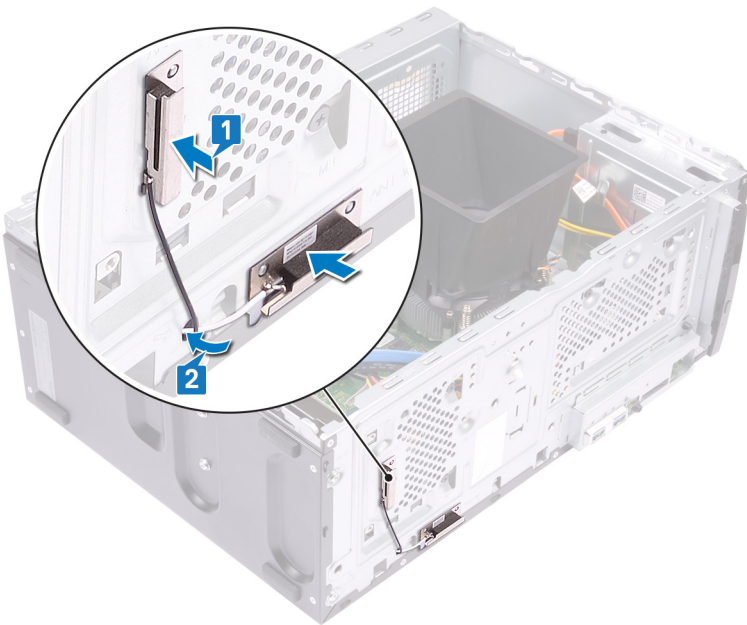

Post-requisites

1. Follow steps 1, 2 and 4 in ["Replacing the wireless card"](#).
2. Replace the [front bezel](#).
3. Replace the [computer cover](#).

Removing the system board

- NOTE:** Before working inside your computer, read the safety information that shipped with your computer and follow the steps in [Before working inside your computer](#). After working inside your computer, follow the instructions in [After working inside your computer](#). For more safety best practices, see the Regulatory Compliance home page at www.dell.com/regulatory_compliance.
- NOTE:** Your computer's Service Tag is stored in the system board. You must enter the Service Tag in the BIOS setup program after you replace the system board.
- NOTE:** Replacing the system board removes any changes you have made to the BIOS using the BIOS setup program. You must make the appropriate changes again after you replace the system board.
- NOTE:** Before disconnecting the cables from the system board, note the location of the connectors so that you can reconnect the cables correctly after you replace the system board.

Prerequisites

1. Remove the [computer cover](#).
2. Remove the [front bezel](#).
3. Remove the [memory module](#).
4. Remove the [solid-state drive/Intel Optane memory](#).
5. Remove the [graphics card](#).
6. Remove the [wireless card](#).
7. Remove the [processor fan and heat-sink assembly](#).
8. Remove the [processor](#).

Procedure

- NOTE:** Note the routing of all cables as you remove them so that you can reroute them correctly after you replace the system board. For information on system board connectors, see "[System board components](#)".
 - NOTE:** Depending on the configuration ordered your computer may have up to two 2.5-inch hard drives installed. If only one hard drive is installed skip step 3 or step 5 where applicable.
1. Disconnect the processor-power cable from the system board (ATX CPU).
 2. Disconnect the optical-drive data cable from the system board (SATA 2).
 3. Disconnect the hard-drive data cable from the system board (SATA 1).
 4. Disconnect the hard-drive cable from the system board (SATA 0).
 5. Disconnect the hard-drive data cable from the system board (SATA 3).
 6. Disconnect the hard-drive power cable from the system board (SATA PWR).
 7. Disconnect the hard-drive power cables from the system board (SATA PWR).
 8. Disconnect the power-supply unit cable (P1) from the system board (ATX SYS).

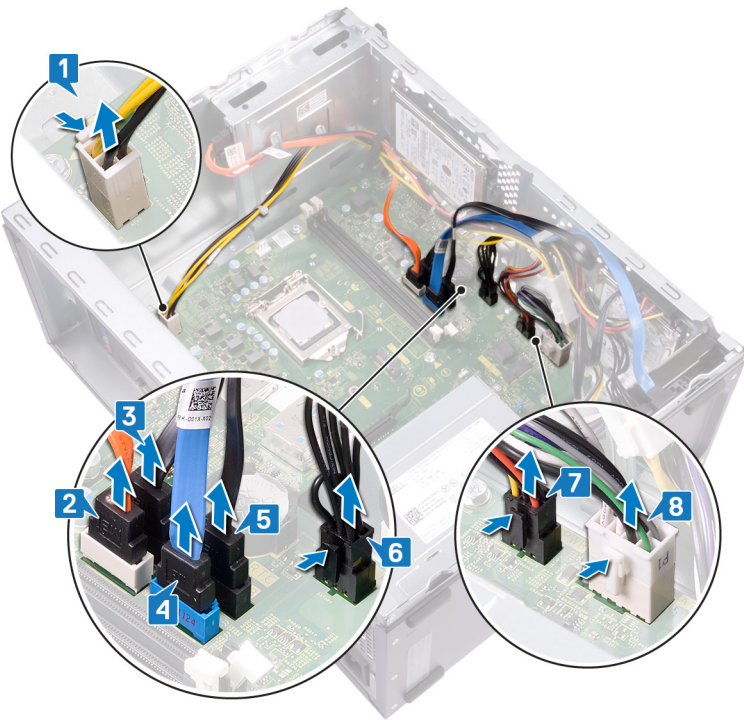

9. Remove the eight screws (#6-32x6.35) that secure the system board to the chassis.
10. Remove the screw (#6-32x4.8, standoff) that secures the system board to the chassis.



11. Remove the screw (#6-32x6.35) that secures the front-I/O bracket to the chassis.
12. Remove the front-I/O bracket from the front-I/O slot on the chassis.

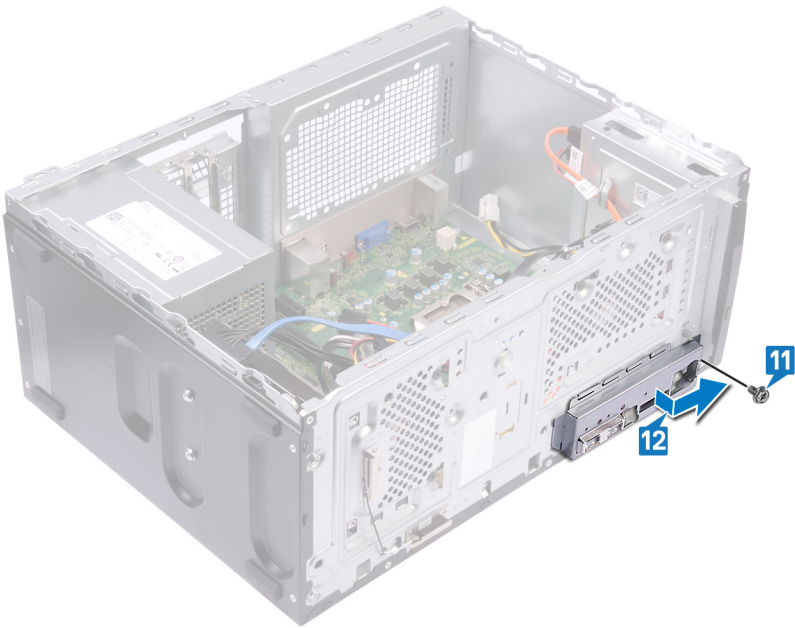

13. Lift the system-board and slide it toward the front-I/O slot, releasing the back-I/O ports from the back-I/O bracket.



14. Lift the system board and remove it from the chassis.

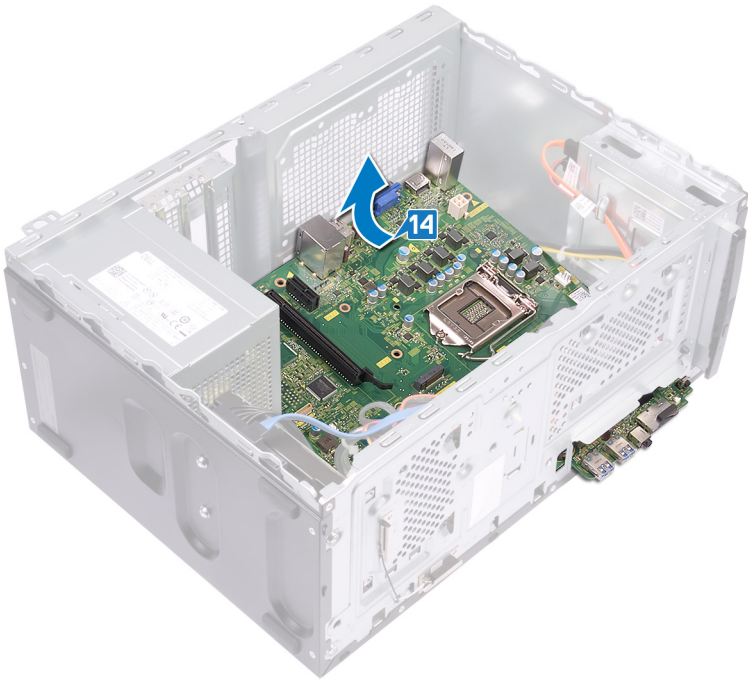

Replacing the system board

- NOTE:** Before working inside your computer, read the safety information that shipped with your computer and follow the steps in [Before working inside your computer](#). After working inside your computer, follow the instructions in [After working inside your computer](#). For more safety best practices, see the Regulatory Compliance home page at www.dell.com/regulatory_compliance.
- NOTE:** Your computer's Service Tag is stored in the system board. You must enter the Service Tag in the BIOS setup program after you replace the system board.
- NOTE:** Replacing the system board removes any changes you have made to the BIOS using the BIOS setup program. You must make the appropriate changes again after you replace the system board.

Procedure

- NOTE:** To ensure that cables are connected to the correct system board connectors, see "[System board components](#)".
- NOTE:** Depending on the configuration ordered your computer may have up to two 2.5-inch hard-drives installed. If only one hard-drive is installed skip step 9 or step 11 where applicable.

1. Slide the edge of the system board into the front-I/O slot on the chassis and lower the system board into the chassis.

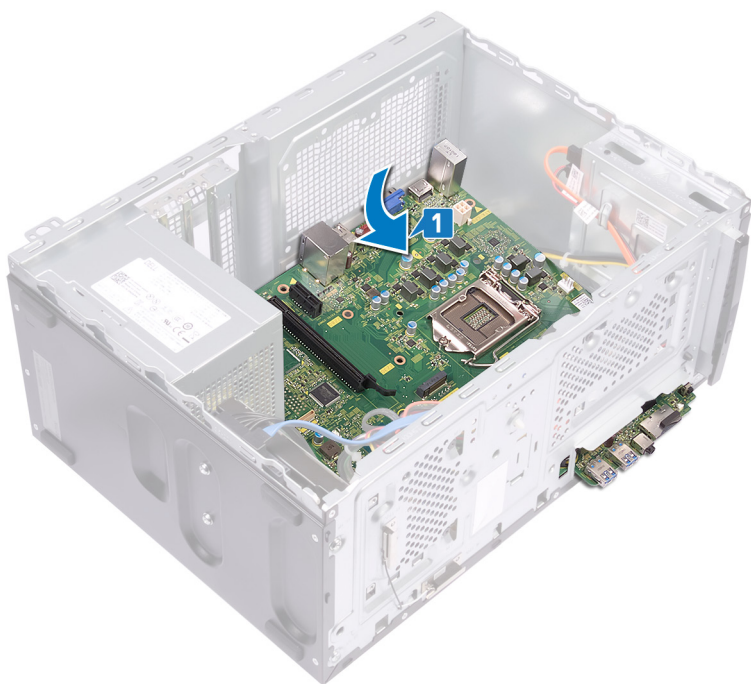

2. Align the screw holes on the system board with the screw holes on the on the chassis.



3. Replace the eight screws (#6-32x6.35) that secure the system board to the chassis.
4. Replace the screw (#6-32x4.8, standoff) that secures the system board to the chassis.



5. Slide the front-I/O bracket into the front-I/O slot, aligning the screw hole on the front-I/O board to the screw hole on the chassis.
6. Replace the screw (#6-32x6.35) that secures the front-I/O bracket to the chassis.

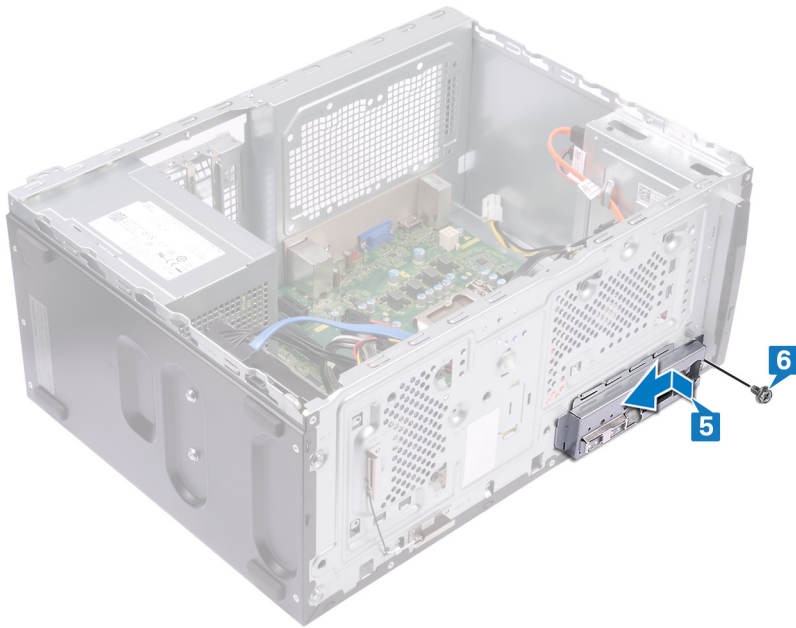

7. Connect the power-supply unit cable (P1) to the system board (ATX CPU).
8. Connect the hard-drive power cables to the system board (SATA PWR).
9. Connect the hard-drive power cable to the system board (SATA PWR).
10. Connect the hard-drive data cable to the system board (SATA 3).
11. Connect the hard-drive cable to the system board (SATA 0).
12. Connect the hard-drive data cable to the system board (SATA 1).
13. Connect the optical-drive data cable to the system board (SATA 2).
14. Connect the processor-power cable to the system board (ATX SYS).

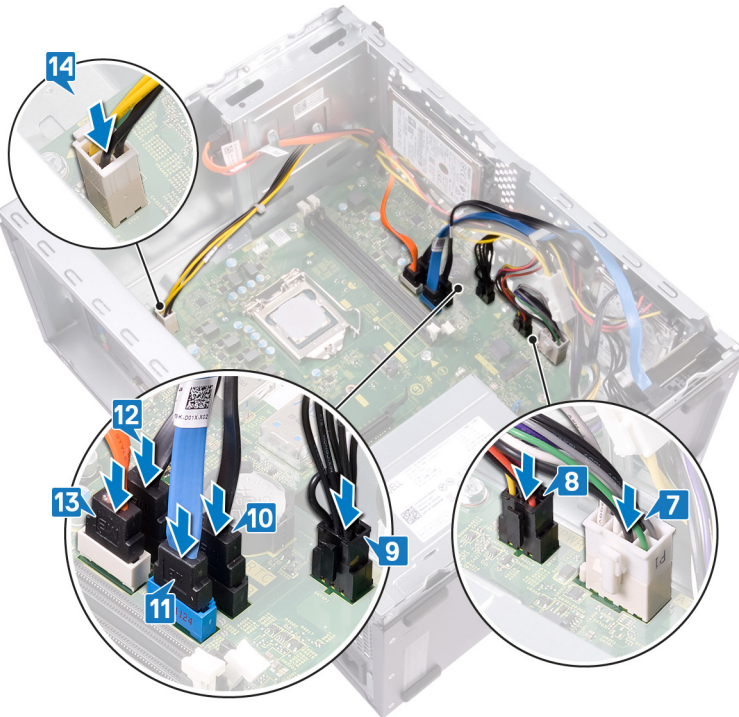

Post-requisites

1. Replace the [processor](#).

2. Replace the [processor fan and heat-sink assembly](#).
3. Replace the [wireless card](#).
4. Replace the [graphics card](#).
5. Replace the [solid-state drive/Intel Optane memory](#).
6. Replace the [memory module](#).
7. Replace the [front bezel](#).
8. Replace the [computer cover](#).

System setup

CAUTION: Unless you are an expert computer user, do not change the settings in the BIOS Setup program. Certain changes can make your computer work incorrectly.

NOTE: Before you change BIOS Setup program, it is recommended that you write down the BIOS Setup program screen information for future reference.

Use the BIOS Setup program for the following purposes:

- Get information about the hardware installed in your computer, such as the amount of RAM and the size of the hard drive.
- Change the system configuration information.
- Set or change a user-selectable option, such as the user password, type of hard drive installed, and enabling or disabling base devices.

BIOS overview

The BIOS manages data flow between the computer's operating system and attached devices such as hard disk, video adapter, keyboard, mouse, and printer.

Entering BIOS setup program

Turn on (or restart) your computer and press F2 immediately.

Navigation keys

NOTE: For most of the System Setup options, changes that you make are recorded but do not take effect until you restart the system.

| Keys | Navigation |
|-------------------|---|
| Up arrow | Moves to the previous field. |
| Down arrow | Moves to the next field. |
| Enter | Selects a value in the selected field (if applicable) or follow the link in the field. |
| Spacebar | Expands or collapses a drop-down list, if applicable. |
| Tab | Moves to the next focus area. |
| Esc | Moves to the previous page until you view the main screen. Pressing Esc in the main screen displays a message that prompts you to save any unsaved changes and restarts the system. |

Boot Sequence

Boot Sequence allows you to bypass the System Setup–defined boot device order and boot directly to a specific device (for example: optical drive or hard drive). During the Power-on Self Test (POST), when the Dell logo appears, you can:

- Access System Setup by pressing F2 key
- Bring up the one-time boot menu by pressing F12 key

The one-time boot menu displays the devices that you can boot from including the diagnostic option. The boot menu options are:

- Removable Drive (if available)
- STXXXX Drive (if available)

NOTE: XXX denotes the SATA drive number.

- Optical Drive (if available)

- SATA Hard Drive (if available)
- Diagnostics

 **NOTE: Choosing Diagnostics, will display the ePSA diagnostics screen.**

The boot sequence screen also displays the option to access the System Setup screen.

System setup options

 **NOTE: Depending on this computer and its installed devices, the items listed in this section may or may not appear.**

Table 3. System setup options—General menu

General

System Information

| | |
|----------------------|--|
| BIOS version | Displays the BIOS version number. |
| Service Tag | Displays the Service Tag of the computer. |
| Asset Tag | Displays the Asset Tag of the computer. |
| Ownership Tag | Displays the Ownership Tag of the computer. |
| Manufacture Date | Displays the manufacture date of the computer. |
| Ownership Date | Displays the ownership date of the computer. |
| Express Service Code | Displays the express service code of the computer. |

Memory Information

| | |
|---------------------|---|
| Memory Installed | Displays the total computer memory installed. |
| Memory Available | Displays the total computer memory available. |
| Memory Speed | Displays the memory speed. |
| Memory Channel Mode | Displays single or dual channel mode. |
| Memory Technology | Displays the technology used for the memory. |
| DIMM 1 Size | Displays the DIMM 1 memory size. |
| DIMM 2 Size | Displays the DIMM 2 memory size. |

PCI Information

| | |
|-----------|--|
| Slot1 | Displays the PCI information of Slot1. |
| Slot2 | Displays the PCI information of Slot2. |
| Slot3 | Displays the PCI information of Slot3. |
| Slot4_M.2 | Displays the PCI information of Slot4_M.2. |
| Slot5_M.2 | Displays the PCI information of Slot5_M.2. |

Processor Information

| | |
|---------------------|--|
| Processor Type | Displays the processor type. |
| Core Count | Displays the number of cores on the processor. |
| Processor ID | Displays the processor identification code. |
| Current Clock Speed | Displays the current processor clock speed. |
| Minimum Clock Speed | Displays the minimum processor clock speed. |
| Maximum Clock Speed | Displays the maximum processor clock speed. |
| Processor L2 Cache | Displays the processor L2 Cache size. |
| Processor L3 Cache | Displays the processor L3 Cache size. |
| HT Capable | Displays whether the processor is HyperThreading (HT) capable. |

General

64-Bit Technology Displays whether 64-bit technology is used.

Device Information

SATA-0 Displays the SATA-0 device information of the computer.

SATA-1 Displays the SATA-1 device information of the computer.

SATA-2 Displays the SATA-2 device information of the computer.

SATA-3 Displays the SATA-3 device information of the computer.

M.2 PCIe SSD-0 Displays the M.2 PCIe SSD information of the computer.

LOM MAC Address Displays the LAN On Motherboard (LOM) MAC address of the computer.

Video Controller Displays the video controller type of the computer.

Audio Controller Displays the audio controller information of the computer.

Wi-Fi Device Displays the wireless device information of the computer.

Bluetooth Device Displays the Bluetooth device information of the computer.

Boot Sequence

Boot Sequence Displays the boot sequence.

Allows you to change the order in which the computer attempts to find an operating system. The options are:

- Windows Boot Manager
- Onboard NIC(IPV4)
- Oboard NIC(IPV6)

By default, all the check boxes are selected. You can clear the check boxes or change the boot order.

Boot List Option Displays the available boot options.

Allows you to change the boot list option:

- Legacy External Devices
- **UEFI** (default)

You can also add or delete a boot option.

Advanced Boot Options Enable or disable legacy boot options when in UEFI boot mode.

- **Enable Legacy Option ROMs** (default)
- Enable Attempt Legacy Boot

UEFI Boot Path Security These options control whether the computer will prompt the user to enter the Admin password (if set) when booting a UEFI boot path from the F12 Boot Menu .

- **Always Except Internal HDD** (default)
- Always, Except Internal HDD&PXE
- Always
- Never

Date/Time Displays the current date in MM/DD/YY format and current time in HH:MM:SS AM/PM format.

Table 4. System setup options—System Configuration menu

System Configuration

Integrated NIC Controls the on-board LAN controller.

Enable UEFI Network Stack Allows you to configure the integrated network controller. The options are:

- Disabled
- Enabled
- **Enabled w/PXE** (default)

System Configuration

SATA Operation

Allows you to configure the SATA drives on board. All drives are enabled by default. The options are:

- Disabled
- AHCI
- **RAID On** (default)

Drives

Enable or disable various drives on board.

- SATA-0
- SATA-1
- SATA-2
- SATA-3
- M.2 PCIe SSD-0

By default, all the check boxes are selected.

SMART Reporting

Enable or disable Self-Monitoring, Analysis, and Reporting Technology (SMART) during system startup. This option is disabled by default.

USB Configuration

Configures the integrated USB controller. If Boot Support is enabled, the computer is allowed to boot any type of USB Mass Storage Devices (HDD, memory key, floppy).

If USB port is enabled, the device attached to this port is enabled and available for OS.

If USB port is disabled, the OS cannot detect any device attached to this port.

- Enable USB Boot Support
- Enable Front USB Ports
- Enable Rear USB Ports

By default, all the check boxes are selected.

NOTE: USB keyboard and mouse always work in the BIOS setup irrespective of these settings.

Front USB Configuration

Enable or disable the front USB ports.

- Front Port 1
- Front Port 2

By default, all the check boxes are selected.

Rear USB Configuration

Enable or disable the rear USB ports.

- Rear Port 1
- Rear Port 2
- Rear Port 3
- Rear Port 4

By default, all the check boxes are selected.

Audio

Enable or disable the integrated audio controller.

By default, **Enable Audio** is selected.

Dust Filter Maintenance

Enable or disable the BIOS reminder messages for maintaining the optional dust filter installed in your computer, at the interval set.

- **Disabled** (default)
- 15 days
- 30 days
- 60 days
- 90 days
- 120 days
- 150 days
- 180 days

System Configuration

Miscellaneous Devices

Enable or disable the Secure Digital (SD) card reader.
By default, **Enable Secure Digital (SD) Card** is selected.

Table 5. System setup options—Video menu

Video

| | |
|-----------------|---|
| Multi-Display | This option enables or disables Multi-Display. It should be enabled for Windows 7 or later. This feature is not applicable to other operating systems. By default, Enable Multi-Display is selected. |
| Primary Display | This option determines which video controller becomes the primary display when multiple controllers are available in the computer. <ul style="list-style-type: none">• Auto (default)• Intel HD Graphics• NVIDIA HD Graphics |

Table 6. System setup options—Security menu

Security

| | |
|-------------------------------|--|
| Admin Password | Set, change, or delete the administrator password. NOTE: You must set the admin password before you set the computer or hard drive password. Deleting the admin password automatically deletes the computer password and the hard drive password. NOTE: Successful password changes take effect immediately. |
| System Password | Set, change, or delete the system password. NOTE: Successful password changes take effect immediately. |
| Internal HDD-0 Password | Set, change, or delete the internal hard-disk drive password. NOTE: Successful password changes take effect immediately. |
| Internal HDD-0Password | Set, change, or delete the internal hard-disk drive password. NOTE: Successful password changes take effect immediately. |
| Internal HDD-1 Password | Set, change, or delete the internal hard-disk drive password. NOTE: Successful password changes take effect immediately. |
| Strong Password | Enable or disable permission to the computer and hard-drive passwords when the admin password is set. By default, Enable Strong Password is not selected. |
| Password Configuration | Control the minimum and maximum number of characters allowed for the Admin and System passwords. |
| Password Bypass | Bypass the System (Boot) Password and the internal HDD password prompts during a system restart. <ul style="list-style-type: none">• Disabled (default)• Reboot Bypass |
| Password Change | Enable or disable changes to the System and Hard Disk passwords when an administrator password is set. By default, Allow Non-Admin Password Changes is selected. |
| UEFI Capsule Firmware Updates | Enable or disable BIOS updates through UEFI capsule update packages. By default, Enable UEFI Capsule Firmware Updates is selected. |
| PTT Security | Enable or disable Platform Trust Technology (PTT) visibility to the operating system. |

Security

| | |
|--------------------------|--|
| | By default, PTT On is not selected. |
| Absolute(R) | Enable or disable the BIOS module interface of the optional Absolute Persistence Module Service from Absolute Software. <ul style="list-style-type: none">• Enabled (default)• Disabled• Permanently Disabled |
| Admin Setup Lockout | Enable to prevent users from entering Setup when an Admin Password is set. By default, Enable Admin Setup Lockout is not selected. |
| Master Password Lockout | When enabled, this option disables the master password support. By default, Enable Master Password Lockout is not selected. |
| SIMM Security Mitigation | Allows you to enable or disable the additional UEFI SIMM Security Mitigation protections. By default, SMM Security Mitigation is not selected. |

Table 7. System setup options—Secure Boot menu

Secure Boot

| | |
|-----------------------|--|
| Secure Boot Enable | Enable or disable the secure boot feature. By default, Secure Boot Enable is not selected. |
| Secure Boot Mode | Set the Secure Boot Mode to allow evaluation or enforcement of UEFI driver signatures. <ul style="list-style-type: none">• Deployed Mode (default)• Audit Mode |
| Expert Key Management | Allows you to manipulate the security key databases only if the computer is in Custom Mode. By default, Enable Custom Mode is selected. If Enable Custom Mode is selected, the options are: <ul style="list-style-type: none">• PK (default)• KEK• db• dbx After selecting an option, the subsequent actions are: <ul style="list-style-type: none">• Save to File—Saves the key to a user-selected file.• Replace from File—Replaces the current key with a key from a user-selected file.• Append from File—Adds a key to the current database from a user-selected file• Delete—Deletes the selected key |

Table 8. System setup options—Intel Software Guard Extensions menu

Intel Software Guard Extensions

| | |
|------------------|--|
| Intel SGX Enable | Enable or disable Intel Software Guard Extensions that provides a secure environment for running code or storing sensitive information in the context of the main OS. The options are: <ul style="list-style-type: none">• Disabled• Enabled• Software Controlled (default) |
|------------------|--|

Intel Software Guard Extensions

| | |
|---------------------|--|
| Enclave Memory Size | Set the Intel Software Guard Extensions Enclave Reserve Memory Size. The options are: <ul style="list-style-type: none">• 32 MB• 64 MB• 128 MB |
|---------------------|--|

Table 9. System setup options—Performance menu

Performance

| | |
|--------------------|--|
| Multi Core Support | Enable or disable one core or multiple cores. The performance of some applications improves with additional cores. If you enable Multi Core Support, two cores are enabled. If you disable Multi Core Support, one core is enabled. <ul style="list-style-type: none">• All (default)• 1• 2• 3• 4• 5• 6• 7 |
| Intel SpeedStep | Enable or disable Intel Speedstep Technology. By default, Enable Intel SpeedStep is selected. NOTE: If enabled, the processor clock speed and the core voltage are adjusted dynamically based on the processor load. |
| C-States Control | Enable or disable additional processor sleep states. By default, C states is selected. |
| Intel TurboBoost | Enable or disable Intel TurboBoost mode of the processor. By default, Enable Intel TurboBoost is selected. |

Table 10. System setup options—Power Management menu

Power Management

| | |
|-------------------------------------|--|
| AC Recovery | Enable or disable the automatic power-on when an AC adapter is connected. <ul style="list-style-type: none">• Power Off (default)• Power On• Last Power State |
| Enable Intel Speed Shift Technology | Enable or disable the Intel Speed Shift Technology support. By default, Enable Intel Speed Shift Technology is selected. |
| Auto On Time | Enable to set the computer to turn on automatically every day or on a preselected date and time. This option can be configured only if the Auto On Time is set to Everyday, Weekdays, or Selected Days. <ul style="list-style-type: none">• Disabled (default)• Every Day• Weekdays• Select Days |
| Deep Sleep Control | Set the computer to conserve power while in Shutdown (S5) or Hibernate state. <ul style="list-style-type: none">• Disabled• Enabled in S5 only• Enabled in S4 and S5 (default) |

Power Management

| | |
|------------------|--|
| USB Wake Support | <p>Enable the USB devices to wake the computer from Standby mode.</p> <p>NOTE: This feature is only functional when the AC power adapter is connected. If the AC power adapter is removed during Standby, the system setup removes power from all the USB ports to conserve battery power.</p> <p>By default, Enable USB Wake Support is selected.</p> |
| Wake on LAN/WLAN | <p>Enable or disable the feature that powers on the computer from the Off state when triggered by a LAN signal.</p> <ul style="list-style-type: none">• Disabled (default)• LAN Only• WLAN Only• LAN or WLAN• LAN with PXE Boot |
| Block Sleep | <p>When Block Sleep is enabled, the computer does not go to Sleep (S3) state.</p> <p>By default, Block Sleep is not selected.</p> |

Table 11. System setup options—POST Behavior menu

POST Behavior

| | |
|-----------------------|---|
| Numlock LED | <p>Enable or disable Numlock when the computer boots up.</p> <p>By default, Enable Numlock LED is selected.</p> |
| Keyboard Errors | <p>Set the computer to report keyboard-related errors when the computer boots up.</p> <p>By default, Enable Keyboard Error Detection is selected.</p> |
| Fastboot | <p>Enable to set the speed of the boot process by bypassing some of the compatibility steps.</p> <ul style="list-style-type: none">• Minimal• Thorough (default)• Auto |
| Extend BIOS POST Time | <p>Set the BIOS POST time for an additional pre-boot delay.</p> <ul style="list-style-type: none">• 0 seconds (default)• 5 seconds• 10 seconds |
| Full Screen Logo | <p>Display the full screen logo if your image matches the screen resolution.</p> <p>By default, Enable Full Screen Logo is not selected.</p> |
| Warnings and Errors | <p>Enable or disable prompts on warning and errors.</p> <ul style="list-style-type: none">• Prompt on Warnings and Errors (default)• Continue on Warnings• Continue on Warnings and Errors |

Table 12. System setup options—Virtualization Support menu

Virtualization Support

| | |
|-------------------|---|
| Virtualization | <p>Specify whether a Virtual Machine Monitor (VMM) can utilize the additional hardware capabilities provided by Intel Virtualization Technology.</p> <p>By default, Enable Intel Virtualization Technology is selected.</p> |
| VT for Direct I/O | <p>Specify whether a Virtual Machine Monitor (VMM) can utilize the additional hardware capabilities provided by Intel Virtualization Technology for Direct I/O.</p> <p>By default, Enable VT for Direct I/O is selected.</p> |

Table 13. System setup options—Wireless menu

Wireless

| | |
|------------------------|---|
| Wireless Device Enable | Enable or disable internal wireless devices. <ul style="list-style-type: none">• WLAN/WiGig (default)• Bluetooth (default) |
|------------------------|---|

Table 14. System setup options—Maintenance menu

Maintenance

| | |
|---------------------|--|
| Service Tag | Display the Service Tag of your computer. |
| Asset Tag | Create a computer Asset Tag. |
| SERR Messages | Control the SERR message mechanism. Some graphics cards require the SERR message. By default, Enable SERR Messages is selected. |
| BIOS Downgrade | Control flashing of the system firmware to previous revisions. By default, Allows BIOS Downgrade is selected. |
| Data Wipe | Enable to securely erase data from all internal storage devices. By default, Wipe on Next Boot is not selected. |
| BIOS Recovery | Enable the user to recover from certain corrupted BIOS conditions from a recovered file on the user primary hard drive. By default, BIOS Recovery from Hard Drive is selected. |
| First Power On Date | Set the date on which the computer is switched on (for ownership record). By default, Set Ownership Date is not selected. |

Table 15. System setup options—System Logs menu

System Logs

| | |
|-------------|----------------------|
| BIOS Events | Display BIOS events. |
|-------------|----------------------|

Table 16. System setup options—Advanced configurations menu

System Logs

| | |
|------|--|
| ASPM | Set the Active State Power Management (ASPM) level. <ul style="list-style-type: none">• Auto (default)• Disabled• L1 Only |
|------|--|

Table 17. System setup options—SupportAssist System Resolution menu

SupportAssist System Resolution

| | |
|----------------------------|---|
| Auto OS Recovery Threshold | Control the automatic boot flow for SupportAssist System Resolution Console and for the Dell OS Recovery tool. <ul style="list-style-type: none">• OFF• 1• 2 (default)• 3 |
| SupportAssist OS Recovery | Enable or disable the boot flow for the SupportAssist OS Recovery tool when certain system errors. By default, SupportAssist OS Recovery is selected. |
| BIOSConnect | Enable or disable the cloud Service OS upon absence of Local OS Recovery.. |

By default, **BIOSConnect** is selected.

Clearing Forgotten Passwords

NOTE: Before working inside your computer, read the safety information that shipped with your computer and follow the steps in [Before working inside your computer](#). After working inside your computer, follow the instructions in [After working inside your computer](#). For more safety best practices, see the Regulatory Compliance home page at www.dell.com/regulatory_compliance.

Prerequisites

Remove the [computer cover](#).

Procedure

1. Locate the password jumper (PSWD) on the system board.

NOTE: For more information on the location of the jumper, see [“System-board components”](#).

2. Remove the jumper plug from the password jumper-pins.

3. Wait for 5 seconds and then replace the jumper plug in its original location.

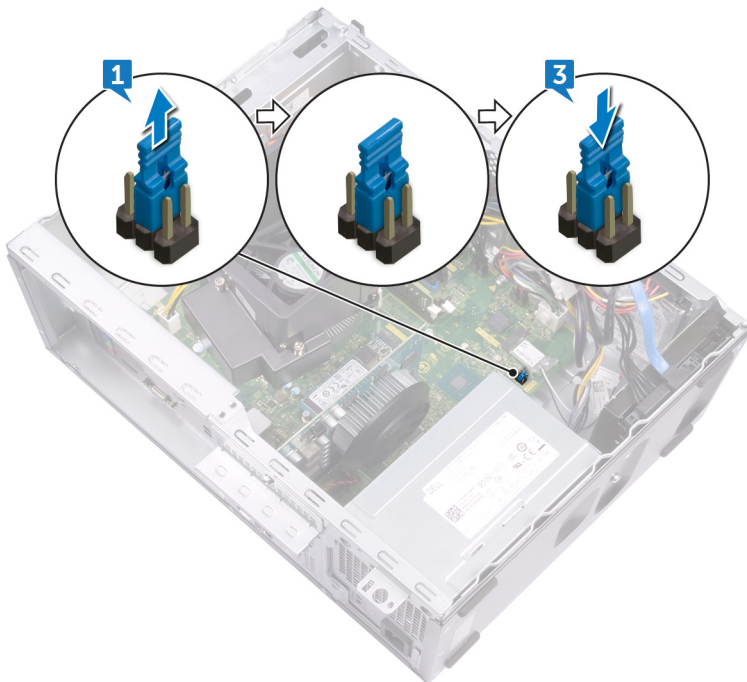

Post-requisites

Replace the [computer cover](#).

Clearing CMOS Settings

NOTE: Before working inside your computer, read the safety information that shipped with your computer and follow the steps in [Before working inside your computer](#). After working inside your computer, follow the instructions in [After](#)

working inside your computer. For more safety best practices, see the Regulatory Compliance home page at www.dell.com/regulatory_compliance.

Prerequisites

Remove the [computer cover](#).

Procedure

1. Locate the CMOS jumper (CMCL R2) on the system board.

NOTE: For more information on the location of the jumper, see **“System-board components”**.

2. Remove the jumper plug from the password jumper-pins (PSWD) and connect it to the CMOS jumper-pins.
3. Wait for 5 seconds, and then replace the jumper plug to its original location.

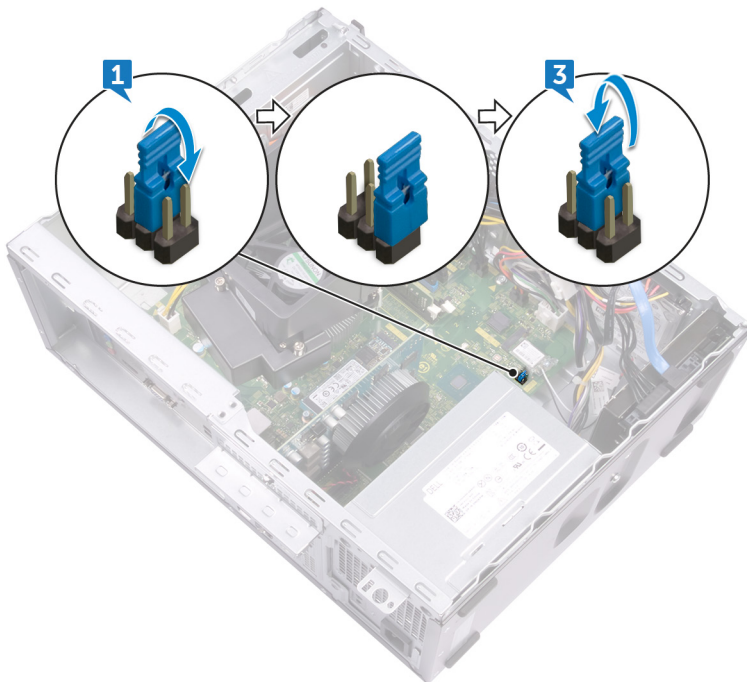

Post-requisites

Replace the [computer cover](#).

Troubleshooting

Enhanced Pre-Boot System Assessment (ePSA) diagnostics

The ePSA diagnostics (also known as system diagnostics) performs a complete check of your hardware. The ePSA is embedded with the BIOS and is launched by the BIOS internally. The embedded system diagnostics provides a set of options for particular devices or device groups allowing you to:

- Run tests automatically or in an interactive mode
- Repeat tests
- Display or save test results
- Run thorough tests to introduce additional test options to provide extra information about the failed device(s)
- View status messages that inform you if tests are completed successfully
- View error messages that inform you of problems encountered during testing

NOTE: Some tests for specific devices require user interaction. Always ensure that you are present at the computer terminal when the diagnostic tests are performed.

Running the ePSA diagnostics

1. Turn on your computer.
2. As the computer boots, press the F12 key as the Dell logo appears.
3. On the boot menu screen, select the **Diagnostics** option.
4. Click the arrow at the bottom left corner.
Diagnostics front page is displayed.
5. Click the arrow in the lower-right corner to go to the page listing.
The items detected are listed.
6. To run a diagnostic test on a specific device, press Esc and click **Yes** to stop the diagnostic test.
7. Select the device from the left pane and click **Run Tests**.
8. If there are any issues, error codes are displayed.
Note the error code and validation number and contact Dell.

Diagnostics

The computer POST (Power On Self Test) ensures that it meets the basic computer requirements and the hardware is working appropriately before the boot process begins. If the computer passes the POST, the computer continues to start in a normal mode. However, if the computer fails the POST, the computer emits a series of LED codes during the start-up. The system LED is integrated on the Power button.

The following table shows different light patterns and what they indicate.

Table 18. Diagnostics

| Number of amber LED flashes | Problem description |
|-----------------------------|--|
| 2, 1 | System board failure |
| 2, 2 | System board, PSU or PSU cabling failure |
| 2, 3 | System board, RAM or CPU failure |
| 2, 4 | CMOS battery failure |

| Number of amber LED flashes | Problem description |
|-----------------------------|--|
| 2, 5 | Corrupt BIOS. Recovery image not detected or is invalid during BIOS auto-recovery process. |
| 2, 6 | CPU configuration error or CPU failure |
| 2, 7 | RAM failure |
| 3, 1 | PCIe (e.g. GPU) card failure |
| 3, 2 | Storage/USB configuration error or failure |
| 3, 3 | No RAM detected |
| 3, 4 | System board error |
| 3, 5 | Memory configuration error, incompatible memory or invalid memory configuration |
| 3, 6 | Recovery image not detected |
| 3, 7 | Recovery image detected but invalid |

Recovering the operating system

When your computer is unable to boot to the operating system even after repeated attempts, it automatically starts Dell SupportAssist OS Recovery.

Dell SupportAssist OS Recovery is a standalone tool that is preinstalled in all Dell computers installed with Windows 10 operating system. It consists of tools to diagnose and troubleshoot issues that may occur before your computer boots to the operating system. It enables you to diagnose hardware issues, repair your computer, back up your files, or restore your computer to its factory state.

You can also download it from the Dell Support website to troubleshoot and fix your computer when it fails to boot into their primary operating system due to software or hardware failures.

For more information about the Dell SupportAssist OS Recovery, see *Dell SupportAssist OS Recovery User's Guide* at www.dell.com/support.

Flashing BIOS (USB key)

1. Follow the procedure from step 1 to step 7 in "Flashing the BIOS" to download the latest BIOS setup program file.
2. Create a bootable USB drive. For more information see the knowledge base article [SLN143196](http://www.dell.com/support) at www.dell.com/support.
3. Copy the BIOS setup program file to the bootable USB drive.
4. Connect the bootable USB drive to the computer that needs the BIOS update.
5. Restart the computer and press **F12** when the Dell logo is displayed on the screen.
6. Boot to the USB drive from the **One Time Boot Menu**.
7. Type the BIOS setup program filename and press **Enter**.
8. The **BIOS Update Utility** appears. Follow the instructions on the screen to complete the BIOS update.

Flashing the BIOS

You may need to flash (update) the BIOS when an update is available or when you replace the system board.

Follow these steps to flash the BIOS:

1. Turn on your computer.
2. Go to www.dell.com/support.
3. Click **Product support**, enter the Service Tag of your computer, and then click **Submit**.

NOTE: If you do not have the Service Tag, use the auto-detect feature or manually browse for your computer model.

4. Click **Drivers & downloads > Find it myself**.
5. Select the operating system installed on your computer.
6. Scroll down the page and expand **BIOS**.
7. Click **Download** to download the latest version of the BIOS for your computer.

8. After the download is complete, navigate to the folder where you saved the BIOS update file.
9. Double-click the BIOS update file icon and follow the instructions on the screen.

Enabling Intel Optane memory

1. On the taskbar, click the search box, and then type `Intel Rapid Storage Technology`.
2. Click **Intel Rapid Storage Technology**.
The **Intel Rapid Storage Technology** window is displayed.
3. On the **Status** tab, click **Enable** to enable the Intel Optane memory.
4. On the warning screen, select a compatible fast drive, and then click **Yes** to continue enabling Intel Optane memory.
5. Click **Intel Optane memory > Reboot** to complete enabling your Intel Optane memory.

 **NOTE: Applications may take up to three subsequent launches after enablement to see the full performance benefits.**

Disabling Intel Optane memory

 **CAUTION: After disabling Intel Optane memory, do not uninstall the driver for Intel Rapid Storage Technology as it will result in a blue screen error. The Intel Rapid Storage Technology user interface can be removed without uninstalling the driver.**

 **NOTE: Disabling Intel Optane memory is required before removing the SATA storage device accelerated by the Intel Optane memory module from the computer.**

1. On the taskbar, click the search box, and then type `Intel Rapid Storage Technology`.
2. Click **Intel Rapid Storage Technology**.
The **Intel Rapid Storage Technology** window is displayed.
3. On the **Intel Optane memory** tab, click **Disable** to disable the Intel Optane memory.

 **NOTE: For computers in which Intel Optane memory acts as a primary storage, do not disable the Intel Optane memory. The Disable option will be grayed out.**

4. Click **Yes** if you accept the warning.
The disabling progress is displayed.
5. Click **Reboot** to complete disabling your Intel Optane memory and restart your computer.

WiFi power cycle

If your computer is unable to access the internet due to WiFi connectivity issues a WiFi power cycle procedure may be performed. The following procedure provides the instructions on how to conduct a WiFi power cycle:

 **NOTE: Some ISPs (Internet Service Providers) provide a modem/router combo device.**

1. Turn off your computer.
2. Turn off the modem.
3. Turn off the wireless router.
4. Wait for 30 seconds.
5. Turn on the wireless router.
6. Turn on the modem.
7. Turn on your computer.

Flea power release

Flea power is the residual static electricity that remains on the computer even after it has been powered off. The following procedure provides the steps to conduct a flea power release for the computer.

1. Turn off your computer.
2. Disconnect the power cable.



3. Press and hold down the power button for 15 seconds to drain the flea power.
4. Connect the power cable.
5. Turn on your computer.

Getting help and contacting Dell

Self-help resources

You can get information and help on Dell products and services using these self-help resources:

Table 19. Self-help resources

| Self-help resources | Resource location |
|---|---|
| Information about Dell products and services | www.dell.com |
| My Dell |  |
| Tips |  |
| Contact Support | In Windows search, type <code>Contact Support</code> , and press Enter. |
| Online help for operating system | www.dell.com/support/windows www.dell.com/support/linux |
| Troubleshooting information, user manuals, setup instructions, product specifications, technical help blogs, drivers, software updates, and so on. | www.dell.com/support |
| Dell knowledge base articles for a variety of computer concerns. | <ol style="list-style-type: none"> 1. Go to www.dell.com/support. 2. Type the subject or keyword in the Search box. 3. Click Search to retrieve the related articles. |
| Learn and know the following information about your product: | See <i>Me and My Dell</i> at www.dell.com/support/manuals . |
| <ul style="list-style-type: none"> • Product specifications • Operating system • Setting up and using your product • Data backup • Troubleshooting and diagnostics • Factory and system restore • BIOS information | <p>To locate the <i>Me and My Dell</i> relevant to your product, identify your product through one of the following:</p> <ul style="list-style-type: none"> • Select Detect Product. • Locate your product through the drop-down menu under View Products. • Enter the Service Tag number or Product ID in the search bar. |

Contacting Dell

To contact Dell for sales, technical support, or customer service issues, see www.dell.com/contactdell.

 **NOTE: Availability varies by country/region and product, and some services may not be available in your country/region.**

 **NOTE: If you do not have an active internet connection, you can find contact information on your purchase invoice, packing slip, bill, or Dell product catalog.**