

Dell Vostro 3590 (Without optical drive)

Service Manual



Notes, cautions, and warnings

 **NOTE:** A NOTE indicates important information that helps you make better use of your product.

 **CAUTION:** A CAUTION indicates either potential damage to hardware or loss of data and tells you how to avoid the problem.

 **WARNING:** A WARNING indicates a potential for property damage, personal injury, or death.

© 2018 - 2019 Dell Inc. or its subsidiaries. All rights reserved. Dell, EMC, and other trademarks are trademarks of Dell Inc. or its subsidiaries. Other trademarks may be trademarks of their respective owners.

1 Working on your computer	6
Safety instructions.....	6
Before working inside your computer.....	6
Electrostatic discharge—ESD protection.....	7
ESD field service kit	7
Transporting sensitive components.....	8
After working inside your computer.....	8
2 Removing and installing components	9
Recommended tools.....	9
Screw list.....	9
Secure Digital Card.....	10
Removing the Secure Digital card.....	10
Installing the Secure Digital card.....	11
Base cover.....	12
Removing the base cover.....	12
Installing the base cover.....	14
Battery.....	15
Lithium-ion battery precautions.....	15
Removing the battery.....	16
Installing the battery.....	16
Memory modules.....	17
Removing the memory module.....	17
Installing the memory module.....	18
WLAN card.....	19
Removing the WLAN card.....	19
Installing the WLAN card.....	20
Solid-state drive/Intel Optane.....	21
Removing the M.2 2230 Solid-state drive.....	21
Installing the M.2 2230 Solid-state drive.....	22
Removing the M.2 2280 Solid-state drive or Intel Optane memory - Optional.....	23
Installing the M.2 2280 Solid-state drive or Intel Optane memory - Optional.....	24
Coin-cell battery.....	25
Removing the coin-cell.....	25
Installing the coin-cell battery.....	26
Hard drive.....	27
Removing the hard drive assembly.....	27
Installing the hard drive assembly.....	29
System fan.....	31
Removing the system fan.....	31
Installing the system fan.....	33
Heat sink.....	35
Removing the heatsink.....	35
Installing the heatsink.....	35

Speakers.....	36
Removing the speakers.....	36
Installing the speakers.....	37
IO board.....	38
Removing the IO board.....	38
Installing the IO board.....	40
Touchpad.....	41
Removing the touch pad assembly.....	41
Installing the touch pad assembly.....	43
Display assembly.....	45
Removing the display assembly.....	45
Installing the display assembly.....	48
Power-button board.....	50
Removing the power button board.....	50
Installing the power button board.....	51
Power button.....	51
Removing the power button.....	51
Installing the power button.....	52
System board.....	53
Removing the system board.....	53
Installing the system board.....	54
Power-adapter port.....	54
Removing the power adapter port.....	54
Installing the power adapter port.....	55
Display bezel.....	56
Removing the display bezel.....	56
Installing the display bezel.....	57
Camera.....	58
Removing the camera.....	58
Installing the camera.....	59
Display panel.....	60
Removing the display panel.....	60
Installation display panel.....	62
Display hinges.....	64
Removing the display hinges.....	64
Installing the display hinges.....	65
Display cable.....	66
Removing the display cable.....	66
Installing the display cable.....	67
Display back-cover and antenna assembly.....	68
Removing the display back-cover.....	68
Installing the display back-cover.....	70
Palm-rest and keyboard assembly.....	71
Removing the palmrest and keyboard assembly.....	71
3 System setup.....	73
Boot menu.....	73
Navigation keys.....	73
System setup options.....	74
General options.....	74

System information.....	74
Video.....	75
Security.....	75
Secure boot.....	76
Intel Software Guard Extensions.....	77
Performance.....	77
Power management.....	78
POST behavior.....	79
Virtualization support.....	80
Wireless.....	80
Maintenance screen.....	80
System logs.....	81
SupportAssist System Resolution.....	81
System and setup password.....	81
Assigning a system setup password.....	81
Deleting or changing an existing system setup password.....	82
4 Troubleshooting.....	83
Enhanced Pre-Boot System Assessment (ePSA) diagnostics.....	83
Running the ePSA diagnostics.....	83
System diagnostic lights.....	83
Flashing BIOS (USB key).....	84
Flashing the BIOS.....	84
Backup media and recovery options.....	85
WiFi power cycle.....	85
Flea power release.....	85
5 Getting help.....	86
Contacting Dell.....	86

Working on your computer

Safety instructions

Prerequisites

Use the following safety guidelines to protect your computer from potential damage and to ensure your personal safety. Unless otherwise noted, each procedure included in this document assumes that the following conditions exist:

- You have read the safety information that shipped with your computer.
- A component can be replaced or, if purchased separately, installed by performing the removal procedure in reverse order.

About this task

 **NOTE:** Disconnect all power sources before opening the computer cover or panels. After you finish working inside the computer, replace all covers, panels, and screws before connecting to the power source.

 **WARNING:** Before working inside your computer, read the safety information that shipped with your computer. For additional safety best practices information, see the [Regulatory Compliance Homepage](#)

 **CAUTION:** Many repairs may only be done by a certified service technician. You should only perform troubleshooting and simple repairs as authorized in your product documentation, or as directed by the online or telephone service and support team. Damage due to servicing that is not authorized by Dell is not covered by your warranty. Read and follow the safety instructions that came with the product.

 **CAUTION:** To avoid electrostatic discharge, ground yourself by using a wrist grounding strap or by periodically touching an unpainted metal surface at the same time as touching a connector on the back of the computer.

 **CAUTION:** Handle components and cards with care. Do not touch the components or contacts on a card. Hold a card by its edges or by its metal mounting bracket. Hold a component such as a processor by its edges, not by its pins.

 **CAUTION:** When you disconnect a cable, pull on its connector or on its pull-tab, not on the cable itself. Some cables have connectors with locking tabs; if you are disconnecting this type of cable, press in on the locking tabs before you disconnect the cable. As you pull connectors apart, keep them evenly aligned to avoid bending any connector pins. Also, before you connect a cable, ensure that both connectors are correctly oriented and aligned.

 **NOTE:** The color of your computer and certain components may appear differently than shown in this document.

Before working inside your computer

About this task

To avoid damaging your computer, perform the following steps before you begin working inside the computer.

Steps

1. Ensure that you follow the [Safety Instruction](#).
2. Ensure that your work surface is flat and clean to prevent the computer cover from being scratched.
3. Turn off your computer.
4. Disconnect all network cables from the computer.

 **CAUTION:** To disconnect a network cable, first unplug the cable from your computer and then unplug the cable from the network device.

5. Disconnect your computer and all attached devices from their electrical outlets.

6. Press and hold the power button while the computer is unplugged to ground the system board.

NOTE: To avoid electrostatic discharge, ground yourself by using a wrist grounding strap or by periodically touching an unpainted metal surface at the same time as touching a connector on the back of the computer.

Electrostatic discharge—ESD protection

ESD is a major concern when you handle electronic components, especially sensitive components such as expansion cards, processors, memory DIMMs, and system boards. Very slight charges can damage circuits in ways that may not be obvious, such as intermittent problems or a shortened product life span. As the industry pushes for lower power requirements and increased density, ESD protection is an increasing concern.

Due to the increased density of semiconductors used in recent Dell products, the sensitivity to static damage is now higher than in previous Dell products. For this reason, some previously approved methods of handling parts are no longer applicable.

Two recognized types of ESD damage are catastrophic and intermittent failures.

- **Catastrophic** – Catastrophic failures represent approximately 20 percent of ESD-related failures. The damage causes an immediate and complete loss of device functionality. An example of catastrophic failure is a memory DIMM that has received a static shock and immediately generates a "No POST/No Video" symptom with a beep code emitted for missing or nonfunctional memory.
- **Intermittent** – Intermittent failures represent approximately 80 percent of ESD-related failures. The high rate of intermittent failures means that most of the time when damage occurs, it is not immediately recognizable. The DIMM receives a static shock, but the tracing is merely weakened and does not immediately produce outward symptoms related to the damage. The weakened trace may take weeks or months to melt, and in the meantime may cause degradation of memory integrity, intermittent memory errors, etc.

The more difficult type of damage to recognize and troubleshoot is the intermittent (also called latent or "walking wounded") failure.

Perform the following steps to prevent ESD damage:

- Use a wired ESD wrist strap that is properly grounded. The use of wireless anti-static straps is no longer allowed; they do not provide adequate protection. Touching the chassis before handling parts does not ensure adequate ESD protection on parts with increased sensitivity to ESD damage.
- Handle all static-sensitive components in a static-safe area. If possible, use anti-static floor pads and workbench pads.
- When unpacking a static-sensitive component from its shipping carton, do not remove the component from the anti-static packing material until you are ready to install the component. Before unwrapping the anti-static packaging, ensure that you discharge static electricity from your body.
- Before transporting a static-sensitive component, place it in an anti-static container or packaging.

ESD field service kit

The unmonitored Field Service kit is the most commonly used service kit. Each Field Service kit includes three main components: anti-static mat, wrist strap, and bonding wire.

Components of an ESD field service kit

The components of an ESD field service kit are:

- **Anti-Static Mat** – The anti-static mat is dissipative and parts can be placed on it during service procedures. When using an anti-static mat, your wrist strap should be snug and the bonding wire should be connected to the mat and to any bare metal on the system being worked on. Once deployed properly, service parts can be removed from the ESD bag and placed directly on the mat. ESD-sensitive items are safe in your hand, on the ESD mat, in the system, or inside a bag.
- **Wrist Strap and Bonding Wire** – The wrist strap and bonding wire can be either directly connected between your wrist and bare metal on the hardware if the ESD mat is not required, or connected to the anti-static mat to protect hardware that is temporarily placed on the mat. The physical connection of the wrist strap and bonding wire between your skin, the ESD mat, and the hardware is known as bonding. Use only Field Service kits with a wrist strap, mat, and bonding wire. Never use wireless wrist straps. Always be aware that the internal wires of a wrist strap are prone to damage from normal wear and tear, and must be checked regularly with a wrist strap tester in order to avoid accidental ESD hardware damage. It is recommended to test the wrist strap and bonding wire at least once per week.
- **ESD Wrist Strap Tester** – The wires inside of an ESD strap are prone to damage over time. When using an unmonitored kit, it is a best practice to regularly test the strap prior to each service call, and at a minimum, test once per week. A wrist strap tester is the best method for doing this test. If you do not have your own wrist strap tester, check with your regional office to find out if they have one. To perform the test, plug the wrist-strap's bonding-wire into the tester while it is strapped to your wrist and push the button to test. A green LED is lit if the test is successful; a red LED is lit and an alarm sounds if the test fails.
- **Insulator Elements** – It is critical to keep ESD sensitive devices, such as plastic heat sink casings, away from internal parts that are insulators and often highly charged.

- **Working Environment** – Before deploying the ESD Field Service kit, assess the situation at the customer location. For example, deploying the kit for a server environment is different than for a desktop or portable environment. Servers are typically installed in a rack within a data center; desktops or portables are typically placed on office desks or cubicles. Always look for a large open flat work area that is free of clutter and large enough to deploy the ESD kit with additional space to accommodate the type of system that is being repaired. The workspace should also be free of insulators that can cause an ESD event. On the work area, insulators such as Styrofoam and other plastics should always be moved at least 12 inches or 30 centimeters away from sensitive parts before physically handling any hardware components
- **ESD Packaging** – All ESD-sensitive devices must be shipped and received in static-safe packaging. Metal, static-shielded bags are preferred. However, you should always return the damaged part using the same ESD bag and packaging that the new part arrived in. The ESD bag should be folded over and taped shut and all the same foam packing material should be used in the original box that the new part arrived in. ESD-sensitive devices should be removed from packaging only at an ESD-protected work surface, and parts should never be placed on top of the ESD bag because only the inside of the bag is shielded. Always place parts in your hand, on the ESD mat, in the system, or inside an anti-static bag.
- **Transporting Sensitive Components** – When transporting ESD sensitive components such as replacement parts or parts to be returned to Dell, it is critical to place these parts in anti-static bags for safe transport.

ESD protection summary

It is recommended that all field service technicians use the traditional wired ESD grounding wrist strap and protective anti-static mat at all times when servicing Dell products. In addition, it is critical that technicians keep sensitive parts separate from all insulator parts while performing service and that they use anti-static bags for transporting sensitive components.

Transporting sensitive components

When transporting ESD sensitive components such as replacement parts or parts to be returned to Dell, it is critical to place these parts in anti-static bags for safe transport.

Lifting equipment

Adhere to the following guidelines when lifting heavy weight equipment:

 **CAUTION: Do not lift greater than 50 pounds. Always obtain additional resources or use a mechanical lifting device.**

1. Get a firm balanced footing. Keep your feet apart for a stable base, and point your toes out.
2. Tighten stomach muscles. Abdominal muscles support your spine when you lift, offsetting the force of the load.
3. Lift with your legs, not your back.
4. Keep the load close. The closer it is to your spine, the less force it exerts on your back.
5. Keep your back upright, whether lifting or setting down the load. Do not add the weight of your body to the load. Avoid twisting your body and back.
6. Follow the same techniques in reverse to set the load down.

After working inside your computer

About this task

After you complete any replacement procedure, ensure that you connect any external devices, cards, and cables before turning on your computer.

Steps

1. Connect any telephone or network cables to your computer.

 **CAUTION: To connect a network cable, first plug the cable into the network device and then plug it into the computer.**

2. Connect your computer and all attached devices to their electrical outlets.
3. Turn on your computer.
4. If required, verify that the computer works correctly by running **ePSA diagnostics**.

Removing and installing components

Recommended tools

The procedures in this document require the following tools:











- Phillips #0 screwdriver
- Phillips #1 screwdriver
- Plastic scribe









NOTE: The #0 screw driver is for screws 0-1 and the #1 screw driver is for screws 2-4

Screw list

The table provides the list of screws that are used for securing different components.

Table 1. Screw list

Component	Screw type	Quantity	Screw image
Base cover	M2.5x6	6	 <p>NOTE: Screw color may vary depending on the configuration ordered.</p>
Battery	M2x3	4	
Display panel	M2x2	4	
System Fan	M2.5x5	3	
Hard-drive assembly	M2x3	4	
Hard-drive bracket	M3x3	4	
Heat sink - discrete	M2x3	4	
Hinges	M2.5x2.5	8	 
	M2x2	2	
I/O board	M2x4	2	
Optical-drive bracket	M2x3	2	

Component	Screw type	Quantity	Screw image
Optical-drive connector board	M2x2 Big Head	1	
Power-adaptor port	M2x3	1	
Power-button board	M2x2 Big Head	1	
Power button with fingerprint reader (optional)	M2x2 Big Head	1	
Solid-state drive to thermal plate	M2x2 Big Head	1	
Solid-state drive	M2x0.8x2.2	1	
System board	M2x4	1	
Touchpad	M2x2	6	
Wireless-card bracket	M2x3	1	

Secure Digital Card

Removing the Secure Digital card

Prerequisites

1. Follow the procedure in [Before working inside your computer](#)

Steps

1. Push the secure digital card to release it from the computer.
2. Slide the secure digital card out of the computer.



Installing the Secure Digital card

Steps

1. Slide the secure digital into the slot until it clicks into place.
2. Follow the procedures in [After working inside your computer](#).



Base cover

Removing the base cover

Prerequisites

1. Follow the procedure in [before working inside your computer](#)
2. Remove the [SD memory card](#)

Steps

1. Loosen the three captive screws [1].
2. Remove the single (M2x4) screw and six (M2.5x7) screws that secure the base cover to the palmrest and keyboard assembly [2, 3].

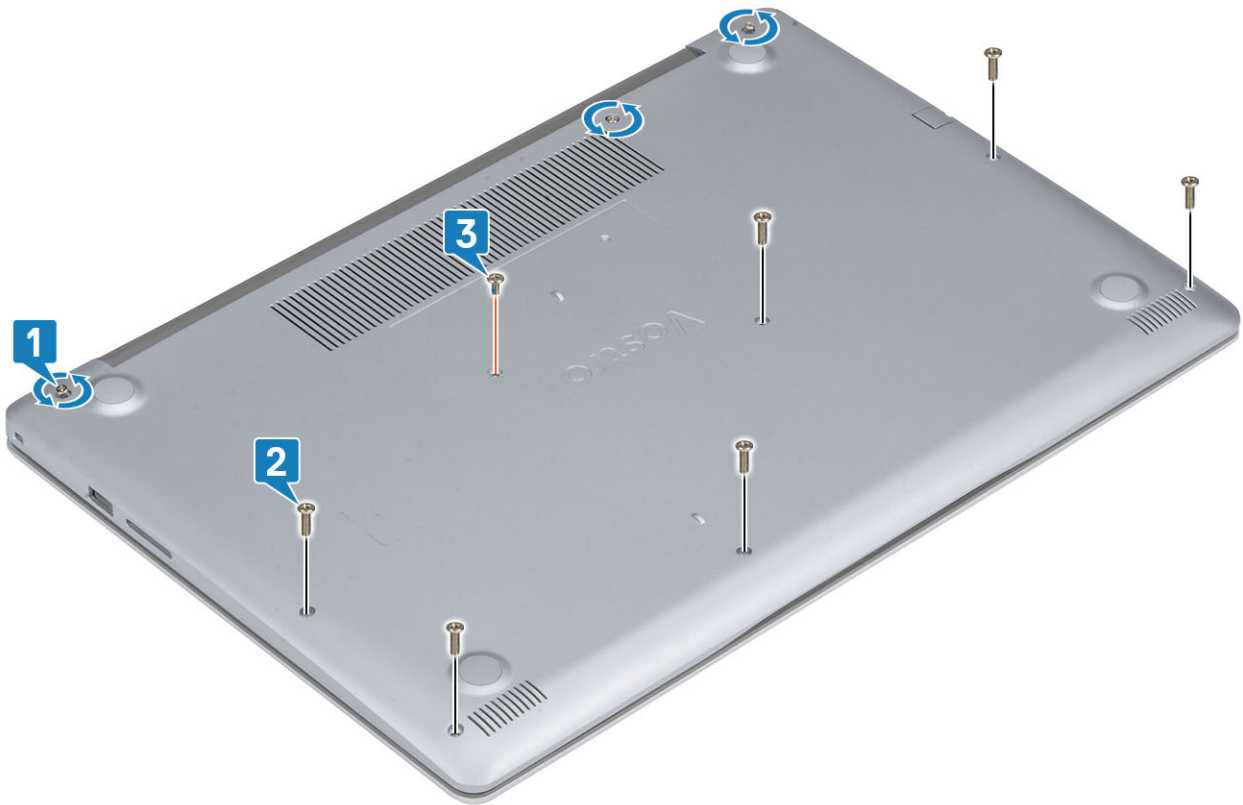

3. Pry the base cover from the top-left corner [1] and continue to pry open the sides of the base cover [2, 3, 4].

two



Installing the base cover

Steps

1. Place the base cover on the palmrest and keyboard assembly [1].
2. Press the edges and sides of the base cover until it snaps into place [2, 3, 4].



3. Tighten the three captive screws, and replace the single (M2x4) screw that secures the base cover to the palmrest and keyboard assembly [1, 2].
4. Replace the six (M2.5x7) screws that secure the base cover to the palmrest and keyboard assembly [3].

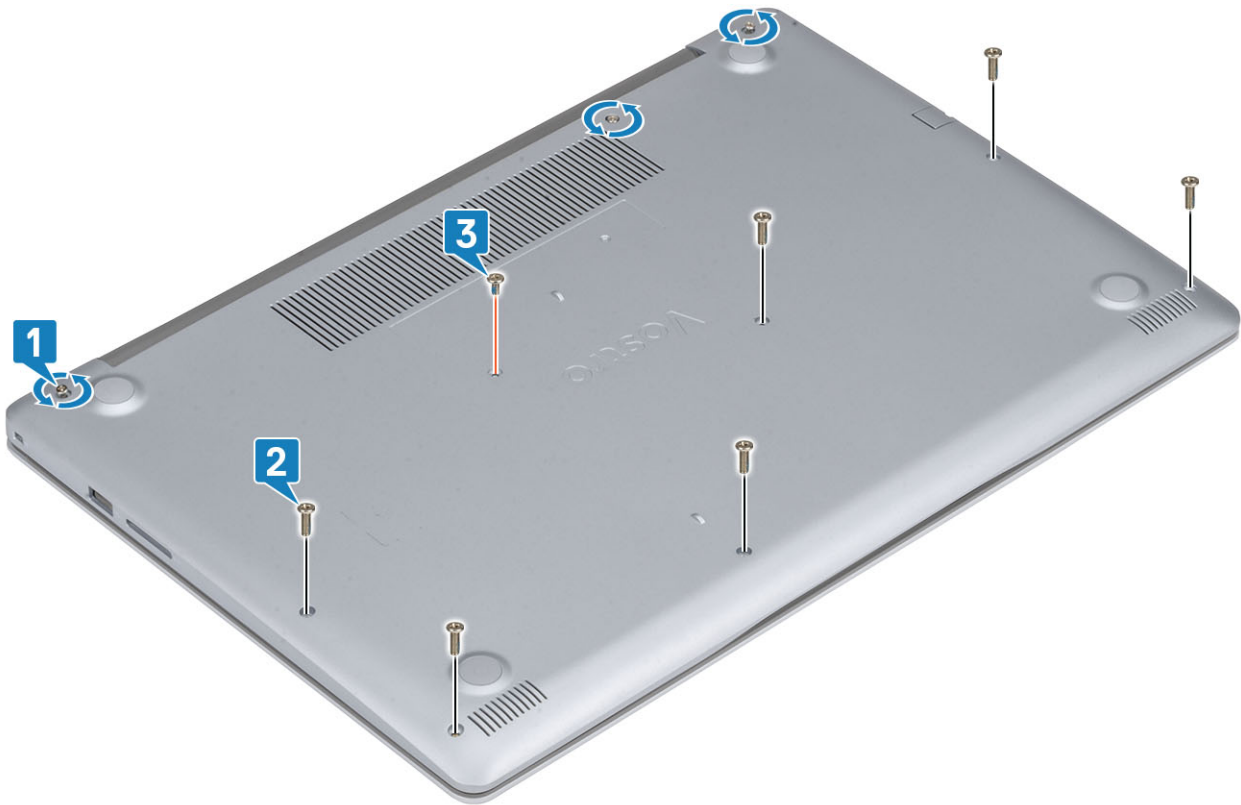

Next steps

1. Replace the [SD memory card](#)
2. Follow the procedure in [after working inside your computer](#)

Battery

Lithium-ion battery precautions

⚠ CAUTION:

- Exercise caution when handling Lithium-ion batteries.
- Discharge the battery as much as possible before removing it from the system. This can be done by disconnecting the AC adapter from the system to allow the battery to drain.
- Do not crush, drop, mutilate, or penetrate the battery with foreign objects.
- Do not expose the battery to high temperatures, or disassemble battery packs and cells.
- Do not apply pressure to the surface of the battery.
- Do not bend the battery.
- Do not use tools of any kind to pry on or against the battery.
- Ensure any screws during the servicing of this product are not lost or misplaced, to prevent accidental puncture or damage to the battery and other system components.
- If a battery gets stuck in a device as a result of swelling, do not try to free it as puncturing, bending, or crushing a Lithium-ion battery can be dangerous. In such an instance, contact for assistance and further instructions.
- If the battery gets stuck inside your computer as a result of swelling, do not try to release it as puncturing, bending, or crushing a lithium-ion battery can be dangerous. In such an instance, contact Dell technical support for assistance. See www.dell.com/contactdell.
- Always purchase genuine batteries from www.dell.com or authorized Dell partners and resellers.

Removing the battery

Prerequisites

1. Follow the procedure in [before working inside your computer](#)
2. Remove the [SD memory card](#)
3. Remove the [base cover](#)

Steps

1. Disconnect the battery cable from the system board [1].
2. Remove the four (M2x3) screws that secure the battery to the palmrest and keyboard assembly [2].
3. Lift the battery off the palmrest and keyboard assembly [3].

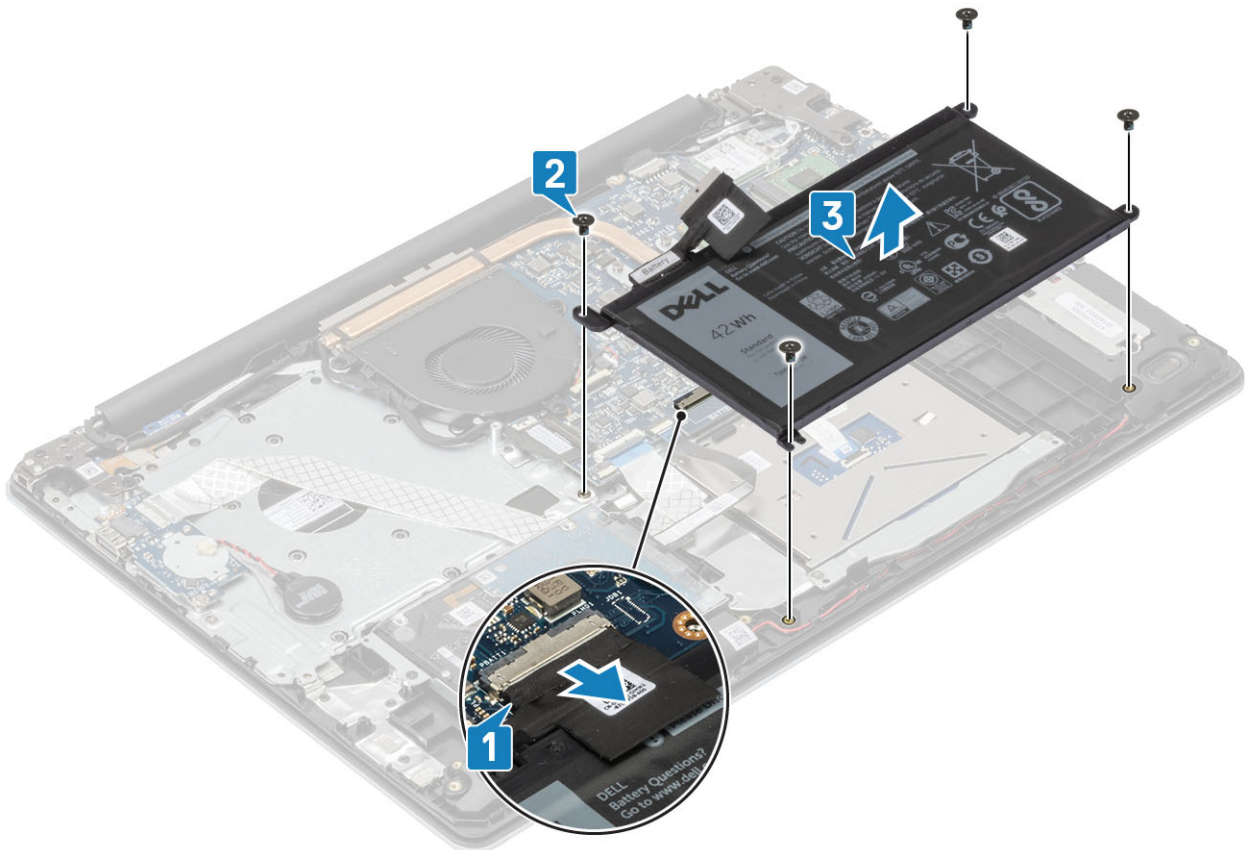

Installing the battery

Steps

1. Align the screw holes on the battery with the screw holes on the palmrest and keyboard assembly [1].
2. Replace the four (M2x3) screws that secure the battery to the palmrest and keyboard assembly [2].
3. Connect the battery cable to the system board [3].

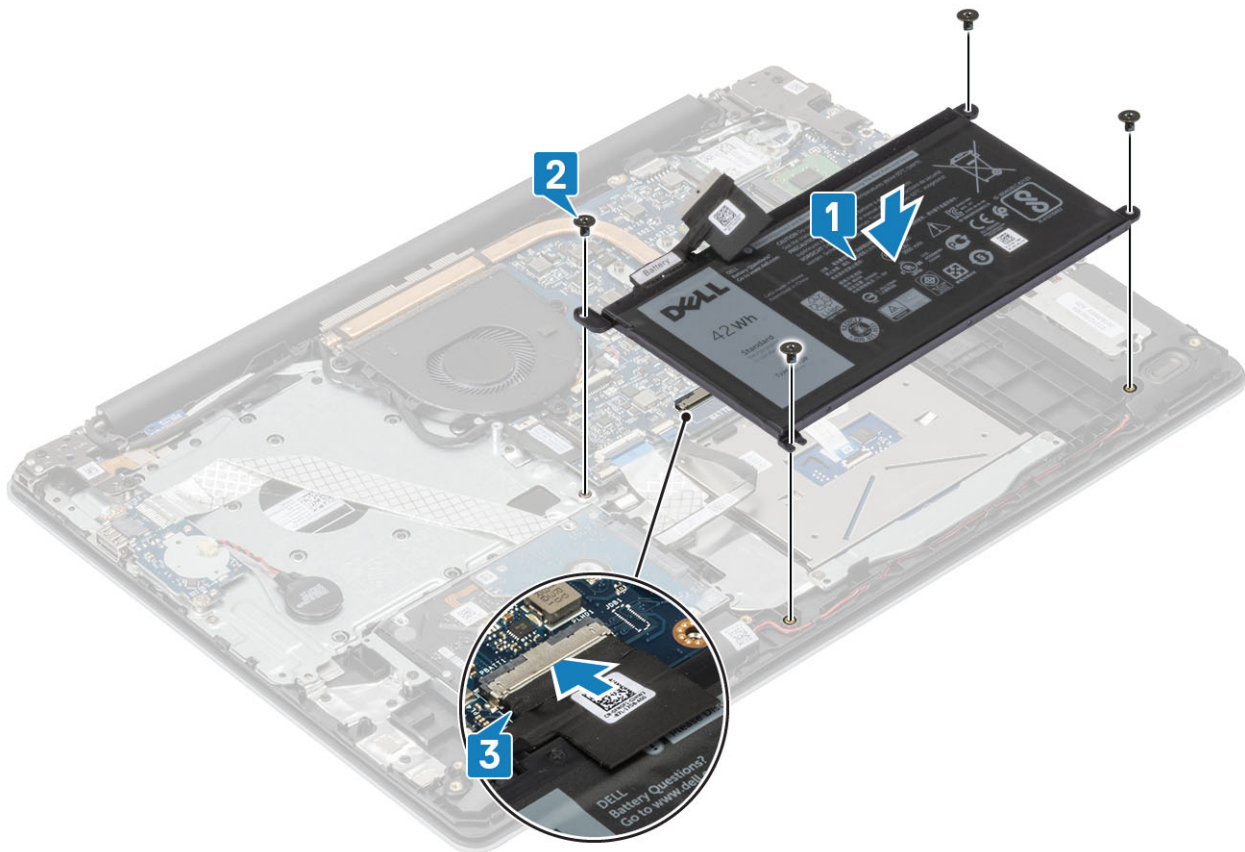

Next steps

1. Replace the [base cover](#)
2. Replace the [SD memory card](#)
3. Follow the procedure in [after working inside your computer](#)

Memory modules

Removing the memory module

Prerequisites

1. Follow the procedure in [before working inside your computer](#)
2. Remove the [SD memory card](#)
3. Remove the [base cover](#)
4. Disconnect the battery cable from the connector on the system board.

Steps

1. Pry the clips securing the memory module until the memory module pops-up [1].
2. Remove the memory module from the memory module slot [2].

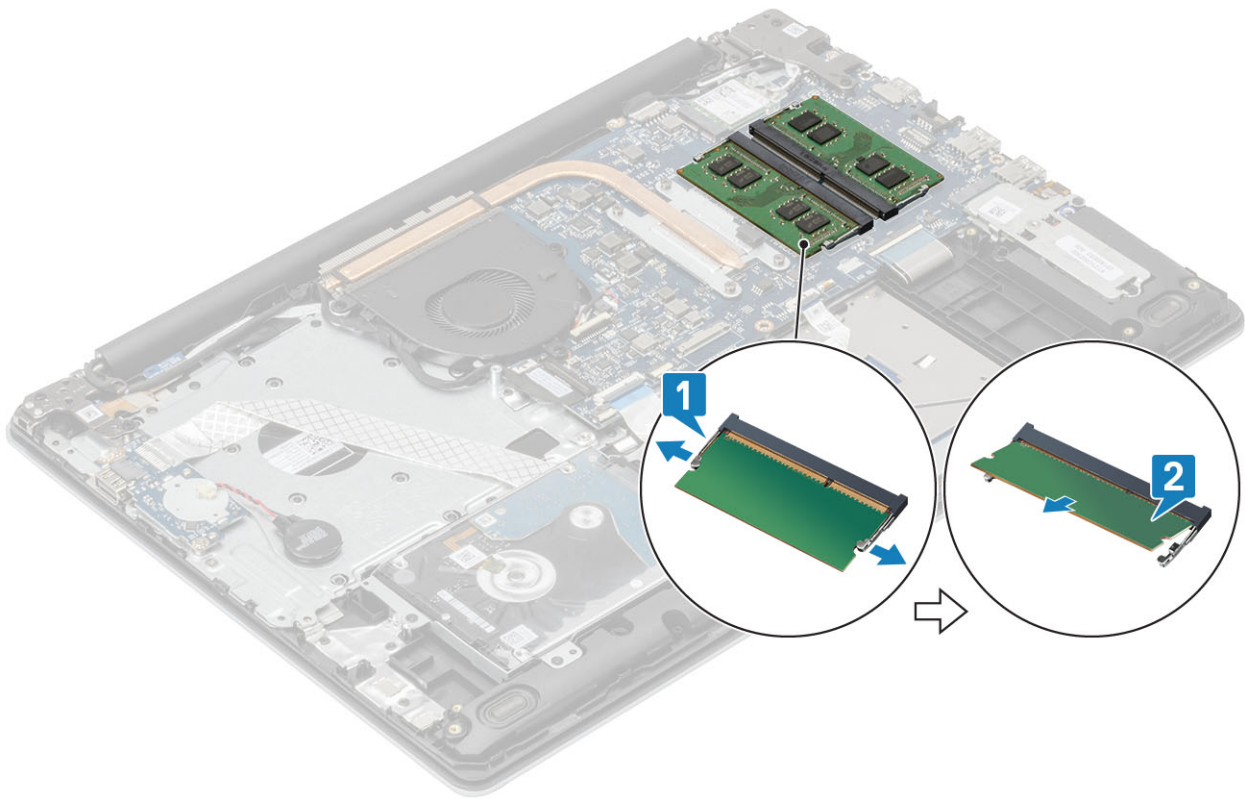

Installing the memory module

Steps

1. Align the notch on the memory module with the tab on the memory-module slot.
2. Slide the memory module firmly into the slot at an angle [1].
3. Press the memory module down until the clips secure it [2].

 **NOTE:** If you do not hear the click, remove the memory module and reinstall it.

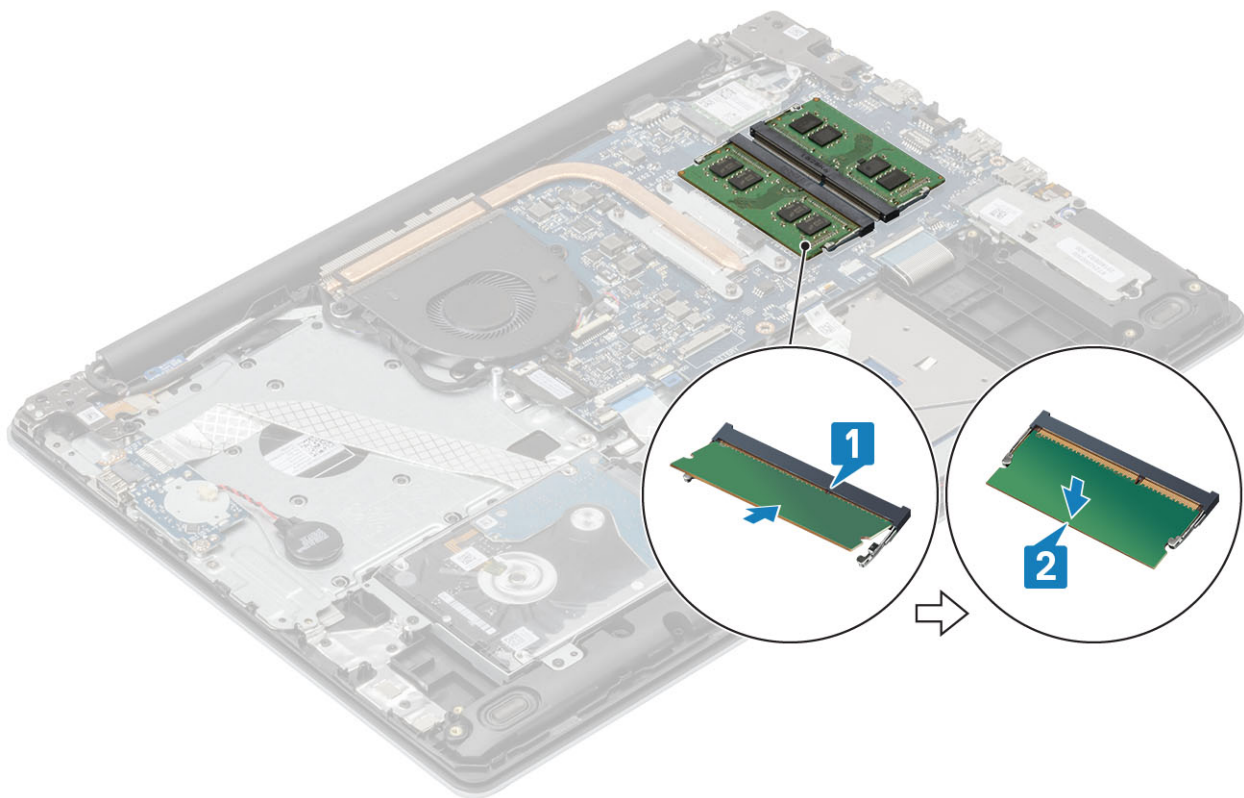

Next steps

1. Connect the battery cable to the connector on the system board.
2. Replace the [base cover](#)
3. Replace the [SD memory card](#)
4. Follow the procedure in [after working inside your computer](#)

WLAN card

Removing the WLAN card

Prerequisites

1. Follow the procedure in [before working inside your computer](#)
2. Remove the [SD memory card](#)
3. Remove the [base cover](#)
4. Disconnect the battery cable from the connector on the system board.

Steps

1. Remove the single (M2x3) screw that secures the WLAN card bracket to the system board [1].
2. Slide and remove the WLAN card bracket that secures the WLAN cables [2].
3. Disconnect the WLAN cables from the connectors on the WLAN card [3].
4. Lift the WLAN card away from the connector [4].

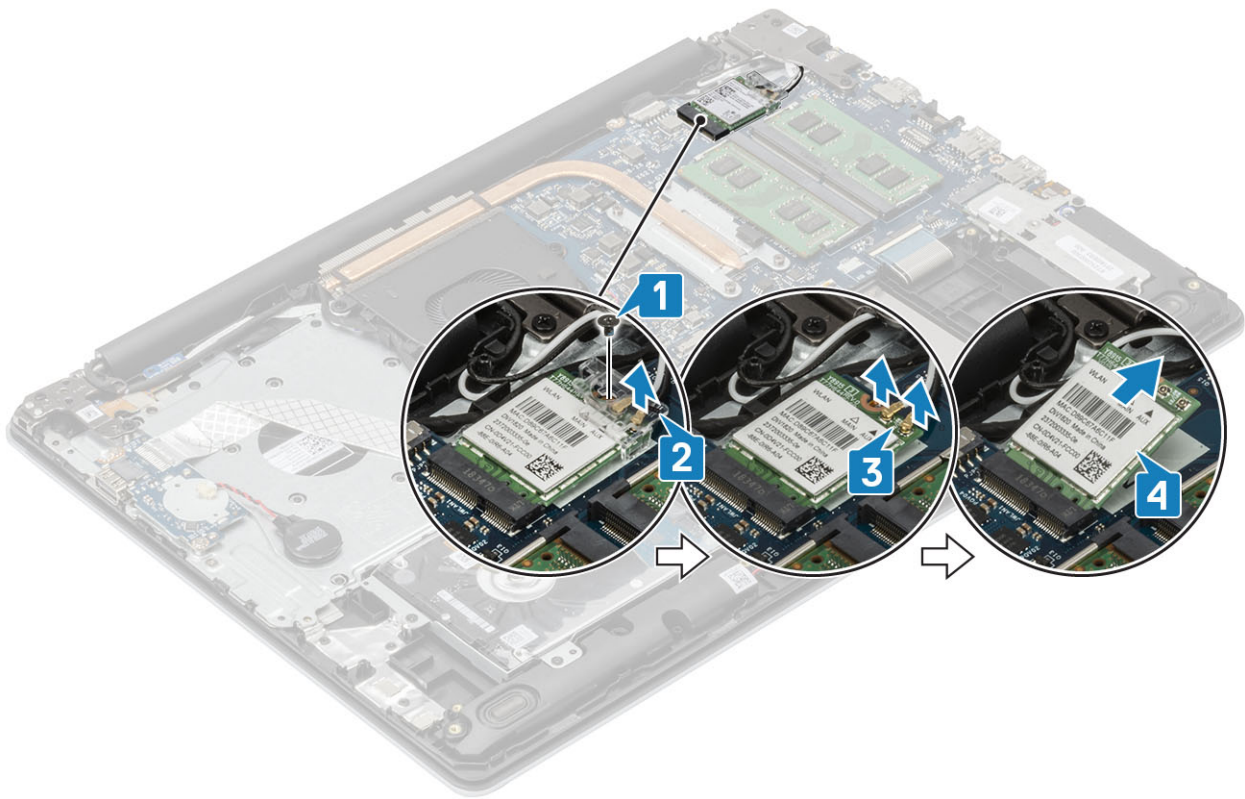

Installing the WLAN card

About this task

CAUTION: To avoid damage to the WLAN card, do not place any cables under it.

Steps

1. Insert the WLAN card into the connector on the system board [1].
2. Connect the WLAN cables to the connectors on the WLAN card [2].
3. Place the WLAN card bracket to secure the WLAN cables to the WLAN card [3].
4. Replace the single (M2x3) screw to secure the WLAN bracket to the WLAN card [4].

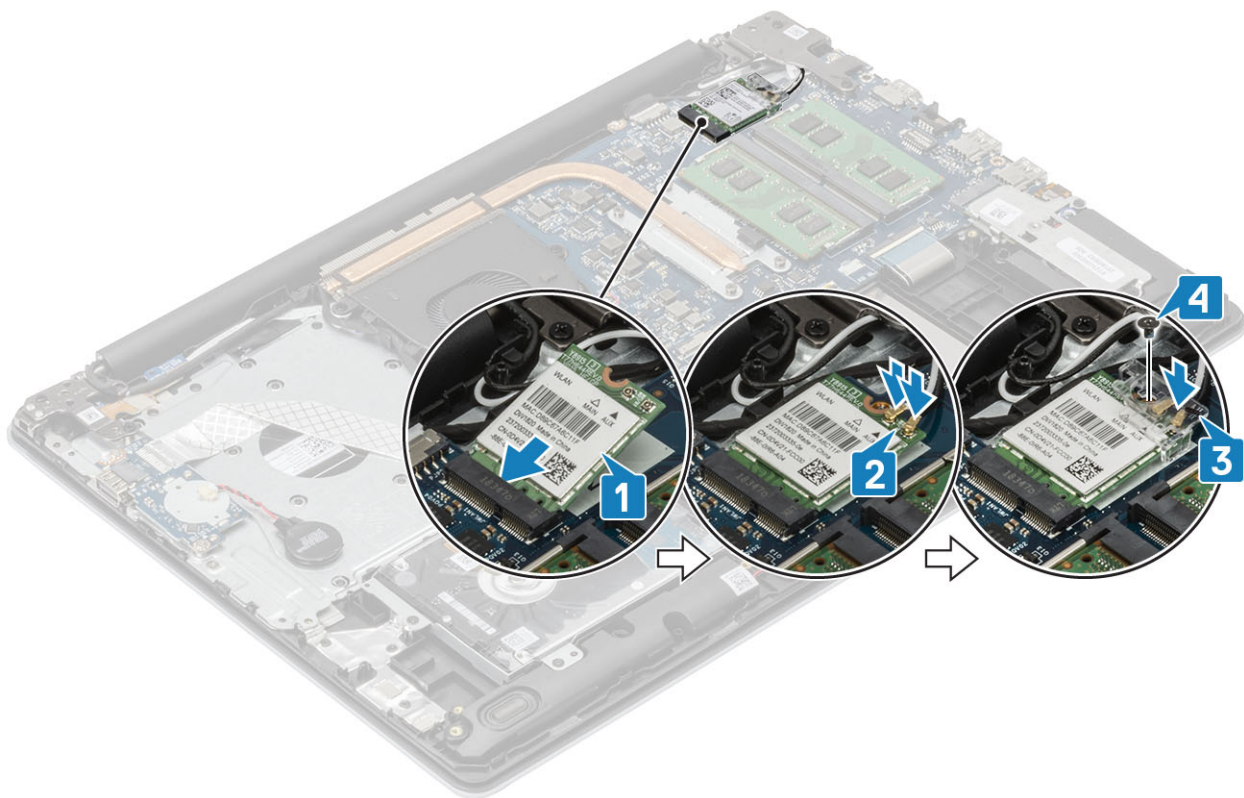

Next steps

1. Connect the battery cable to the connector on the system board.
2. Replace the [base cover](#)
3. Replace the [SD memory card](#)
4. Follow the procedure in [after working inside your computer](#)

Solid-state drive/Intel Optane

Removing the M.2 2230 Solid-state drive

Prerequisites

1. Follow the procedure in [before working inside your computer](#)
2. Remove the [SD memory card](#)
3. Remove the [base cover](#)
4. Disconnect the battery cable from the connector on the system board.

Steps

1. Loosen the captive screw that secures the thermal plate to the palmrest and keyboard assembly [1].
2. Remove the single (M2x3) screw that secures the thermal plate to the palmrest and keyboard assembly [2].
3. Slide and remove the thermal plate from the solid-state drive slot [3].

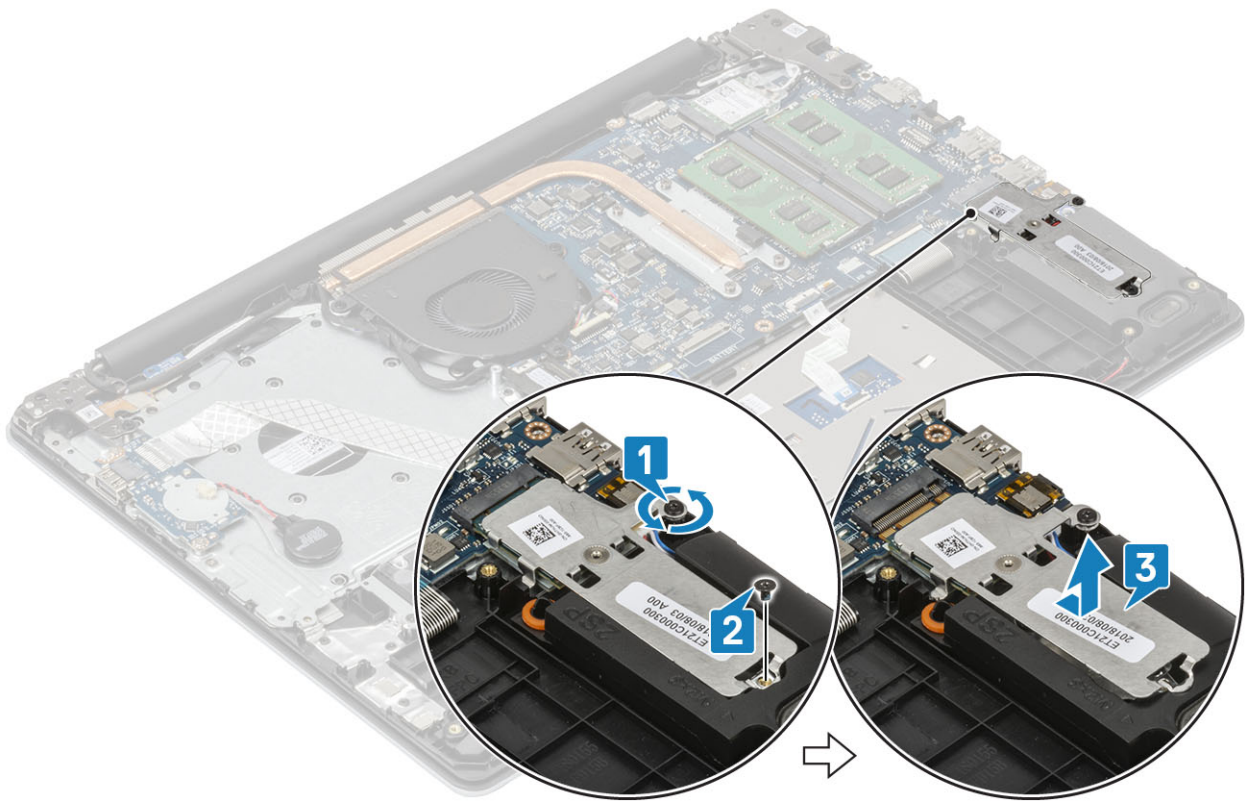

4. Turn the thermal plate over.
5. Remove the single (M2x2) screw that secures the solid-state drive to the thermal plate [1].
6. Lift the solid-state drive off the thermal plate [2].

Installing the M.2 2230 Solid-state drive

Steps

1. Place the solid-state drive into the thermal plate slot [1].
2. Replace the single (M2x2) screw that secures the solid-state drive to the thermal plate [2].

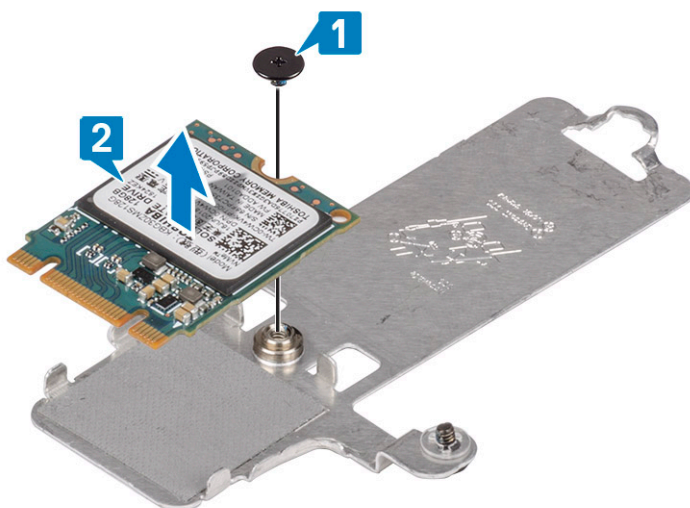

3. Align the notch on the solid-state drive with the tab on the solid-state drive slot.
4. Slide and insert the tab of the solid-state drive into the solid-state drive slot [1].
5. Tighten the captive screw that secures the thermal plate to the palmrest and keyboard assembly [2].

6. Replace the single (M2x3) screw that secures the thermal plate to the palmrest and keyboard assembly [3].

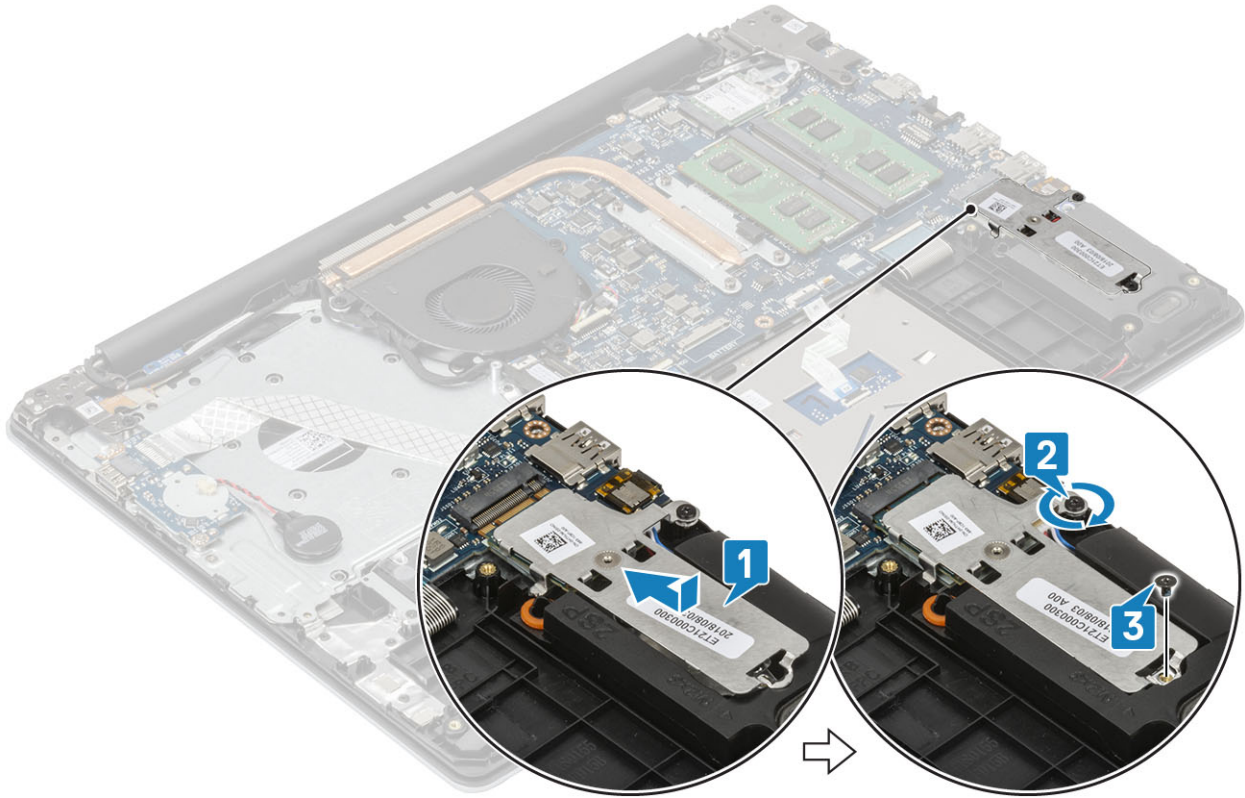

Next steps

1. Connect the battery cable to the connector on the system board.
2. Replace the [base cover](#)
3. Replace the [SD memory card](#)
4. Follow the procedure in [after working inside your computer](#)

Removing the M.2 2280 Solid-state drive or Intel Optane memory - Optional

Prerequisites

1. Follow the procedure in [before working inside your computer](#)
2. Remove the [SD memory card](#)
3. Remove the [base cover](#)
4. Disconnect the battery cable from the connector on the system board.

Steps

1. Loosen the captive screw that secures the thermal plate to the palmrest and keyboard assembly [1].
2. Remove the single (M2x3) screw that secures the thermal plate to the palmrest and keyboard assembly [2].
3. Slide and remove the thermal plate from the solid-state drive/Intel Optane slot [3].
4. Slide and lift the solid-state drive/Intel Optane off the palmrest and keyboard assembly [4].

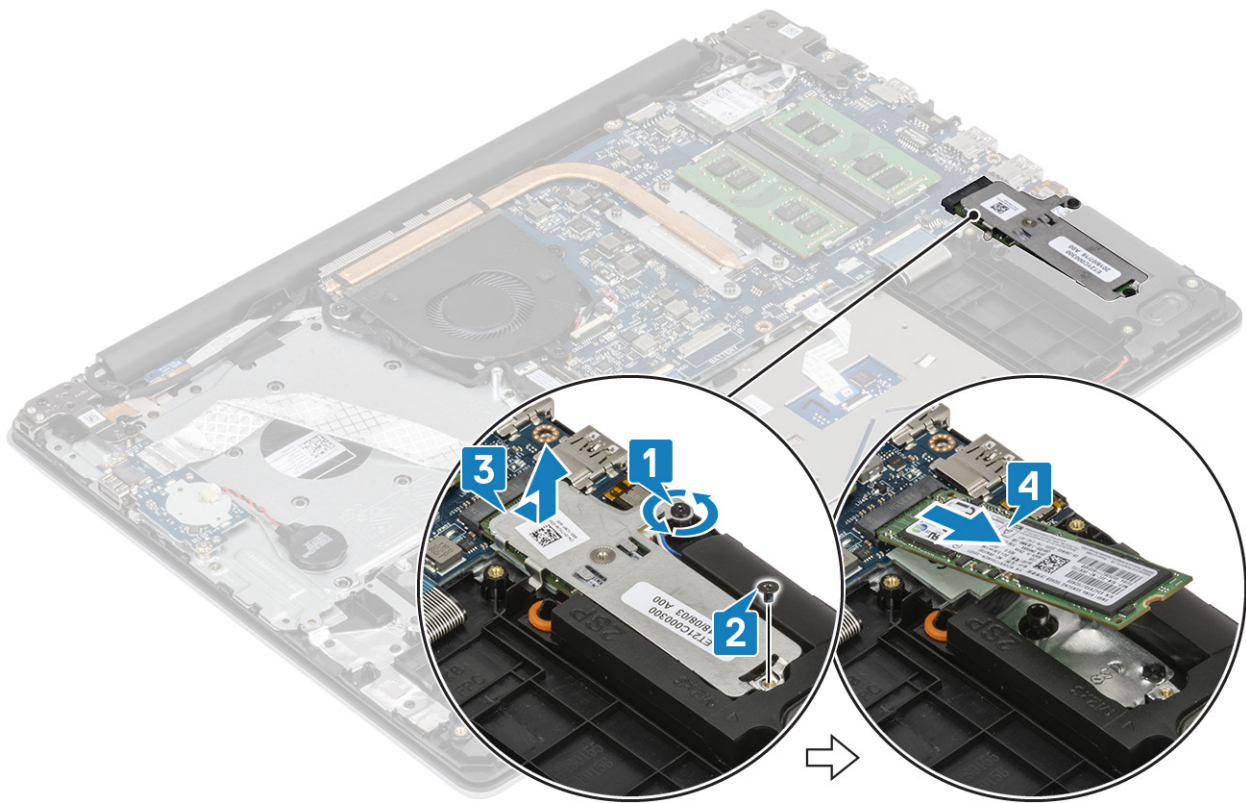

Installing the M.2 2280 Solid-state drive or Intel Optane memory - Optional

Steps

1. Slide and insert the tab of the solid-state drive/Intel Optane into the solid-state drive/Intel Optane slot [1, 2].
2. Tighten the captive screw that secures the thermal plate to the palmrest and keyboard assembly [3].
3. Replace the single (M2x3) screw that secures the thermal plate to the palmrest and keyboard assembly [4].

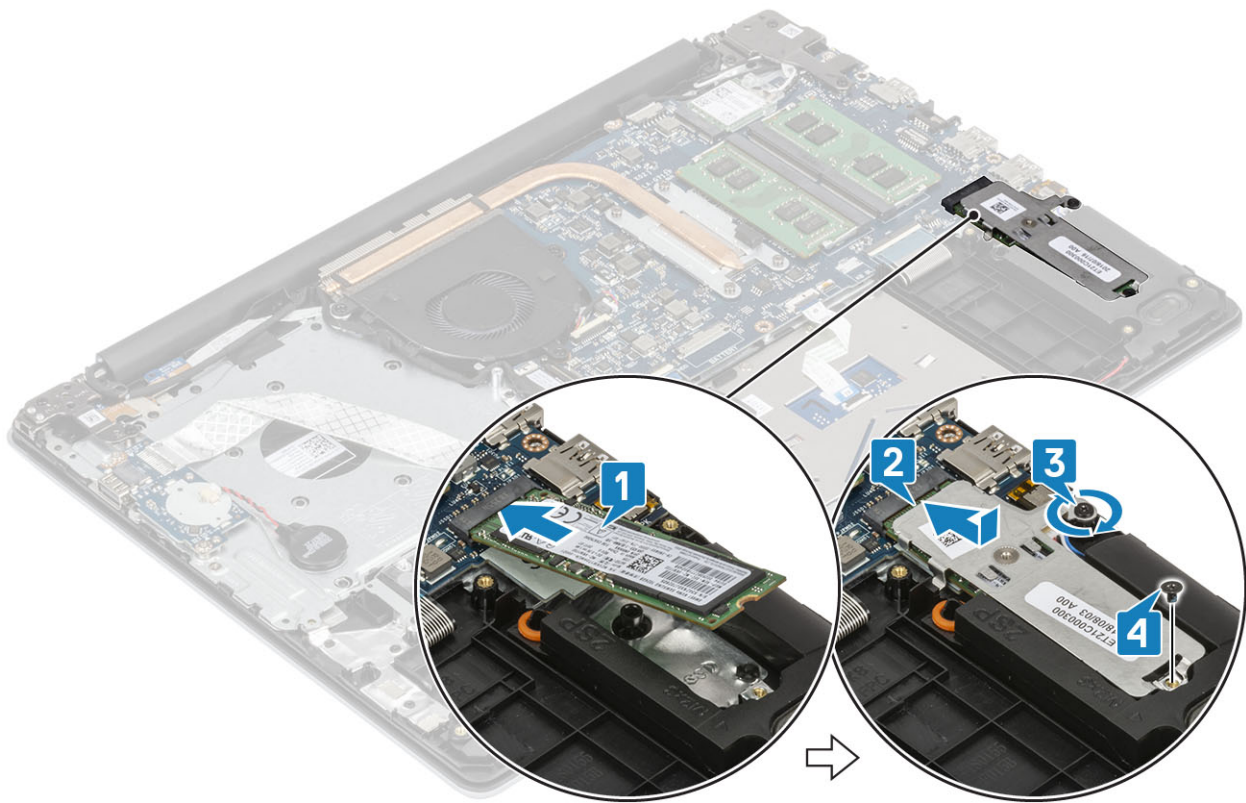

Next steps

1. Connect the battery cable to the connector on the system board.
2. Replace the [base cover](#)
3. Replace the [SD memory card](#)
4. Follow the procedure in [after working inside your computer](#)

Coin-cell battery

Removing the coin-cell

Prerequisites

1. Follow the procedure in [before working inside your computer](#)
2. Remove the [SD memory card](#)
3. Remove the [base cover](#)
4. Disconnect the battery cable from the connector on the system board.

Steps

1. Disconnect the coin-cell battery cable from the I/O board [1].
2. [2].

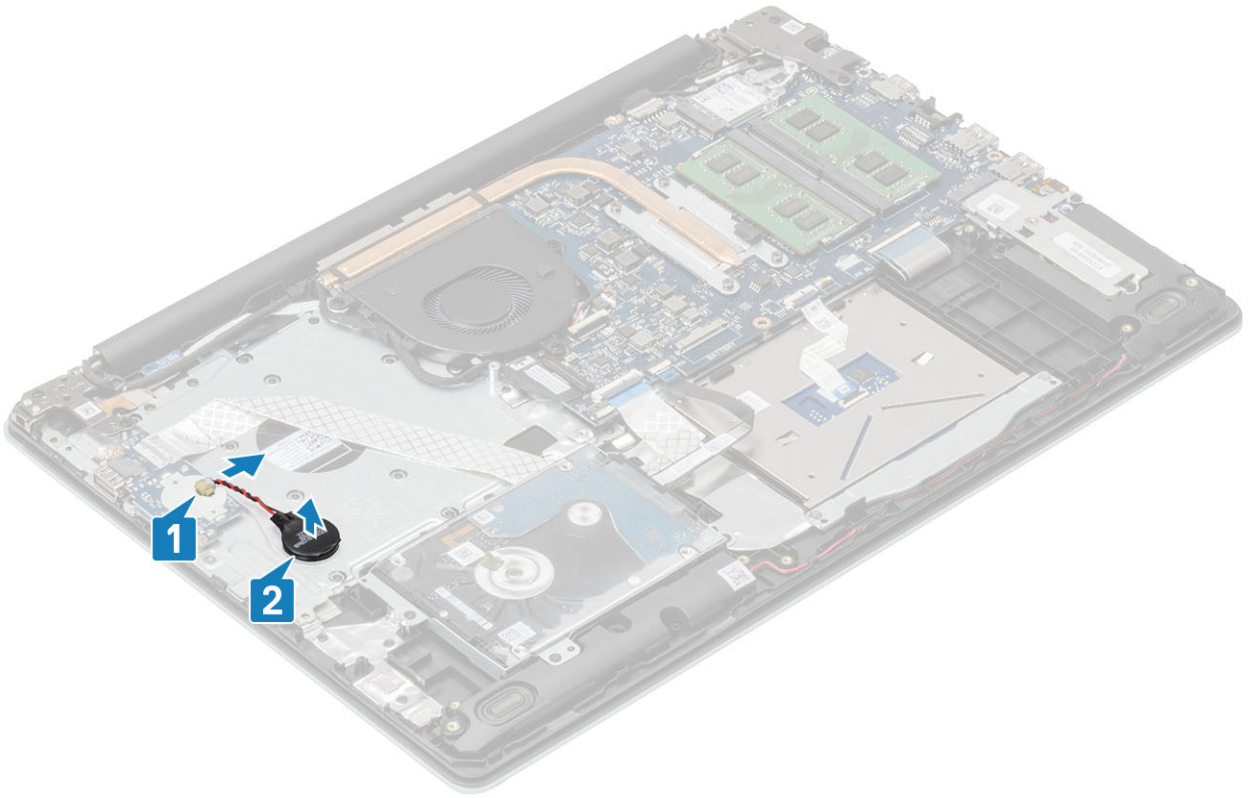

Installing the coin-cell battery

Steps

1. Connect the coin-cell battery cable to the I/O board [1].
2. Affix the coin cell battery on the palm rest and keyboard assembly [2].

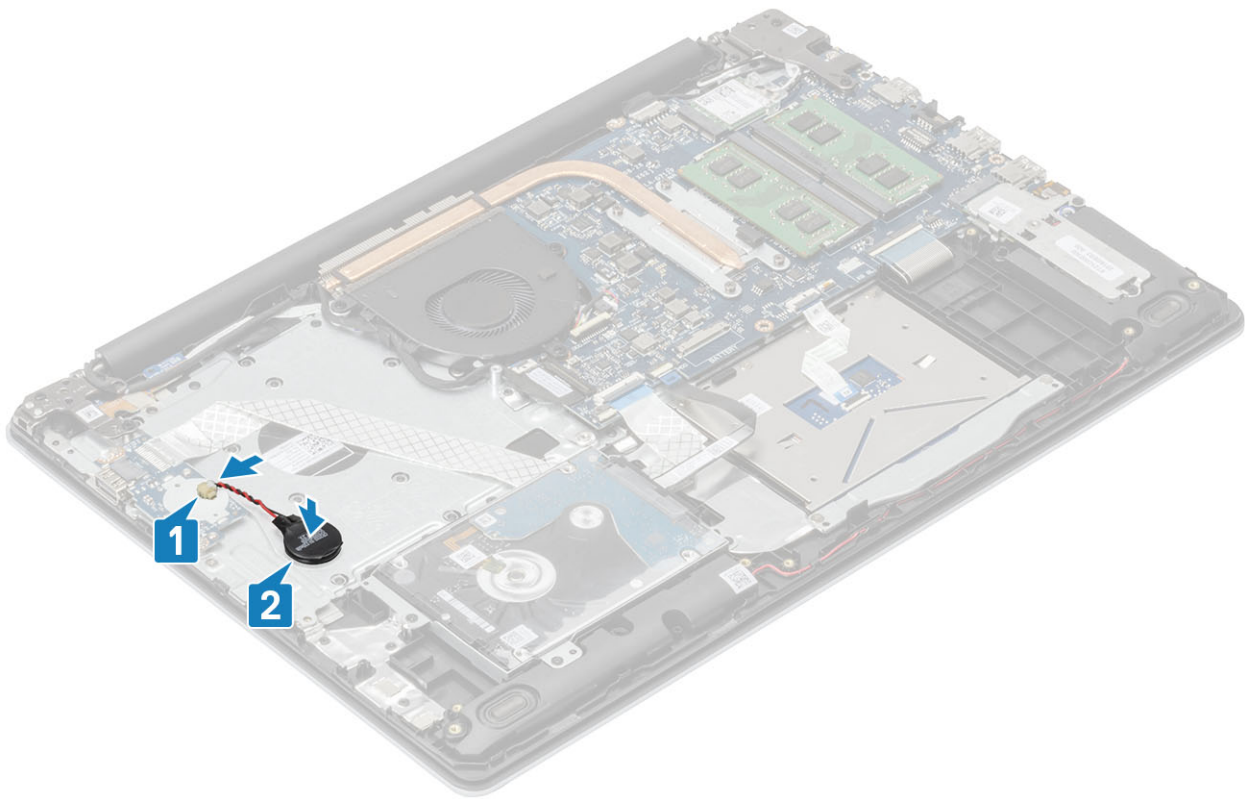

Next steps

1. Connect the battery cable to the connector on the system board.
2. Replace the [base cover](#)
3. Replace the [SD memory card](#)
4. Follow the procedure in [after working inside your computer](#)

Hard drive

Removing the hard drive assembly

Prerequisites

1. Follow the procedure in [before working inside your computer](#)
2. Remove the [SD memory card](#)
3. Remove the [base cover](#)
4. Remove the [battery](#)

Steps

1. Lift the latch and disconnect the hard drive cable from the system board [1].
2. Remove the four (M2x3) screws that secure the hard drive assembly to the palm rest and keyboard assembly [2].
3. Lift the hard drive assembly along with its cable off the palm rest and keyboard assembly [3].

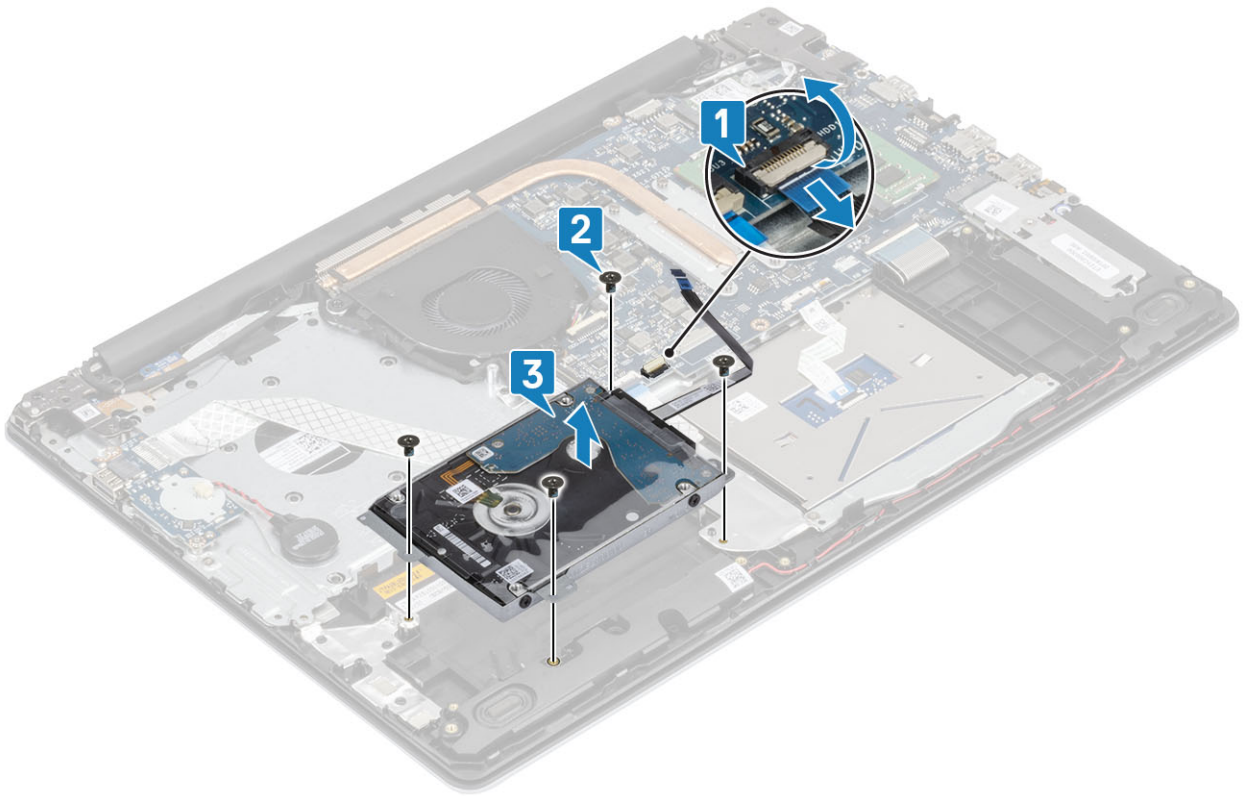

4. Disconnect the interposer from the hard drive.



5. Remove the four (M3x3) screws that secure the hard drive bracket to the hard drive [1].

6. Lift the hard drive bracket off the hard drive [2].

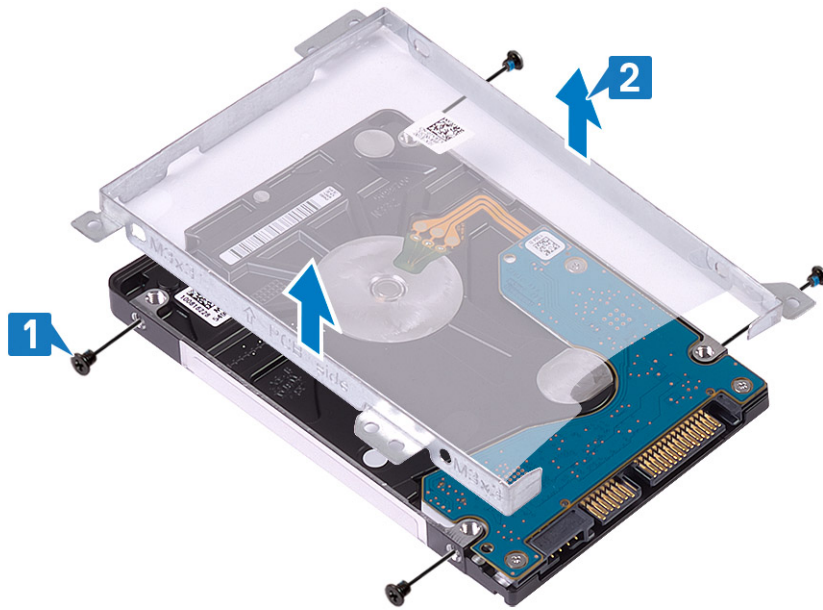

Installing the hard drive assembly

Steps

1. Align the screw holes on the hard drive bracket with the screw holes on the hard drive [1].
2. Replace the four (M3x3) screws that secure the hard drive bracket to the hard drive [2].

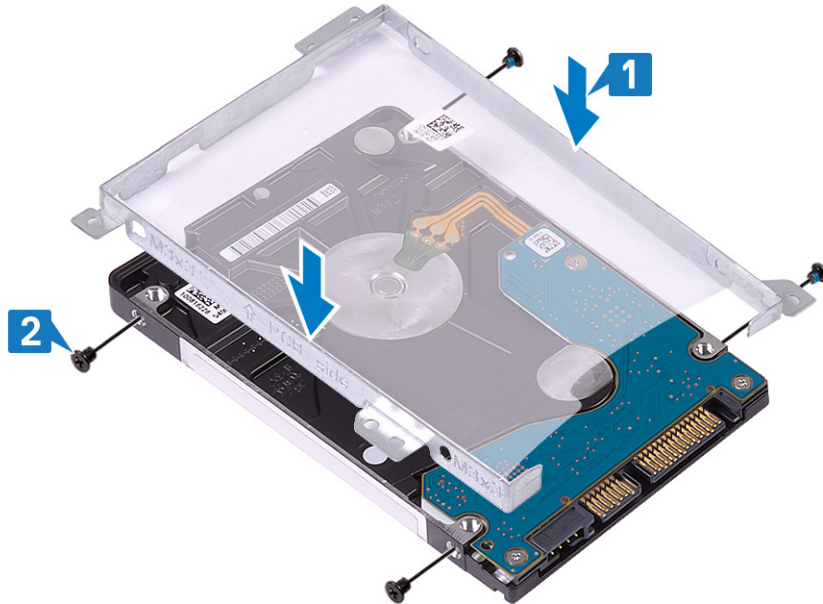

3. Connect the interposer to the hard drive.



4. Align the screw holes on the hard drive assembly with the screw holes on the palm rest and keyboard assembly [1].
5. Replace the four (M2x3) screws that secure the hard drive assembly to the palm rest and keyboard assembly [2].
6. Connect the hard drive cable to the system board and close the latch to secure the cable [3].

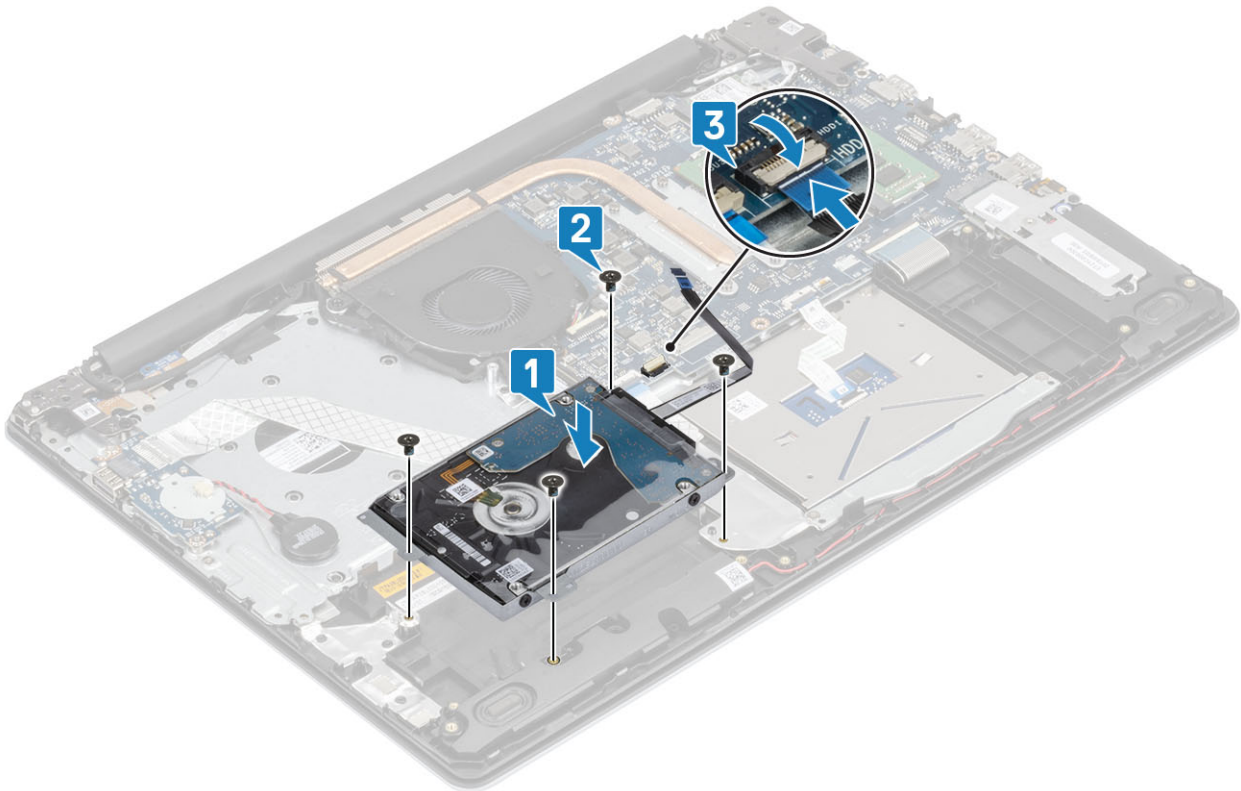

Next steps

1. Replace the [battery](#)
2. Replace the [base cover](#)
3. Replace the [SD memory card](#)
4. Follow the procedure in [after working inside your computer](#)

System fan

Removing the system fan

Prerequisites

1. Follow the procedure in [before working inside your computer](#)
2. Remove the [SD memory card](#)
3. Remove the [base cover](#)
4. Disconnect the battery cable from the connector on the system board.

Steps

1. Disconnect the display cable and fan cable from the system board [1, 2].

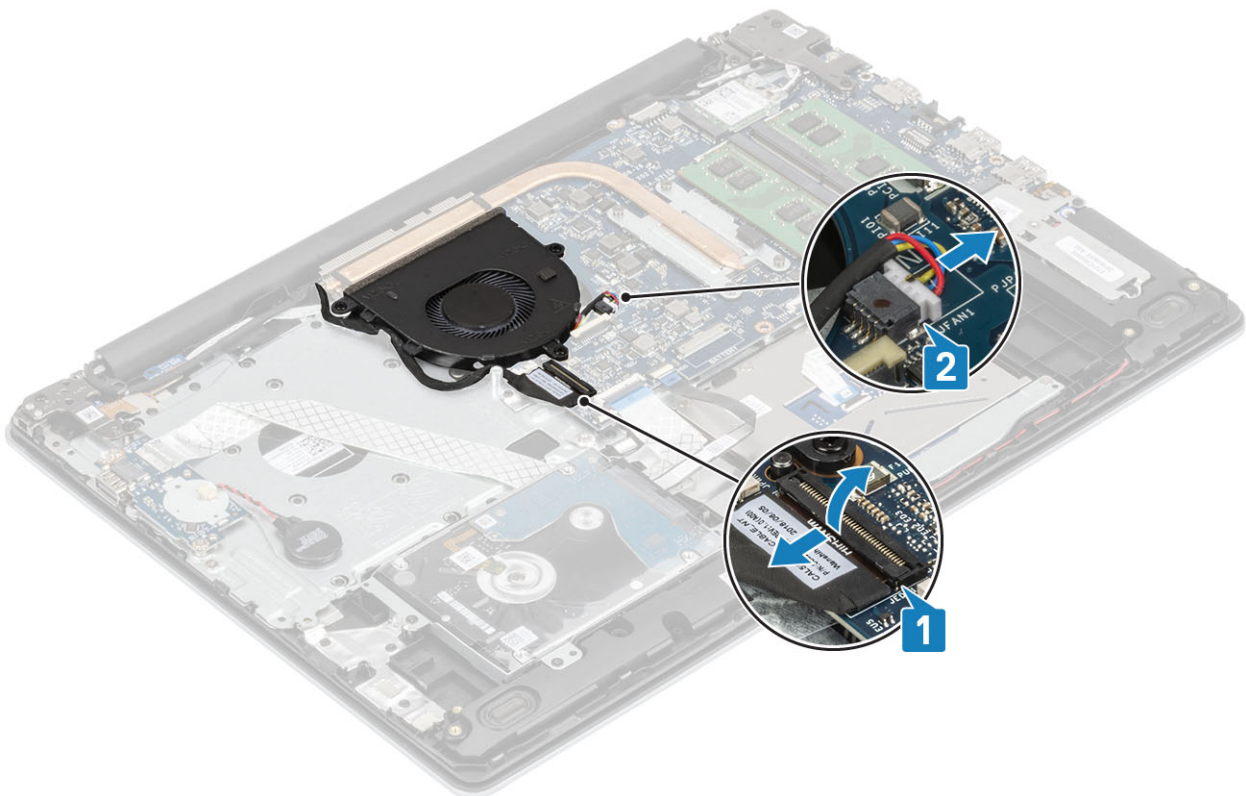

2. Unroute the display cable from the routing guides on the fan .

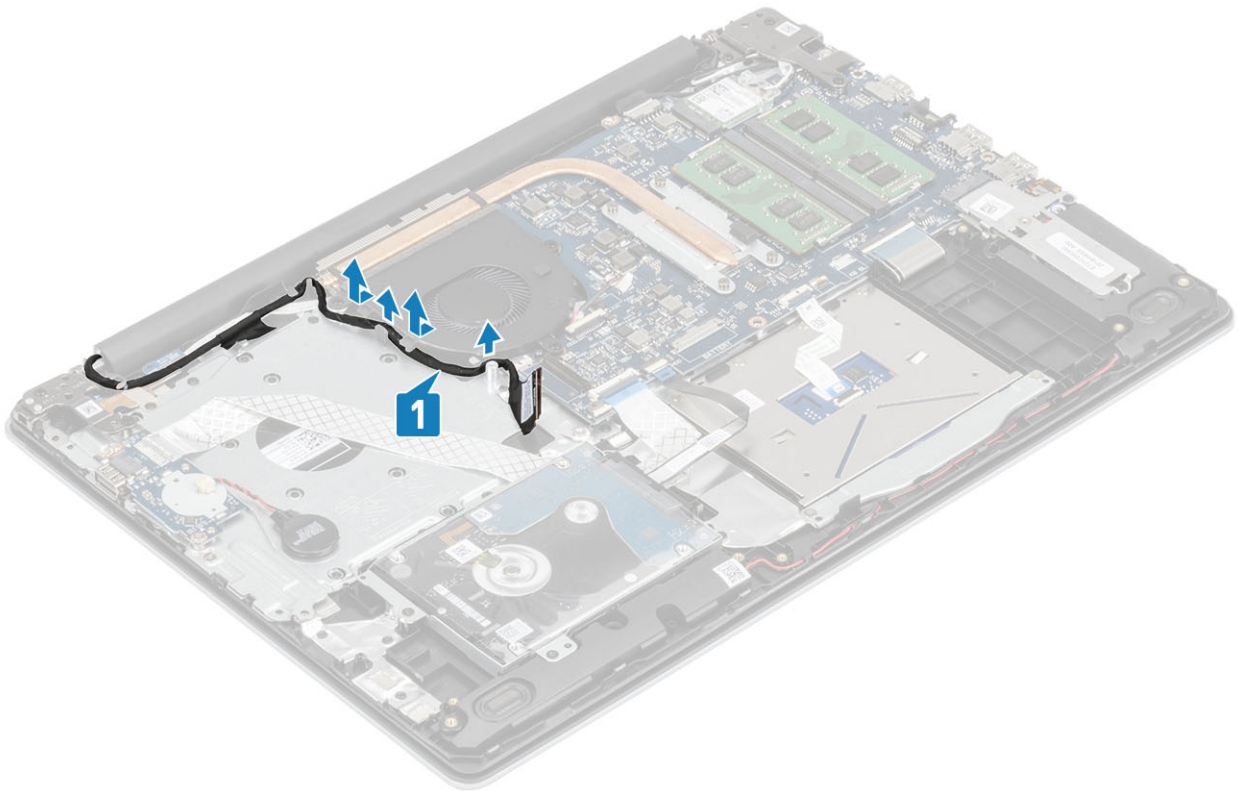

3. Remove the three (M2.5x5) screws that secure the fan to the palm rest and keyboard board assembly [1].
4. Lift the fan off the palm rest and keyboard board assembly [2].

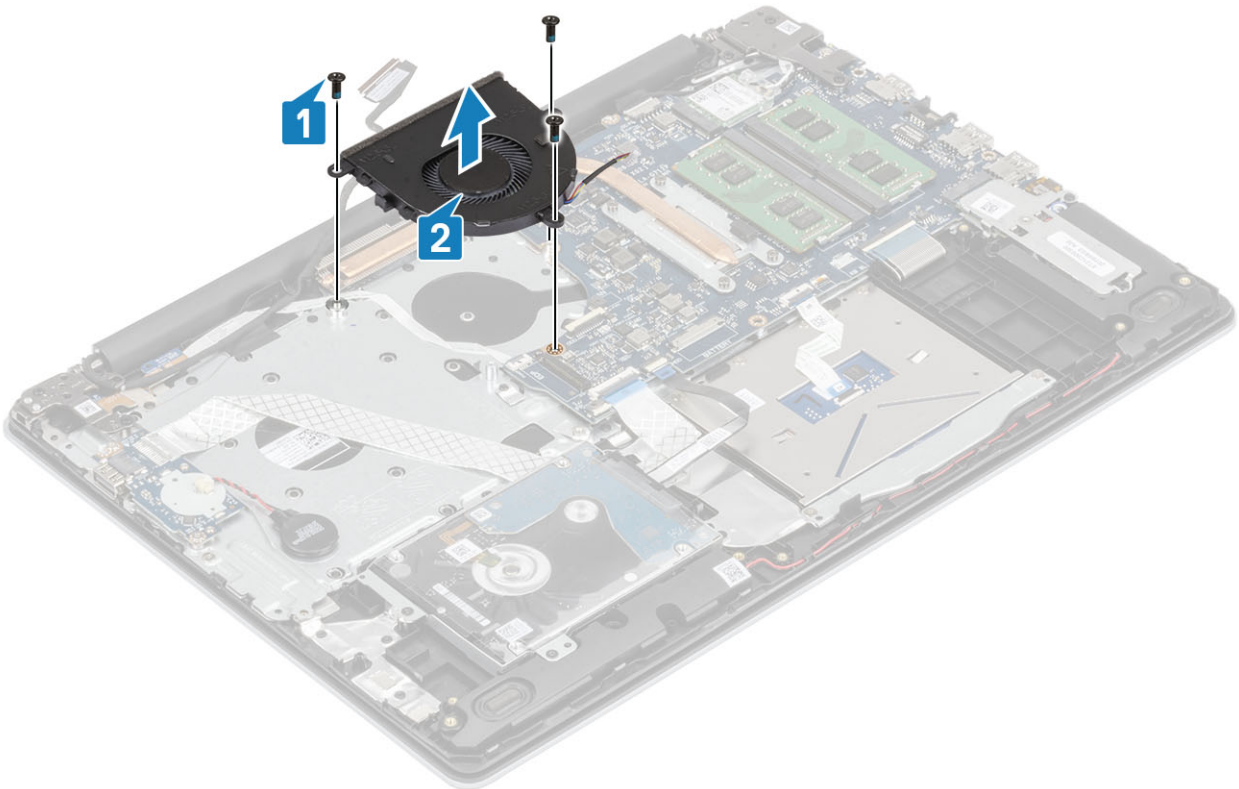

Installing the system fan

Steps

1. Align the screw holes on the fan with the screw holes on the palm rest and keyboard board assembly [1].
2. Replace the three (M2.5x5) screws that secure the fan to the palm rest and keyboard board assembly [2].

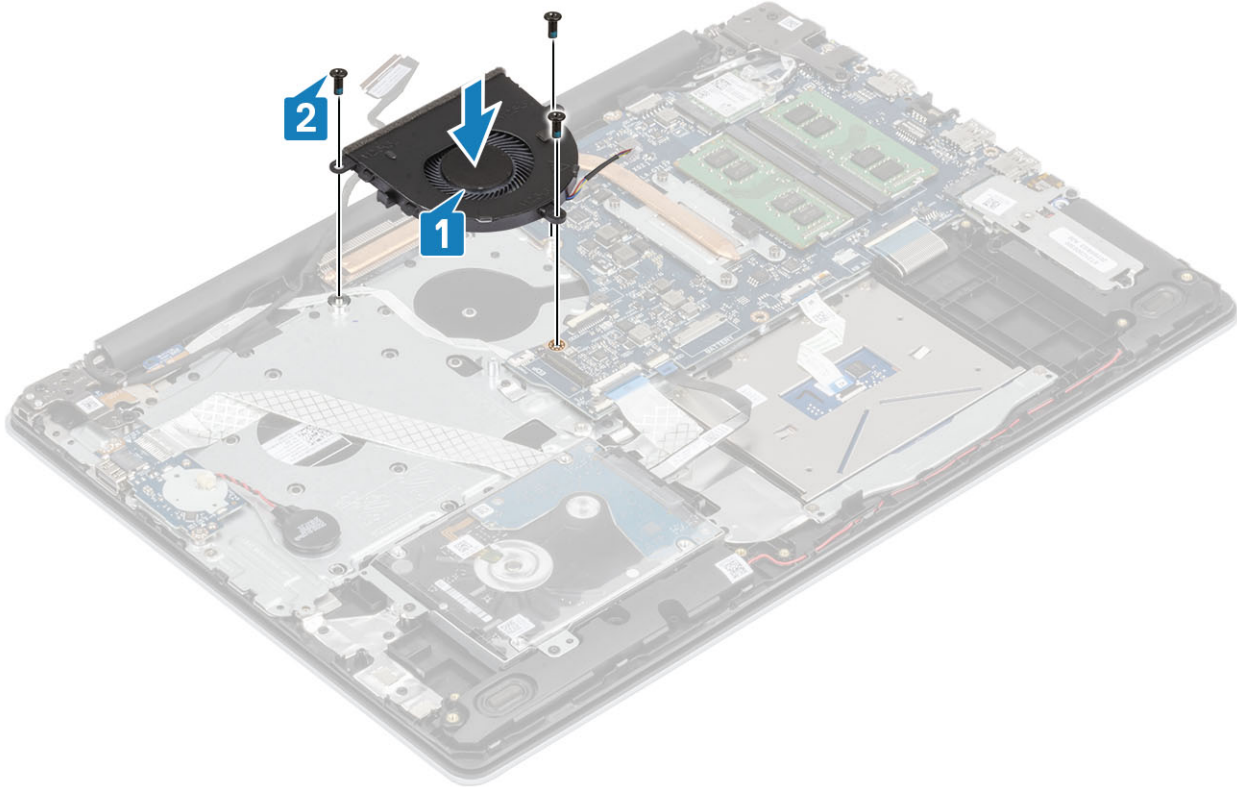

3. Route the display cable through the routing guides on the fan [1].

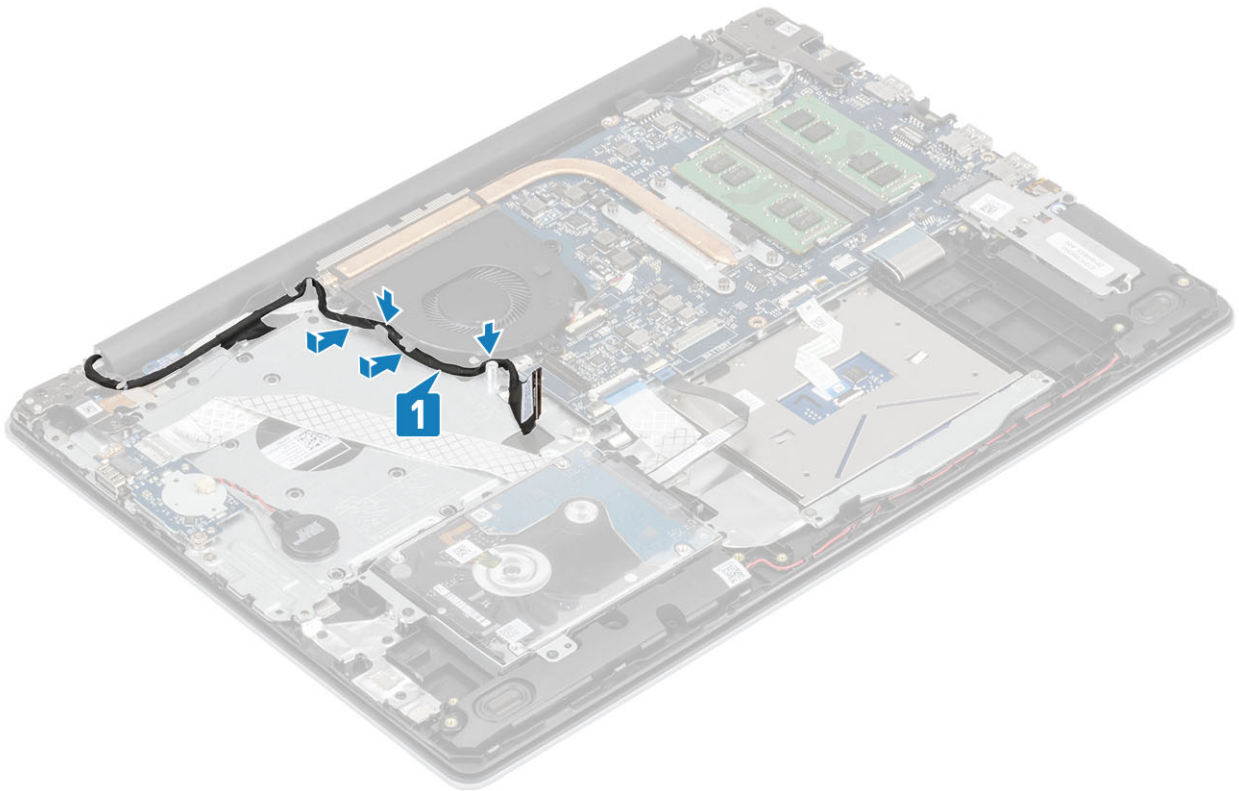

4. Connect the display cable and fan cable to the system board [1, 2].

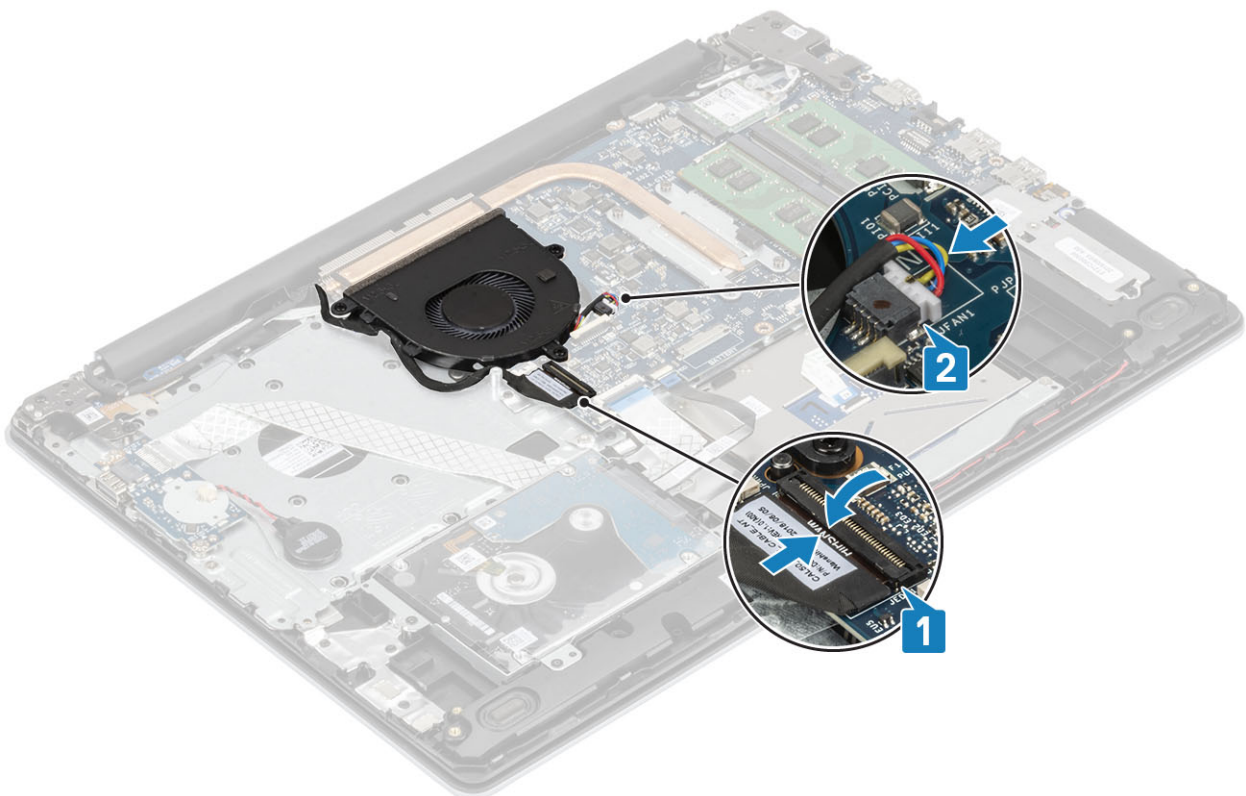

Next steps

1. Replace the [battery](#)
2. Replace the [base cover](#)
3. Replace the [SD memory card](#)

4. Follow the procedure in [after working inside your computer](#)

Heat sink

Removing the heatsink

Prerequisites

1. Follow the procedure in [before working inside your computer](#)
2. Remove the [SD memory card](#)
3. Remove the [base cover](#)
4. Remove the [battery](#)
5. Remove the [system fan](#)

Steps

1. Loosen the four captive screws that secure the heatsink to the system board [1].

NOTE: Loosen the screws in the order of the callout numbers [1, 2, 3, 4] as indicated on the heatsink.

2. Lift the heatsink off the system board [2].

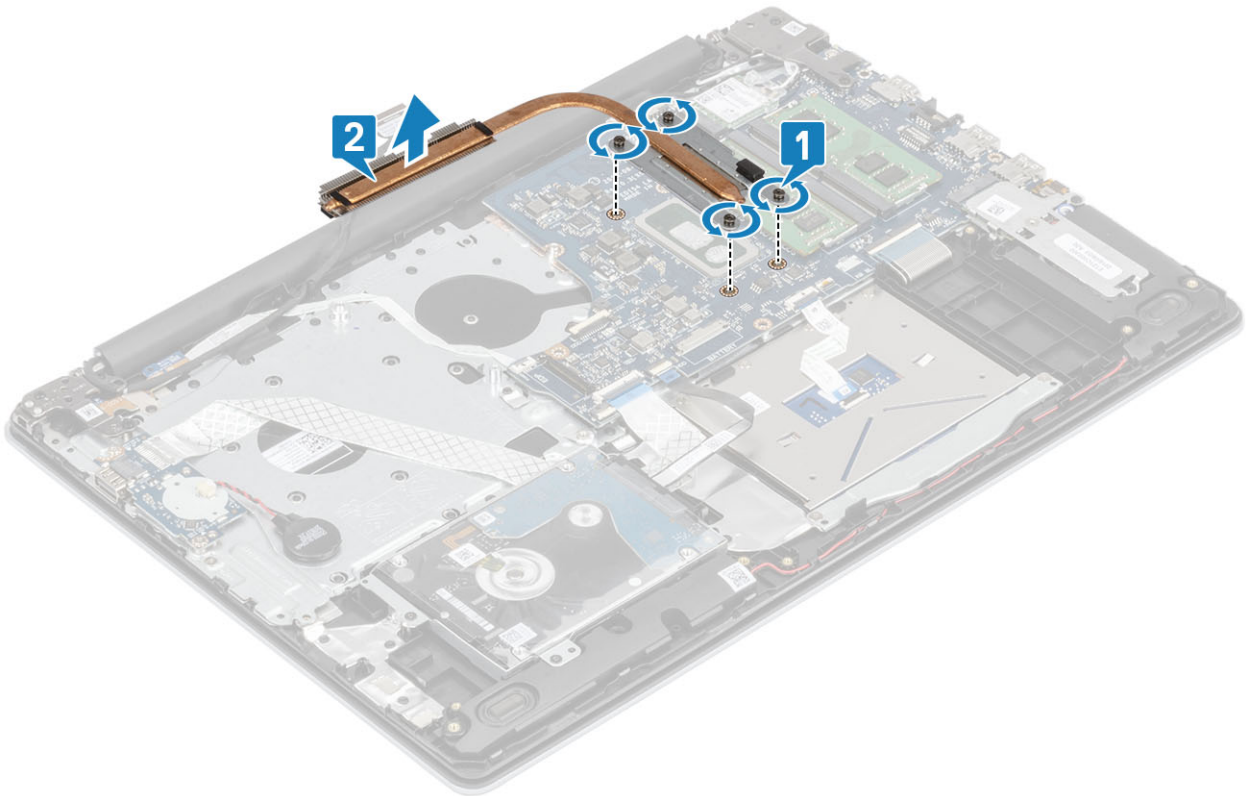

Installing the heatsink

Steps

1. Place the heatsink on the system board and align the screw holes on the heatsink with the screw holes on the system board [1].
2. In sequential order (as indicated on the heatsink), tighten the four captive screws that secure the heatsink to the system board [2].

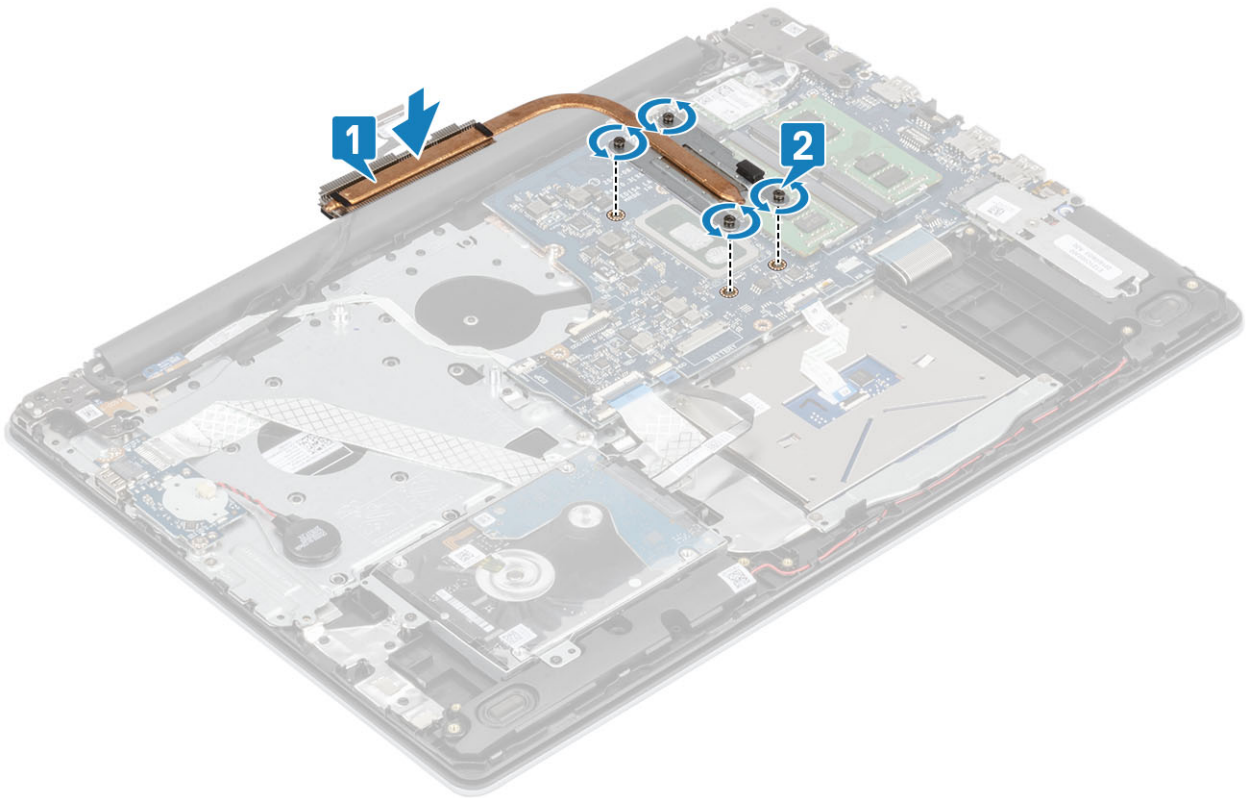

Next steps

1. Connect the battery cable to the connector on the system board.
2. Replace the [battery](#)
3. Replace the [base cover](#)
4. Replace the [SD memory card](#)
5. Follow the procedure in [after working inside your computer](#)

Speakers

Removing the speakers

Prerequisites

1. Follow the procedure in [before working inside your computer](#)
2. Remove the [SD memory card](#)
3. Remove the [base cover](#)
4. Remove the [battery](#)
5. Remove the [M.2 SSD](#)

Steps

1. Disconnect the speaker cable from the system board [1].
2. Unroute and remove the speaker cable from the routing guides on palm rest and keyboard assembly [2].
3. Lift the speakers, along with the cable, off the palm rest and keyboard assembly [3].

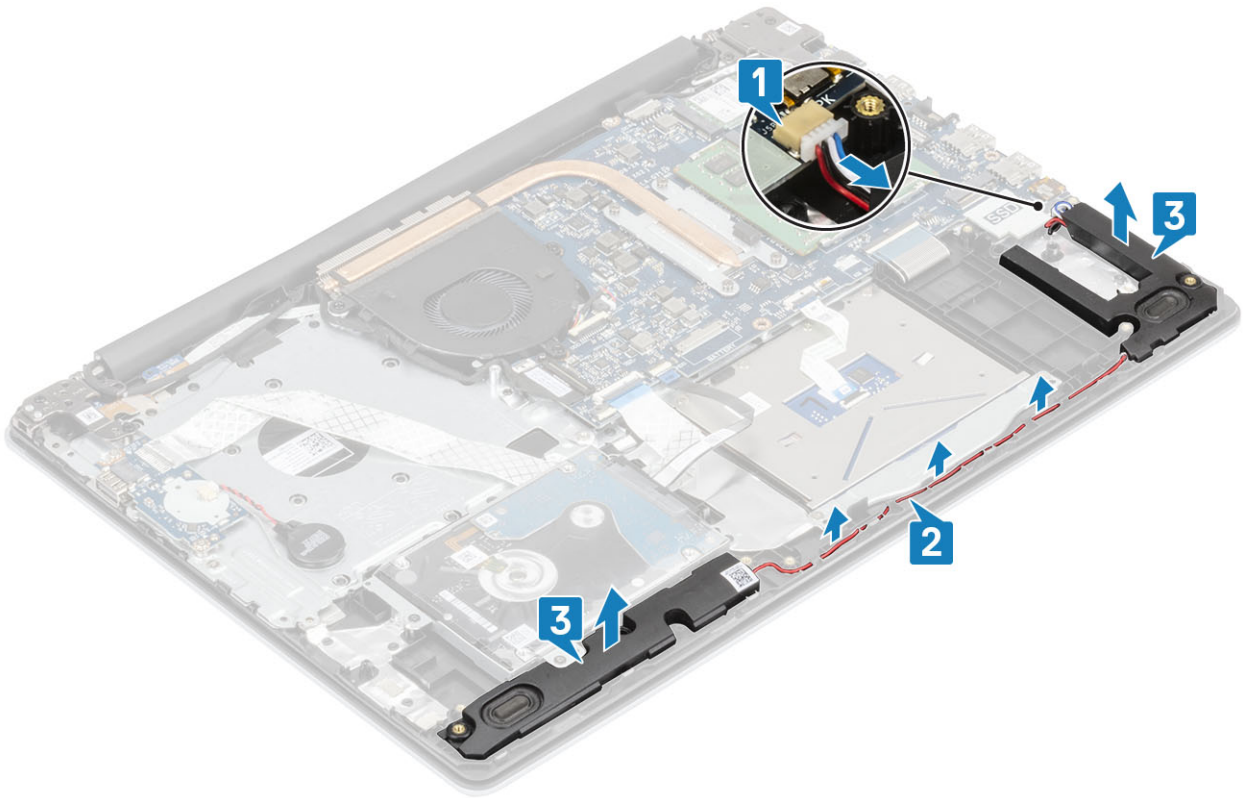

Installing the speakers

About this task

NOTE: If the rubber grommets are pushed out when removing the speakers, push them back in before replacing the speakers.

Steps

1. Using the alignment posts and rubber grommets, place the speakers in the slots on the palm rest and keyboard assembly [1].
2. Route the speaker cable through the routing guides on the palm rest and keyboard assembly [2].
3. Connect the speaker cable to the system board [3].

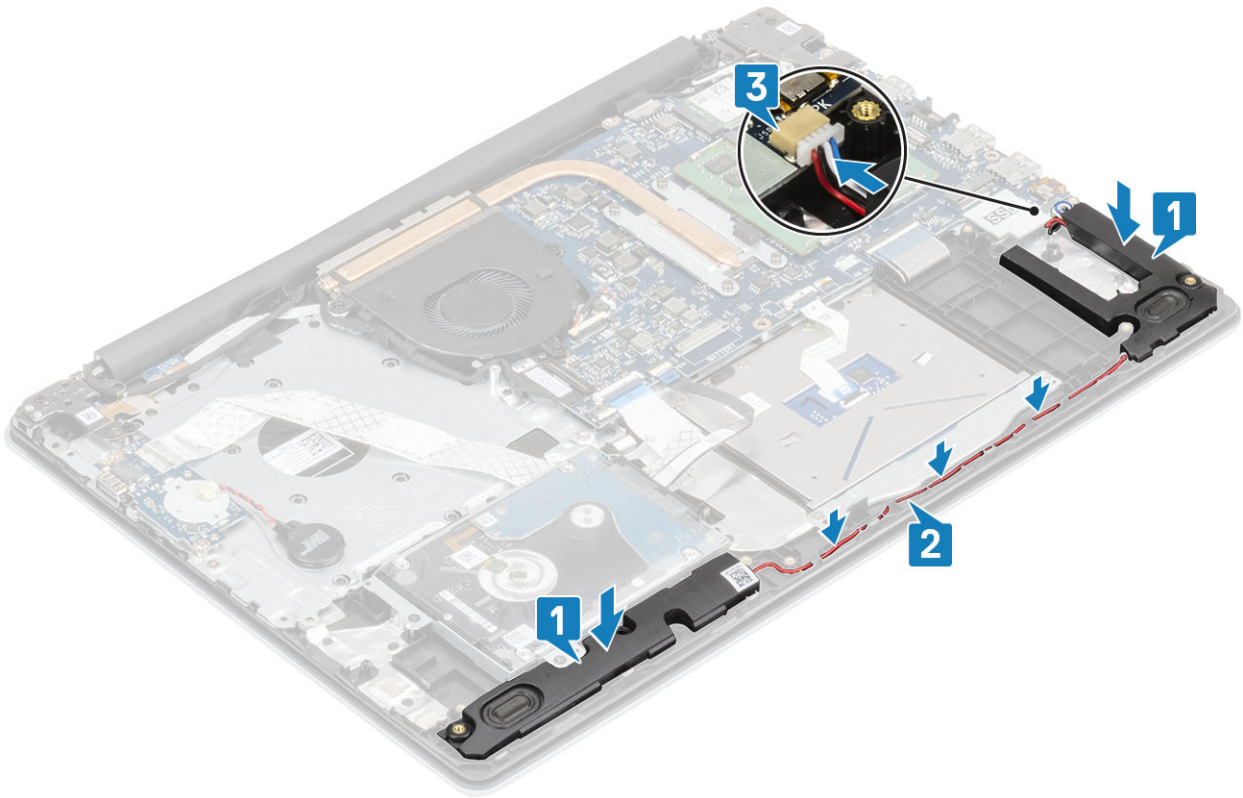

Next steps

1. Replace the [M.2 SSD](#)
2. Replace the [battery](#)
3. Replace the [base cover](#)
4. Replace the [SD memory card](#)
5. Follow the procedure in [after working inside your computer](#)

IO board

Removing the IO board

Prerequisites

1. Follow the procedure in [before working inside your computer](#)
2. Remove the [SD memory card](#)
3. Remove the [base cover](#)
4. Remove the [battery](#)
5. Remove the [hard drive assembly](#)

Steps

1. Disconnect the coin-cell battery cable from the I/O board [1].
2. Open the latch and disconnect the I/O board cable from the system board [2].

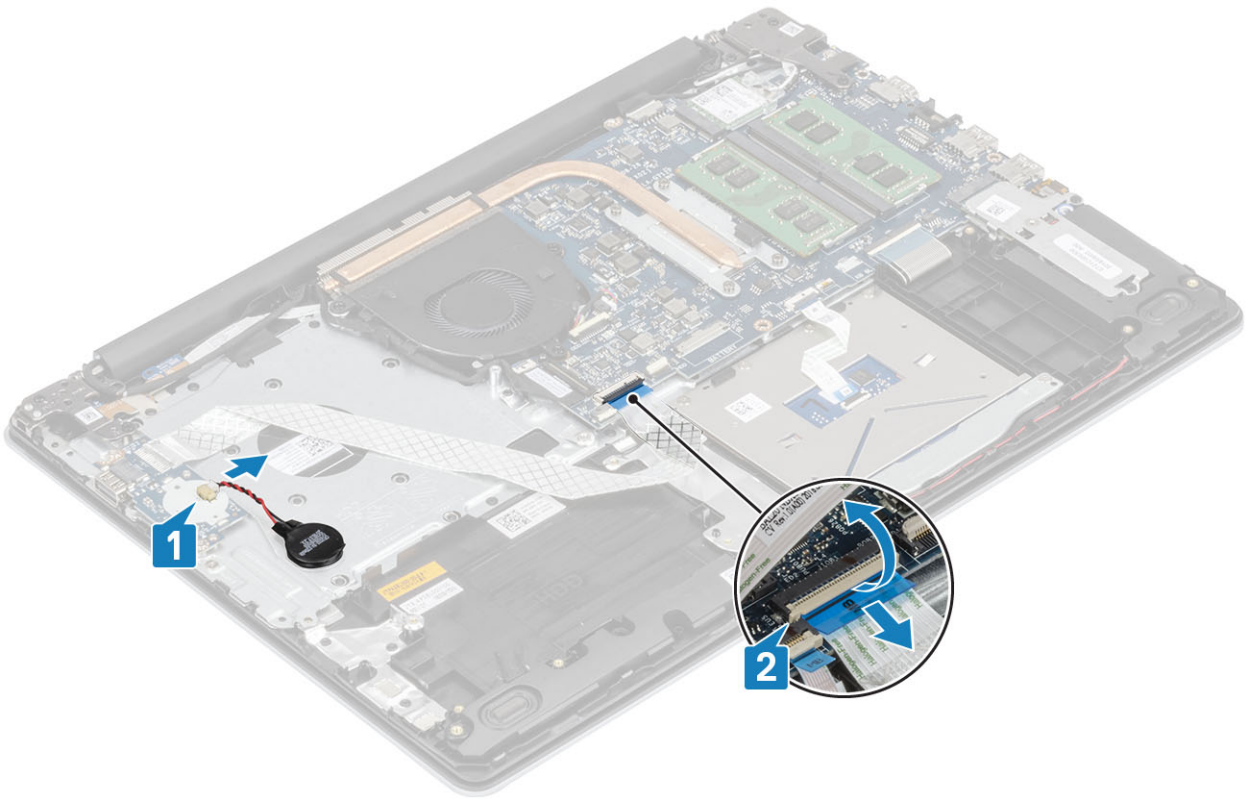

3. Remove the two (M2x4) screws that secure the I/O board to the palm rest and keyboard assembly [1].
4. Lift the I/O board, along with the cable, off the palm rest and keyboard assembly [2].

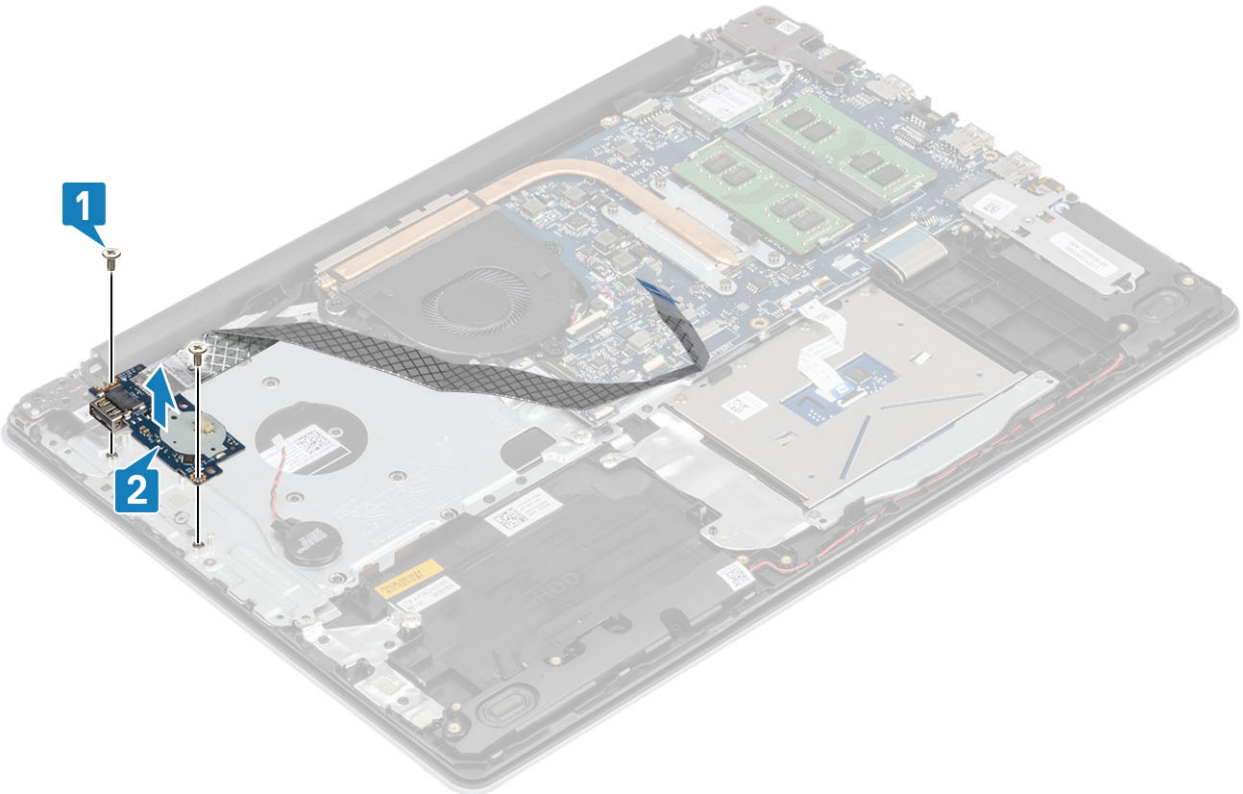

Installing the I/O board

Steps

1. Using the alignment posts, place the I/O board on the palm rest and keyboard assembly [1].
2. Replace the two (M2x4) screws that secure the I/O board to the palm rest and keyboard assembly [2].

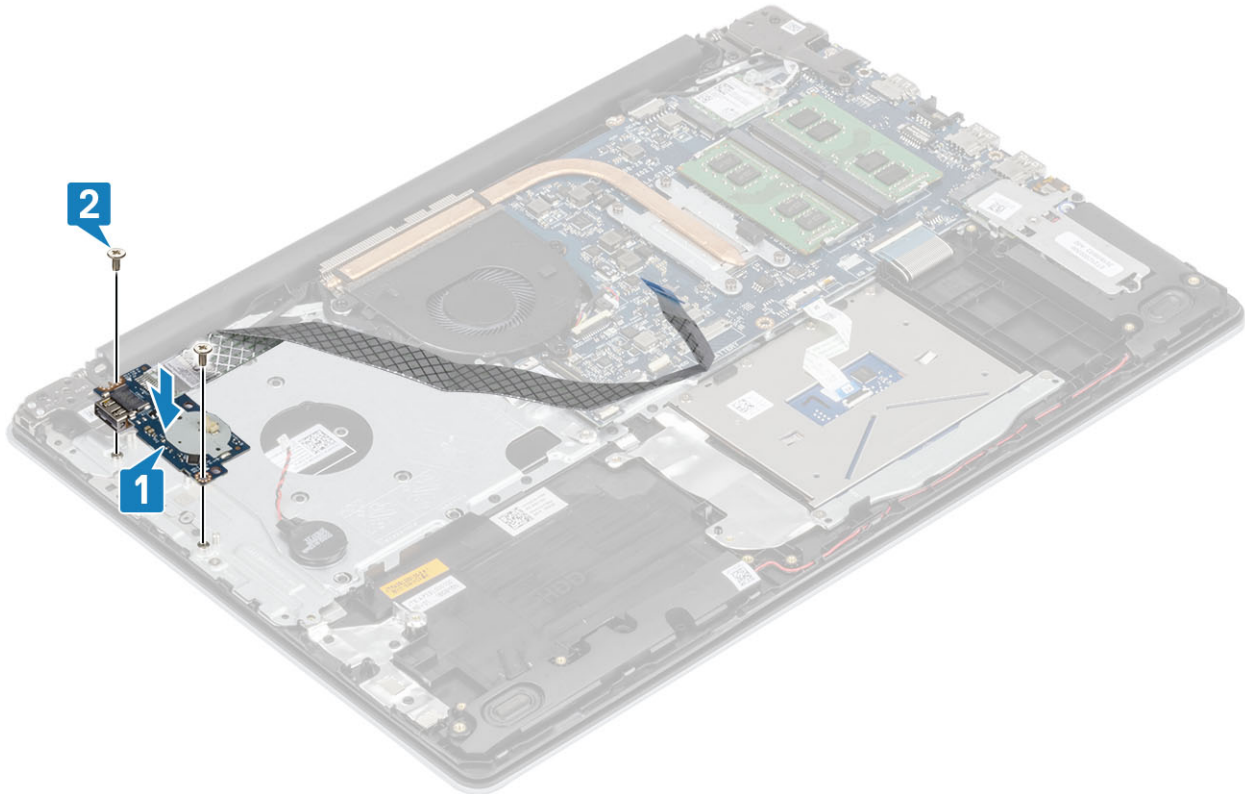

3. Connect the coin-cell battery cable to the I/O board [1].
4. Connect the I/O board cable to the system board and close the latch to secure the cable [2].

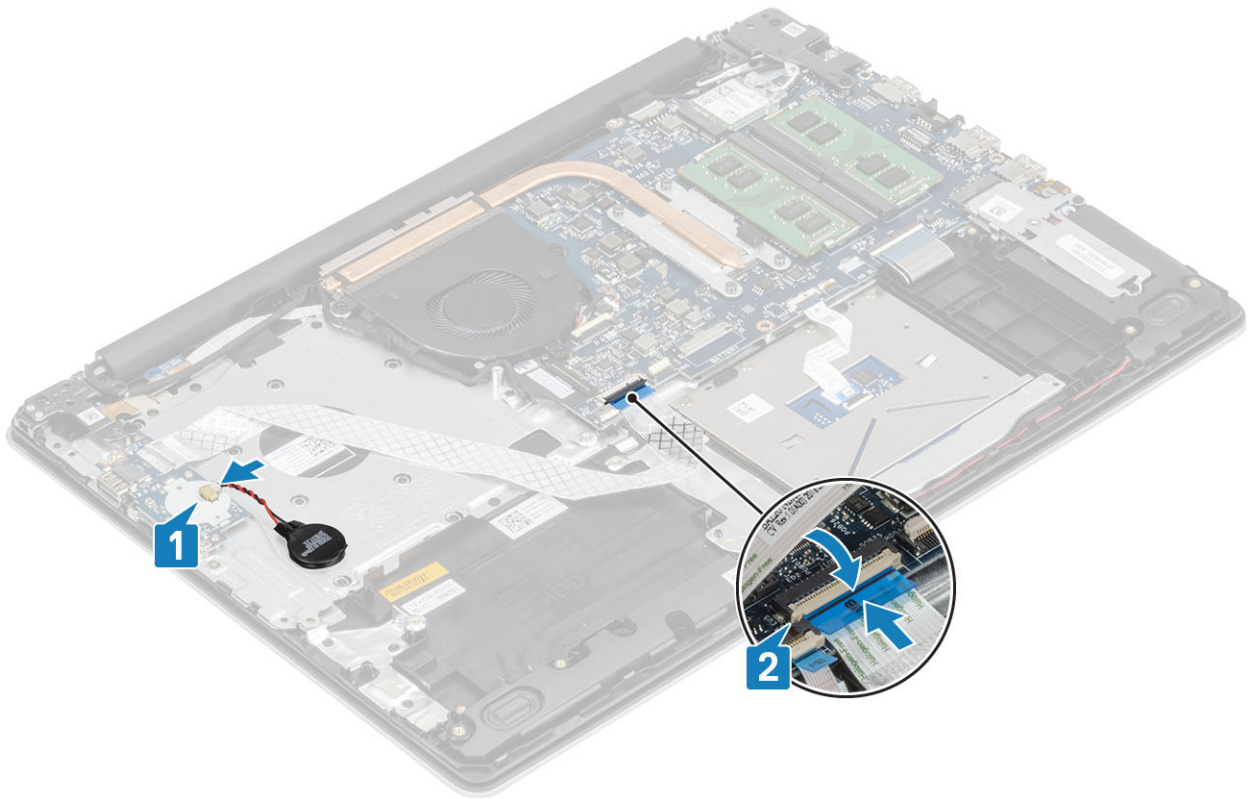

Next steps

1. Replace the [hard drive assembly](#)
2. Replace the [battery](#)
3. Replace the [base cover](#)
4. Replace the [SD memory card](#)
5. Follow the procedure in [after working inside your computer](#)

Touchpad

Removing the touch pad assembly

Prerequisites

1. Follow the procedure in [before working inside your computer](#)
2. Remove the [SD memory card](#)
3. Remove the [base cover](#)
4. Remove the [battery](#)

Steps

1. Open the latch and disconnect the hard drive cable and touch pad cable from the system board [1, 2].
2. Peel the tape that secures the touch pad to the palmrest and keyboard assembly [3].

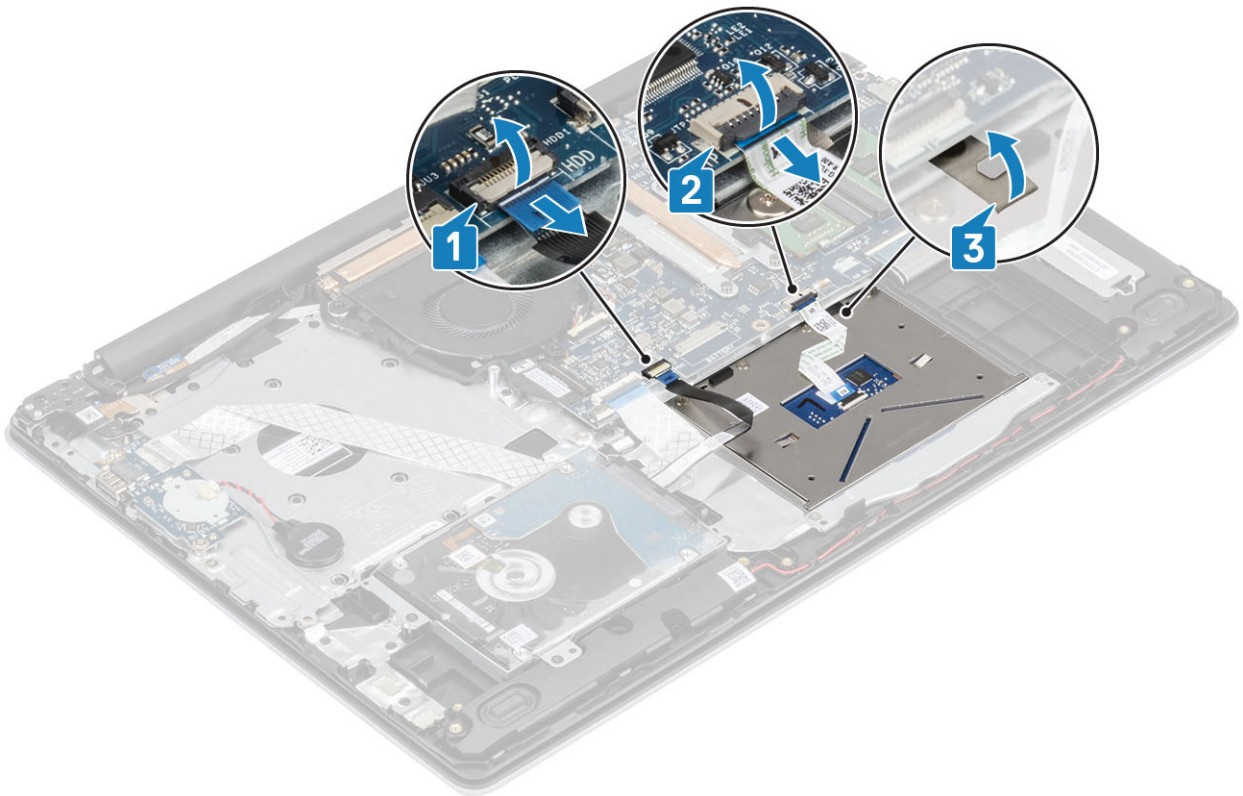

3. Remove the two (M2x2) screws that secure the touch pad bracket to the palmrest and keyboard assembly [1].
4. Lift the touch pad bracket off the palm rest and keyboard assembly [2].

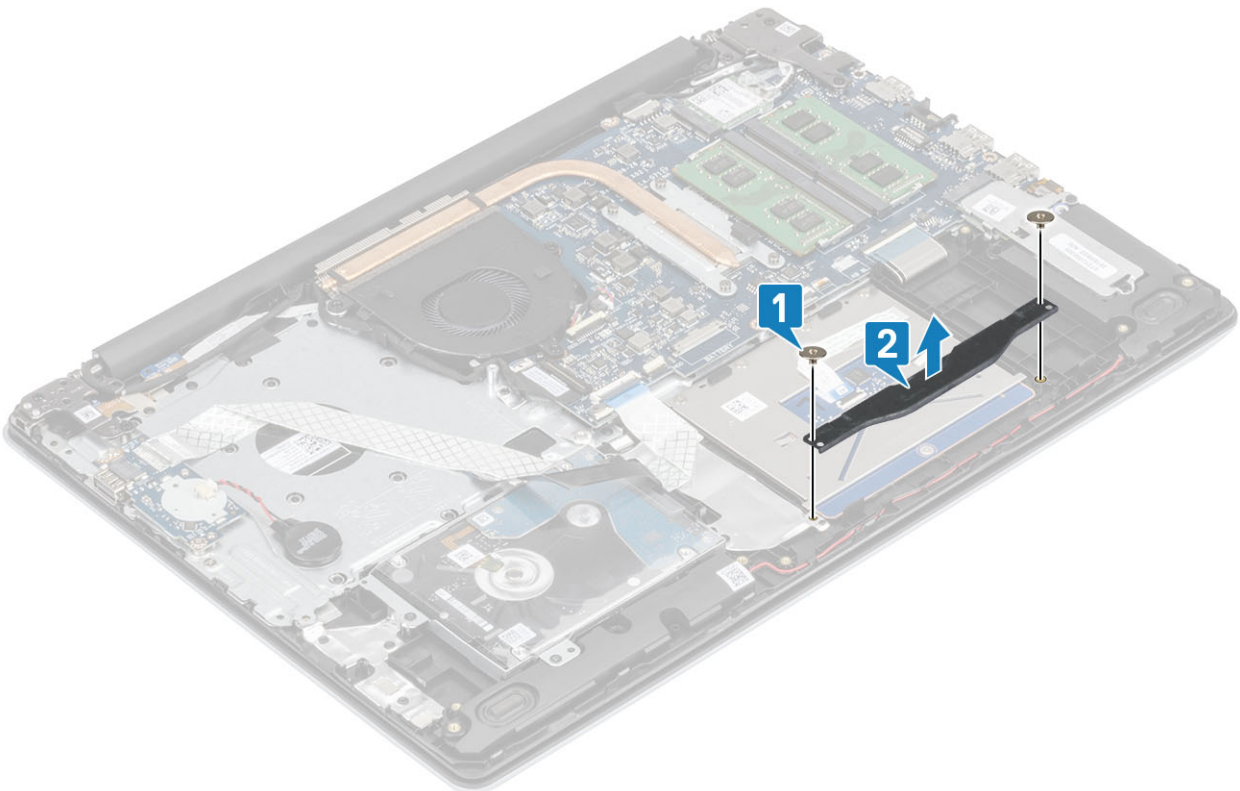

5. Remove the four (M2x2) screws that secure the touch pad to the palmrest and keyboard assembly [1].
6. Lift the touch pad off the palmrest and keyboard assembly [2].

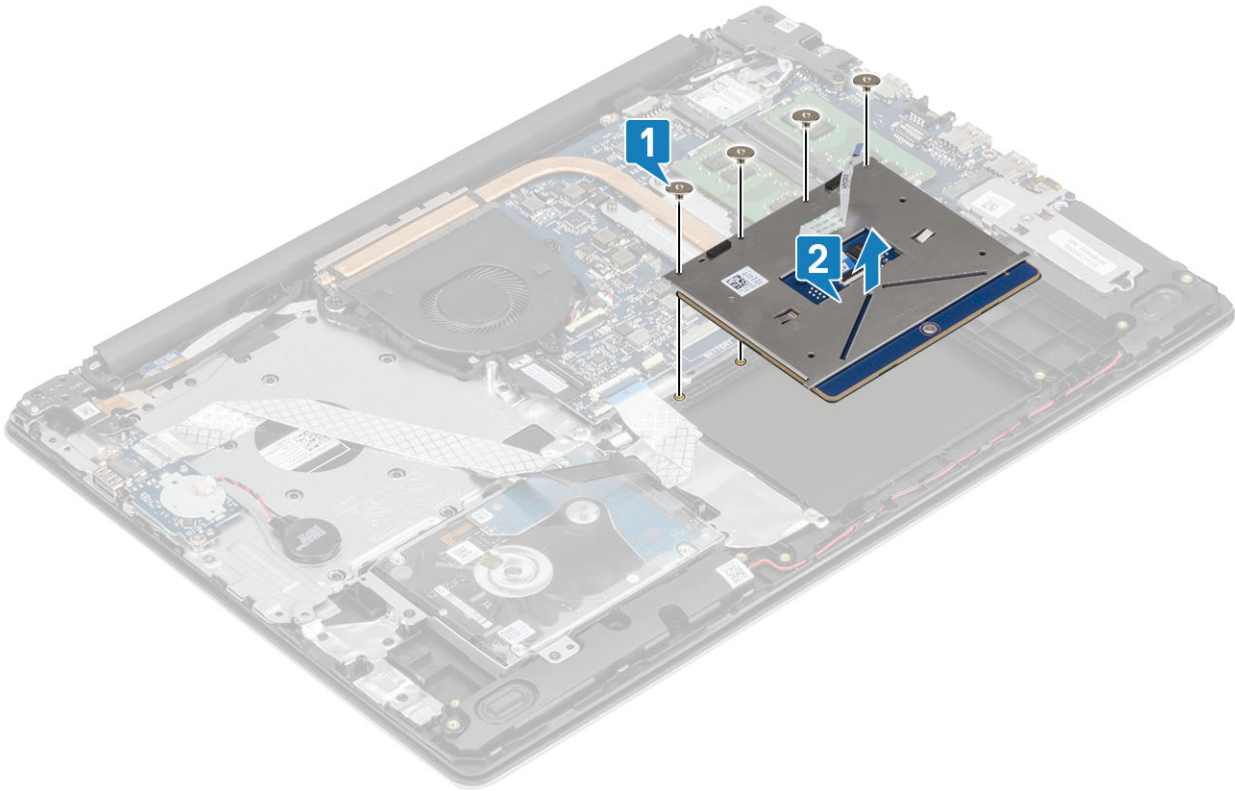

Installing the touch pad assembly

About this task

NOTE: Ensure that the touch pad is aligned with the guides available on the palm-rest and keyboard assembly, and the gap on either sides of the touch pad is equal.

Steps

1. Place the touch pad into the slot on the palmrest and keyboard assembly [1].
2. Replace the four (M2x2) screws that secure the touch pad to the palmrest and keyboard assembly [2].

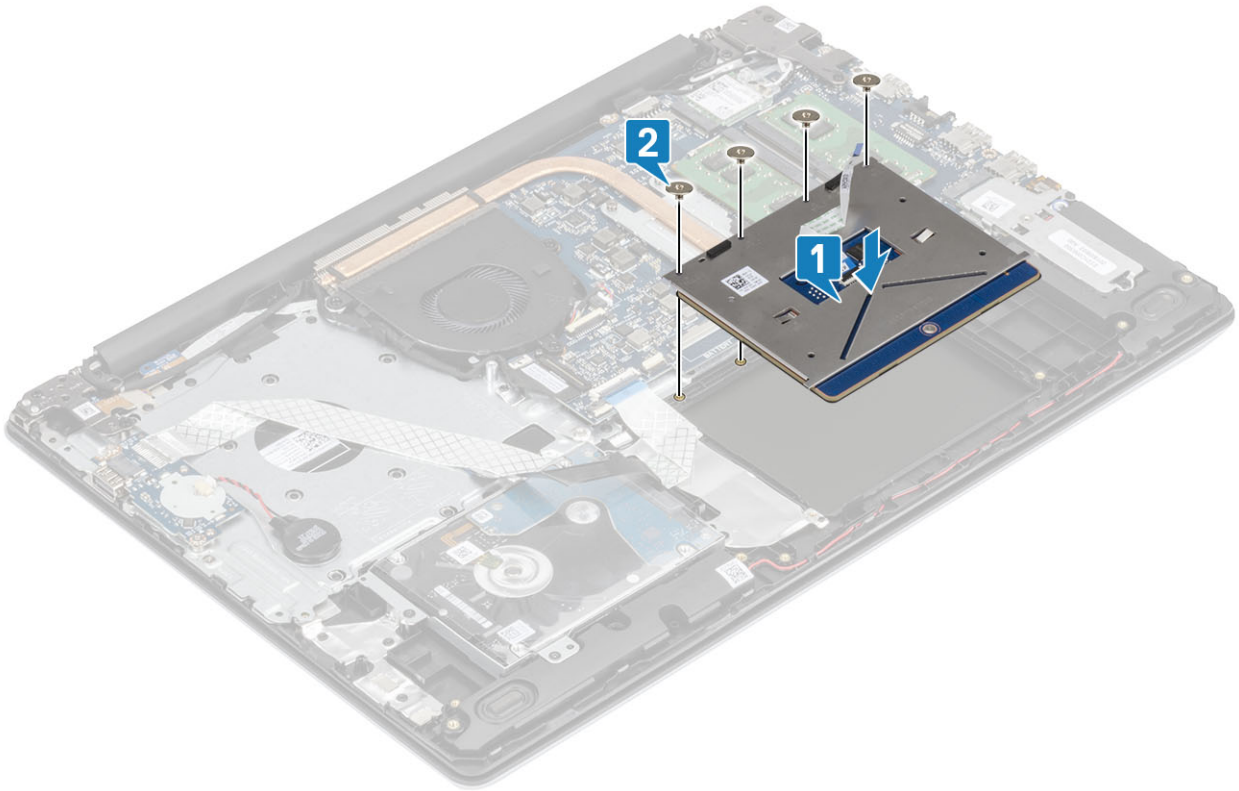

3. Place the touch pad bracket into the slot on the palmrest and keyboard assembly [1].
4. Replace the two screws (M2x2) that secure the touch pad bracket to the palmrest and keyboard assembly [2].

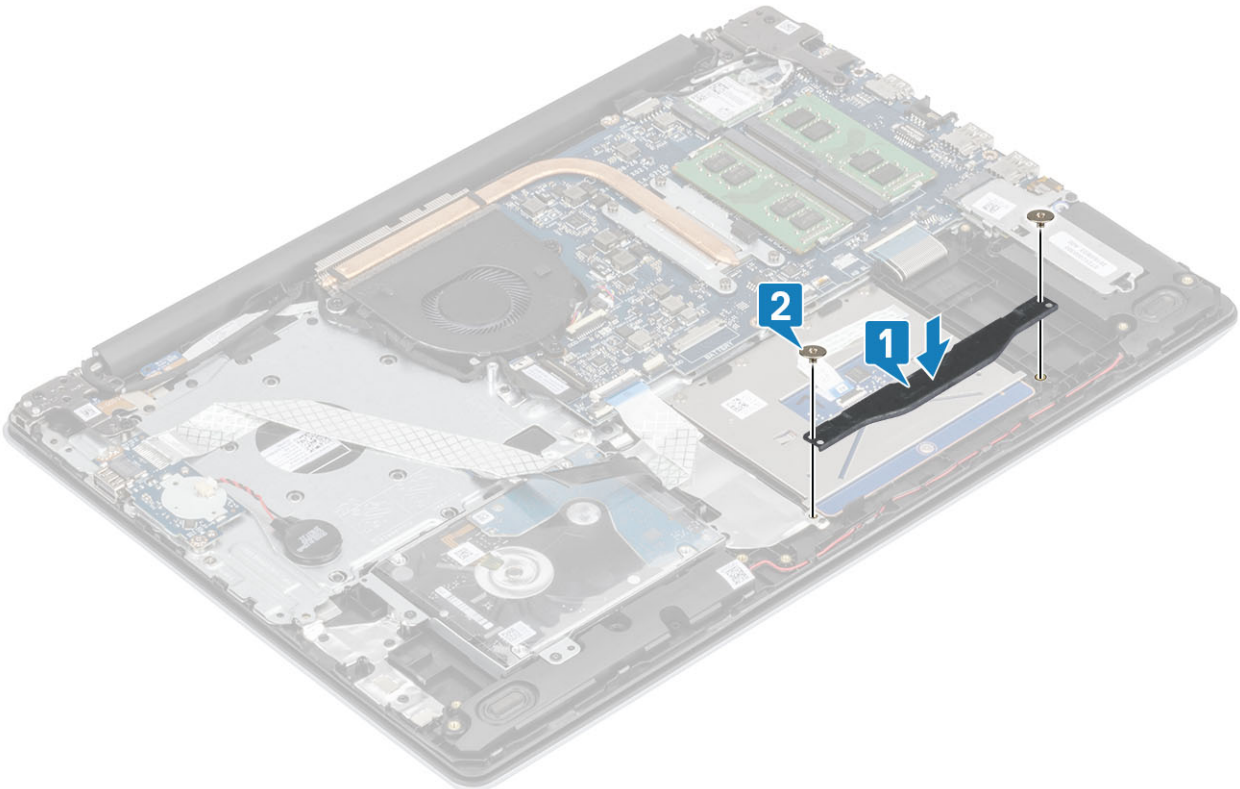

5. Affix the tape that secures the touch pad to the palmrest and keyboard assembly [1].
6. Slide the touch pad cable and hard drive cable into its connector on the system board and close the latch to secure the cables [2, 3].

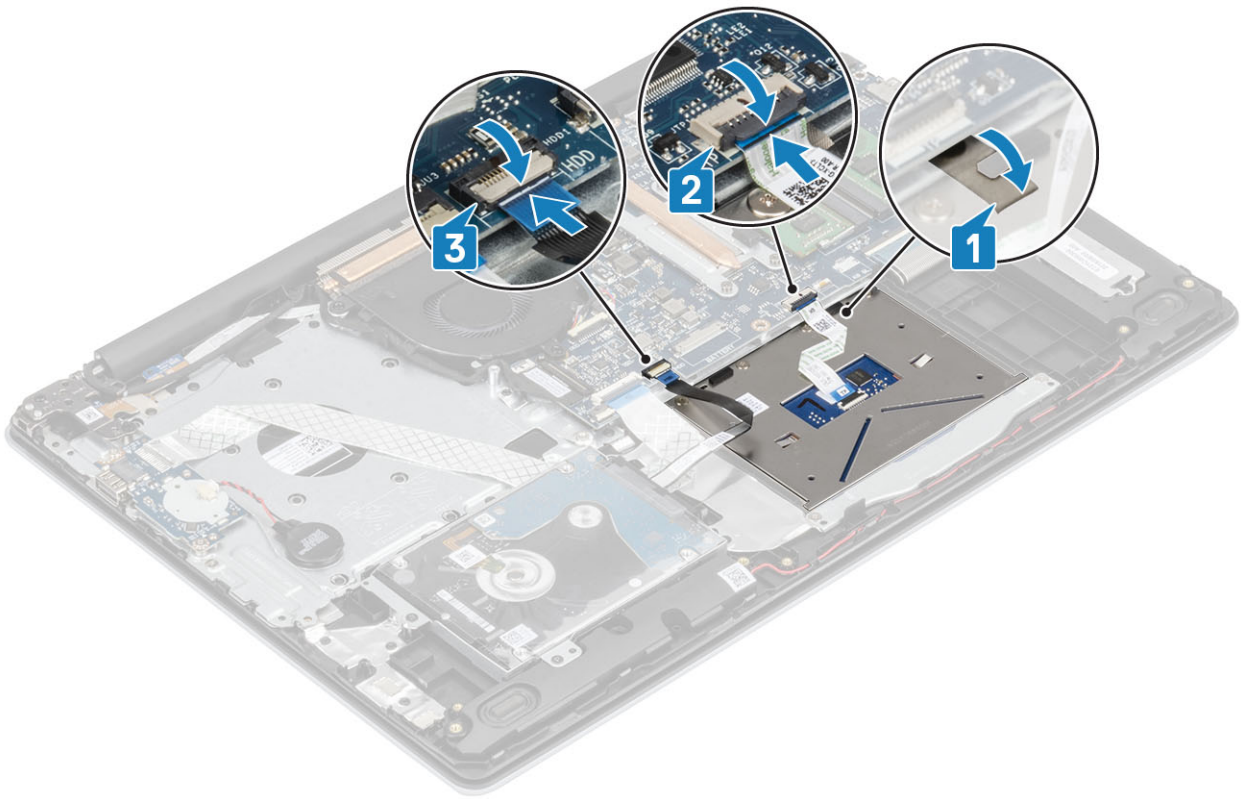

Next steps

1. Replace the [battery](#)
2. Replace the [base cover](#)
3. Replace the [SD memory card](#)
4. Follow the procedure in [after working inside your computer](#)

Display assembly

Removing the display assembly

Prerequisites

1. Follow the procedure in [before working inside your computer](#)
2. Remove the [SD memory card](#)
3. Remove the [base cover](#)
4. Disconnect the battery cable from the connector on the system board
5. Remove the [WLAN](#)

Steps

1. Open the latch and disconnect the display cable from the system board [1].
2. Unroute the display cable from the routing guides on the palmrest and keyboard assembly [2].
3. Peel off the tape securing the wireless antenna from the system board [3].

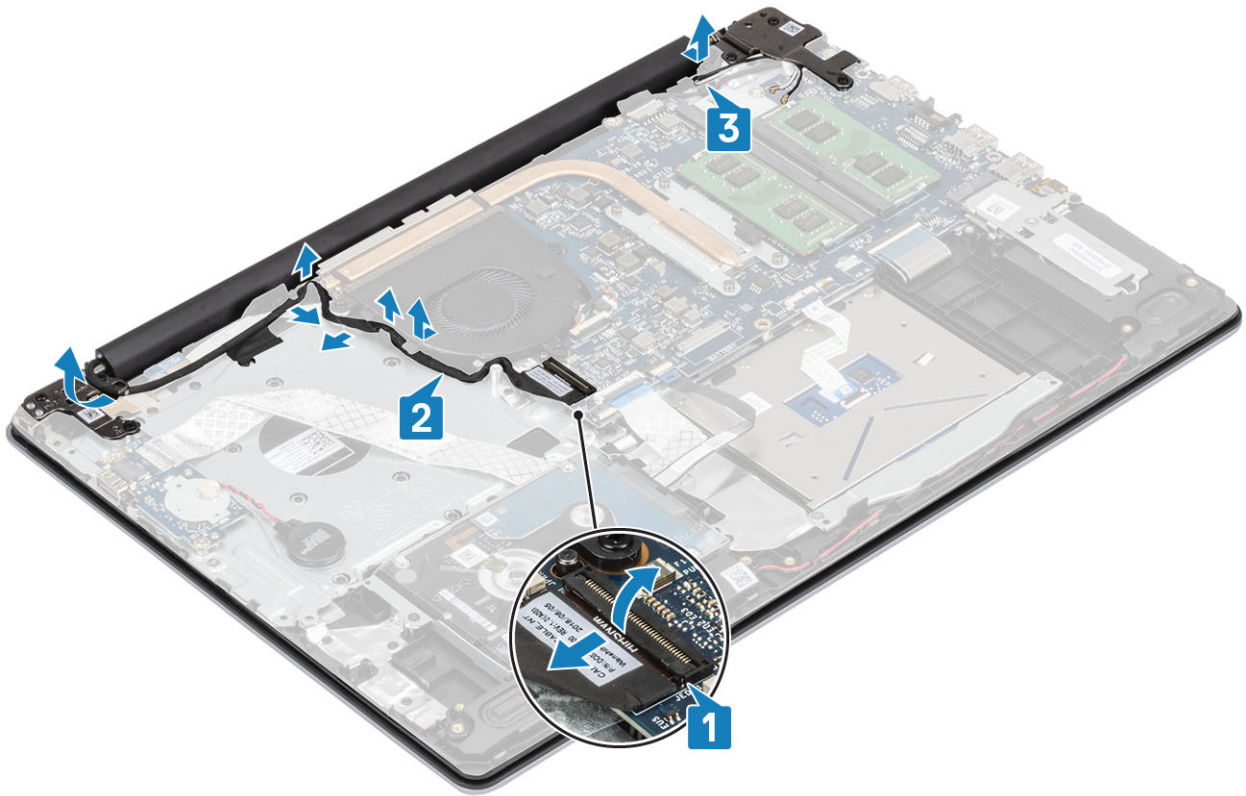

- 4. Remove the five (M2.5x5) screws that secure the left and right hinges to the system board, and palmrest and keyboard assembly [1].
- 5. Lift the palmrest and keyboard assembly at an angle [2].

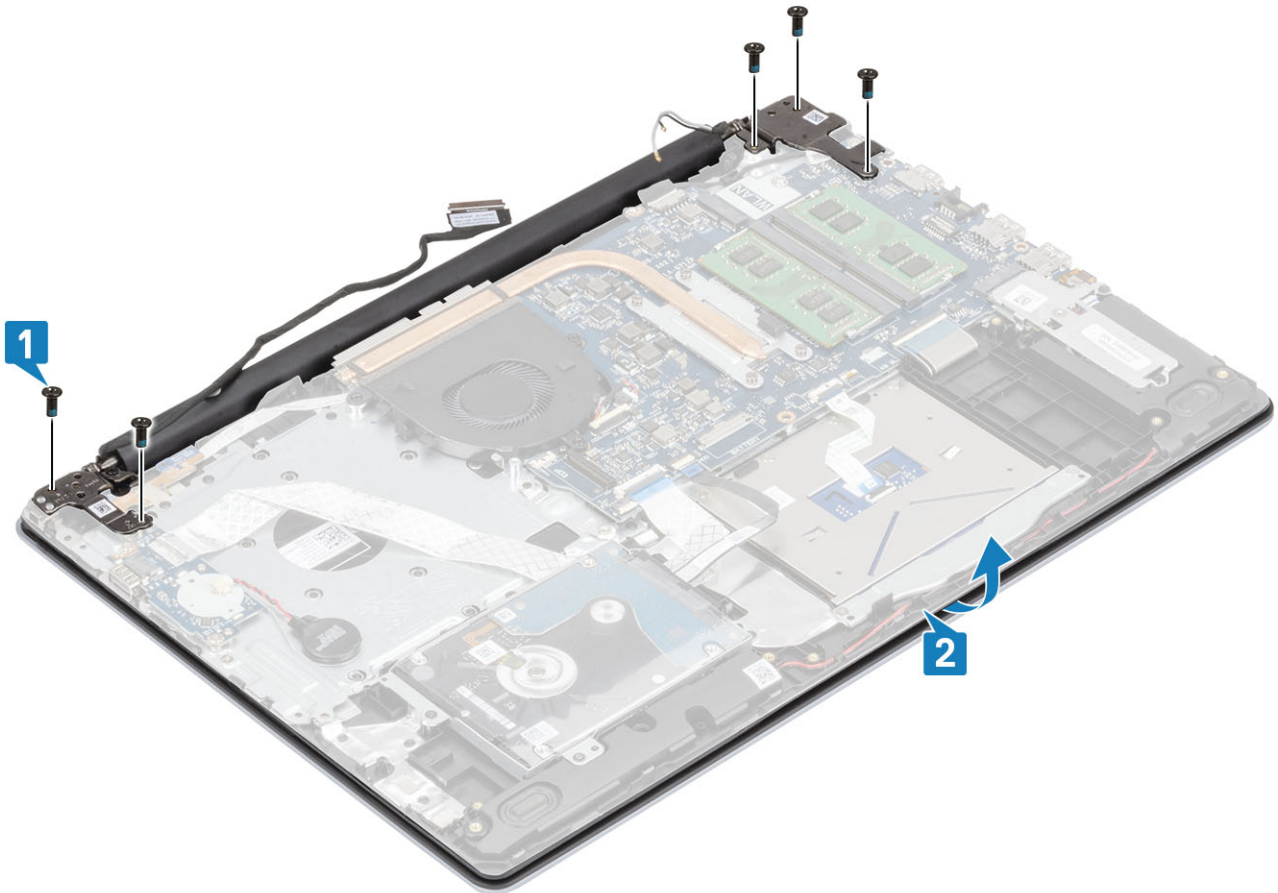

- 6. Lift the hinges and remove the palmrest and keyboard assembly off the display assembly [1, 2].

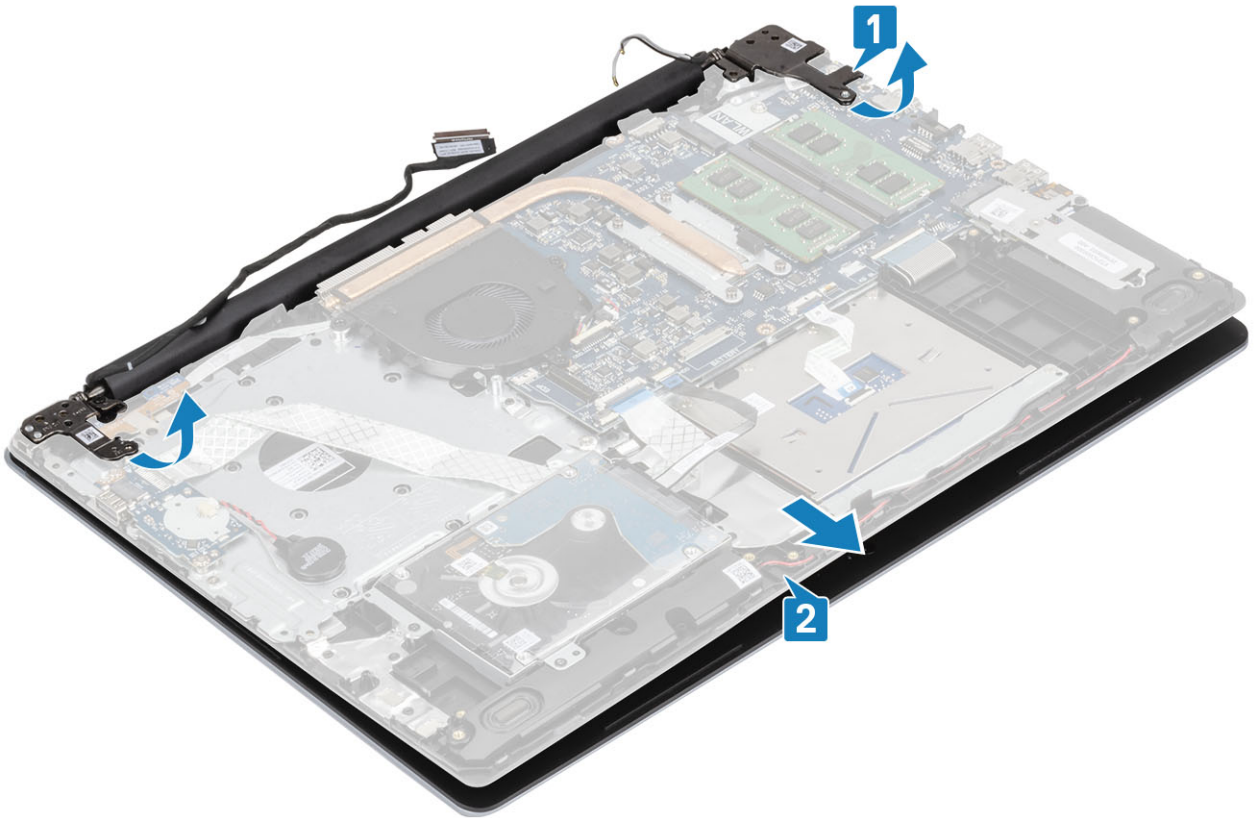

7. After performing all the preceding steps, you are left with display assembly.



Installing the display assembly

About this task

NOTE: Ensure that the hinges are opened to the maximum before replacing the display assembly on the palmrest and keyboard assembly.

Steps

1. Align and place the palmrest and keyboard assembly under the hinges on the display assembly [1].
2. Seat the palmrest and keyboard assembly on the display assembly [2].
3. Press the hinges down on the system board, and palmrest and keyboard assembly [3].

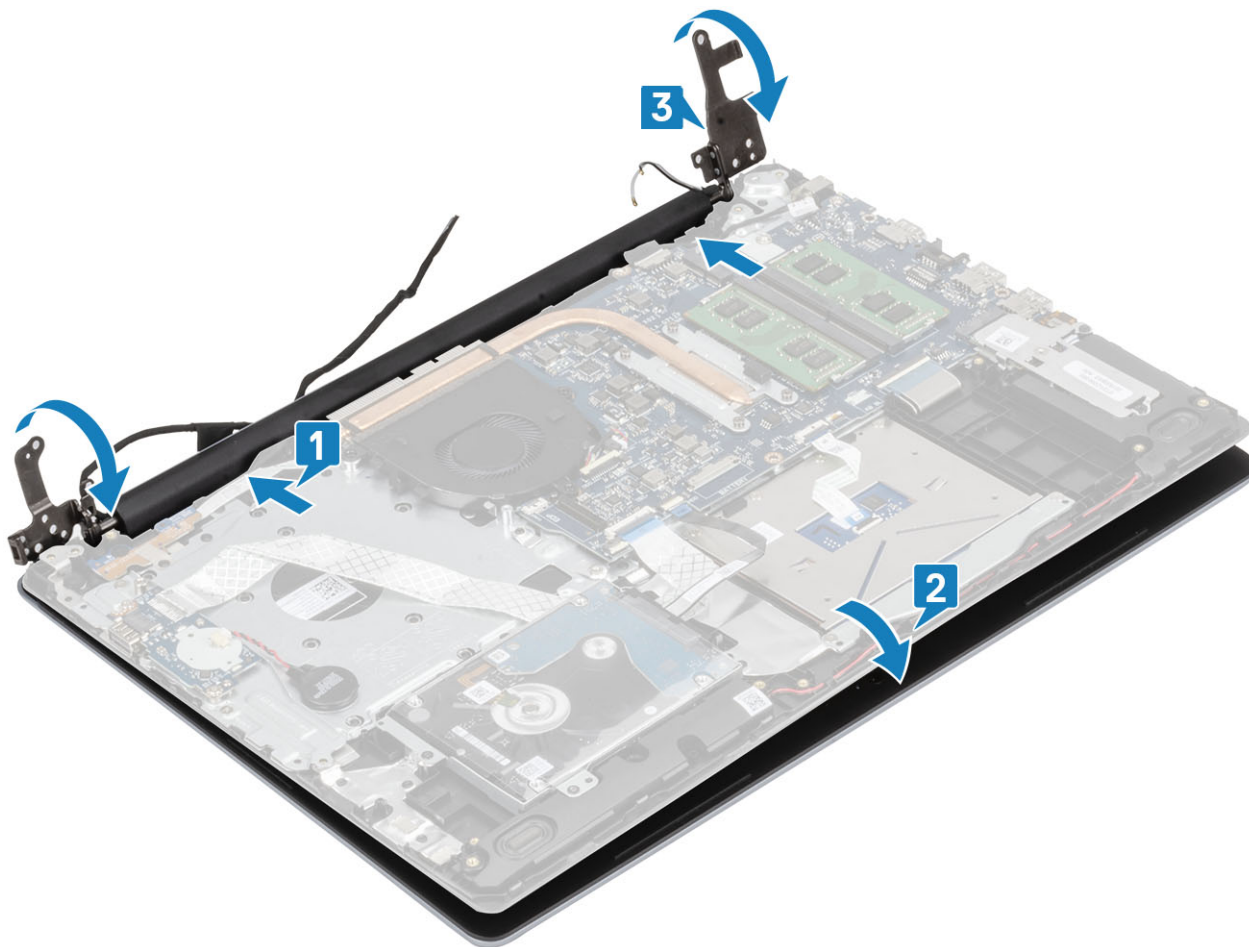

4. Replace the five (M2.5x5) screws that secure the left and right hinges to the system board, and palmrest and keyboard assembly [1].

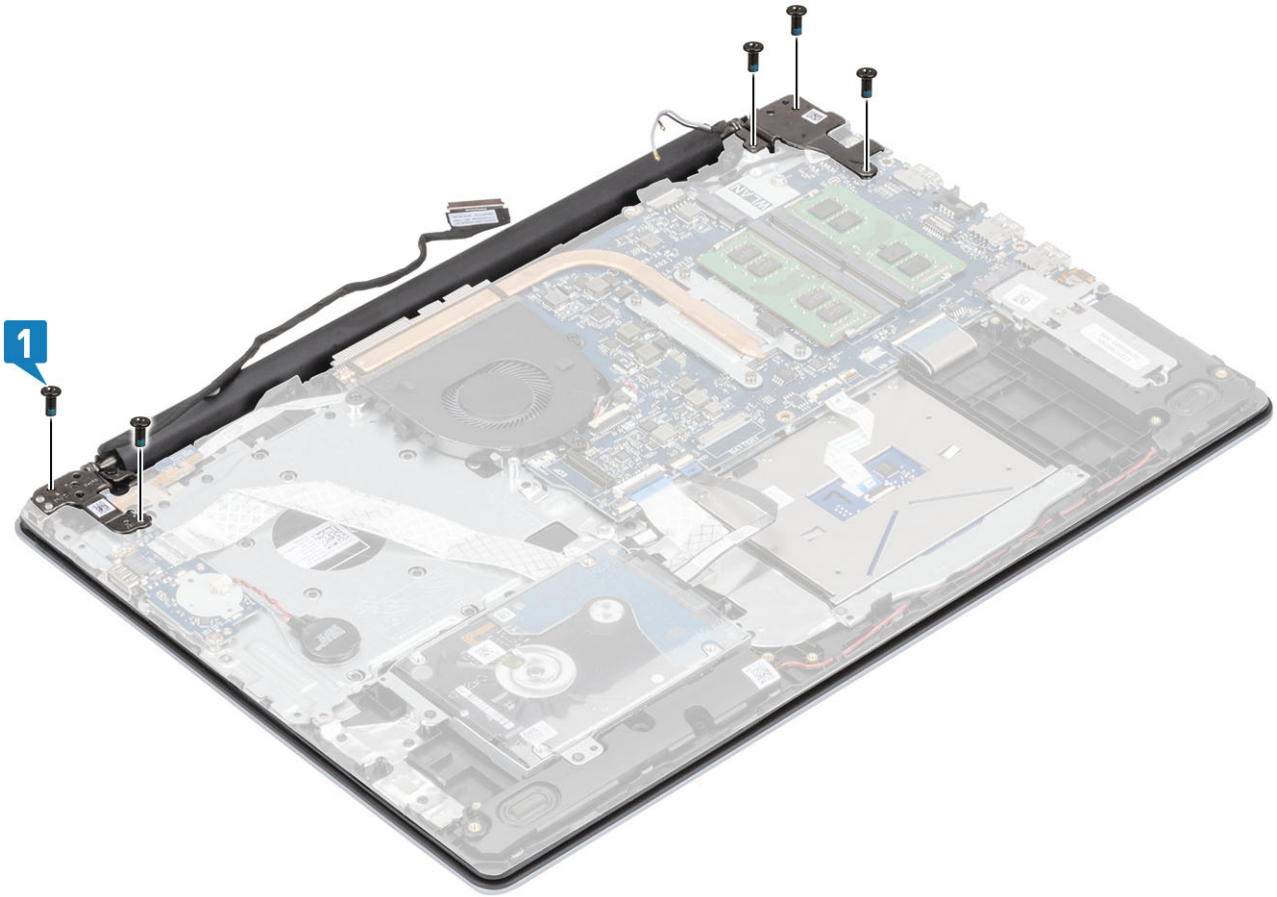

5. Route the display cable through the routing guides on the palmrest and keyboard assembly [1].
6. Connect the display cable to the connector on the system board [2].
7. Affix the antenna cables to the system board [3].

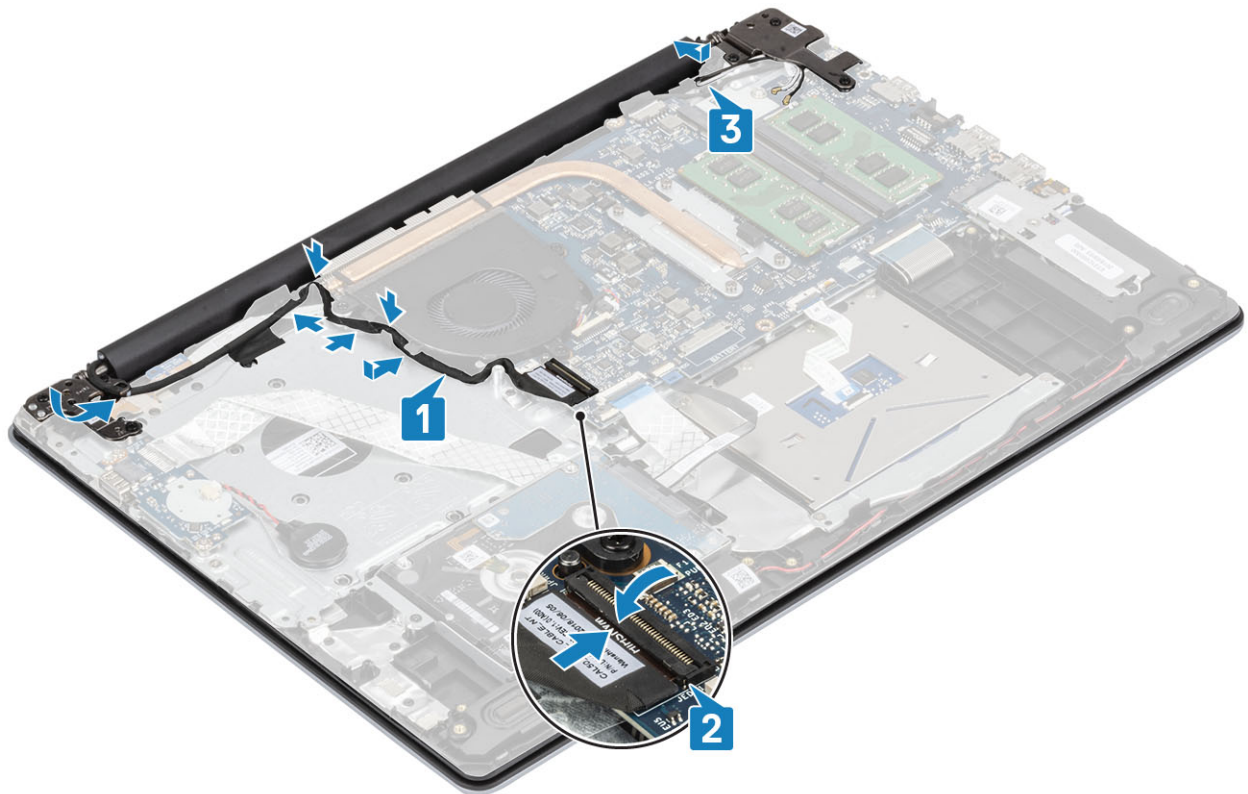

Next steps

1. Replace the [WLAN](#)
2. Connect the battery cable to the connector on the system board.
3. Replace the [base cover](#)
4. Replace the [SD memory card](#)
5. Follow the procedure in [after working inside your computer](#)

Power-button board

Removing the power button board

Prerequisites

1. Follow the procedure in [before working inside your computer](#)
2. Remove the [SD memory card](#)
3. Remove the [base cover](#)
4. Disconnect the battery cable from the connector on the system board.
5. Remove the [WLAN](#)
6. Remove the [system fan](#)
7. Remove the [display assembly](#)

Steps

1. Open the latch and disconnect the power button board cable from the system [1].
2. Peel the conductive tape off the power button board [2].
3. Remove the single (M2x2) screw that secures the power button board to the palmrest and keyboard assembly [3].
4. Lift the power button board, along with the cable off the palmrest and keyboard assembly [4].

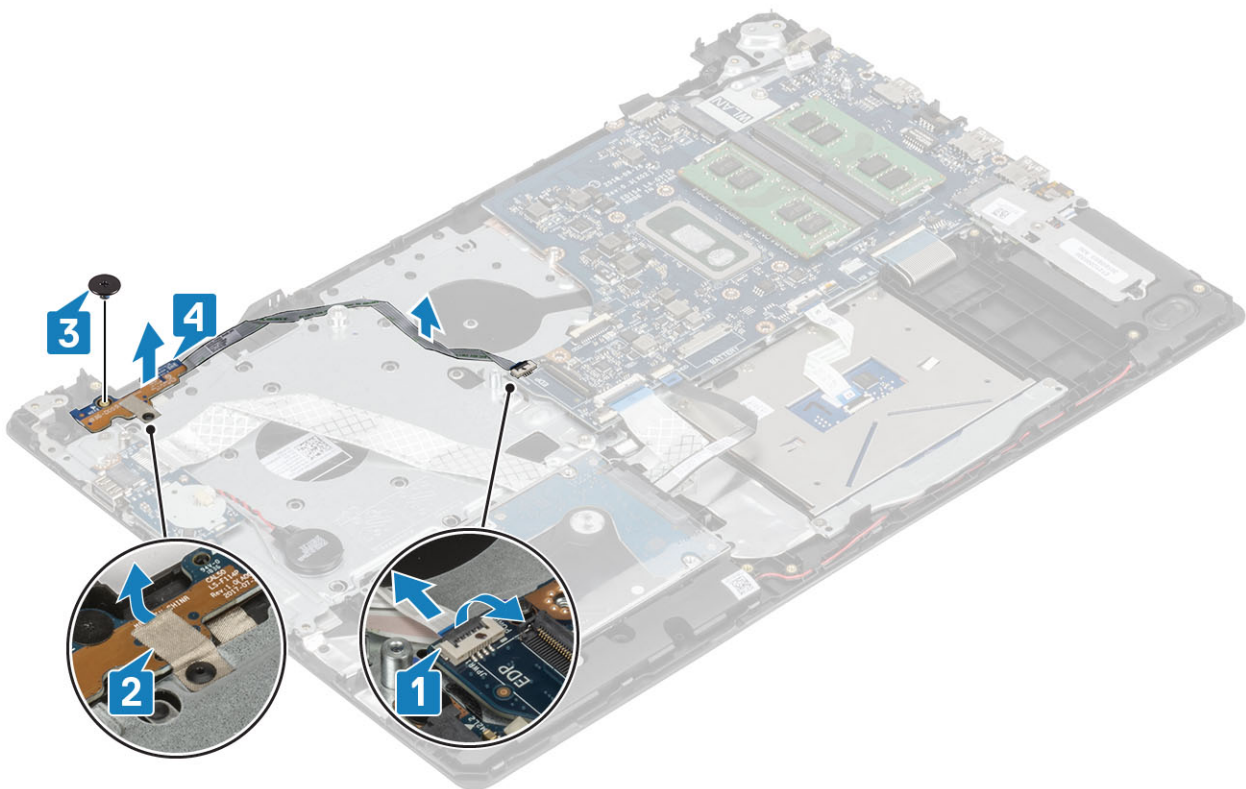

Installing the power button board

Steps

1. Place the power-button board into the slot on the palmrest and keyboard assembly [1].
2. Replace the single (M2x2) screw that secures the power button board to the palmrest and keyboard assembly [2].
3. Affix the conductive tape to the power button board [3].
4. Slide the power button cable to the system board and close the latch to secure the cable [4].

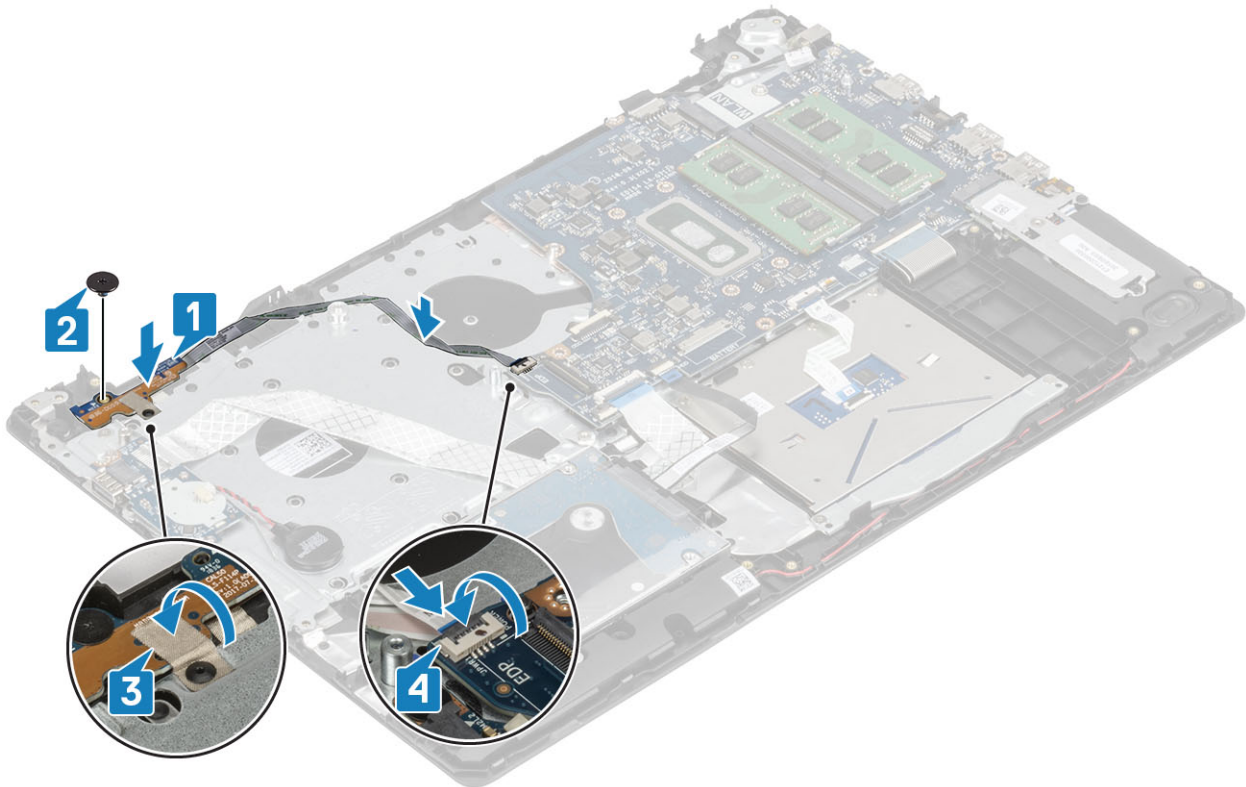

Next steps

1. Replace the [display assembly](#)
2. Replace the [system fan](#)
3. Replace the [WLAN](#)
4. Connect the battery cable to the connector on the system board.
5. Replace the [base cover](#)
6. Replace the [SD memory card](#)
7. Follow the procedure in [after working inside your computer](#)

Power button

Removing the power button

Prerequisites

1. Follow the procedure in [before working inside your computer](#)
2. Remove the [SD memory card](#)
3. Remove the [base cover](#)
4. Disconnect the battery cable from the connector on the system board.
5. Remove the [WLAN](#)

6. Remove the [system fan](#)
7. Remove the [heatsink](#)
8. Remove the [display assembly](#)
9. Remove the [power button board](#)

Steps

1. Remove the single (M2x2) screw that secures the power button on the palmrest and keyboard assembly [1].
2. Lift the power button off the palmrest and keyboard assembly [2].

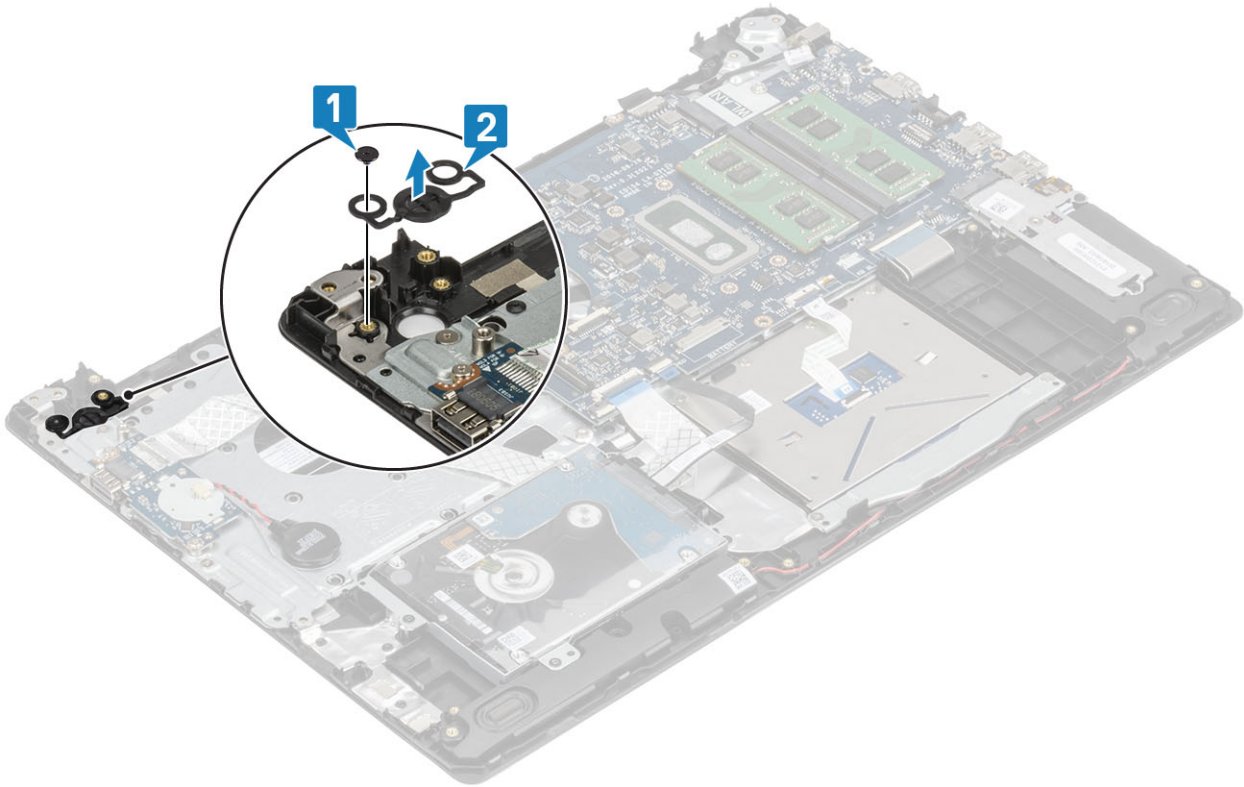

Installing the power button

Steps

1. Place the power-button into the slot on the palmrest and keyboard assembly [1].
2. Replace the single (M2x2) screw that secures the power button on the palmrest and keyboard assembly [2].

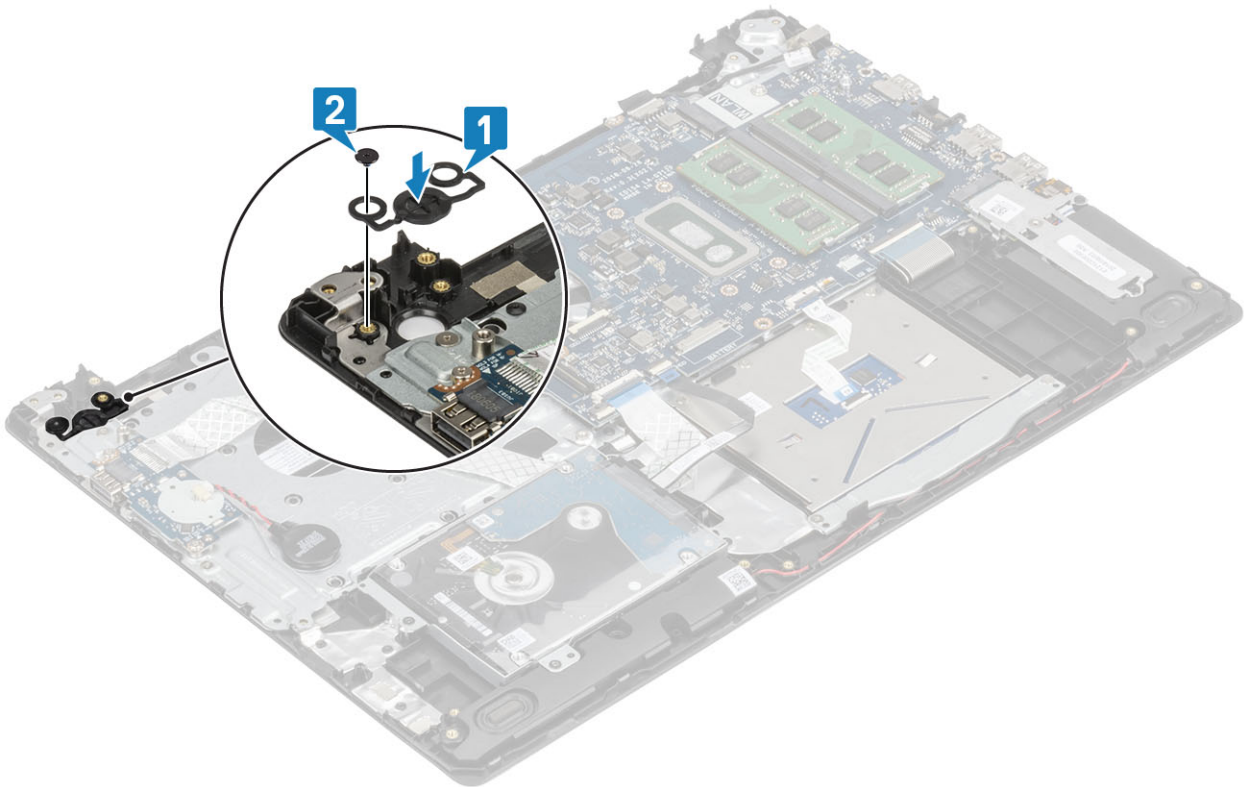

Next steps

1. Replace the [power button board](#)
2. Replace the [display assembly](#)
3. Remove the [system fan](#)
4. Replace the [WLAN](#)
5. Connect the battery cable to the connector on the system board.
6. Replace the [base cover](#)
7. Replace the [SD memory card](#)
8. Follow the procedure in [after working inside your computer](#)

System board

Removing the system board

Prerequisites

1. Follow the procedure in [before working inside your computer](#)
2. Remove the [SD memory card](#)
3. Remove the [base cover](#)
4. Remove the [battery](#)
5. Remove the [memory](#)
6. Remove the [WLAN](#)
7. Remove the [SSD](#)
8. Remove the [system fan](#)
9. Remove the [heatsink](#)
10. Remove the [display assembly](#)

Steps

1. Disconnect the power adapter port cable and speaker cable from the system board [1, 2].

2. Disconnect the following cables from the system board:
 - a) Power button board cable [1].
 - b) Finger print board cable [2].
 - c) IO board cable [3].
 - d) Hard drive cable [4].
 - e) Touchpad cable [5].
 - f) Keyboard cable [6].
3. Remove the single (M2x4) screw that secures the system board to the palmrest and keyboard assembly [1].
4. Lift the system board off the palmrest and keyboard assembly [2].

Installing the system board

Steps

1. Align the screw hole on the system board with the screw hole on the palmrest and keyboard assembly.
2. Replace the single (M2x4) screw that secures the system board to the palmrest and keyboard assembly.
3. Connect the following cables to the system board:
 - a) Power button board cable [1].
 - b) Finger print board cable [2].
 - c) IO board cable [3].
 - d) Hard drive cable [4].
 - e) Touchpad cable [5].
 - f) Keyboard cable [6].
4. Connect the power adapter port cable and speaker cable to the system board [1, 2].

Next steps

1. Replace the [display assembly](#)
2. Replace the [heatsink](#)
3. Replace the [system fan](#)
4. Replace the [SSD](#)
5. Replace the [WLAN](#)
6. Replace the [memory](#)
7. Replace the [battery](#)
8. Replace the [base cover](#)
9. Replace the [SD memory card](#)
10. Follow the procedure in [after working inside your computer](#)

Power-adapter port

Removing the power adapter port

Prerequisites

1. Follow the procedure in [before working inside your computer](#)
2. Remove the [SD memory card](#)
3. Remove the [base cover](#)
4. Remove the [battery](#)
5. Remove the [WLAN](#)
6. Remove the [SSD](#)
7. Remove the [display assembly](#)
8. Remove the [power button board](#)

Steps

1. Disconnect and route the power adapter cable from the system board [1, 2].
2. Remove the single (M2x3) screw that secures the power adapter port to the palmrest and keyboard assembly [3].
3. Lift the power adapter port, along with its cable, off the palmrest and keyboard assembly [4].

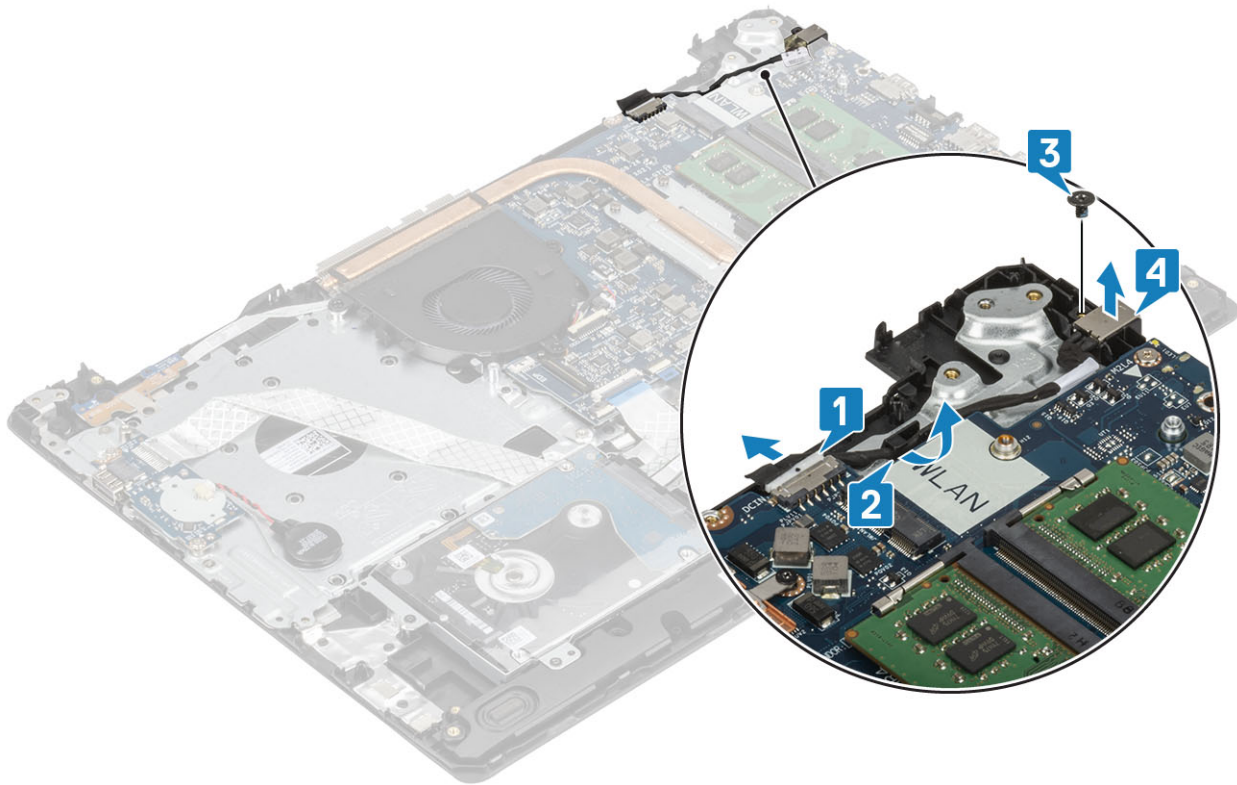

Installing the power adapter port

Steps

1. Place the power adapter port into the slot on the palmrest and keyboard assembly [1].
2. Replace the single (M2x3) screw that secures the power adapter port to the palmrest and keyboard assembly [2].
3. Route the power adapter cable through the routing channels [3].
4. Connect the power adapter cable to the system board [4].

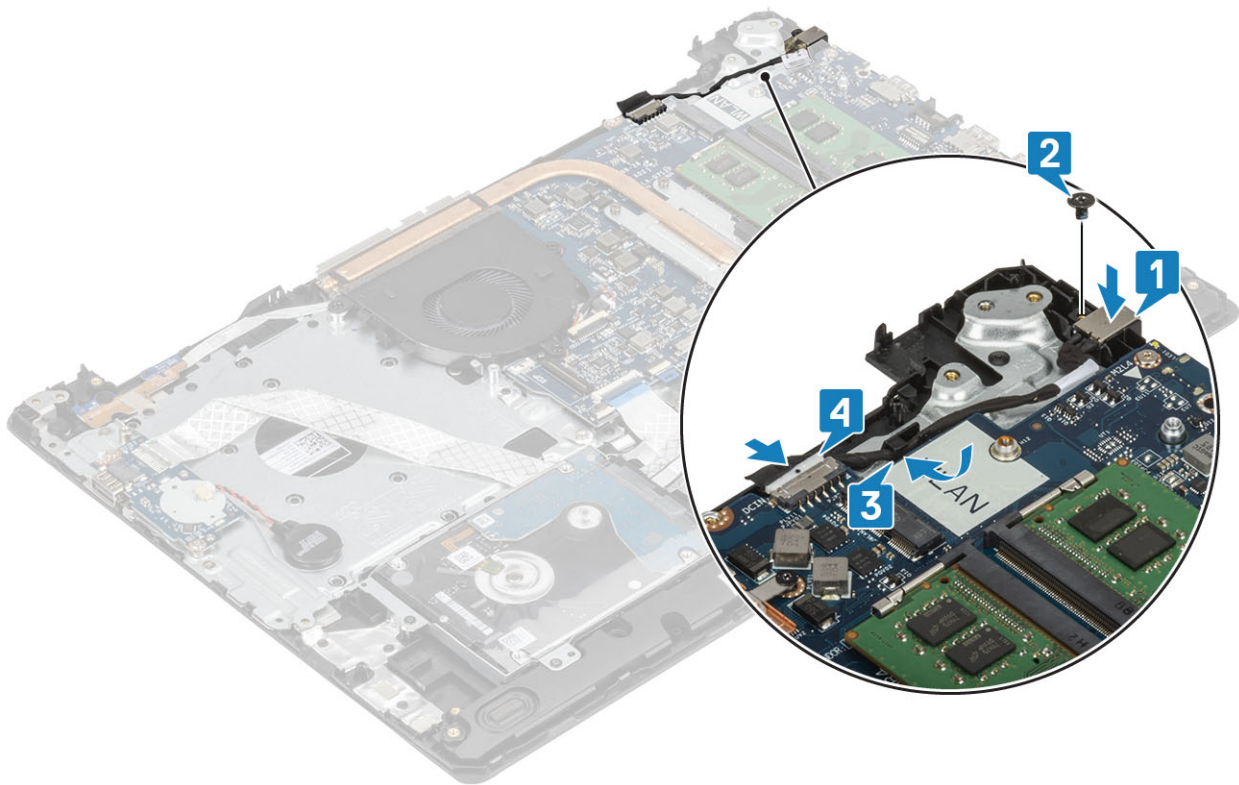

Next steps

1. Replace the [power button board](#)
2. Replace the [display assembly](#)
3. Replace the [SSD](#)
4. Replace the [WLAN](#)
5. Replace the [battery](#)
6. Replace the [base cover](#)
7. Replace the [SD memory card](#)
8. Follow the procedure in [after working inside your computer](#)

Display bezel

Removing the display bezel

Prerequisites

1. Follow the procedure in [before working inside your computer](#)
2. Remove the [SD memory card](#)
3. Remove the [base cover](#)
4. Disconnect the battery cable from the connector on the system board
5. Remove the [memory](#)
6. Remove the [WLAN](#)
7. Remove the [SSD](#)
8. Remove the [hard drive assembly](#)
9. Remove the [system fan](#)
10. Remove the [heatsink](#)
11. Remove the [display assembly](#)

Steps

1. Pry the inner top side of the display bezel [1].
2. Continue to pry the inner left and inner right edges of the display bezel [2].
3. Pry up the bottom inner edge of the display bezel and lift the bezel off the display assembly [3].

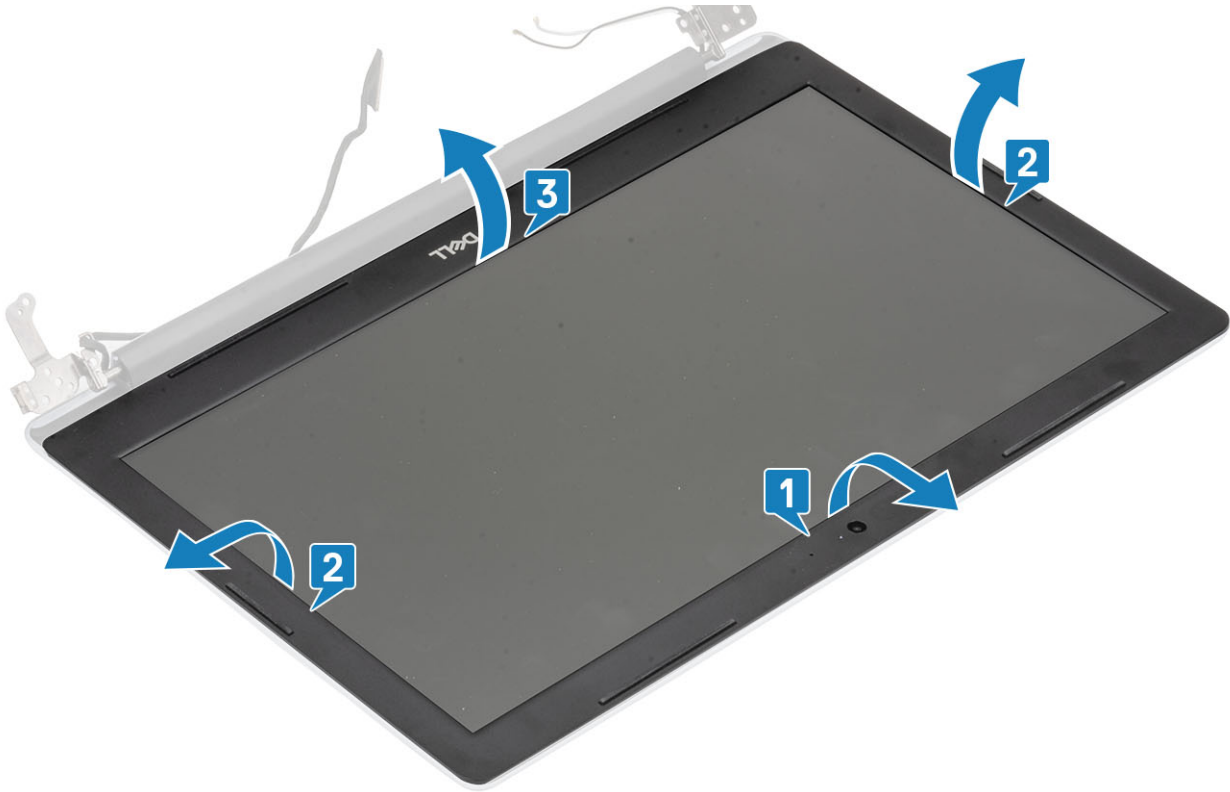

Installing the display bezel

Steps

1. Align the display bezel with the display back-cover and antenna assembly, and then gently snap the display bezel into place [1].



Next steps

1. Replace the [display assembly](#)
2. Replace the [hard drive assembly](#)
3. Replace the [system fan](#)
4. Replace the [heatsink](#)
5. Replace the [SSD](#)
6. Replace the [WLAN](#)
7. Replace the [memory](#)
8. Connect the battery cable to the connector on the system board.
9. Replace the [base cover](#)
10. Replace the [SD memory card](#)
11. Follow the procedure in [after working inside your computer](#)

Camera

Removing the camera

Prerequisites

1. Follow the procedure in [before working inside your computer](#)
2. Remove the [SD memory card](#)
3. Remove the [base cover](#)
4. Remove the [battery](#)
5. Remove the [WLAN](#)
6. Remove the [SSD](#)
7. Remove the [hard drive assembly](#)
8. Remove the [system fan](#)
9. Remove the [heatsink](#)
10. Remove the [display assembly](#)

11. Remove the [display bezel](#)

Steps

1. Using a plastic scribe, gently pry the camera off the display back-cover and antenna assembly [1].
2. Disconnect the camera cable from the camera module [2].
3. Lift the camera module from the display back-cover and antenna assembly [3].

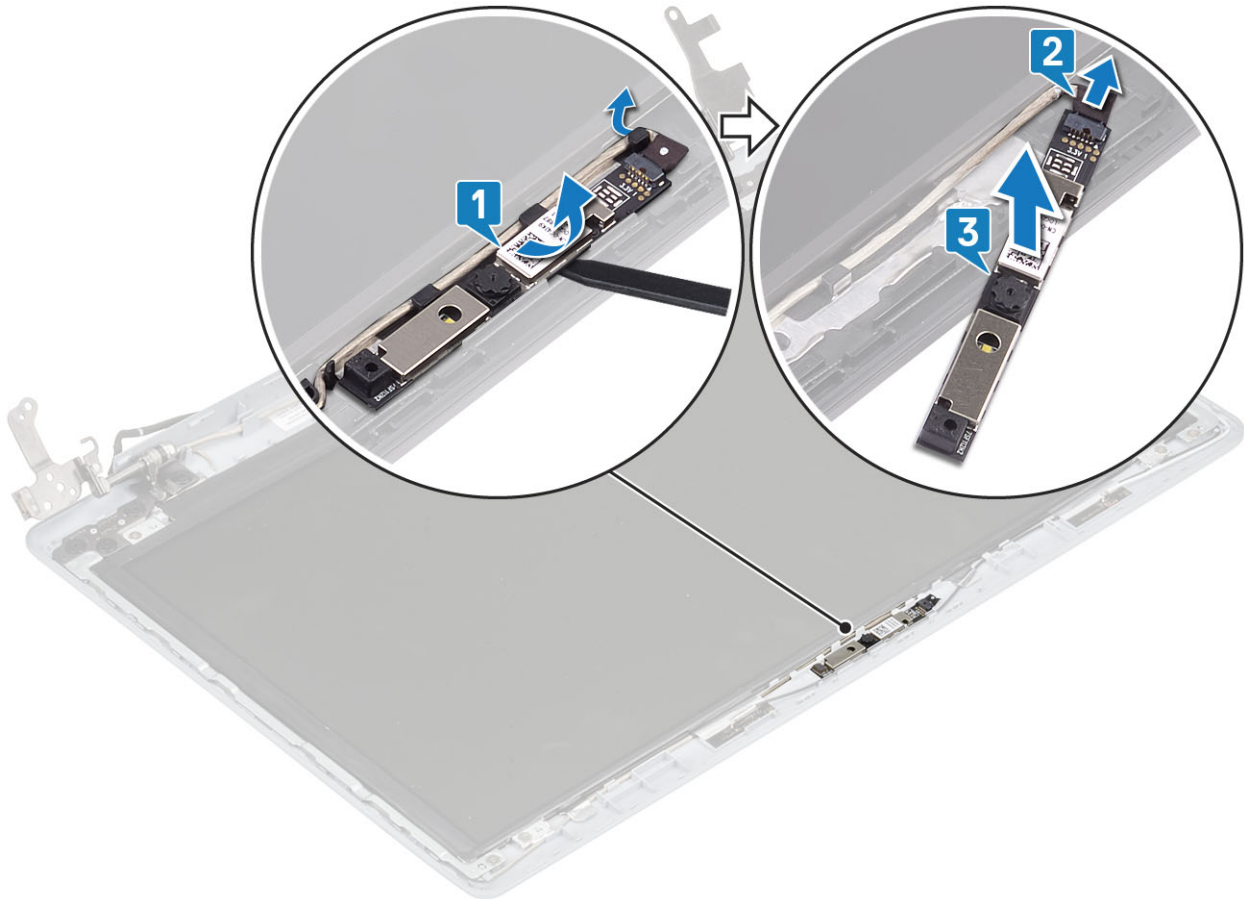

Installing the camera

Steps

1. Connect the camera cable to the camera module [1].
2. Route the camera cable through the routing channels [2].
3. Using the alignment post, adhere the camera module on the display back-cover and antenna assembly [3].

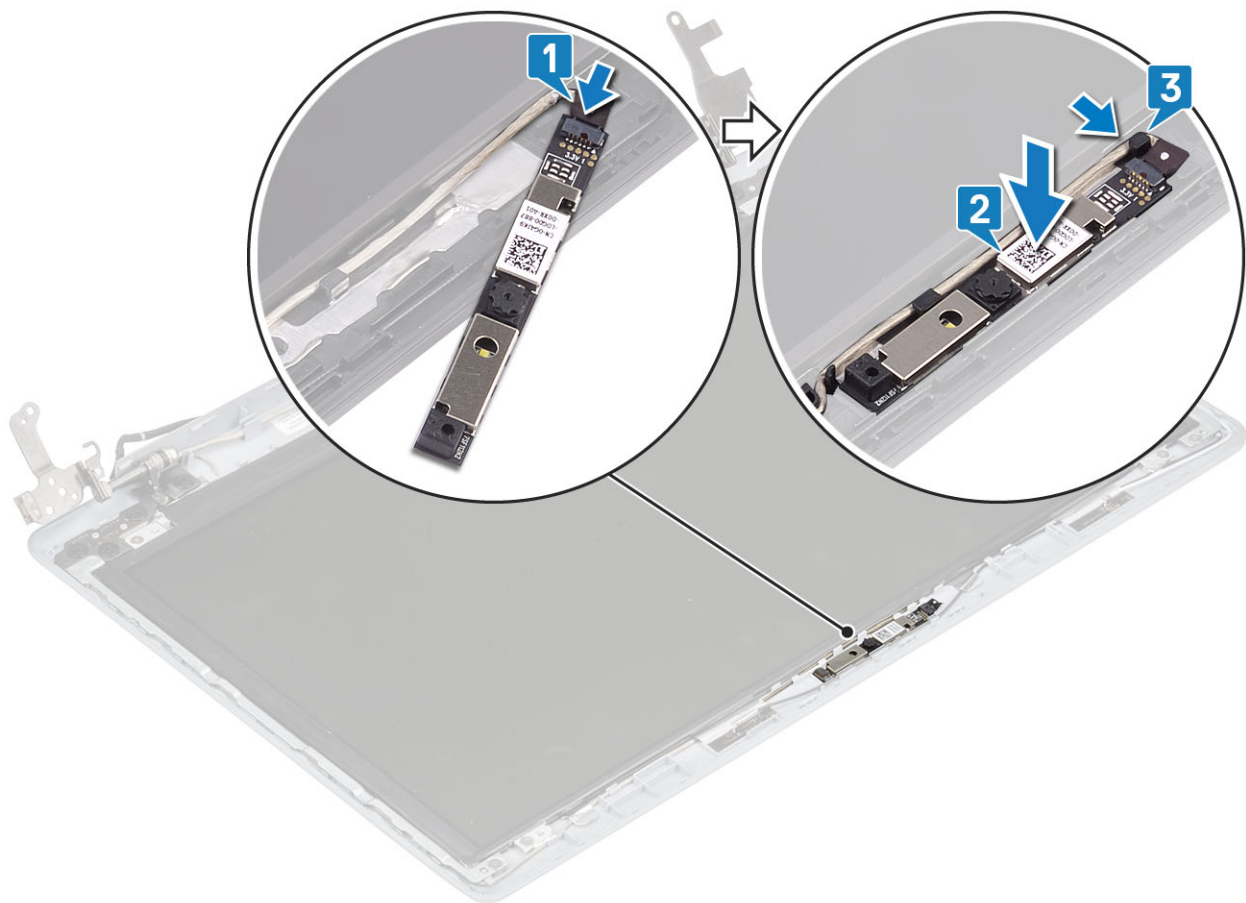

Next steps

1. Replace the [display bezel](#)
2. Replace the [display assembly](#)
3. Replace the [hard drive assembly](#)
4. Replace the [system fan](#)
5. Replace the [heatsink](#)
6. Replace the [SSD](#)
7. Replace the [WLAN](#)
8. Replace the [battery](#)
9. Replace the [base cover](#)
10. Replace the [SD memory card](#)
11. Follow the procedure in [after working inside your computer](#)

Display panel

Removing the display panel

Prerequisites

1. Follow the procedure in [before working inside your computer](#)
2. Remove the [SD memory card](#)
3. Remove the [base cover](#)
4. Remove the [battery](#)
5. Remove the [WLAN](#)
6. Remove the [SSD](#)
7. Remove the [hard drive assembly](#)

8. Remove the [system fan](#)
9. Remove the [heatsink](#)
10. Remove the [display assembly](#)
11. Remove the [display bezel](#)
12. Remove the [camera](#)

Steps

1. Remove the four (M2x2) screws that secure the display panel to the display back-cover and antenna assembly [1].
2. Lift the display panel and turn it over [2].

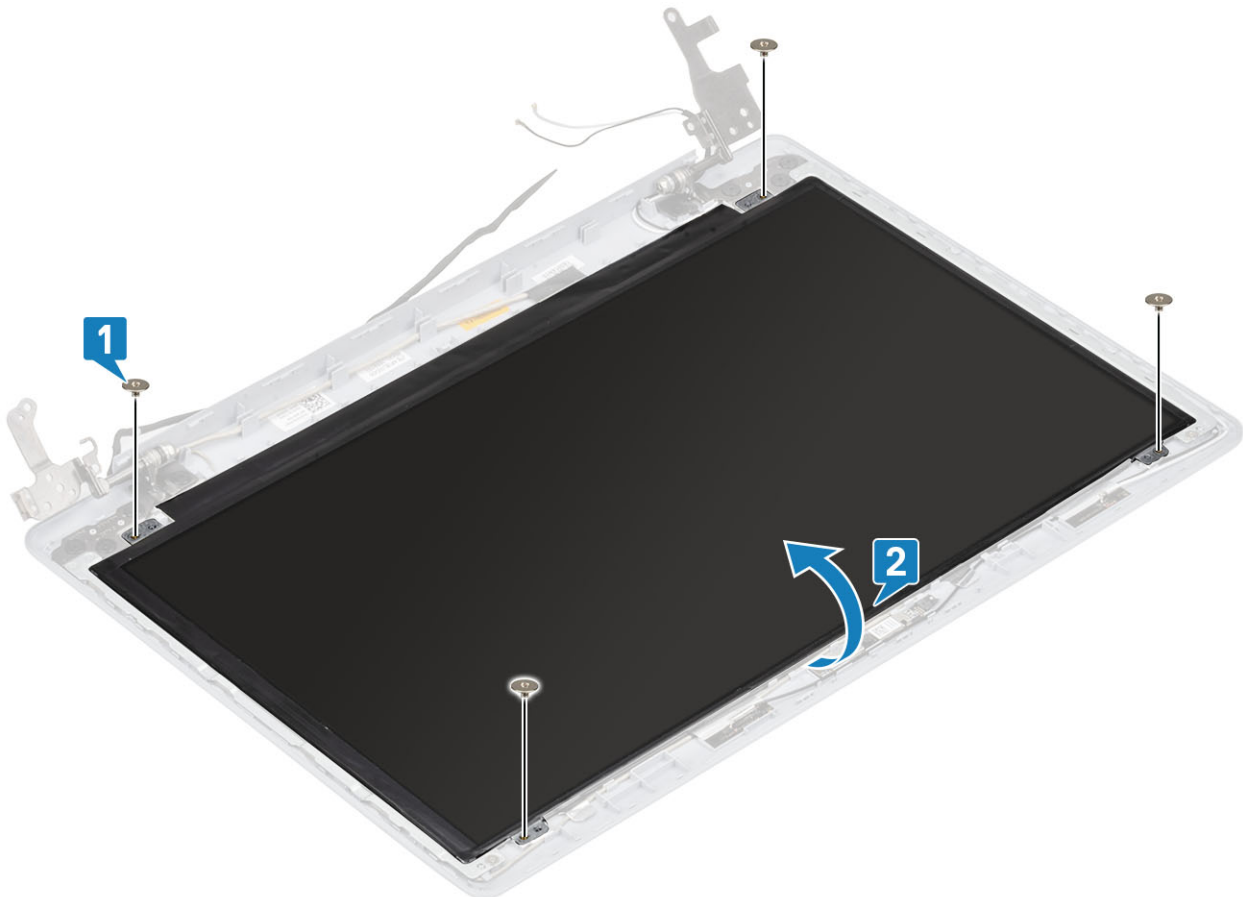

3. Peel the tape that secures the display cable to the back of the display panel [1].
4. Lift the latch and disconnect the display cable from the display-panel cable connector [2].
5. Lift the display panel away from the display back-cover and antenna assembly [3].

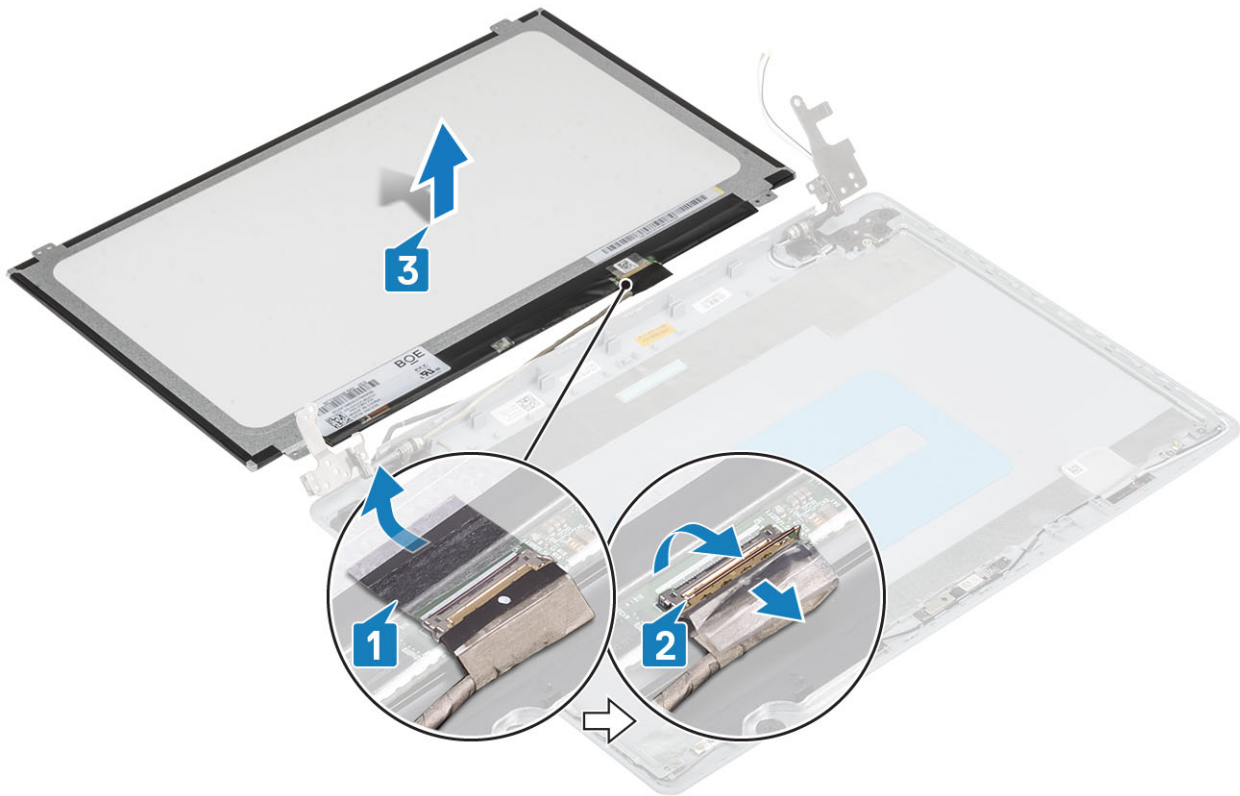

Installation display panel

Steps

1. Place the display panel on a flat and clean surface [1].
2. Connect the display cable to the connector at the back of the display panel and close the latch to secure the cable [2].
3. Adhere the tape that secures the display cable to the back of the display panel [3].
4. Turn the display panel over and place it on the display back-cover and antenna assembly [4].

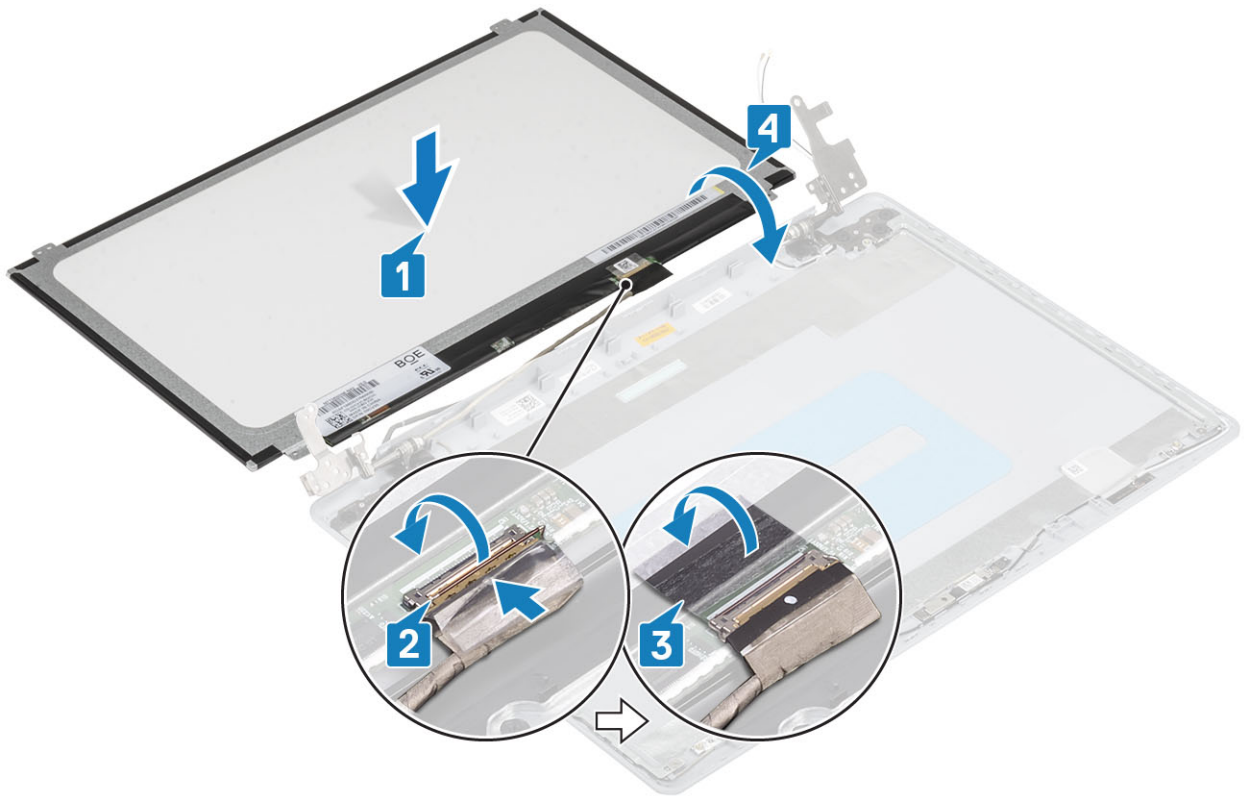

5. Align the screw holes on the display panel with the screw holes on the display back-cover and antenna assembly.
6. Replace the four (M2x2) screws that secure the display panel to the display back-cover and antenna assembly [1].

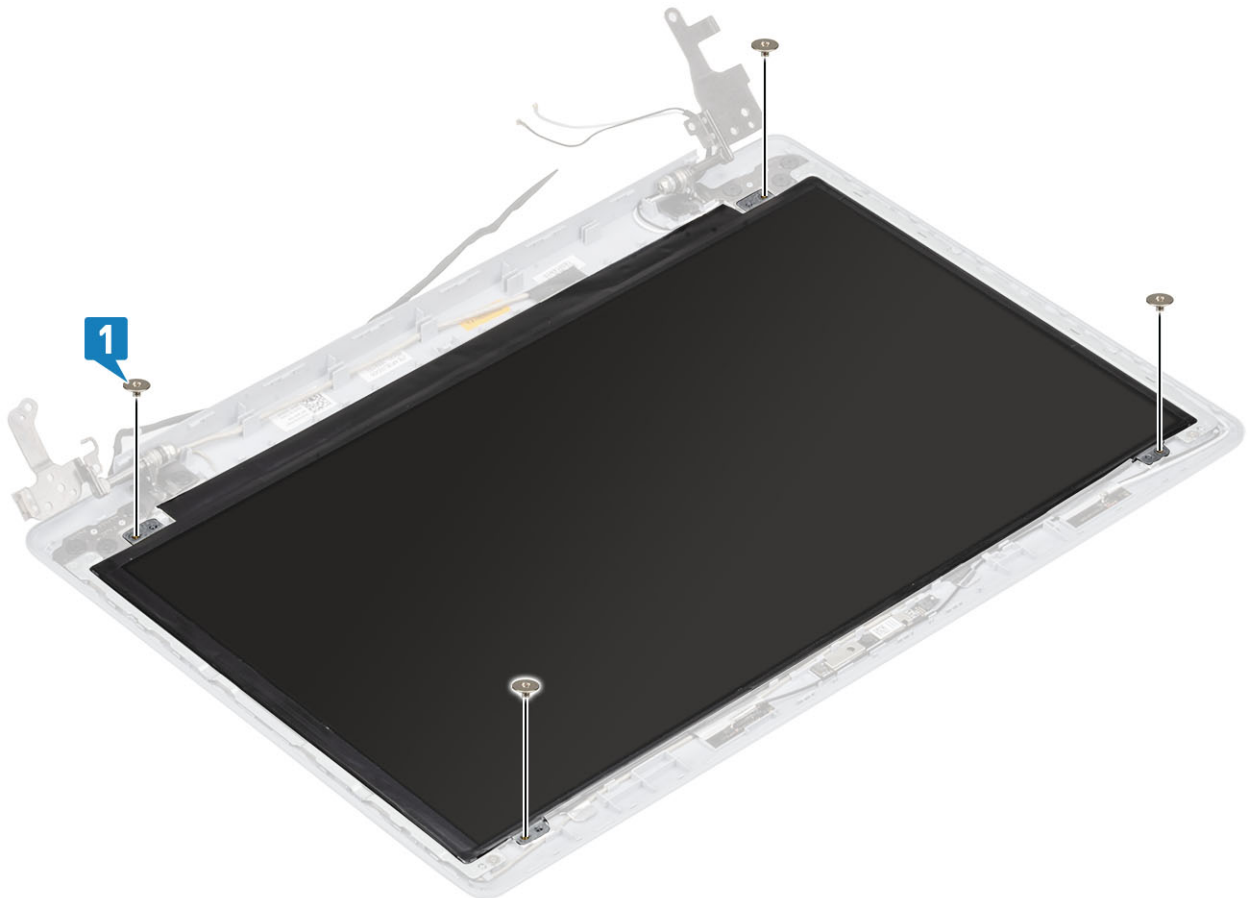

Next steps

1. Replace the [camera](#)
2. Replace the [display bezel](#)
3. Replace the [display assembly](#)
4. Replace the [hard drive assembly](#)
5. Replace the [system fan](#)
6. Replace the [heatsink](#)
7. Replace the [SSD](#)
8. Replace the [WLAN](#)
9. Replace the [battery](#)
10. Replace the [base cover](#)
11. Replace the [SD memory card](#)
12. Follow the procedure in [after working inside your computer](#)

Display hinges

Removing the display hinges

Prerequisites

1. Follow the procedure in [before working inside your computer](#)
2. Remove the [SD memory card](#)
3. Remove the [base cover](#)
4. Remove the [battery](#)
5. Remove the [WLAN](#)
6. Remove the [SSD](#)
7. Remove the [hard drive assembly](#)
8. Remove the [system fan](#)
9. Remove the [heatsink](#)
10. Remove the [display assembly](#)
11. Remove the [display bezel](#)
12. Remove the [camera](#)
13. Remove the [display panel](#)

Steps

1. Remove the eight (M2.5x2.5) screws and two (M2x2) screws that secure the hinges to the display back-cover and antenna assembly [1, 2].
2. Lift the hinges and brackets off the display back-cover and antenna assembly [3].

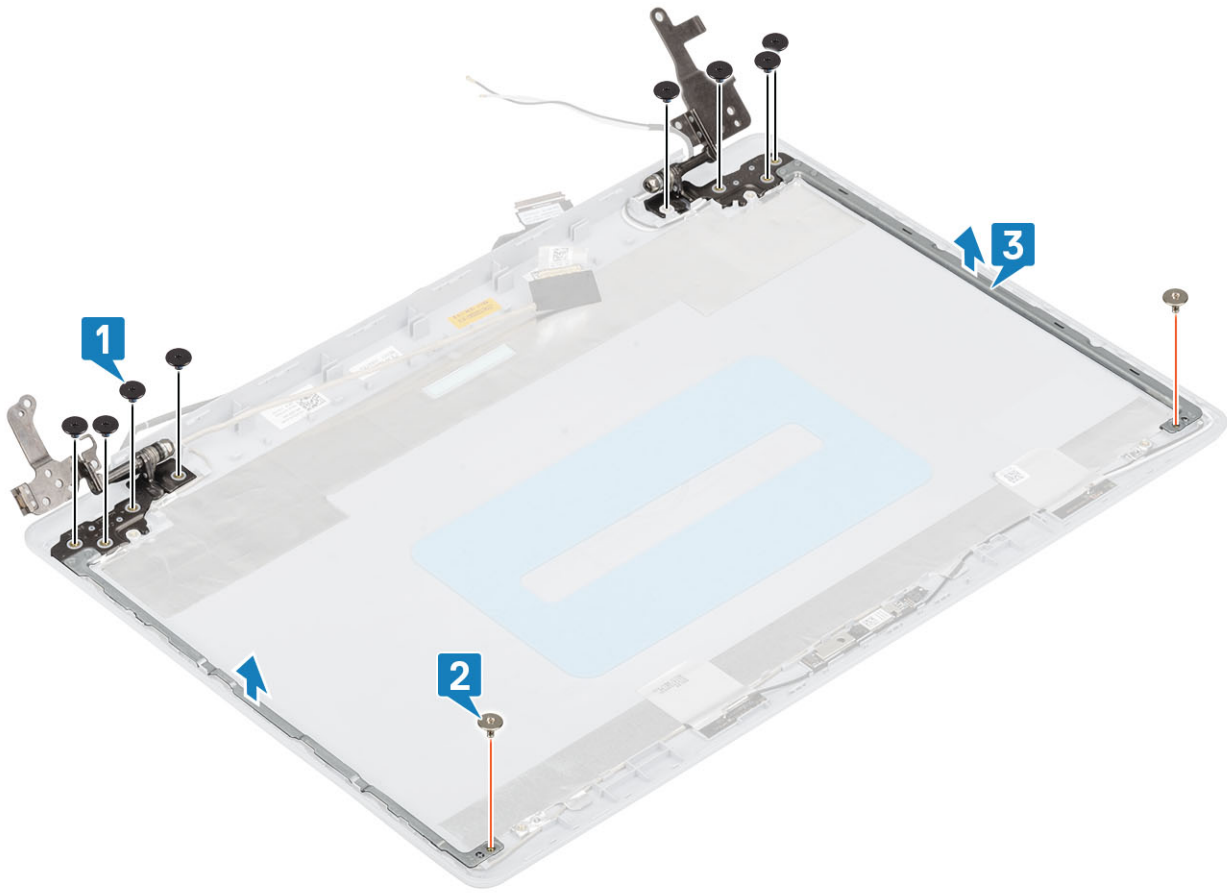

Installing the display hinges

Steps

1. Align the screw holes on the hinges and brackets with the screw holes on the display back-cover and antenna assembly [1].
2. Replace the eight (M2.5x2.5) screws and two (M2x2) screws that secure the hinges to the display back-cover and antenna assembly [2, 3].

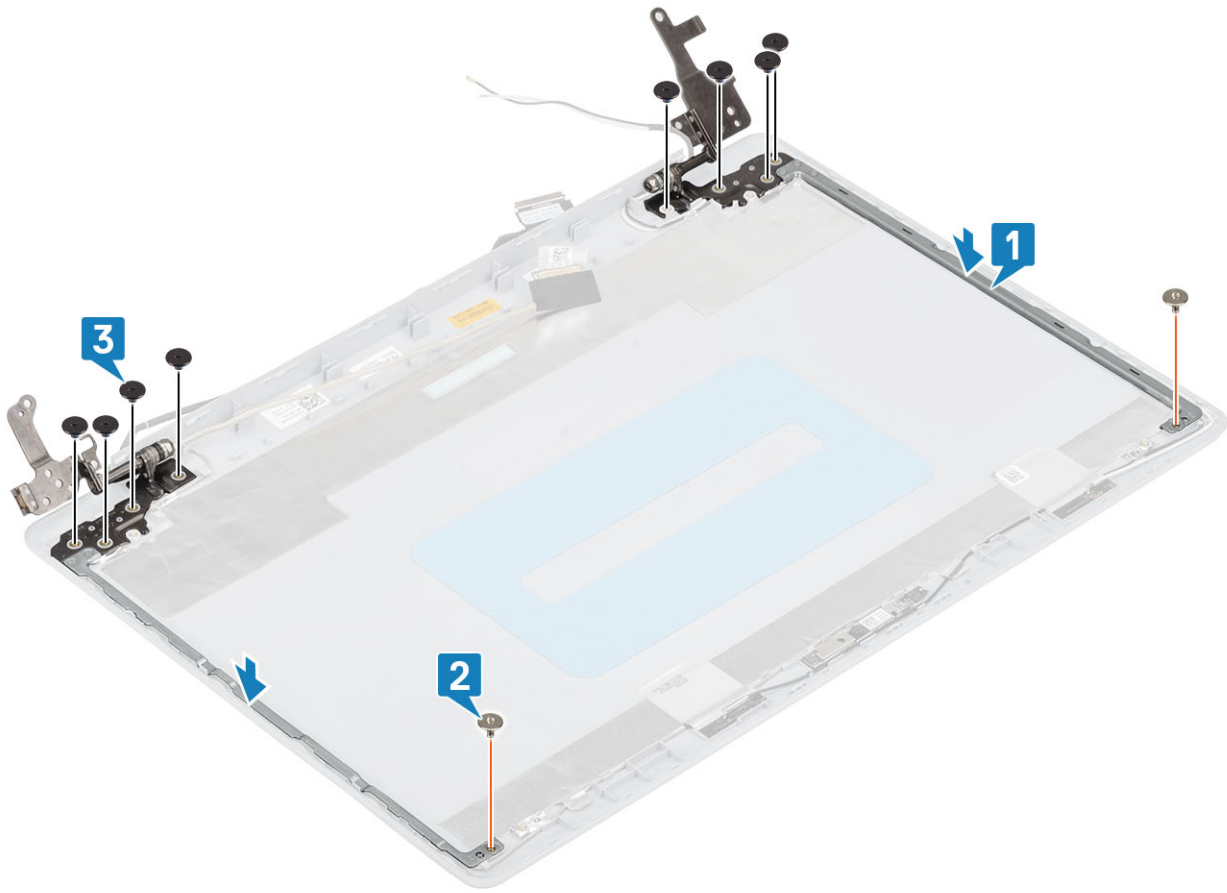

Next steps

1. Replace the [display panel](#)
2. Replace the [camera](#)
3. Replace the [display bezel](#)
4. Replace the [display assembly](#)
5. Replace the [hard drive assembly](#)
6. Replace the [system fan](#)
7. Replace the [heatsink](#)
8. Replace the [SSD](#)
9. Replace the [WLAN](#)
10. Replace the [battery](#)
11. Replace the [base cover](#)
12. Replace the [SD memory card](#)
13. Follow the procedure in [after working inside your computer](#)

Display cable

Removing the display cable

Prerequisites

1. Follow the procedure in [before working inside your computer](#)
2. Remove the [SD memory card](#)
3. Remove the [base cover](#)
4. Remove the [battery](#)
5. Remove the [WLAN](#)

6. Remove the [SSD](#)
7. Remove the [hard drive assembly](#)
8. Remove the [system fan](#)
9. Remove the [heatsink](#)
10. Remove the [display assembly](#)
11. Remove the [display bezel](#)
12. Remove the [display panel](#)
13. Remove the [display hinges](#)

Steps

1. Remove the camera cable and the display cable from the routing guides on the display back-cover and antenna assembly [1].
2. Peel the adhesive that secures the camera cable [2].
3. Lift the camera cable and the display cable off the display back-cover and antenna assembly [3].

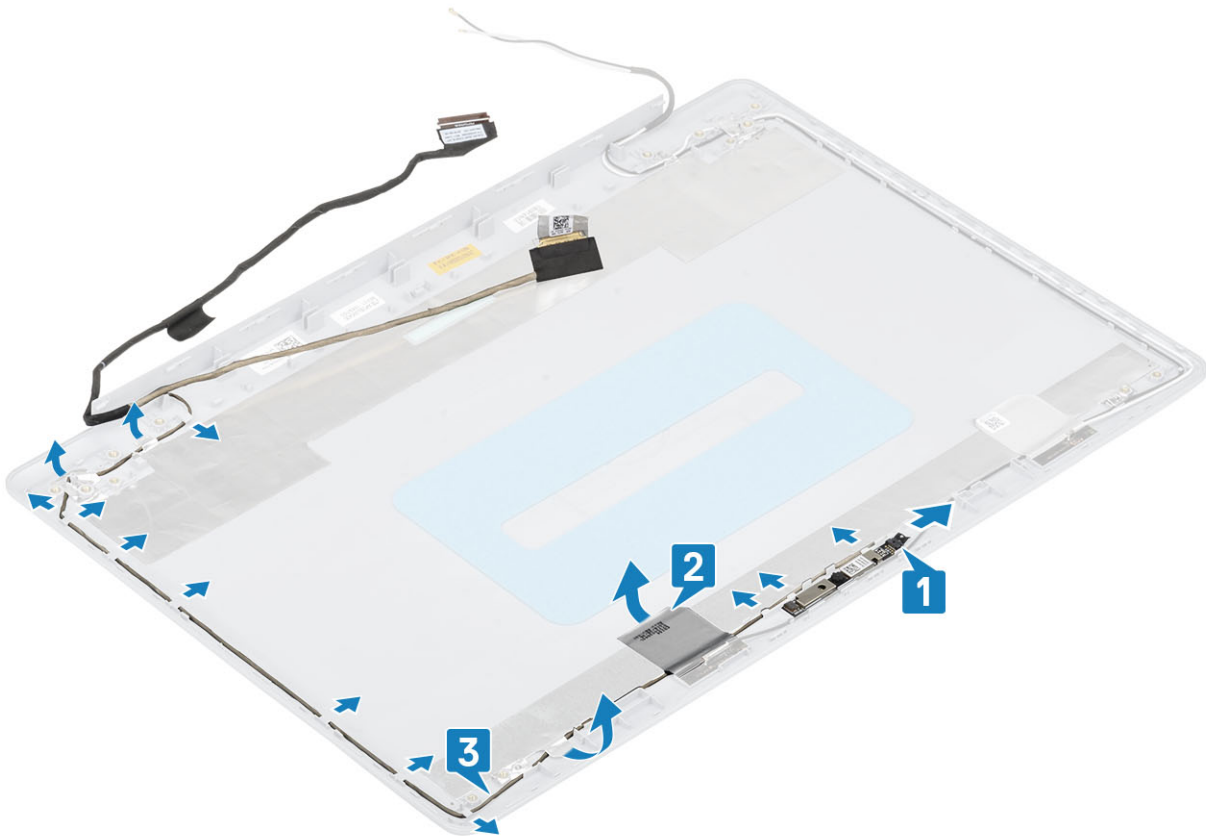

Installing the display cable

Steps

1. Place the display cable and camera cable on the display back-cover and antenna assembly [1].
2. Affix the adhesive that secures the camera cable [2].
3. Route the display cable and camera cable through the routing guides on the display back-cover and antenna assembly [3].

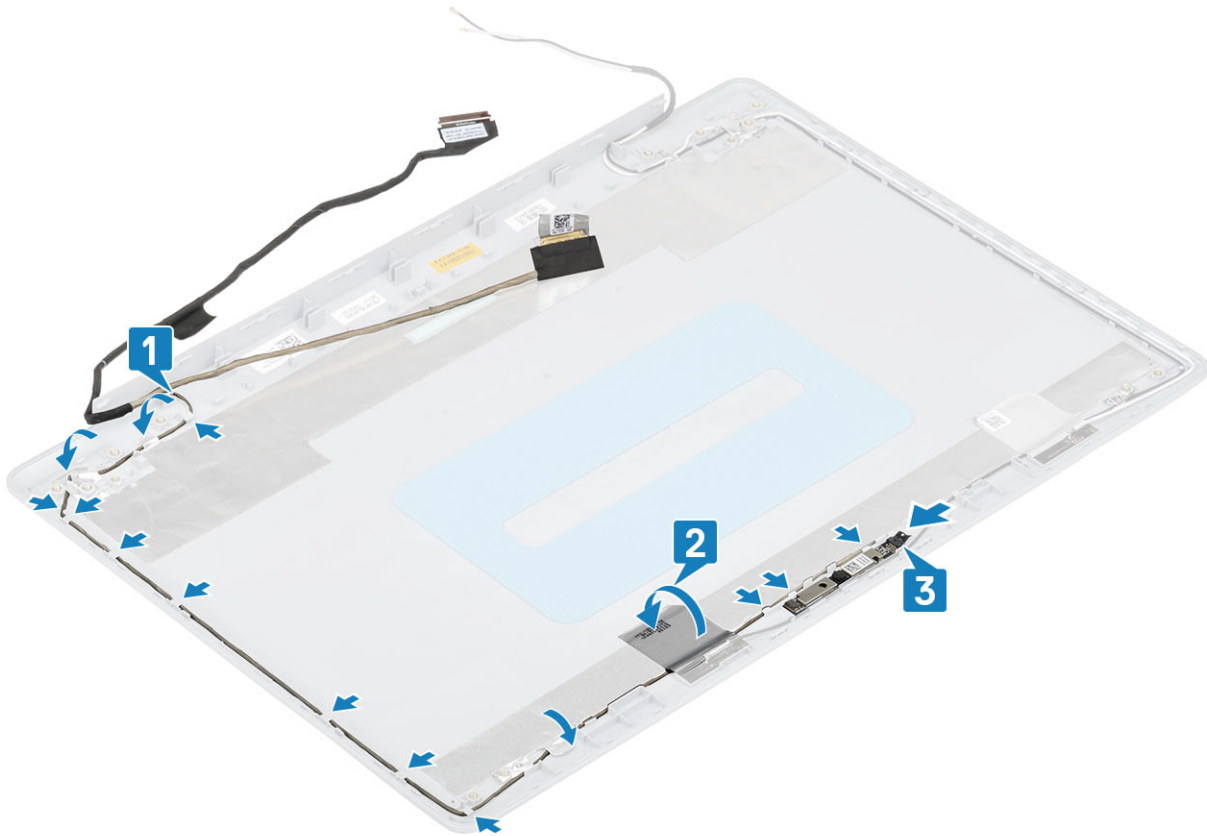

Next steps

1. Replace the [display hinges](#)
2. Replace the [display panel](#)
3. Replace the [display bezel](#)
4. Replace the [display assembly](#)
5. Replace the [hard drive assembly](#)
6. Replace the [system fan](#)
7. Replace the [heatsink](#)
8. Replace the [SSD](#)
9. Replace the [WLAN](#)
10. Replace the [battery](#)
11. Replace the [base cover](#)
12. Replace the [SD memory card](#)
13. Follow the procedure in [after working inside your computer](#)

Display back-cover and antenna assembly

Removing the display back-cover

Prerequisites

1. Follow the procedure in [before working inside your computer](#)
2. Remove the [SD memory card](#)
3. Remove the [base cover](#)
4. Remove the [battery](#)
5. Remove the [WLAN](#)
6. Remove the [SSD](#)

7. Remove the [hard drive assembly](#)
8. Remove the [system fan](#)
9. Remove the [heatsink](#)
10. Remove the [display assembly](#)
11. Remove the [display bezel](#)
12. Remove the [camera](#)
13. Remove the [display panel](#)
14. Remove the [display hinges](#)
15. Remove the [display cable](#)

About this task

After performing all the preceding steps, you are left with the display back-cover.

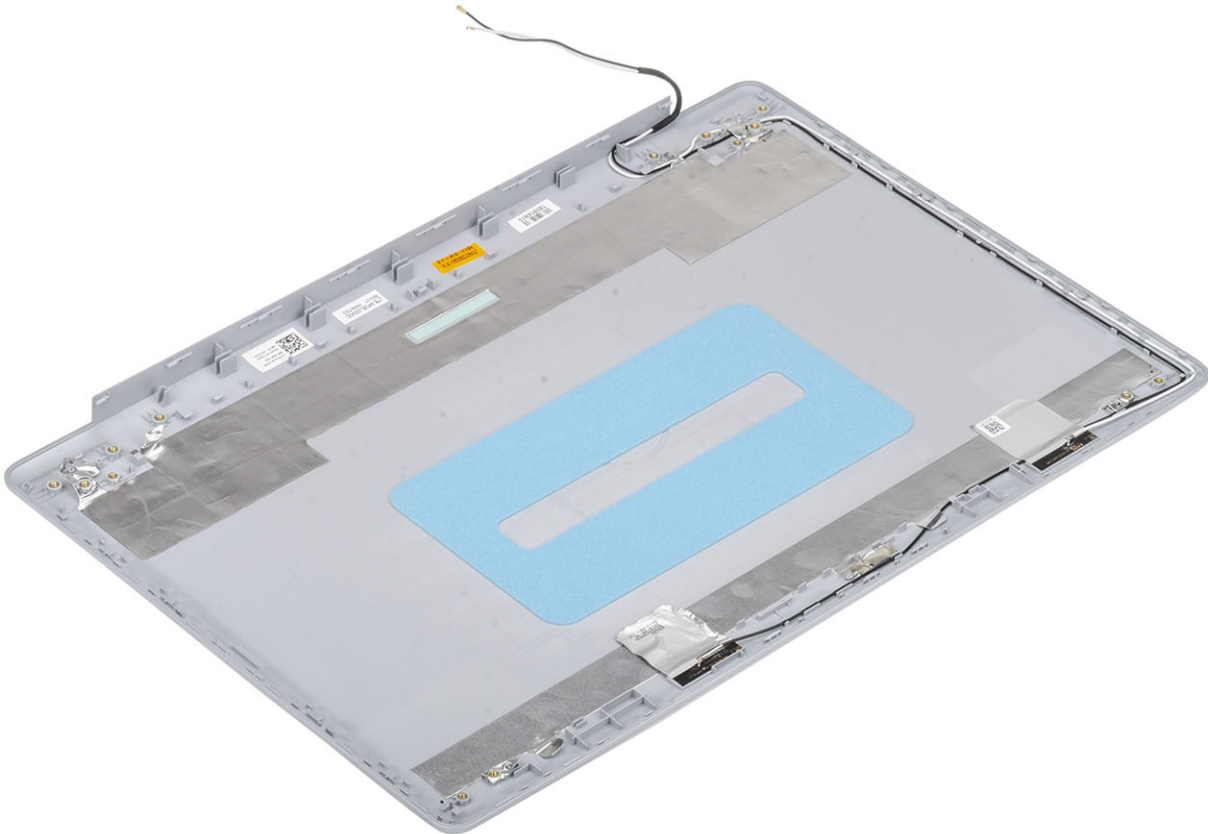

Installing the display back-cover

About this task

Place the display back-cover on a clean and flat surface.

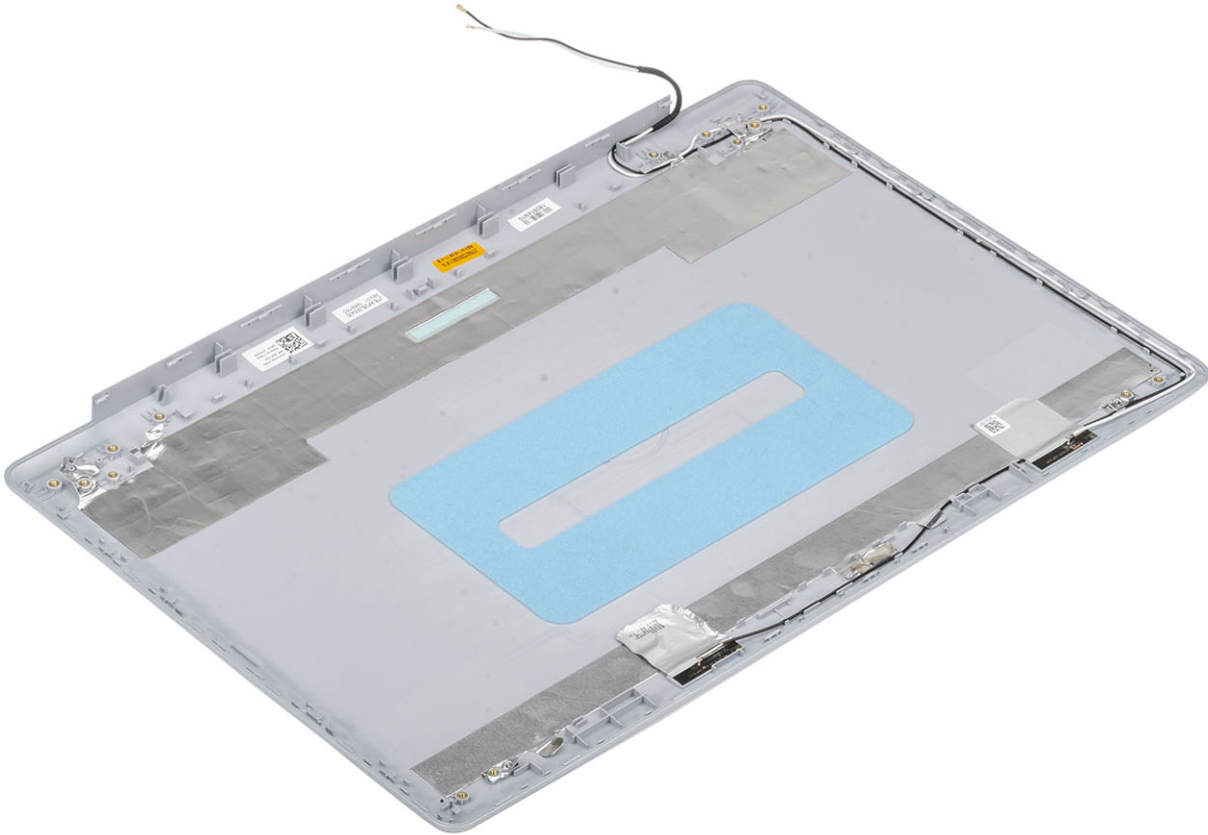

Next steps

1. Replace the [display cable](#)
2. Replace the [display hinges](#)
3. Replace the [display panel](#)
4. Replace the [camera](#)
5. Replace the [display bezel](#)
6. Replace the [display assembly](#)
7. Replace the [hard drive assembly](#)
8. Replace the [system fan](#)
9. Replace the [heatsink](#)
10. Replace the [SSD](#)
11. Replace the [WLAN](#)
12. Replace the [battery](#)
13. Replace the [base cover](#)
14. Replace the [SD memory card](#)
15. Follow the procedure in [after working inside your computer](#)

Palm-rest and keyboard assembly

Removing the palmrest and keyboard assembly

Prerequisites

1. Follow the procedure in [before working inside your computer](#)
2. Remove the [SD memory card](#)
3. Remove the [base cover](#)
4. Remove the [battery](#)
5. Remove the [memory](#)
6. Remove the [WLAN](#)
7. Remove the [SSD](#)
8. Remove the [speakers](#)
9. Remove the [coin-cell battery](#)
10. Remove the [hard drive assembly](#)
11. Remove the [system fan](#)
12. Remove the [heatsink](#)
13. Remove the [IO board](#)
14. Remove the [touchpad](#)
15. Remove the [display assembly](#)
16. Remove the [power button board](#)
17. Remove the [power button](#)
18. Remove the [display hinges](#)
19. Remove the [power adapter port](#)
20. Remove the [system board](#)

About this task

After performing the preceding steps, you are left with the palmrest and keyboard assembly.

 **NOTE:** The system board can be removed and installed together with the heatsink still attached.



System setup

System setup enables you to manage your hardware and specify BIOS level options. From the System setup, you can:

- Change the NVRAM settings after you add or remove hardware
- View the system hardware configuration
- Enable or disable integrated devices
- Set performance and power management thresholds
- Manage your computer security

Topics:

- [Boot menu](#)
- [Navigation keys](#)
- [System setup options](#)
- [System and setup password](#)

Boot menu

Press <F12> when the Dell logo appears to initiate a one-time boot menu with a list of the valid boot devices for the system. Diagnostics and BIOS Setup options are also included in this menu. The devices listed on the boot menu depend on the bootable devices in the system. This menu is useful when you are attempting to boot to a particular device or to bring up the diagnostics for the system. Using the boot menu does not make any changes to the boot order stored in the BIOS.

The options are:

- UEFI Boot:
 - Windows Boot Manager
- Other Options:
 - BIOS Setup
 - BIOS Flash Update
 - Diagnostics
 - Change Boot Mode Settings

Navigation keys

 **NOTE:** For most of the System Setup options, changes that you make are recorded but do not take effect until you restart the system.

Keys	Navigation
Up arrow	Moves to the previous field.
Down arrow	Moves to the next field.
Enter	Selects a value in the selected field (if applicable) or follow the link in the field.
Spacebar	Expands or collapses a drop-down list, if applicable.
Tab	Moves to the next focus area.
Esc	Moves to the previous page until you view the main screen. Pressing Esc in the main screen displays a message that prompts you to save any unsaved changes and restarts the system.

System setup options

NOTE: Depending on the and its installed devices, the items listed in this section may or may not appear.

General options

Table 2. General

Option	Description
System Information	Displays the following information: <ul style="list-style-type: none">System Information: Displays BIOS Version, Service Tag, Asset Tag, Ownership Tag, Ownership Date, Manufacture Date, and the Express Service Code.Memory Information: Displays Memory Installed, Memory Available, Memory Speed, Memory Channel Mode, Memory Technology, DIMM A size, and DIMM B sizeProcessor Information: Displays Processor Type, Core Count, Processor ID, Current Clock Speed, Minimum Clock Speed, Maximum Clock Speed, Processor L2 Cache, Processor L3 Cache, HT Capable, and 64-Bit Technology.Device Information: Displays Primary HDD, ODD Device, M.2 SATA SSD, M.2 PCIe SSD-0, LOM MAC Address, Video Controller, Video BIOS Version, Video Memory, Panel type, Native Resolution, Audio Controller, Wi-Fi Device, and Bluetooth Device.
Battery Information	Displays the battery status health and whether the AC adapter is installed.
Boot Sequence	Allows you to specify the order in which the computer attempts to find an operating system from the devices specified in this list.
Advanced Boot Options	Allows you to select the Legacy Option ROMs option, when in UEFI boot mode. By default, no option is selected. <ul style="list-style-type: none">Enable Legacy Option ROMsEnable Attempt Legacy Boot
UEFI Boot Path Security	This option controls whether or not the system will prompt the user to enter the Admin password when booting a UEFI boot path from the F12 Boot Menu. <ul style="list-style-type: none">Always, Except Internal HDD—DefaultAlwaysNever
Date/Time	Allows you to set the date and time settings. Changes to the system date and time take effect immediately.

System information

Table 3. System Configuration

Option	Description
Integrated NIC	Allows you to configure the on-board LAN controller. <ul style="list-style-type: none">Disabled = The internal LAN is off and not visible to the operating system.Enabled = The internal LAN is enabled.Enabled w/PXE = The internal LAN is enabled (with PXE boot) (selected by default)
SATA Operation	Allows you to configure the operating mode of the integrated hard drive controller. <ul style="list-style-type: none">Disabled = The SATA controllers are hiddenAHCI = SATA is configured for AHCI modeRAID ON = SATA is configured to support RAID mode (selected by default)

Option	Description
Drives	<p>Allows you to enable or disable the various drives on-board:</p> <ul style="list-style-type: none"> • SATA-0 (enabled by default) • SATA-1 (enabled by default) • SATA-2 (enabled by default) • M.2 PCIe SSD-0 (enabled by default)
Smart Reporting	<p>This field controls whether hard drive errors for integrated drives are reported during system startup. The Enable Smart Reporting option is disabled by default.</p>
USB Configuration	<p>Allows you to enable or disable the integrated USB controller for:</p> <ul style="list-style-type: none"> • Enable USB Boot Support • Enable External USB Port <p>All the options are enabled by default.</p>
Audio	<p>Allows you to enable or disable the integrated audio controller. The option Enable Audio is selected by default.</p> <ul style="list-style-type: none"> • Enable Microphone • Enable Internal Speaker <p>Both the options are selected by default.</p>
Miscellaneous Devices	<p>Allows you to enable or disable the following devices:</p> <ul style="list-style-type: none"> • Enable Camera (enabled by default)

Video

Option	Description
LCD Brightness	<p>Allows you to set the display brightness depending up on the power source—On Battery and On AC. The LCD brightness is independent for battery and AC adapter. It can be set using the slider.</p>

NOTE: The video setting is visible only when a video card is installed into the system.

Security

Table 4. Security

Option	Description
Admin Password	<p>Allows you to set, change, and delete the admin password.</p>
System Password	<p>Allows you to set, change, and delete the system password.</p>
Strong Password	<p>This option lets you enable or disable strong passwords for the system.</p>
Password Configuration	<p>Allows you to control the minimum and maximum number of characters allowed for a administrative password and the system password. The range of characters is between 4 and 32.</p>
Password Bypass	<p>This option lets you bypass the System (Boot) Password and the internal HDD password prompts during a system restart.</p> <ul style="list-style-type: none"> • Disabled — Always prompt for the system and internal HDD password when they are set. This option is enabled by default. • Reboot Bypass — Bypass the password prompts on Restarts (warm boots). <p>NOTE: The system will always prompt for the system and internal HDD passwords when powered on from the off state (a cold boot). Also, the system will always prompt for passwords on any module bay HDDs that may be present.</p>

Option	Description
Password Change	This option lets you determine whether changes to the System and Hard Disk passwords are permitted when an administrator password is set. Allow Non-Admin Password Changes - This option is enabled by default.
Non-Admin Setup Changes	Determines whether changes to the setup option are permitted when an administrator password is set.
UEFI Capsule Firmware Updates	This option controls whether this system allows BIOS updates via UEFI capsule update packages. This option is selected by default. Disabling this option will block BIOS updates from services such as Microsoft Windows Update and Linux Vendor Firmware Service (LVFS)
TPM 2.0 Security	Allows you to control whether the Trusted Platform Module (TPM) is visible to the operating system. <ul style="list-style-type: none"> TPM On (default) Clear PPI Bypass for Enable Commands PPI Bypass for Disable Commands PPI Bypass for Clear Commands Attestation Enable (default) Key Storage Enable (default) SHA-256 (default) Choose any one option: <ul style="list-style-type: none"> Disabled Enabled (default)
Computrace(R)	This field lets you Activate or Disable the BIOS module interface of the optional Computrace Service from Absolute Software. Enables or disables the optional Computrace service designed for asset management. <ul style="list-style-type: none"> Deactivate Disable Activate - This option is selected by default.
OROM Keyboard Access	This option determines whether users are able to enter Option ROM configuration screen via hotkeys during boot. <ul style="list-style-type: none"> Enabled (default) Disabled One Time Enable
Admin Setup Lockout	Allows you to prevent users from entering Setup when Admin password is set. This option is not set by default.
Master Password Lockout	Allows you to disable master password support Hard Disk passwords need to be cleared before the settings can be changed. This option is not set by default.
SMM Security Mitigation	Allows you to enable or disable additional UEFI SMM Security Mitigation protections. This option is not set by default.

Secure boot

Table 5. Secure Boot

Option	Description
Secure Boot Enable	Allows you to enable or disable Secure Boot feature <ul style="list-style-type: none"> Secure Boot Enable This option is selected by default.

Option	Description
Secure Boot Mode	<p>Allows you to modify the behavior of Secure Boot to allow evaluation or enforcement of UEFI driver signatures.</p> <ul style="list-style-type: none"> · Deployed Mode (default) · Audit Mode
Expert key Management	<p>Allows you to manipulate the security key databases only if the system is in Custom Mode. The Enable Custom Mode option is disabled by default. The options are:</p> <ul style="list-style-type: none"> · PK (default) · KEK · db · dbx <p>If you enable the Custom Mode, the relevant options for PK, KEK, db, and dbx appear. The options are:</p> <ul style="list-style-type: none"> · Save to File- Saves the key to a user-selected file · Replace from File- Replaces the current key with a key from a user-selected file · Append from File- Adds a key to the current database from a user-selected file · Delete- Deletes the selected key · Reset All Keys- Resets to default setting · Delete All Keys- Deletes all the keys <p> NOTE: If you disable the Custom Mode, all the changes made will be erased and the keys will restore to default settings.</p>

Intel Software Guard Extensions

Table 6. Intel Software Guard Extensions

Option	Description
Intel SGX Enable	<p>This field specifies you to provide a secured environment for running code/storing sensitive information in the context of the main OS.</p> <p>Click one of the following options:</p> <ul style="list-style-type: none"> · Disabled · Enabled · Software controlled—Default
Enclave Memory Size	<p>This option sets SGX Enclave Reserve Memory Size</p> <p>Click one of the following options:</p> <ul style="list-style-type: none"> · 32 MB · 64 MB · 128 MB—Default

Performance

Table 7. Performance

Option	Description
Multi Core Support	<p>This field specifies whether the process has one or all cores enabled. The performance of some applications improves with the additional cores.</p> <ul style="list-style-type: none"> · All—Default · 1

Option	Description
Intel SpeedStep	<p>Allows you to enable or disable the Intel SpeedStep mode of processor.</p> <ul style="list-style-type: none"> • Enable Intel SpeedStep <p>This option is set by default.</p>
C-States Control	<p>Allows you to enable or disable the additional processor sleep states.</p> <ul style="list-style-type: none"> • C states <p>This option is set by default.</p>
Intel TurboBoost	<p>Allows you to enable or disable the Intel TurboBoost mode of the processor.</p> <ul style="list-style-type: none"> • Enable Intel TurboBoost <p>This option is set by default.</p>
Hyper-Thread Control	<p>Allows you to enable or disable the HyperThreading in the processor.</p> <ul style="list-style-type: none"> • Disabled • Enabled—Default

Power management

Option	Description
AC Behavior	<p>Allows you to enable or disable the computer from turning on automatically when an AC adapter is connected.</p> <p>Default setting: Wake on AC is not selected.</p>
Enable Intel Speed Shift Technology	<ul style="list-style-type: none"> • Enable Intel Speed Shift Technology <p>Default setting: Enabled</p>
Auto On Time	<p>Allows you to set the time at which the computer must turn on automatically. The options are:</p> <ul style="list-style-type: none"> • Disabled • Every Day • Weekdays • Select Days <p>Default setting: Disabled</p>
USB Wake Support	<p>Allows you to enable USB devices to wake the system from Standby.</p> <p> NOTE: This feature is only functional when the AC power adapter is connected. If the AC power adapter is removed during Standby, the system setup removes power from all the USB ports to conserve battery power.</p> <ul style="list-style-type: none"> • Enable USB Wake Support
Wake on WLAN	<p>Allows you to enable or disable the feature that powers on the computer from the Off state when triggered by a LAN signal.</p> <ul style="list-style-type: none"> • Disabled • WLAN <p>Default setting: Disabled</p>
Peak Shift	<p>This option enables you to minimize the AC power consumption during the peak power times of day. After you enable this option, your system runs only in battery even if the AC is attached.</p> <ul style="list-style-type: none"> • Enable peak shift—is disabled

Option	Description
	<ul style="list-style-type: none"> Set battery threshold (15% to 100%) - 15 % (enabled by default)
Advanced Battery Charge Configuration	<p>This option enables you to maximize the battery health. By enabling this option, your system uses the standard charging algorithm and other techniques, during the non work hours to improve the battery health.</p> <p>Enable Advanced Battery Charge Mode- is disabled</p>
Primary Battery Charge Configuration	<p>Allows you to select the charging mode for the battery. The options are:</p> <ul style="list-style-type: none"> Adaptive—enabled by default Standard—Fully charges your battery at a standard rate. ExpressCharge—The battery charges over a shorter time using Dell’s fast charging technology. Primarily AC use Custom <p>If Custom Charge is selected, you can also configure Custom Charge Start and Custom Charge Stop.</p> <p>NOTE: All charging mode may not be available for all the batteries. To enable this option, disable the Advanced Battery Charge Configuration option.</p>

POST behavior

Option	Description
Adapter Warnings	<p>Allows you to enable or disable the system setup (BIOS) warning messages when you use certain power adapters.</p> <p>Default setting: Enable Adapter Warnings</p>
Numlock Enable	<p>Allows you to enable the Numlock option when the computer boots.</p> <p>Enable Network. This option is enabled by default.</p>
Fn Lock Options	<p>Allows you to let hot key combinations Fn + Esc toggle the primary behavior of F1–F12, between their standard and secondary functions. If you disable this option, you cannot toggle dynamically the primary behavior of these keys. The available options are:</p> <ul style="list-style-type: none"> Fn Lock—enabled by default Lock Mode Disable/Standard—enabled by default Lock Mode Enable/Secondary
Fastboot	<p>Allows you to speed up the boot process by bypassing some of the compatibility steps. The options are:</p> <ul style="list-style-type: none"> Minimal—enabled by default Thorough Auto
Extended BIOS POST Time	<p>Allows you to create an extra preboot delay. The options are:</p> <ul style="list-style-type: none"> 0 seconds—enabled by default. 5 seconds 10 seconds
Full Screen Log	<ul style="list-style-type: none"> Enable Full Screen Logo—not enabled
Warnings and errors	<ul style="list-style-type: none"> Prompt on warnings and errors—enabled by default Continue on warnings Continue on warnings and errors
Sign of Life Indication	<ul style="list-style-type: none"> Enable Sign of Life Keyboard Backlight Indication—enabled by default

Virtualization support

Option	Description
Virtualization	<p>This field specifies whether a virtual Machine Monitor (VMM) can utilize the conditional hardware capabilities provided by Intel Virtualization Technology.</p> <p>Enable Intel Virtualization Technology—enabled by default.</p>
VT for Direct I/O	<p>Enables or disables the Virtual Machine Monitor (VMM) from utilizing the additional hardware capabilities provided by Intel® Virtualization technology for direct I/O.</p> <p>Enable VT for Direct I/O - enabled by default.</p>
Trusted Execution	<p>This option specifies whether a Measured Virtual Machine Monitor (MVMM) can utilize the additional hardware capabilities provided by Intel Trusted Execution Technology. The TPM Virtualization Technology, and the Virtualization technology for direct I/O must be enabled to use this feature.</p> <p>Trusted Execution - disabled by default.</p>

Wireless

Option	Description
Wireless Switch	<p>Allows to set the wireless devices that can be controlled by the wireless switch. The options are:</p> <ul style="list-style-type: none">· WLAN· Bluetooth <p>All the options are enabled by default.</p> <p> NOTE: For WLAN enable or disable controls are tied together and they cannot be enabled or disabled independently.</p>
Wireless Device Enable	<p>Allows you to enable or disable the internal wireless devices.</p> <ul style="list-style-type: none">· WLAN· Bluetooth <p>All the options are enabled by default.</p>

Maintenance screen

Option	Description
Service Tag	<p>Displays the Service Tag of your computer.</p>
Asset Tag	<p>Allows you to create a system asset tag if an asset tag is not already set. This option is not set by default.</p>
BIOS Downgrade	<p>This controls flashing of the system firmware to previous revisions. Option 'Allow BIOS downgrade' is enabled by default.</p>
Data Wipe	<p>This field allows users to erase the data securely from all internal storage devices. Option 'Wipe on Next boot' is not enabled by default. The following is list of devices affected:</p> <ul style="list-style-type: none">· Internal SATA HDD/SSD· Internal M.2 SATA SDD· Internal M.2 PCIe SSD· Internal eMMC
BIOS Recovery	<p>This field allows you to recover from certain corrupted BIOS conditions from a recover file on the user primary hard drive or an external USB key.</p> <ul style="list-style-type: none">· BIOS Recovery from Hard Drive—enabled by default· Always perform integrity check—disabled by default

System logs

Option	Description
BIOS Events	Allows you to view and clear the System Setup (BIOS) POST events.
Thermal Events	Allows you to view and clear the System Setup (Thermal) events.
Power Events	Allows you to view and clear the System Setup (Power) events.

SupportAssist System Resolution

Option	Description
Auto OS Recovery Threshold	Allows you to control the automatic boot flow for SupportAssist System. Options are: <ul style="list-style-type: none">· Off· 1· 2 (Enabled by default)· 3
SupportAssist OS Recovery	Allows you to recover the SupportAssist OS Recovery (Disabled by default)

System and setup password

Table 8. System and setup password

Password type	Description
System password	Password that you must enter to log on to your system.
Setup password	Password that you must enter to access and make changes to the BIOS settings of your computer.

You can create a system password and a setup password to secure your computer.

 **CAUTION:** The password features provide a basic level of security for the data on your computer.

 **CAUTION:** Anyone can access the data stored on your computer if it is not locked and left unattended.

 **NOTE:** System and setup password feature is disabled.

Assigning a system setup password

Prerequisites

You can assign a new **System or Admin Password** only when the status is in **Not Set**.

About this task

To enter the system setup, press F2 immediately after a power-on or re-boot.

Steps

1. In the **System BIOS** or **System Setup** screen, select **Security** and press Enter. The **Security** screen is displayed.
2. Select **System/Admin Password** and create a password in the **Enter the new password** field. Use the following guidelines to assign the system password:
 - A password can have up to 32 characters.

- The password can contain the numbers 0 through 9.
 - Only lower case letters are valid, upper case letters are not allowed.
 - Only the following special characters are allowed: space, ("), (+), (,), (-), (.), (/), (:), ([), (\), (]), (`).
3. Type the system password that you entered earlier in the **Confirm new password** field and click **OK**.
 4. Press Esc and a message prompts you to save the changes.
 5. Press Y to save the changes.
The computer reboots.

Deleting or changing an existing system setup password

Prerequisites

Ensure that the **Password Status** is Unlocked (in the System Setup) before attempting to delete or change the existing System and/or Setup password. You cannot delete or change an existing System or Setup password, if the **Password Status** is Locked.

About this task

To enter the System Setup, press F2 immediately after a power-on or reboot.

Steps

1. In the **System BIOS** or **System Setup** screen, select **System Security** and press Enter.
The **System Security** screen is displayed.
2. In the **System Security** screen, verify that **Password Status** is **Unlocked**.
3. Select **System Password**, alter or delete the existing system password and press Enter or Tab.
4. Select **Setup Password**, alter or delete the existing setup password and press Enter or Tab.
 **NOTE: If you change the System and/or Setup password, re-enter the new password when prompted. If you delete the System and/or Setup password, confirm the deletion when prompted.**
5. Press Esc and a message prompts you to save the changes.
6. Press Y to save the changes and exit from System Setup.
The computer reboot.

Troubleshooting

Enhanced Pre-Boot System Assessment (ePSA) diagnostics

About this task

The ePSA diagnostics (also known as system diagnostics) performs a complete check of your hardware. The ePSA is embedded with the BIOS and is launched by the BIOS internally. The embedded system diagnostics provides a set of options for particular devices or device groups allowing you to:

- Run tests automatically or in an interactive mode
- Repeat tests
- Display or save test results
- Run thorough tests to introduce additional test options to provide extra information about the failed device(s)
- View status messages that inform you if tests are completed successfully
- View error messages that inform you of problems encountered during testing

NOTE: Some tests for specific devices require user interaction. Always ensure that you are present at the computer terminal when the diagnostic tests are performed.

Running the ePSA diagnostics

Steps

1. Turn on your computer.
2. As the computer boots, press the F12 key as the Dell logo appears.
3. On the boot menu screen, select the **Diagnostics** option.
4. Click the arrow at the bottom left corner.
Diagnostics front page is displayed.
5. Click the arrow in the lower-right corner to go to the page listing.
The items detected are listed.
6. To run a diagnostic test on a specific device, press Esc and click **Yes** to stop the diagnostic test.
7. Select the device from the left pane and click **Run Tests**.
8. If there are any issues, error codes are displayed.
Note the error code and validation number and contact Dell.

System diagnostic lights

Battery-status light

Indicates the power and battery-charge status.

Solid white — Power adapter is connected and the battery has more than 5 percent charge.

Amber — Computer is running on battery and the battery has less than 5 percent charge.

Off

- Power adapter is connected and the battery is fully charged.
- Computer is running on battery and the battery has more than 5 percent charge.
- Computer is in sleep state, hibernation, or turned off.

The power and battery-status light blinks amber along with beep codes indicating failures.

For example, the power and battery-status light blinks amber two times followed by a pause, and then blinks white three times followed by a pause. This 2,3 pattern continues until the computer is turned off indicating no memory or RAM is detected.

The following table shows different power and battery-status light patterns and associated problems.

Table 9. LED codes

Diagnostic light codes	Problem description
2,1	Processor failure
2,2	System board: BIOS or ROM (Read-Only Memory) failure
2,3	No memory or RAM (Random-Access Memory) detected
2,4	Memory or RAM (Random-Access Memory) failure
2,5	Invalid memory installed
2,6	System-board or chipset error
2,7	Display failure
2,8	LCD power rail failure. Replace system board
3,1	Coin-cell battery failure
3,2	PCI, video card/chip failure
3,3	Recovery image not found
3,4	Recovery image found but invalid
3,5	Power-rail failure
3,6	System BIOS Flash incomplete
3,7	Management Engine (ME) error

Camera status light: Indicates whether the camera is in use.

- Solid white — Camera is in use.
- Off — Camera is not in use.

Caps Lock status light: Indicates whether Caps Lock is enabled or disabled.

- Solid white — Caps Lock enabled.
- Off — Caps Lock disabled.

Flashing BIOS (USB key)

Steps

1. Follow the procedure from step 1 to step 7 in "[Flashing the BIOS](#)" to download the latest BIOS setup program file.
2. Create a bootable USB drive. For more information see the knowledge base article [SLN143196](#) at www.dell.com/support.
3. Copy the BIOS setup program file to the bootable USB drive.
4. Connect the bootable USB drive to the computer that needs the BIOS update.
5. Restart the computer and press **F12** when the Dell logo is displayed on the screen.
6. Boot to the USB drive from the **One Time Boot Menu**.
7. Type the BIOS setup program filename and press **Enter**.
8. The **BIOS Update Utility** appears. Follow the instructions on the screen to complete the BIOS update.

Flashing the BIOS

About this task

You may need to flash (update) the BIOS when an update is available or when you replace the system board.

Follow these steps to flash the BIOS:

Steps

1. Turn on your computer.
 2. Go to www.dell.com/support.
 3. Click **Product support**, enter the Service Tag of your computer, and then click **Submit**.
-  **NOTE: If you do not have the Service Tag, use the auto-detect feature or manually browse for your computer model.**
4. Click **Drivers & downloads > Find it myself**.
 5. Select the operating system installed on your computer.
 6. Scroll down the page and expand **BIOS**.
 7. Click **Download** to download the latest version of the BIOS for your computer.
 8. After the download is complete, navigate to the folder where you saved the BIOS update file.
 9. Double-click the BIOS update file icon and follow the instructions on the screen.

Backup media and recovery options

It is recommended to create a recovery drive to troubleshoot and fix problems that may occur with Windows. Dell proposes multiple options for recovering Windows operating system on your Dell PC. For more information, see [Dell Windows Backup Media and Recovery Options](#).

WiFi power cycle

About this task

If your computer is unable to access the internet due to WiFi connectivity issues a WiFi power cycle procedure may be performed. The following procedure provides the instructions on how to conduct a WiFi power cycle:

 **NOTE: Some ISPs (Internet Service Providers) provide a modem/router combo device.**

Steps

1. Turn off your computer.
2. Turn off the modem.
3. Turn off the wireless router.
4. Wait for 30 seconds.
5. Turn on the wireless router.
6. Turn on the modem.
7. Turn on your computer.

Flea power release

About this task

Flea power is the residual static electricity that remains on the computer even after it has been powered off and the battery has been removed. The following procedure provides the instructions on how to conduct flea power release:

Steps

1. Turn off your computer.
2. Disconnect the power adapter from your computer.
3. Press and hold the power button for 15 seconds to drain the flea power.
4. Connect the power adapter to your computer.
5. Turn on your computer.

Getting help

Topics:

- [Contacting Dell](#)

Contacting Dell

Prerequisites

 **NOTE:** If you do not have an active Internet connection, you can find contact information on your purchase invoice, packing slip, bill, or Dell product catalog.

About this task

Dell provides several online and telephone-based support and service options. Availability varies by country and product, and some services may not be available in your area. To contact Dell for sales, technical support, or customer service issues:

Steps

1. Go to **Dell.com/support**.
2. Select your support category.
3. Verify your country or region in the **Choose a Country/Region** drop-down list at the bottom of the page.
4. Select the appropriate service or support link based on your need.