

**SAMSUNG**

# USER MANUAL

SM-G980F  
SM-G980F/DS  
SM-G981B  
SM-G981B/DS  
SM-G985F  
SM-G985F/DS  
SM-G986B  
SM-G986B/DS  
SM-G988B  
SM-G988B/DS

# Table of Contents

## Basics

- 4 Read me first
- 7 Device overheating situations and solutions
- 10 Device layout and functions
- 16 Battery
- 23 Nano-SIM card and eSIM
- 26 Memory card (microSD card)
- 28 Turning the device on and off
- 30 Initial setup
- 30 Samsung account
- 32 Transferring data from your previous device (Smart Switch)
- 35 Understanding the screen
- 46 Notification panel
- 48 Screen capture and screen record
- 50 Entering text

## Apps and features

- 53 Installing or uninstalling apps
- 55 Bixby
- 60 Bixby Vision
- 63 Bixby Routines
- 66 Phone
- 71 Contacts
- 75 Messages
- 78 Internet

- 80 Camera
- 102 Gallery
- 110 AR Zone
- 122 Always On Display
- 123 Edge screen
- 127 Multi window
- 130 Samsung Daily
- 131 Samsung Pay
- 134 Samsung Health
- 137 Samsung Members
- 137 Samsung Notes
- 138 Galaxy Wearable
- 138 Calendar
- 139 Reminder
- 141 Voice Recorder
- 144 My Files
- 144 Clock
- 146 Calculator
- 146 Game Launcher
- 148 Game Booster
- 149 Kids Home
- 150 SmartThings
- 154 Sharing content
- 157 Music Share
- 158 Samsung DeX
- 165 Link to Windows
- 167 Samsung Global Goals
- 167 Google apps

## Settings

- 169 Introduction
- 169 Connections
  - 170 Wi-Fi
  - 172 Bluetooth
  - 173 NFC and payment
  - 175 Data saver
  - 176 Mobile data only apps
  - 176 SIM card manager (dual SIM models)
  - 177 Mobile Hotspot and Tethering
  - 178 More connection settings
- 180 Sounds and vibration
  - 181 Dolby Atmos (surround sound)
  - 181 Separate app sound
- 182 Notifications
  - 182 App icon badges
- 183 Display
  - 184 Dark mode settings
  - 185 Motion smoothness
  - 185 Blue light filter
  - 186 Changing the screen mode or adjusting the display colour
  - 187 Font size and style
  - 187 Screen resolution
  - 187 Screensaver
- 188 Wallpaper
- 188 Themes
- 188 Lock screen
  - 189 Smart Lock
- 190 Biometrics and security
  - 191 Face recognition
  - 194 Fingerprint recognition
  - 198 Samsung Pass
  - 201 Secure Folder
  - 205 Secure Wi-Fi
- 206 Privacy
- 207 Location
- 207 Accounts and backup
  - 208 Samsung Cloud
- 209 Google
- 210 Advanced features
  - 211 Motions and gestures
  - 212 Dual Messenger
- 213 Digital Wellbeing and parental controls
  - 213 Digital Wellbeing
- 215 Device care
  - 215 Optimising your device
  - 216 Battery
  - 217 Storage
  - 217 Memory
  - 217 Security
- 218 Apps
- 218 General management
- 219 Accessibility
- 219 Software update
- 220 About phone

## Appendix

- 221 Accessibility
- 239 FAQ
- 246 Troubleshooting
- 251 Removing the battery

# Basics

## Read me first

Please read this manual before using the device to ensure safe and proper use.

- Descriptions are based on the device's default settings.
- Some content may differ from your device depending on the region, service provider, model specifications, or device's software.
- Content (high quality content) that requires high CPU and RAM usage will affect the overall performance of the device. Apps related to the content may not work properly depending on the device's specifications and the environment that it is used in.
- Samsung is not liable for performance issues caused by apps supplied by providers other than Samsung.
- Samsung is not liable for performance issues or incompatibilities caused by edited registry settings or modified operating system software. Attempting to customise the operating system may cause the device or apps to work improperly.
- Software, sound sources, wallpapers, images, and other media provided with this device are licensed for limited use. Extracting and using these materials for commercial or other purposes is an infringement of copyright laws. Users are entirely responsible for illegal use of media.
- You may incur additional charges for data services, such as messaging, uploading and downloading, auto-syncing, or using location services depending on your data plan. For large data transfers, it is recommended to use the Wi-Fi feature.
- Default apps that come with the device are subject to updates and may no longer be supported without prior notice. If you have questions about an app provided with the device, contact a Samsung Service Centre. For user-installed apps, contact service providers.
- Modifying the device's operating system or installing softwares from unofficial sources may result in device malfunctions and data corruption or loss. These actions are violations of your Samsung licence agreement and will void your warranty.

- Depending on the region or service provider, a screen protector is attached for protection during production and distribution. Damage to the attached screen protector is not covered by the warranty.
- You can see the touchscreen clearly even in strong outdoor sunlight by automatically adjusting the contrast range based on the surrounding environment. Due to the nature of the product, displaying fixed graphics for extended periods may result in afterimages (screen burn-in) or ghosting.
  - It is recommended not to use fixed graphics on part or all of the touchscreen for extended periods and turn off the touchscreen when not using the device.
  - You can set the touchscreen to turn off automatically when you are not using it. Launch the **Settings** app, tap **Display** → **Screen timeout**, and then select the length of time you want the device to wait before turning off the touchscreen.
  - To set the touchscreen to automatically adjust its brightness based on the surrounding environment, launch the **Settings** app, tap **Display**, and then tap the **Adaptive brightness** switch to activate it.
- Depending on the region or model, some devices are required to receive approval from the Federal Communications Commission (FCC).

If your device is approved by the FCC, you can view the FCC ID of the device. To view the FCC ID, launch the **Settings** app and tap **About phone** → **Status**. If your device does not have an FCC ID, it means that the device has not been authorised for sale in the U.S. or its territories and may only be brought to the U.S. for the owner's personal use.

- Depending on the region, you can view the regulatory information on the device. To view the information, launch the **Settings** app and tap **About phone** → **Regulatory information**.

## Maintaining water and dust resistance

Your device supports water- and dust-resistance. Follow these tips carefully to maintain the water- and dust-resistance of your device. Failure to do so may result in damage to your device.

- Do not immerse the device in fresh water deeper than 1.5 m or keep it submerged for more than 30 minutes. If you immerse the device in any liquid other than fresh water, such as salt water, ionised water, or alcoholic beverage, liquid will enter the device faster.
- Do not expose the device to **water moving with force**.
- If the device is exposed to fresh water, dry it thoroughly with a clean, soft cloth. If the device is exposed to other liquids, such as salt water, swimming pool water, soapy water, oil, perfume, sunscreen, hand cleaner, or chemical products such as cosmetics, rinse it with fresh water and dry it thoroughly with a clean, soft cloth. If you do not follow these instructions, the device's performance and appearance may be affected.
- **If the device has been immersed in water or the microphone or speaker is wet**, sound may not be heard clearly during a call. After wiping the device with a dry cloth, dry it thoroughly before using it.
- The touchscreen and other features may not work properly **if the device is used in water**.
- **If the device is dropped or receives an impact**, the water- and dust-resistant features of the device may be damaged.
- **Your device has been tested in a controlled environment and certified to be water- and dust-resistant in specific situations (meets requirements of classification IP68 as described by the international standard IEC 60529-Degrees of Protection provided by Enclosures [IP Code]; test conditions: 15-35 °C, 86-106 kPa, fresh water, 1.5 metre, 30 minutes). Despite this classification, it is still possible for your device to be damaged in certain situations.**

## Instructional icons



**Warning:** situations that could cause injury to yourself or others



**Caution:** situations that could cause damage to your device or other equipment



**Notice:** notes, usage tips, or additional information

## Device overheating situations and solutions

### When the device heats up while charging the battery

While charging, the device and the charger may become hot. During wireless charging or fast charging, the device may feel hotter to the touch. This does not affect the device's lifespan or performance and is in the device's normal range of operation. If the battery becomes too hot, the charging speed may decrease or the charger may stop charging.

#### Do the following when the device heats up:

- Disconnect the charger from the device and close any running apps. Wait for the device to cool down and then begin charging the device again.
- If the lower part of the device overheats, it could be because the connected USB cable is damaged. Replace the damaged USB cable with a new Samsung-approved one.
- When using a wireless charger, do not place foreign materials, such as metal objects, magnets, and magnetic stripe cards, between the device and the wireless charger.



The wireless charging or fast charging feature is only available on supported models.

### When the device heats up during use

When you use features or apps that require more power or use them for extended periods, your device may temporarily heat up due to increased battery consumption. Close any running apps and do not use the device for a while.

The following are examples of situations in which the device may overheat. Depending on the functions and apps you use, these examples may not apply to your model.

- During the initial setup after purchase or when restoring data
- When downloading large files

- When using apps that require more power or using apps for extended periods
  - When playing high-quality games for extended periods
  - When recording videos for extended periods
  - When streaming videos while using the maximum brightness setting
  - When connecting to a TV
- While multitasking (or, when running many apps in the background)
  - When using Multi window
  - When updating or installing apps while recording videos
  - When downloading large files during a video call
  - When recording videos while using a navigation app
- When using large amount of data for syncing with the cloud, email, or other accounts
- When using a navigation app in a car while the device is placed in direct sunlight
- When using the mobile hotspot and tethering feature
- When using the device in areas with weak signals or no reception
- When charging the battery with a damaged USB cable
- When the device's multipurpose jack is damaged or exposed to foreign materials, such as liquid, dust, metal powder, and pencil lead
- When you are roaming

### **Do the following when the device heats up:**

- Keep the device updated with the latest software.
- Conflicts between running apps may cause the device to heat up. Restart the device.
- Deactivate the Wi-Fi, GPS, and Bluetooth features when not using them.
- Close apps that increase battery consumption or that run in the background when not in use.
- Delete unnecessary files or unused apps.
- Decrease the screen brightness.
- If the device overheats or feels hot for a prolonged period, do not use it for a while. If the device continues to overheat, contact a Samsung Service Centre.



## Precautions for device overheating

If you begin to feel uncomfortable due to the device overheating, stop using the device.

When the device heats up, the features and performance may be limited or the device may turn off to cool down. The feature is only available on supported models.

- If the device overheats and reaches a certain temperature, a warning message will appear to prevent device failure, skin irritations and damages, and battery leakage. To lower the device's temperature, the screen brightness and the performance speed will be limited and battery charging will stop. Running apps will be closed and all calling and other features will be limited, except for emergency calls, until the device cools down.
- If the second message appears due to a further increase of the device's temperature, the device will turn off. Do not use the device until the device's temperature drops below the specified level. If the second warning message appears during an emergency call, the call will not be disconnected by a forced shut down.

## Precautions for operating environment

Your device may heat up due to the environment in the following conditions. Use caution to avoid shortening the battery's lifespan, damaging the device, or causing a fire.

- Do not store your device in very cold or very hot temperatures.
- Do not expose your device to direct sunlight for extended periods.
- Do not use or store your device for extended periods in very hot areas, such as inside a car in the summertime.
- Do not place the device in any areas that may overheat, such as on an electric heating mat.
- Do not store your device near or in heaters, microwaves, hot cooking equipment, or high pressure containers.
- Do not use a cable whose covering is peeled off or damaged, and do not use any charger or battery that is damaged or malfunctioning.

# Device layout and functions

## Package contents

Refer to the quick start guide for package contents.



- The items supplied with the device and any available accessories may vary depending on the region or service provider.
- The supplied items are designed only for this device and may not be compatible with other devices.
- Appearances and specifications are subject to change without prior notice.
- You can purchase additional accessories from your local Samsung retailer. Make sure they are compatible with the device before purchase.
- Use only Samsung-approved accessories. Using unapproved accessories may cause the performance problems and malfunctions that are not covered by the warranty.
- Availability of all accessories is subject to change depending entirely on manufacturing companies. For more information about available accessories, refer to the Samsung website.
- The supplied earphones (USB Type-C) which support digital output are designed only for this device. They may not be compatible with other devices that use different audio output method.

## Device layout

### ► Galaxy S20 Ultra 5G, S20 Ultra:

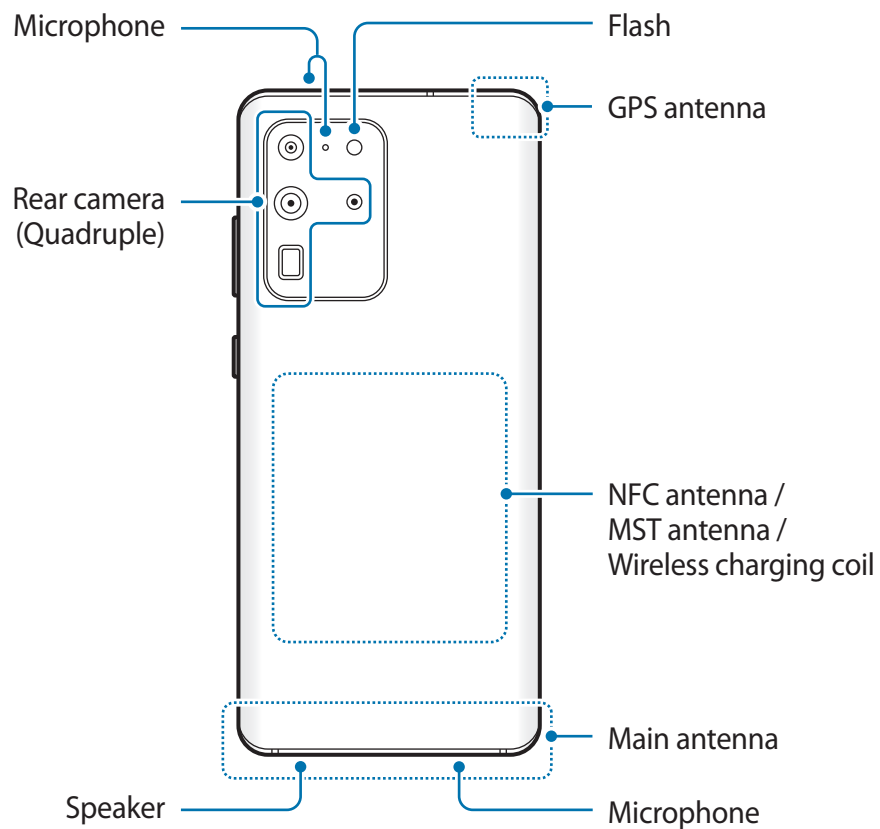
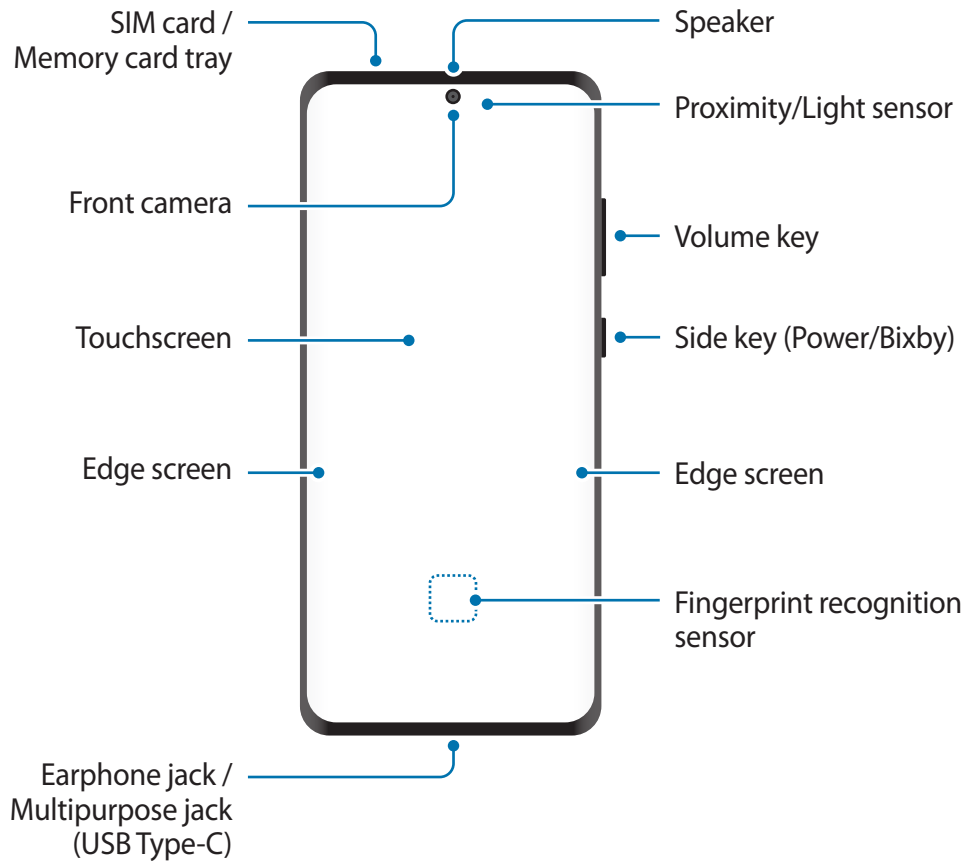

► **Galaxy S20+ 5G, S20+:**

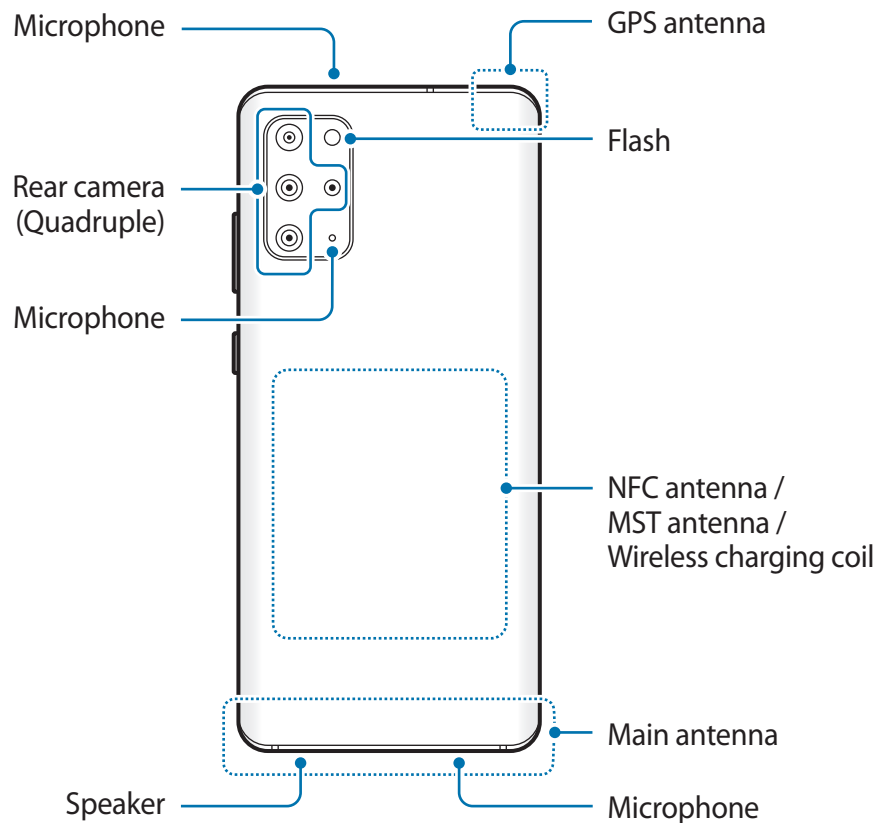
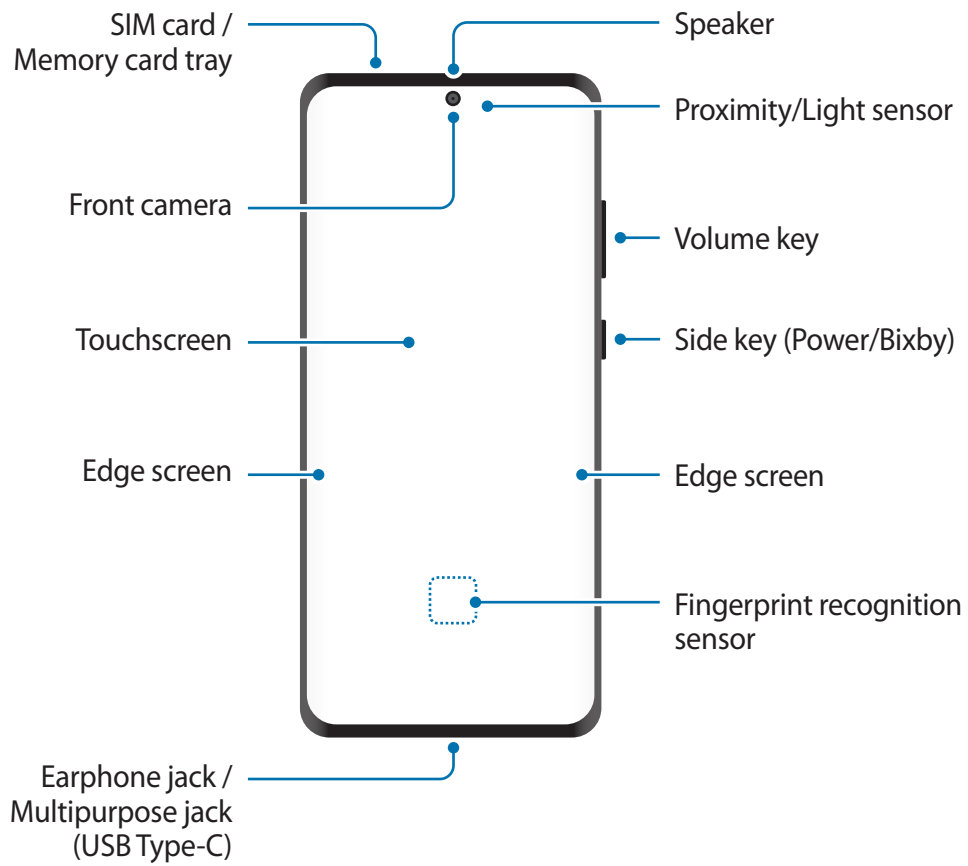

► Galaxy S20 5G, S20:

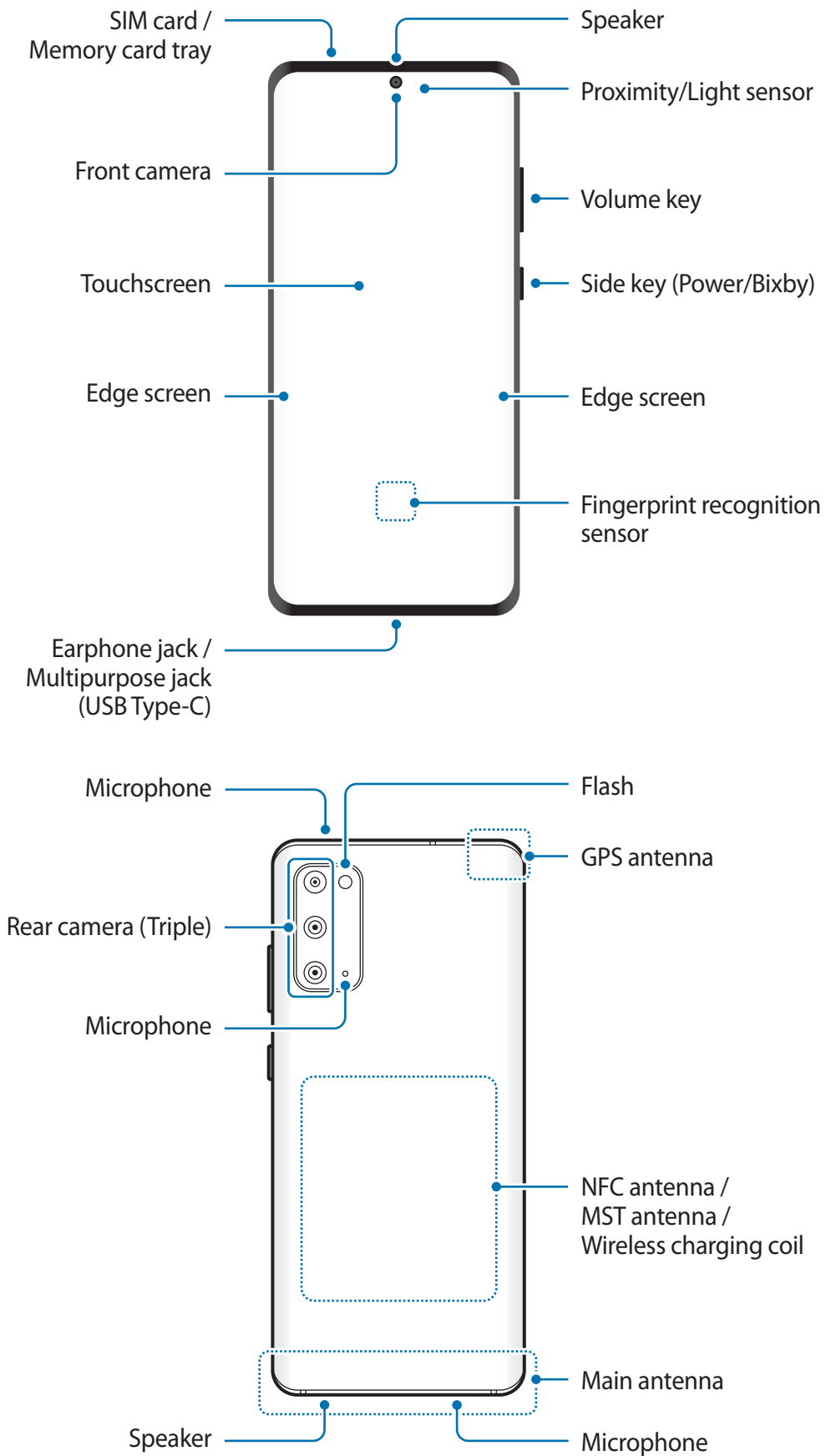



- When using the speakers, such as when playing media files or using speakerphone, do not place the device close to your ears.
- Be careful not to expose the camera lens to a strong light source, such as direct sunlight. If the camera lens is exposed to a strong light source, such as direct sunlight, the camera image sensor may be damaged. A damaged image sensor is irreparable and will cause dots or spots in pictures.
- If you use the device with its glass or acrylic body broken, there may be a risk of injury. Use the device only after it has been repaired at a Samsung Service Centre.
- If dust or foreign materials enter the microphone, speaker, or receiver, the device's sound may become quiet or certain features may not work. If you attempt to remove the dust or foreign materials with a sharp object, the device may be damaged and its appearance may be affected.



- Connectivity problems and battery drain may occur in the following situations:
  - If you attach metallic stickers on the antenna area of the device
  - If you attach a device cover made with metallic material to the device
  - If you cover the device's antenna area with your hands or other objects while using certain features, such as calls or the mobile data connection
- Using a Samsung-approved screen protector is recommended. Unapproved screen protectors may cause the sensors to malfunction.
- Do not cover the proximity/light sensor area with screen accessories, such as a screen protector, stickers, or a cover. Doing so may cause the sensor to malfunction.
- The light may flicker at the top of the device during calls due to proximity sensor operation.
- The colours on the Edge screen may look different depending on your viewing position.

## Hard keys

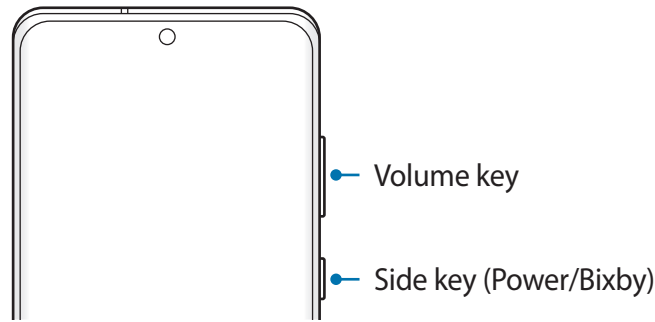

Key	Function
Volume key	<ul style="list-style-type: none"> <li>• Press to adjust the device volume.</li> </ul>
Side key	<ul style="list-style-type: none"> <li>• When the device is off, press and hold to turn it on.</li> <li>• Press to turn on or lock the screen.</li> <li>• Press and hold to start a conversation with Bixby. Refer to <a href="#">Using Bixby</a> for more information.</li> <li>• Press twice or press and hold to launch the app or feature you set.</li> </ul>
Side key + Volume Down key	<ul style="list-style-type: none"> <li>• Press simultaneously to capture a screenshot.</li> <li>• Press and hold simultaneously to turn off the device.</li> </ul>

### Setting the Side key

Select an app or feature to launch by pressing the Side key twice or pressing and holding the Side key.

Launch the **Settings** app, tap **Advanced features** → **Side key**, and then select an option you want.

## Soft buttons

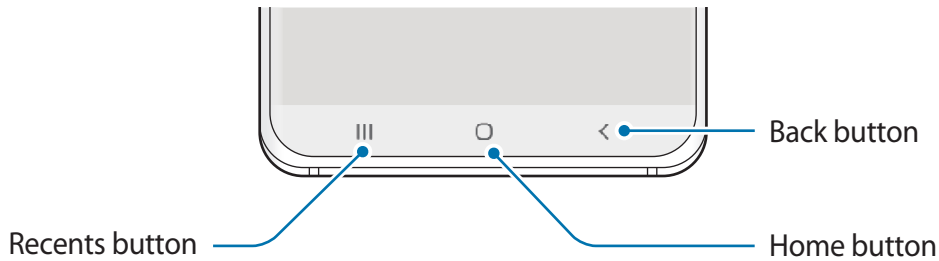

When you turn on the screen, the soft buttons will appear at the bottom of the screen. The soft buttons are set to the Recents button, Home button, and Back button by default. Refer to [Navigation bar \(soft buttons\)](#) for more information.

## Battery

### Charging the battery

Charge the battery before using it for the first time or when it has been unused for extended periods.



Use only Samsung-approved battery, charger, and cable specifically designed for your device. Incompatible battery, charger, and cable can cause serious injuries or damage to your device.



- Connecting the charger improperly may cause serious damage to the device. Any damage caused by misuse is not covered by the warranty.
- Use only USB Type-C cable supplied with the device. The device may be damaged if you use Micro USB cable.



To save energy, unplug the charger when not in use. The charger does not have a power switch, so you must unplug the charger from the electric socket when not in use to avoid wasting power. The charger should remain close to the electric socket and easily accessible while charging.



- 1 Connect the USB cable to the USB power adaptor.
- 2 Plug the USB cable into the device's multipurpose jack.

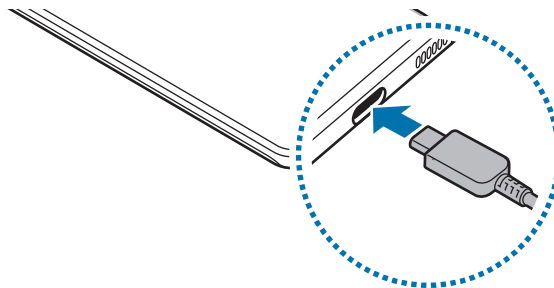

- 3 Plug the USB power adaptor into an electric socket.
- 4 After fully charging, disconnect the charger from the device. Then, unplug the charger from the electric socket.

## Reducing the battery consumption

Your device provides various options that help you conserve battery power.

- Optimise the device using the device care feature.
- When you are not using the device, turn off the screen by pressing the Side key.
- Activate power saving mode.
- Close unnecessary apps.
- Deactivate the Bluetooth feature when not in use.
- Deactivate auto-syncing of apps that need to be synced.
- Decrease the backlight time.
- Decrease the screen brightness.

## Battery charging tips and precautions

- When the battery power is low, the battery icon appears empty.
- If the battery is completely discharged, the device cannot be turned on immediately when the charger is connected. Allow a depleted battery to charge for a few minutes before turning on the device.
- If you use multiple apps at once, network apps, or apps that need a connection to another device, the battery will drain quickly. To avoid losing power during a data transfer, always use these apps after fully charging the battery.
- Using a power source other than the charger, such as a computer, may result in a slower charging speed due to a lower electric current.
- The device can be used while it is charging, but it may take longer to fully charge the battery.
- If the device receives an unstable power supply while charging, the touchscreen may not function. If this happens, unplug the charger from the device.
- While charging, the device and the charger may heat up. This is normal and should not affect the device's lifespan or performance. If the battery gets hotter than usual, the charger may stop charging. If this occurs during wireless charging, disconnect the device from the charger to let it cool down, then charge the device again later.
- If you charge the device while the multipurpose jack is wet, the device may be damaged. Thoroughly dry the multipurpose jack before charging the device.
- If the device is not charging properly, take the device and the charger to a Samsung Service Centre.

## Super fast charging

The device has a built-in super fast charging feature so you can charge the battery more quickly.

To use the super fast charging feature, you must use the battery charger supplied with the device and the super fast charging feature must be activated.

If the super fast charging feature is not activated, launch the **Settings** app, tap **Device care** → **Battery** → **Charging**, and then tap the **Super fast charging** switch to activate it.

When you connect a fast battery charger, you can charge the battery with the fast charging feature. When the pop-up window appears on the device, tap **Turn on**.

Alternatively, launch the **Settings** app, tap **Device care** → **Battery** → **Charging**, and then tap the **Fast charging** switch to activate it.



- While charging, you cannot activate or deactivate this feature.
- To use the super fast charging feature, use a USB PD (Power Delivery) charger that supports Super fast charging.
- To use the fast charging feature, use a battery charger that supports Adaptive fast charging.
- You cannot use the fast charging feature or the super fast charging feature when you charge the battery using a standard battery charger.
- If the device heats up or the ambient air temperature rises, the charging speed may decrease automatically. This is a normal operating condition to prevent damage to the device.
- You can charge the battery more quickly while the device or its screen is turned off.

## Wireless charging

The device has a built-in wireless charging coil. You can charge the battery using a wireless charger (sold separately).

### Fast wireless charging

You can charge your device faster using the fast wireless charging feature. A fan inside the charger may produce noise during fast wireless charging.

Launch the **Settings** app, tap **Device care** → **Battery** → **Charging** → **Fast wireless charging**. You can turn off or on the fast wireless charging feature by tapping the **On** or **Off** switch. If you use the **Turn off as scheduled** option, you can set the fast wireless charging feature to turn off automatically at the preset time. When the fast wireless charging feature turns off, the charger's fan noise and the indicator light will be reduced.



- To use this feature, you must use a charger and components that support the fast wireless charging feature.
- While charging, you cannot activate or deactivate this feature.

### Charging the battery

- 1 Place the centre of the device's back on the centre of the wireless charger.

The estimated charging time will appear on the notification panel. The actual charging time may vary depending on the charging conditions.

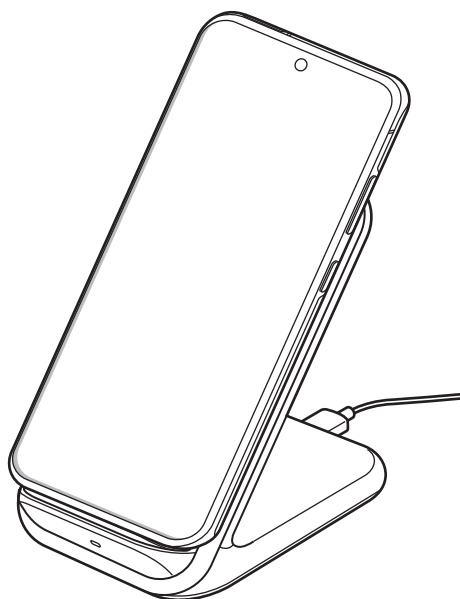

2 After fully charging, disconnect the device from the wireless charger.



### Precautions for wireless charging

- Do not place the device on the wireless charger with a credit card or radio-frequency identification (RFID) card (such as a transportation card or a key card) placed between the back of the device and the device cover.
- Do not place the device on the wireless charger when conductive materials, such as metal objects and magnets, are placed between the device and the wireless charger.

The device may not charge properly or may overheat, or the device and the cards may be damaged.



- If you use the wireless charger in areas with weak network signals, you may lose network reception.
- Use Samsung-approved wireless chargers. If you use other wireless chargers, the battery may not charge properly.

## Wireless PowerShare

You can charge another device with your device's battery. You can still charge another device even while charging your device. Depending on the type of accessories or cover being used, the Wireless PowerShare feature may not work properly. It is recommended to remove any accessories and cover being used before using this feature.



Do not use earphones while sharing power. Doing so may affect nearby devices.

1 Open the notification panel, swipe downwards, and then tap  (**Wireless PowerShare**) to activate it.

2 Place the other device on the centre of your device, with their backs facing.



- When charging starts, a notification sound or vibration will occur.
- The location of the wireless charging coil may vary by device model. Adjust the devices to connect with each other properly.
- Some features are not available while sharing power.

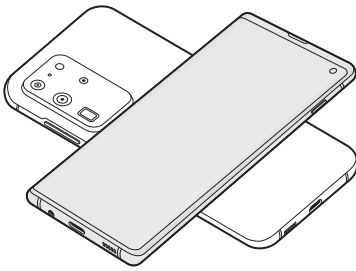

Smartphone

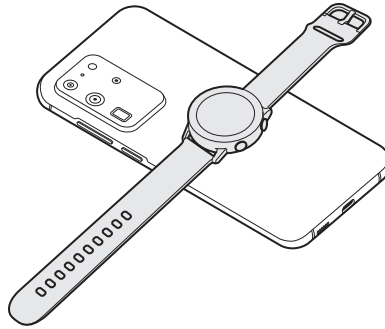

Galaxy Watch

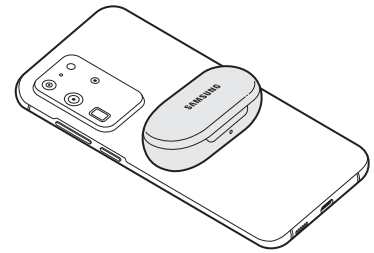

Galaxy Buds

3 When you are finished charging, disconnect the other device from your device.



- Only devices that support the wireless charging feature can be charged using this feature. Some devices may not be charged. To see devices that support the Wireless PowerShare feature, visit [www.samsung.com](http://www.samsung.com).
- To charge properly, do not move or use either device while charging.
- The power charged to the other device may be less than the amount shared to it by your device.
- If you charge the other device while charging your device, the charging speed may decrease or the device may not charge properly depending on the charger type.
- The charging speed or efficiency may vary depending on the device's condition or the surrounding environment.

## Setting the limit for power sharing

You can set the device to stop power sharing when the remaining battery power drops below a certain level.

Launch the **Settings** app, tap **Device care** → **Battery** → **Wireless PowerShare** → **Battery limit**, and then set the limit.

## Nano-SIM card and eSIM

Insert the SIM or USIM card provided by the mobile telephone service provider.

To have two phone numbers or service providers for a single device, activate the eSIM.

Differing from a physical nano-SIM card, an eSIM is an embedded digital SIM. Using both the nano-SIM card and the eSIM may result in slower data transfer speeds in some areas.



- eSIM may not be available depending on the region, service provider, or model.
- Some services that require a network connection may not be available depending on the service provider.

## Installing the SIM or USIM card



- Use only a nano-SIM card.
- Use caution not to lose or let others use the SIM or USIM card. Samsung is not responsible for any damages or inconveniences caused by lost or stolen cards.

### ► Single SIM models:

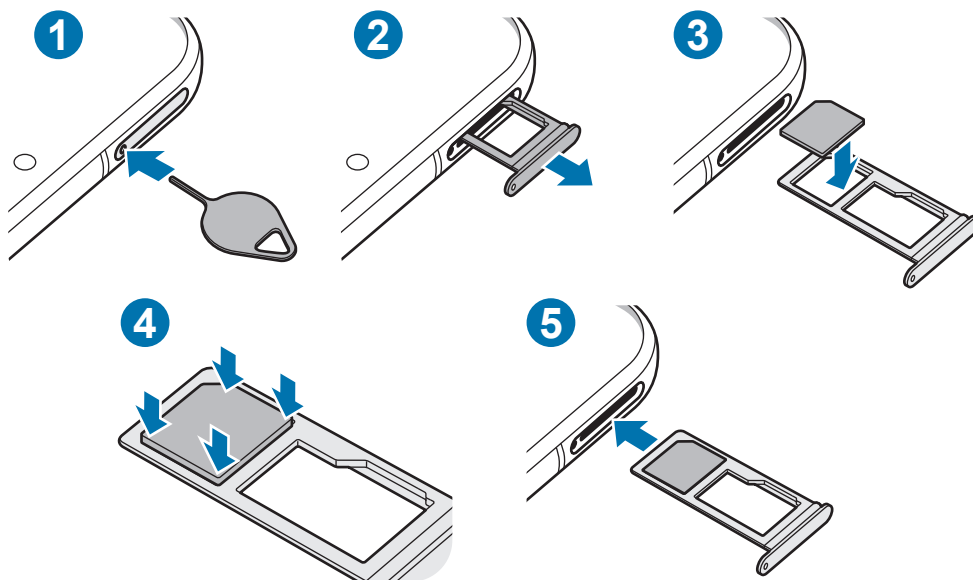

► Dual SIM models:

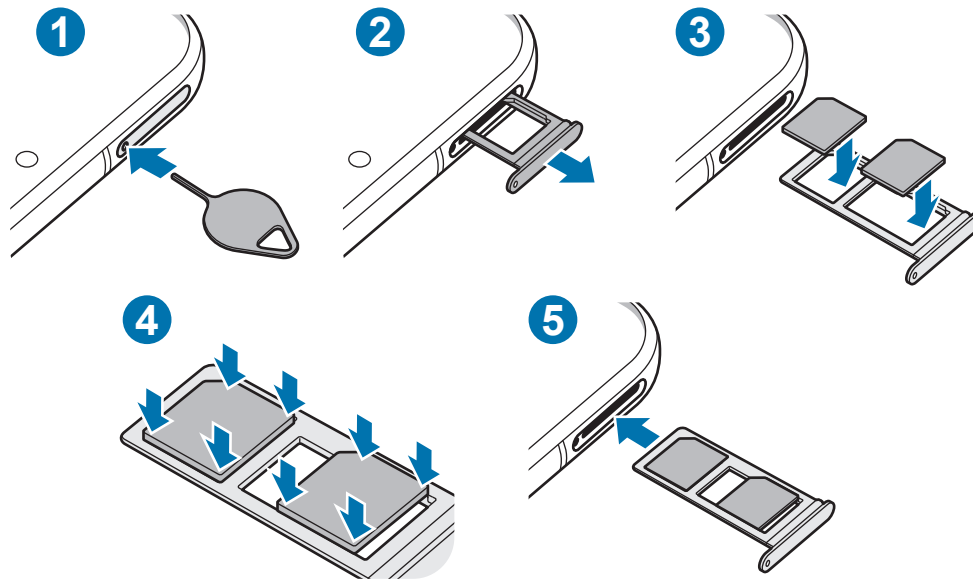

1 Insert the ejection pin into the hole on the tray to loosen the tray.

⚠ Ensure that the ejection pin is perpendicular to the hole. Otherwise, the device may be damaged.

2 Pull out the tray gently from the tray slot.

3 Place the SIM or USIM card on the tray with the gold-coloured contacts facing downwards.

4 Gently press the SIM or USIM card into the tray to secure it.

⚠ If the card is not fixed firmly into the tray, the SIM card may leave or fall out of the tray.

5 Insert the tray back into the tray slot.

⚠

- If you insert the tray into your device while the tray is wet, your device may be damaged. Always make sure the tray is dry.
- Fully insert the tray into the tray slot to prevent liquid from entering your device.



## Correct card installation (dual SIM models)

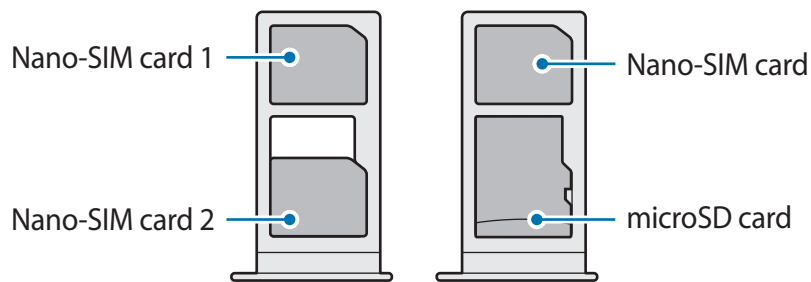

 You cannot insert a nano-SIM card and a microSD card in the same place simultaneously.

## Activating an eSIM

Launch the **Settings** app and tap **Connections** → **SIM card manager** → **Add mobile plan**. When a mobile plan is found, follow the on-screen instructions to activate the eSIM.

If you have a QR code provided by your service provider, launch the **Settings** app, tap **Connections** → **SIM card manager** → **Add mobile plan** → **Add using QR code**, and then scan the QR code.

 This feature may not be available depending on the region or service provider.

## Using the eSIM and nano-SIM card (dual SIM models)

If you install a nano-SIM card and activate the eSIM, you can have two phone numbers or service providers for a single device.

 This feature may not be available depending on the region or service provider.

## Activating SIM or USIM cards

Launch the **Settings** app and tap **Connections** → **SIM card manager**. Select a SIM or USIM card and tap the switch to activate it.

## Customising the eSIM and nano-SIM card

Launch the **Settings** app, tap **Connections** → **SIM card manager**, and then select the eSIM or nano-SIM card to access the following options:

- **Icon:** Change the icon of the eSIM or nano-SIM card.
- **Name:** Change the display name of the eSIM or nano-SIM card.
- **Network mode:** Select a network type to use with the eSIM or nano-SIM card.

## Setting preferred eSIM or nano-SIM card

When two cards are activated, you can assign voice calls, messaging, and data services to specific cards.

Launch the **Settings** app, tap **Connections** → **SIM card manager**, and then set the feature preferences for your cards in **Preferred SIM card**.

# Memory card (microSD card)

## Installing a memory card

Your device's memory card capacity may vary from other models and some memory cards may not be compatible with your device depending on the memory card manufacturer and type. To view your device's maximum memory card capacity, refer to the Samsung website.



- Some memory cards may not be fully compatible with the device. Using an incompatible card may damage the device or the memory card, or corrupt the data stored in it.
- Use caution to insert the memory card right-side up.



- The device supports the FAT and the exFAT file systems for memory cards. When inserting a card formatted in a different file system, the device will ask to reformat the card or will not recognise the card. To use the memory card, you must format it. If your device cannot format or recognise the memory card, contact the memory card manufacturer or a Samsung Service Centre.
- Frequent writing and erasing of data shortens the lifespan of memory cards.
- When inserting a memory card into the device, the memory card's file directory appears in the **My Files** → **SD card** folder.

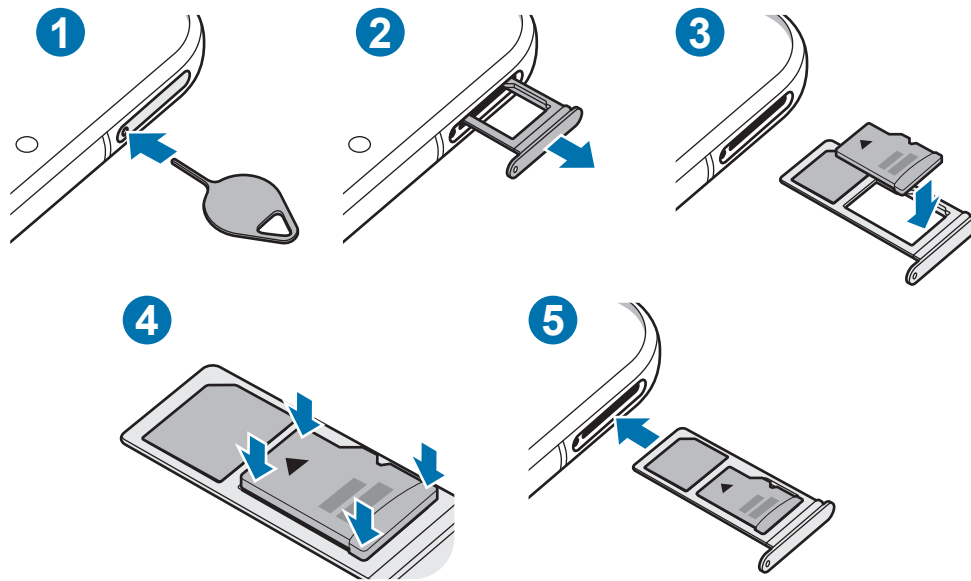

1 Insert the ejection pin into the hole on the tray to loosen the tray.

 Ensure that the ejection pin is perpendicular to the hole. Otherwise, the device may be damaged.

2 Pull out the tray gently from the tray slot.

 When you remove the tray from the device, the mobile data connection will be disabled.

3 Place a memory card on the tray with the gold-coloured contacts facing downwards.

4 Gently press the memory card into the tray to secure it.

 If the card is not fixed firmly into the tray, the memory card may leave or fall out of the tray.

5 Insert the tray back into the tray slot.

 • If you insert the tray into your device while the tray is wet, your device may be damaged. Always make sure the tray is dry.

• Fully insert the tray into the tray slot to prevent liquid from entering your device.

## Removing the memory card

Before removing the memory card, first unmount it for safe removal.

Launch the **Settings** app and tap **Device care** → **Storage** → **Advanced** → **SD card** → **Unmount**.



Do not remove external storage, such as a memory card or USB storage, while the device is transferring or accessing information, or right after transferring data. Doing so can cause data to be corrupted or lost or cause damage to the external storage or device. Samsung is not responsible for losses, including loss of data, resulting from the misuse of external storage devices.

## Formatting the memory card

A memory card formatted on a computer may not be compatible with the device. Format the memory card on the device.

Launch the **Settings** app and tap **Device care** → **Storage** → **Advanced** → **SD card** → **Format**.



Before formatting the memory card, remember to make backup copies of all important data stored in the memory card. The manufacturer's warranty does not cover loss of data resulting from user actions.

## Turning the device on and off



Follow all posted warnings and directions from authorised personnel in areas where the use of wireless devices is restricted, such as aeroplanes and hospitals.

### Turning the device on

Press and hold the Side key for a few seconds to turn on the device.

When you turn on your device for the first time or after performing a data reset, follow the on-screen instructions to set up your device.

## Turning the device off

- 1 To turn off the device, press and hold the Side key and the Volume Down key simultaneously. Alternatively, open the notification panel and tap .

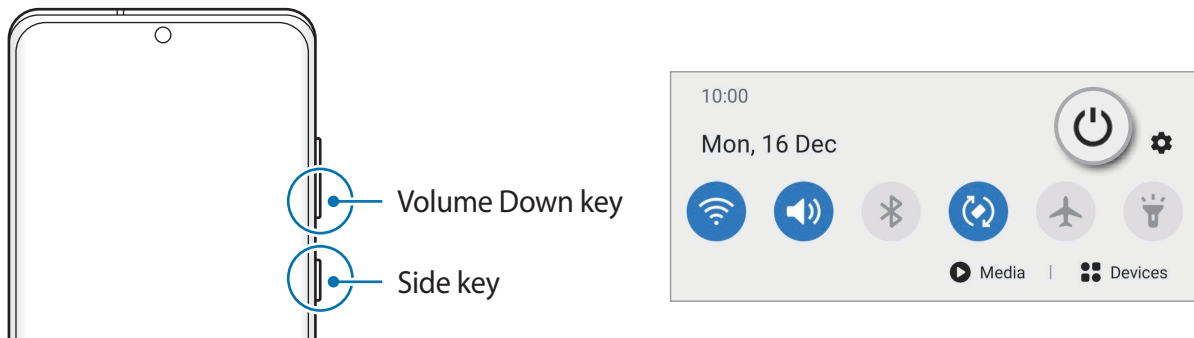

- 2 Tap **Power off**.

To restart the device, tap **Restart**.



You can set the device to turn off when you press and hold the Side key. Launch the **Settings** app, tap **Advanced features** → **Side key**, and then tap **Power off menu** under **Press and hold**.

## Forcing restart

If your device is frozen and unresponsive, press and hold the Side key and the Volume Down key simultaneously for more than 7 seconds to restart it.

## Emergency mode

You can switch the device to emergency mode to reduce battery consumption. Some apps and functions will be restricted. In emergency mode, you can make an emergency call, send your current location information to others, sound an emergency alarm, and more.

To activate emergency mode, press and hold the Side key and the Volume Down key simultaneously, and then tap **Emergency mode**. Alternatively, open the notification panel and tap  → **Emergency mode**.

To deactivate emergency mode, tap  → **Turn off Emergency mode**.



The usage time left shows the time remaining before the battery power runs out. Usage time left may vary depending on your device settings and operating conditions.

## Initial setup

When you turn on your device for the first time or after performing a data reset, follow the on-screen instructions to set up your device.

- 1 Press and hold the Side key for a few seconds to turn on the device.
- 2 Tap .
- 3 Select your preferred device language and tap **Next**.
- 4 Follow the on-screen instructions to complete the setup.

The Home screen will appear.



If you do not connect to a Wi-Fi network, you may not be able to set up some device features during the initial setup.

## Samsung account

Your Samsung account is an integrated account service that allows you to use a variety of Samsung services provided by mobile devices, TVs, and the Samsung website.

To check the list of services that can be used with your Samsung account, launch the **Settings** app and tap **Accounts and backup** → **Accounts** → **Samsung account** → **Apps and services**. Alternatively, visit [account.samsung.com](https://account.samsung.com).

### Creating a Samsung account

If you do not have a Samsung account, you should create one. You can create a Samsung account using your email address.

- 1 Launch the **Settings** app and tap **Accounts and backup** → **Accounts** → **Add account** → **Samsung account**.  
Alternatively, launch the **Settings** app and tap .
- 2 Tap **Create account**.
- 3 Follow the on-screen instructions to complete creating your account.

## Signing in to your Samsung account

If you already have a Samsung account, sign in to your Samsung account. You can also sign in using your Google account.

**1** Launch the **Settings** app and tap **Accounts and backup** → **Accounts** → **Add account** → **Samsung account**.

Alternatively, launch the **Settings** app and tap .

**2** Enter your Samsung account ID and password and tap **Sign in**.

If you want to sign in using your Google account, tap **Continue with Google**.

**3** Follow the on-screen instructions to complete signing in to your Samsung account.

## Finding your ID and resetting your password

If you forget your Samsung account ID or password, tap **Find ID** or **Reset password** on the Samsung account sign-in screen. You can find your ID or reset your password after you enter the required information.

## Removing your Samsung account

When you remove your Samsung account from the device, your data, such as contacts or events, will also be removed.

**1** Launch the **Settings** app and tap **Accounts and backup** → **Accounts**.

**2** Tap **Samsung account** → **Personal info** →  → **Remove account**.

**3** Tap **Remove**, enter your Samsung account password, and then tap **OK**.

## Transferring data from your previous device (Smart Switch)

You can use Smart Switch to transfer data from your previous device to your new device.

Launch the **Settings** app and tap **Accounts and backup** → **Smart Switch**.



- This feature may not be supported on some devices or computers.
- Limitations apply. Visit [www.samsung.com/smartswitch](http://www.samsung.com/smartswitch) for details. Samsung takes copyright seriously. Only transfer content that you own or have the right to transfer.

### Transferring data using a USB cable

You can connect your previous device to your device with the USB cable to easily and quickly transfer data.

- 1 Connect your device and the previous device using your device's USB cable.

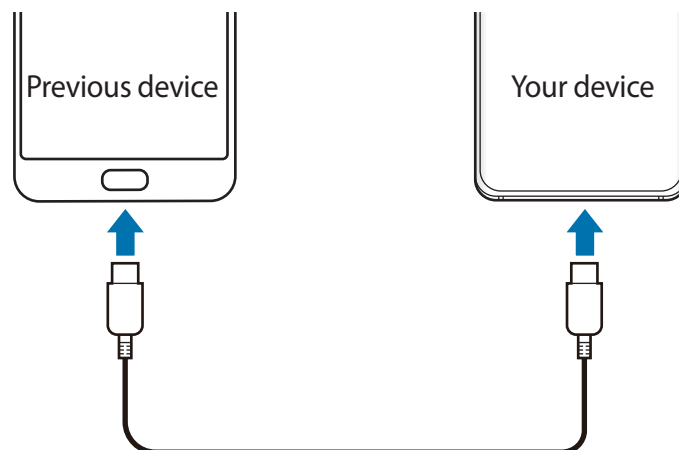

- 2 When the app selection pop-up window appears, tap **Smart Switch** → **Receive data**.

- 3 In the previous device, tap **Allow**.

If you do not have the app, download it from **Galaxy Store** or **Play Store**.

Your device will recognise the previous device and a list of data you can transfer will appear.



4 Select an item to bring and tap **Transfer**.

5 Follow the on-screen instructions to transfer data from the previous device.

After the data is done transferring, you can view a list of the transferred data on your device.



Do not disconnect the USB cable from the device when you are transferring files. Doing so may cause data loss or device damage.



- A USB connector may be needed depending on the previous device.
- Transferring data increases the battery power consumption of your device. Ensure that your device is sufficiently charged before transferring data. If the battery power is low, data transfer may be interrupted.

## Transferring data wirelessly

Transfer data from your previous device to your device wirelessly via Wi-Fi Direct.

1 On the previous device, launch **Smart Switch**.

If you do not have the app, download it from **Galaxy Store** or **Play Store**.

2 On your device, launch the **Settings** app and tap **Accounts and backup** → **Smart Switch**.

3 Place the devices near each other.

4 On the previous device, tap **Send data** → **Wireless**.

5 On the previous device, tap **Allow**.

6 On your device, select an item to bring and tap **Transfer**.

7 Follow the on-screen instructions to transfer data from your previous device.

After the data is done transferring, you can view a list of the transferred data on your device.

## Backing up and restoring data using external storage

Transfer data using external storage, such as a microSD card.

- 1 Back up data from your previous device to external storage.
- 2 Insert or connect the external storage device to your device.
- 3 On your device, launch the **Settings** app and tap **Accounts and backup** → **Smart Switch** →  → **Restore**.
- 4 Follow the on-screen instructions to transfer data from external storage.

## Transferring backup data from a computer

Transfer data between your device and a computer. You must download the Smart Switch computer version app from [www.samsung.com/smartswitch](http://www.samsung.com/smartswitch). Back up data from your previous device to a computer and import the data to your device.

- 1 On the computer, visit [www.samsung.com/smartswitch](http://www.samsung.com/smartswitch) to download Smart Switch.
- 2 On the computer, launch Smart Switch.  
 If your previous device is not a Samsung device, back up data to a computer using a program provided by the device's manufacturer. Then, skip to the fifth step.
- 3 Connect your previous device to the computer using the device's USB cable.
- 4 On the computer, follow the on-screen instructions to back up data from the device. Then, disconnect your previous device from the computer.
- 5 Connect your device to the computer using the USB cable.
- 6 On the computer, follow the on-screen instructions to transfer data to your device.

# Understanding the screen

## Controlling the touchscreen



- Do not allow the touchscreen to come into contact with other electrical devices. Electrostatic discharges can cause the touchscreen to malfunction.
- To avoid damaging the touchscreen, do not tap it with anything sharp or apply excessive pressure to it with your fingertips.
- It is recommended not to use fixed graphics on part or all of the touchscreen for extended periods. Doing so may result in afterimages (screen burn-in) or ghosting.



- The device may not recognise touch inputs close to the edges of the screen, which are outside of the touch input area.
- It is recommended to use fingers when you use the touchscreen.

### Tapping

Tap the screen.

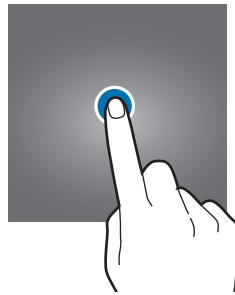

### Tapping and holding

Tap and hold the screen for approximately 2 seconds.

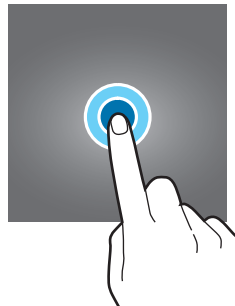

### Dragging

Tap and hold an item and drag it to the target position.

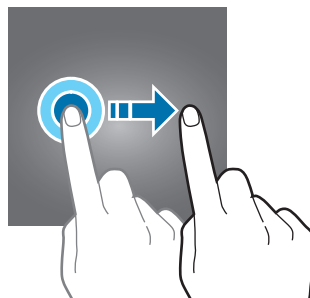

## Double-tapping

Double-tap the screen.

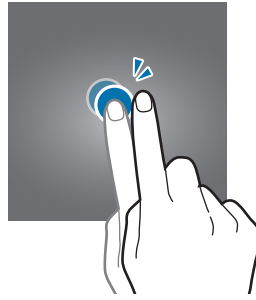

## Swiping

Swipe upwards, downwards, to the left, or to the right.

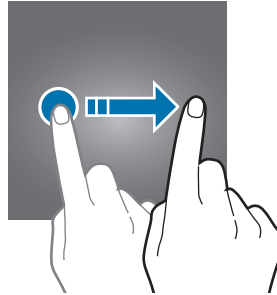

## Spreading and pinching

Spread two fingers apart or pinch on the screen.

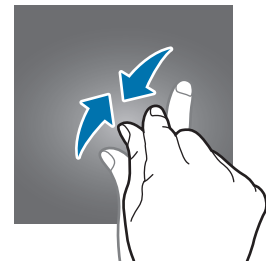

## Navigation bar (soft buttons)

When you turn on the screen, the soft buttons will appear on the navigation bar at the bottom of the screen. The soft buttons are set to the Recents button, Home button, and Back button by default. The functions of the buttons can change according to the app currently being used or usage environment.



Button		Function
	Recents	<ul style="list-style-type: none"> <li>• Tap to open the list of recent apps.</li> </ul>
○	Home	<ul style="list-style-type: none"> <li>• Tap to return to the Home screen.</li> <li>• Tap and hold to launch the <b>Google Assistant</b> app.</li> </ul>
<	Back	<ul style="list-style-type: none"> <li>• Tap to return to the previous screen.</li> </ul>

## Hiding the navigation bar

View files or use apps on a wider screen by hiding the navigation bar.

Launch the **Settings** app, tap **Display** → **Navigation bar**, and then tap **Full screen gestures** under **Navigation type**. The navigation bar will be hidden and the gesture hints will appear. Tap **More options** and select an option you want.

- **Swipe from bottom:** The gesture hints will appear where the soft buttons are located. To use the soft buttons, drag the gesture hint of the desired button upwards.
- **Swipe from sides and bottom:**
  - Swipe up from the bottom of the screen to move to the Home screen.
  - Swipe up and hold to view the list of recent apps.
  - Swipe inward from either side of the screen to return to the previous screen.
  - Swipe inward from one of the bottom corners to launch the **Google Assistant** app.

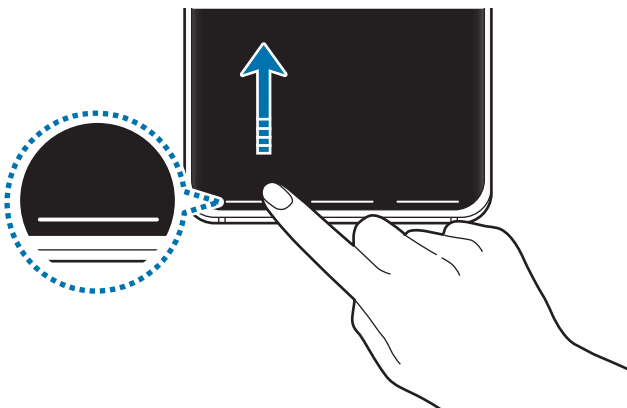

Swipe from bottom

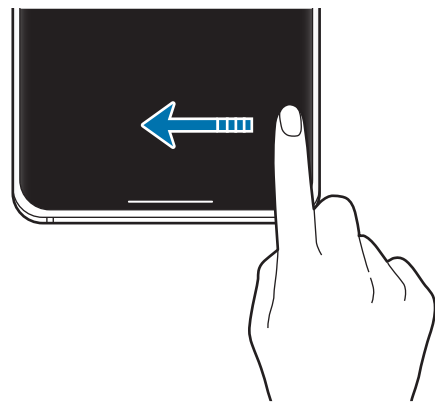

Swipe from sides and bottom

If you want to hide the gesture hints at the bottom of the screen, tap the **Gesture hints** switch to deactivate it.

## Home screen and Apps screen

The Home screen is the starting point for accessing all of the device's features. It displays widgets, shortcuts to apps, and more.

The Apps screen displays icons for all apps, including newly installed apps.



The screen may appear differently depending on the region or service provider.

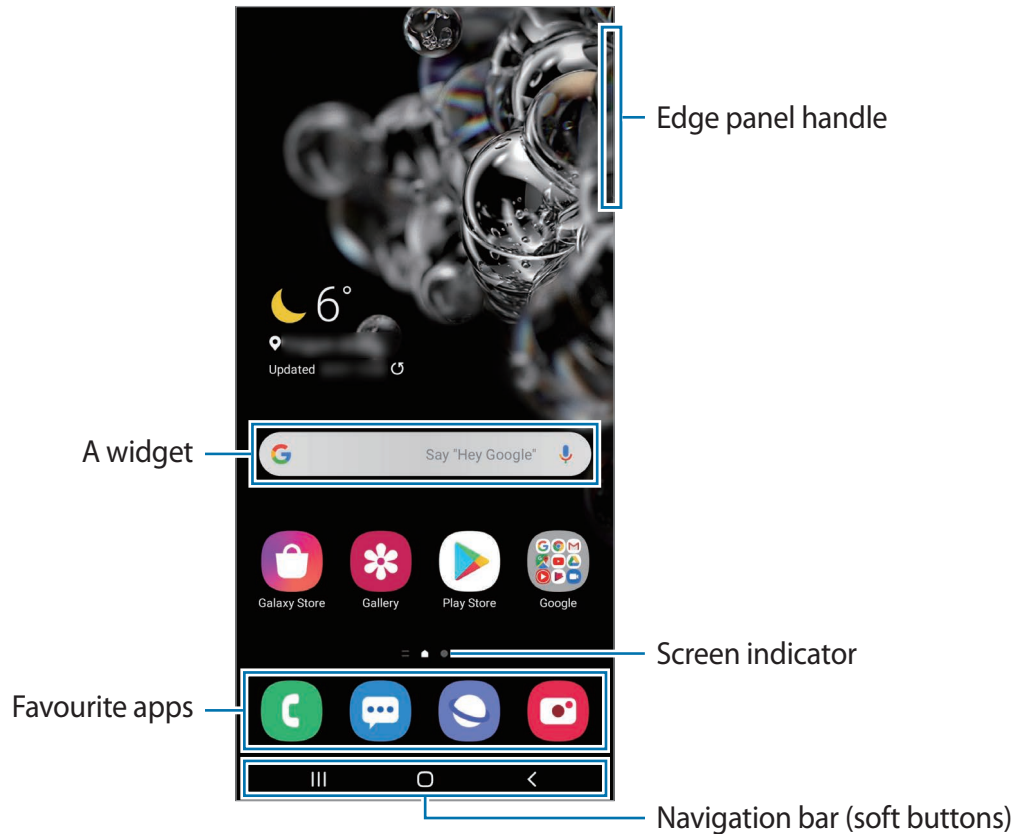

## Switching between Home and Apps screens

On the Home screen, swipe upwards or downwards to open the Apps screen.

To return to the Home screen, swipe upwards or downwards on the Apps screen.

Alternatively, tap the Home button or the Back button.



If you add the Apps button on the Home screen, you can open the Apps screen by tapping the button. On the Home screen, tap and hold an empty area, tap **Home screen settings**, and then tap the **Apps button** switch to activate it. The Apps button will be added at the bottom of the Home screen.



## Launching Finder

Search for content on the device quickly.

- 1 On the Apps screen, tap **Search**. Alternatively, open the notification panel, swipe downwards, and then tap **Q**.

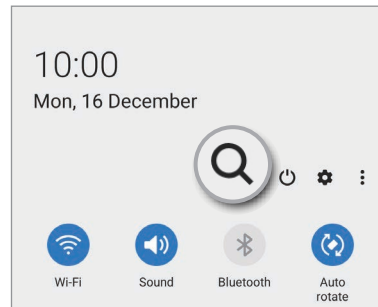
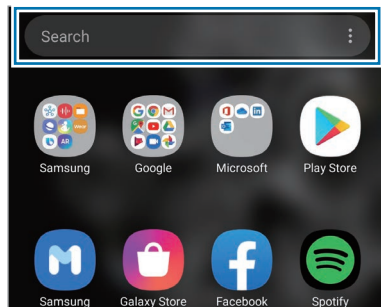

- 2 Enter a keyword.

Apps and content on your device will be searched.

If you tap **Q** on the keyboard, you can search for more content.

## Displaying the screen in landscape mode

On the Home screen, tap and hold an empty area, tap **Home screen settings**, and then tap the **Rotate to landscape mode** switch to activate it.

Rotate the device until it is horizontal to view the screen in landscape mode.

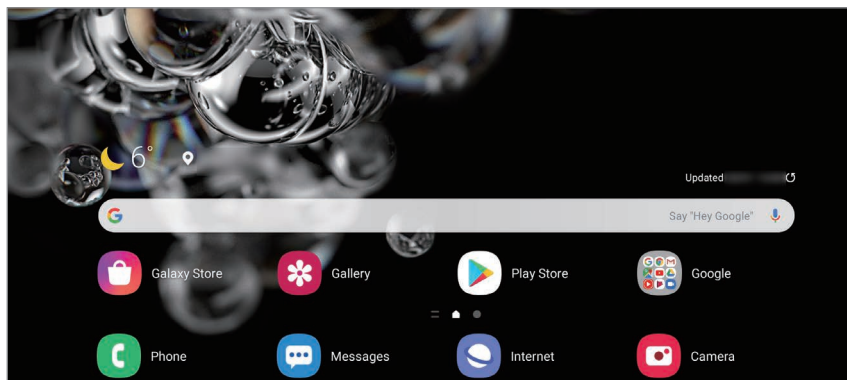



## Moving items

Tap and hold an item, and then drag it to a new location. To move the item to another panel, drag it to the side of the screen.

To add a shortcut to an app on the Home screen, tap and hold an item on the Apps screen, and then tap **Add to Home**. A shortcut to the app will be added on the Home screen.

You can also move frequently used apps to the shortcuts area at the bottom of the Home screen.

## Creating folders

Create folders and gather similar apps to quickly access and launch apps.

On the Home screen or the Apps screen, tap and hold an app, and then drag it over another app.

A new folder containing the selected apps will be created. Tap **Folder name** and enter a folder name.

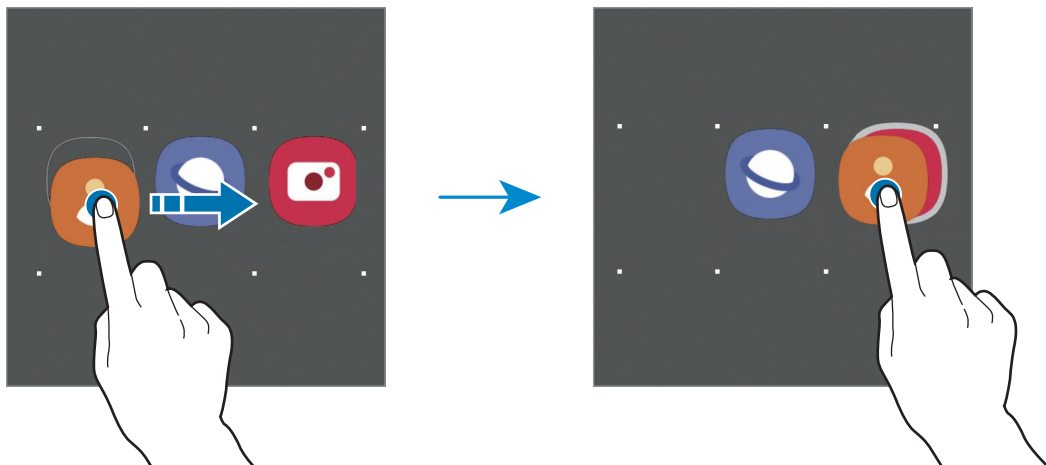

- **Adding more apps**

Tap **+** on the folder. Tick the apps to add and tap **Done**. You can also add an app by dragging it to the folder.

- **Moving apps from a folder**

Tap and hold an app to drag it to a new location.

- **Deleting a folder**

Tap and hold a folder, and then tap **Delete folder**. Only the folder will be deleted. The folder's apps will be relocated to the Apps screen.

## Editing the Home screen

On the Home screen, tap and hold an empty area, or pinch your fingers together to access the editing options. You can set the wallpaper, add widgets, and more. You can also add, delete, or rearrange Home screen panels.

- Adding panels: Swipe to the left, and then tap  $\oplus$ .
- Moving panels: Tap and hold a panel preview, and then drag it to a new location.
- Deleting panels: Tap  $\text{🗑}$  on the panel.

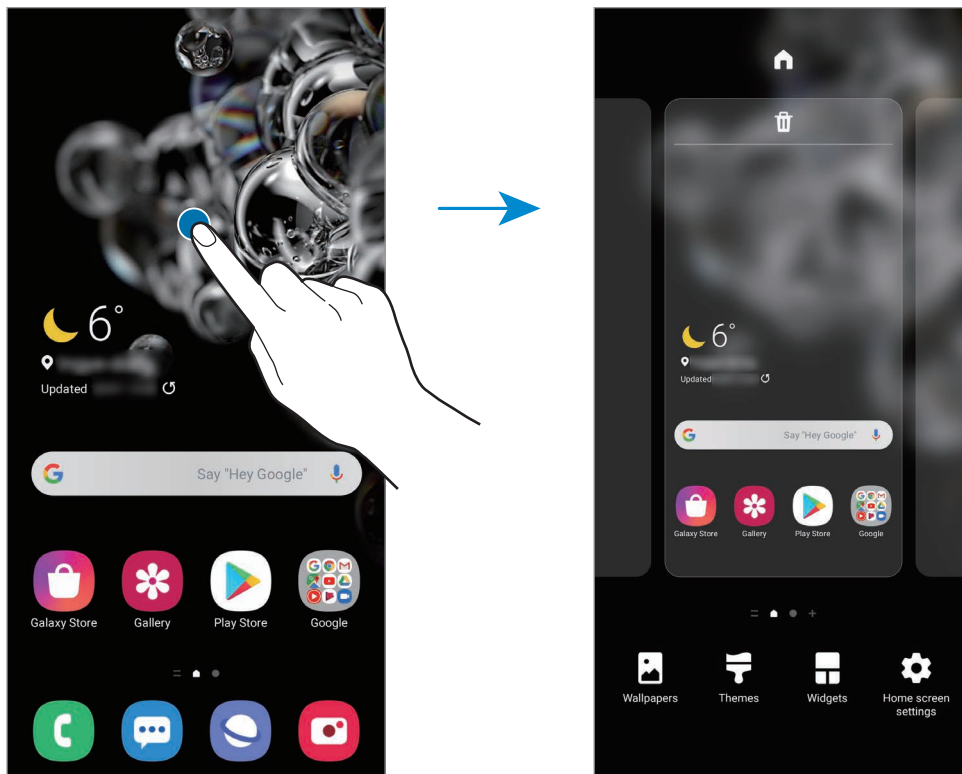

- **Wallpapers:** Change the wallpaper settings for the Home screen and the locked screen.
- **Themes:** Change the device's theme. Visual elements of interface, such as colours, icons, and wallpapers, will change depending on the selected theme.
- **Widgets:** Widgets are small apps that launch specific app functions to provide information and convenient access on your Home screen. Tap and hold a widget, and then drag it to the Home screen. The widget will be added on the Home screen.
- **Home screen settings:** Configure settings for the Home screen, such as the screen grid or layout.

## Displaying all apps on the Home screen

Without using a separate Apps screen, you can set the device to display all apps on the Home screen. On the Home screen, tap and hold an empty area, and then tap **Home screen settings** → **Home screen layout** → **Home screen only** → **Apply**.

You can now access all your apps by swiping to the left on the Home screen.









## Indicator icons

Indicator icons appear on the status bar at the top of the screen. The icons listed in the table below are most common.



- The status bar may not appear at the top of the screen in some apps. To display the status bar, drag down from the top of the screen.
- Some indicator icons appear only when you open the notification panel.
- The indicator icons may appear differently depending on the service provider or model.

Icon	Meaning
	No signal
	Signal strength
	Roaming (outside of normal service area)
	GPRS network connected
	EDGE network connected
	UMTS network connected
	HSDPA network connected
	HSPA+ network connected
	LTE network connected
	5G network connected
	LTE network connected in LTE network that includes the 5G network
	Wi-Fi connected
	Bluetooth feature activated
	Location services being used
	Call in progress
	Missed call

Icon	Meaning
	New text or multimedia message
	Alarm activated
	Mute mode activated
	Vibration mode activated
	Flight mode activated
	Error occurred or caution required
	Battery charging
	Battery power level

## Lock screen

Pressing the Side key turns off the screen and locks it. Also, the screen turns off and automatically locks if the device is not used for a specified period.

To unlock the screen, swipe in any direction when the screen turns on.

If the screen is off, press the Side key to turn on the screen. Alternatively, double-tap the screen.



Locked screen

## Changing the screen lock method

To change the screen lock method, launch the **Settings** app, tap **Lock screen** → **Screen lock type**, and then select a method.

When you set a pattern, PIN, password, or your biometric data for the screen lock method, you can protect your personal information by preventing others from accessing your device. After setting the screen lock method, the device will require an unlock code whenever unlocking it.

- **Swipe:** Swipe in any direction on the screen to unlock it.
- **Pattern:** Draw a pattern with four or more dots to unlock the screen.
- **PIN:** Enter a PIN with at least four numbers to unlock the screen.
- **Password:** Enter a password with at least four characters, numbers, or symbols to unlock the screen.
- **None:** Do not set a screen lock method.
- **Face:** Register your face to unlock the screen. Refer to [Face recognition](#) for more information.
- **Fingerprints:** Register your fingerprints to unlock the screen. Refer to [Fingerprint recognition](#) for more information.



You can set your device to perform a factory data reset if you enter the unlock code incorrectly several times in a row and reach the attempt limit. Launch the **Settings** app, tap **Lock screen** → **Secure lock settings**, unlock the screen using the preset screen lock method, and then tap the **Auto factory reset** switch to activate it.

# Notification panel

When you receive new notifications, such as messages or missed calls, indicator icons appear on the status bar. To see more information about the icons, open the notification panel and view the details.

To open the notification panel, drag the status bar downwards. To close the notification panel, swipe upwards on the screen.

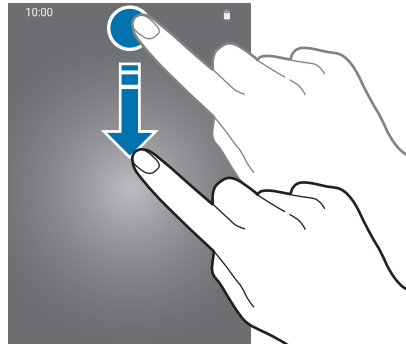

You can use the following functions on the notification panel.

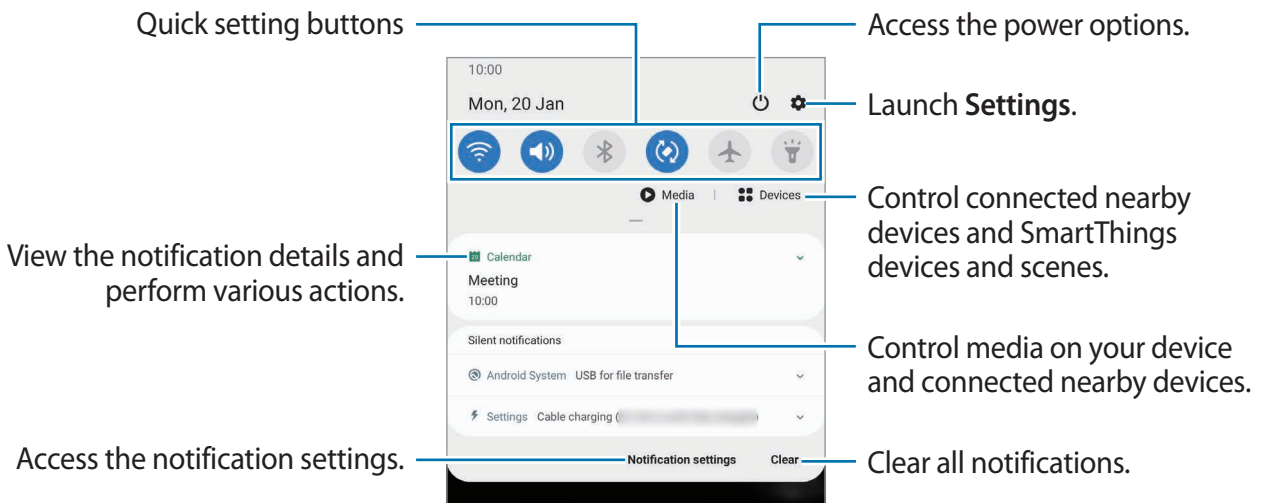

## Using quick setting buttons

Tap quick setting buttons to activate certain features. Swipe downwards on the notification panel to view more buttons.

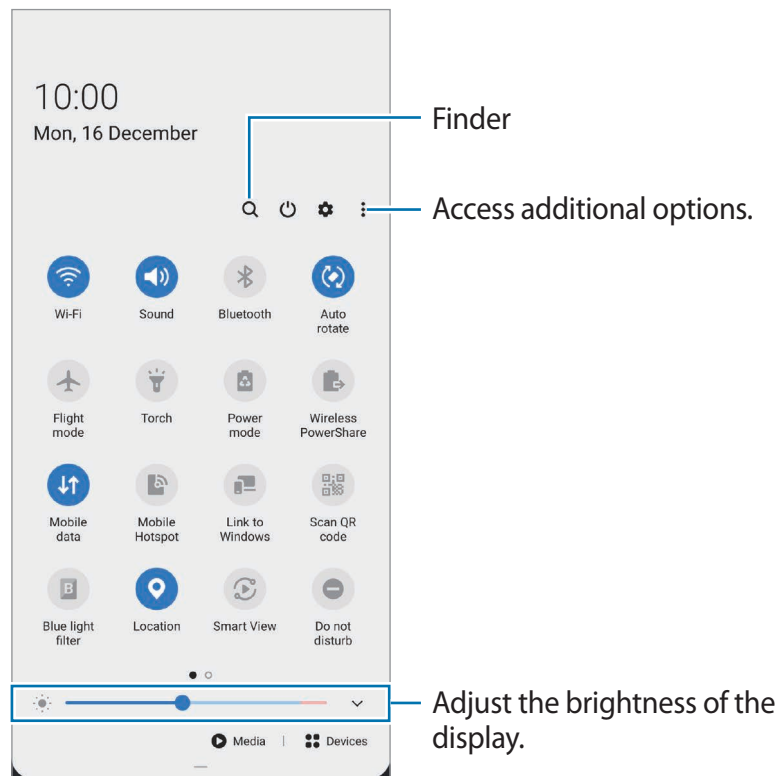

To change feature settings, tap the text under each button. To view more detailed settings, tap and hold a button.

To rearrange buttons, tap → **Button order**, tap and hold a button, and then drag it to another location.

## Controlling media playback

Take control of music or video playback easily using the Media feature. You can also continue playback on another device.

**1** Open the notification panel and tap **Media**.

**2** Tap the icons on the controller to control the playback.

To continue playback on another device, tap and select the device you want.

## Controlling nearby devices

Launch quickly and take control of nearby connected devices and frequently used SmartThings devices and scenes on the notification panel.

- 1 Open the notification panel and tap **Devices**.  
Nearby connected devices and SmartThings devices and scenes will appear.
- 2 Select a nearby device or a SmartThings device to control it, or select a scene to launch it.

## Screen capture and screen record

### Screen capture

Capture a screenshot while using the device and write on, draw on, crop, or share the captured screen. You can capture the current screen and scrollable area.

### How to capture a screenshot

Use the following methods to capture a screenshot. You can view the captured screenshots in **Gallery**.

**Method 1)** Key capture: Press the Side key and the Volume Down key simultaneously.

**Method 2)** Swipe capture: Swipe your hand to the left or right across the screen.







- It is not possible to capture a screenshot while using some apps and features.
- If capturing a screenshot by swiping is not activated, launch the **Settings** app, tap **Advanced features** → **Motions and gestures**, and then tap the **Palm swipe to capture** switch to activate it.



After capturing a screenshot, use the following options on the toolbar at the bottom of the screen:







- : Capture the current content and the hidden content on an elongated page, such as a webpage. When you tap , the screen will automatically scroll down and more content will be captured.
- : Write or draw on the screenshot or crop a portion from the screenshot. You can view the cropped area in **Gallery**.
- **#**: Add tags to the screenshot. To search for screenshots by tag, tap **Search** at the top of the Apps screen. You can view the tags list and easily search for the screenshot you want.
- : Share the screenshot with others.



If the options are not visible on the captured screen, launch the **Settings** app, tap **Advanced features** → **Screenshots and screen recorder**, and then tap the **Screenshot toolbar** switch to activate it.

## Screen record

Record the screen while using your device.

- 1 Open the notification panel, swipe downwards, and then tap  (**Screen recorder**) to activate it.
- 2 Select a sound setting and tap **Start recording**.  
After a countdown, recording will start.
  - To write or draw on the screen, tap .
  - To record the screen with a video overlay of yourself, tap .
- 3 When you are finished recording the video, tap .  
You can view the video in **Gallery**.



To change the screen recorder settings, launch the **Settings** app and tap **Advanced features** → **Screenshots and screen recorder** → **Screen recorder settings**.

# Entering text

## Keyboard layout

A keyboard appears automatically when you enter text to send messages, create notes, and more.



Text entry is not supported in some languages. To enter text, you must change the input language to one of the supported languages.

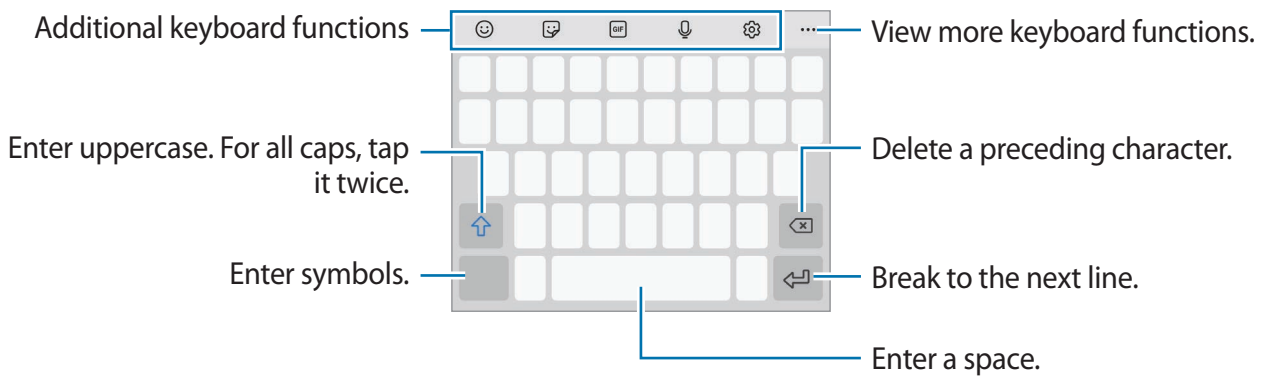



## Changing the input language

Tap  → **Languages and types** → **Manage input languages** and select the languages to use. When you select two or more languages, you can switch between the input languages by swiping to the left or right on the space key.

## Changing the keyboard

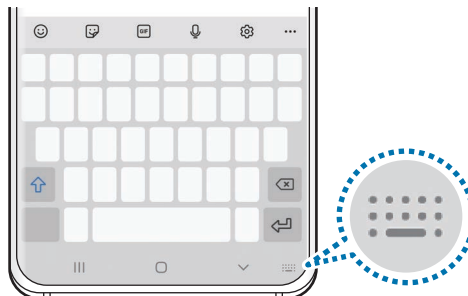
On the navigation bar, tap  to change the keyboard.



To change the keyboard type, tap  → **Languages and types**, select a language, and then select the keyboard type you want.























- If the keyboard button () does not appear on the navigation bar, launch the **Settings** app, tap **General management** → **Language and input** → **On-screen keyboard**, and then tap the **Show Keyboard button** switch to activate it.
- On a **3x4 keyboard**, a key has three or four characters. To enter a character, tap the corresponding key repeatedly until the desired character appears.



## Additional keyboard functions



Some features may not be available depending on the region or service provider.



-  : Enter emoticons.
-  : Enter stickers. You can also enter your emoji stickers that look like you. Refer to [Using your emoji stickers in chats](#) for more information.
-  : Attach animated GIFs.
-  : Enter text by voice.
-  : Change the keyboard settings.
-  →  : Search for content on the device quickly and enter it.
-  →  : Translate text and enter it.
-  →  : Enter your personal information registered to Samsung Pass.
-  →  : Add an item from the clipboard.
-  →  : Open the text editing panel.
-  →  : Change the keyboard mode.
-  →  : Change the keyboard size.
-  →  : Enter stickers.

## Copying and pasting

- 1 Tap and hold over text.
- 2 Drag  or  to select the desired text, or tap **Select all** to select all text.
- 3 Tap **Copy** or **Cut**.  
The selected text is copied to the clipboard.
- 4 Tap and hold where the text is to be inserted and tap **Paste**.  
To paste text that you have previously copied, tap **Clipboard** and select the text.

## Dictionary

Look up definitions for words while using certain features, such as when browsing webpages.

- 1 Tap and hold over a word that you want to look up.
- 2 Tap **Dictionary** on the options list.  
If a dictionary is not preinstalled on the device, tap **Move to Manage dictionaries**, tap  next to a dictionary, and then tap **Install** to download it.
- 3 View the definition in the dictionary pop-up window.  
To switch to the full screen view, tap . Tap the definition on the screen to view more definitions. In the detailed view, tap  to add the word to your favourite words list or tap **Search Web** to use the word as a search term.

# Apps and features

## Installing or uninstalling apps

### Galaxy Store

Purchase and download apps. You can download apps that are specialised for Samsung Galaxy devices.

Launch the **Galaxy Store** app.



This app may not be available depending on the region or service provider.

### Installing apps

Browse apps by category or tap **Q** to search for a keyword.

Select an app to view information about it. To download free apps, tap **Install**. To purchase and download apps where charges apply, tap the price and follow the on-screen instructions.



To change the auto update settings, tap **≡** → **⚙️** → **Auto update apps**, and then select an option.

### Play Store

Purchase and download apps.

Launch the **Play Store** app.

### Installing apps

Browse apps by category or search for apps by keyword.

Select an app to view information about it. To download free apps, tap **Install**. To purchase and download apps where charges apply, tap the price and follow the on-screen instructions.



To change the auto update settings, tap **≡** → **Settings** → **Auto-update apps**, and then select an option.

## Managing apps

### Uninstalling or disabling apps

Tap and hold an app and select an option.

- **Uninstall:** Uninstall downloaded apps.
- **Disable:** Disable selected default apps that cannot be uninstalled from the device.



Some apps may not support this feature.

### Enabling apps

Launch the **Settings** app, tap **Apps** → ▼ → **Disabled**, select an app, and then tap **Enable**.

### Setting app permissions

For some apps to operate properly, they may need permission to access or use information on your device.

To view your app permission settings, launch the **Settings** app and tap **Apps**. Select an app and tap **Permissions**. You can view the app's permissions list and change its permissions.

To view or change app permission settings by permission category, launch the **Settings** app and tap **Apps** → ⋮ → **Permission manager**. Select an item and select an app.



If you do not grant permissions to apps, the basic features of the apps may not function properly.

# Bixby

## Introduction

Bixby is a user interface that helps you use your device more conveniently.

You can talk to Bixby or type text. Bixby will launch a function you request or show the information you want. It also learns your usage patterns and environments. The more it learns about you, the more precisely it will understand you.



- To use Bixby, your device must be connected to a Wi-Fi or mobile network.
- To use Bixby, you must sign in to your Samsung account.
- Bixby is only available in some languages, and certain features may not be available depending on your region.

## Starting Bixby

When you launch Bixby for the first time, the Bixby intro page will appear. You must select the language to use with Bixby, sign in to your Samsung account according to the on-screen instructions, and then agree to the terms and conditions.

- 1 Press and hold the Side key. Alternatively, launch the **Bixby** app.

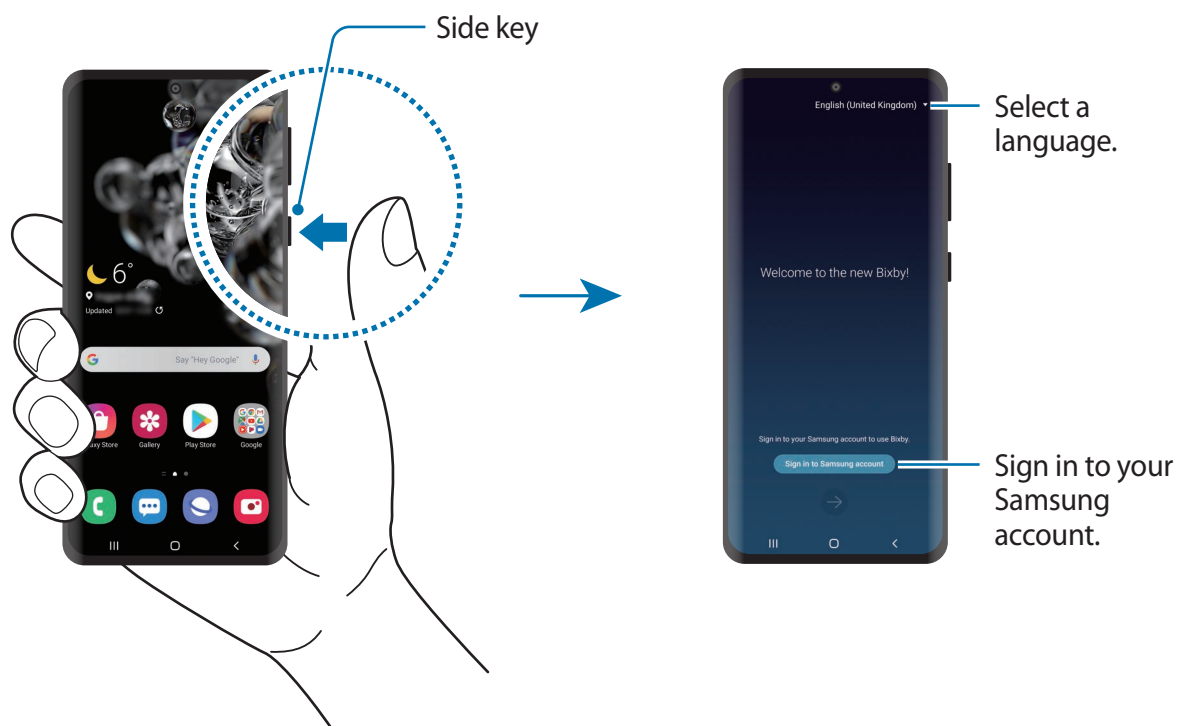

- 2 Select the language to use with Bixby.
- 3 Tap **Sign in to Samsung account** and follow the on-screen instructions to sign in to your Samsung account.



If you are already signed in, your account information will appear on the screen.

- 4 Follow the on-screen instructions to complete the setup.  
The Bixby screen will appear.

## Using Bixby

When you say what you want to Bixby, Bixby will launch corresponding functions or show the information you requested.

While pressing and holding the Side key, say what you want to Bixby, and then release your finger from the key when you are finished speaking. Alternatively, say “Hi, Bixby”, and when the device emits a sound, say what you want.

For example, while pressing and holding the Side key, say “How’s the weather today?” The weather information will appear on the screen.

If you want to know the weather tomorrow, while pressing and holding the Side key, just say “Tomorrow?” Because Bixby understands the context of the conversation, it will show you tomorrow’s weather.





If Bixby asks you a question during a conversation, while pressing and holding the Side key, answer Bixby. Or, tap  and answer Bixby.

If you are using headphones or Bluetooth audio devices, or start a conversation by saying “Hi, Bixby”, you can continue the conversation without tapping the icon. Launch the **Bixby** app and tap  → **Settings** → **Automatic listening** → **Hands-free only**.

## Waking up Bixby using your voice

You can start a conversation with Bixby by saying “Hi, Bixby”. Register your voice so that Bixby will respond to your voice when you say “Hi, Bixby”.

- 1 Launch the **Bixby** app and tap  → **Settings** → **Voice wake-up**.
- 2 Tap the **Wake with “Hi, Bixby”** switch to activate it.
- 3 Follow the on-screen instructions to complete the setup.

Now you can say “Hi, Bixby”, and when the device emits a sound, start a conversation.

## Communicating by typing text

If your voice is not recognised due to noisy environments or if you are in a situation where speaking is difficult, you can communicate with Bixby via text.

Launch the **Bixby** app, tap , and then type what you want.

During the communication, Bixby also will answer you through text instead of voice feedback.

## Bixby usages

### Launching apps or services

You can launch features quickly via Bixby. You can also use various convenient services, such as ordering coffee or searching for nearby restaurants or hotels and making a reservation.

For example, while pressing and holding the Bixby key, say “Call mom”, and then release your finger from the Bixby key. Bixby will now make a call to the contact saved as mom.

## Viewing more ways to use Bixby

To view more ways to use Bixby, launch the **Bixby** app and tap **All capsules** (or **Marketplace**). You can check out services supported by Bixby and examples of commands.

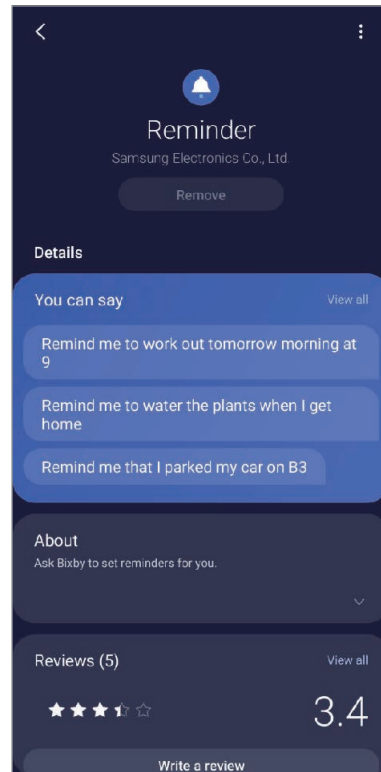
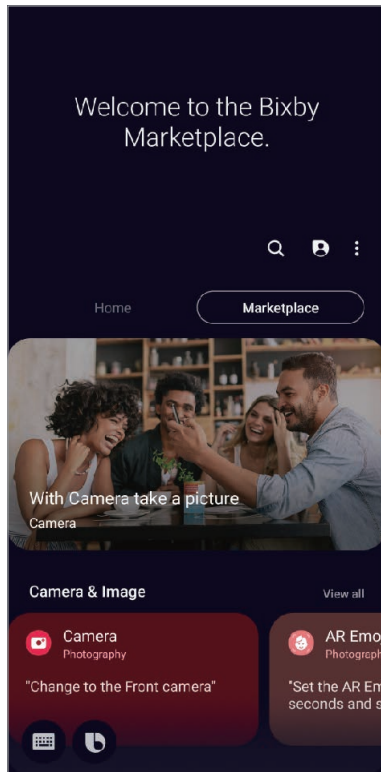

Some features may not be available depending on the region or service provider.

# Bixby Vision

## Introduction

Bixby Vision is a service that provides various features based on image recognition. You can use Bixby Vision to quickly search for information by recognising objects. Use a variety of useful Bixby Vision features.

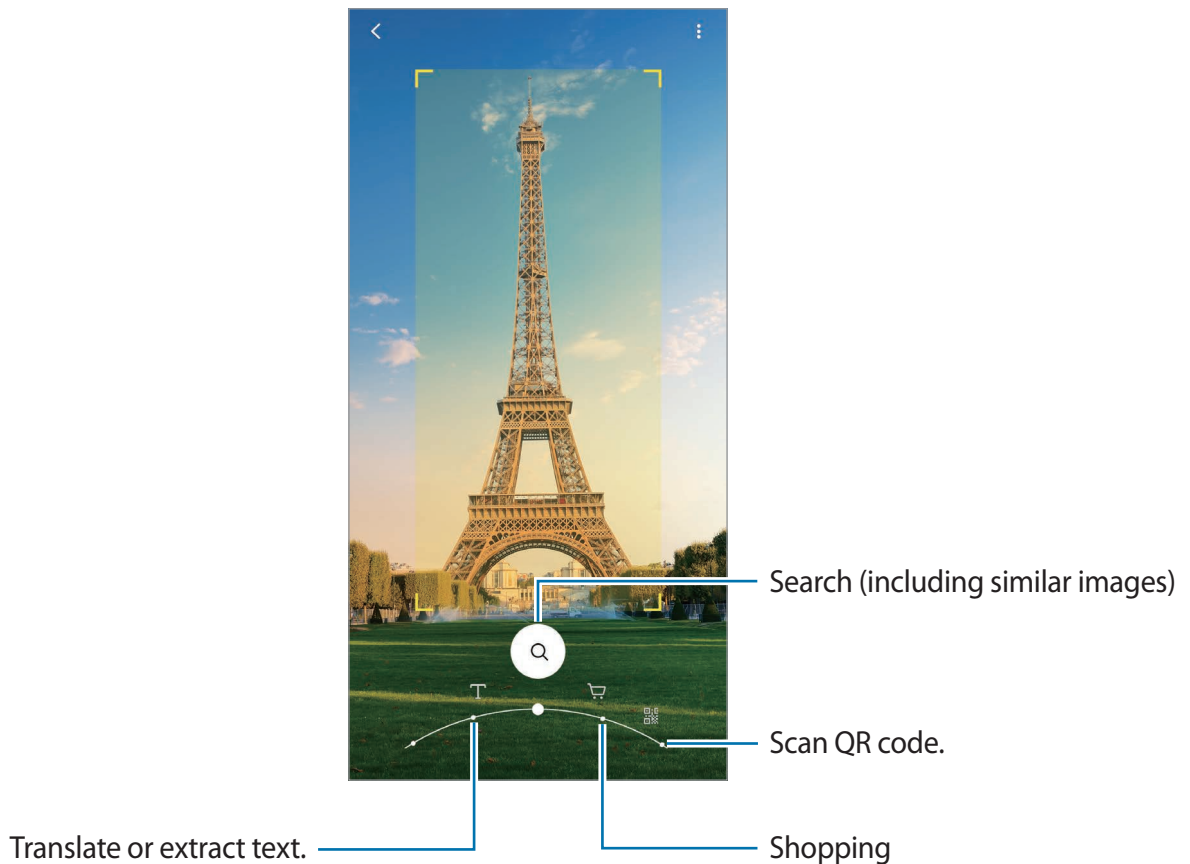

- To use this feature, the device must be connected to a Wi-Fi or mobile network.
- The available features and search results may vary depending on the region or service provider.
- This feature may not be available or you may not get correct search results depending on the image size, format, or resolution.
- Samsung is not responsible for the product information provided by Bixby Vision.

## Launching Bixby Vision

Launch Bixby Vision using one of these methods.

- In the **Camera** app, tap **MORE** on the shooting modes list and tap **BIXBY VISION**.
- In the **Gallery** app, select an image and tap .
- In the **Internet** app, tap and hold an image and tap **Bixby Vision**.
- If you added the Bixby Vision app icon to the Apps screen, launch the **Bixby Vision** app.

## Translating or extracting text



Recognise and show the translated text on the screen. You can also extract text from a document or an image file.

For example, if you want to know what a sign says while travelling abroad, use the Bixby Vision features. The device will translate the sign's text into the language you select.

**1** Launch the **Camera** app, tap **MORE** on the shooting modes list, and then tap **BIXBY VISION**.

**2** Select  and keep the text within the screen to recognise it.

The translated text will appear on the screen.

- To extract text, tap . If you tap , you can use additional features with the extracted text, such as sharing or saving it.
- To change the source or target language, tap the language settings panel at the bottom of the screen.

## Searching for similar images and related information

Search for images similar to the recognised object online and related information. You can view various images with properties similar to the object, such as colour or shape, and view the related information.

For example, if you want to know the information about a building, use the Bixby Vision features. The device will search for and show you related information or images with similar characteristics.

**1** Launch the **Camera** app, tap **MORE** on the shooting modes list, and then tap **BIXBY VISION**.

2 Select  and keep the object within the screen to recognise it.

3 Select a search result.

The similar images and related information will appear.

## Searching for shopping information

Recognise a product to search for information even when you do not know the product's name.

For example, if you want to search for the product's information online, use the Bixby Vision features and the device will search for it and show you the results.

1 Launch the **Camera** app, tap **MORE** on the shooting modes list, and then tap **BIXBY VISION**.

2 Select  and keep the object within the screen to recognise it.

3 Select a search result.

The information about the product will appear.

## Reading QR codes

Recognise QR codes and view a variety of information, such as websites, photos, videos, maps, and business cards.

1 Launch the **Camera** app, tap **MORE** on the shooting modes list, and then tap **BIXBY VISION**.

2 Select  and keep the QR code within the screen to recognise it.

The information connected to the QR code will appear.

# Bixby Routines

## Introduction

Bixby Routines are a service that automates settings you use repeatedly and suggests useful features according to your frequent situations by learning your usage patterns.

For example, a 'before bed' routine will perform actions, such as turning on silent mode and dark mode, to not be jarring on your eyes and ears when you use the device before going to bed.

## Adding routines

Add routines to use your device more conveniently. When you add a routine, you can set its running condition to auto or manual.

## Adding recommended routines

When your device learns your usage patterns, it will recommend adding useful or frequently used features as routines.

When the recommendation notification appears, tap **View all** and add it as your own routine.

## Adding routines from the recommendation list

View the list of useful features and add them as your own routines.

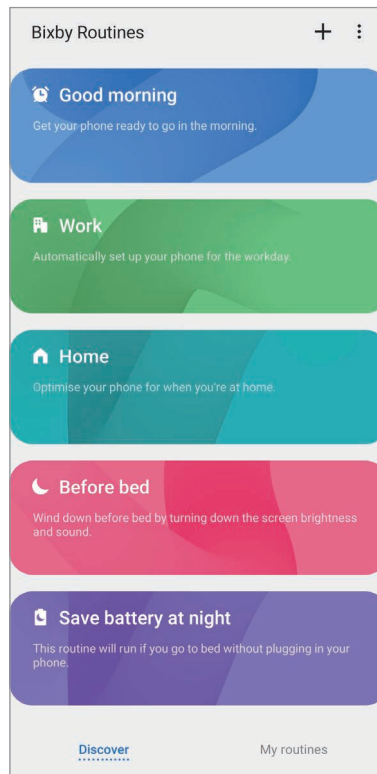

- 1 Launch the **Settings** app and tap **Advanced features** → **Bixby Routines**.
- 2 On the **Discover** list, select a routine you want and tap **Save**.
  - To set the routine's conditions and actions, tap **Edit**. Alternatively, tap the condition or action you want to edit.
  - If you want to set the routine's running condition to manual, tap **Start button tapped**. This option will appear only when there are no running conditions set.  
For manual routines, you can add them to the Home screen as widgets and access them quickly. When a pop-up window appears, tap **Add**.

## Adding your own routines

Add features you want to use as routines.

- 1 Launch the **Settings** app and tap **Advanced features** → **Bixby Routines** → **+**.
- 2 Tap **+**, set conditions, and then tap **Next**.  
If you want to set the routine's running condition to manual, tap **Start button tapped**.



3 Tap **+**, set actions, and then tap **Done**.

4 Enter a routine name and tap **Done**.

For manual routines, you can add them to the Home screen as widgets and access them quickly. When a pop-up windows appears, tap **Add**.

## Using routines

### Running auto routines

Auto routines will run automatically when their conditions are detected.

### Running manual routines

For manual routines which you set the running condition as **Start button tapped**, you can run them manually by tapping the button whenever you want.

Launch the **Settings** app and tap **Advanced features** → **Bixby Routines** → **My routines** and tap  next to the routine you want to run. Alternatively, tap the routine's widget on the Home screen.

### Viewing running routines

Currently running routines will appear on the notification panel. To view a routine's details, tap the notification.

### Stopping running routines

You can quickly stop running routines. On the notification panel, tap  next to a routine and tap **Stop**.

## Managing routines

Launch the **Settings** app and tap **Advanced features** → **Bixby Routines** → **My routines**. Your routines will appear.

To deactivate a routine, tap the routine's switch or .

To edit a routine, select a routine and tap **Edit**. Alternatively, tap the condition or action you want to edit.



To delete routines, tap  → **Delete**, tick routines to delete, and then tap **Delete**.

# Phone

## Introduction

Make or answer voice and video calls.

## Making calls

- 1 Launch the **Phone** app and tap **Keypad**.
- 2 Enter a phone number.
- 3 Tap  to make a voice call, or tap  to make a video call.

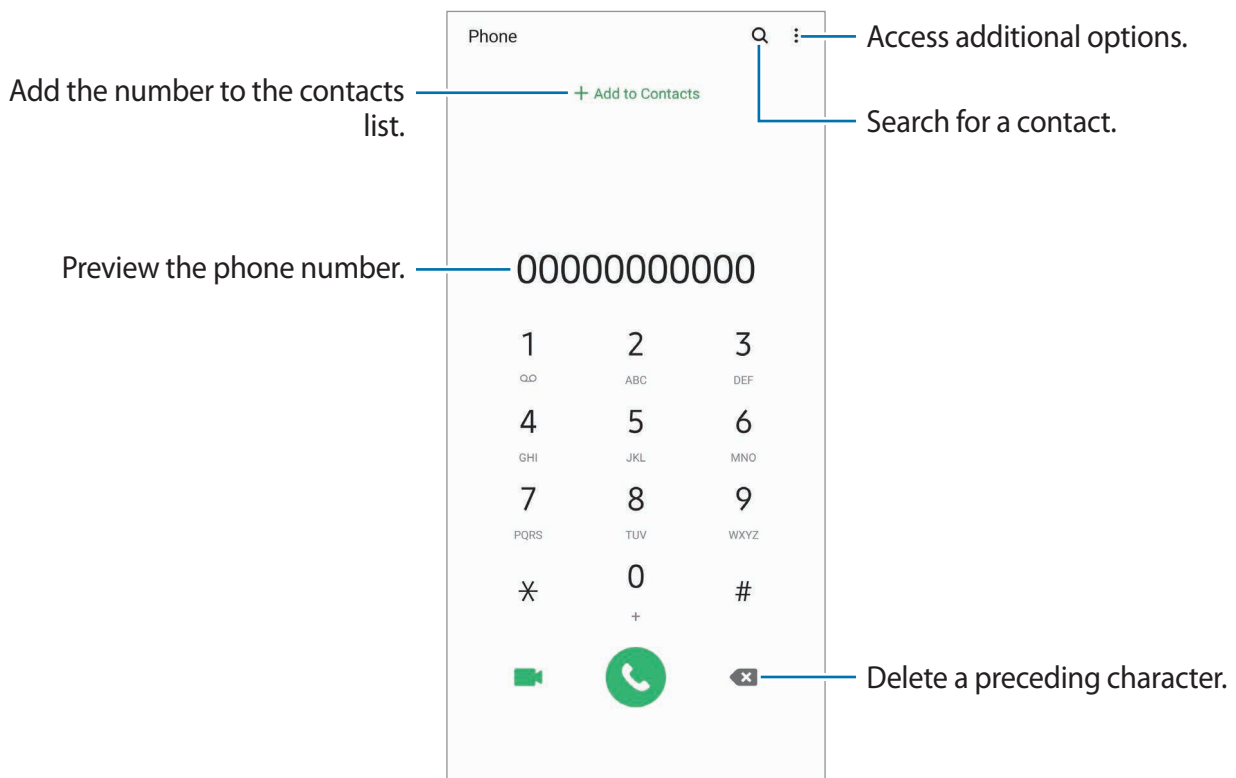

## Making calls from call logs or contacts list

Launch the **Phone** app, tap **Recents** or **Contacts**, and then swipe to the right on a contact or a phone number to make a call.

If this feature is deactivated, launch the **Settings** app, tap **Advanced features** → **Motions and gestures**, and then tap the **Swipe to call or send messages** switch to activate it.

## Using speed dial

Set speed dial numbers to quickly make calls.

To set a number to speed dial, launch the **Phone** app, tap **Keypad** or **Contacts** →  → **Speed dial numbers**, select a speed dial number, and then add a phone number.

To make a call, tap and hold a speed dial number on the keypad. For speed dial numbers 10 and up, tap the first digit(s) of the number, and then tap and hold the last digit.

For example, if you set the number **123** as a speed dial number, tap **1**, tap **2**, and then tap and hold **3**.

## Making calls from the locked screen

On the locked screen, drag  outside the circle.

## Making calls by searching for nearby places

You can easily make calls to places near your current location by searching for their information. You can search for nearby places by category, such as restaurants or stores, or by selecting recommended hot places.

Launch the **Phone** app, tap **Places**, and then select a category or tap  and enter a business name in the search field. Or, select one from the recommended hot places. The business's information, such as its phone number or address, will appear.



This feature may not be available depending on the region or service provider.

## Making an international call

- 1 Launch the **Phone** app and tap **Keypad**.
- 2 Tap and hold **0** until the + sign appears.
- 3 Enter the country code, area code, and phone number, and then tap .

## Receiving calls



### Answering a call

When a call comes in, drag  outside the large circle.

### Rejecting a call

When a call comes in, drag  outside the large circle.

To send a message when rejecting an incoming call, drag the **Send message** bar upwards and select a message to send. If the **Add reminder** switch is activated, a reminder will be saved to alert you of the rejected call one hour later.



To create various rejection messages, launch the **Phone** app, tap  → **Settings** → **Quick decline messages**, enter a message, and then tap .

### Missed calls

If a call is missed, the  icon appears on the status bar. Open the notification panel to view the list of missed calls. Alternatively, launch the **Phone** app and tap **Recents** to view missed calls.

## Blocking phone numbers

Block calls from specific numbers added to your block list.

- 1 Launch the **Phone** app and tap  → **Settings** → **Block numbers**.
- 2 Tap **Recents** or **Contacts**, select contacts or phone numbers, and then tap **Done**.  
To manually enter a number, tap **Add phone number**, enter a phone number, and then tap .

When blocked numbers try to contact you, you will not receive notifications. The calls will be logged in the call log.



You can also block incoming calls from people that do not show their caller ID. Tap the **Block unknown callers** switch to activate the feature.

## Options during calls



If the area around the rear camera is covered, unwanted noises may incur during a call. Remove accessories, such as a screen protector or stickers, around the rear camera area.

### During a voice call

The following actions are available:

- : Access additional options.
- **Add call**: Dial a second call. The first call will be put on hold. When you end the second call, the first call will be resumed.
- **Hold call**: Hold a call. Tap **Resume call** to retrieve the held call.
- **Bluetooth**: Switch to a Bluetooth headset if it is connected to the device.
- **Speaker**: Activate or deactivate the speakerphone. When using the speakerphone, keep the device away from your ears.
- **Mute**: Turn off the microphone so that the other party cannot hear you.
- **Keypad / Hide**: Open or close the keypad.
- : End the current call.

### During a video call

Tap the screen to use the following options:

- : Access additional options.
- **Camera**: Turn off the camera so that the other party cannot see you.
- **Switch**: Switch between the front and rear cameras.
- : End the current call.
- **Mute**: Turn off the microphone so that the other party cannot hear you.
- **Speaker**: Activate or deactivate the speakerphone. When using the speakerphone, keep the device away from your ears.

## Adding a phone number to Contacts

### Adding a phone number to Contacts from the keypad

- 1 Launch the **Phone** app and tap **Keypad**.
- 2 Enter the number.
- 3 Tap **Add to Contacts**.
- 4 Tap **Create new contact** to create a new contact, or tap **Update existing contact** to add the number to an existing contact.

### Adding a phone number to Contacts from the calls list

- 1 Launch the **Phone** app and tap **Recents**.
- 2 Tap a caller's image and tap **Add**, or tap a phone number and tap **Add to Contacts**.
- 3 Tap **Create new contact** to create a new contact, or tap **Update existing contact** to add the number to an existing contact.

## Adding a tag to a phone number

You can add tags to numbers without saving them to Contacts. This allows you to view the caller's information when they call without having them listed in Contacts.

- 1 Launch the **Phone** app and tap **Recents**.
- 2 Tap a phone number → .
- 3 Tap **Add note**, enter a tag, and then tap **Add**.

When a call comes from that number, the tag will show under the number.

# Contacts

## Introduction

Create new contacts or manage contacts on the device.

## Adding contacts

### Creating a new contact

- 1 Launch the **Contacts** app and tap .
- 2 Select a storage location.
- 3 Enter contact information.

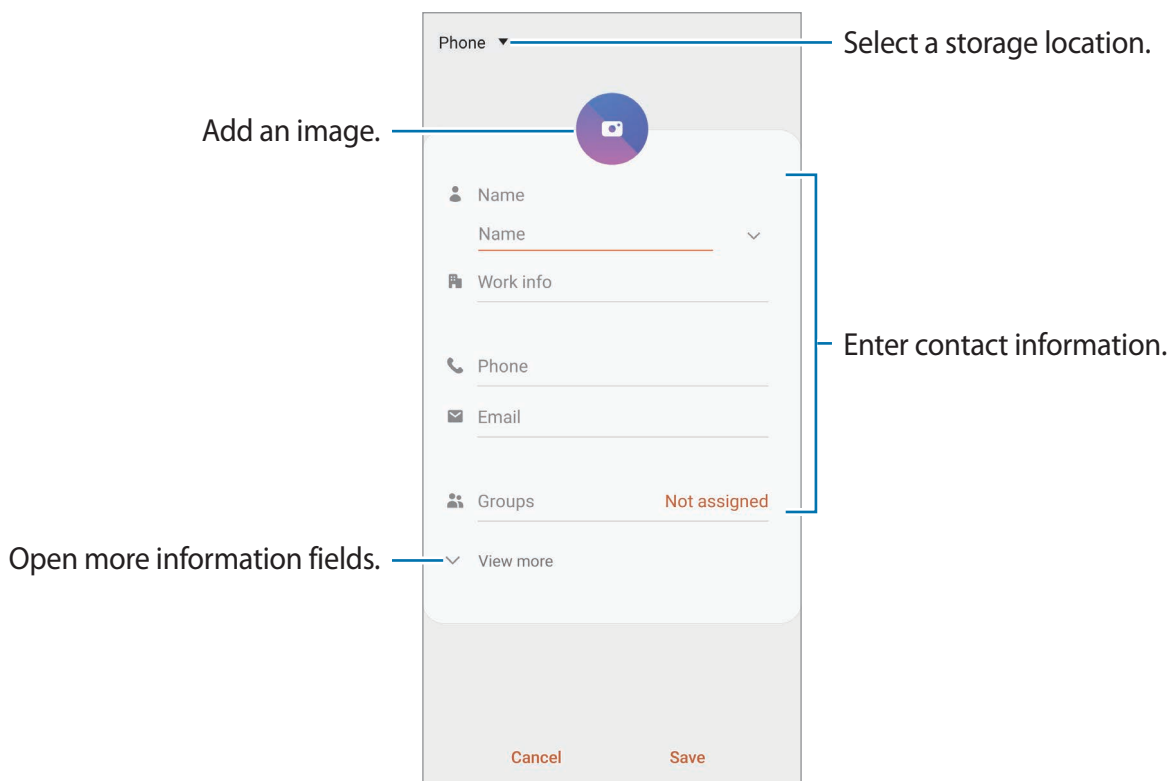

Depending on the selected storage location, the types of information you can save may vary.

- 4 Tap **Save**.

## Importing contacts

Add contacts by importing them from other storages to your device.

- 1 Launch the **Contacts** app and tap  → **Manage contacts** → **Import or export contacts** → **Import**.
- 2 Select a storage location to import contacts from.
- 3 Tick VCF files or contacts to import and tap **Done**.
- 4 Select a storage location to save contacts to and tap **Import**.

## Syncing contacts with your web accounts

Sync your device contacts with online contacts saved in your web accounts, such as your Samsung account.

- 1 Launch the **Settings** app, tap **Accounts and backup** → **Accounts** and select the account to sync with.
- 2 Tap **Sync account** and tap the **Contacts** switch to activate it.  
For the Samsung account, tap  → **Sync settings** and tap the **Contacts** switch to activate it.

## Searching for contacts

Launch the **Contacts** app.

Use one of the following search methods:

- Scroll up or down the contacts list.
- Drag a finger along the index at the right side of the contacts list to scroll through it quickly.
- Tap **Q** at the top of the contacts list and enter search criteria.



Tap the contact. Then take one of the following actions:

- ☆ : Add to favourite contacts.
- 📞 / 📺 : Make a voice or video call.
- 💬 : Compose a message.
- ✉️ : Compose an email.

## Sharing contacts

You can share contacts with others by using various sharing options.

- 1 Launch the **Contacts** app and tap  → **Share**.
- 2 Select contacts and tap **Share**.
- 3 Select a sharing method.

## Saving and sharing profile

Save and share your profile information, such as your photo and status message, with others using the profile sharing feature.



- To use this feature, you must sign in to your Samsung account.
- The profile sharing feature may not be available depending on the region or service provider.
- The profile sharing feature is only available for contacts who have activated the profile sharing feature on their device.

- 1 Launch the **Contacts** app and select your profile.
- 2 Tap **Tap here to share your profile** and tap the switch to activate it.
  - To use the profile sharing feature, your phone number must be verified. You can view your contacts' updated profile information in **Contacts**.
  - To change the scope of contacts to share your profile with, tap **Select what's shared**, select an item to share, and then select an option.

## Creating groups

You can add groups, such as family or friends, and manage contacts by group.

- 1 Launch the **Contacts** app and tap  → **Groups** → **Create group**.
- 2 Enter a group name.  
To set a group ringtone, tap **Group ringtone** and select a ringtone.
- 3 Tap **Add member**, select contacts to add to the group, and then tap **Done**.
- 4 Tap **Save**.

## Sending a group message

You can send a group message to a group's members at the same time.

Launch the **Contacts** app, tap  → **Groups**, select a group, and then tap  → **Send message**.

## Merging duplicate contacts

When you import contacts from other storages, or sync contacts with other accounts, your contacts list may include duplicate contacts. Merge duplicate contacts into one to streamline your contacts list.

- 1 Launch the **Contacts** app and tap  → **Manage contacts** → **Merge contacts**.
- 2 Tick contacts and tap **Merge**.

## Deleting contacts

- 1 Launch the **Contacts** app and tap  → **Delete**.
- 2 Select contacts and tap **Delete**.

To delete contacts one by one, open the contacts list and tap a contact. Then tap  → **Delete**.

# Messages

## Introduction

Send and view messages by conversation.

## Sending messages



You may incur additional charges for sending messages when you are roaming.

1 Launch the **Messages** app and tap .

2 Add recipients and enter a message.

To record and send a voice message, tap and hold , say your message, and then release your finger. The recording icon appears only while the message input field is empty.

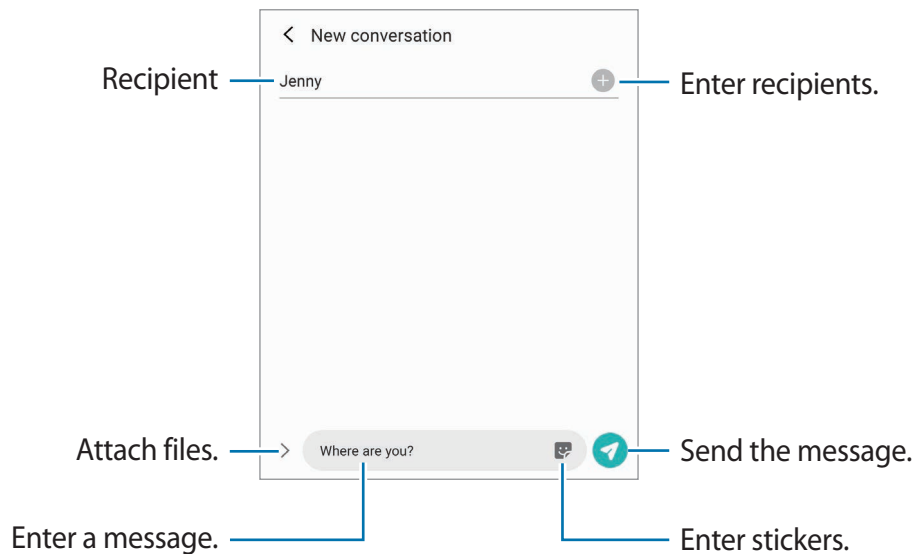

3 Tap  to send the message.

## Viewing messages

Messages are grouped into message threads by contact.



You may incur additional charges for receiving messages when you are roaming.

- 1 Launch the **Messages** app and tap **Conversations**.
- 2 On the messages list, select a contact or a phone number.
  - To reply to the message, tap the message input field, enter a message, and then tap .
  - To adjust the font size, spread two fingers apart or pinch on the screen.



## Sorting messages

You can sort messages by category and manage them easily.

- 1 Launch the **Messages** app and tap **Conversations**.
- 2 Tap **New category** → **Add category**.  
If the category option does not appear, tap  → **Settings** and tap the **Conversations categories** switch to activate it.
- 3 Enter a category name and tap **Done**.
- 4 Select conversations to add to the category and tap **Done**.

## Blocking unwanted messages

Block messages from specific numbers added to your block list.

- 1 Launch the **Messages** app and tap  → **Settings** → **Block numbers and messages** → **Block numbers**.
- 2 Tap **Conversations** and select a contact or a phone number. Or, tap **Contacts**, select contacts, and then tap **Done**.  
To manually enter a number, enter a phone number under **Enter phone number** and tap .

## Setting the message notification

You can change notification sound, display options, and more.

- 1 Launch the **Messages** app, tap **⋮** → **Settings** → **Notifications**, and then tap the switch to activate it.
- 2 Change the notification settings.

## Setting a message reminder

You can set an alert at an interval to let you know that you have unchecked notifications. If this feature is not activated, launch the **Settings** app, tap **Accessibility** → **Advanced settings** → **Notification reminders**, and then tap the switch to activate it.

## Deleting messages

- 1 Launch the **Messages** app and tap **Conversations**.
- 2 On the messages list, select a contact or a phone number.
- 3 Tap and hold a message, then tap **Delete**.  
To delete multiple messages, tick messages you want to delete.
- 4 Tap **Delete**.

# Internet

## Introduction

Browse the Internet to search for information and bookmark your favourite webpages to access them conveniently.

## Browsing webpages

- 1 Launch the **Internet** app.
- 2 Tap the address field.
- 3 Enter the web address or a keyword, and then tap **Go**.

To view the toolbars, drag your finger downwards slightly on the screen.

To switch between tabs quickly, swipe to the left or right on the address field.

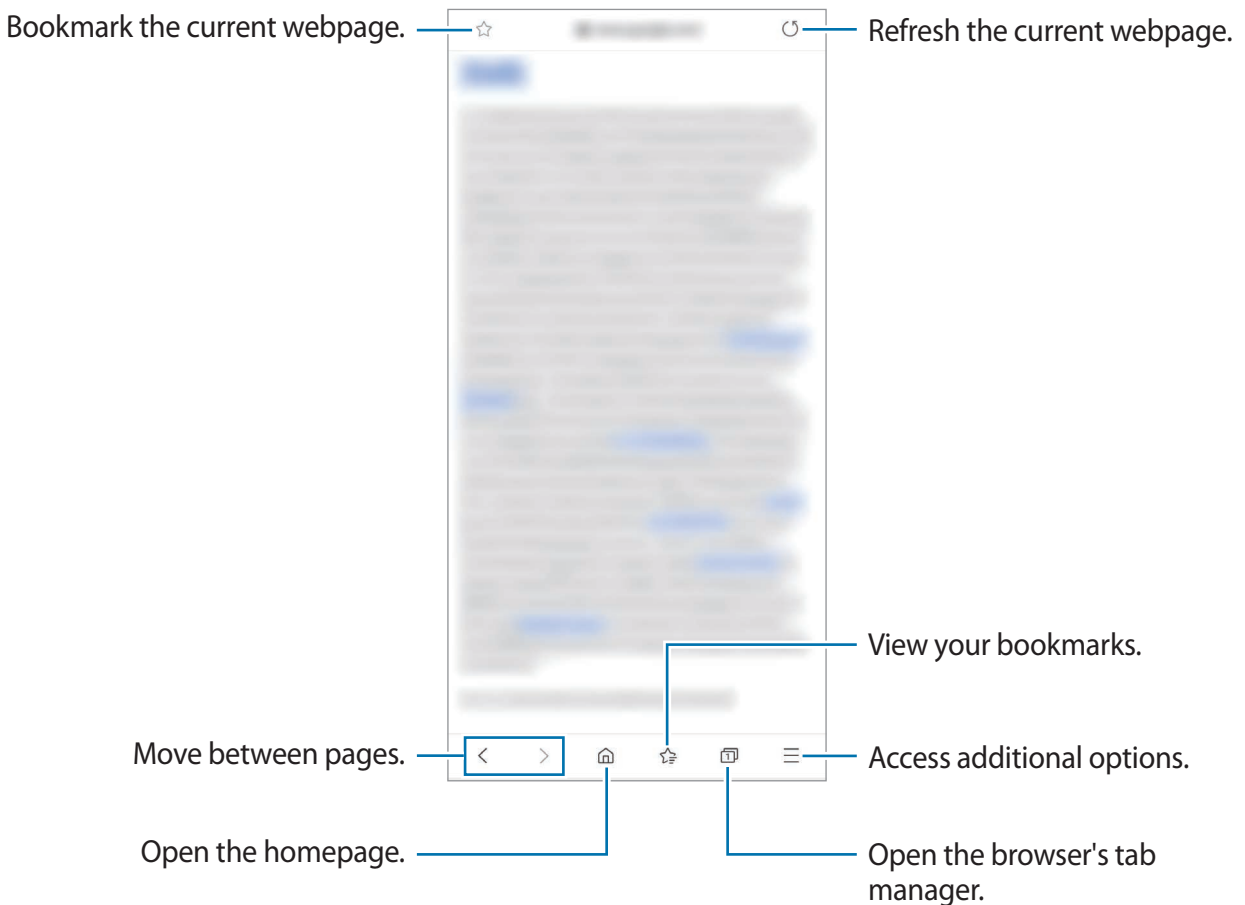

## Using secret mode

In secret mode, you can separately manage open tabs, bookmarks, and saved pages. You can lock secret mode using a password and your biometric data.

### Activating secret mode

In the toolbar at the bottom of the screen, tap  → **Turn on Secret mode**. If you are using this feature for the first time, set whether to use a password for secret mode.

In secret mode, the device will change the colour of the toolbars.



In secret mode, you cannot use some features, such as screen capture.

### Changing security settings

You can change your password or the lock method.

Tap  → **Settings** → **Privacy and security** → **Secret mode settings** → **Change password**.

To use your registered biometric data as a lock method along with the password, tap an option switch under **Biometrics** to activate it.

### Deactivating secret mode

In the toolbar at the bottom of the screen, tap  → **Turn off Secret mode**.

# Camera

## Introduction

Take photos and record videos using various modes and settings.

### Camera etiquette

- Do not take photos or record videos of other people without their permission.
- Do not take photos or record videos where legally prohibited.
- Do not take photos or record videos in places where you may violate other people's privacy.

## Launching Camera

Use the following methods to launch **Camera**:

- Launch the **Camera** app.
- Press the Side key twice quickly.
- On the locked screen, drag  outside the circle.



- Some methods may not be available depending on the region or service provider.
- Some camera features are not available when you launch the **Camera** app from the locked screen or when the screen is turned off while the screen lock method is set.
- If photos you take appear blurry, clean the camera lens and try again.



## Taking photos

1 Tap the image on the preview screen where the camera should focus.

To adjust the brightness of photos, tap the screen. When the adjustment bar appears, drag the adjustment bar towards **+** or **-**.

2 Tap  to take a photo.

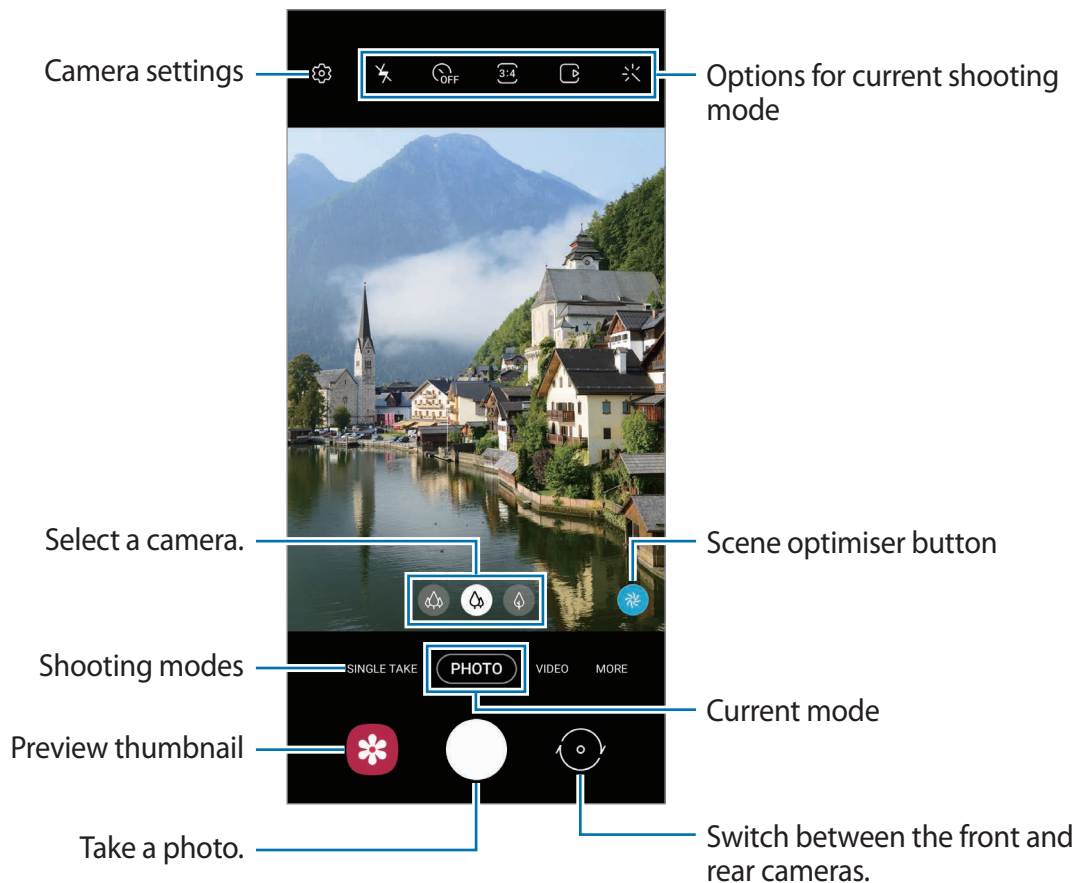

- The preview screen may vary depending on the shooting mode and which camera is being used.
- The camera automatically shuts off when unused.
- Make sure that the lens is not damaged or contaminated. Otherwise, the device may not work properly in some modes that require high resolutions.
- Your device's camera features a wide-angle lens. Minor distortion may occur in wide-angle photos or videos and does not indicate device performance problems.
- When you take photos or videos with a high resolution or a high zoom ratio, the focus may not be clear if the subject is close. Take photos or videos from a good distance.

## Using zoom features

Spread two fingers apart on the screen to zoom in, and pinch to zoom out. Alternatively, drag the camera selection icon to the left or right. If the zoom ratio exceeds a certain level, a zoom guide map will appear to indicate where you are zooming in on the image.



Zoom features are available only when using the rear camera.

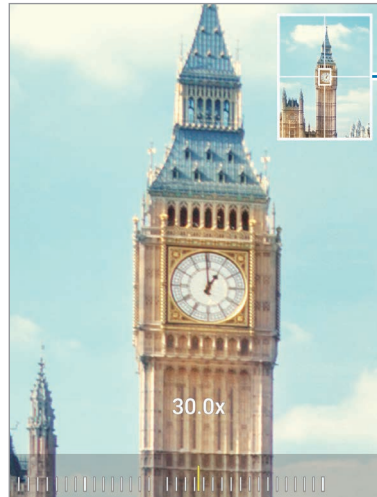

Zoom guide map

## Using the camera button

Tap and hold the camera button to record a video.

To take burst shots, swipe downwards on the camera button and hold it.

## Options for current shooting mode

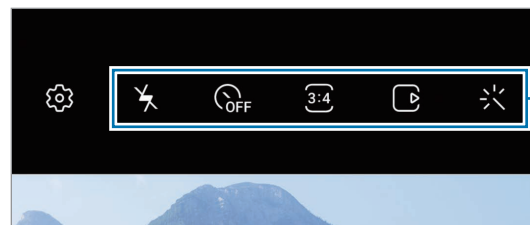

On the preview screen, use the following options.

















Options for current shooting mode



The available options may vary depending on the shooting mode.

-  : Activate or deactivate the flash.
-  : Select the length of the delay before the camera automatically takes a photo.
-  : Select an aspect ratio and resolution for photos.

- : Activate or deactivate the motion photo feature. If you activate the feature, a video clip will also be taken from a few seconds before tapping the camera button.
- : Stabilise a video.
- : Activate or deactivate the night hyperlapse feature.
- : Select a frame rate.
- : Select an aspect ratio and resolution for videos.
- : Apply a filter effect or beauty effects.
- : Record fun videos with virtual handwriting or drawings on faces or anywhere else. Refer to [AR Doodle](#) for more information.
- : Select a metering method. This determines how light values are calculated.  **Centre-weighted** uses the light in the centre portion of the shot to calculate the exposure of the shot.  **Spot** uses the light in a concentrated centre area of the shot to calculate the exposure of the shot.  **Matrix** averages the entire scene.
- : In **FOOD** mode, focus on a subject inside the circular frame and blur the image outside the frame.
- : In **FOOD** mode, adjust the colour tone.
- : Activate or deactivate the motion detection feature when recording super slow-mo videos.

## Changing shooting modes

To change the shooting mode, drag the shooting modes list to the left or right, or swipe to the left or right on the preview screen.

Select a shooting mode you want.

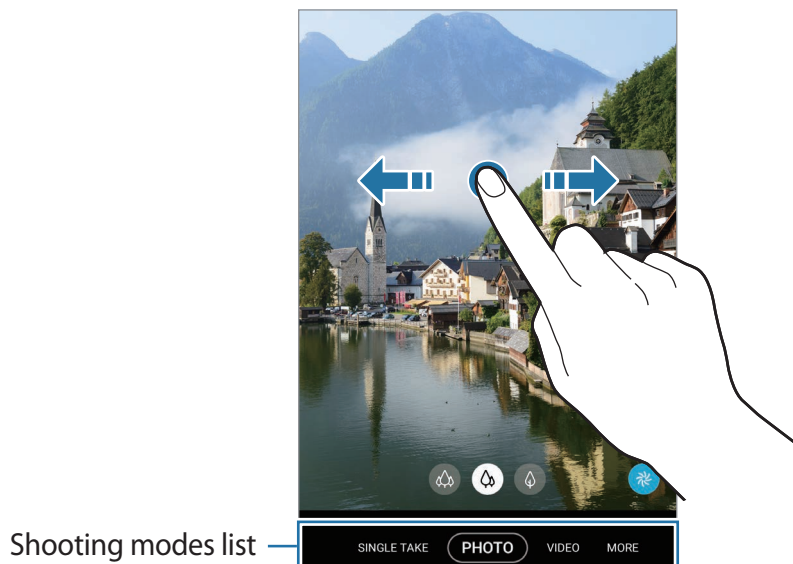



## Selecting a camera for shooting



On the preview screen, select the camera you want and take a photo or record a video.



This feature is only available in some shooting modes.

-  (Ultra wide): The Ultra wide camera lets you take wide-angle photos or record wide-angle videos which look just like the actual view. Use this feature to take landscape photos.

To correct the distortion in photos taken with the Ultra wide camera, tap  on the preview screen, tap **Save options**, and then tap the **Ultra wide shape correction** switch to activate it.

-  (Wide-angle): The wide-angle camera lets you take basic photos or record normal videos.
-  (Telephoto): The telephoto camera (optical zoom) lets you take photos or record videos by enlarging the subject.



 Ultra wide



 Wide-angle



 Telephoto

## Photo mode (Intelligent camera)

The camera adjusts the shooting options automatically depending on the surroundings to capture photos easily. The intelligent camera feature automatically recognises the subject and optimises the colour and any effects.





On the shooting modes list, tap **PHOTO** and tap  to take a photo.

### Taking high-resolution photos

Take high-resolution photos. You can crop the high-resolution photos by enlarging the area you want and saving it as a high-resolution file.



The resolution may vary depending on the model.

- 1 On the shooting modes list, tap **PHOTO**.
- 2 In the shooting options, tap  →  or .
- 3 Tap  to take a photo.





## Scene optimiser

The camera adjusts the colour settings and applies the optimised effect automatically by recognising the subject.

On the shooting modes list, tap **PHOTO**. When the camera recognises the subject, the scene optimiser button will change and the optimised colour and effect will be applied.



- If this feature is not activated, tap  on the preview screen and tap the **Scene optimiser** switch to activate it.
- To use additional features, tap  on the preview screen, tap **Scene optimiser**, and then tap the switches next to the features you want.
- If you do not want to use this feature, tap the scene optimiser button on the preview screen.

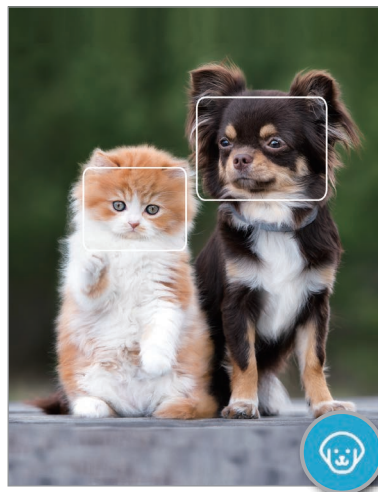

## Shot suggestions

The camera suggests the ideal composition for the photo by recognising the position and angle of your subject.

On the preview screen, tap  and tap the **Shot suggestions** switch to activate it.

- 1 On the shooting modes list, tap **PHOTO**.  
A guide will appear on the preview screen.

2 Point the guide at the subject.

The camera recognises the composition, and the recommended composition appears on the preview screen.

3 Adjust the position and angle of the camera to fit the composition.

When the ideal composition is achieved, the guide will change to yellow.

4 Tap  to take a photo.

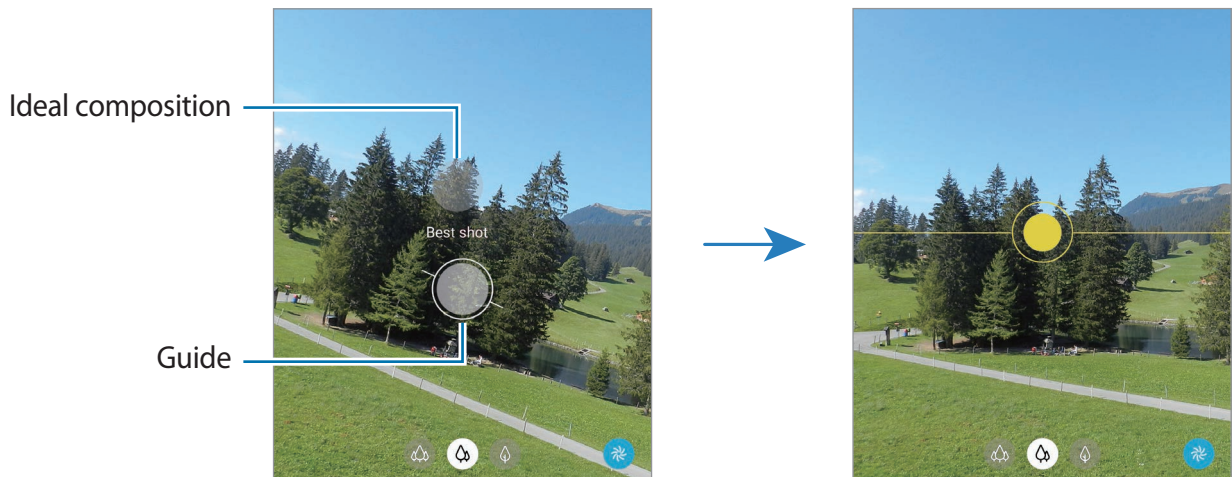

## Taking selfies

You can take self-portraits with the front camera.

1 On the shooting modes list, tap **PHOTO**.

2 On the preview screen, swipe upwards or downwards, or tap  to switch to the front camera for self-portraits.

3 Face the front camera lens.

To take self-portraits with a wide-angle shot of the landscape or people, tap .

4 Tap  to take a photo.



## Applying filter and beauty effects

You can select a filter effect and modify facial features, such as your skin tone or face shape, before taking a photo.

- 1 On the preview screen, tap .
- 2 Select a filter effect or beauty effects and take a photo.

## Creating filters

Select an image with a colour tone you like from **Gallery**, and save the colour tone as a new filter. When you then take a photo with the filter, you can get a similar look.

- 1 On the preview screen, tap  → **My filters**.  
When you create a filter for the first time, select a sample image with a colour tone you want to use and tap **Next** → **Save filter**.
- 2 Tap  and select an image with a colour tone you want to use.  
To change the filter name, tap the name.
- 3 Tap **Save filter**.

## Locking the focus (AF) and exposure (AE)

You can lock the focus or exposure on a selected area to prevent the camera from automatically adjusting based on changes to the subjects or light sources.

Tap and hold the area to focus, the AF/AE frame will appear on the area and the focus and exposure setting will be locked. The setting remains locked even after you take a photo.





## Video mode

The camera adjusts the shooting options automatically depending on the surroundings to record videos easily.

1 On the shooting modes list, tap **VIDEO**.

2 Tap  to record a video.

- To switch between the front and rear cameras while recording, swipe upwards or downwards on the preview screen or tap .
- To capture an image from the video while recording, tap .
- To change the focus while recording a video, tap where you want to focus. To use auto focus mode, tap **AF** to cancel the manually set focus.
- To record the sound from a specific direction at a higher volume, point the camera towards the direction and enlarge the screen by spreading two fingers apart on it.

3 Tap  to stop recording the video.



- If you use the video zoom feature for a long time while recording a video, the video quality may diminish to prevent your device from overheating.
- The optical zoom may not work in low-light environments.

## Recording high-resolution videos

Record high-resolution videos with a maximum resolution of 8K.

Tap  →  and record a video.

When you finish recording an 8K video, play the video in the **Gallery** app. When you tap  on a frame that you like, the frame will be saved as a high-resolution photo.



The maximum capacity for recording a video may vary depending on the resolution.

## Stabilising videos (Super steady)

When recording videos, stabilise them using the Super steady feature.



Tap **VIDEO** on the shooting modes list, tap  on the shooting options to activate it, and then record a video.

## Single take mode

Take photos or videos in single take mode when you want to get a variety of results with just one shot. Your device automatically captures the best shot and videos and creates photos with optimised filters or videos with certain sections repeated.

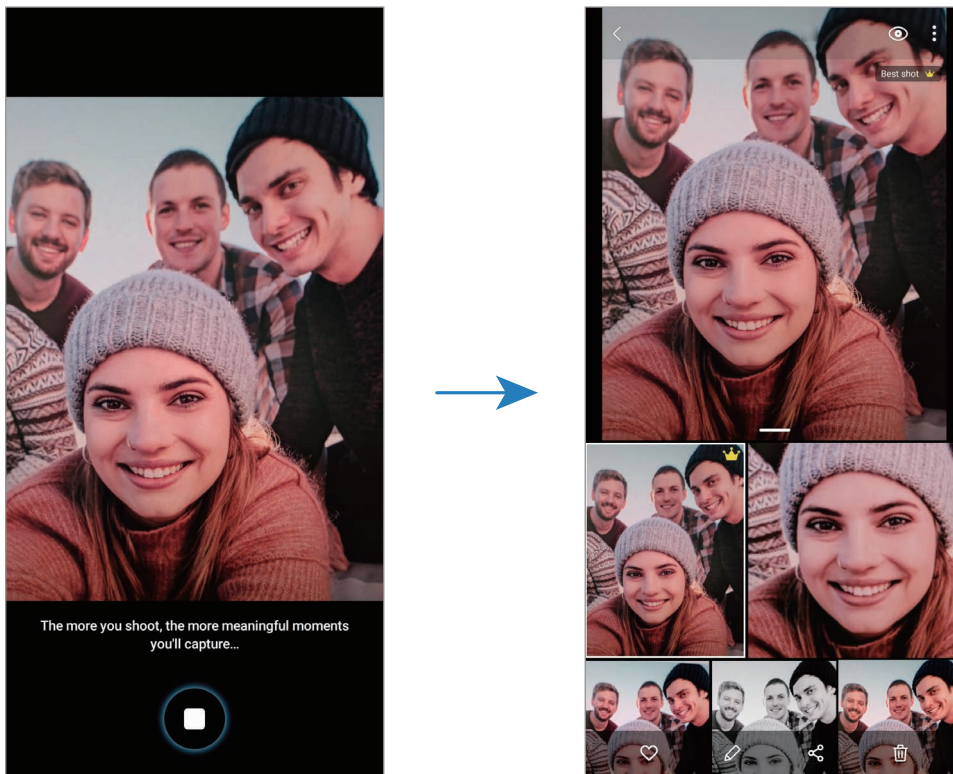

- 1 On the shooting modes list, tap **SINGLE TAKE**.
- 2 Tap  and move the camera to capture the scene you want.



- 3 When you are finished, tap the preview thumbnail.  
A variety of optimised results for the scene will appear. To view other results, drag the  icon upwards.  
To save the results individually, tap **Select**, tick the items you want, and then tap .

## Pro mode / Pro video mode

Capture photos or videos while manually adjusting various shooting options, such as exposure value and ISO value.







On the shooting modes list, tap **MORE** → **PRO** or **PRO VIDEO**. Select options and customise the settings, and then tap  to take a photo or tap  to record a video.

### Available options

-  : Select an ISO value. This controls camera light sensitivity. Low values are for stationary or brightly lit objects. Higher values are for fast-moving or poorly lit objects. However, higher ISO settings can result in noise in photos or videos.



If the shutter speed is set manually, you cannot set the ISO setting to **AUTO**.

-  : Adjust the shutter speed. A slow shutter speed allows more light in, so the photo or video becomes brighter. This is ideal for photos or videos of scenery or photos or videos taken at night. A fast shutter speed allows less light in. This is ideal for capturing photos or videos of fast-moving subjects.
-  : Adjust the colour tone.
-  : Change the focus mode. Drag the adjustment bar towards  or  to manually adjust the focus. To switch to auto focus mode, tap **MANUAL**.
-  : Select an appropriate white balance, so images have a true-to-life colour range. You can set the colour temperature.
-  : Change the exposure value. This determines how much light the camera's sensor receives. For low-light situations, use a higher exposure.



If the shutter speed is set manually, you cannot change the exposure value. The exposure value will change and be displayed based on the shutter speed setting.

## Separating the focus area and the exposure area

You can separate the focus area and the exposure area.

Tap and hold the preview screen. The AF/AE frame will appear on the screen. Drag the frame to the area where you want to separate the focus area and the exposure area.



## Panorama mode

Using panorama mode, take a series of photos and then stitch them together to create a wide scene.



To get the best shots using panorama mode, follow these tips:

- Move the camera slowly in one direction.
- Keep the image within the frame on the camera's viewfinder. If the preview image is out of the guide frame or you do not move the device, the device will automatically stop taking photos.
- Avoid taking photos of indistinct backgrounds, such as an empty sky or a plain wall.



1 On the shooting modes list, tap **MORE** → **PANORAMA**.

2 Tap  and move the device slowly in one direction.

3 Tap  to stop taking photos.

## Food mode

Take photos of food with more vibrant colours.

- 1 On the shooting modes list, tap **MORE** → **FOOD**.
- 2 Tap the screen and drag the circular frame over the area to highlight.  
The area outside the circular frame will be blurred.  
To resize the circular frame, drag a corner of the frame.
- 3 Tap  and drag the adjustment bar to adjust the colour tone.
- 4 Tap  to take a photo.

## Night mode

Take a photo in low-light conditions, without using the flash. When you use a tripod, you can get brighter and steadier results.

- 1 On the shooting modes list, tap **MORE** → **NIGHT**.
- 2 Tap  and hold your device steady until shooting is complete.

## Live focus mode / Live focus video mode

The camera allows you to capture photos or videos where the background is blurred and the subject stands out clearly. You can also apply a background effect and edit it after taking a photo.



The available options may vary depending on the shooting mode.



Blur



Big circle



Spin



Zoom





Colour point



- Use this feature in a place that has sufficient light.
- The background blur may not be applied properly in the following conditions:
  - The device or the subject is moving.
  - The subject is thin or transparent.
  - The subject has a similar colour to the background.
  - The subject or background is plain.

## Highlighting subjects using the Live focus feature

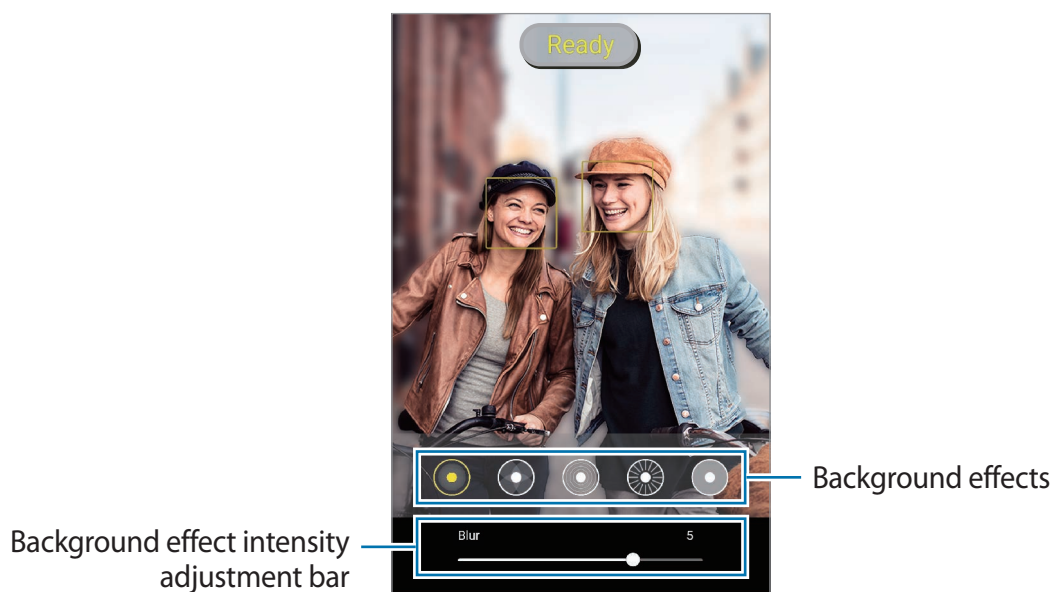

- 1 On the shooting modes list, tap **MORE** → **LIVE FOCUS** or **LIVE FOCUS VIDEO**.
- 2 Tap  and select a background effect you want.  
To adjust the intensity of the background effect, drag the adjustment bar to the left or right.
- 3 When **Ready** appears on the preview screen, tap  to take a photo or tap  to record a video.



## Editing the background of the Live focus photos

You can also edit the background effect and the intensity of the background effect for a photo taken with the Live focus feature.

- 1 Select a photo taken with the Live focus feature and tap **Change background effect**.
- 2 Select a background effect you want.
  - To adjust the intensity of the background effect, drag the adjustment bar to the left or right.

- When the background lighting appears in blurred points, the  (**Artistic**) icon will appear on the effects list. To change the shape of the background blur, tap  and select the shape you want.

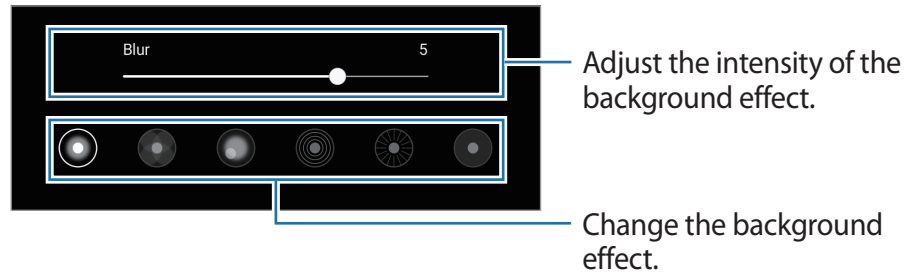

3 Tap **Apply** to save the photo.

## Super Slow-mo mode

Super slow motion is a feature that records a quickly passing moment slowly so that you can appreciate it later. After the video is recorded, background music will be added automatically.



- Some super slow motion features may differ depending on the model.
- Use this feature in a place that has sufficient light. When recording a video indoors with insufficient or poor lighting, some of the following situations may occur:
  - The screen may appear dark due to the small amount of light.
  - The screen may flicker in certain lighting conditions, such as in places with fluorescent lighting.
  - Noise may occur.



1 On the shooting modes list, tap **MORE** → **SUPER SLOW-MO**.

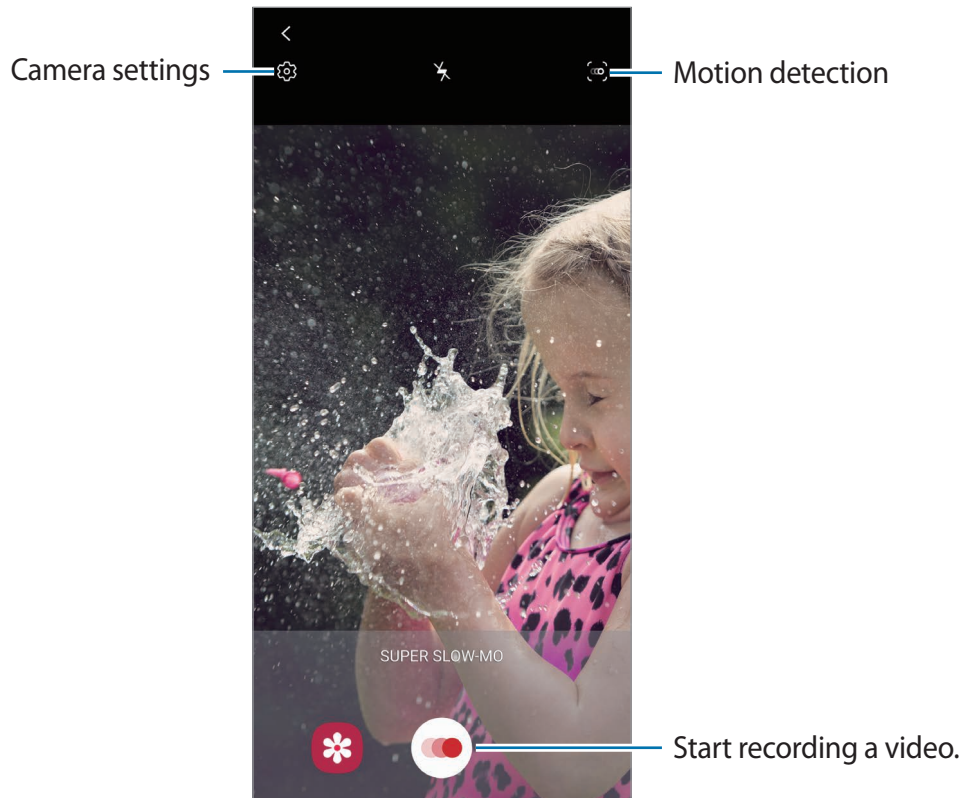

2 Tap .

The device will capture the moment in super slow motion and save it as a video.

3 On the preview screen, tap the preview thumbnail.

4 Tap **Play super slow-mo video**.

Random background music will automatically accompany the video during playback.

To edit the super slow motion section, drag the section editing bar to the left or right.

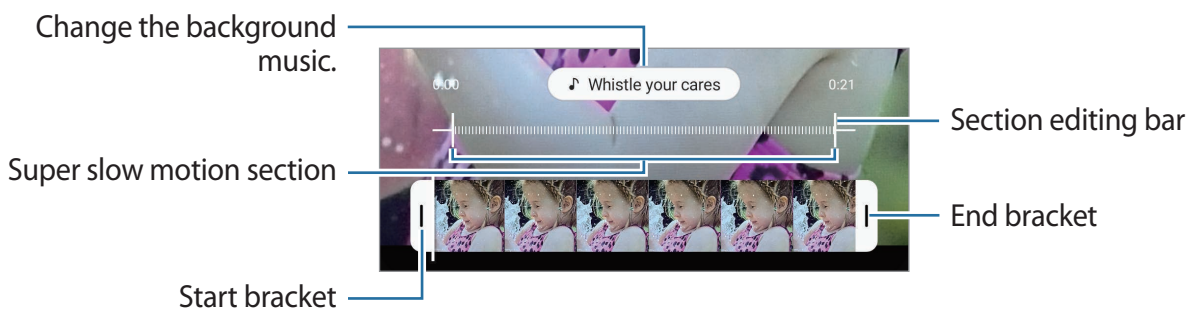

## Recording super slow motion videos automatically

To capture the moment in super slow motion when motion is detected in the motion detection area, tap  to activate it. The motion detection feature will be activated and the motion detection area will appear on the preview screen.

Tap  to start recording. When motion is detected, the device will begin recording in super slow motion and save it as a video.



Super slow motion recording may start at an unwanted moment if there are conditions such as the following:

- When the device shakes.
- When another object is moving near the subject in the motion detection area.
- When recording under flickering light, such as in places with fluorescent lighting.

## Slow motion mode

Record a video for viewing it in slow motion. You can specify sections of your videos to be played in slow motion.

1 On the shooting modes list, tap **MORE** → **SLOW MOTION**.

2 Tap  to start recording.

3 When you are finished recording, tap  to stop.

4 On the preview screen, tap the preview thumbnail.

5 Tap **Play slow motion video**.

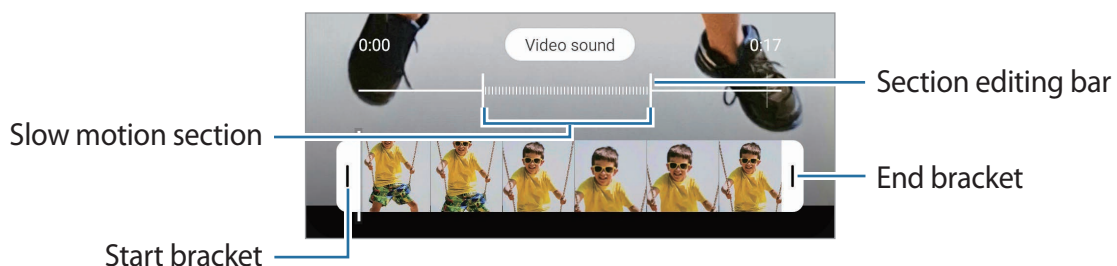

The fastest section of the video will be set as a slow motion section and the video will start playing. Up to two slow motion sections will be created based on the video.

To edit the slow motion section, drag the section editing bar to the left or right.



## Hyperlapse mode

Record scenes, such as passing people or cars, and view them as fast-motion videos.

- 1 On the shooting modes list, tap **MORE** → **HYPERLAPSE**.
- 2 Tap  and select a frame rate option.  
If you set the frame rate to **Auto**, the device will automatically adjust the frame rate according to the changing rate of the scene.
- 3 Tap  to start recording.
- 4 Tap  to finish recording.
- 5 On the preview screen, tap the preview thumbnail and tap **Play hyperlapse** to view the video.

## Customising camera settings

On the preview screen, tap . Some options may not be available depending on the shooting mode.

### Intelligent features

- **Scene optimiser:** Set the device to adjust the colour settings and apply the optimised effect automatically depending on the subject or scene.
- **Shot suggestions:** Set the device to suggest the ideal composition for the photo by recognising the position and angle of your subject.
- **Smart selfie angle:** Set the device to automatically switch to a wide-angle selfie when there are more than two people in the frame.
- **Scan QR codes:** Enable or disable the QR code reader.

## Pictures

- **Swipe Shutter button to edge to:** Select an action to perform when you swipe downwards on the camera button and hold it.
- **Save options:** Select how you want to save photos.

Tap the **Save RAW copies** switch to set the device to save photos as uncompressed RAW files (DNG file format) in pro mode. RAW files retain all of a photo's data for the best image quality, but they will take up more memory.



When using the **Save RAW copies** feature, each photo is saved in two formats, DNG and JPG.

## Videos

- **Rear video size:** Select a resolution for videos you want to take with the rear camera. Using a higher resolution will result in higher quality videos, but they will take up more memory.
- **Front video size:** Select a resolution for videos you want to take with the front camera. Using a higher resolution will result in higher quality videos, but they will take up more memory.
- **Advanced recording options:** Set the device to use an advanced recording option. If you activate the **High efficiency video** feature, you can record videos in the High Efficiency Video Codec (HEVC) format. Your HEVC videos will be saved as compressed files to conserve the device's memory.

If you activate the **HDR10+ video** feature, you can record videos in which each scene's contrast and colour are optimised.



- You cannot play the HEVC videos on other devices or share them online.
  - Super slow motion and slow motion videos cannot be recorded in the HEVC format.
  - To play the HDR10+ video properly, the device must support HDR10+.
- **Video stabilisation:** Activate anti-shake to reduce or eliminate blurry image resulting from camera shake while recording a video.

## Useful features

- **Auto HDR:** Take photos with rich colours and reproduce details even in bright and dark areas.
- **Selfie tone:** Set a tone to apply when you take selfies.
- **Tracking auto-focus:** Set the device to track and automatically focus on a selected subject. When you select a subject on the preview screen, the device will focus on the subject even if the subject is moving or you change the camera's position.



Tracking a subject may fail in the following conditions:

- The subject is too big or too small.
  - The subject moves excessively.
  - The subject is backlit or you are shooting in a dark place.
  - Colours or patterns on the subject and the background are the same.
  - The subject includes horizontal patterns, such as blinds.
  - The camera shakes excessively.
  - The video resolution is high.
  - When zooming in or out using the optical zoom.
- **Pictures as previewed:** Set the device to save photos as they appear on the preview screen when taken with the front camera without flipping them.
  - **Grid lines:** Display viewfinder guides to help composition when selecting subjects.
  - **Location tags:** Attach a GPS location tag to the photo.
    - GPS signal strength may decrease in locations where the signal is obstructed, such as between buildings or in low-lying areas, or in poor weather conditions.
    - Your location may appear on your photos when you upload them to the Internet. To avoid this, deactivate the location tag setting.
  - **Shooting methods:** Select additional shooting methods for taking a photo or recording a video.
  - **Storage location:** Select the memory location for storage. This feature will appear when you insert a memory card.
  - **Reset settings:** Reset the camera settings.
  - **Contact us:** Ask questions or view frequently asked questions.
  - **About Camera:** View the Camera app version and legal information.

# Gallery

## Introduction

View images and videos stored in your device. You can also manage images and videos by album or create stories.

## Using Gallery

Launch the **Gallery** app.

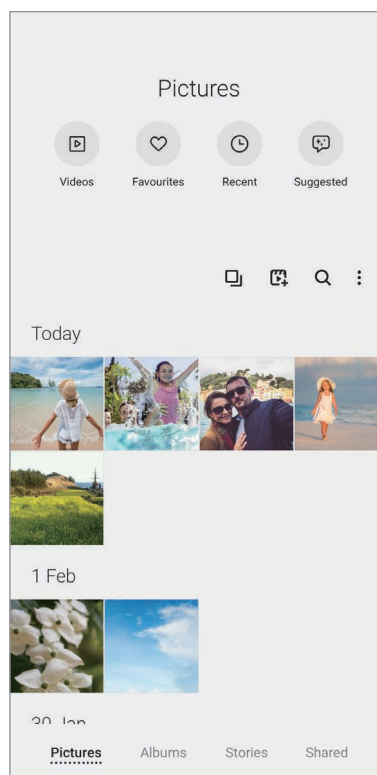

- **Videos:** View the videos saved in your device.
- **Favourites:** View your favourite photos and videos.
- **Recent:** View recent photos and videos.
- **Suggested:** View recommended content.

## Grouping similar images

Launch the **Gallery** app and tap  to group similar images and display only the best shots as a preview of the images. When you tap the image preview, you can view all the images in the group.



The icon appears only when there are similar images.

## Creating movies

Create a movie by selecting images or videos. Launch the **Gallery** app, tap , tick the files you want to use, and then tap **Create movie**. When you select **Highlight reel**, the device will automatically combine the highlights from the images or videos and create a movie.

## Searching for images

Launch the **Gallery** app and tap  to view images sorted by category, such as types or locations.

To search for images by entering keywords, tap the search field.

## Viewing images

1 Launch the **Gallery** app and tap **Pictures**.

2 Select an image.

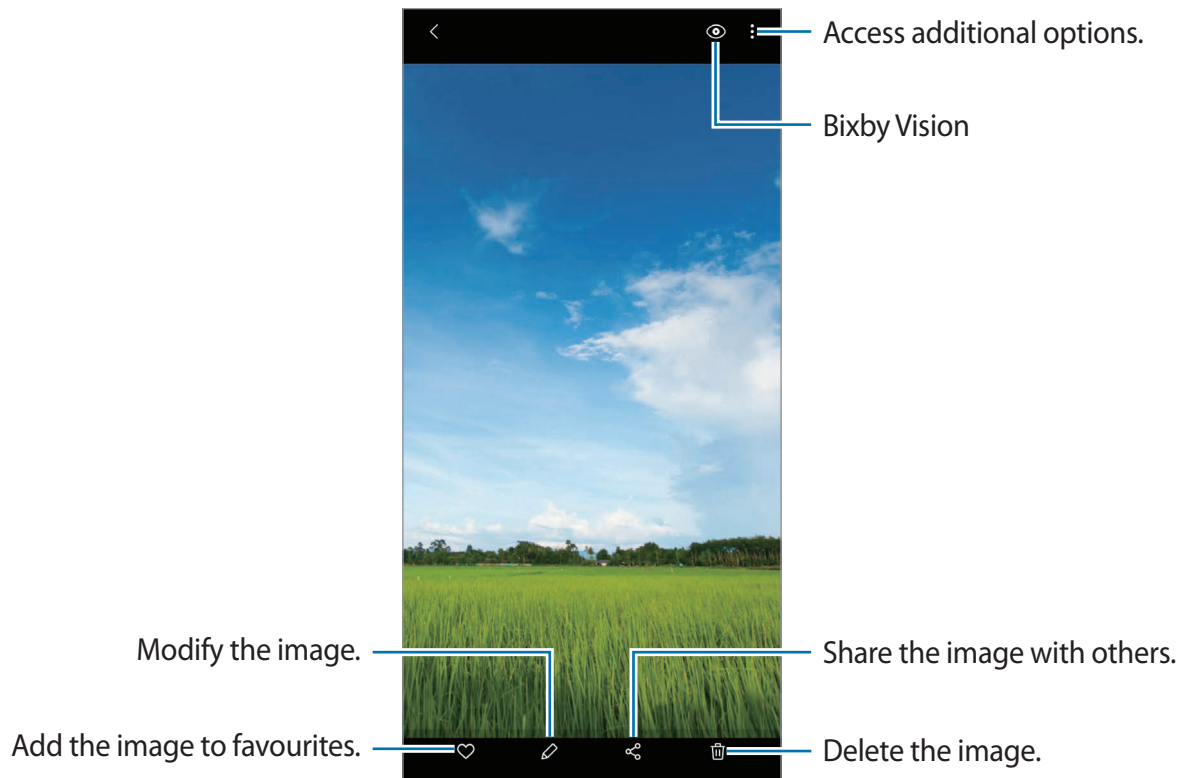



## Cropping images by enlarging an area

- 1 Launch the **Gallery** app and tap **Pictures**.
- 2 Select an image.
- 3 Double-tap or spread two fingers apart on the area you want to save and tap .  
The cropped area will be saved as a file.

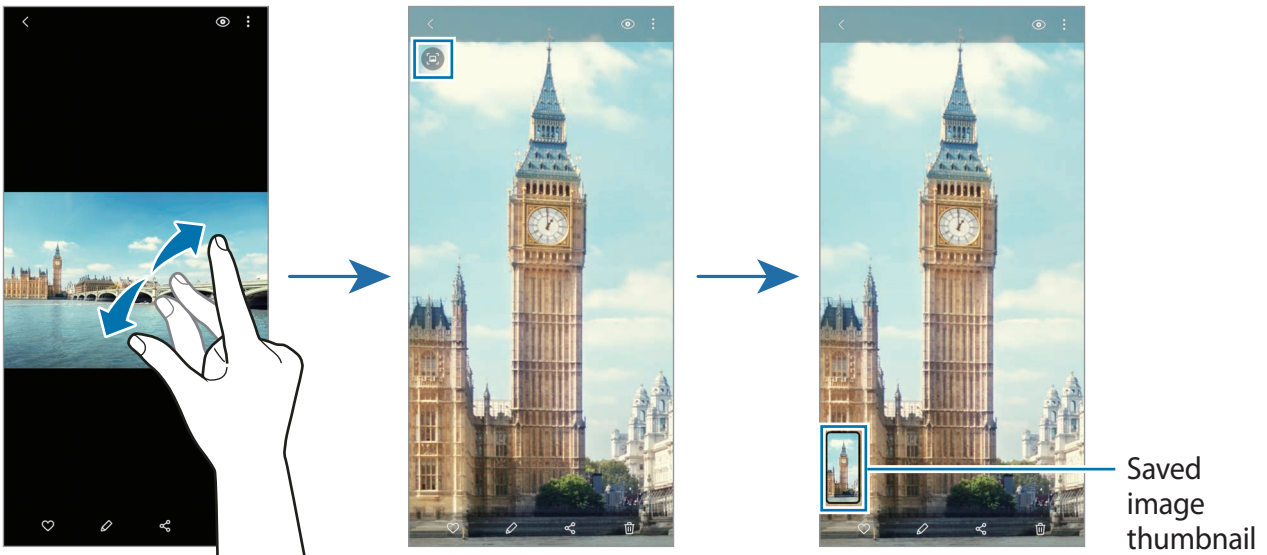

## Viewing videos

- 1 Launch the **Gallery** app and tap **Pictures**.
- 2 Select a video to play.
- 3 Tap **Play video** to play the video.

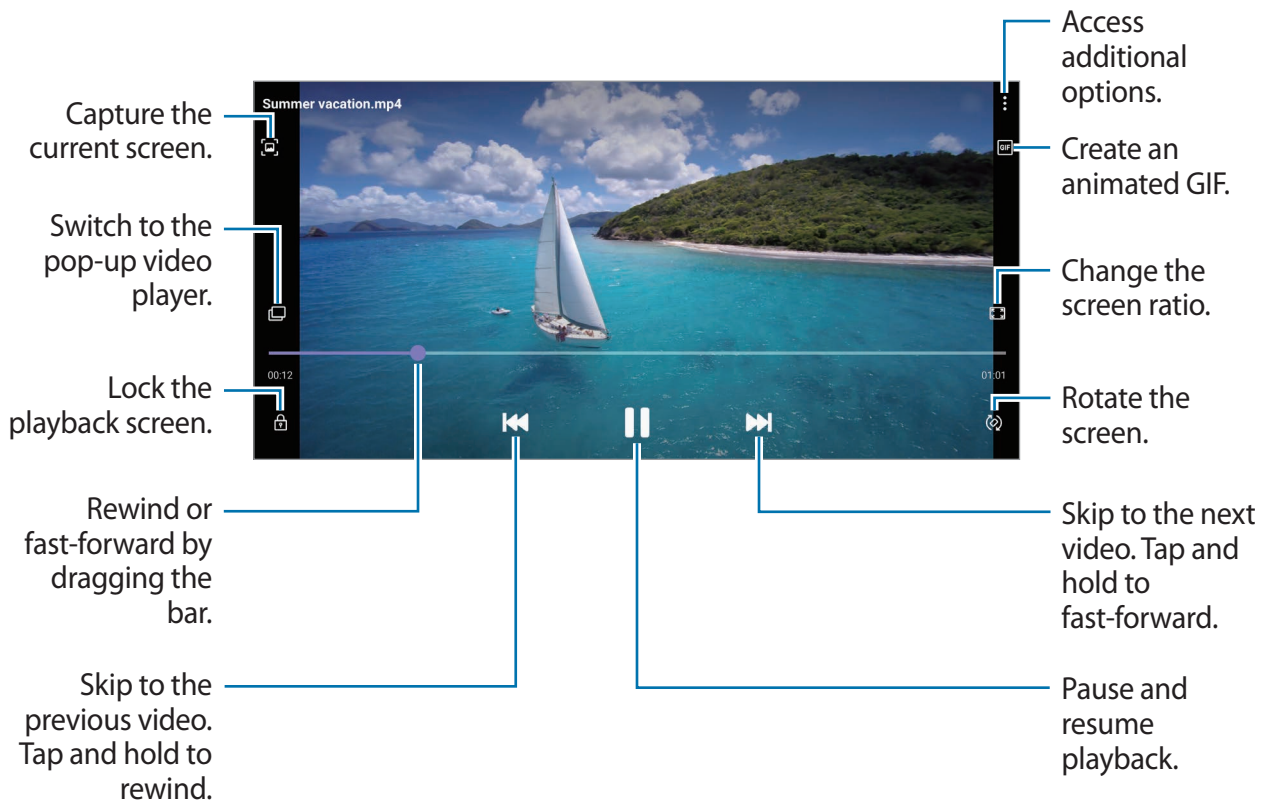

Drag your finger up or down on the left side of the playback screen to adjust the brightness, or drag your finger up or down on the right side of the playback screen to adjust the volume.

To rewind or fast-forward, swipe to the left or right on the playback screen.

## Using the Video enhancer feature

Enhance the image quality of your videos to enjoy brighter and more vivid colours. Launch the **Settings** app, tap **Advanced features**, and then tap the **Video enhancer** switch to activate it.



- This feature is only available in some apps.
- Using this feature will increase battery consumption.

## Viewing albums

You can view your images and videos sorted by folders or albums.

Launch the **Gallery** app, tap **Albums**, and then select an album.

## Creating albums

You can add albums and sort files.

- 1 Launch the **Gallery** app and tap **Albums**.
- 2 Tap  → **Create album**.
- 3 Enter a title for the album and tap **Create**.

## Moving photos and videos to albums

- 1 Launch the **Gallery** app and tap **Albums**.
- 2 Select an album and tap **Add items**.
- 3 Tap **Pictures**, or tap **Albums** and select an album with the images or videos you want.
- 4 Tick files and tap **Done**.
- 5 Tap **Move**.  
The files will be deleted from the original folder and moved to the album. To copy the files, tap **Copy**.

## Deleting albums

- 1 Launch the **Gallery** app and tap **Albums**.
- 2 Tap and hold an album to delete, and tap **Delete**.

## Creating album groups

You can add groups and sort albums.



- 1 Launch the **Gallery** app and tap **Albums**.
- 2 Tap  → **Create group**.
- 3 Enter a title for the group and tap **Create**.
- 4 Select the group, tap **Add albums**, tick albums, and then tap **Add**.  
The albums will be moved to the group.

## Viewing stories

When you capture or save images and videos, the device will read their date and location tags, sort the images and videos, and then create stories. To create stories automatically, you must capture or save multiple images and videos.

Launch the **Gallery** app, tap **Stories**, and then select a story.

## Editing stories

- To add images or videos to a story, select a story and tap **Story album** →  → **Add**.
- To remove images or videos from a story, select a story, tap **Story album** →  → **Edit**, tick images or videos to remove, and then tap **Remove from story**.

## Deleting stories

- 1 Launch the **Gallery** app and tap **Stories**.
- 2 Tap and hold a story to delete, and tap **Delete**.

## Syncing images and videos

When you sync your **Gallery** app with the cloud, photos and videos you take will also be saved in the cloud. You can view images and videos saved in the cloud in your **Gallery** app and from other devices.

Launch the **Gallery** app, tap  → **Settings** → **Cloud sync**, and then follow the on-screen instructions to complete the sync. The **Gallery** app and the cloud will be synced.



When you connect your Samsung account and Microsoft account, you can set the cloud storage as Microsoft OneDrive.

## Deleting images or videos

1 Launch the **Gallery** app.

2 Select an image or a video to delete.

To delete multiple files, tap and hold a file to delete on the list and tick more files to delete.

3 Tap  or **Delete**.

## Using the recycle bin feature

You can keep the deleted images and videos in the recycle bin. The files will be deleted after a certain period.

Launch the **Gallery** app, tap  → **Settings**, and then tap the **Recycle bin** switch to activate it.

To view files in the recycle bin, launch the **Gallery** app and tap  → **Recycle bin**.

# AR Zone

## Introduction

AR Zone provides you AR related features, such as AR Emoji and AR Doodle. Choose a feature and capture fun photos or videos.

## Launching AR Zone

Use the following methods to launch AR Zone:

- Launch the **AR Zone** app.
- Launch the **Camera** app and tap **MORE** → **AR ZONE**.



Available features may vary depending on the region, service provider, or model.

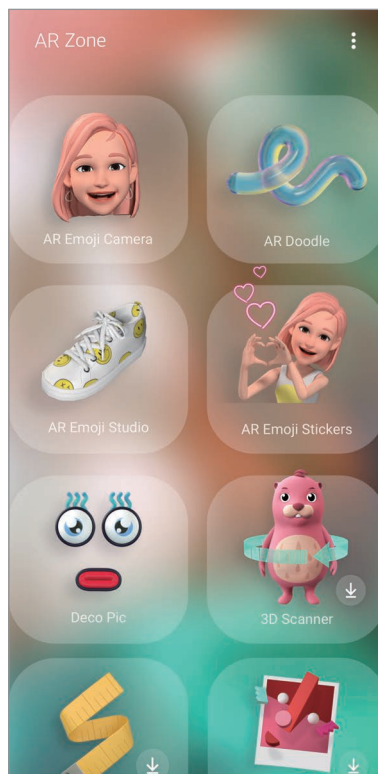

- **AR Emoji Camera:** Create an emoji that looks just like you, and take photos and record videos using your emojis or character emojis.
- **AR Doodle:** Record fun videos with virtual handwriting or drawings on faces or anywhere else.

- **AR Emoji Studio:** Edit or decorate your emoji and create clothes with custom patterns and colours for your emoji.
- **AR Emoji Stickers:** Create your own stickers with your emoji's expressions and actions.
- **Deco Pic:** Capture photos or videos with various stickers.
- **3D Scanner** (Galaxy S20 Ultra 5G, S20 Ultra, S20+ 5G, S20+): Create 3D images of objects you took photos of and share them.
- **Quick Measure:** Measure the subject's size, a person's height, or the distance between the device and the object quickly and easily.
- **Picture Link:** Create your AR markers by adding information, such as links or music, to images you want. When the camera recognises the markers, you can view the information in them.

## Creating AR Emoji

Create an emoji that looks just like you, and take photos and record videos using your emojis or character emojis.

You can customise your emoji's features, such as the face shape or hairstyle, and decorate your emoji with various accessories. You can also express yourself in fun ways using your emoji stickers during a conversation.





Your emoji



Character emoji

## Creating an emoji

Make an emoji that looks like you. Emoji stickers with various expressions will be automatically generated.

- 1 Launch the **AR Zone** app and tap **AR Emoji Camera** → .
- 2 Align your face on the screen and tap  to take a photo.
- 3 Select your emoji type and tap **Next**.
- 4 Decorate your emoji and tap **Next**.
- 5 Tap **All done**.

Your emoji and its emoji stickers are now created. Refer to [AR Emoji Stickers](#) for more information about emoji stickers.

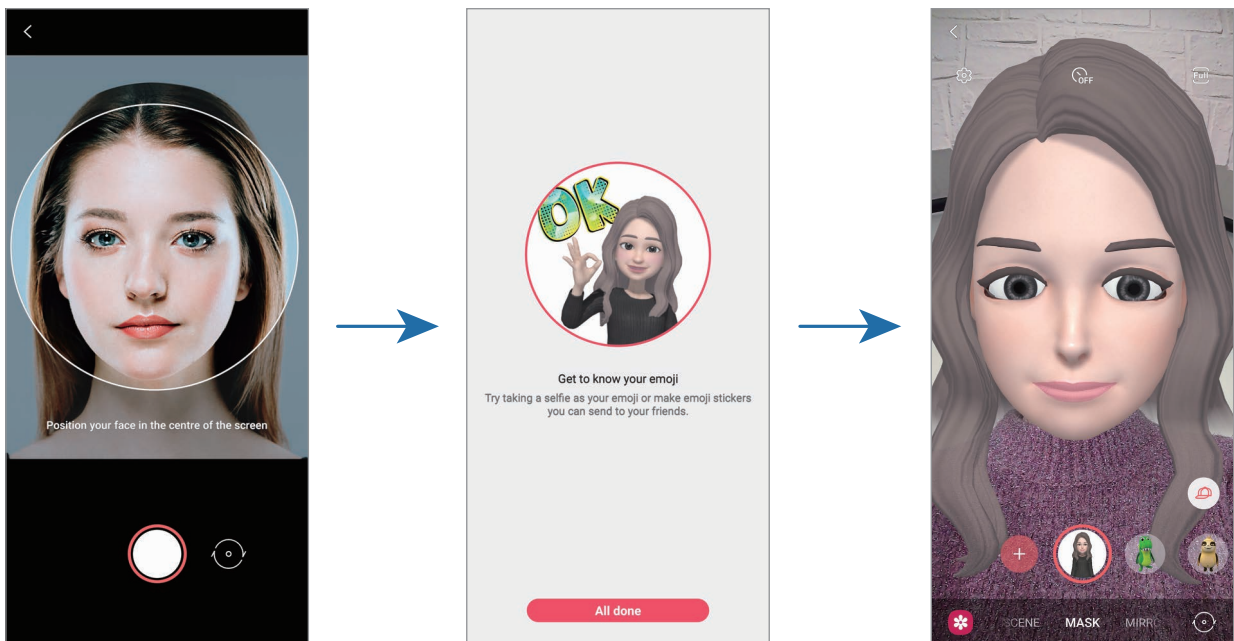

You can use the **AR Emoji Camera** feature in both the front and rear cameras. To switch between cameras, swipe upwards or downwards on the preview screen.

## Deleting an emoji

Launch the **AR Zone** app and tap **AR Emoji Camera**. Tap  → **Manage emojis**, tick the emoji you want to delete, and then tap **Delete**. The emoji and its emoji stickers will be deleted.



## AR Emoji Camera

### Capturing photos or videos with your emojis

Create fun photos or videos with your emoji using various shooting modes.



SCENE



MASK



MIRROR



PLAY

- 1 Launch the **AR Zone** app and tap **AR Emoji Camera**.
- 2 Select the emoji you want to use.

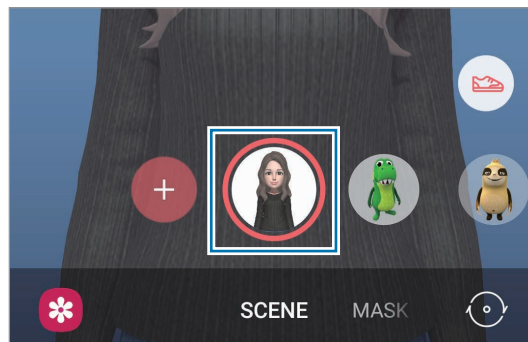

- 3 Select the mode you want to use.
  - **SCENE:** Your emoji mimics your expressions.
  - **MASK:** Your emoji's face appears over your face so it looks like you are wearing a mask.
  - **MIRROR:** Your emoji mimics your body movements.
  - **PLAY:** Your emoji moves on a real background.

- 4 Tap  to take a photo or tap and hold  to record a video.

You can view and share the photos and videos that you have captured in **Gallery**.

## Capturing photos or videos with character emojis

Character emojis mimic your expressions.

- 1 Launch the **AR Zone** app and tap **AR Emoji Camera**.

- 2 Select a character emoji you want to use.

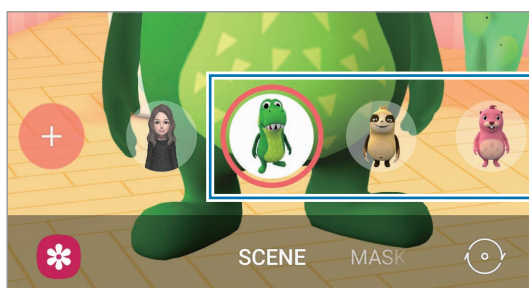

- 3 Tap  to take a photo or tap and hold  to record a video.

You can view and share the photos and videos that you have captured in **Gallery**.

## AR Emoji Stickers

Create your own stickers with your emoji's expressions and actions. You can use your emoji stickers when sending messages or on a social network.

## Creating your own stickers

- 1 Launch the **AR Zone** app and tap **AR Emoji Stickers**.
- 2 Tap **Make custom stickers** at the bottom of the screen.
- 3 Edit stickers how you want.
  - 🗨️ : Add stickers.
  - 🖼️ : Select the sticker's background.
  - 😊 : Select an expression.
  - 🚶 : Select an action.
  - T : Enter text.
  - 🎨 : Write or draw on stickers.
- 4 Tap **Save**.

You can view the stickers you have created by tapping **Custom**.

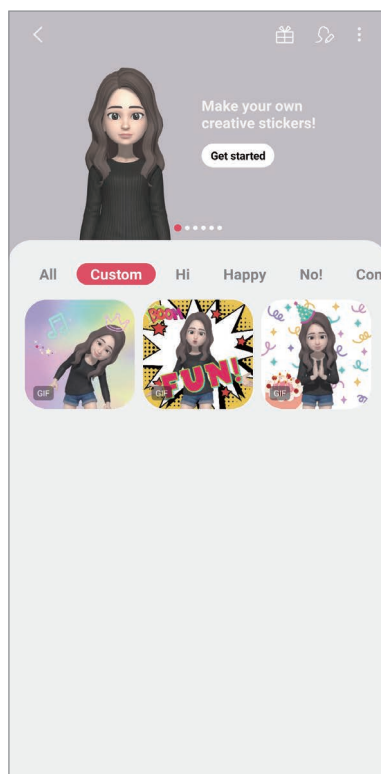



## Using your emoji stickers in chats

You can use your emoji stickers during a conversation via messages or on a social network. The following actions are an example of using your emoji stickers in the **Messages** app.

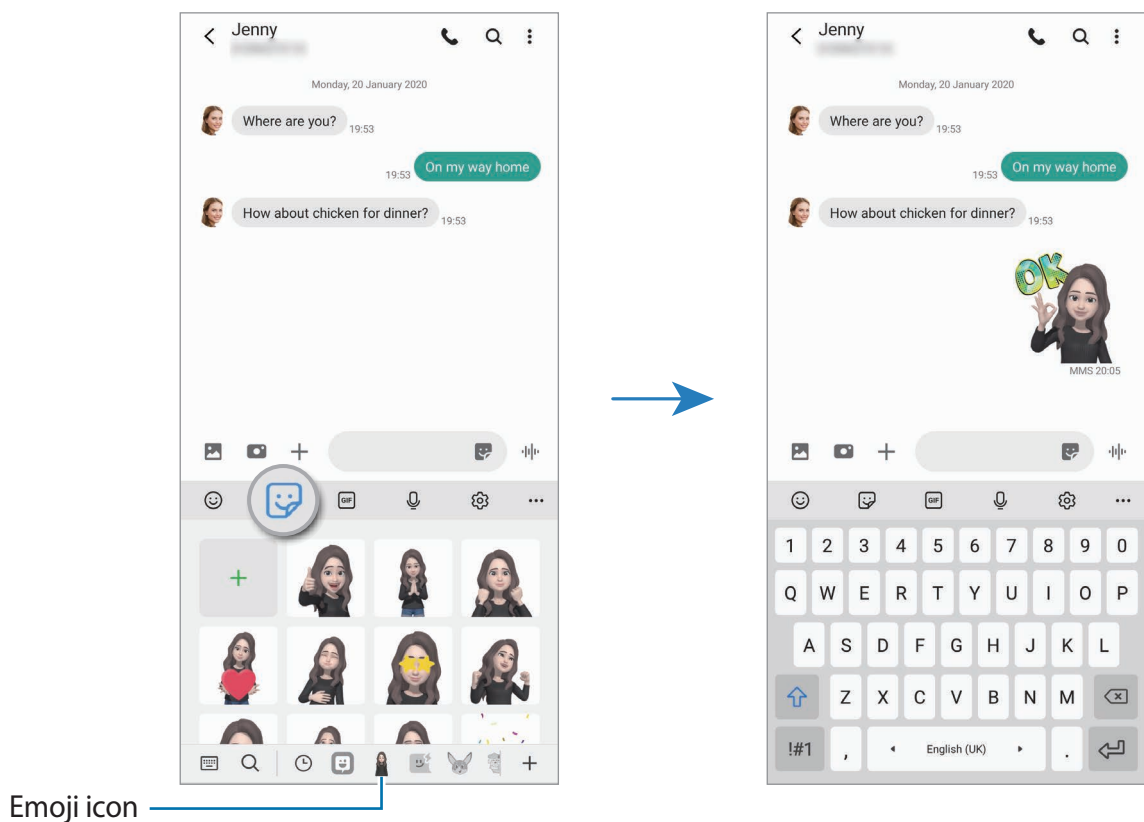
- 1 While composing a message in the **Messages** app, tap  on the Samsung keyboard.
- 2 Tap the emoji icon.
- 3 Select one of your emoji stickers.  
The emoji sticker will be inserted.



## Deleting emoji stickers

On the Samsung keyboard, tap , tap  at the bottom of the keyboard, and then tap **Manage sticker sets**. Select the emoji stickers you want to delete and tap **Delete**.

## AR Emoji Studio

Edit or decorate your emoji in the AR Emoji Studio. You can also create clothes with custom patterns and colours for your emoji.



Available options may vary depending on the region or service provider.

Launch the **AR Zone** app and tap **AR Emoji Studio**. AR Emoji Studio will appear.

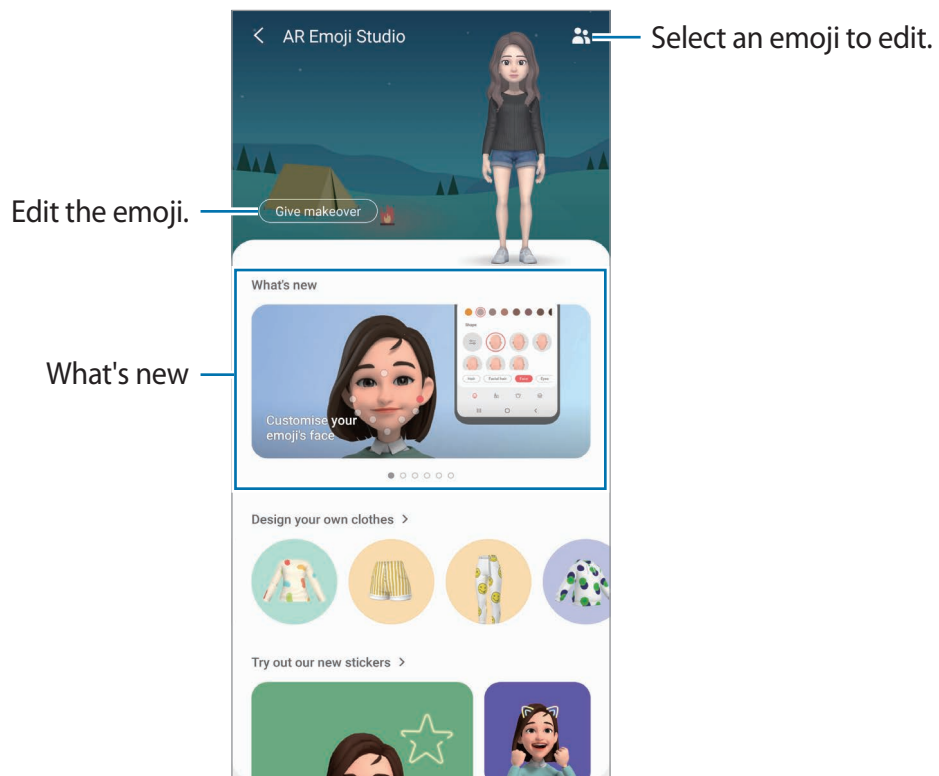

## Designing your emoji's clothes

- 1 Launch the **AR Zone** app and tap **AR Emoji Studio**.
- 2 Tap **Design your own clothes**.
- 3 Select a clothing type and select an image or pattern to use.  
If you tap **Gallery**, you can design clothes using images saved in your device.
- 4 Design your outfit and tap **Save**.  
When a pop-up window appears, tap **Try it on**. Then, you can see your emoji in the outfit you designed.

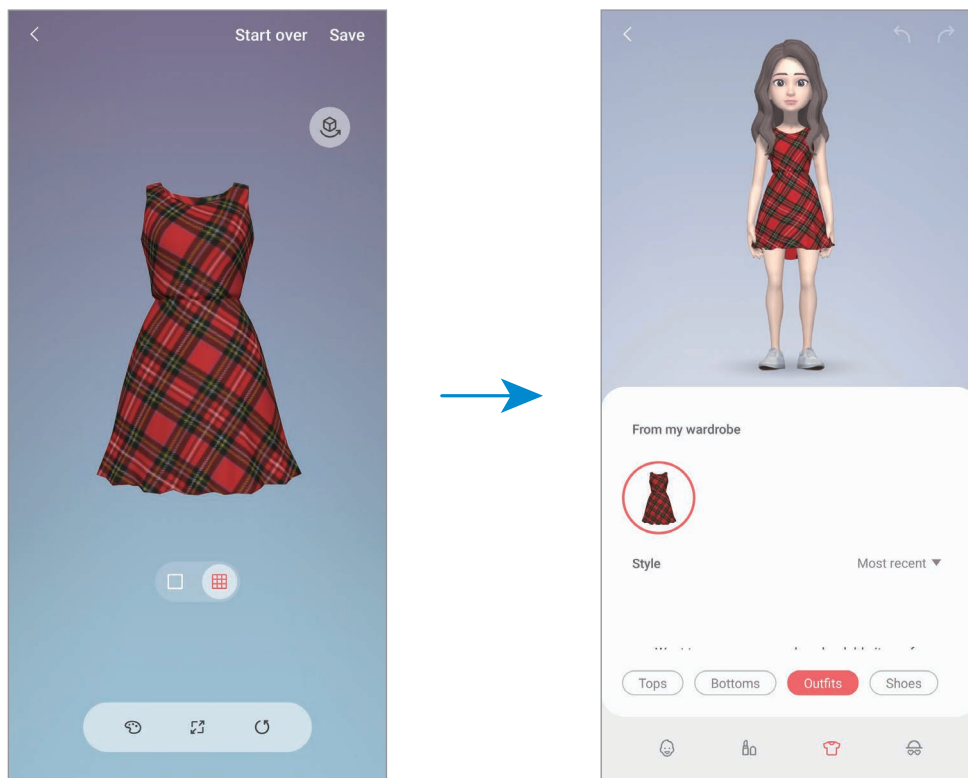

## AR Doodle

Record fun videos with virtual handwriting or drawings on people or pets' (cat and dogs) faces or anywhere else. When the camera recognises a face or space, the doodles on the face will follow the face as it moves, and the doodles in the space will be fixed in the same place even if the camera moves.

### 1 Launch the **AR Zone** app and tap **AR Doodle**.

When the camera recognises the subject, the recognition area will appear on the screen.

### 2 Write or draw in the recognition area.

- If you switch to the rear camera, you can also write or draw outside the recognition area.
- If you tap  and then begin to doodle, you can record yourself doodling.

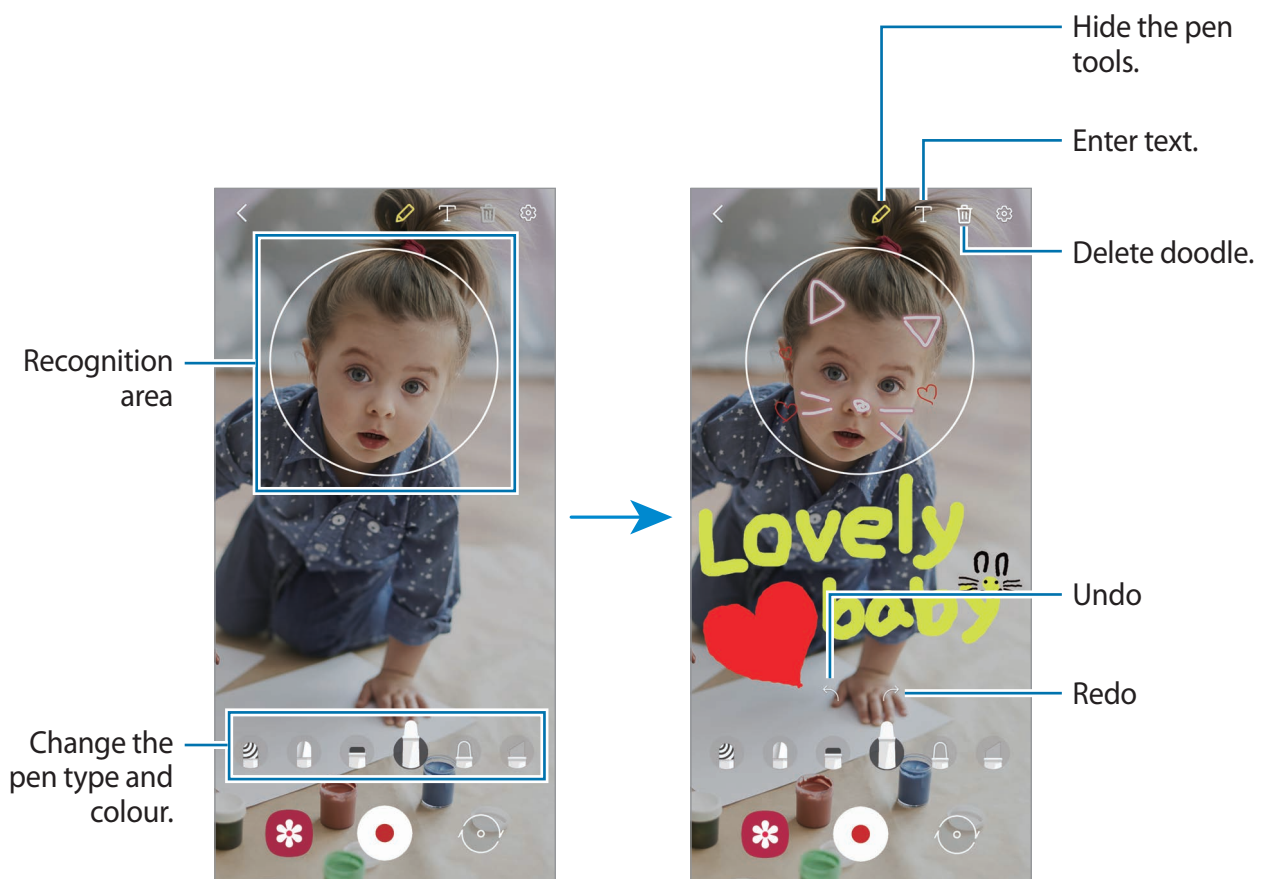

### 3 Tap to record a video.

### 4 Tap to stop recording the video.



You can view and share the video in **Gallery**.

## Deco Pic

Capture photos or videos with various stickers.

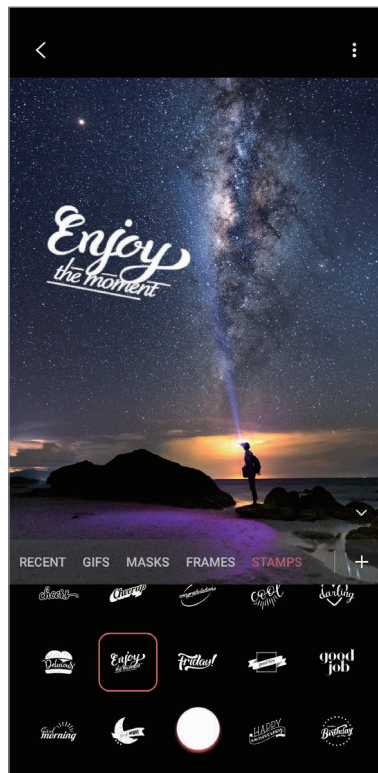
- 1 Launch the **AR Zone** app and tap **Deco Pic**.
- 2 Select a sticker you want to use.



- 3 Tap  to take a photo or tap and hold  to record a video.  
You can view and share the photos and videos that you have captured in **Gallery**.



## Quick Measure

Measure the subject's size, a person's height, or the distance between the device and the object quickly and easily.

- 1 Launch the **AR Zone** app and tap **Quick Measure**.
- 2 Point the camera towards the subject to measure its size and distance.  
The measurement results will appear on the screen.



To use Quick measure, you must sign in to your Google account.

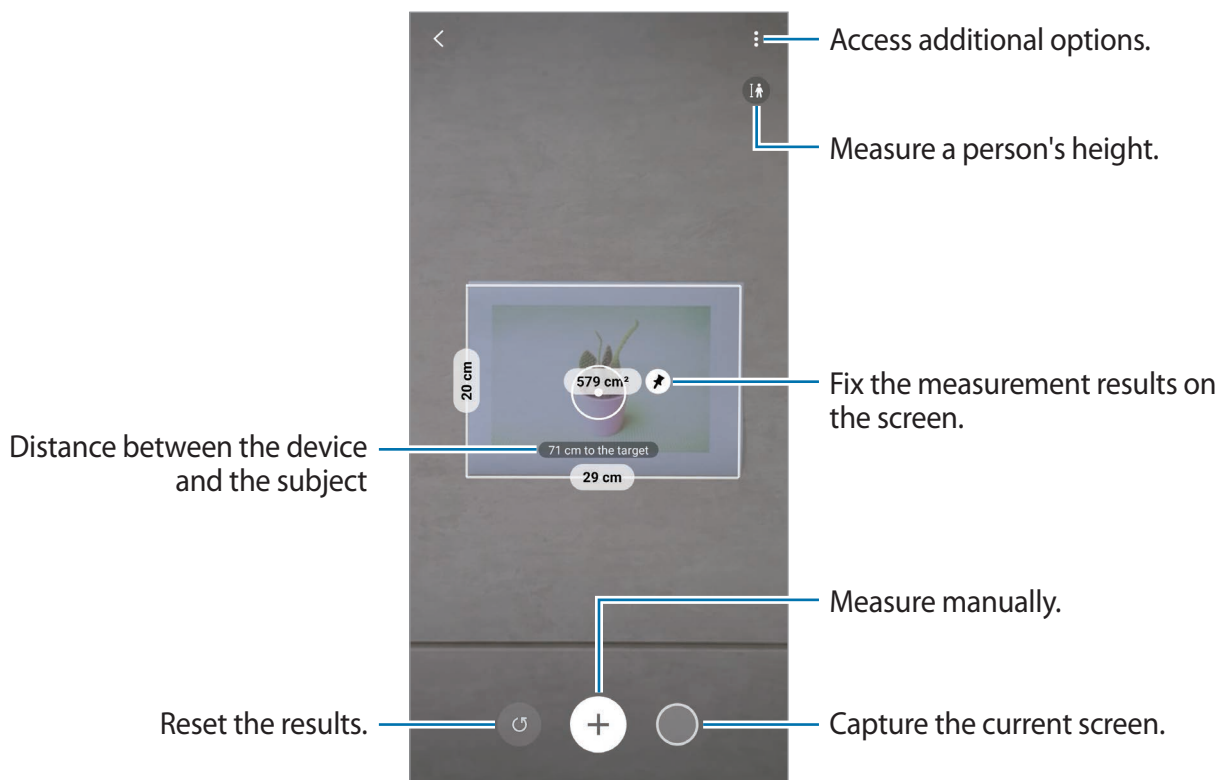

## Measuring manually

You can manually measure the size and distance of the subject.

- 1 Launch the **AR Zone** app and tap **Quick Measure**.
- 2 Point the circle in the centre of the screen at the starting point of the subject.

3 Tap .

The starting point will be fixed on the screen.

4 Move the device to start measuring.

Tap  to fix the measurement results on the screen.

## Always On Display

You can view information, such as the clock or calendar, or control music playback on the screen when it is turned off.

You can also check notifications for new messages or missed calls.

The Always On Display is set to appear only when you tap the screen. To change the settings to make it appear continuously or during a set time, launch the **Settings** app, tap **Lock screen** → **Always On Display**, and then select a mode you want.



The brightness of the Always On Display may change automatically depending on the lighting conditions.

### Opening notifications on the Always On Display

When you receive message, missed call, or app notifications, notification icons will appear on the Always On Display. Double-tap a notification icon to view its notification.

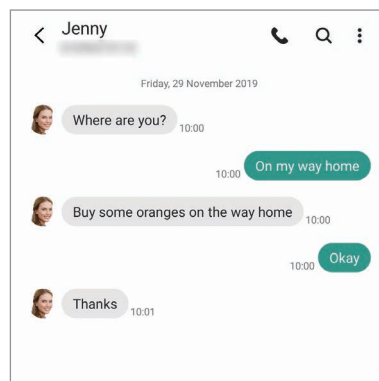

If the screen is locked, you must unlock it to view notifications.

## Deactivating the Always On Display feature

Open the notification panel, swipe downwards, and then tap  (Always On Display) to deactivate it. Alternatively, launch the **Settings** app, tap **Lock screen**, and then tap the **Always On Display** switch to deactivate it.

## Edge screen

### Introduction

You can quickly access your favourite apps and features from the Edge panels.

### Using the Edge panels



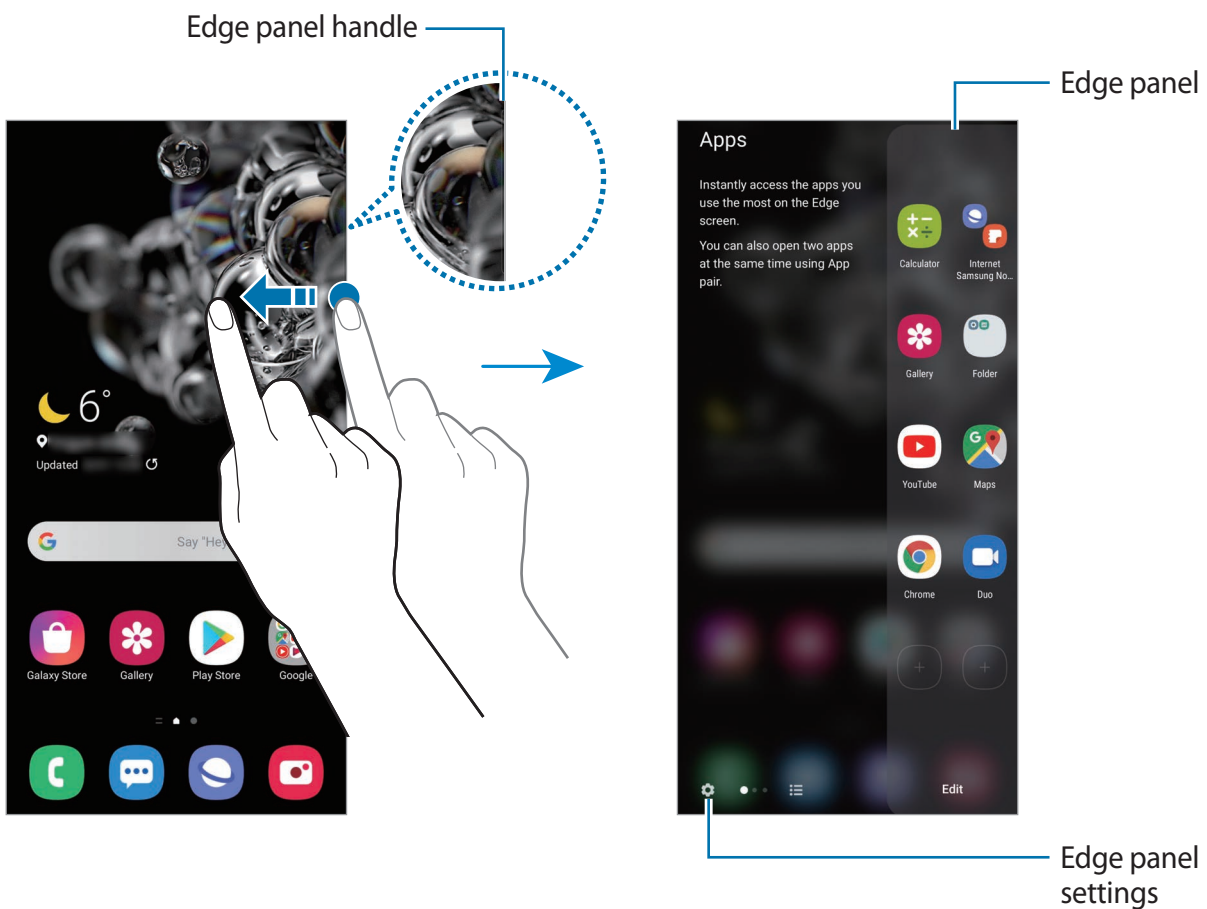

Drag the Edge panel handle towards the centre of the screen.

If the Edge panel handle is not visible, launch the **Settings** app, tap **Display** → **Edge screen**, and then tap the **Edge panels** switch to activate it.





## Editing the Edge panels

Select panels to display on the Edge screen or edit them.

- 1 Drag the Edge panel handle towards the centre of the screen.
- 2 Tap  to open the Edge panel settings screen.
- 3 Tick Edge panels to display.
  - To edit a panel, tap **Edit**.
  - To download additional panels, tap **Galaxy Store**.
  - To rearrange the panels, tap  → **Reorder** and drag   to another location.

## Setting the Edge panel handle

You can change the location, size, transparency, or vibration settings of the handle.



Drag the Edge panel handle towards the centre of the screen. Then, tap  →  → **Handle settings**.

## Apps edge

Quickly launch frequently used apps.

- 1 Drag the Edge panel handle towards the centre of the screen.
- 2 On the Apps edge panel, select an app to launch it.

## Editing the Apps edge panel

- To add an app, tap  on the panel and tap an app from the apps list.
- To create a folder on the panel, tap  on the panel, tap and hold an app from the apps list, and then drag it over another app on the Apps edge panel.
- To delete an app, tap and hold an app on the panel and drag it to **Remove** at the top of the panel.
- To change the order of apps, tap and hold an app and drag it to another location.



You can also edit the Apps edge panel by tapping **Edit**.

## Adding app pairs

Add two frequently used apps, such as a video player and a messenger app, to the Apps edge panel to launch them together in the split screen view with a single tap. For more information about the split screen view, refer to [Split screen view](#).

- 1 Drag the Edge panel handle towards the centre of the screen.
- 2 On the Apps edge panel, tap  → **Create App pair**.
- 3 Select two apps from the list.  
The first app will appear at the top and the second app will appear at the bottom when opened in the split screen view.
- 4 Tap **Done**.

## Edge lighting

You can set the device to light up the edges of the screen and display a pop-up window when you receive notifications, such as new messages.

When a pop-up window appears while using an app, drag the window downwards to quickly view the content and perform available actions.

## Managing notifications to display as the edge lighting

- 1 Launch the **Settings** app, tap **Display** → **Edge screen** → **Edge lighting**, and then tap the switch to activate it.
- 2 Tap **Choose apps** and tap the switches next to apps to receive notifications as the edge lighting.



Some notifications may not display as the edge lighting depending on notification types.

## Viewing notifications via the pop-up window

When you receive a notification with edge lighting, you can quickly view its content and perform available actions by opening the pop-up window. For example, if you receive a message while watching a video or playing a game, you can view the message and reply to it without switching the screen.

When you receive a notification with edge lighting while using an app, drag the notification downwards.

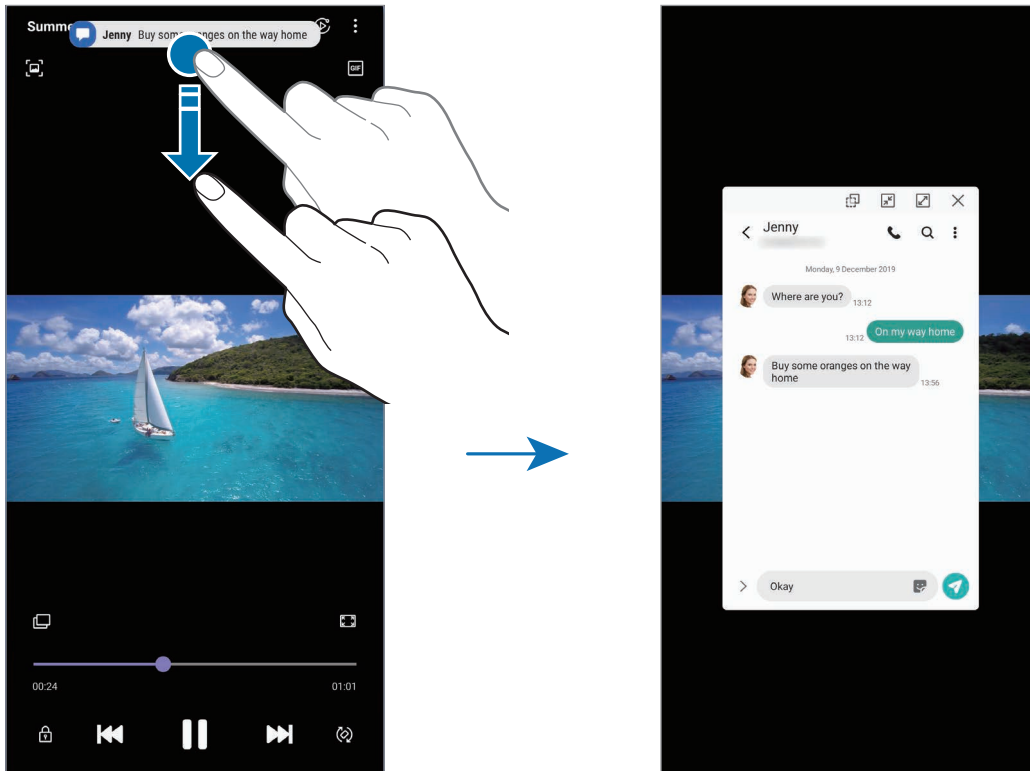

This feature is only available to apps that support the Multi window and edge lighting features. To view supported apps, launch the **Settings** app, tap **Display** → **Edge screen** → **Edge lighting** → **Choose apps**.

# Multi window

## Introduction

Multi window lets you run two apps at the same time in the split screen view. You can also run multiple apps at the same time in the pop-up view.



Some apps may not support this feature.

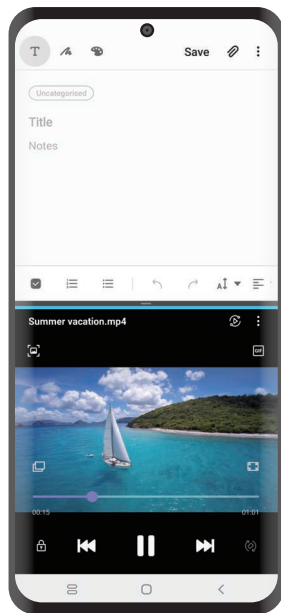

Split screen view

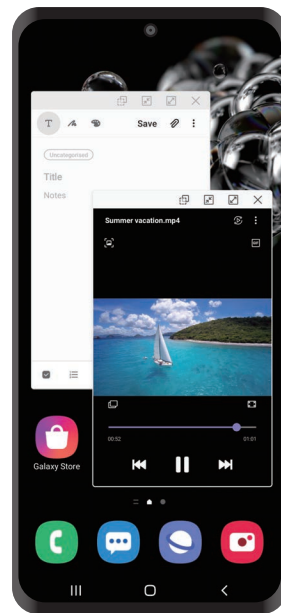

Pop-up view

## Split screen view

- 1 Tap the Recents button to open the list of recently used apps.
- 2 Swipe to the left or right, tap an app's icon, and then tap **Open in split screen view**.  
The selected app will launch in the upper window.
- 3 On the lower window, swipe left or right to select another app to launch.  
To launch apps not on the list of recently used apps, tap the Home button or Back button and select an app.

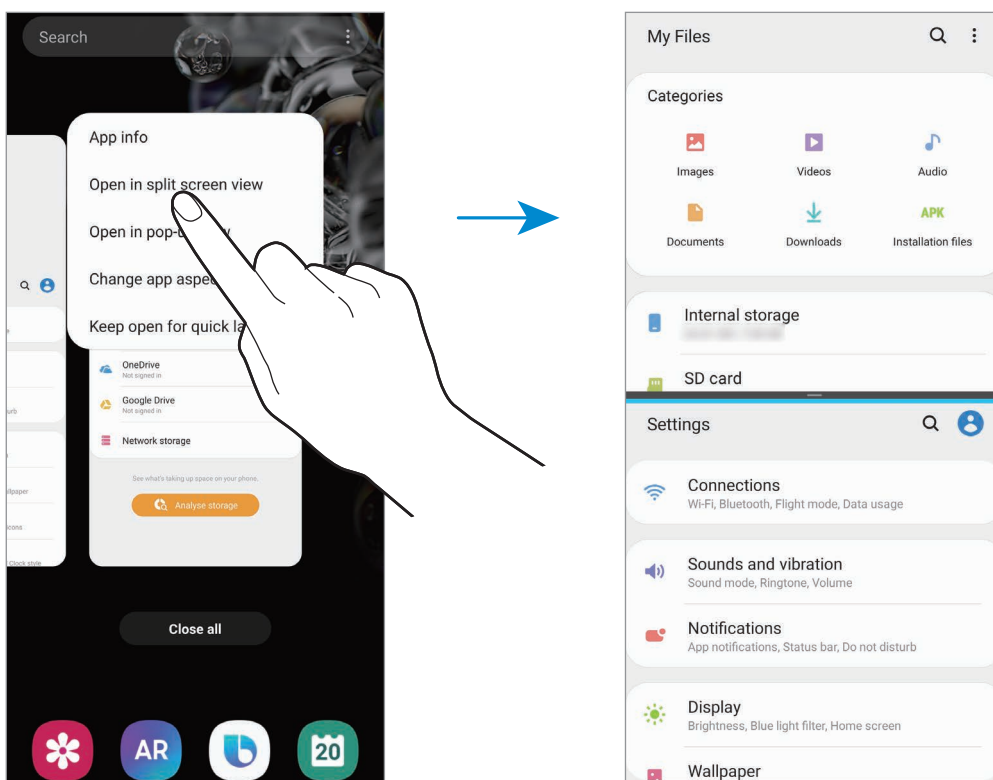

## Adjusting the window size

Drag the bar between the app windows up or down to adjust the size of the windows.  
When you drag the bar between the app windows to the top or bottom edge of the screen, the window will be maximised.



## Pop-up view

- 1 Tap the Recents button to open the list of recently used apps.
- 2 Swipe to the left or right, tap an app's icon, and then tap **Open in pop-up view**.  
The app screen will appear in the pop-up view.

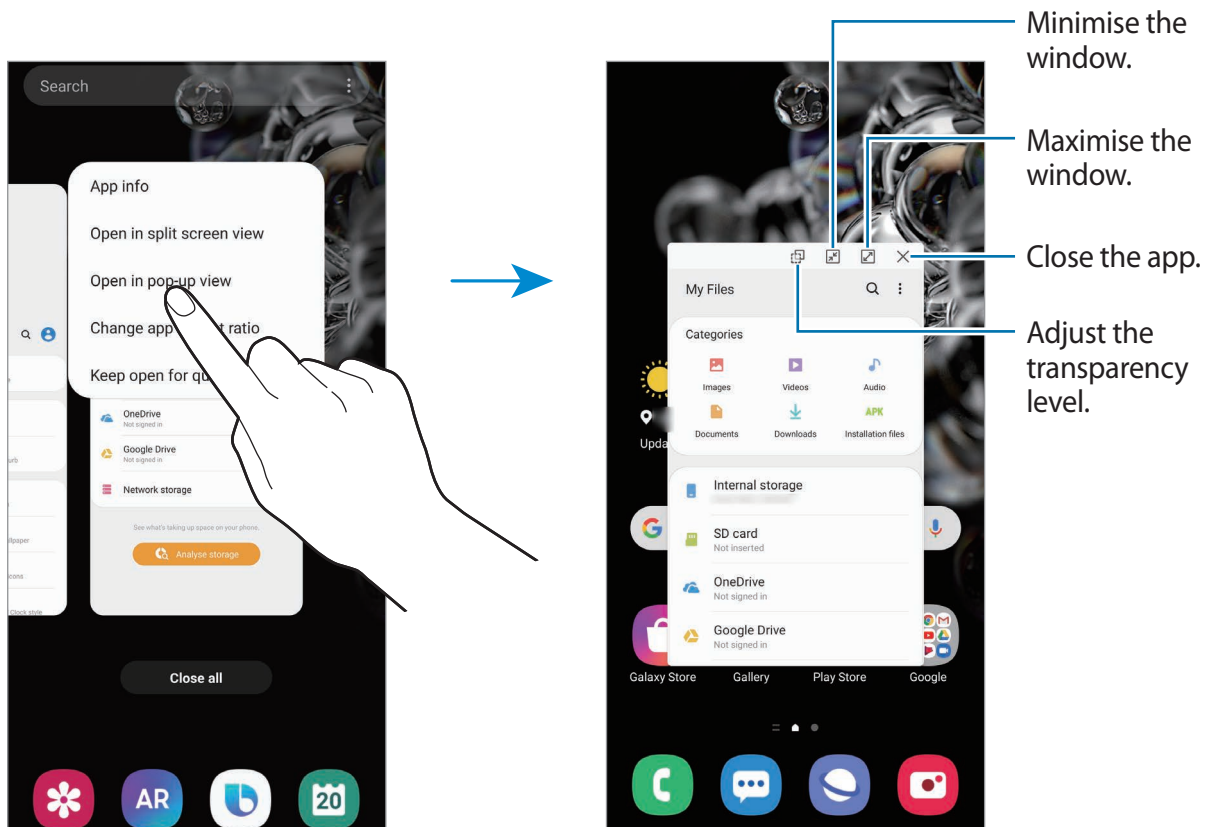

## Moving pop-up windows

To move a pop-up window, tap the window's toolbar and drag it to a new location.

# Samsung Daily

View the latest news and various content, such as videos and games.



- To use Samsung Daily, your device must be connected to a Wi-Fi or mobile network.
- To fully use this feature, you must sign in to your Samsung account.

1 On the Home screen, swipe to the right.

The Samsung Daily screen will appear.

When launching this feature for the first time or after performing a data reset, follow the on-screen instructions to complete the setup.

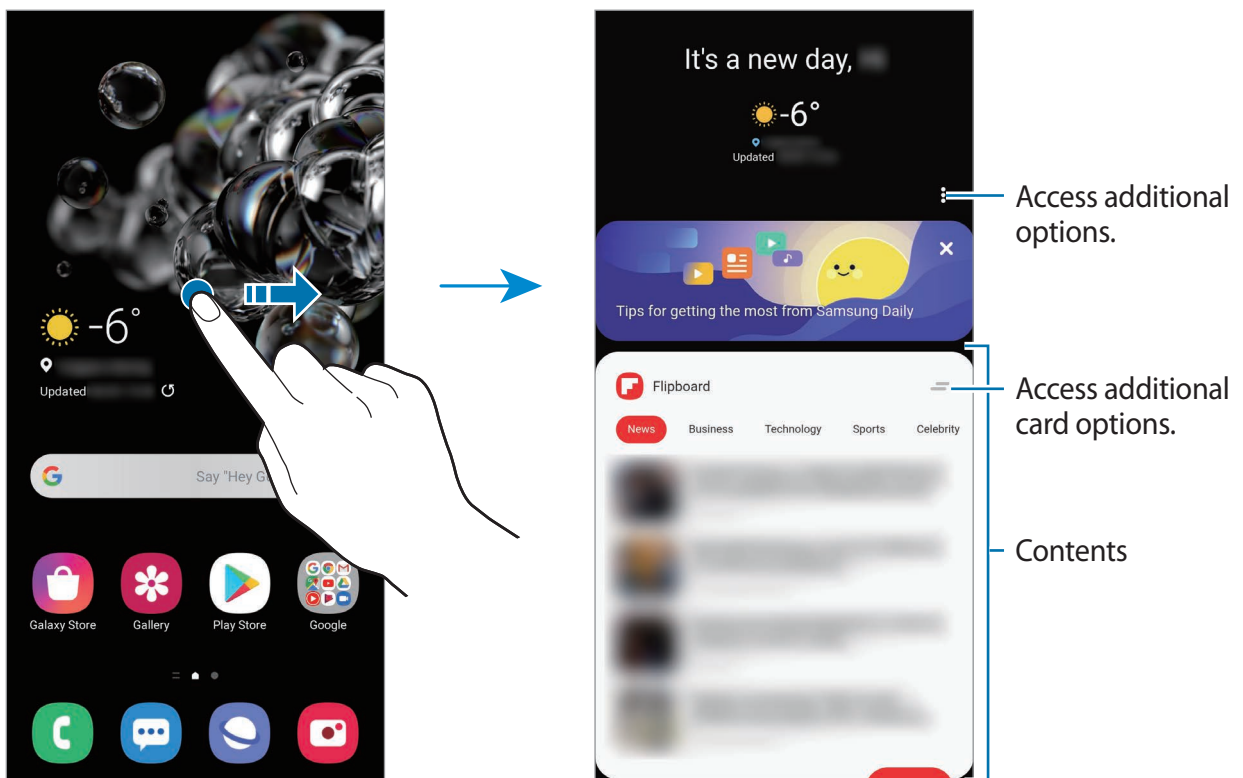

- To stop displaying a card on the list, tap at the top of the card and tap **Don't show again**.
- To add or delete content to be shown as cards, tap → **Cards** and tap the switches next to items to turn them on or off.
- To change the order of the cards, tap → **Cards** → **Reorder** and drag to another location.

2 Swipe upwards or downwards to view content.



The content of the cards update automatically at a specified interval. You can update cards whenever you want by swiping downwards on the screen.

3 To close Samsung Daily, swipe to the left on the screen or tap the Back button.

## Samsung Pay

### Introduction

Register frequently used cards to Samsung Pay, a mobile payment service, to make payments quickly and securely. Samsung Pay supports magnetic secure transmission (MST) as well as near field communication (NFC) to allow payment through standard credit card readers.

You can view more information, such as cards that support this feature at [www.samsung.com/samsung-pay](http://www.samsung.com/samsung-pay).





- To use this feature, you must sign in to your Samsung account and register your biometric data. Refer to [Samsung account](#) and [Fingerprint recognition](#) for more information.
- To make payments with Samsung Pay, the device may be required a connection to a Wi-Fi or mobile network depending on the region.
- This app's availability and supported features may vary depending on the region or service provider.
- The procedures for the initial setup and card registration may vary depending on the region or service provider.
- Magnetic secure transmission (MST) may not be supported depending on the region.

## Setting up Samsung Pay

When running this app for the first time or restart it after performing a data reset, follow the on-screen instructions to complete the initial setup.

- 1 Launch the **Samsung Pay** app.
- 2 Sign in to your Samsung account.
- 3 Read and agree to the terms and conditions.
- 4 Register your fingerprint to use when making payments.
- 5 Create a PIN to use when making payments.



This PIN will be used to verify various actions in Samsung Pay, such as making payments and unlocking the app.

## Registering cards

You can easily register cards by capturing their images with the camera.



You can check the cards that support this feature from the Samsung Pay website ([www.samsung.com/samsung-pay](http://www.samsung.com/samsung-pay)).

Launch the **Samsung Pay** app and follow the on-screen instructions to complete your card registration.

## Making payments

- 1 Tap and hold a card image at the bottom of the screen and drag it upwards. Alternatively, launch the **Samsung Pay** app. Then, on the cards list, swipe to the left or right and select a card to use.

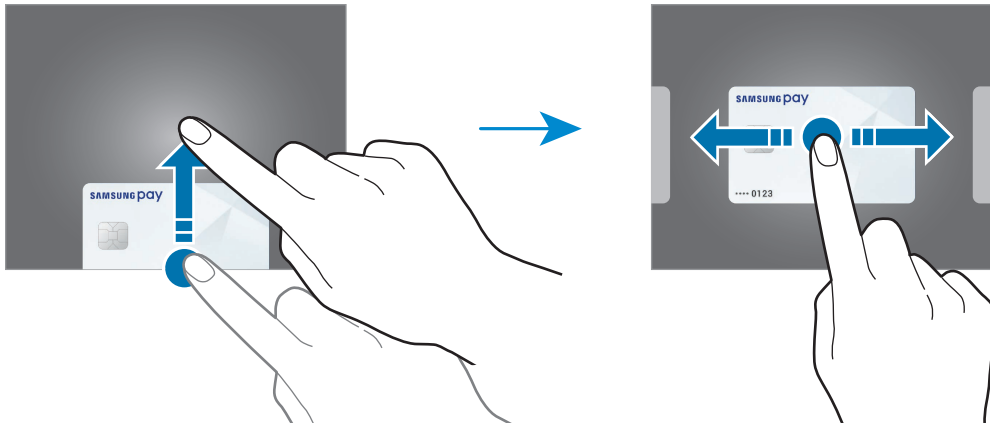

- 2 Scan your fingerprint.  
Alternatively, enter the payment PIN you set when setting up the Samsung Pay.
- 3 Touch the back of your device to the card reader.  
When the card reader recognises the card information, the payment will be processed.



- Payments may not be processed depending on your network connection.
- The verification method for payments may vary depending on the card readers.

## Cancelling payments

You can cancel payments by visiting the place where you made them.

On the cards list, swipe to the left or right to select the card you used. Follow the on-screen instructions to complete payment cancellation.

# Samsung Health

## Introduction

Samsung Health helps you manage your wellness and fitness. Set fitness goals, check your progress, and keep track of your overall wellness and fitness. You can also compare your step count records with other Samsung Health users, compete with your friends, and view health tips.

## Using Samsung Health

Launch the **Samsung Health** app. When running this app for the first time or restart it after performing a data reset, follow the on-screen instructions to complete the setup.



Some features may not be available depending on the region.

To add items to the Samsung Health home screen, tap **Manage items** at the bottom of the trackers list and tap  on the items to add.

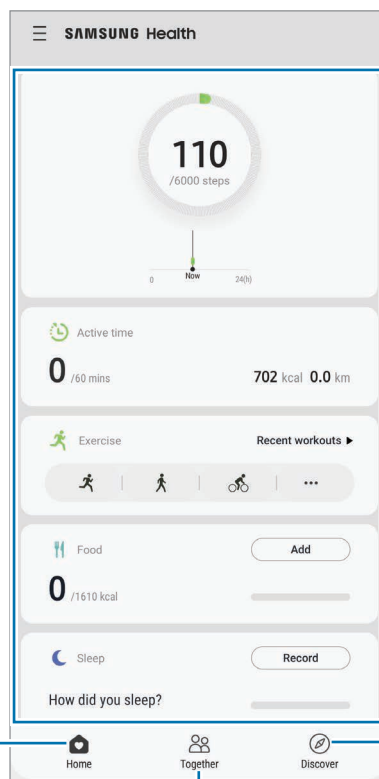

View and manage trackers.

Monitor your health and fitness.

View health tips.

Compare your step count records with other Samsung Health users or compete with your friends.

## Together

Together allows you to set up step count goals and compete with your friends. You can invite friends to walk together, set target step counts, compete in challenges, and view your ranking.

On the Samsung Health home screen, tap **Together**.

## Steps

The device counts the number of steps you take and measures the distance travelled.

On the Samsung Health home screen, tap the steps tracker.

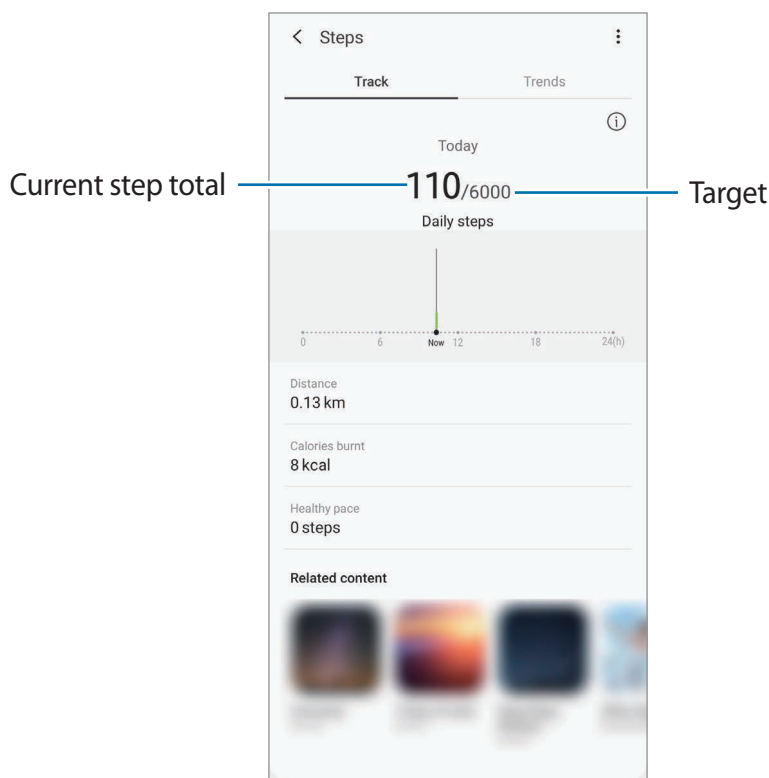

- You may experience a brief delay while the steps tracker monitors your steps and then displays your step count. You may also experience a brief delay before the pop-up window indicates that your goal has been reached.
- If you use the steps tracker while travelling by car or train, vibration may affect your step count.
- You can check your current steps on the notification panel. To turn off notifications, on the Samsung Health home screen, tap **☰** → **⚙️** → **Notifications**, and then tap the **Steps** switch under **Categories** to deactivate it. Alternatively, open the notification panel, tap and hold the notification, tap **Details**, and then tap the **Steps** switch to deactivate it.

## Additional information

- Samsung Health is intended for fitness and wellness purposes only and is not intended for use in the diagnosis of disease or other conditions, or in the cure, mitigation, treatment, or prevention of disease.
- The available functions, features and addable applications for Samsung Health may vary from country to country due to different local laws and regulations. You should check the features and applications available in your specific region before use.
- Samsung Health applications and its service can be changed or discontinued without prior notice.
- The purpose for data collection is limited to providing the service that you have requested, including providing additional information to enhance your wellness, sync data, data analysis and statistics or to develop and provide better services. (But if you sign in to your Samsung account from Samsung Health, your data may be saved on the server for data backup purposes.) Personal information may be stored until the completion of such purposes. You can delete personal data stored by Samsung Health by using the Erase personal data option in the Settings menu. To delete any data you have shared with social networks or transferred to storage devices, you must delete them separately.
- You may share and/or sync your data with additional Samsung services or compatible third party services that you select, as well as with any of your other connected devices. Access to Samsung Health information by such additional services or third party devices will only be permitted with your express approval.
- You assume full responsibility for the inappropriate use of data shared on social networks or transmitted to others. Use caution when sharing your personal data with others.
- If you use a wireless connection, such as Bluetooth, the device may be affected by electronic interference from other devices. Avoid using the device near other devices that transmit radio waves.
- Please read Terms and Conditions and Privacy Policy of Samsung Health carefully before using it.



## Samsung Members

**Samsung Members** offers support services to customers, such as device problem diagnosis, and lets users submit questions and error reports. You can also share information with others in the Galaxy users' community or view the latest news and tips. **Samsung Members** can help you solve any problems you might encounter while using your device.



To submit your feedback or post your comments, you must sign in to your Samsung account. Refer to [Samsung account](#) for more information.

## Samsung Notes

Create notes by entering text from the keyboard or by handwriting or drawing on the screen. You can also insert images or voice recordings into your notes.

### Creating notes

- 1 Launch the **Samsung Notes** app and tap .
- 2 Select an input method from the toolbar at the top of the screen and compose a note.

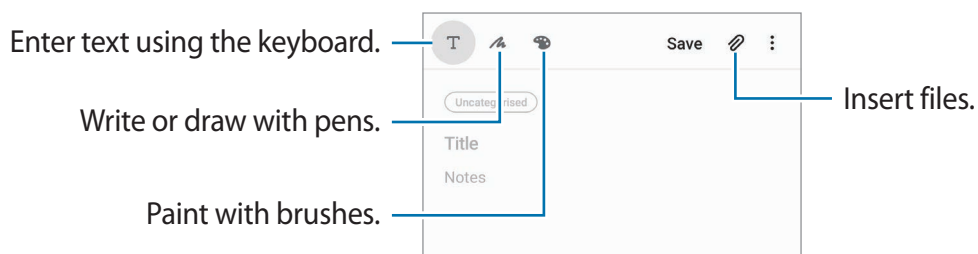

- 3 When you are finished composing the note, tap **Save**.

### Deleting notes

- 1 Launch the **Samsung Notes** app.
- 2 Tap and hold a note to delete.  
To delete multiple notes, tick more notes to delete.
- 3 Tap **Delete**.

# Galaxy Wearable

Galaxy Wearable is an app that allows you to manage your wearable devices. When you connect your device to the wearable device, you can customise the wearable device's settings and apps.

Launch the **Galaxy Wearable** app.

Tap **Get started** to connect your device to the wearable device. Follow the on-screen instructions to finish the setup. Refer to the wearable device's user manual for more information about how to connect and use the wearable device with your device.

# Calendar

Manage your schedule by entering upcoming events or reminders in your planner.

## Creating events

- 1 Launch the **Calendar** app and tap **+** or double-tap a date.  
If the date already has saved events or tasks in it, tap the date and tap **+**.
- 2 Enter event details.

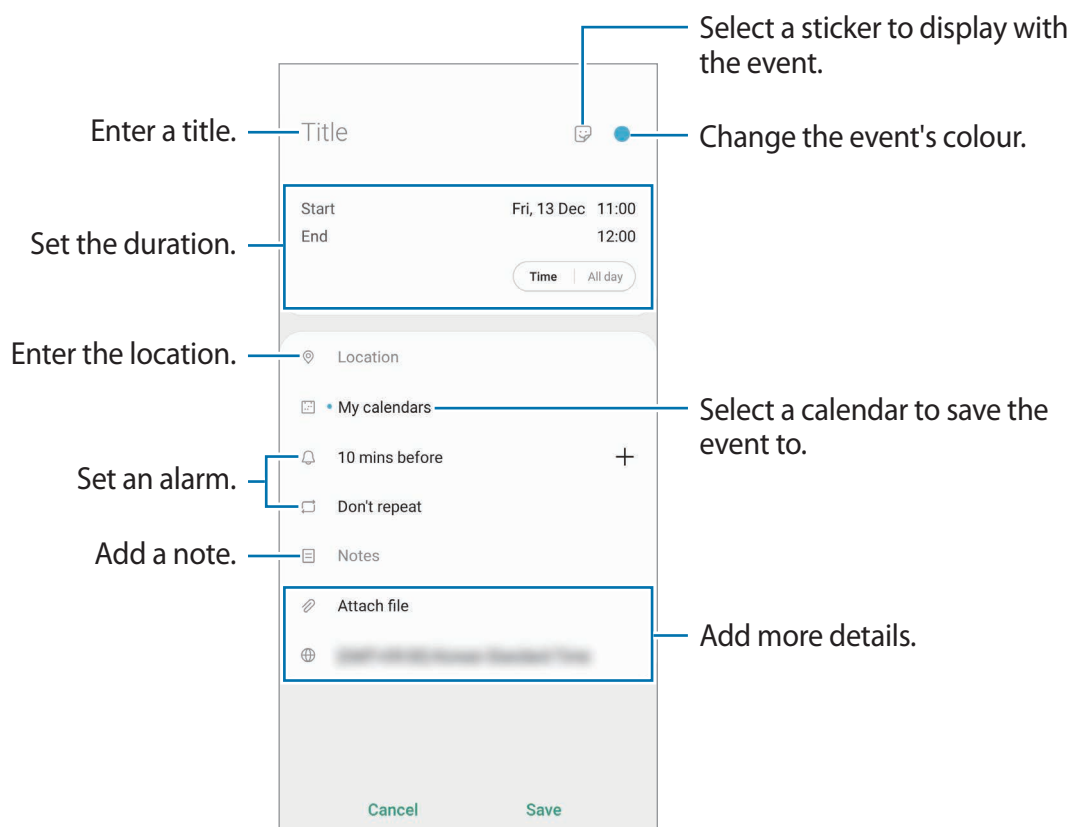



3 Tap **Save** to save the event.

## Creating reminders

You can create tasks as reminders and receive notifications at the preset time or location for each reminder. Launch the **Calendar** app and tap  → **Reminder**. Refer to [Reminder](#) for more information.

## Syncing events with your accounts

- 1 Launch the **Settings** app, tap **Accounts and backup** → **Accounts**, and then select the account to sync with.
- 2 Tap **Sync account** and tap the **Calendar** switch to activate it.  
For the Samsung account, tap  → **Sync settings** and tap the **Calendar** switch to activate it.

To add accounts to sync with, launch the **Calendar** app and tap  →  → **Add new account**. Then, select an account to sync with and sign in. When an account is added, a blue circle is displayed next to the account name.

## Reminder

Create reminders to schedule to-do items or to view content later. You will receive notifications at the preset time or location for each reminder.



- To receive more accurate notifications, connect to a Wi-Fi or mobile network.
- To fully use this feature, you must sign in to your Samsung account.
- To use location reminders, the GPS feature must be activated.

## Starting Reminder

Launch the **Calendar** app and tap  → **Reminder**. The Reminder screen will appear and the **Reminder** app icon () will be added to the Apps screen.

## Creating reminders

Create reminders with various methods. Reminder will alert you if you create a reminder with a specified time or location setting. You can also save various content, such as a single memo or webpage address, and view it later.

For example, create a reminder to alert you to 'Water the flowers when I get home.'

- 1 Launch the **Reminder** app.
- 2 Tap **Write a reminder** or **+** and enter 'Water the flowers.'
- 3 Tap **Place** → **Pick a place** and set the location to home.
- 4 Tap **When I arrive at** → **Done**.

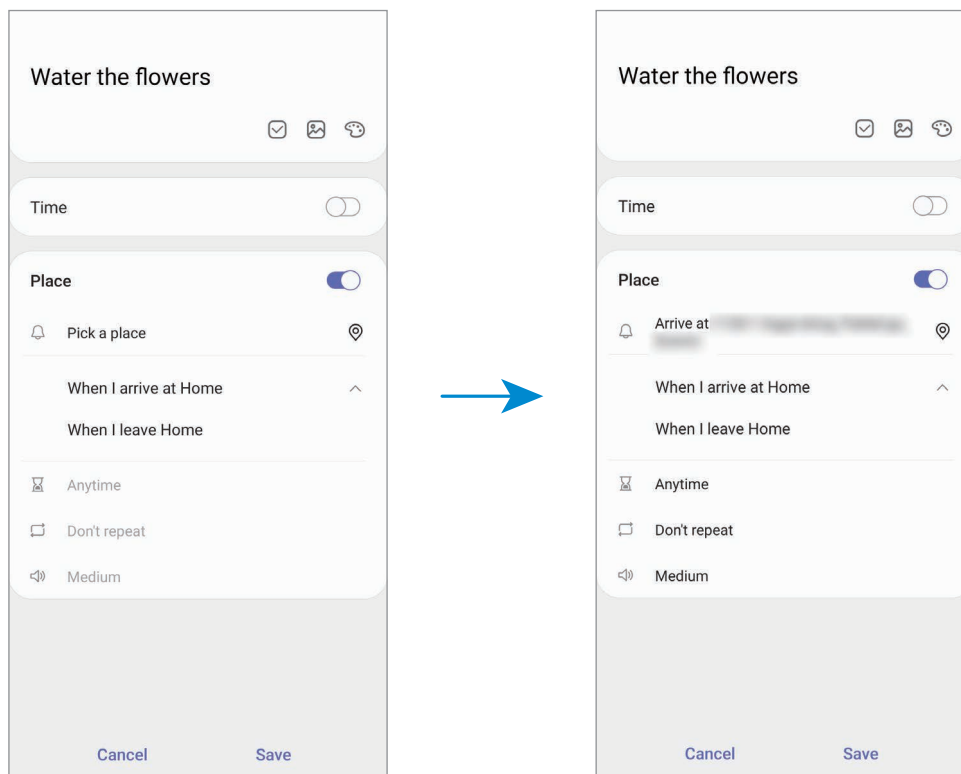

- 5 Tap **Save** to save the reminder.

When you arrive at home, the 'Water the flowers' notification will appear.

## Completing reminders

Mark reminders that you do not need to be reminded of as complete.

On the reminders list, select a reminder and tap **Complete**.

## Restoring reminders

Restore reminders that have been completed.

1 On the reminders list, tap  → **Completed** → **Edit**.

2 Tick items to restore and tap **Restore**.

Reminders will be added to the reminders list and you will be reminded at the preset times.

## Deleting reminders

To delete a reminder, select a reminder and tap **Delete**. To delete multiple reminders, tap and hold a reminder, tick reminders to delete, and then tap **Delete**.

# Voice Recorder

## Introduction

Use different recording modes for various situations. The device can convert your voice to text and distinguish between sound sources.

## Making voice recordings

1 Launch the **Voice Recorder** app.

2 Tap  to start recording. Speak into the microphone.

- Tap  to pause recording.
- While making a voice recording, tap **BOOKMARK** to insert a bookmark.

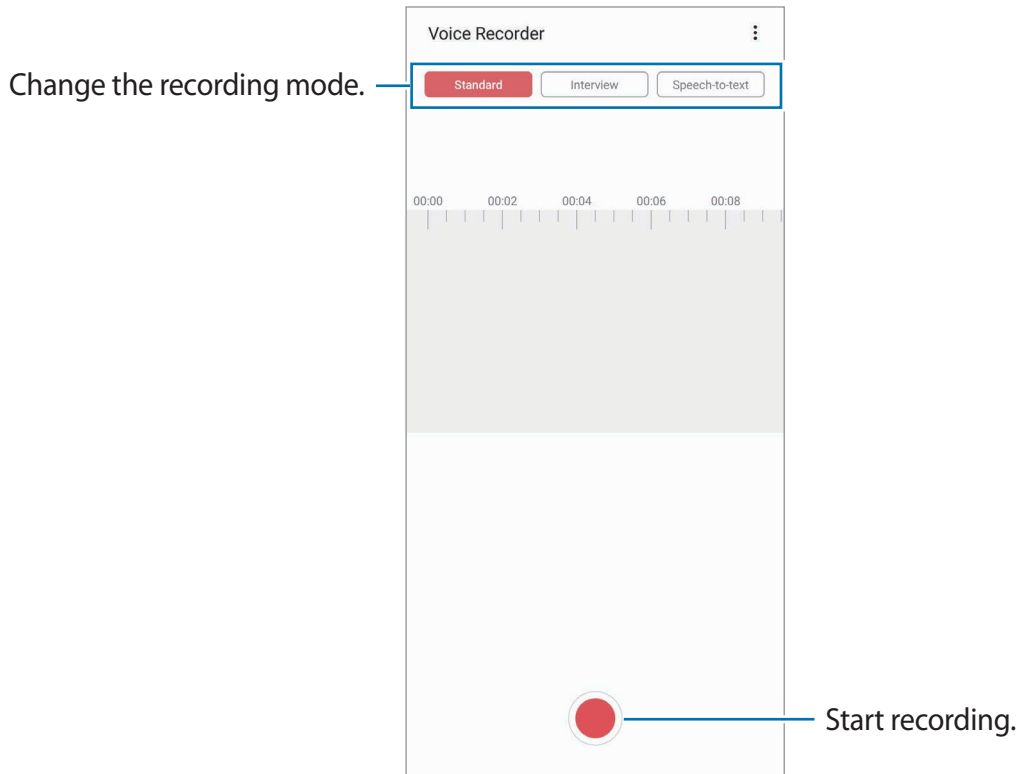

3 Tap  to finish recording.

4 Enter a file name and tap **Save**.

## Changing the recording mode

Launch the **Voice Recorder** app.

Select a mode from the top of the voice recorder screen.

- **Standard:** This is the normal recording mode.
- **Interview:** The device records sound from the top and the bottom of the device at a high volume while reducing the volume of sound from the sides.

- **Speech-to-text:** The device records your voice and simultaneously converts it to on-screen text. For best results, keep the device near your mouth and speak loudly and clearly in a quiet place.



If the voice memo system language does not match the language you are speaking, the device will not recognise your voice. Before using this feature, tap the current language to set the voice memo system language.

## Playing selected voice recordings

When you review interview recordings, you can mute or unmute certain sound sources in the recording.

- 1 Launch the **Voice Recorder** app.
- 2 Tap **List** and select a voice recording made in interview mode.
- 3 To mute certain sound sources, tap **ON** for the corresponding direction that sound is to be muted.

The icon will change to **OFF** and the sound will be muted.

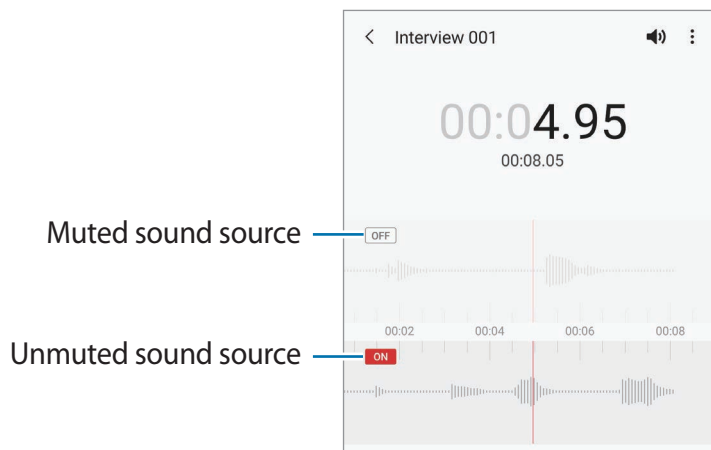

## My Files

Access and manage various files stored in the device or in other locations, such as cloud storage services.

Launch the **My Files** app.

View files that are stored in each storage.

To check for unnecessary data and free up the device's storage, tap **Analyse storage**.

To search for files or folders, tap **Q**.

## Clock

### Introduction

Set alarms, check the current time in many cities around the world, time an event, or set a specific duration.

### Alarm

Launch the **Clock** app and tap **Alarm**.

### Setting alarms

Tap **+** in the alarms list, set an alarm time, select the days on which the alarm will repeat, set other various alarm options, and then tap **Save**.

To open the keypad to enter an alarm time, tap the time input field.

To activate or deactivate alarms, tap the switch next to the alarm in the alarms list.

### Stopping alarms

Tap **Dismiss** to stop an alarm. If you have previously enabled the snooze option, tap **Snooze** to repeat the alarm after a specified length of time.

### Deleting alarms

Tap and hold an alarm, tick alarms to delete, and then tap **Delete**.



## World Clock

Launch the **Clock** app and tap **World Clock**.

### Creating clocks

Tap **+**, enter a city name or select a city from the map, and then tap **Add**.

To use the time zone converter, tap **⋮** → **Time zone converter**.

### Deleting clocks

Tap and hold a clock, tick clocks to delete, and then tap **Delete**.

## Stopwatch

**1** Launch the **Clock** app and tap **Stopwatch**.

**2** Tap **Start** to time an event.

To record lap times while timing an event, tap **Lap**.

**3** Tap **Stop** to stop timing.

- To restart the timing, tap **Resume**.
- To clear lap times, tap **Reset**.

## Timer

**1** Launch the **Clock** app and tap **Timer**.

To add a frequently used timer, tap **+**, set the duration and name, and then tap **Add**.

**2** Set the duration and tap **Start**.

To open the keypad to enter the duration, tap the duration input field.

**3** Tap **Dismiss** when the timer goes off.

# Calculator

Perform simple or complex calculations.

Launch the **Calculator** app.

- 🕒 : View the calculation history. To clear the history, tap **Clear history**. To close the calculation history panel, tap 📄.
- 📏 : Use the unit conversion tool. You can convert various values, such as area, length, or temperature, into other units.
- 🧮 : Display the scientific calculator.

# Game Launcher

## Introduction

Game Launcher gathers your games downloaded from **Play Store** and **Galaxy Store** into one place for easy access. You can set the device to game mode to play games more easily.

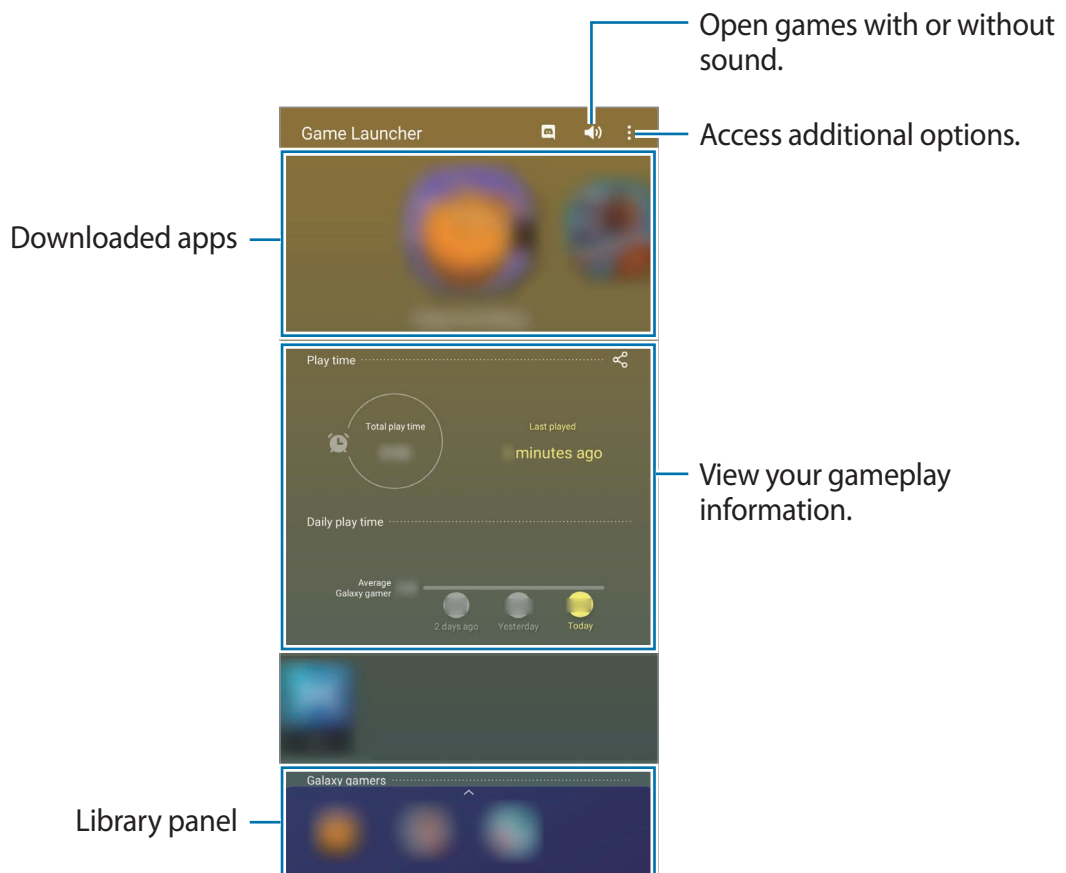

## Using Game Launcher

1 Launch the **Game Launcher** app.



If **Game Launcher** does not appear, launch the **Settings** app, tap **Advanced features**, and then tap the **Game Launcher** switch to activate it.

2 Drag the Library panel upwards and tap a game.



Games downloaded from **Play Store** and **Galaxy Store** will be automatically shown on the Game Launcher screen. If you cannot see your games, drag the Library panel upwards and tap  → **Add apps**.

## Removing a game from Game Launcher

Drag the Library panel upwards, tap and hold a game, and then tap **Remove from Game Launcher**.

## Changing the performance mode

You can change the game performance mode.

Launch the **Game Launcher** app, tap  → **Game performance** → **Game performance**, and then select the mode you want.

- **Focus on performance:** This focuses on giving you the best possible performance while playing games.
- **Balanced:** This balances the performance and the battery usage time.
- **Focus on power saving:** This saves battery power while playing games.



Battery power efficiency may vary by game.

# Game Booster

## Introduction

Game Booster lets you play games in a better environment and provides you with useful options via the Game Booster panel.



## Using Game Booster

To open the Game Booster panel while playing games, tap  on the navigation bar. If the navigation bar is hidden, drag upwards from the bottom of the screen to show it. If you have set the navigation bar to use **Full screen gestures**, open the notification panel and tap **Tap to open Game Booster**.

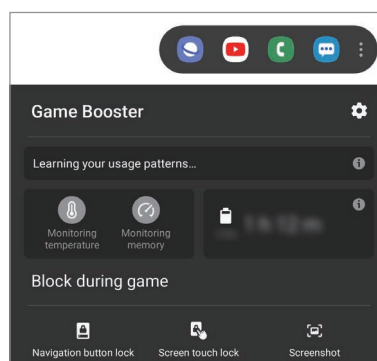

- You can set to open the Game Booster panel from the navigation bar while the navigation bar is set to **Full screen gestures**. On the Game Booster panel, tap **Block during game** and tap the **Full screen gestures** switch to activate it.
- Available options may vary depending on the game.



- : Configure settings for Game Booster.
- Monitoring temperature / Monitoring memory**: Set the device to automatically adjust settings to prevent device overheating and to stop apps running in the background to better manage memory.
- Block during game**: Lock some features during games.
- Navigation button lock**: Hide the buttons on the navigation bar. To display the buttons, tap  on the navigation bar.
- Screen touch lock**: Lock the touchscreen while the game is being played. To unlock the touchscreen, drag the lock icon in any direction.
- Screenshot**: Capture screenshots.

## Launching apps in pop-up windows while playing games

You can launch apps in pop-up windows while playing a game.

Tap  and select an app from the apps list.

To edit the apps list, tap .

## Kids Home

### Introduction

You can restrict children's access to certain apps, set their usage times, and configure settings to provide a fun and safe environment for children when they use the device.

### Using Kids Home

Open the notification panel, swipe downwards, and then tap  (**Kids Home**) to activate it. The Kids Home screen will appear. When starting Kids Home for the first time or after performing a data reset, follow the on-screen instructions to complete the setup.

On the Kids Home screen, select the app you want to use.

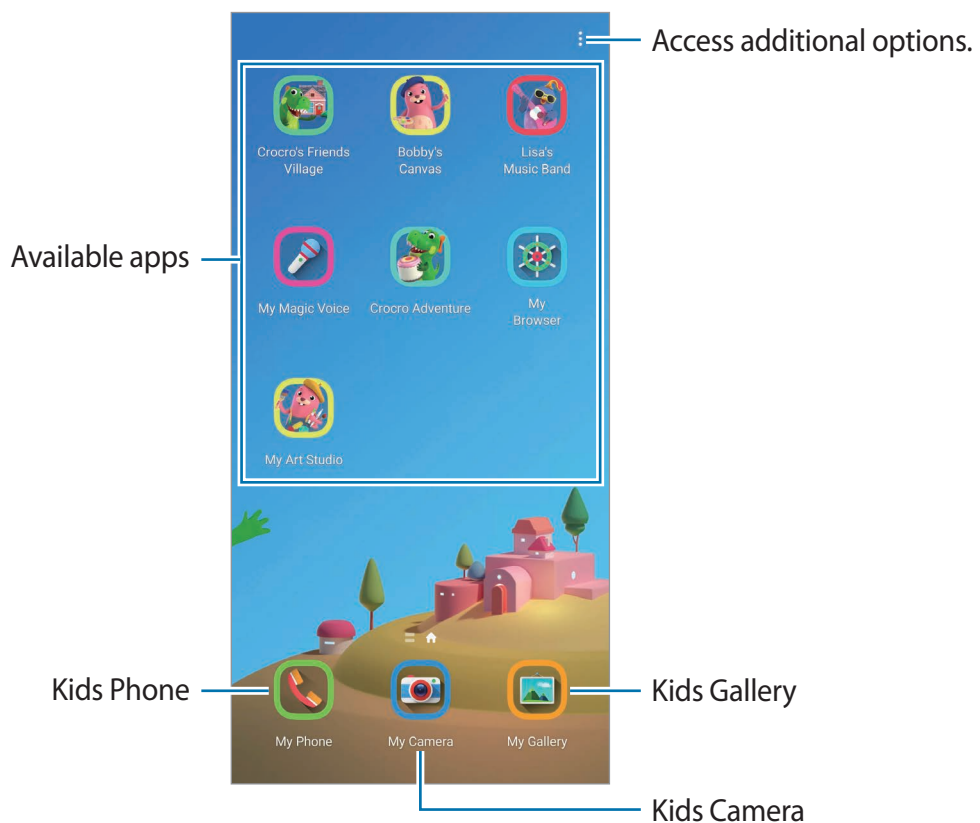



Your preset screen lock method or your created PIN will be used when activating the **Parental control** feature or closing Kids Home.

## Using parental control features

You can configure the settings for Kids Home and view the usage history.

On the Kids Home screen, tap  → **Parental control** and enter your unlock code.

- **Kid's name:** Manage your child's profile.
- **Set daily playtime:** Restrict the usage time for Kids Home.
- **Daily usage:** View the daily usage time of Kids Home.
- **Activity:** View the activity history of Kids Home.
- **Frequently contacted:** View the frequently used contacts in Kids Home.
- **My kid's creations:** View the works created from the apps in Kids Home.
- **Allowed content:** Check the apps or content supported by Kids Home and add them.
- **Show Content page:** Set the device to display the Samsung partner's content page on the Kids Home screen.

## Closing Kids Home

To close Kids Home, tap the Back button or tap  → **Close Kids Home**, and then enter your unlock code.

# SmartThings

## Introduction

Control and manage smart appliances and Internet of Things (IoT) products with your smartphone.

- **Connecting with nearby devices:** Connect with nearby devices, such as Bluetooth headsets or wearable devices, easily and quickly.
- **Registering and controlling home appliances, TVs, and IoT products:** Register smart refrigerators, washers, air conditioners, air purifiers, TVs, and Internet of Things (IoT) products on your smartphone, and view their status or control them from your smartphone's screen.

- **Receiving notification:** Receive notifications from connected devices on your smartphone. For example, when the laundry is finished, you can receive a notification on your smartphone.



- To use SmartThings, your smartphone and other devices must be connected to a Wi-Fi or mobile network. To fully use SmartThings, you must sign in to your Samsung account.
- The devices you can connect may vary depending on the region or service provider. Available features may differ depending on the connected device.
- Connected devices' own errors or defects are not covered by the Samsung warranty. When errors or defects occur on the connected devices, contact the device's manufacturer.

## Connecting to nearby devices

Connect to nearby devices, such as Bluetooth headsets, easily and quickly.



Connection methods may vary depending on the type of connected devices or the shared content.

- 1 Launch the **SmartThings** app.
- 2 Tap **Add device** or tap **+** → **Device**.
- 3 Tap **Scan**.
- 4 Select a device from the list and connect to it by following the on-screen instructions.

## Using home appliances, TVs, and IoT products

View the status of your smart appliances, TVs, and IoT products from your smartphone's screen. You can group devices by location and add rules to control the devices easily and conveniently.

### Connecting devices

- 1 Launch the **SmartThings** app.
- 2 Tap **Add device** or tap **+** → **Device**.

- 3 Select a device type.  
Or, tap **Scan** or tap the search field to search for devices.
- 4 Follow the on-screen instructions to connect devices.

## Viewing and controlling connected devices



You can view and control the devices. For example, you can check the ingredients in your refrigerator or adjust the TV volume.

- 1 Launch the **SmartThings** app.  
The list of connected devices will appear.
- 2 View the status of devices on the list.  
To control the devices, select a device. When the device controller supplied with the selected device is downloaded, you can control the device.

## Adding devices and scenes by locations

Add devices by locations, view the list of devices in a same location, and control them. You can also add a scene to a location to control multiple devices at the same time.





### Adding locations

- 1 Launch the **SmartThings** app and tap  →  → **Add location**.
- 2 Enter the location name.
  - To set a location, tap **Geolocation** to select a location on the map and tap **Done**.
  - To add rooms to the location, tap **Rooms**, tick rooms you want to add, and then tap **Done**.
- 3 Tap **Done**.  
Your location will be added.  
To add devices to the location, tap **Add device** or tap  → **Device** and follow the on-screen instructions to register devices.



## Adding scenes





Add a scene and register devices to it to control multiple devices at the same time.

- 1 Launch the **SmartThings** app.
- 2 Tap  →  and select a location.
- 3 Tap  → **Scenes** → **Add scene**.
- 4 Enter the scene name.
- 5 Tap  under **Actions** to add actions to perform.
- 6 Tap **Save**.

## Adding automations



You can also set an automation to operate devices automatically depending on the preset time, the status of devices, and more.

For example, add an automation to turn on the audio automatically every day at 7:00 AM.

- 1 Launch the **SmartThings** app.
- 2 Tap  →  and select a location.
- 3 Tap  → **Automations** → **Add automation**.
- 4 Tap  under **If**, set the activation conditions for the automation, and then tap **Next**.
- 5 Tap  under **Then**, set actions to perform, and then tap **Done**.
- 6 Enter the automation name and tap **OK**.

## Receiving notifications

You can receive notifications from connected devices on your smartphone. For example, when the laundry is finished, you can receive a notification on your smartphone.

To set devices to receive notifications, launch the **SmartThings** app, tap  →  → **Notifications**, and then tap the switches next to the devices you want.

## Sharing content

Share content by using various sharing options. The following actions are an example of sharing images.



You may incur additional charges when sharing files via the mobile network.

- 1 Launch the **Gallery** app and select an image.
- 2 Tap  and select a sharing method, such as message and email.

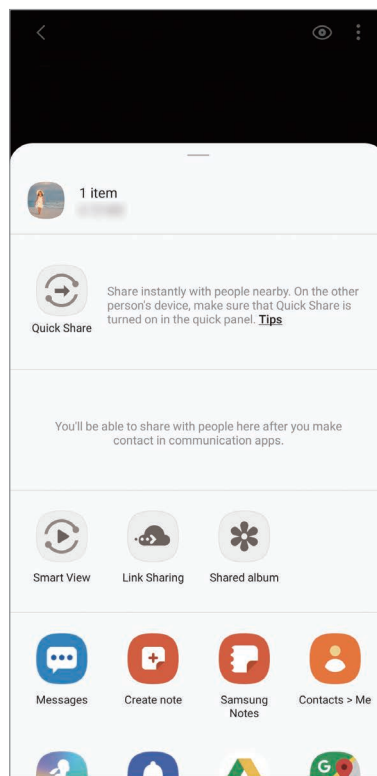



When you have a communication or sharing history, the people you contacted will appear on the sharing options panel. To directly share content with them via the corresponding app, select a person's icon. If the feature is not activated, launch the **Settings** app, tap **Advanced features**, and then tap the **Direct share** switch to activate it.

## Quick Share

Share content with nearby devices via Wi-Fi Direct or Bluetooth, or with SmartThings supported devices.





This feature does not support sharing videos with TVs or SmartThings supported devices. To watch videos on TV, use the Smart View feature.

- 1 Launch the **Gallery** app and select an image.
- 2 On the other device, open the notification panel, swipe downwards, and then tap  (**Quick Share**) to activate it.
- 3 Tap  and select a device to transfer the image to.
- 4 Accept the file transfer request on the other device.

## Setting who can find your device

Set who is allowed to find and send content to your device.

- 1 Open the notification panel, swipe downwards, and then tap  (**Quick Share**) to activate it.
- 2 Tap and hold  (**Quick Share**).  
The Quick Share settings screen will appear.
- 3 Select an option under **Who can share with you?**
  - **Contacts only:** Allow only your contacts to share with your device.
  - **Everyone:** Allow any nearby devices to share with your device.

## Smart View

View your device's displayed content on a large screen by connecting your device to a screen mirroring-enabled TV or monitor.



When you play a video with Smart View, the resolution may vary depending on the TV model.

- 1 Launch the **Gallery** app and select an image.
- 2 Tap  → **Smart View** and select a device to mirror your device's screen or display content.

## Link Sharing

Share large files. Upload files to the Samsung storage server and share them with others via a Web link.



To use this feature, you must sign in to your Samsung account.

- 1 Launch the **Gallery** app and select an image.
- 2 Tap  → **Link Sharing**.  
The link for the image will be created.
- 3 Select a sharing option.

## Shared album

Create a shared album to share photos or videos with others, and download your files whenever you want.



- To use this feature, you must sign in to your Samsung account.
- When you play a high-resolution video from a shared album, the video connection may drop depending on the network speed.
- Content that is larger than 1 GB cannot be shared to a shared album.

- 1 Launch the **Gallery** app and select an image.

2 Tap  → **Shared album**.

3 Select an album to share.

If there is no album to share, tap **Create shared album** and follow the on-screen instructions to create an album.

## Music Share

The Music Share feature allows you to easily share your Bluetooth speaker or headset that is already connected to your device with others. For example, you can play music stored on your friend's smartphone via your Bluetooth car stereo while keeping it and your smartphone connected.



This feature is available only on devices that support the Music Share feature.





1 **Your smartphone** Launch the **Settings** app, tap **Connections** → **Bluetooth**, tap the switch to activate it, and then connect the smartphone to your Bluetooth car stereo.



If the smartphone and your Bluetooth car stereo are already connected, proceed to the next step.

2 **Your smartphone** Open the notification panel, swipe downwards, and then tap  (**Music Share**) to activate it.

You can use additional features, such as setting who to share your device with, by launching the **Settings** app and tapping **Connections** → **Bluetooth** →  → **Advanced** → **Music Share**.

- 3 Friend's smartphone** Open the notification panel, swipe downwards, and then tap  (Bluetooth) to activate it.

The list of the devices that can be connected will appear.

- 4 Friend's smartphone** Select your Bluetooth car stereo connected to your smartphone.

- 5 Your smartphone** Accept the connection request.

Your friend's smartphone and your smartphone will be connected.

- 6 Friend's smartphone** Play a music file.

The music will play on your Bluetooth car stereo.

## Samsung DeX

### Introduction

Samsung DeX is a service that allows you to use your smartphone like a computer by connecting the smartphone to an external display, such as a TV or monitor, or to a computer. Accomplish tasks you want done on your smartphone quickly and easily on a large screen using a keyboard and mouse. While using Samsung DeX, you can simultaneously use your smartphone.

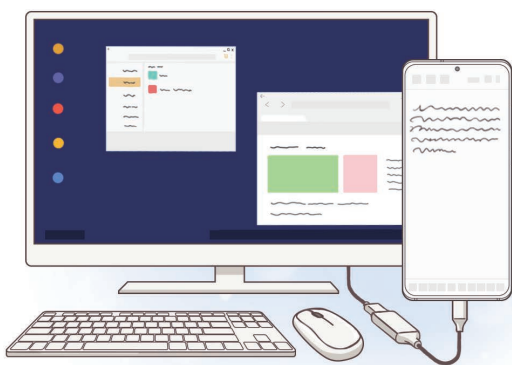

## Connecting devices and starting Samsung DeX

### Connecting to an external display

You can connect your smartphone to an external display using an HDMI adaptor (USB Type-C to HDMI).

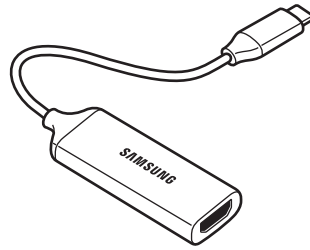

- All accessories are sold separately.
- Use only official Samsung DeX supported accessories that are provided by Samsung. Performance problems and malfunctions caused by using accessories that are not officially supported are not covered by the warranty.

- 1 Connect an HDMI adaptor to your smartphone.
- 2 Connect an HDMI cable to the HDMI adaptor and to a TV or monitor's HDMI port.

**3** On your smartphone's screen, tap **Continue** → **Start**.

Without changing your smartphone's screen, the Samsung DeX screen will appear on the connected TV or monitor.

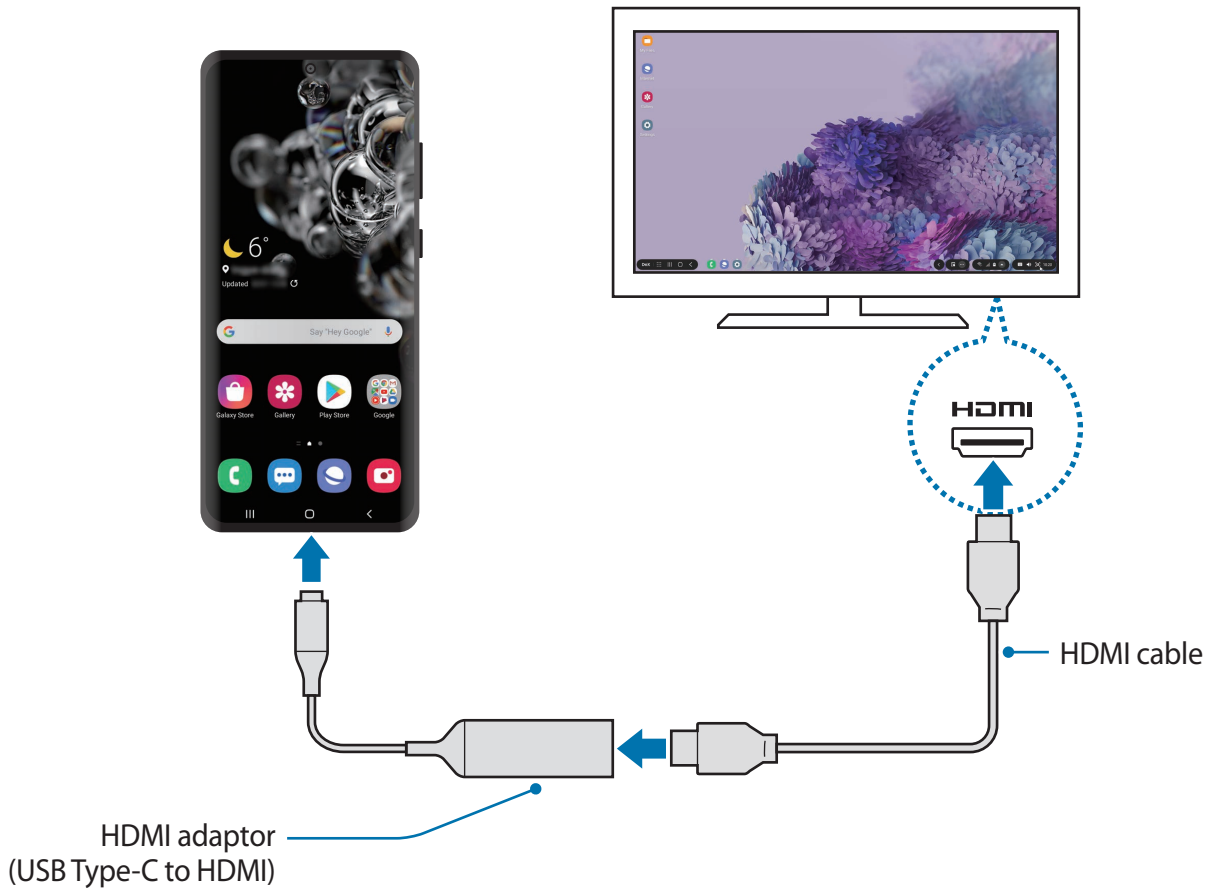

## Connecting to a computer

You can use Samsung DeX by connecting your smartphone to a computer using a USB cable.

**1** Connect your smartphone to a computer using a USB cable.

 To use the USB cable supplied with the device, the computer must have a USB Type-C port.

**2** Open the notification panel, tap **Samsung DeX**.



- 3 When the screen for the app installation instructions appears on your smartphone, follow the on-screen instructions to download the Samsung DeX app on the computer.
- 4 When the app is installed, connect your smartphone to the USB cable again. When they are connected, the Samsung DeX screen will appear on the computer.

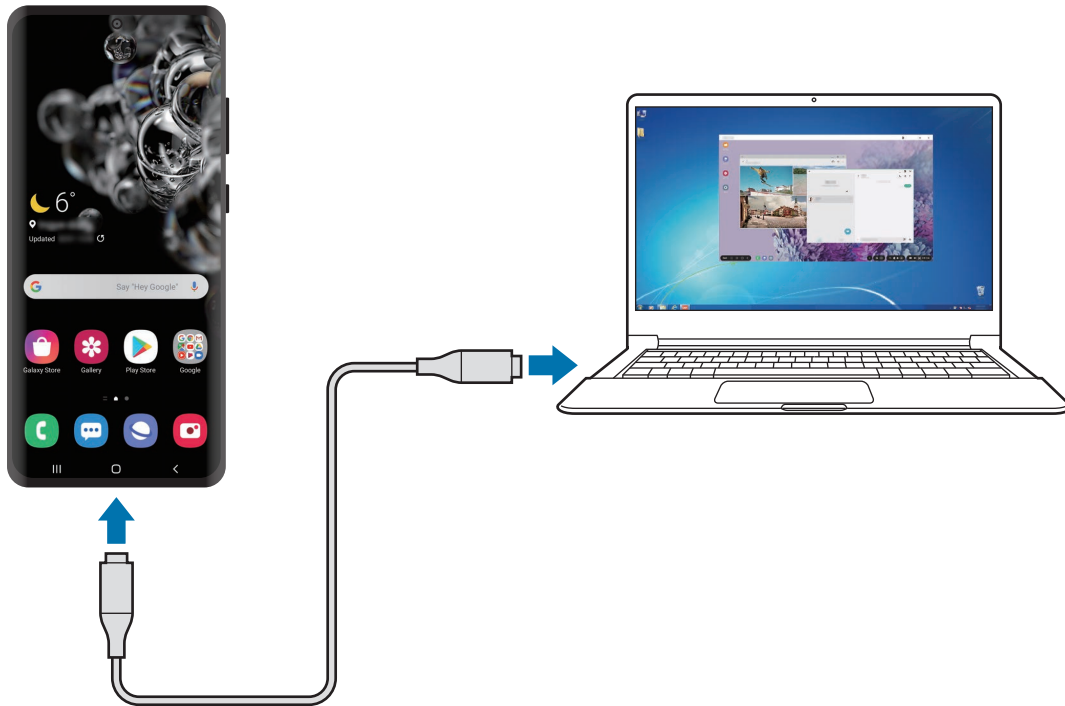

## Controlling the Samsung DeX screen

### Controlling on an external display

#### Controlling with an external keyboard and mouse

You can use a wireless keyboard/mouse. Refer to the respective device's manual for more information.



- You can set the mouse pointer to flow from the external display to the smartphone's screen. Launch the **Settings** app, select **Samsung DeX** → **Mouse/trackpad**, and then select the **Flow pointer to phone screen** switch to activate it.
- You can also use the external keyboard on the smartphone's screen.

## Using your smartphone as a touchpad

You can use your smartphone as a touchpad and operate it with your fingers.

On your smartphone, drag downwards from the top of the screen to open the notification panel and tap **Use your phone as a touchpad**.



- You can use the touchpad only when using Samsung DeX mode.
- If your smartphone's case has a front cover, open the front cover to use your smartphone as a touchpad. If the front cover is closed, the touchpad may not work properly.
- If your smartphone's screen turns off, press the Side key or double-tap the screen to turn on the screen.

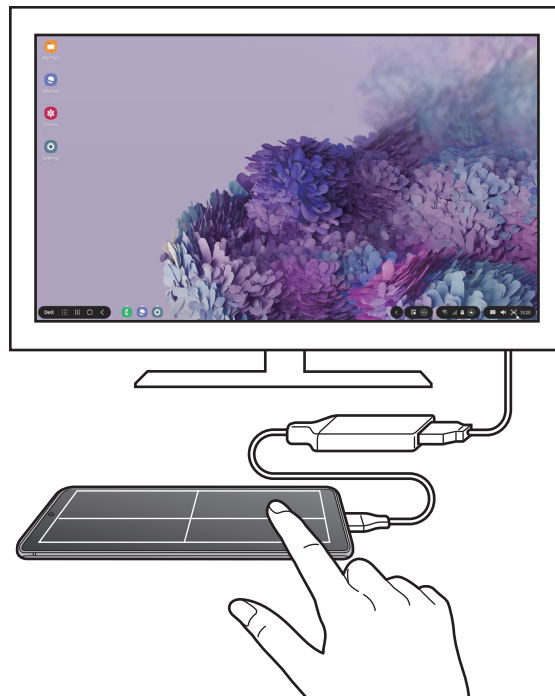

## Using the screen keyboard

When you enter text to send messages, create notes, or perform other tasks, a screen keyboard will appear automatically on your smartphone's screen without connecting an external keyboard.

If the keyboard does not appear, select  on the quick access toolbar.

## Controlling on a computer

Control the Samsung DeX screen using the keyboard and mouse connected to the computer. You can move files easily between the computer and Samsung DeX by drag and drop, and you can also copy and paste text.





To view keyboard shortcuts available while using Samsung DeX, select **DeX** → **How to use** → **Use keyboard shortcuts** → **Keyboard shortcuts**.

## Using Samsung DeX

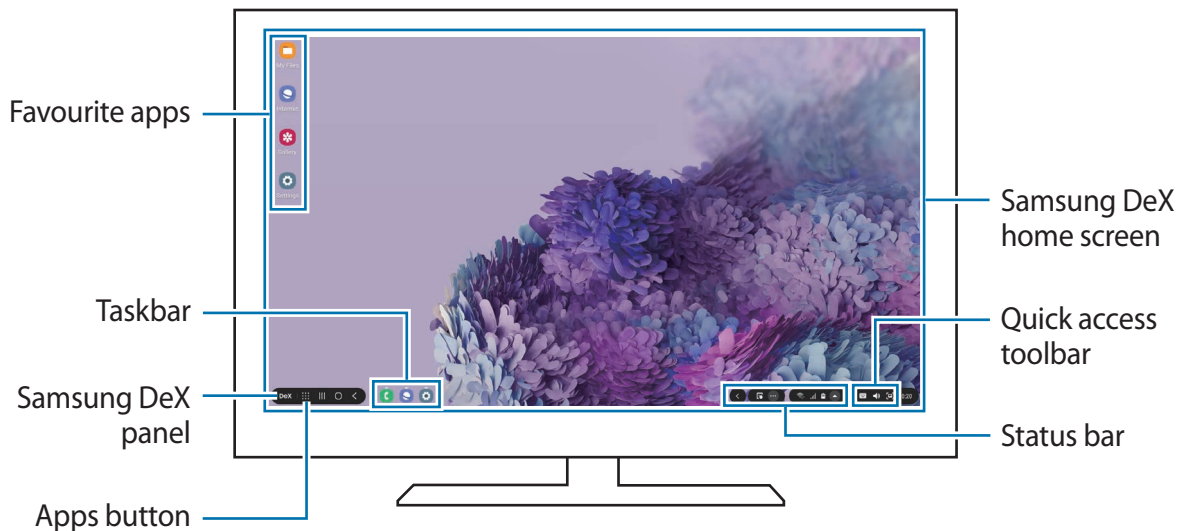
Use your smartphone's features in an interface environment similar to a computer. You can multitask by running multiple apps simultaneously. You can also check your smartphone's notifications and status.



- The Samsung DeX screen layout may differ depending on the connected device.
- When starting or ending Samsung DeX, running apps may be closed.
- Some apps or features may not be available when using Samsung DeX.
- To adjust the screen settings, use the connected TV or monitor's display settings.
- To change the audio output, select  on the status bar, select **Media**, and then select a device under **Audio output**.
- **Favourite apps:** Add frequently used apps to the Home screen and launch them quickly.
- **Samsung DeX panel:** You can use various useful features, such as locking the Samsung DeX screen, viewing how to use Samsung DeX, and switching to screen mirroring mode.

- **Apps button:** View and run your smartphone's apps.
- **Taskbar:** View the apps that are currently running.
- **Status bar:** View your smartphone's notifications and status. Status icons may appear differently depending on your smartphone's status. When you select , the quick setting buttons will appear. You can activate or deactivate certain smartphone features using the quick setting buttons.
- **Quick access toolbar:** Use quick tools, such as screen keyboard, volume control, or search.

## Using Samsung DeX and smartphone simultaneously

While using Samsung DeX, you can use separate apps on the external display or the computer and your smartphone simultaneously.

For example, while watching a video on the connected TV or monitor, you can chat with your friend on a messenger.

On the connected TV or monitor, launch an app to run on the Samsung DeX screen. Then, launch another app on your smartphone.

## Locking the Samsung DeX screen

If you want to lock the external display and your smartphone's screen while using Samsung DeX, select **DeX** → **Lock DeX**.



While using Samsung DeX, you cannot lock the external display and your smartphone's screen by pressing the Side key.

## Transferring data with a computer

### Copying files

On the Samsung DeX screen, click and hold a file to select it in the **My Files** app or **Gallery** app and drag it to the computer screen. On the computer screen, select a file and drag it to the Samsung DeX screen, the **My Files** app, or the **Gallery** app.

### Copying and pasting text

Using the keyboard shortcut keys, copy text on the Samsung DeX screen or computer screen and paste it in the text input field on the other screen.

## Ending Samsung DeX

When you disconnect your smartphone from the external display, such as a TV or monitor, or the computer, Samsung DeX will end.

Disconnect your smartphone from the HDMI adaptor or USB cable.

## Link to Windows

### Introduction

You can connect your device to a Windows PC to instantly access your device's data, such as photos or messages, on the computer.

When calls or messages come in, you can receive them on the computer.



- This feature is only available on Windows 10 version 1803 or higher, and it is recommended to use the latest version to fully use this feature.
- A Microsoft account is required to use this feature. When you create a Microsoft account, you can sign in to all Microsoft devices and services, such as Microsoft Office programs and Windows 10.

### Connecting to a computer

- 1 Device** Launch the **Settings** app and tap **Advanced features** → **Link to Windows**.
- 2 Device** Tap **Sign in with Microsoft**, sign in to your Microsoft account, and then tap **Continue**.
- 3 Device** Tap **Show me** to view the computer setup procedures and tap **Continue** to complete the setup.
- 4 Computer** Launch the **Microsoft Store** app, search and download the **Your Phone** app, and then launch it.
- 5 Device** Accept the connection request.  
Your device and the computer will be connected.

## Viewing data and notifications from your device on the computer

1 Launch the **Your Phone** app on the computer.

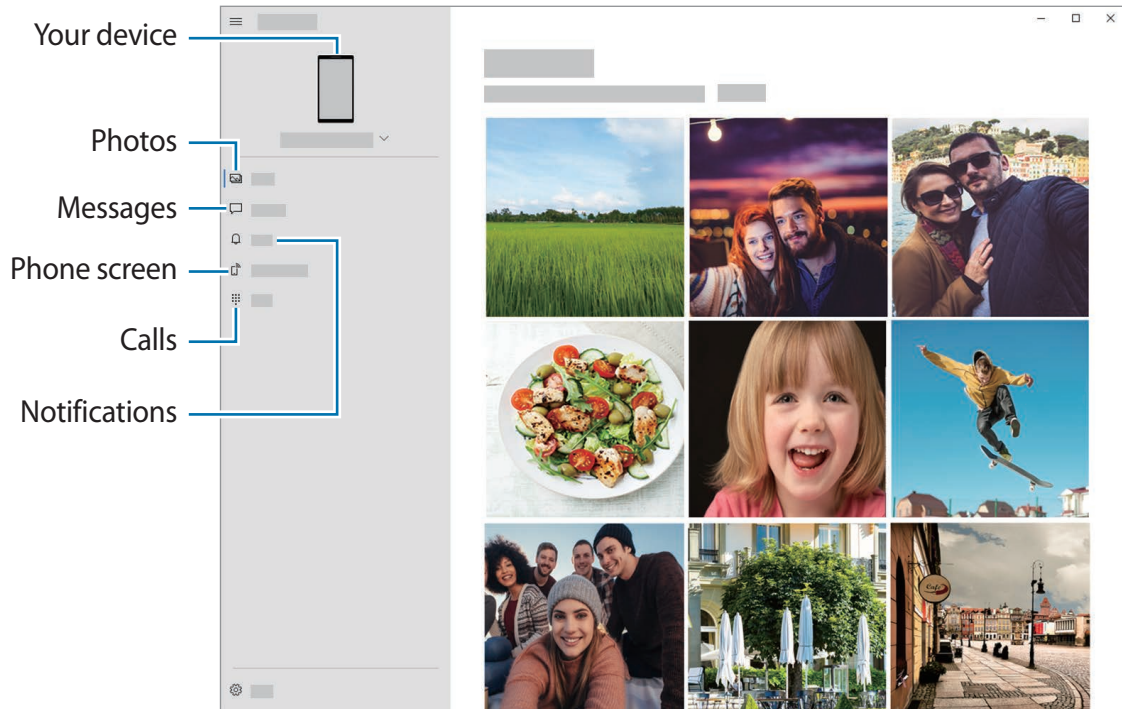

Available features and menus may vary depending on the software version or model.

2 Select a category you want.

- **Photos:** View the photos saved in your device.
- **Messages:** View messages saved in your device or send new messages.
- **Notifications:** View notifications from your device on the computer.
- **Phone screen:** Mirror your device's screen on the computer screen. You can also use the apps and features in the device.
- **Calls:** Make or answer calls.

## Samsung Global Goals

The Global Goals, which were established by the United Nations General Assembly in 2015, consist of goals that aim to create a sustainable society. These goals have the power to end poverty, fight inequality, and stop climate change.

With Samsung Global Goals, learn more about the global goals and join the movement for a better future.

## Google apps

Google provides entertainment, social network, and business apps. You may require a Google account to access some apps.

To view more app information, access each app's help menu.



Some apps may not be available or may be labelled differently depending on the region or service provider.

### Chrome

Search for information and browse webpages.

### Gmail

Send or receive emails via the Google Mail service.

### Maps

Find your location on the map, search the world map, and view location information for various places around you.

### YT Music

Enjoy various music and videos provided by YouTube Music. You can also view the music collections stored on your device and play them.

### Play Movies & TV

Purchase or rent videos, such as movies and TV programmes, from **Play Store**.

## **Drive**

Store your content on the cloud, access it from anywhere, and share it with others.

## **YouTube**

Watch or create videos and share them with others.

## **Photos**

Search for, manage, and edit all your photos and videos from various sources in one place.

## **Google**

Search quickly for items on the Internet or your device.

## **Duo**

Make a simple video call.



# Settings

## Introduction

Customise device settings. You can make your device more personalised by configuring various setting options.

Launch the **Settings** app.

To search for settings by entering keywords, tap **Q**.

## Connections

### Options

Change settings for various connections, such as the Wi-Fi feature and Bluetooth.

On the Settings screen, tap **Connections**.

- **Wi-Fi:** Activate the Wi-Fi feature to connect to a Wi-Fi network and access the Internet or other network devices. Refer to [Wi-Fi](#) for more information.
- **Bluetooth:** Use Bluetooth to exchange data or media files with other Bluetooth-enabled devices. Refer to [Bluetooth](#) for more information.
- **NFC and payment:** Set the device to allow you to read near field communication (NFC) tags that contain information about products. You can also use this feature to make payments and buy tickets for transportation or events after downloading the required apps. Refer to [NFC and payment](#) for more information.
- **Flight mode:** Set the device to disable all wireless functions on your device. You can use only non-network services.



Follow the regulations provided by the airline and the instructions of aircraft personnel. In cases where it is allowed to use the device, always use it in flight mode.

- **Mobile networks:** Configure your mobile network settings.

- **Data usage:** Keep track of your data usage amount and customise the settings for the limitation. Set the device to automatically disable the mobile data connection when the amount of mobile data you have used reaches your specified limit.

You can activate the data saver feature to prevent some apps running in the background from sending or receiving data. Refer to [Data saver](#) for more information.

You can also select apps to always use the mobile data even when your device is connected to a Wi-Fi network. Refer to [Mobile data only apps](#) for more information.

- **SIM card manager** (dual SIM models): Activate your SIM or USIM cards and customise the SIM card settings. Refer to [SIM card manager \(dual SIM models\)](#) for more information.
- **Mobile Hotspot and Tethering:** Use the device as a mobile hotspot to share the device's mobile data connection with other devices when the network connection is not available. Connections can be made via Wi-Fi, USB, or Bluetooth. Refer to [Mobile Hotspot and Tethering](#) for more information.
- **More connection settings:** Customise settings to control other features. Refer to [More connection settings](#) for more information.

## Wi-Fi

Activate the Wi-Fi feature to connect to a Wi-Fi network and access the Internet or other network devices.

### Connecting to a Wi-Fi network

1 On the Settings screen, tap **Connections** → **Wi-Fi** and tap the switch to activate it.

2 Select a network from the Wi-Fi networks list.

Networks that require a password appear with a lock icon. Enter the password and tap **Connect**.



- Once the device connects to a Wi-Fi network, the device will reconnect to that network each time it is available without requiring a password. To prevent the device from connecting to the network automatically, tap  next to the network and tap the **Auto reconnect** switch to deactivate it.
- If you cannot connect to a Wi-Fi network properly, restart your device's Wi-Fi feature or the wireless router.

## Wi-Fi Direct

Wi-Fi Direct connects devices directly via a Wi-Fi network without requiring an access point.

- 1 On the Settings screen, tap **Connections** → **Wi-Fi** and tap the switch to activate it.
- 2 Tap  → **Wi-Fi Direct**.  
The detected devices are listed.  
If the device you want to connect to is not in the list, request that the device turns on its Wi-Fi Direct feature.
- 3 Select a device to connect to.  
The devices will be connected when the other device accepts the Wi-Fi Direct connection request.

### Sending and receiving data

You can share data, such as contacts or media files, with other devices. The following actions are an example of sending an image to another device.

- 1 Launch the **Gallery** app and select an image.
- 2 Tap  → **Wi-Fi Direct** and select a device to transfer the image to.
- 3 Accept the Wi-Fi Direct connection request on the other device.  
If the devices are already connected, the image will be sent to the other device without the connection request procedure.

### Ending the device connection

- 1 On the Settings screen, tap **Connections** → **Wi-Fi**.
- 2 Tap  → **Wi-Fi Direct**.  
The device displays the connected devices in the list.
- 3 Tap the device name to disconnect the devices.

## Bluetooth

Use Bluetooth to exchange data or media files with other Bluetooth-enabled devices.



- Samsung is not responsible for the loss, interception, or misuse of data sent or received via Bluetooth.
- Always ensure that you share and receive data with devices that are trusted and properly secured. If there are obstacles between the devices, the operating distance may be reduced.
- Some devices, especially those that are not tested or approved by the Bluetooth SIG, may be incompatible with your device.
- Do not use the Bluetooth feature for illegal purposes (for example, pirating copies of files or illegally tapping communications for commercial purposes). Samsung is not responsible for the repercussion of illegal use of the Bluetooth feature.

### Pairing with other Bluetooth devices

**1** On the Settings screen, tap **Connections** → **Bluetooth** and tap the switch to activate it. The detected devices will be listed.

**2** Select a device to pair with.

If the device you want to pair with is not on the list, set the device to enter Bluetooth pairing mode. Refer to the other device's user manuals.



Your device is visible to other devices while the Bluetooth settings screen is open.

**3** Accept the Bluetooth connection request on your device to confirm.

The devices will be connected when the other device accepts the Bluetooth connection request.

## Sending and receiving data

Many apps support data transfer via Bluetooth. You can share data, such as contacts or media files, with other Bluetooth devices. The following actions are an example of sending an image to another device.

- 1 Launch the **Gallery** app and select an image.
- 2 Tap  → **Bluetooth** and select a device to transfer the image to.  
If the device you want to pair with is not in the list, request that the device turns on its visibility option.
- 3 Accept the Bluetooth connection request on the other device.

## Unpairing Bluetooth devices

- 1 On the Settings screen, tap **Connections** → **Bluetooth**.  
The device displays the paired devices in the list.
- 2 Tap  next to the device name to unpair.
- 3 Tap **Unpair**.

## NFC and payment

Your device allows you to read near field communication (NFC) tags that contain information about products. You can also use this feature to make payments and buy tickets for transportation or events after downloading the required apps.



The device contains a built-in NFC antenna. Handle the device carefully to avoid damaging the NFC antenna.

## Reading information from NFC tags

Use the NFC feature to read product information from NFC tags.

- 1 On the Settings screen, tap **Connections** and tap the **NFC and payment** switch to activate it.

- 2 Place the NFC antenna area on the back of your device near an NFC tag.  
The information from the tag appears.

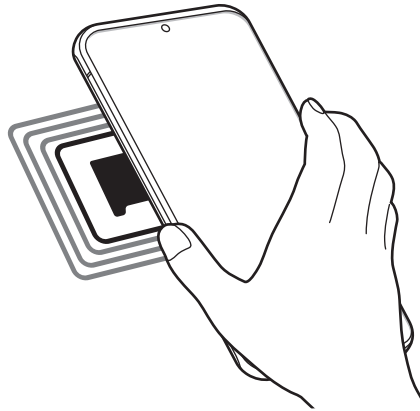

-  Ensure that the device's screen is turned on and unlocked. Otherwise, the device will not read NFC tags or receive data.

## Making payments with the NFC feature

Before you can use the NFC feature to make payments, you must register for the mobile payment service. To register or get more information about the service, contact your service provider.

- 1 On the Settings screen, tap **Connections** and tap the **NFC and payment** switch to activate it.
- 2 Touch the NFC antenna area on the back of your device to the NFC card reader.

To set the default payment app, open the Settings screen and tap **Connections** → **NFC and payment** → **Tap and pay** → **PAYMENT**, and then select an app.

-  The payment services list may not include all available payment apps.

## Sending data with the NFC feature

Transfer data, such as images or contacts, with other devices by touching your device's NFC antenna to the other device's NFC antenna.

- 1 On the Settings screen, tap **Connections** → **NFC and payment** and tap the switch to activate it.
- 2 Tap the **Android Beam** switch to activate it.
- 3 Select an item and touch the other device's NFC antenna to your device's NFC antenna.
- 4 When **Touch to beam.** appears on the screen, tap your device's screen to send the item.



If both devices try to send data simultaneously, the file transfer may fail.

## Data saver

Reduce your data usage by preventing some apps running in the background from sending or receiving data.

On the Settings screen, tap **Connections** → **Data usage** → **Data saver** and tap the switch to activate it.

When the data saver feature is activated, the  icon will appear on the status bar.

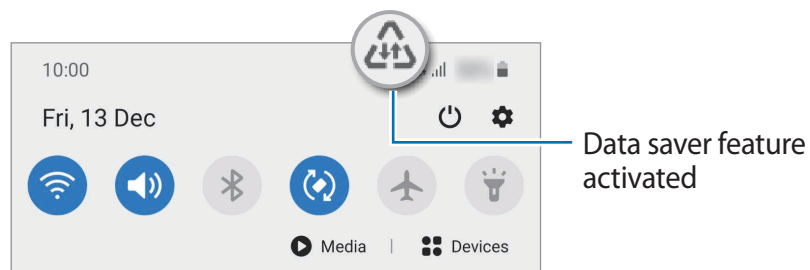

To select apps to use data without restriction, tap **Allow app while Data saver on** and select apps.

## Mobile data only apps

Select apps to always use the mobile data even when your device is connected to a Wi-Fi network.

For example, you can set the device to use only mobile data for apps that you want to keep secure or streaming apps that can be disconnected. Even if you do not deactivate the Wi-Fi feature, the apps will launch using the mobile data.

On the Settings screen, tap **Connections** → **Data usage** → **Mobile data only apps**, tap the switch to activate it, and then tap the switches next to the apps you want.



You may incur additional charges when using this feature.

## SIM card manager (dual SIM models)

Activate your eSIM or nano-SIM card and customise the SIM card settings. Refer to [Using the eSIM and nano-SIM card \(dual SIM models\)](#) for more information.

On the Settings screen, tap **Connections** → **SIM card manager**.

- **Calls:** Select the eSIM or nano-SIM card for voice calls.
- **Text messages:** Select the eSIM or nano-SIM card for messaging.
- **Mobile data:** Select the eSIM or nano-SIM card for data services.
- **Confirm SIM card for calls:** Set the device to ask to use the eSIM or nano-SIM card for the next call when you make a call without using your preferred eSIM or nano-SIM card for calls.
- **Dual SIM always on:** Set the device to allow incoming calls from the eSIM or nano-SIM card that is not being used during a call.



When this feature is enabled, you may incur additional charges for call forwarding depending on the region or service provider.



## Mobile Hotspot and Tethering

Use the device as a mobile hotspot to share the device's mobile data connection with other devices when the network connection is not available. Connections can be made via Wi-Fi, USB, or Bluetooth.

On the Settings screen, tap **Connections** → **Mobile Hotspot and Tethering**.



You may incur additional charges when using this feature.

- **Mobile Hotspot:** Use the mobile hotspot to share the device's mobile data connection with computers or other devices.
- **Bluetooth tethering:** Use Bluetooth tethering to share the device's mobile data connection with computers or other devices via Bluetooth.
- **USB tethering:** Use USB tethering to share the device's mobile data connection with a computer via USB. When connected to a computer, the device is used as a wireless modem for the computer.

### Using the mobile hotspot

Use your device as a mobile hotspot to share your device's mobile data connection with other devices.

- 1 On the Settings screen, tap **Connections** → **Mobile Hotspot and Tethering** → **Mobile Hotspot**.
- 2 Tap the switch to activate it.

The  icon appears on the status bar. Other devices can find your device in the Wi-Fi networks list.

To set a password for the mobile hotspot, tap  → **Configure Mobile Hotspot** and select the level of security. Then, enter a password and tap **Save**.

3 On the other device's screen, search for and select your device from the Wi-Fi networks list.

To connect without entering the password, tap  and scan the QR code with the other device.



If the mobile hotspot is not found, on your device, set **Band** to **2.4 GHz**, tap  → **Configure Mobile Hotspot**, and then deselect **Hide my device**.

4 On the connected device, use the device's mobile data connection to access the Internet.

### Auto Hotspot

You can share your device's mobile data connection with other devices signed in to your Samsung account without entering a password.

Tap the **Auto Hotspot** switch to activate it.

## More connection settings

Customise settings to control other connection features.

On the Settings screen, tap **Connections** → **More connection settings**.

- **Nearby device scanning:** Set the device to scan for nearby devices to connect to.
- **Printing:** Configure settings for printer plug-ins installed on the device. You can search for available printers or add one manually to print files. Refer to [Printing](#) for more information.
- **MirrorLink:** Use the MirrorLink feature to control your device's MirrorLink apps on the vehicle's head unit monitor. Refer to [MirrorLink](#) for more information.
- **VPN:** Set up virtual private networks (VPNs) on your device to connect to a school or company's private network.
- **Private DNS:** Set the device to use the security enhanced private DNS.
- **Ethernet:** When you connect an Ethernet adaptor, you can use a wired network and configure network settings.

## Printing

Configure settings for printer plug-ins installed on the device. You can connect the device to a printer via Wi-Fi or Wi-Fi Direct, and print images or documents.



Some printers may not be compatible with the device.

### Adding printer plug-ins

Add printer plug-ins for printers you want to connect the device to.

- 1 On the Settings screen, tap **Connections** → **More connection settings** → **Printing** → **Download plugin**.
- 2 Search for a printer plug-in in **Play Store**.
- 3 Select a printer plug-in and install it.
- 4 Select the installed printer plug-in.  
The device will automatically search for printers that are connected to the same Wi-Fi network as your device.
- 5 Select a printer to add.



To add printers manually, tap **⋮** → **Add printer**.

### Printing content

While viewing content, such as images or documents, access the options list, tap **Print** → ▼ → **All printers...**, and then select a printer.



Printing methods may vary depending on the content type.

## MirrorLink

You can display your device's screen on the vehicle's head unit monitor.

Connect your device to a vehicle to control your device's MirrorLink apps on the vehicle's head unit monitor.

On the Settings screen, tap **Connections** → **More connection settings** → **MirrorLink**.



Your device is compatible with vehicles that support MirrorLink version 1.1 or higher.

### Connecting your device to a vehicle via MirrorLink

When using this feature for the first time, connect the device to a Wi-Fi or mobile network.

- 1 Pair your device with a vehicle via Bluetooth.  
Refer to [Pairing with other Bluetooth devices](#) for more information.
- 2 Connect your device to the vehicle using a USB cable.  
When they are connected, access your device's MirrorLink apps on the head unit monitor.

### Ending the MirrorLink connection

Unplug the USB cable from your device and the vehicle.

## Sounds and vibration

### Options

Change settings for various sounds on the device.

On the Settings screen, tap **Sounds and vibration**.

- **Sound mode:** Set the device to use sound mode, vibration mode, or silent mode.
- **Vibrate while ringing:** Set the device to vibrate and play a ringtone for incoming calls.
- **Temporary mute:** Set the device to use silent mode for a certain period.
- **Ringtone:** Change the call ringtone.
- **Notification sound:** Change the notification sound.

- **System sound:** Change the sound to use for certain actions, such as charging the device.
- **Volume:** Adjust the device's volume level.
- **Vibration pattern:** Select a vibration pattern.
- **Vibration intensity:** Adjust the force of the vibration notification.
- **System sound/vibration control:** Set the device to sound or vibrate for actions, such as controlling the touchscreen.
- **Sound quality and effects:** Set the device's sound quality and effects. Refer to [Dolby Atmos \(surround sound\)](#) for more information.
- **Separate app sound:** Set the device to play media sound from a specific app separately on the other audio device. Refer to [Separate app sound](#) for more information.

### Dolby Atmos (surround sound)

Select a surround sound mode optimised for various types of audio, such as movies, music, and voice. With Dolby Atmos, you can experience moving audio sounds that flow all around you.

On the Settings screen, tap **Sounds and vibration** → **Sound quality and effects** → **Dolby Atmos**, tap the switch to activate it, and then select a mode.

### Separate app sound

Set the device to play media sound from a specific app on the connected Bluetooth speaker or headset separate from the sound of other apps.

For example, you can listen to the Navigation app through your device's speaker while listening to playback from the Music app through the vehicle's Bluetooth speaker.

- 1 On the Settings screen, tap **Sounds and vibration** → **Separate app sound** and tap the switch to activate it.
- 2 Select an app to play media sounds separately and tap the Back button.
- 3 Select a device for playing the selected app's media sound.

# Notifications

## Options

Change the notification settings.

On the Settings screen, tap **Notifications**.

- **Suggest actions and replies:** Set the device to suggest actions and replies for notifications.
- **Show snooze option:** Set whether to show the snooze option.
- **App icon badges:** Change the settings for app icon badges. Refer to [App icon badges](#) for more information.
- **Status bar:** Set how to display notification icons and whether to show the remaining battery percentage on the status bar.
- **Do not disturb:** Set the device to mute all sounds except for allowed exceptions.
- **Recently sent:** View the apps that received recent notifications and change the notification settings. To customise notification settings for more apps, tap **See all** → ▼ → **All** and select an app from the apps list.

## App icon badges

You can set the device to display a number or dot badge on apps that have notifications. You can also set it to display no badges.

**1** On the Settings screen, tap **Notifications** → **App icon badges** and tap the switch to activate it.

**2** Select an option under **Badge style**.

If you activate the **Notifications on app icons** feature, you can view the notification by tapping and holding the app icon.

# Display

## Options

Change the display and the Home screen settings.

On the Settings screen, tap **Display**.

- **Light / Dark:** Activate or deactivate dark mode.
- **Dark mode settings:** Reduce eye strain by applying the dark theme when using the device at night or in a dark place. Refer to [Dark mode settings](#) for more information.
- **Brightness:** Adjust the brightness of the display.
- **Adaptive brightness:** Set the device to keep track of your brightness adjustments and apply them automatically in similar lighting conditions.
- **Motion smoothness:** Change the refresh rate of the screen. When a high refresh rate is set, the screen will scroll more smoothly. Refer to [Motion smoothness](#) for more information.
- **Blue light filter:** Activate the blue light filter and change the filter settings. Refer to [Blue light filter](#) for more information.
- **Screen mode:** Change the screen mode to adjust the display's colour and contrast. Refer to [Changing the screen mode or adjusting the display colour](#) for more information.
- **Font size and style:** Change the font size and style. Refer to [Font size and style](#) for more information.
- **Screen zoom:** Change the screen zoom setting.
- **Screen resolution:** Change the screen resolution. Refer to [Screen resolution](#) for more information.
- **Full screen apps:** Select apps to use with the full screen aspect ratio. You can also set the device to hide the front camera from the screen.
- **Screen timeout:** Set the length of time the device waits before turning off the display's backlight.
- **Home screen:** Configure settings for the Home screen, such as the screen grid or layout.
- **Easy mode:** Switch to easy mode to display larger icons and apply a simpler layout to the Home screen.

- **Edge screen:** Change the settings for the Edge screen. Refer to [Edge screen](#) for more information.
- **Navigation bar:** Change the navigation bar settings. Refer to [Navigation bar \(soft buttons\)](#) for more information.
- **Accidental touch protection:** Set the device to prevent the screen from detecting touch input when it is in a dark place, such as a pocket or bag.
- **Touch sensitivity:** Increase the touch sensitivity of the screen for use with screen protectors.
- **Show charging information:** Set the device to display the remaining battery percentage and the estimated time until it is fully charged when the screen is off.
- **Screensaver:** Set the device to launch a screensaver when the device is charging. Refer to [Screensaver](#) for more information.

## Dark mode settings

Reduce eye strain by applying the dark theme when using the device at night or in a dark place.



- The dark theme may not be applied in some apps.
- You can quickly activate or deactivate dark mode on the notification panel. Open the notification panel, swipe downwards, and then tap  (**Dark mode**).

- 1 On the Settings screen, tap **Display** and tap **Dark** to activate it.
- 2 To set the schedule to apply dark mode to the screen, tap **Dark mode settings**, tap the **Turn on as scheduled** switch to activate it, and then select an option.
  - **Sunset to sunrise:** Set the device to turn on dark mode at night and turn it off in the morning based on your current location.
  - **Custom schedule:** Set a specific time to turn on and off dark mode.



## Motion smoothness

The refresh rate is the number of times the screen is refreshed every second. Use a high refresh rate to prevent the screen from flickering when switching between screens. The screen will scroll more smoothly. When you select a standard refresh rate, you can use the battery longer.

- 1 On the Settings screen, tap **Display** → **Motion smoothness**.
- 2 Select a refresh rate.
  - **High refresh rate (120 Hz):** Use a high refresh rate for the screen to switch more smoothly.
  - **Standard refresh rate (60 Hz):** Use a standard refresh rate in normal situations to conserve battery power.

## Blue light filter

Reduce eye strain by limiting the amount of blue light emitted by the screen.

- 1 On the Settings screen, tap **Display** → **Blue light filter** and tap the **Turn on now** switch to activate it.
- 2 Drag the adjustment bar to adjust the filter's opacity.
- 3 To set the schedule to apply the blue light filter to the screen, tap the **Turn on as scheduled** switch to activate it and select an option.
  - **Sunset to sunrise:** Set the device to apply the blue light filter at night and turn it off in the morning based on your current location.
  - **Custom schedule:** Set a specific time to apply the blue light filter.

## Changing the screen mode or adjusting the display colour

Change the screen mode or adjust the display colour to your preference.

### Changing the screen mode

On the Settings screen, tap **Display** → **Screen mode** and select a mode you want.

- **Vivid:** This optimises the colour range, saturation, and sharpness of your display. You can also adjust the display colour balance by colour value.
- **Natural:** This adjusts the screen to a natural tone.



- You can adjust the display colour only in **Vivid** mode.
- **Vivid** mode may not be compatible with third-party apps.
- You cannot change the screen mode while applying the blue light filter.

### Optimising the full screen colour balance

Optimise the display colour by adjusting the colour tones to your preference.

On the Settings screen, tap **Display** → **Screen mode** → **Vivid** and adjust the colour adjustment bar under **White balance**.

When you drag the colour adjustment bar towards **Cool**, the blue colour tone will increase. When you drag the bar towards **Warm**, the red colour tone will increase.

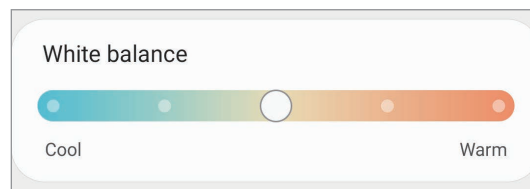

### Adjusting the screen tone by colour value

Increase or lower certain colour tones by adjusting the Red, Green, or Blue value individually.

- 1 On the Settings screen, tap **Display** → **Screen mode** → **Vivid**.
- 2 Tap **Advanced settings**.
- 3 Adjust the **R** (Red), **G** (Green), or **B** (Blue) colour bar to your preference. The screen tone will be adjusted.

## Font size and style

Change the font size and style.

- 1 On the Settings screen, tap **Display** → **Font size and style**.
- 2 Change the font style and boldness setting and drag the adjustment bar under **Font size** to change the size.

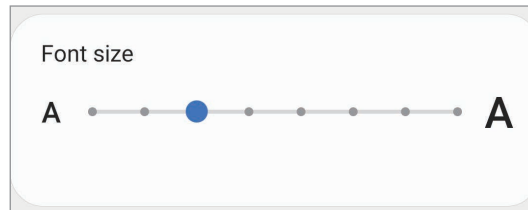

## Screen resolution

Change the screen resolution. It is set to FHD+ by default. Higher resolutions make the display more vivid, however they will consume more battery power.

- 1 On the Settings screen, tap **Display** → **Screen resolution**.
- 2 Select a resolution option and tap **Apply**.  
Some currently running apps may close when you change the resolution.

## Screensaver

You can set to display images as a screensaver when the screen turns off automatically. The screensaver will be displayed when the device is charging.

- 1 On the Settings screen, tap **Display** → **Screensaver**.
- 2 Select an option.  
If you select **Photo Frame** or **Photos**, a slideshow with selected images will start. If you select **Photo Table**, selected images will appear as small cards and overlap.
- 3 Tap  to select albums for displaying images.

4 When you are finished, tap the Back button.

To preview the selected option, tap **Preview**.



When you tap the screen while your screensaver is displayed, the screen will turn on.

## Wallpaper

Change the wallpaper settings for the Home screen and the locked screen.

On the Settings screen, tap **Wallpaper**.

## Themes

Apply various themes to the device to change the visual elements of the Home screen, locked screen, and icons.

On the Settings screen, tap **Themes**.

- **Themes:** Change the device's theme.
- **Wallpapers:** Change the wallpaper settings for the Home screen and the locked screen.
- **Icons:** Change the icon style.
- **AODs:** Select an image to display on the Always On Display.

## Lock screen

### Options

Change the settings for the locked screen.

On the Settings screen, tap **Lock screen**.



The available options may vary depending on the screen lock method selected.

- **Screen lock type:** Change the screen lock method.
- **Smart Lock:** Set the device to unlock itself when trusted locations or devices are detected. Refer to [Smart Lock](#) for more information.

- **Secure lock settings:** Change screen lock settings for the selected lock method.
- **Always On Display:** Set the device to display information while the screen is turned off. Refer to [Always On Display](#) for more information.
- **Wallpaper services:** Set the device to use wallpaper services such as Dynamic Lock screen.
- **Clock style:** Change the type and colour of the clock on the locked screen.
- **Roaming clock:** Change the clock to show both the local and home time zones on the locked screen when roaming.
- **FaceWidgets:** Change the settings of the items displayed on the locked screen.
- **Contact information:** Set the device to show contact information, such as your email address, on the locked screen.
- **Notifications:** Set how to show notifications on the locked screen.
- **Shortcuts:** Select apps to display shortcuts to them on the locked screen.
- **About Lock screen:** View the Lock screen version and legal information.

## Smart Lock

You can set the device to unlock itself and remain unlocked when trusted locations or devices are detected.

For example, if you have set your home as a trusted location, when you get home your device will detect the location and automatically unlock itself.



- This feature will be available to use after you set a screen lock method.
- If you do not use your device for four hours or when you turn on the device, you must unlock the screen using the pattern, PIN, or password you set.

- 1 On the Settings screen, tap **Lock screen** → **Smart Lock**.
- 2 Unlock the screen using the preset screen lock method.
- 3 Select an option and follow the on-screen instructions to complete the setup.

# Biometrics and security

## Options

Change the settings for securing the device.

On the Settings screen, tap **Biometrics and security**.

- **Face recognition:** Set the device to unlock the screen by recognising your face. Refer to [Face recognition](#) for more information.
- **Fingerprints:** Register your fingerprints to unlock the screen. Refer to [Fingerprint recognition](#) for more information.
- **Biometrics preferences:** Change the settings for biometric data.
- **Biometrics security patch:** View the version of the biometrics security patch and check for updates.
- **Google Play Protect:** Set the device to check for harmful apps and behaviour and warn about potential harm and remove them.
- **Find My Mobile:** Activate or deactivate the Find My Mobile feature. Access the Find My Mobile website ([findmymobile.samsung.com](https://findmymobile.samsung.com)) to track and control your lost or stolen device.
- **Security update:** View the version of your device's software and check for updates.
- **Google Play system update:** View the Google Play system version and check for updates.
- **Samsung Pass:** Verify your identity easily and securely via your biometric data. Refer to [Samsung Pass](#) for more information.
- **Samsung Blockchain Keystore:** Manage your blockchain private key safely. (Galaxy S20 Ultra 5G, S20 Ultra)
- **Install unknown apps:** Set the device to allow the installation of apps from unknown sources.
- **Secure Folder:** Create a secure folder to protect your private content and apps from others. Refer to [Secure Folder](#) for more information.
- **Secure Wi-Fi:** Set the device to protect your data while using unsecured Wi-Fi networks. Refer to [Secure Wi-Fi](#) for more information.



This feature may not be available depending on the Wi-Fi network, region, or service provider.

- **Encrypt or decrypt SD card:** Set the device to encrypt files on a memory card.
  -  If you reset your device to the factory defaults with this setting enabled, the device will not be able to read your encrypted files. Disable this setting before resetting the device.
- **Other security settings:** Configure additional security settings.

## Face recognition

You can set the device to unlock the screen by recognising your face.



- If you use your face as a screen lock method, your face cannot be used to unlock the screen for the first time after turning on the device. To use the device, you must unlock the screen using the pattern, PIN, or password you set when registering the face. Be careful not to forget your pattern, PIN, or password.
- If you change the screen lock method to **Swipe** or **None**, which are not secure, all of your biometric data will be deleted. If you want to use your biometric data in apps or features, you must register your biometric data again.



### Precautions for using face recognition

Before using the face recognition to unlock your device, keep the following precautions in mind.

- Your device could be unlocked by someone or something that looks like your image.
- Face recognition is less secure than Pattern, PIN, or Password.

### For better face recognition

Consider the following when using face recognition:

- Consider the conditions when registering, such as wearing glasses, hats, masks, beards, or heavy makeup
- Ensure that you are in a well-lit area and that the camera lens is clean when registering
- Ensure your image is not blurry for better match results

## Registering your face

For better face registration, register your face indoors and out of direct sunlight.

- 1 On the Settings screen, tap **Biometrics and security** → **Face recognition**.
- 2 Read the on-screen instructions and tap **Continue**.
- 3 Set a screen lock method.
- 4 Select whether you are wearing glasses or not and tap **Continue**.
- 5 Hold the device with the screen facing towards you and look at the screen.

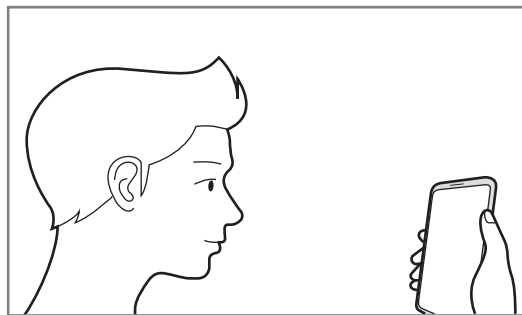

- 6 Position your face inside the frame on the screen.  
The camera will scan your face.



- If unlocking the screen with your face is not working properly, tap **Remove face data** to remove your registered face and register your face again.
- To enhance the face recognition, tap **Add alternative look** and add an alternate appearance.



## Deleting the registered face data

You can delete face data that you have registered.

- 1 On the Settings screen, tap **Biometrics and security** → **Face recognition**.
- 2 Unlock the screen using the preset screen lock method.
- 3 Tap **Remove face data** → **Remove**.

Once the registered face is deleted, all the related features will also be deactivated.

## Unlocking the screen with your face

You can unlock the screen with your face instead of using a pattern, PIN, or password.

- 1 On the Settings screen, tap **Biometrics and security** → **Face recognition**.
- 2 Unlock the screen using the preset screen lock method.
- 3 Tap the **Face unlock** switch to activate it.



- If you want to set the device to unlock the screen without swiping on the locked screen after recognising your face, tap the **Stay on Lock screen** switch to deactivate it.
- If you want to reduce the possibility of recognising faces in photos or videos, tap the **Faster recognition** switch to deactivate it. This may decrease the face recognition speed.
- If you want to set your device to recognise your face only when your eyes are open, tap the **Require open eyes** switch to activate it.
- If you want to increase the recognition rate in a dark place, tap the **Brighten screen** switch to activate it.

- 4 On the locked screen, look at the screen.

When your face is recognised, you can unlock the screen without using any additional screen lock method. If your face is not recognised, use the preset screen lock method.

## Fingerprint recognition

In order for fingerprint recognition to function, your fingerprint information needs to be registered and stored in your device. After registering, you can set the device to use your fingerprint for the features below:

- Screen lock
- Secure Folder



- This feature may not be available depending on the region or service provider.
- Fingerprint recognition uses the unique characteristics of each fingerprint to enhance the security of your device. The likelihood of the fingerprint sensor confusing two different fingerprints is very low. However, in rare cases where separate fingerprints are very similar the sensor may recognise them as identical.
- Your device comes with a screen protector attached. If you replace it, make sure the new protector allows for use of the ultrasonic fingerprint sensor. However, a screen protector may not be attached depending on the region or service provider.
- If you use your fingerprint as a screen lock method, your fingerprint cannot be used to unlock the screen for the first time after turning on the device. To use the device, you must unlock the screen using the pattern, PIN, or password you set when registering the fingerprint. Be careful not to forget your pattern, PIN, or password.
- If your fingerprint is not recognised, unlock the device using the pattern, PIN, or password you set when registering the fingerprint, and then re-register your fingerprints. If your pattern, PIN, or password is forgotten, you will not be able to use the device if you do not reset it. Samsung is not responsible for any data loss or inconvenience caused by forgotten unlock codes.
- If you change the screen lock method to **Swipe** or **None**, which are not secure, all of your biometric data will be deleted. If you want to use your biometric data in apps or features, you must register your biometric data again.

## For better fingerprint recognition

When you scan your fingerprints on the device, be aware of the following conditions that may affect the feature's performance:

- The device may not recognise fingerprints that are affected by wrinkles or scars.
- The device may not recognise fingerprints from small or thin fingers.
- To improve recognition performance, register fingerprints of the hand used most often to perform tasks on the device.
- Your device has a built-in fingerprint recognition sensor at the bottom centre of the screen. Ensure that the screen protector or the touchscreen on the fingerprint recognition sensor area is not scratched or damaged by objects, such as coins, keys, pens, and necklaces.
- Ensure that the fingerprint recognition sensor area at the bottom centre of the screen and your fingers are clean and dry.
- If you bend your finger or use a fingertip, the device may not recognise your fingerprints. Press the screen so that your fingertip spreads over the wide surface of the fingerprint recognition area.

## Registering fingerprints

- 1 On the Settings screen, tap **Biometrics and security** → **Fingerprints**.
- 2 Read the on-screen instructions and tap **Continue**.
- 3 Set a screen lock method.
- 4 Read the screen covers and protectors instructions and tap **OK**.

- 5 Place your finger on the fingerprint recognition sensor at the bottom of the screen. After the device detects your finger, lift it up and place it on the fingerprint recognition sensor again.

Repeat this action until the fingerprint is registered.

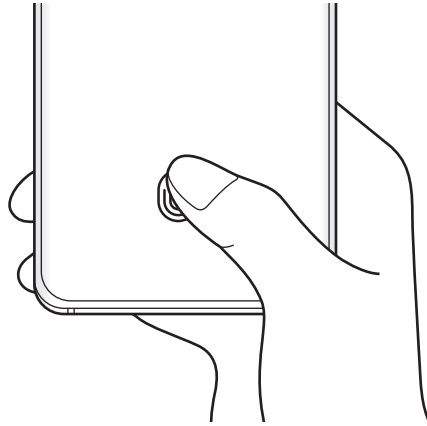

- 6 When you are finished registering your fingerprints, tap **Done**.

## Checking registered fingerprints

You can check whether your fingerprint is registered by placing your finger on the fingerprint recognition sensor.

- 1 On the Settings screen, tap **Biometrics and security** → **Fingerprints**.
- 2 Unlock the screen using the preset screen lock method.
- 3 Tap **Check added fingerprints**.
- 4 Place your finger on the fingerprint recognition sensor.  
The recognition result will be displayed.

## Deleting registered fingerprints

You can delete registered fingerprints.

- 1 On the Settings screen, tap **Biometrics and security** → **Fingerprints**.
- 2 Unlock the screen using the preset screen lock method.
- 3 Select a fingerprint to delete and tap **Remove**.

## Unlocking the screen with your fingerprints

You can unlock the screen with your fingerprint instead of using a pattern, PIN, or password.

- 1 On the Settings screen, tap **Biometrics and security** → **Fingerprints**.
- 2 Unlock the screen using the preset screen lock method.
- 3 Tap the **Fingerprint unlock** switch to activate it.
- 4 On the locked screen, place your finger on the fingerprint recognition sensor and scan your fingerprint.

## Changing the fingerprint recognition icon setting

Set the device to show or hide the fingerprint recognition icon when you tap the screen while the screen is turned off.

- 1 On the Settings screen, tap **Biometrics and security** → **Fingerprints**.
- 2 Unlock the screen using the preset screen lock method.
- 3 Tap **Show icon when screen is off** and select an option.

## Samsung Pass

Register your biometric data to Samsung Pass and easily verify your identity when using services which require your login or personal information.



- To use this feature, your device must be connected to a Wi-Fi or mobile network.
- To use this feature, you must sign in to your Samsung account. Refer to [Samsung account](#) for more information.
- The website sign-in feature is only available for websites that you access via the **Internet** app. Some websites may not support this feature.
- Registered biometric data and saved payment card information are only saved to your device and are not synced with other devices or servers.

### Registering Samsung Pass

Before using Samsung Pass, register your biometric data to Samsung Pass.

On the Settings screen, tap **Biometrics and security** → **Samsung Pass**. Follow the on-screen instructions to complete the setup.

### Verifying the Samsung account password

You can use your registered biometric data to verify your identity instead of entering your Samsung account password when, for example, you purchase content from **Galaxy Store**.

On the Samsung Pass main screen, tap  → **Settings** → **Account and syncing**, and then tap the **Verify with Samsung Pass** switch to activate it.

### Using Samsung Pass to sign in to websites

You can use Samsung Pass to easily sign in to websites that support ID and password autofill.

- 1 Open a website that you want to sign in to.
- 2 Enter your ID and password, and then tap the website's sign in button.
- 3 When a pop-up window asking whether you want to save the sign-in information appears, tick **Sign in with Samsung Pass** and tap **Remember**.

## Using Samsung Pass to sign in to apps

You can use Samsung Pass to easily sign in to apps that support ID and password autofill.

- 1 Open an app that you want to sign in to.
- 2 Enter your ID and password, and then tap the app's sign in button.
- 3 When a pop-up window asking whether you want to save the sign-in information appears, tap **Save**.

## Managing sign-in information

View the list of websites and apps you have set to use Samsung Pass and manage your sign-in information.

- 1 On the Samsung Pass main screen, tap **Sign-in** and select a website or app from the list.
- 2 Tap **Edit** and modify your ID, password, and the website's or app's name.  
To delete your sign-in information, tap **Delete**.

## Using Samsung Pass with websites and apps

When using websites or apps that support Samsung Pass, you can easily sign in with Samsung Pass.

To see the list of websites and apps that support Samsung Pass, on the Samsung Pass main screen, tap  → **Partners**. If there are no websites or apps that support Samsung Pass, **Partners** will not appear.



- Available websites and apps may vary depending on the region or service provider.
- Samsung is not responsible for any loss or inconvenience caused by signing in to websites or apps via Samsung Pass.

## Entering your personal information automatically

You can use Samsung Pass to easily enter your personal information, such as your address or payment card information, on apps that support autofill.

- 1 On the Samsung Pass main screen, tap **Autofill forms** and select an option.
- 2 Enter the information and tap **Save**.

You can now use the biometric data you registered to Samsung Pass when entering the personal information automatically on supported apps.

## Deleting your Samsung Pass data

You can delete your biometric data, sign-in information, and app data registered to Samsung Pass.



- Your agreement to the terms and conditions and your Samsung account will remain active.
- The Samsung Pass data on other devices signed in to your Samsung account will not be deleted.

- 1 On the Samsung Pass main screen, tap **⋮** → **Settings** → **Delete data**.
- 2 Enter your Samsung account password and tap **OK**.  
Your Samsung Pass data will be deleted.



## Secure Folder

Secure Folder protects your private content and apps, such as photos and contacts, from being accessed by others. You can keep your private content and apps secure even when the device is unlocked.

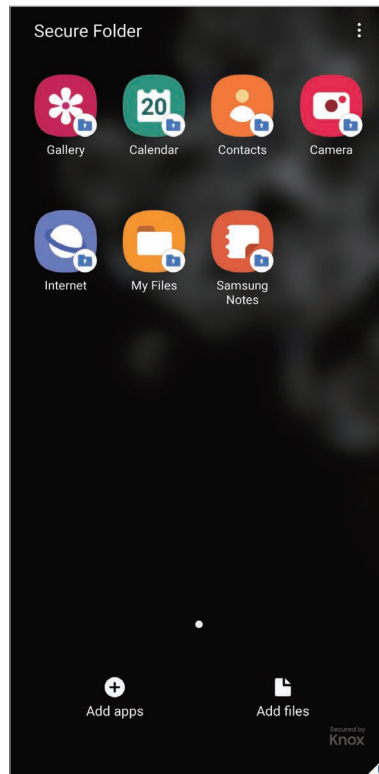

Secure Folder is a separate, secured storage area. The data in Secure Folder cannot be transferred to other devices via unapproved sharing methods, such as USB or Wi-Fi Direct. Attempting to customise the operating system or modifying software will cause Secure Folder to be automatically locked and inaccessible. Before saving data in Secure Folder, make sure to back up a copy of the data in another secure location.



To use Secure Folder, you must sign in to your Samsung account.

### Setting up Secure Folder

- 1 Launch the **Settings** app and tap **Biometrics and security** → **Secure Folder**.
- 2 Agree to the terms and conditions of Secure Folder.

3 Enter your Samsung account ID and password and tap **Sign in**.

4 Select a lock method to use for Secure Folder and follow the on-screen instructions to complete the setup.

The Secure Folder screen will appear and the Secure Folder app icon () will be added to the Apps screen.

To change the name or icon colour of Secure Folder, tap  → **Customise**.



- When you launch the **Secure Folder** app, you must unlock the app using your preset lock method.
- If you forget your Secure Folder unlock code, you can reset it using your Samsung account. Tap the button at the bottom of the locked screen, and enter your Samsung account password.

## Setting auto lock for Secure Folder

Set the device to automatically lock Secure Folder when it is not being used.

1 Launch the **Secure Folder** app and tap  → **Settings** → **Auto lock Secure Folder**.

2 Select a lock option.



To manually lock your Secure Folder, tap  → **Lock and exit**.

## Moving content to Secure Folder

Move content, such as photos and videos, to Secure Folder. The following actions are an example of moving an image from the default storage to Secure Folder.

1 Launch the **Secure Folder** app and tap **Add files**.

2 Tap **Images**, tick images to move, and then tap **Done**.

3 Tap **Move**.

The selected items will be deleted from the original folder and moved to Secure Folder. To copy items, tap **Copy**.



The method for moving content may vary depending on the content type.

## Moving content from Secure Folder

Move content from Secure Folder to the corresponding app in the default storage. The following actions are an example of moving an image from Secure Folder to the default storage.

- 1 Launch the **Secure Folder** app and tap **Gallery**.
- 2 Select an image and tap **⋮** → **Move out of Secure Folder**.  
The selected items will be moved to **Gallery** in the default storage.

## Adding apps

Add an app to use in Secure Folder.

- 1 Launch the **Secure Folder** app and tap **Add apps**.
- 2 Tick one or more apps installed on the device and tap **Add**.  
To install apps from **Play Store** or **Galaxy Store**, tap **Download from Play Store** or **Download from Galaxy Store**.

## Removing apps from Secure Folder

Tap and hold an app to delete, and tap **Uninstall**.

## Adding accounts

Add your Samsung and Google accounts, or other accounts, to sync with the apps in Secure Folder.

- 1 Launch the **Secure Folder** app and tap **⋮** → **Settings** → **Accounts** → **Add account**.
- 2 Select an account service.
- 3 Follow the on-screen instructions to complete the account setup.

## Hiding Secure Folder

You can hide the Secure Folder shortcut from the Apps screen.

Launch the **Secure Folder** app, tap  → **Settings**, and then tap the **Show icon on Apps screen** switch to deactivate it.

Alternatively, open the notification panel, swipe downwards, and then tap  (**Secure Folder**) to deactivate the feature.



## Backing up and restoring Secure Folder

Back up content and apps in Secure Folder to Samsung Cloud using your Samsung account and restore them later.

### Backing up data

- 1 Launch the **Secure Folder** app and tap  → **Settings** → **Backup and restore**.
- 2 Tap **Add account** and follow the on-screen instructions to complete signing in to your Samsung account.
- 3 Tap **Back up Secure Folder data**.
- 4 Tick items you want to back up and tap **Back up**.  
Data will be backed up to Samsung Cloud.

### Restoring data

- 1 Launch the **Secure Folder** app and tap  → **Settings** → **Backup and restore**.
- 2 Tap **Restore**.
- 3 Tap  to select a device to restore the data.
- 4 Tick items you want to restore and tap **Restore**.  
Backed up data will be restored to your device.

## Uninstalling Secure Folder

You can uninstall Secure Folder, including the content and apps in it.

Launch the **Secure Folder** app and tap  → **Settings** → **More settings** → **Uninstall**.

To back up content before uninstalling Secure Folder, tick **Move media files out of Secure Folder** and tap **Uninstall**. To access data backed up from Secure Folder, launch the **My Files** app and tap **Internal storage** → **Secure Folder**.



Notes saved in **Samsung Notes** will not be backed up.

## Secure Wi-Fi

Secure Wi-Fi is a service that secures your Wi-Fi network connection. It encrypts data using Wi-Fi networks and disables tracking apps and websites so that you can use Wi-Fi networks safely. For example, when using an unsecure Wi-Fi network in public places, such as cafes or airports, Secure Wi-Fi is automatically activated so that no one can hack your login information or monitor your activity in apps and websites.

On the Settings screen, tap **Biometrics and security** → **Secure Wi-Fi** and follow the on-screen instructions to complete the setup.

When Secure Wi-Fi is activated, the  icon will appear on the status bar.



- To use this feature, you must sign in to your Samsung account.
- Using this feature may result in a slower Wi-Fi network speed.
- This feature may not be available depending on the Wi-Fi network, region, or service provider.

## Selecting apps to protect using Secure Wi-Fi

Select apps to protect using Secure Wi-Fi so that you can safely protect data, such as your password or your activity in apps, from being accessed by others.



Some apps may not support this feature.

On the Settings screen, tap **Biometrics and security** → **Secure Wi-Fi** → **Protected apps** and tap the switches next to the apps you want to protect using Secure Wi-Fi.

## Purchasing protection plan

You are provided with a free protection plan for Wi-Fi networks every month. You can also purchase paid protection plans and have unlimited bandwidth protection for a limited time.

1 On the Settings screen, tap **Biometrics and security** → **Secure Wi-Fi**.

2 Tap **Protection plan** and select the plan you want.



For certain protection plans, you can transfer the protection plan to another device signed in to your Samsung account.

3 Follow the on-screen instructions to complete the purchase.

## Privacy

Change the settings for privacy.

On the Settings screen, tap **Privacy**.

- **Permission manager:** View the list of features and apps that have permission to use them. You can also edit the permission settings.
- **Send diagnostic data:** Set the device to automatically send the device's diagnostic and usage information to Samsung.
- **Receive marketing information:** Set whether to receive Samsung marketing information, such as special offers, membership benefits, and newsletters.
- **Samsung account privacy:** Manage personal data related to your Samsung account and change the settings for Customisation Service.
- **Advanced:** Configure advanced settings for privacy.

## Location

Change settings for location information permissions.

On the Settings screen, tap **Location**.

- **App permissions:** View the list of apps that have permission to access the device's location and edit the permission settings.
- **Improve accuracy:** Set the device to use the Wi-Fi or Bluetooth feature to increase the accuracy of your location information, even when the features are deactivated.
- **Recent location requests:** View which apps request your current location information.
- **Location services:** View the location services your device is using.

## Accounts and backup

### Options

Sync, back up, or restore your device's data using Samsung Cloud. You can also sign in to accounts, such as your Samsung account or Google account, or transfer data to or from other devices via Smart Switch.

On the Settings screen, tap **Accounts and backup**.

- **Accounts:** Add your Samsung and Google accounts, or other accounts, to sync with.
- **Backup and restore:** Keep your personal information, app data, and settings safe on your device. You can back up your sensitive information and access it later. You must sign in to your Google or Samsung account to back up or restore data.
- **Samsung Cloud:** Manage the content that you want to store securely in Samsung Cloud. Sync and back up your data and settings, and restore the previous device's data and settings even when you do not have it. Refer to [Samsung Cloud](#) for more information.
- **Smart Switch:** Launch Smart Switch and transfer data from your previous device. Refer to [Transferring data from your previous device \(Smart Switch\)](#) for more information.



Regularly back up your data to a safe location, such as Samsung Cloud or a computer, so that you can restore it if the data is corrupted or lost due to an unintended factory data reset.

## Samsung Cloud

Sync your device's data with Samsung Cloud and view the data you have synced in each app. You can also back up your device's data to Samsung Cloud and restore it later.

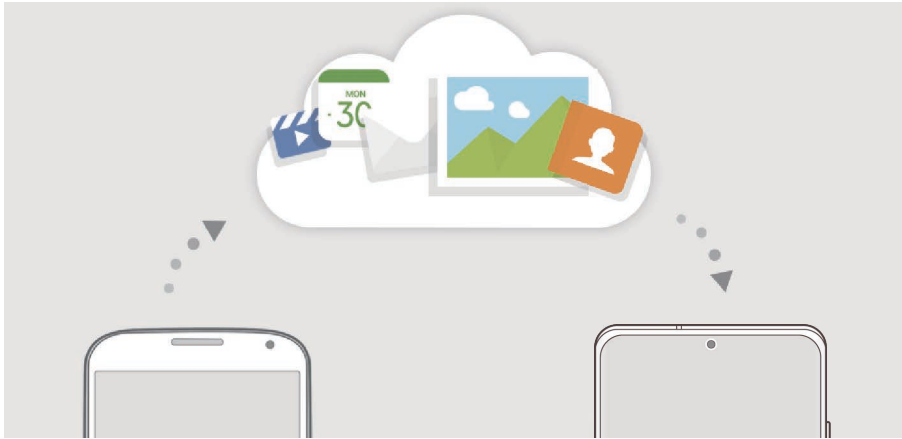

To use Samsung Cloud, you must sign in to your Samsung account.

### Syncing data

You can sync data saved in your device with Samsung Cloud and access it from other devices.

- 1 On the Settings screen, tap **Accounts and backup** → **Samsung Cloud**.
- 2 Tap **⋮** → **Settings** → **Sync and auto backup settings** → **Sync**.
- 3 Tap the switches next to the items you want to sync with.



- You can check the saved data or change the settings by tapping **Gallery**, **Other synced data**, or **Samsung Cloud Drive**.
- When you connect your Samsung account and Microsoft account, you can sync images and videos with Microsoft OneDrive.



## Backing up data

You can back up your device's data to Samsung Cloud.

- 1 On the Settings screen, tap **Accounts and backup** → **Samsung Cloud** → **Back up this phone**.
- 2 Tick items you want to back up and tap **Back up**.
- 3 Tap **Done**.



- Some data will not be backed up. To check which data will be backed up, on the Settings screen, tap **Accounts and backup** → **Samsung Cloud** → **Back up this phone**.
- To view the backup data for other devices in your Samsung Cloud, on the Settings screen, tap **Accounts and backup** → **Samsung Cloud** → **Restore data** → ▼, and then select a device you want.

## Restoring data

You can restore your backup data from Samsung Cloud to your device.

- 1 On the Settings screen, tap **Accounts and backup** → **Samsung Cloud**.
- 2 Tap **Restore data** → ▼ and select a device you want.
- 3 Tick items you want to restore and tap **Restore**.

## Google

Configure settings for some features provided by Google.

On the Settings screen, tap **Google**.

# Advanced features

## Options

Activate advanced features and change the settings that control them.

On the Settings screen, tap **Advanced features**.



Excessive shaking or an impact to the device may cause an unintended input for some features using sensors.

- **Side key:** Select an app or feature to launch using the Side key. Refer to [Setting the Side key](#) for more information.
- **Bixby Routines:** Add routines to automate settings that you use repeatedly. The device also suggests useful routines according to your frequent situations. Refer to [Bixby Routines](#) for more information.
- **Call & text on other devices:** Use your device's calling and messaging features on other devices signed in to your Samsung account.



This feature may not be available depending on the region or service provider.

- **Link to Windows:** Instantly access data saved in your device on your computer. Refer to [Link to Windows](#) for more information.
- **Smart pop-up view:** Select apps to view their notifications via pop-up windows. When using this feature, you can quickly view the contents via pop-up windows by tapping the icon on the screen.



This feature is only available in apps that support the Multi window feature.

- **Screenshots and screen recorder:** Change the settings for screenshots and screen recorder.
- **Direct share:** Set the device to display the people you contacted on the sharing options panel to allow you to share content directly.
- **Reduce animations:** Set the device to reduce the screen effects of certain actions, such as opening or closing apps.
- **Motions and gestures:** Activate the motion feature and configure settings. Refer to [Motions and gestures](#) for more information.

- **One-handed mode:** Activate one-handed operation mode for your convenience when using the device with one hand.



This feature may not be available depending on the region or service provider.

- **Game Launcher:** Activate the Game Launcher. Refer to [Game Launcher](#) for more information.
- **Dual Messenger:** Install the second app and use two separate accounts for the same messenger app. Refer to [Dual Messenger](#) for more information.
- **Video enhancer:** Enhance the image quality of your videos to enjoy brighter and more vivid colours.



This feature may not be available in some apps.

- **Send SOS messages:** Set the device to send help messages by pressing the Side key three times.

## Motions and gestures

Activate the motion feature and configure settings.

On the Settings screen, tap **Advanced features** → **Motions and gestures**.

- **Lift to wake:** Set the device to turn on the screen when you pick it up.
- **Double tap to wake:** Set the device to turn on the screen by double-tapping anywhere on the screen while the screen is turned off.
- **Smart stay:** Set the device to prevent the display from turning off while you are looking at it.
- **Smart alert:** Set the device to alert you if you have missed calls or new messages when you pick up the device.



This feature may not work if the screen is turned on or the device is not on a flat surface.

- **Easy mute:** Set the device to mute incoming calls or alarms by using palm motions or facing the device's screen downwards.

- **Palm swipe to capture:** Set the device to capture a screenshot when you swipe your hand to the left or right across the screen. You can view the captured images in **Gallery**.



It is not possible to capture a screenshot while using some apps and features.

- **Swipe to call or send messages:** Set the device to make a call or send a message when you swipe to the right or left on a contact or a phone number in the **Phone** or **Contacts** app.



## Dual Messenger

Install the second app and use two separate accounts for the same messenger app.

- 1 On the Settings screen, tap **Advanced features** → **Dual Messenger**.

Supported apps will appear.

- 2 Tap the switch of an app to install the second app.

The second app will be installed. The second app's icon will be displayed with . When you receive notifications from the second app, the notifications will be displayed with  to distinguish them from the first app's notifications.



- The Dual Messenger feature may not be available depending on the app.
- Some features of the app may be limited for the second app.

## Uninstalling a second app

- 1 On the Settings screen, tap **Advanced features** → **Dual Messenger**.

- 2 Tap the switch of the app you want to uninstall and tap **Disable** or **Uninstall**.

All data related to the second app will be deleted.



If you uninstall the first app, the second app will also be deleted.

# Digital Wellbeing and parental controls

## Options

View the history of your device usage and use features to prevent your device from interfering with your life. You can also set up parental controls for your children and manage their digital use.

On the Settings screen, tap **Digital Wellbeing and parental controls**.

- **Digital Wellbeing:** View the daily usage history of your device. Refer to [Digital Wellbeing](#) for more information.
- **Parental controls:** Manage your children's digital use.

## Digital Wellbeing

View the daily usage history of your device. You can also limit usage time or change the notification settings for each app.

On the Settings screen, tap **Digital Wellbeing and parental controls** → **Digital Wellbeing**.

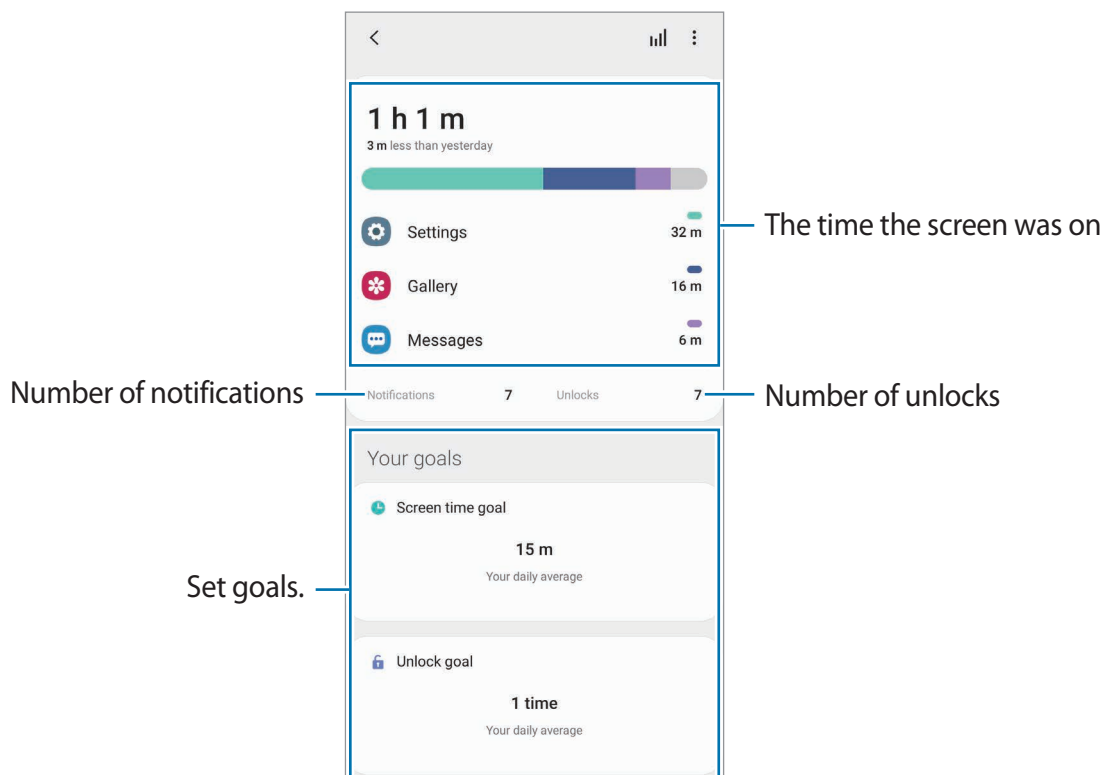

## Setting your goals

You can set goals for how long to use your device and how many times to unlock it a day.

- 1 On the Settings screen, tap **Digital Wellbeing and parental controls**.
- 2 Tap **Screen time goal** or **Unlock goal** under **Your goals**, set a goal, and then tap **Set**.

## Setting timers for apps

You can limit the daily usage time for each app by setting a timer. When you reach the limit, the app will be deactivated and you cannot use it.

- 1 On the Settings screen, tap **Digital Wellbeing and parental controls** → **App timers**.
- 2 Tap **No timer** next to the app you want and set the time.

## Using focus mode

You can activate focus mode to avoid distractions from your device and stay focused on what you want. While focus mode is on, you can only use default apps and the apps you allowed exceptions for.

On the Settings screen, tap **Digital Wellbeing and parental controls**. Then tap the mode you want to activate under **Focus mode** and tap **Start**.

## Activating wind down mode

You can activate wind down mode to reduce eye strain before sleeping and prevent your sleep from being disturbed.

- 1 On the Settings screen, tap **Digital Wellbeing and parental controls** → **Wind Down**.
- 2 To set the schedule to activate wind down mode, tap **Turn on as scheduled**, tap the switch to activate it, and then set the days and time.

# Device care

## Introduction

The device care feature provides an overview of the status of your device's battery, storage, memory, and system security. You can also automatically optimise the device with a tap of your finger.

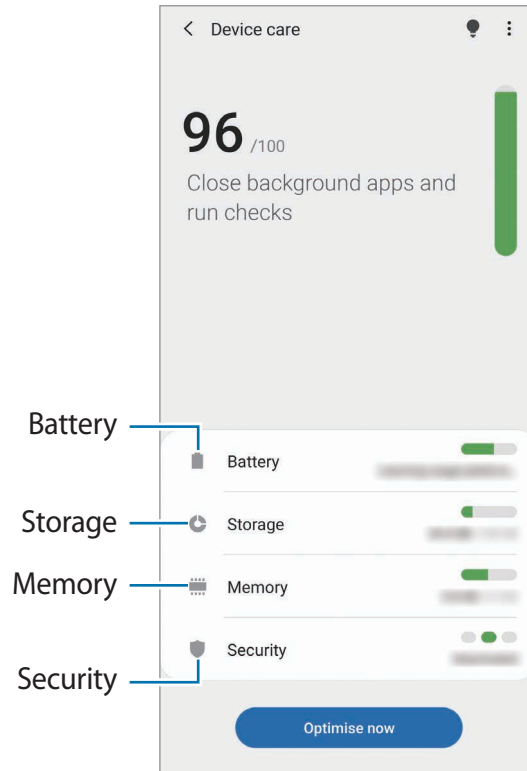

## Optimising your device

On the Settings screen, tap **Device care** → **Optimise now**.

The quick optimisation feature improves device performance through the following actions.

- Closing apps running in the background.
- Managing abnormal battery usage.
- Scanning for crashed apps and malware.

## Using the auto optimisation feature

You can set the device to perform auto optimisation when your device is not in use. Tap  → **Advanced** → **Auto optimisation** and tap the switch to activate it. If you want to set the time to perform auto optimisation, tap **Time**.

## Battery

Check the remaining battery power and time to use the device. For devices with low battery levels, conserve battery power by activating power saving features.

On the Settings screen, tap **Device care** → **Battery**.



- The usage time left shows the time remaining before the battery power runs out. Usage time left may vary depending on your device settings and operating conditions.
- You may not receive notifications from some apps that use power saving mode.

## Power mode

Select a power mode that suits your device usage purposes.

Tap **Power mode** and select an option.

- **High performance:** The screen is as bright as possible and at maximum resolution. The battery may drain quickly.
- **Optimised:** Optimised for a balance between the device's performance and battery usage.
- **Medium power saving:** Activate power saving mode to extend the battery's usage time.
- **Maximum power saving:** In maximum power saving mode, the device decreases battery consumption by activating dark mode and limiting the apps and features available. Network connections, except for the mobile network, will be deactivated.

You can set the device to charge the battery more quickly. Tap **Charging** and tap the switches next to the items you want.



## Adaptive power saving

You can set the device to activate power saving mode automatically based on your usage patterns and the remaining battery power.

Tap **Power mode** and tap the **Adaptive power saving** switch to activate it. Your device will activate power saving mode based on the situation to extend the battery's usage time.

## Putting apps to sleep

You can save battery power by preventing apps that are running in the background from using battery power when they are not being used. Tap **Battery usage**, select apps from the apps list, and then tap the **Put app to sleep** switch to activate the feature.

## Storage

Check the status of the used and available memory.

On the Settings screen, tap **Device care** → **Storage**.



- The actual available capacity of the internal memory is less than the specified capacity because the operating system and default apps occupy part of the memory. The available capacity may change when you update the device.
- You can view the available capacity of the internal memory in the Specification section for your device on the Samsung website.

## Managing the memory

To delete files or uninstall apps that you do not use any more, select a category. Then, tick items to select and tap **Delete** or **Uninstall**.

## Memory

On the Settings screen, tap **Device care** → **Memory**.

To speed up your device by stopping apps running in the background, tick apps from the apps list, and tap **Clean now**.

## Security

Check the device's security status. This feature scans your device for malware.

On the Settings screen, tap **Device care** → **Security** → **Scan phone**.

## Apps

Manage the device's apps and change their settings. You can view the apps' usage information, change their notification or permission settings, or uninstall or disable unnecessary apps.

On the Settings screen, tap **Apps**.

## General management

Customise your device's system settings or reset the device.

On the Settings screen, tap **General management**.

- **Language and input:** Select device languages and change settings, such as keyboards and voice input types. Some options may not be available depending on the selected language. Refer to [Adding device languages](#) for more information.
- **Date and time:** Access and alter the settings to control how the device displays the time and date.



If the battery remains fully discharged, the time and date is reset.

- **Contact us:** Ask questions or view frequently asked questions.
- **Reset:** Reset your device's settings or perform a factory data reset. You can reset all your settings, or only network settings, or accessibility settings. You can also set the device to restart at a preset time for device optimisation.

## Adding device languages

You can add languages to use on your device.

- 1 On the Settings screen, tap **General management** → **Language and input** → **Language** → **Add language**.

To view all the languages that can be added, tap  → **All languages**.

- 2 Select a language to add.

- 3 To set the selected language as the default language, tap **Set as default**. To keep the current language setting, tap **Keep current**.

The selected language will be added to your languages list. If you changed the default language, the selected language will be added to the top of the list.

To change the default language from your languages list, select the language you want and tap **Apply**. If an app does not support the default language, the next supported language in the list will be used.

## Accessibility

Configure various settings to improve accessibility to the device. Refer to [Accessibility](#) for more information.

On the Settings screen, tap **Accessibility**.

## Software update

Update your device's software via the firmware over-the-air (FOTA) service. You can also schedule software updates.

On the Settings screen, tap **Software update**.



If emergency software updates are released for your device's security and to block new types of security threats, they will be installed automatically without your agreement.

- **Download and install:** Check for and install updates manually.
- **Auto download over Wi-Fi:** Set the device to download updates automatically when connected to a Wi-Fi network.
- **Last update:** View information about the last software update.

## Security updates information

Security updates are provided to strengthen the security of your device and protect your personal information. For security updates for your model, visit [security.samsungmobile.com](https://security.samsungmobile.com).



The website supports only some languages.

## About phone

Access your device's information.

On the Settings screen, tap **About phone**.

To change your device's name, tap **Edit**.

- **Status:** View various device information, such as the SIM card status, Wi-Fi MAC address, and serial number.
- **Legal information:** View legal information related to the device, such as safety information and the open source licence.
- **Software information:** View the device's software information, such as its operating system version and firmware version.
- **Battery information:** View the device's battery status and information.

# Appendix

## Accessibility

### About Accessibility

Improve accessibility with features that make the device easier to use for users who have impaired vision, hearing, and reduced dexterity.

Launch the **Settings** app and tap **Accessibility**. You can check the accessibility feature you are using at the top of the screen. Tap  to view features you are currently using or tap **Turn off** to disable the features quickly.

### Voice Assistant (Voice feedback)

#### Activating or deactivating Voice Assistant

When you activate Voice Assistant, the device will start voice feedback. When you tap the selected feature once, the device will read the text on the screen aloud. Tapping the feature twice will activate the feature.

Launch the **Settings** app, tap **Accessibility** → **Screen reader**, tap the **Voice Assistant** switch, tap **Allow**, and then tap the selected area twice to activate the feature.

To deactivate Voice Assistant, tap the switch and tap anywhere on the screen twice quickly.

To view how to use Voice Assistant, tap **Tutorial**.



Some features are not available while you are using Voice Assistant.

## Controlling the screen with finger gestures

You can use various finger gestures to control the screen while you are using Voice Assistant.

### One finger gestures

- Tapping: Read aloud the item under your finger. To explore the screen, place a finger on the screen and move it on the screen.
- Tapping twice: Open the selected item. While selected items are read aloud, when you hear the item you want, release your finger from the item. Then, tap anywhere on the screen twice quickly.
- Double-tapping and holding the screen: Move an item or access an available option.
- Swiping to the left: Read the previous item.
- Swiping to the right: Read the next item.
- Swiping upwards or downwards: Change the most recent contextual menu settings.
- Swiping to the left then right in one motion: Scroll up the screen.
- Swiping to the right then left in one motion: Scroll down the screen.
- Swiping upwards then downwards in one motion: Move to the first item on the screen.
- Swiping downwards then upwards in one motion: Move to the last item on the screen.

### Two finger gestures

- Tapping twice: Start, pause, or resume the current action.
- Tapping three times: Check the current time, remaining battery power, and more. To change items that are read aloud, launch the **Settings** app and tap **Accessibility** → **Screen reader** → **Settings** → **Status bar information**.
- Tapping four times: Activate or deactivate voice feedback.
- Swiping to the left: Move to the next page.
- Swiping to the right: Return to the previous page.
- Swiping upwards: Scroll down the list.
- Swiping downwards: Scroll up the list.
- Swipe upwards or downwards on the Home screen: Open the Apps screen.
- Swipe upwards or downwards on the Apps screen: Return to the Home screen.
- Swiping in any direction on the locked screen: Unlock the screen.
- Swiping downwards from the top of the screen: Open the notification panel.

### Three finger gestures

- Tapping: Start reading items aloud from the top.
- Tapping twice: Start reading from the next item.
- Tapping three times: Read the last selected text and copy it to the clipboard.
- Swiping to the left or right: Open the contextual menu and scroll through the options.
- Swiping upwards or downwards: Change the text reading and selecting granularity.
- Swiping upwards then downwards in one motion: Return to the previous screen.
- Swiping downwards then upwards in one motion: Return to the Home screen.

### Four finger gestures

- Tapping: Return to the previous screen.
- Tapping twice: Return to the Home screen.
- Tapping three times: Open the list of recent apps.

### Using the contextual menu

While you are using Voice Assistant, swipe to the left or right with three fingers. The contextual menu will appear and the device will read the options aloud. Swipe to the left or right with three fingers to scroll through the options. When you hear the option you want, swipe upwards or downwards to use the option or adjust the settings for the option. For example, when you hear **Speech rate**, you can adjust the speech rate by swiping upwards or downwards.

### Adding and managing image labels

You can assign labels to images on the screen. The device reads aloud the labels when the images are selected. Add labels to unlabelled images by tapping the screen twice with three fingers and holding.

To manage the labels, launch the **Settings** app and tap **Accessibility** → **Screen reader** → **Settings** → **Manage custom labels**.

## Configuring settings for Voice Assistant

Configure settings for Voice Assistant for your convenience.

Launch the **Settings** app and tap **Accessibility** → **Screen reader** → **Settings**.

- **Text-to-speech:** Change the settings for text-to-speech features used when Voice Assistant is activated, such as languages, speed, and more.
- **Verbosity:** Customise the detailed settings for voice feedback.
- **Shake for continuous reading:** Set the device to read aloud the text displayed on the screen when you shake the device. You can select from various shaking intensity.
- **Speak passwords:** Set the device to read the characters aloud when you enter your password.
- **Read caller ID aloud:** Set the device to read the caller's name aloud when you have an incoming call.
- **Vibration feedback:** Set the device to vibrate when you control the screen, such as selecting an item.
- **Sound feedback:** Set the device to emit a sound when you control the screen, such as selecting an item. You can also adjust the volume of the sound played when you touch the screen to control it.
- **Focus on speech audio:** Set the device to turn the media volume down when the device reads an item aloud.
- **Focus indicator:** Set the device to thicken the border of the focus indicator that appears when you tap items. You can also change the colour of the indicator.
- **Single-tap activation:** Set the device to activate the selected item with a single tap.
- **Single-tap navigation bar:** Set the device to use the buttons on the navigation bar with a single tap.
- **Quick menu:** Select contextual menu options to display when you swipe to the left or right with three fingers.
- **Manage custom labels:** Manage the labels you added.
- **Enhanced focus:** Set the device to move the focus to the starting or previous position when changing screens.
- **Keyboard shortcuts:** Set key shortcuts to use when using an external keyboard.
- **Light sensing:** Set the device to let you know when it detects light.



- **Dark screen with Side key:** Set the device to function normally with the screen off.
- **Status bar information:** Select items to read aloud when you tap the screen three times with two fingers.
- **Developer options:** Set options for app development.

## Using the device with the screen turned off

For privacy, you can set the device to function normally with the screen off. The screen will not turn on when you press keys or tap the screen. Currently activated features do not turn off when the screen is off.

Launch the **Settings** app, tap **Accessibility** → **Screen reader** → **Settings**, and then tap the **Dark screen with Side key** switch to activate it. You can activate or deactivate this feature by pressing the Side key twice quickly.



This feature will appear only when Voice Assistant has been activated.

## Entering text using the keyboard

To display the keyboard, tap the text input field, and then tap anywhere on the screen twice quickly.

To activate the rapid key input feature, launch the **Settings** app, tap **Accessibility** → **Screen reader**, and then tap the **Quick typing** switch to activate it.

When you touch the keyboard with your finger, the device reads aloud the character keys under your finger. When you hear the character you want, release your finger from the screen to select it. The character is entered and the device reads the text aloud.

If **Quick typing** is not activated, release your finger from the character you want, and then tap anywhere on the screen twice quickly.



This feature will appear only when Voice Assistant has been activated.

## Entering additional characters

Tap and hold a key on the keyboard to enter additional characters available for the key. A pop-up window appears above the key showing available characters. To select a character, drag your finger on the pop-up window until you hear the character you want, and release it.

## Visibility enhancements

### Using the high contrast theme

Apply a clear theme that displays light-coloured content on a dark background.

Launch the **Settings** app, tap **Accessibility** → **Visibility enhancements** → **High contrast theme**, and then select a theme you want.

### Using the high contrast font

Adjust the colour and outline of fonts to increase the contrast between the text and the background.

Launch the **Settings** app, tap **Accessibility** → **Visibility enhancements**, and then tap the **High contrast fonts** switch to activate it.

### Using the high contrast keyboard

Change the colours of the Samsung keyboard to increase the contrast between the text and the background.

Launch the **Settings** app, tap **Accessibility** → **Visibility enhancements**, and then tap the **High contrast keyboard** switch to activate it.

### Displaying button shapes

Display button shapes with frames to make them stand out.

Launch the **Settings** app, tap **Accessibility** → **Visibility enhancements**, and then tap the **Show button shapes** switch to activate it.

### Reversing the display colours

Improve screen visibility to help users recognise text on the screen more easily.

Launch the **Settings** app, tap **Accessibility** → **Visibility enhancements**, and then tap the **Colour inversion** switch to activate it.

## Colour adjustment

Adjust how colours are displayed on the screen if you have difficulty in distinguishing colours. The device changes the colours into more recognisable colours.

Launch the **Settings** app, tap **Accessibility** → **Visibility enhancements** → **Colour adjustment**, and then tap the switch to activate it. Select an option.

To adjust the intensity of colour, drag the adjustment bar under **Intensity**.

If you select **Personalised colour**, you can personalise the colour of the screen. Follow the on-screen instructions to complete the colour adjustment procedure.

## Colour lens

Adjust the screen colours if you have difficulty in reading the text.

Launch the **Settings** app, tap **Accessibility** → **Visibility enhancements** → **Colour lens**, and then tap the switch to activate it. Select a colour you want.

To adjust the transparency level, drag the adjustment bar under **Opacity**.

## Reducing screen motion effects

Reduce animation effects if you are sensitive to animations or screen movement.

Launch the **Settings** app, tap **Accessibility** → **Visibility enhancements**, and then tap the **Remove animations** switch to activate it.

## Using a magnifier

Activate a magnifier to zoom in on the screen to view a larger version of the content.



Launch the **Settings** app, tap **Accessibility** → **Visibility enhancements**, and then tap the **Magnifier window** switch to activate it. The magnifier will appear on the screen.

Drag the edge of the magnifier frame to move the magnifier to where you want to zoom in on the screen.

## Magnifying the screen

Magnify the screen and zoom in on a specific area.

Launch the **Settings** app and tap **Accessibility** → **Visibility enhancements** → **Magnification**.

- **Triple tap screen to magnify:** Zoom in by tapping the screen three times. To return to the normal view, tap the screen three times again.
- **Use shortcut to magnify:** Zoom in by tapping  on the navigation bar, and then tapping where you want to magnify the screen. To return to the normal view, tap .

To explore the screen, drag two or more fingers across the magnified screen.

To adjust zoom ratio, pinch two or more fingers on the magnified screen or spread them apart.

You can also temporarily magnify the screen by tapping the screen three times and holding. Or, tap , and then tap and hold the screen. While holding the screen, drag your finger to explore the screen. Release your finger to return to the normal view.



- Keyboards and the navigation bar on the screen cannot be magnified.
- When this feature is activated, the performance of some apps may be affected.

## Enlarging mouse or touchpad pointers

Enlarge the pointer when using an external mouse or touchpad.

Launch the **Settings** app, tap **Accessibility** → **Visibility enhancements**, and then tap the **Large mouse/touchpad pointer** switch to activate it.

## Changing font

Change the font size and style.

Launch the **Settings** app and tap **Accessibility** → **Visibility enhancements** → **Font size and style**.

## Changing screen zoom

Change the screen zoom setting.

Launch the **Settings** app and tap **Accessibility** → **Visibility enhancements** → **Screen zoom**.

## Hearing enhancements

### Hearing aid support

Set the device to enhance the sound quality to work better with hearing aids.

Launch the **Settings** app, tap **Accessibility** → **Hearing enhancements** → **Hearing aid support**, and then tap the **Hearing aid compatibility** switch to activate it.

### Amplify ambient sound

Set the device to amplify the sound around you to help you hear better when using an earphone.

- 1 Launch the **Settings** app, tap **Accessibility** → **Hearing enhancements** → **Amplify ambient sound**, and then tap the switch to activate it.
- 2 Connect an earphone to the device and wear it.
- 3 Tap .

### Adapt sound

Optimise the sound setting to find the best sound quality and use it for calls or media playback.

Launch the **Settings** app, tap **Accessibility** → **Hearing enhancements** → **Adapt sound**, and then optimise the sound setting.

### Adjusting the sound balance

Set the device to adjust the sound balance when using an earphone.

- 1 Connect an earphone to the device and wear it.
- 2 Launch the **Settings** app and tap **Accessibility** → **Hearing enhancements**.
- 3 Drag the adjustment bar under **Left/right sound balance** to the left or right and adjust the sound balance.

## Mono audio

Mono output combines stereo sound into one signal that is played through all earphone speakers. Use this if you have a hearing impairment or if a single earbud is more convenient.

Launch the **Settings** app, tap **Accessibility** → **Hearing enhancements**, and then tap the **Mono audio** switch to activate it.

## Turning off all sounds

Set the device to mute all device sounds, such as media sounds, and the caller's voice during a call.

Launch the **Settings** app, tap **Accessibility** → **Hearing enhancements**, and then tap the **Mute all sounds** switch to activate it.

## Live Transcribe

Set the device to capture speech using the device's microphone and convert it to on-screen text.

Launch the **Settings** app, tap **Accessibility** → **Hearing enhancements** → **Live Transcribe**, and then tap the switch to activate it. Then, tap  to transcribe speech.

## Live Caption

Set the device to detect speech and automatically generate captions when you play media content, such as videos or podcasts.

Launch the **Settings** app, tap **Accessibility** → **Hearing enhancements** → **Live Caption**, and then tap the **Live Caption** switch to activate it.

## Caption settings

Launch the **Settings** app, tap **Accessibility** → **Hearing enhancements** → **Subtitle settings** → **Samsung subtitles (CC)** or **Google subtitles (CC)**, and then tap the switch to activate it.

Select an option for configuring the caption settings.

## Sound detectors

Set the device to detect a baby crying or your doorbell. The device will vibrate when it detects sound and the alert will be saved as a log.



While this feature is enabled, the voice recognition will not operate.

## Baby crying detector

Launch the **Settings** app and tap **Accessibility** → **Hearing enhancements** → **Sound detectors** → **Baby crying detector** → **Start**.

## Doorbell detector

- 1 Launch the **Settings** app and tap **Accessibility** → **Hearing enhancements** → **Sound detectors** → **Doorbell detector**.
- 2 Tap **Record** to make a recording of your doorbell.  
The device will detect and record the doorbell.
- 3 Tap **Test** and ring your doorbell to check if it is recorded correctly. When the device detects the doorbell sound, tap **Start**.  
To change the doorbell sound, tap **Change doorbell sound**.

## Interaction and dexterity

### Universal switch

You can control the touchscreen by connecting an external switch, by tapping the screen, or by using head movements and face gestures.

- 1 Launch the **Settings** app and tap **Accessibility** → **Interaction and dexterity** → **Universal switch**.
- 2 Read the on-screen instructions and tap **Done**.
- 3 Tap the switch to activate it.
- 4 If the universal switches are not registered on the device, tap **Add switch** and set switches to control the device.



To activate the universal switch feature, at least one switch must be registered on the device.

To set switches to control the device, tap the switch under **Switches**.

To deactivate this feature, press the Side key and the Volume Up key simultaneously.

## Assistant menu

### Displaying the assistive shortcut icon

Set the device to display the assistive shortcut icon for accessing apps, features, and settings. You can easily control the device by tapping the assistive menus in the icon.

- 1 Launch the **Settings** app and tap **Accessibility** → **Interaction and dexterity** → **Assistant menu**.
- 2 Tap the switch to activate it.  
The assistive shortcut icon appears at the bottom right of the screen.  
To adjust the assistant shortcut icon's transparency level, drag the adjustment bar under **Transparency**.

### Accessing assistive menus









The assistive shortcut icon appears as a floating icon for easy access to the assistive menus from any screen.

When you tap the assistive shortcut icon, the icon expands slightly and the assistive menus appear on the icon. Tap the left or right arrow to move to other panels or swipe to the left or right to select other menus.

### Using the cursor

On the assistive menu, tap **Cursor**. You can control the screen using small finger movements on the touch area. Drag your finger on the touch area to move the cursor. Also, tap the screen to select items under the cursor.

Use the following options:

-  /  : Scroll left or right on the screen.
-  /  : Scroll up or down the screen.
-  : Magnify the area where the cursor is located.
-  : Change the touchpad and cursor settings.
-  : Move the touch area to another location.
-  : Close the touch area.



## Using enhanced assistive menus

Set the device to display enhanced assistive menus for selected apps.

Launch the **Settings** app, tap **Accessibility** → **Interaction and dexterity** → **Assistant menu** → **Assistant plus**, and then tap the switches next to the apps you want to activate.

## Answering or ending calls

Change the method for answering or ending calls.

Launch the **Settings** app, tap **Accessibility** → **Interaction and dexterity** → **Answering and ending calls**, and then tap the switch of the method you want.

## Interaction control

Activate interaction control mode to restrict the device's reaction to inputs while using apps.

- 1 Launch the **Settings** app and tap **Accessibility** → **Interaction and dexterity** → **Interaction control**.
- 2 Tap the switch to activate it.
- 3 Press and hold the Side key and the Volume Up key simultaneously while using an app.
- 4 Adjust the size of the frame or draw a line around an area that you want to restrict.
- 5 Tap **Done**.

The device displays the restricted area. The restricted area will not react when you touch it and the device's keys will be disabled. However, you can enable functions for the Side key, Volume key, and keyboard in interaction control mode.

To deactivate interaction control mode, press and hold the Side key and the Volume Up key simultaneously.

To set the device to lock the screen after deactivating interaction control mode, launch the **Settings** app, tap **Accessibility** → **Interaction and dexterity** → **Interaction control**, and then tap the **Lock screen when deactivated** switch to activate it.

## Touch and hold delay

Set the recognition time for tapping and holding the screen.

Launch the **Settings** app, tap **Accessibility** → **Interaction and dexterity** → **Touch and hold delay**, and then select an option.

## Tap duration

Set the duration you must touch the screen for the device to recognise it as a tap.

Launch the **Settings** app, tap **Accessibility** → **Interaction and dexterity** → **Tap duration**, tap the switch to activate it, and then set the time.

## Ignore repeated touches

Set the device to recognise only the first tap within a set time when you tap the screen repeatedly.

Launch the **Settings** app, tap **Accessibility** → **Interaction and dexterity** → **Ignore repeated touches**, tap the switch to activate it, and then set the time.

## Click after pointer stops

Set the device to select an item automatically when you place the mouse pointer over the item.

Launch the **Settings** app, tap **Accessibility** → **Interaction and dexterity**, and then tap the **Click after pointer stops** switch to activate it.

## Sticky keys

Set an external keyboard's modifier key, such as the Shift, Ctrl, or Alt keys, to stay pressed. This helps you use keyboard shortcuts without pressing two keys at the same time.

Launch the **Settings** app, tap **Accessibility** → **Interaction and dexterity**, and then tap the **Sticky keys** switch to activate it.

## Slow keys

Set the recognition time for pressing a key on the external keyboard.

Launch the **Settings** app, tap **Accessibility** → **Interaction and dexterity** → **Slow keys**, tap the switch to activate it, and then set the time.

## Bounce keys

Set the device to recognise only the first time you press a key within a set time when you press the same key repeatedly.

Launch the **Settings** app, tap **Accessibility** → **Interaction and dexterity** → **Bounce keys**, tap the switch to activate it, and then set the time.

## Advanced settings

### Launching accessibility features quickly

Set to open accessibility features quickly.

Launch the **Settings** app, tap **Accessibility** → **Advanced settings** → **Side and Volume up keys**, and then tap the switch to activate it. Then, select an accessibility feature to open when you simultaneously press the Side key and the Volume Up key.

You can access the following accessibility features:

- Accessibility
- Voice Assistant
- Universal switch
- Magnifier window
- Colour inversion
- Colour adjustment
- Colour lens
- High contrast fonts
- Mute all sounds
- Interaction control

## Launching the shortcut services quickly

Set to start a shortcut service quickly.

Launch the **Settings** app, tap **Accessibility** → **Advanced settings** → **Volume up and down keys**, and then tap the switch to activate it. Then, tap **Selected service** and select a shortcut service to start when you simultaneously press and hold the Volume Up key and the Volume Down key for three seconds.

You can access the following shortcut services:

- Live Transcribe
- Your Phone Companion
- Universal switch
- Voice Assistant

## Setting light notification

Set the device to blink the flash or the screen when an alarm sounds or when you have notifications, such as incoming calls or new messages.

Launch the **Settings** app, tap **Accessibility** → **Advanced settings** → **Flash notification**, and then tap the switches next to the options you want to activate.

## Notification reminders

Set the device to alert you to notifications that you have not checked at the interval.

Launch the **Settings** app, tap **Accessibility** → **Advanced settings** → **Notification reminders**, and then tap the switch to activate it.

- **Vibrate when sound plays:** Set the device to vibrate and play a notification sound when you have unchecked notifications.
- **Remind every:** Set an interval between alerts.
- **Select apps:** Set apps to alert you to notifications.

## Time to take action

Set the amount of time to display pop-up windows that ask you to take action, such as notifications or volume controller.

Launch the **Settings** app, tap **Accessibility** → **Advanced settings** → **Time to take action**, and then select an option.

## Adding voice recordings to voice labels

You can use voice labels to distinguish objects of similar shape by attaching labels to them. You can record and assign a voice recording to an NFC-enabled voice label. The voice recording is played back when you place your device near the label.



Turn on the NFC feature before using this feature.

- 1 Launch the **Settings** app and tap **Accessibility** → **Advanced settings** → **Voice Label**.  
The voice recorder will launch.
- 2 Tap  to start recording. Speak into the microphone.
- 3 When you are finished recording, tap **Done** to stop.
- 4 Hold the back of your device over the voice label.  
The information in the voice recording will be written to the voice label.

## Bixby Vision for accessibility

When you activate the Bixby Vision accessibility features, Bixby Vision can recognise and describe scenes, text, or objects so that you can hear the related information.

Launch the **Settings** app, tap **Accessibility** → **Advanced settings** → **Bixby Vision for accessibility**, and then tap the switch to activate it.



Available features may vary depending on the region.

## Describing surrounding scenes

Analyse the scene you captured and describe it by voice.

- 1 Tap **Open Bixby Vision**.
- 2 Select  and double-tap the screen to capture the scene you want.

## Reading text or object information aloud

Recognise text or objects and describe them by voice.

- 1 Tap **Open Bixby Vision**.
- 2 Select  and keep the text or object within the screen to recognise it.

## Installed services

View accessibility services installed on the device.

Launch the **Settings** app and tap **Accessibility** → **Installed services**.

## FAQ



Some situations may not apply to your device.

### Q. I can't see the clock on the Always On Display.

A. The clock will appear when you tap the Always On Display once. If you want to set the clock to appear continuously on the Always On Display, follow the directions below.

- 1 Open the notification panel and tap **Always On Display** to view the settings.
- 2 Tap **Show always** → **Done**.

### Q. I'd like to use two apps simultaneously on the screen.

A. Use the Multi window feature. You can run two apps at the same time in the split screen view.

- 1 Tap the Recents button to open the list of recently used apps.
- 2 Tap an app's icon and tap **Open in split screen view**.
- 3 On the lower window, select another app to launch.

### Q. The light flickers at the top of the smartphone during calls. Why is that?

A. The light may flicker at the top of the smartphone due to proximity sensor operation but this is normal.

## Q. Can I connect my smartphone to a computer and use it on a large screen?

A. You can simultaneously use your smartphone and a computer by connecting them to each other.

### Method 1) Connecting with 'Link to Windows'

You can connect your device to a Windows PC to instantly access your device's data, such as photos or messages, on the computer.

When calls or messages come in, you can receive them on the computer. Refer to [Link to Windows](#) for how to connect.

### Method 2) Connecting with 'Samsung DeX'

You can connect your smartphone and a computer by launching the Samsung DeX app on the computer. Then you can accomplish tasks you want done on the smartphone on a large screen. You can also simultaneously use the smartphone while using Samsung DeX. Refer to [Connecting to a computer](#) for how to connect.

## Q. I'd like to save photos in my smartphone to a computer.

A. You can save photos in your smartphone to a computer by connecting them to each other. Use the method you want below.

### Method 1) Using a USB cable

You can connect your smartphone to a computer using a USB cable and save photos in the smartphone to the computer.

- 1 Connect your smartphone to a computer using a USB cable.
- 2 On the computer, select the removable disk.
- 3 Select a storage location for the photos.
- 4 Tap and hold a file and drag it to the computer screen.



### Method 2) Using 'Link to Windows'

You can connect your smartphone to a computer by using the same Microsoft account and save photos in the smartphone to the computer.

- 1 Connect your smartphone to a computer.  
Refer to [Connecting to a computer](#) for how to connect.
- 2 On the computer, launch the **Your Phone** app.
- 3 Tap **Photos**.
- 4 Tap and hold a file and drag it to the computer screen.

### Method 3) Using 'Samsung DeX'

You can connect your smartphone to a computer by launching the Samsung DeX app on the computer and then save photos in the smartphone to the computer.

- 1 Connect your smartphone to a computer.  
Refer to [Connecting to a computer](#) for how to connect.
- 2 On the Samsung DeX screen, tap and hold a file in the **My Files** app or the **Gallery** app and drag it to the computer screen.

## Q. How can I watch videos in my smartphone on the TV?

A. Connect your smartphone to a screen mirroring-enabled TV by using Smart View. Then you can watch videos in the smartphone on the TV.

- 1 Open the notification panel and tap  (**Smart View**).
- 2 Select a TV to connect under **Phone** → **Other device**.  
Your smartphone screen will appear on the TV.
- 3 On the smartphone, select and play the video you want.

## Q. A 'ding ding' sound keeps coming from the smartphone. How can I turn it off?

A. The NFC feature may be turned on while there is a transportation card, credit card, or access card in the smartphone cover. Open the notification panel and tap  (NFC) to deactivate it.

## Q. My smartphone is a 5G model but I'd like to use an LTE network.

A. You can use both 5G and LTE networks with a 5G model. To use an LTE network, launch the **Settings** app and tap **Connections** → **Mobile networks** → **Network mode** or **Network mode SIM 1 / Network mode SIM 2** (dual SIM models) → **LTE/3G/2G (auto connect)**.



## Q. A data usage warning notification comes.

A. If you set a data usage limit, the data usage is measured from the 1<sup>st</sup> of every month and you will receive a notification when the data usage is over the limit. You can set the limit yourself without it being relevant to the limit of your data plan.



## Q. How can I take a 108 MP photo or record an 8K video?

A. Follow the directions below to take a 108 MP photo or record an 8K video.

### Taking a 108 MP photo

- 1 Launch the **Camera** app.
- 2 On the shooting modes list, tap **PHOTO**.
- 3 In the shooting options, tap .
- 4 Select  and take a photo.

## Recording an 8K video

- 1 Launch the **Camera** app.
- 2 On the shooting modes list, tap **VIDEO**.
- 3 In the shooting options, tap .
- 4 Select  and record a video.

### Q. When zooming in on the preview screen, a square window appears on the top of the screen. What is that?

A. If the zoom ratio exceeds a certain level, the window will appear to indicate where you are zooming in on the image.

### Q. When I tap the icon in the Gallery app, some images disappear. What happened?

A. When you tap the  icon, similar images are grouped and only a preview of the images will be displayed on the list. When you tap the image preview, you can view all the images in the group.

### Q. In the Gallery app, the items I deleted moved to the recycle bin without being completely deleted. How can I delete the items in the recycle bin?

A. The items moved to the recycle bin are automatically deleted after a certain period. To delete them manually, follow the directions below.

- 1 In the **Gallery** app, tap  → **Recycle bin**.
- 2 Tap and hold an item to delete, and tap **Delete**.  
To delete all items in the recycle bin, tap **Empty**.

## Q. I'd like to change the storage location for photos. I want to save photos in the SD card.

A. You can save photos in either the internal storage or the SD card.

- 1 Launch the **Camera** app and tap  → **Storage location**.
- 2 Select a storage location.

## Q. There is something called AR ZONE in the Camera app. What is that?

A. **AR ZONE** is the app that gathers together all of the AR features, such as AR Emoji, AR Doodle, and Deco Pic, in one place. You can choose a feature and capture fun photos or videos. Refer to [AR Zone](#) for how to use it.

## Q. What can I do with my emoji?

A. You can capture fun photos or videos and also express yourself in fun ways using emoji stickers during a conversation. Refer to [AR Emoji Camera](#) or [AR Emoji Stickers](#) for more information.

## Q. How can I create an emoji?

A. You can create an emoji that looks just like you with the AR Emoji Camera. Refer to [Creating an emoji](#) for how to create an emoji.

## Q. I can't plug the cable supplied with the smartphone into a computer because both sides of the cable are not compatible with the computer. How can I connect my smartphone to a computer?

A. A USB Type-C cable is supplied with the smartphone so you can connect the smartphone to a computer that supports USB Type-C plug-ins.

For a computer that does not support USB Type-C, plug a compatible cable (sold separately) or a compatible connector (sold separately) into the computer first and then connect the smartphone to the computer.

## Q. I can't connect my previous earphones to the smartphone because it doesn't have an earphone jack. How can I connect them to each other?

A. The smartphone supports USB Type-C earphones. Use the earphones supplied with the smartphone.

To use your previous earphones, plug the earphone jack adaptor (USB Type-C to 3.5 mm) (sold separately) into the smartphone first and then connect the earphones to the smartphone.

## Q. What is the Dual Audio feature?

A. Dual Audio is a feature that allows you to connect up to two Bluetooth audio devices to your smartphone. For example, you can connect two Bluetooth headsets or speakers and use them at the same time. Refer to [Pairing with other Bluetooth devices](#) for how to connect.

## Q. What is the Music Share feature?

A. Music Share is a feature that allows you to listen to another smartphone's music via the Bluetooth speaker or headset connected to your smartphone. For example, when you are with your friend in your car and want to listen to your friend's music, use the Music Share feature. Even if you do not connect your friend's smartphone to your Bluetooth car stereo, which is already connected to your smartphone, you can listen to your friend's music via the stereo. Refer to [Music Share](#) for more information.

## Q. I forgot the password or pattern for my smartphone. What should I do to unlock the screen?

A. If a Samsung account is registered to your smartphone, you can access the Find My Mobile website ([findmymobile.samsung.com](http://findmymobile.samsung.com)) and unlock the screen remotely.

- 1 On a computer, access the Find My Mobile website ([findmymobile.samsung.com](http://findmymobile.samsung.com)).
- 2 Sign in to the Samsung account registered to your smartphone.
- 3 Tap **Unlock** and follow the on-screen instructions to unlock the screen.

## Troubleshooting

Before contacting a Samsung Service Centre, please attempt the following solutions. Some situations may not apply to your device.

### When you turn on your device or while you are using the device, it prompts you to enter one of the following codes:

- **Password:** When the device lock feature is enabled, you must enter the password you set for the device.
- **PIN:** When using the device for the first time or when the PIN requirement is enabled, you must enter the PIN supplied with the SIM or USIM card. You can disable this feature by using the Lock SIM card menu.
- **PUK:** Your SIM or USIM card is blocked, usually as a result of entering your PIN incorrectly several times. You must enter the PUK supplied by your service provider.
- **PIN2:** When you access a menu requiring the PIN2, you must enter the PIN2 supplied with the SIM or USIM card. For more information, contact your service provider.

### Your device displays network or service error messages

- When you are in areas with weak signals or poor reception, you may lose reception. Move to another area and try again. While moving, error messages may appear repeatedly.
- You cannot access some options without a subscription. For more information, contact your service provider.

### Your device does not turn on

When the battery is completely discharged, your device will not turn on. Fully charge the battery before turning on the device.

## The touchscreen responds slowly or improperly

- If you attach a screen protector or optional accessories to the touchscreen, the touchscreen may not function properly.
- If you are wearing gloves, if your hands are not clean while touching the touchscreen, or if you tap the screen with sharp objects or your fingertips, the touchscreen may malfunction.
- The touchscreen may malfunction in humid conditions or when exposed to water.
- Restart your device to clear any temporary software bugs.
- Ensure that your device software is updated to the latest version.
- If the touchscreen is scratched or damaged, visit a Samsung Service Centre.

## Your device freezes or encounters a fatal error

Try the following solutions. If the problem is still not resolved, contact a Samsung Service Centre.

### Restarting the device

If your device freezes or hangs, you may need to close apps or turn off the device and turn it on again.

### Forcing restart

If your device is frozen and unresponsive, press and hold the Side key and the Volume Down key simultaneously for more than 7 seconds to restart it.

### Resetting the device

If the methods above do not solve your problem, perform a factory data reset.

Launch the **Settings** app and tap **General management** → **Reset** → **Factory data reset** → **Reset** → **Delete all**. Before performing the factory data reset, remember to make backup copies of all important data stored in the device.

## Calls are not connected

- Ensure that you have accessed the right cellular network.
- Ensure that you have not set call barring for the phone number you are dialling.
- Ensure that you have not set call barring for the incoming phone number.

## Others cannot hear you speaking on a call

- Ensure that you are not covering the built-in microphone.
- Ensure that the microphone is close to your mouth.
- If using an earphone, ensure that it is properly connected.

## Sound echoes during a call

Adjust the volume by pressing the Volume key or move to another area.

## A cellular network or the Internet is often disconnected or audio quality is poor

- Ensure that you are not blocking the device's internal antenna.
- When you are in areas with weak signals or poor reception, you may lose reception. You may have connectivity problems due to issues with the service provider's base station. Move to another area and try again.
- When using the device while moving, wireless network services may be disabled due to issues with the service provider's network.

## The battery does not charge properly (For Samsung-approved chargers)

- Ensure that the charger is connected properly.
- Visit a Samsung Service Centre and have the battery replaced.

## The battery depletes faster than when first purchased

- When you expose the device or the battery to very cold or very hot temperatures, the useful charge may be reduced.
- Battery consumption will increase when you use certain features or apps, such as GPS, games, or the Internet.
- The battery is consumable and the useful charge will get shorter over time.



## Error messages appear when launching the camera

Your device must have sufficient available memory and battery power to operate the camera app. If you receive error messages when launching the camera, try the following:

- Charge the battery.
- Free some memory by transferring files to a computer or deleting files from your device.
- Restart the device. If you are still having trouble with the camera app after trying these tips, contact a Samsung Service Centre.

## Photo quality is poorer than the preview

- The quality of your photos may vary, depending on the surroundings and the photography techniques you use.
- If you take photos in dark areas, at night, or indoors, image noise may occur or images may be out of focus.

## Error messages appear when opening multimedia files

If you receive error messages or multimedia files do not play when you open them on your device, try the following:

- Free some memory by transferring files to a computer or deleting files from your device.
- Ensure that the music file is not Digital Rights Management (DRM)-protected. If the file is DRM-protected, ensure that you have the appropriate licence or key to play the file.
- Ensure that the file formats are supported by the device. If a file format is not supported, such as DivX or AC3, install an app that supports it. To confirm the file formats that your device supports, visit [www.samsung.com](http://www.samsung.com).
- Your device supports photos and videos captured with the device. Photos and videos captured by other devices may not work properly.
- Your device supports multimedia files that are authorised by your network service provider or providers of additional services. Some content circulated on the Internet, such as ringtones, videos, or wallpapers, may not work properly.

## Bluetooth is not working well

If another Bluetooth device is not located or there are connection problems or performance malfunctions, try the following:

- Ensure that the device you wish to connect with is ready to be scanned or connected to.
- Ensure that your device and the other Bluetooth device are within the maximum Bluetooth range (10 m).
- On your device, launch the **Settings** app, tap **Connections**, and then tap the **Bluetooth** switch to re-activate it.
- On your device, launch the **Settings** app, tap **General management** → **Reset** → **Reset network settings** → **Reset settings** → **Reset** to reset network settings. You may lose registered information when performing the reset.

If the tips above do not solve the problem, contact a Samsung Service Centre.

## A connection is not established when you connect the device to a computer

- Ensure that the USB cable you are using is compatible with your device.
- Ensure that you have the proper driver installed and updated on your computer.

## Your device cannot find your current location

GPS signals may be obstructed in some locations, such as indoors. Set the device to use Wi-Fi or a mobile network to find your current location in these situations.

## Data stored in the device has been lost

Always make backup copies of all important data stored in the device. Otherwise, you cannot restore data if it is corrupted or lost. Samsung is not responsible for the loss of data stored in the device.

## A small gap appears around the outside of the device case

- This gap is a necessary manufacturing feature and some minor rocking or vibration of parts may occur.
- Over time, friction between parts may cause this gap to expand slightly.

## There is not enough space in the device's storage

Delete unnecessary data, such as cache, using the device care feature or manually delete unused apps or files to free up storage space.

## The Home button does not appear

The navigation bar containing the Home button may disappear while using certain apps or features. To view the navigation bar, drag upwards from the bottom of the screen.

## The screen brightness adjustment bar does not appear on the notification panel

Open the notification panel by dragging the status bar downwards, and then drag the notification panel downwards. Tap  → **Quick panel layout** and tap the **Show brightness on top** switch to activate it.

## Removing the battery

- **To remove the battery, contact an authorised service centre. To obtain battery removal instructions, please visit [www.samsung.com/global/ecodesign\\_energy](http://www.samsung.com/global/ecodesign_energy).**
- For your safety, you **must not attempt to remove** the battery. If the battery is not properly removed, it may lead to damage to the battery and device, cause personal injury, and/or result in the device being unsafe.
- Samsung does not accept liability for any damage or loss (whether in contract or tort, including negligence) which may arise from failure to precisely follow these warnings and instructions, other than death or personal injury caused by Samsung's negligence.

## Copyright

Copyright © 2020 Samsung Electronics Co., Ltd.

This manual is protected under international copyright laws.

No part of this manual may be reproduced, distributed, translated, or transmitted in any form or by any means, electronic or mechanical, including photocopying, recording, or storing in any information storage and retrieval system.

## Trademarks

- SAMSUNG and the SAMSUNG logo are registered trademarks of Samsung Electronics Co., Ltd.
- Bluetooth® is a registered trademark of Bluetooth SIG, Inc. worldwide.
- Wi-Fi®, Wi-Fi Direct™, Wi-Fi CERTIFIED™, and the Wi-Fi logo are registered trademarks of the Wi-Fi Alliance.
- Manufactured under license from Dolby Laboratories. Dolby, Dolby Atmos, and the double-D symbol are trademarks of Dolby Laboratories.
- All other trademarks and copyrights are the property of their respective owners.