

Dell Latitude 3300

Service Manual

Notes, cautions, and warnings

 **NOTE:** A NOTE indicates important information that helps you make better use of your product.

 **CAUTION:** A CAUTION indicates either potential damage to hardware or loss of data and tells you how to avoid the problem.

 **WARNING:** A WARNING indicates a potential for property damage, personal injury, or death.

© 2019 Dell Inc. or its subsidiaries. All rights reserved. Dell, EMC, and other trademarks are trademarks of Dell Inc. or its subsidiaries. Other trademarks may be trademarks of their respective owners.

1 Working on your computer	6
Safety instructions.....	6
Safety Precautions.....	6
Turning off your computer.....	12
Turning off your computertablet tablet— Windows.....	12
Before working inside your computer.....	12
After working inside your computer.....	12
2 Technology and components	13
UEFI BIOS.....	13
DDR4.....	14
Memory features.....	15
Graphics options.....	15
Integrated graphics controller.....	15
Solid state drive (SSD).....	16
128/256 GB M.2 2230 PCIe SSD (Class 35).....	16
64 GB eMMC 5.1 SSD.....	17
HDMI 1.4a.....	17
Battery Specifications.....	18
USB features.....	18
USB Type-C.....	20
Media Card Readers.....	21
Software and Troubleshooting.....	21
Downloading Windows drivers.....	21
Dell Command Configure.....	22
Turning off your computer.....	24
Turning off your computertablet tablet— Windows.....	25
3 Major components of your system	26
4 Disassembly and reassembly	29
Screw List.....	29
Recommended tools.....	29
microSD card.....	30
Installing the microSD card.....	30
Removing the microSD card.....	30
Base Cover.....	30
Removing the base cover.....	30
Installing the base cover.....	32
Battery.....	34
Removing the battery.....	34
Installing the battery.....	36
Coin Cell.....	39
Removing the coin cell.....	39

Installing the coin cell.....	39
Memory Module.....	40
Removing the memory module.....	40
Installing the memory module.....	41
Solid state drive (SSD).....	42
Removing the SSD.....	42
Installing the SSD.....	42
SSD bracket.....	43
Removing the SSD bracket.....	43
Installing the SSD bracket.....	44
Keyboard.....	45
Removing the keyboard.....	45
Installing the keyboard.....	48
Touchpad.....	52
Removing the touchpad.....	52
Installing the touchpad.....	54
Speakers.....	57
Removing the speakers.....	57
Installing the speakers.....	58
I/O Daughterboard.....	60
Removing the I-O daughterboard.....	60
Installing the I-O daughterboard.....	61
Dc-in cable.....	62
Removing the DC-in cable.....	62
Installing the DC-in cable.....	63
Heat sink.....	64
Removing the heatsink.....	64
Installing the heatsink.....	65
System Fan.....	66
Removing the system fan.....	66
Installing the system fan.....	67
WLAN Card.....	68
Removing the WLAN card.....	68
Installing the WLAN card.....	69
Display assembly.....	70
Removing the display assembly.....	70
Installing the display assembly.....	72
Display bezel.....	74
Removing the display bezel.....	74
Installing the display bezel.....	76
Camera microphone module.....	78
Removing the camera-microphone module.....	78
Installing the camera-microphone module.....	78
LCD panel.....	79
Removing the LCD panel.....	79
Installing the LCD panel.....	80
eDP cable.....	82
Removing the eDP cable.....	82
Installing the eDP cable.....	83
Display hinges.....	84

Removing the display hinges.....	84
Installing the display hinges.....	85
Display back cover.....	86
System board.....	87
Removing the system board.....	87
Installing the system board.....	89
Palmrest.....	92
5 Diagnostics.....	94
Battery Status Lights.....	94
WiFi power cycle.....	94
Diagnostic LEDs.....	95
M-BIST.....	95
Self-Heal.....	96
Course Introduction.....	96
Self-Heal Instruction.....	96
Supported Latitude Models.....	96
BIOS recovery.....	97
BIOS recovery using hard drive.....	97
BIOS recovery using USB drive.....	98
LCD Built-in Self Test	98
ePSA Diagnostics.....	98
Validation Tools	101
6 Getting help.....	108
Contacting Dell.....	108

Working on your computer

Safety instructions

Use the following safety guidelines to protect your computer from potential damage and to ensure your personal safety. Unless otherwise noted, each procedure included in this document assumes that the following conditions exist:

- You have read the safety information that shipped with your computer.
- A component can be replaced or, if purchased separately, installed by performing the removal procedure in reverse order.

NOTE: Disconnect all power sources before opening the computer cover or panels. After you finish working inside the computer, replace all covers, panels, and screws before connecting to the power source.

WARNING: Before working inside your computer, read the safety information that shipped with your computer. For additional safety best practices information, see the [Regulatory Compliance Homepage](#)

CAUTION: Many repairs may only be done by a certified service technician. You should only perform troubleshooting and simple repairs as authorized in your product documentation, or as directed by the online or telephone service and support team. Damage due to servicing that is not authorized by Dell is not covered by your warranty. Read and follow the safety instructions that came with the product.

CAUTION: To avoid electrostatic discharge, ground yourself by using a wrist grounding strap or by periodically touching an unpainted metal surface at the same time as touching a connector on the back of the computer.

CAUTION: Handle components and cards with care. Do not touch the components or contacts on a card. Hold a card by its edges or by its metal mounting bracket. Hold a component such as a processor by its edges, not by its pins.

CAUTION: When you disconnect a cable, pull on its connector or on its pull-tab, not on the cable itself. Some cables have connectors with locking tabs; if you are disconnecting this type of cable, press in on the locking tabs before you disconnect the cable. As you pull connectors apart, keep them evenly aligned to avoid bending any connector pins. Also, before you connect a cable, ensure that both connectors are correctly oriented and aligned.

NOTE: The color of your computer and certain components may appear differently than shown in this document.

CAUTION: System will shut down if side covers are removed while the system is running. The system will not power on if the side cover is removed.

CAUTION: System will shut down if side covers are removed while the system is running. The system will not power on if the side cover is removed.

CAUTION: System will shut down if side covers are removed while the system is running. The system will not power on if the side cover is removed.

Safety Precautions

Follow the safety precautions described in the following sections when you perform an installation or a disassembly/reassembly procedure:

- Turn off the system and all attached peripherals.
- Disconnect the system and all attached peripherals from AC power, and then remove the battery.
- Disconnect all network cables, telephone or telecommunications lines from the system.
- Use a wrist grounding strap and mat when working inside any computer system to avoid electrostatic discharge (ESD) damage.
- After removing a system component, carefully place the removed component on an anti-static mat.
- Wear shoes with non-conductive rubber soles to help reduce the risk of being shocked or seriously injured in an electrical accident.

Standby Power

Dell products with standby power must be completely unplugged before the case is opened. Systems that incorporate standby power are essentially powered while turned off. The internal power enables the system to be remotely turned on (wake on LAN), suspended into a sleep mode, and have other advanced power management features.

After you unplug a system and before you remove components, wait approximately 30 to 45 seconds to allow the charge to drain from the circuits.

Bonding

Bonding is a method for connecting two or more grounding conductors to the same electrical potential. This is done through the use of a Field Service ESD kit. When connecting a bonding wire, always ensure that it is connected to bare metal and never to a painted or non-metal surface. The wrist strap should be secure and in full contact with your skin, and be sure to always remove all jewelry such as watches, bracelets, or rings prior to bonding yourself and the equipment.

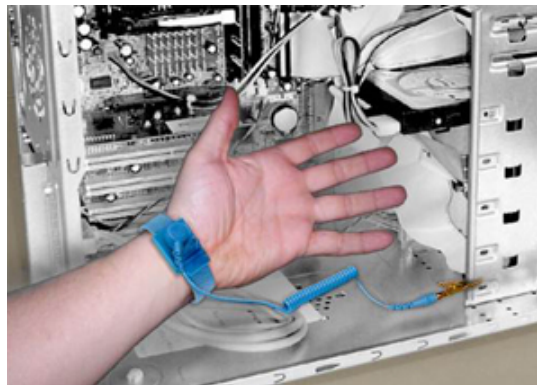

Figure 1. Bonding Properly

Electrostatic Discharge Protection

ESD is a major concern when you handle electronic components, especially sensitive components such as expansion cards, processors, memory DIMMs, and system boards. Very slight charges can damage circuits in ways that may not be obvious, such as intermittent problems or a shortened product life span. As the industry pushes for lower power requirements and increased density, ESD protection is an increasing concern.

Due to the increased density of semiconductors used in recent Dell products, the sensitivity to static damage is now higher than in earlier Dell products. For this reason some previously approved methods of handling parts are no longer applicable.

There are two recognized types of ESD damage: catastrophic and intermittent failures.

- **Catastrophic** —The damage causes an immediate and complete loss of device functionality. An example of catastrophic failure is a memory DIMM that has received a static shock and immediately generates a "No POST/No Video" symptom with a beep code emitted for missing or nonfunctional memory.

NOTE: Catastrophic failures represent approximately 20 percent of ESD-related failures.

- **Intermittent** —The DIMM receives a static shock, but the tracing is merely weakened and does not immediately produce outward symptoms related to the damage. The weakened trace may take weeks or months to melt, and in the meantime may cause degradation of memory integrity, intermittent memory errors, etc.

NOTE: Intermittent failures represent approximately 80 percent of ESD-related failures. The high rate of intermittent failures means that most of the time when damage occurs, it is not immediately recognizable.

The more difficult type of damage to recognize and troubleshoot is the intermittent (also called latent or "walking wounded") failure. The following image shows an example of intermittent damage to a memory DIMM trace. Although the damage is done, the symptoms may not become an issue or cause permanent failure symptoms for some time after the damage occurs.

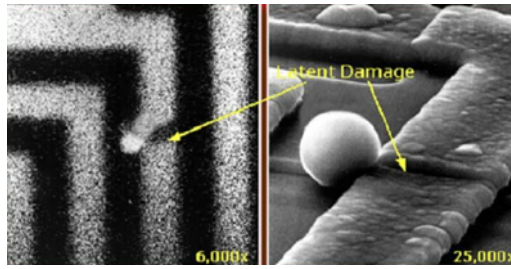

Figure 2. Intermittent (Latent) Damage to a Wiring Trace

Do the following to prevent ESD damage:

- Use a wired ESD wrist strap that is properly grounded.

The use of wireless anti-static straps is no longer allowed; they do not provide adequate protection.

Touching the chassis before handling parts does not ensure adequate ESD protection on parts with increased sensitivity to ESD damage.

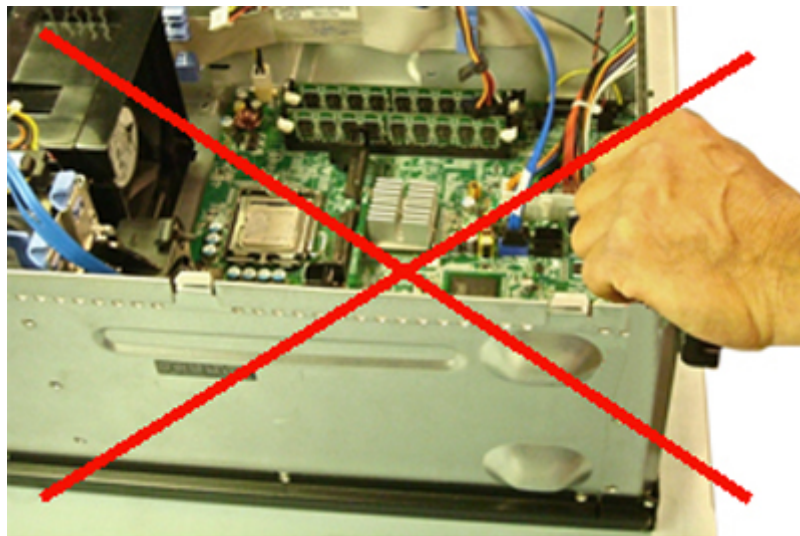

Figure 3. Chassis "Bare Metal" Grounding (Unacceptable)

- Handle all static-sensitive components in a static-safe area. If possible, use anti-static floor pads and workbench pads.
- When handling static-sensitive components, grasp them by the sides, not the top. Avoid touching pins and circuit boards.
- When unpacking a static-sensitive component from its shipping carton, do not remove the component from the anti-static packing material until you are ready to install the component. Before unwrapping the anti-static packaging, be sure to discharge static electricity from your body.
- Before transporting a static-sensitive component, place it in an anti-static container or packaging.

The ESD Field Service Kit

The unmonitored Field Service kit is the most commonly used. Each Field Service kit includes three main components: anti-static mat, wrist strap, and bonding wire.



Figure 4. ESD Field Service Kit

The anti-static mat is dissipative and should be used to safely place parts on during service procedures. When using an anti-static mat, your wrist strap should be snug and the bonding wire should be connected to the mat and to bare-metal on the system being worked on. Once deployed properly, service parts can be removed from the ESD bag and placed directly on the mat. Remember, the only safe place for ESD-sensitive items are in your hand, on the ESD mat, in the system, or inside a bag.



Figure 5. Anti-Static Mat

The wrist strap and bonding wire can be either directly connected between your wrist and bare metal on the hardware if the ESD mat is not required, or connected to the anti-static mat to protect hardware that is temporarily placed on the mat. The physical connection of the wrist strap and bonding wire between your skin, the ESD mat, and the hardware is known as bonding. Use only Field Service kits with a wrist strap, mat, and bonding wire. Never use wireless wrist straps.

Always be aware that the internal wires of a wrist strap are prone to damage from normal wear and tear, and must be checked regularly with a wrist strap tester in order to avoid accidental ESD hardware damage. It is recommended to test the wrist strap and bonding wire a minimum of once per week.

Table 1. Wrist Straps

Wrist Strap and Bonding Wire



Wireless ESD Strap (Unacceptable)



ESD Wrist Strap Tester

The wires inside of an ESD strap are prone to damage over time. When using an unmonitored kit, it is best practice to regularly test the strap prior to each service call, and at a minimum, test once per week. A wrist strap tester is the best method for doing this test. If you do not have your own wrist strap tester, check with your regional office to find out if they have one. To perform the test, plug the wrist-strap's bonding-wire into the tester while it is strapped to your wrist and push the button to test. A green LED is lit if the test is successful; a red LED is lit and an alarm sounds if the test fails.



Figure 6. Wrist Strap Tester

Insulator Elements

It is critical to keep ESD sensitive devices, such as plastic heat sink casings, away from internal parts that are insulators and often highly charged.

Table 2. Placement of Insulator Elements

Unacceptable — DIMM lying on an insulator part (plastic heat sink shroud)

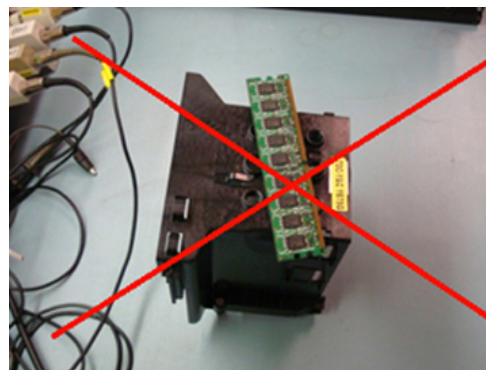

Acceptable — DIMM separated from the insulator part



Consider the Working Environment

Before deploying the ESD Field Service kit, assess the situation at the customer location. For example, deploying the kit for a server environment is different than for a desktop or portable environment. Servers are typically installed in a rack within a data center; desktops or portables are typically placed on office desks or cubicles.

Always look for a large open flat work area that is free of clutter and large enough to deploy the ESD kit with additional space to accommodate the type of system that is being repaired. The workspace should also be free of insulators that can cause an ESD event. On the work area, insulators such as Styrofoam and other plastics should always be moved at least 12 inches or 30 centimeters away from sensitive parts before physically handling any hardware components.

ESD Packaging

All ESD-sensitive devices must be shipped and received in static-safe packaging. Metal, static-shielded bags are preferred. However, you should always return the damaged part using the same ESD bag and packaging that the new part arrived in. The ESD bag should be folded over and taped shut and all the same foam packing material should be used in the original box that the new part arrived in.

ESD-sensitive devices should be removed from packaging only at an ESD-protected work surface, and parts should never be placed on top of the ESD bag because only the inside of the bag is shielded. Always place parts in your hand, on the ESD mat, in the system, or inside an anti-static bag.



Figure 7. ESD Packaging

Transporting Sensitive Components

When transporting ESD-sensitive components such as replacement parts or parts to be returned to Dell, it is critical to place these parts in anti-static bags for safe transport.

ESD Protection Summary

It is strongly suggested that all field service engineers use the traditional wired ESD grounding wrist strap and protective anti-static mat at all times when servicing Dell products. In addition, it is critical that engineers keep sensitive parts separate from all insulator parts while performing service and that they use anti-static bags for transporting sensitive components.

Lifting Equipment

NOTE: Do not lift greater than 50 pounds. Always obtain assistance from another person or persons, or use a mechanical lifting device.



Adhere to the following guidelines when lifting equipment:

1. Get a firm balanced footing. Keep your feet apart for a stable base, and point your toes out.
2. Bend your knees. Do not bend at the waist.
3. Tighten stomach muscles. Abdominal muscles support your spine when you lift, offsetting the force of the load.
4. Lift with your legs, not your back.
5. Keep the load close. The closer it is to your spine, the less force it exerts on your back.
6. Keep your back upright, whether lifting or setting down the load. Do not add the weight of your body to the load. Avoid twisting your body and back.
7. Follow the same techniques in reverse to set the load down.

Turning off your computer

Turning off your computertablet tablet— Windows

 **CAUTION:** To avoid losing data, save and close all open files and exit all open programs before you turn off your computer or remove the side cover.

1. Click or tap .
2. Click or tap  and then click or tap **Shut down**.

 **NOTE:** Ensure that the computer and all attached devices are turned off. If your computer and attached devices did not automatically turn off when you shut down your operating system, press and hold the power button for about 6 seconds to turn them off.

Before working inside your computer

1. Ensure that your work surface is flat and clean to prevent the computer cover from being scratched.
2. Turn off your computer.
3. If the computer is connected to a docking device (docked), undock it.
4. Disconnect all network cables from the computer (if available).

 **CAUTION:** If your computer has an RJ45 port, disconnect the network cable by first unplugging the cable from your computer.

5. Disconnect your computer and all attached devices from their electrical outlets.
6. Open the display.
7. Press and hold the power button for few seconds, to ground the system board.

 **CAUTION:** To guard against electrical shock unplug your computer from the electrical outlet before performing Step # 8.

 **CAUTION:** To avoid electrostatic discharge, ground yourself by using a wrist grounding strap or by periodically touching an unpainted metal surface at the same time as touching a connector on the back of the computer.

8. Remove any installed ExpressCards or Smart Cards from the appropriate slots.

After working inside your computer

After you complete any replacement procedure, ensure that you connect external devices, cards, and cables before turning on your computer.

 **CAUTION:** To avoid damage to the computer, use only the battery designed for this particular Dell computer. Do not use batteries designed for other Dell computers.

1. Connect any external devices, such as a port replicator or media base, and replace any cards, such as an ExpressCard.
2. Connect any telephone or network cables to your computer.

 **CAUTION:** To connect a network cable, first plug the cable into the network device and then plug it into the computer.

3. Connect your computer and all attached devices to their electrical outlets.
4. Turn on your computer.

Technology and components

This chapter details the technology and components available in the system.

Topics:

- [UEFI BIOS](#)
- [DDR4](#)
- [Graphics options](#)
- [Solid state drive \(SSD\)](#)
- [HDMI 1.4a](#)
- [Battery Specifications](#)
- [USB features](#)
- [USB Type-C](#)
- [Media Card Readers](#)
- [Software and Troubleshooting](#)
- [Turning off your computer](#)

UEFI BIOS

UEFI is an acronym for Unified Extensible Firmware Interface. The UEFI specification defines a new model for the interface between personal computer operating systems and platform firmware. The interface consists of data tables that contain platform related information, plus boot and runtime service calls that are available to the operating system and its loader. Together, these provide a standard environment for booting an operating system and running pre-boot applications. One of the main differences between BIOS and UEFI is the way applications are coded. Assembler was used if functions or applications had to be coded for the BIOS while a higher level language code will be used to program the UEFI.

Dell UEFI BIOS implementation will supersede the existing two different sets of BIOS in the portables and desktop products into one single UEFI BIOS moving forward.

Important Information

There is no difference in between the conventional BIOS and the UEFI BIOS unless the UEFI option is checked in the 'Boot List Option' setting in the BIOS page. This will allow the user to create a UEFI boot option list manually without affecting the existing boot priority list. With the implementation of UEFI BIOS, the changes are more related to the manufacturing tools and functionalities with very minimal impact to the customer's usages.

A few things to remember are:

- If customers have a UEFI boot media, and ONLY if they have UEFI boot media (either in the optical media or via USB storage), the one-time boot menu will show an additional section listing the UEFI boot options. Customers can view this option if they have UEFI boot media attached, and the UEFI boot option is specified manually through the 'Boot Sequence' settings.

How to change Service Tag/Owner Tag?

When the service technician replaces a system board, its required to set the service tag when the system restarts. Failure to set a service tag may result in system battery not being able to charge. Therefore, it is very important that the service technician set the correct system service tag. If a wrong service tag is set, then the technician will have to place the order for another system board replacement.

How to change Asset tag information?

To change the Asset tag information, we can use one of the following software utilities:

- Portables Technology Dell Command Configure toolkit-

Customers may also report that after a motherboard replacement, the asset field is already populated in the system BIOS, and needs to be cleared or set. For older systems and all newer systems with the UEFI BIOS platform, customers can download the Dell Command Configure Toolkit (DCC) to customize the BIOS options or even change the ownership or asset tag from within Windows.

DDR4

DDR4 (Double Data Rate fourth generation) memory is a higher-speed successor to the DDR2 and DDR3 technologies and allows up to 512 GB in capacity, compared to the DDR3's maximum of 128 GB per DIMM. DDR4 synchronous dynamic random-access memory is keyed differently from both SDRAM and DDR to prevent the user from installing the wrong type of memory into the system.

DDR4 needs 20 percent less or just 1.2 volts, compared to DDR3 which requires 1.5 volts of electrical power to operate. DDR4 also supports a new, deep power-down mode that allows the host device to go into standby without needing to refresh its memory. Deep power-down mode is expected to reduce standby power consumption by 40 to 50 percent.

DDR4 Details

There are subtle differences between DDR3 and DDR4 memory modules, as listed below:

Key notch difference

The key notch on a DDR4 module is in a different location from the key notch on a DDR3 module. Both notches are on the insertion edge but the notch location on the DDR4 is slightly different, to prevent the module from being installed into an incompatible board or platform.

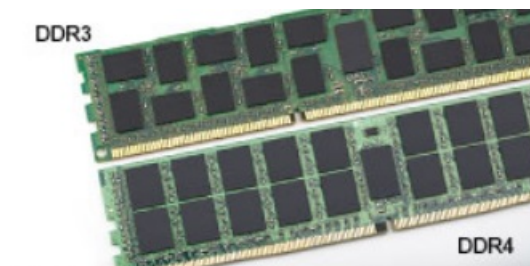

Figure 8. Notch difference

Increased thickness

DDR4 modules are slightly thicker than DDR3, to accommodate more signal layers.



Figure 9. Thickness difference

Curved edge

DDR4 modules feature a curved edge to help with insertion and alleviate stress on the PCB during memory installation.

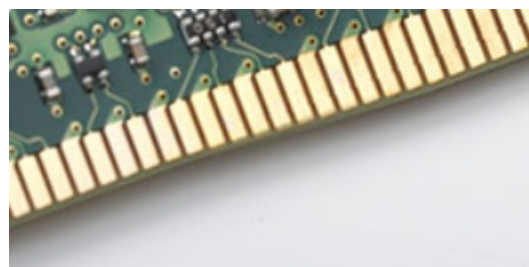

Figure 10. Curved edge

Memory Errors

Memory errors on the system display the new 2 - Amber, 3 - White failure code. If all memory fails, the LCD does not turn on. Troubleshoot for possible memory failure by trying known good memory modules in the memory connectors on the bottom of the system or under the keyboard, as in some portable systems.

Memory features

This laptop supports 4–32 GB DDR4 SDRAM memory, up to 2400 MHz on KabyLake processors and 2133 MHz on SkyLake processors.

Verifying system memory

Windows 10

1. Tap the **Windows** button and select **All Settings**  > **System**.
2. Under **System**, tap **About**.

Windows 10

1. From your desktop, start the **Charms Bar**.
2. Select **Control Panel** and then select **System**.

Windows 7

- Click **Start** → **Control Panel** → **System**.

Verifying system memory in system setup BIOS

1. Turn on or restart your system.
2. Perform the following actions after the Dell logo is displayed
 - With keyboard — Tap F2 until the Entering BIOS setup message appears. To enter the Boot selection menu, tap F12.
3. On the left pane, select **Settings** > **General** > **System Information**. The memory information is displayed on the right pane.

Testing memory using ePSA

1. Turn on or restart your system.
2. Perform one of the following actions after the Dell logo is displayed:
 - With keyboard press **F12**.
 - The system displays one time boot menu and uses up and down arrow key to go to diagnostics and press enter to launch ePSA.

The Pre Boot System Assessment (PSA) starts on your system.

 **NOTE: If you wait too long and the operating system logo be displayed, continue to wait until you see the desktop. Turn off the laptop and try again.**

 **NOTE: ePSA can alternatively be launched by pressing and holding Fn+ Press Power button.**

Graphics options

Integrated graphics controller

Table 3. Graphics specification

Integrated graphics controller specifications

Integrated Graphics Controller	Intel HD Graphics
--------------------------------	-------------------

Integrated graphics controller specifications

Model	Dell Latitude 3300
Bus Type	Internal PCIe
Memory Interface	Unified Memory Architecture
Basic Graphic frequency	Pentium 4415 U: 300 Mhz Celeron 3865 U: 300 Mhz i3-7020 U : 300 Mhz i5-8250 U : 300 Mhz
Max Graphics dynamic frequency	Pentium 4415 U: 950 Mhz Celeron 3865U : 900 Mhz i3-7020 U : 1.00 GHz i5-8250 U : 1.1 GHz
Graphics Level	Intel Celeron 3865 U: Intel HD Graphic 610 Intel Pentium 4415 U: Intel HD Graphic 610 i3-7020 U : Intel HD Graphic 620 i5-8250 U: Intel UHD Graphic 620
Estimated Maximum Power Consumption (TDP)	15 W (Total SOC power consumption)
Display Support	eDP (internal), HDMI, DisplayPort through Type-C port
Maximum Color Depth	32 bit
Maximum Vertical Refresh Rate	Up to 85 Hz depending on resolution
Operating Systems Graphics/ Video API Support	DirectX 12, OpenGL 4.4 (except OpenGL4.5 for i3-7020U)
Supported Resolutions and Max Refresh Rates (Hz) (Note: Analog and/or digital)	eDP: Panel 1366 x 768 @ 60 Hz HDMI: V1.4 @1.65 Gbps DisplayPort (via Type-C): V1.2 (Except Celeron sku)
Numbers of Displays Supported	3 max

Solid state drive (SSD)

128/256 GB M.2 2230 PCIe SSD (Class 35)

Table 4. 128/256 GB M.2 2230 PCIe SSD (Class 35)

Specifications

Capacity (GB)	128 GB/256 GB
Dimensions (W x D x H)	22 x 30 x 2.38 (mm)
Interface type and maximum speed	PCIe Gen 3 8 Gbps (up to 2 lanes)
MTBF	1.4 Mil hours

Specifications

Logical blocks	250,069,680
Power source	
Power consumption (reference only)	Idle 0.05 W, Active 4.5 W

Environmental Operating Conditions (Non-Condensing)

Temperature range	0 °C to 70 °C
Relative humidity range	10% to 90%
Op shock (@ 2ms)	1,500 G

Environmental Non-Operating Conditions (Non-Condensing)

Temperature range	- 40 °C to 70 °C
Relative humidity range	5% to 95%

64 GB eMMC 5.1 SSD

Table 5. 64 GB eMMC 5.0 SSD specifications

Specifications

Capacity (GB)	64 GB
Dimensions (W x D x H)	0.86 x 1.65 x 0.05 (inch)
Interface type and maximum speed	Upto eMMC 5.1, HS200, 200 Mbps
MTBF	1.4 Mil hours
Logical blocks	500,118,192
Power source	
Power consumption (reference only)	Idle 0.05 W, Active 4.5 W

Environmental Operating Conditions (Non-Condensing)

Temperature range	0 °C to 70 °C
Relative humidity range	5% to 95%

Environmental Non-Operating Conditions (Non-Condensing)

Temperature range	- 40 °C to 70 °C
Relative humidity range	5% to 95%

HDMI 1.4a

This topic explains the HDMI 1.4a and its features along with the advantages.

HDMI (High-Definition Multimedia Interface) is an industry-supported, uncompressed, all-digital audio/video interface. HDMI provides an interface between any compatible digital audio/video source, such as a DVD player, or A/V receiver and a compatible digital audio and/or video monitor, such as a digital TV (DTV). The primary advantage is cable reduction and content protection provisions. HDMI supports standard, enhanced, or high-definition video, plus multichannel digital audio on a single cable.

HDMI 1.4a Features

- **HDMI Ethernet Channel** - Adds high-speed networking to an HDMI link, allowing users to take full advantage of their IP-enabled devices without a separate Ethernet cable.
- **Audio Return Channel** - Allows an HDMI-connected TV with a built-in tuner to send audio data "upstream" to a surround audio system, eliminating the need for a separate audio cable.
- **3D** - Defines input/output protocols for major 3D video formats, paving the way for true 3D gaming and 3D home theater applications.
- **Content Type** - Real-time signaling of content types between display and source devices, enabling a TV to optimize picture settings based on content type.
- **Additional Color Spaces** - Adds support for additional color models used in digital photography and computer graphics.
- **4K Support** - Enables video resolutions far beyond 1080p, supporting next-generation displays that will rival the Digital Cinema systems used in many commercial movie theaters.
- **HDMI Micro Connector** - A new, smaller connector for phones and other portable devices, supporting video resolutions up to 1080p.
- **Automotive Connection System** - New cables and connectors for automotive video systems, designed to meet the unique demands of the motoring environment while delivering true HD quality.

Advantages of HDMI

- Quality HDMI transfers uncompressed digital audio and video for the highest, crispest image quality.
- Low-cost HDMI provides the quality and functionality of a digital interface while also supporting uncompressed video formats in a simple, cost-effective manner.
- Audio HDMI supports multiple audio formats from standard stereo to multichannel surround sound.
- HDMI combines video and multichannel audio into a single cable, eliminating the cost, complexity, and confusion of multiple cables currently used in A/V systems.
- HDMI supports communication between the video source (such as a DVD player) and the DTV, enabling new functionality.

Battery Specifications

What is ExpressCharge ?

For a system advertised as having the ExpressCharge feature, the battery typically will have greater than 80% charge after about an hour of charging with the system off and fully charged in about 2 hours with the system off.

Enabling Expresscharge requires that both the system and the battery that is used on the system be ExpressCharge capable. If any of the above requirements is missing, ExpressCharge will not be enabled.

What is BATTMAN?

BATTMAN is a computer controlled battery manager intended for typical rechargeable batteries. It has the following capabilities:

- Monitors self-discharge
- Measures internal resistance
- Automatically performs repeated discharge/charge cycles to break in new batteries
- Keeps a log of all operations performed, which can be imported
- Connects via parallel port to any PC running Microsoft Windows
- Operating software, complete with source code, is available to download

USB features

Universal Serial Bus, or USB, was introduced in 1996. It dramatically simplified the connection between host computers and peripheral devices like mice, keyboards, external drivers, and printers.

Table 6. USB evolution

Type	Data Transfer Rate	Category	Introduction Year
USB 2.0	480 Mbps	High Speed	2000

Type	Data Transfer Rate	Category	Introduction Year
USB 3.0/USB 3.1 Gen 1 Port	5 Gbps	SuperSpeed	2010
USB 3.1 Gen 2	10 Gbps	SuperSpeed	2013

USB 3.0/USB 3.1 Gen 1 (SuperSpeed USB)

For years, the USB 2.0 has been firmly entrenched as the de facto interface standard in the PC world with about 6 billion devices sold, and yet the need for more speed grows by ever faster computing hardware and ever greater bandwidth demands. The USB 3.0/USB 3.1 Gen 1 finally has the answer to the consumers' demands with a theoretically 10 times faster than its predecessor. In a nutshell, USB 3.1 Gen 1 features are as follows:

- Higher transfer rates (up to 5 Gbps)
- Increased maximum bus power and increased device current draw to better accommodate power-hungry devices
- New power management features
- Full-duplex data transfers and support for new transfer types
- Backward USB 2.0 compatibility
- New connectors and cable

The topics below cover some of the most commonly asked questions regarding USB 3.0/USB 3.1 Gen 1.



Speed

Currently, there are 3 speed modes defined by the latest USB 3.0/USB 3.1 Gen 1 specification. They are Super-Speed, Hi-Speed and Full-Speed. The new SuperSpeed mode has a transfer rate of 4.8 Gbps. While the specification retains Hi-Speed, and Full-Speed USB mode, commonly known as USB 2.0 and 1.1 respectively, the slower modes still operate at 480 Mbps and 12 Mbps respectively and are kept to maintain backward compatibility.

USB 3.0/USB 3.1 Gen 1 achieves the much higher performance by the technical changes below:

- An additional physical bus that is added in parallel with the existing USB 2.0 bus (refer to the picture below).
- USB 2.0 previously had four wires (power, ground, and a pair for differential data); USB 3.0/USB 3.1 Gen 1 adds four more for two pairs of differential signals (receive and transmit) for a combined total of eight connections in the connectors and cabling.
- USB 3.0/USB 3.1 Gen 1 utilizes the bidirectional data interface, rather than USB 2.0's half-duplex arrangement. This gives a 10-fold increase in theoretical bandwidth.

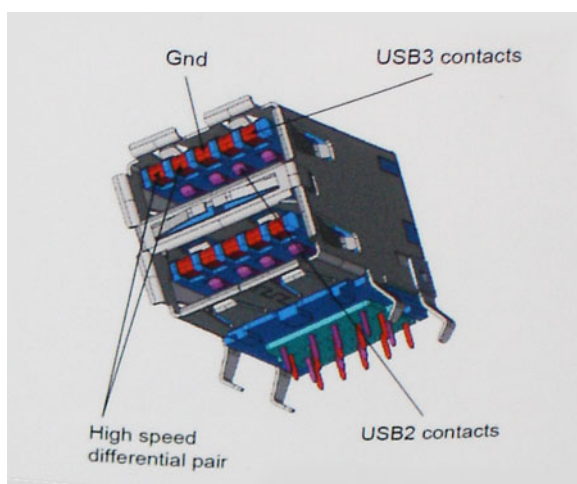

With today's ever increasing demands placed on data transfers with high-definition video content, terabyte storage devices, high megapixel count digital cameras etc., USB 2.0 may not be fast enough. Furthermore, no USB 2.0 connection could ever come close to the 480Mbps theoretical maximum throughput, making data transfer at around 320 Mbps (40 MB/s) — the actual real-world maximum.

Similarly, USB 3.0/USB 3.1 Gen 1 connections will never achieve 4.8Gbps. We will likely see a real-world maximum rate of 400MB/s with overheads. At this speed, USB 3.0/USB 3.1 Gen 1 is a 10x improvement over USB 2.0.

Applications

USB 3.0/USB 3.1 Gen 1 opens up the laneways and provides more headroom for devices to deliver a better overall experience. Where USB video was barely tolerable previously (both from a maximum resolution, latency, and video compression perspective), it's easy to imagine that with 5-10 times the bandwidth available, USB video solutions should work that much better. Single-link DVI requires almost 2Gbps throughput. Where 480Mbps was limiting, 5Gbps is more than promising. With its promised 4.8Gbps speed, the standard will find its way into some products that previously weren't USB territory, like external RAID storage systems.

Listed below are some of the available SuperSpeed USB 3.0/USB 3.1 Gen 1 products:

- External Desktop USB 3.0/USB 3.1 Gen 1 Hard Drives
- Portable USB 3.0/USB 3.1 Gen 1 Hard Drives
- USB 3.0/USB 3.1 Gen 1 Drive Docks & Adapters
- USB 3.0/USB 3.1 Gen 1 Flash Drives & Readers
- USB 3.0/USB 3.1 Gen 1 Solid-state Drives
- USB 3.0/USB 3.1 Gen 1 RAIDs
- Optical Media Drives
- Multimedia Devices
- Networking
- USB 3.0/USB 3.1 Gen 1 Adapter Cards & Hubs

Compatibility

The good news is that USB 3.0/USB 3.1 Gen 1 has been carefully planned from the start to peacefully co-exist with USB 2.0. First of all, while USB 3.0/USB 3.1 Gen 1 specifies new physical connections and thus new cables to take advantage of the higher speed capability of the new protocol, the connector itself remains the same rectangular shape with the four USB 2.0 contacts in the exact same location as before. Five new connections to carry receive and transmitted data independently are present on USB 3.0/USB 3.1 Gen 1 cables and only come into contact when connected to a proper SuperSpeed USB connection.

USB Type-C

USB Type-C is a new, tiny physical connector. The connector itself can support various exciting new USB standards like USB 3.1 and USB power delivery (USB PD).

Alternate Mode

USB Type-C is a new connector standard that is very small. It is about a third the size of an old USB Type-A plug. This is a single connector standard that every device should be able to use. USB Type-C ports can support a variety of different protocols using "alternate modes," which allows you to have adapters that can output HDMI, VGA, DisplayPort, or other types of connections from that single USB port

USB Power Delivery

The USB PD specification is also closely intertwined with USB Type-C. Currently, smartphones, tablets, and other mobile devices often use a USB connection to charge. A USB 2.0 connection provides up to 2.5 watts of power — that'll charge your phone, but that's about it. A laptop might require up to 60 watts, for example. The USB Power Delivery specification ups this power delivery to 100 watts. It's bi-directional, so a device can either send or receive power. And this power can be transferred at the same time the device is transmitting data across the connection.

This could spell the end of all those proprietary laptop charging cables, with everything charging via a standard USB connection. You could charge your laptop from one of those portable battery packs you charge your smartphones and other portable devices from today. You could plug your laptop into an external display connected to a power cable, and that external display would charge your laptop as you used it as an external display — all via the one little USB Type-C connection. To use this, the device and the cable have to support USB Power Delivery. Just having a USB Type-C connection doesn't necessarily mean they do.

USB Type-C and USB 3.1

USB 3.1 is a new USB standard. USB 3's theoretical bandwidth is 5 Gbps, while USB 3.1's is 10 Gbps. That's double the bandwidth, as fast as a first-generation Thunderbolt connector. USB Type-C isn't the same thing as USB 3.1. USB Type-C is just a connector shape, and the underlying technology could just be USB 2 or USB 3.0. In fact, Nokia's N1 Android tablet uses a USB Type-C connector, but underneath it's all USB 2.0 — not even USB 3.0. However, these technologies are closely related.

Media Card Readers

NOTE: The media card reader is integrated into the system board on portable systems. If there is a hardware failure or the reader malfunctions, replace the system board.

The media card reader expands the usefulness and functionality of portable systems, especially when used with other devices such as digital cameras, portable MP3 players, and handheld devices. All these devices use a form of media card to store information. Media card readers allow for easy transfer of data between these devices.



Several different types of media or memory cards are available today. Below is a list of the different types of cards that work in the media card reader.

SD Card Reader

1. Memory Stick
2. Secure Digital (SD)
3. Secure Digital High Capacity (SDHC)
4. Secure Digital eXtended Capacity(SDXC)

Software and Troubleshooting

Downloading Windows drivers

1. Turn on the tablet/desktop/notebook.
2. Go to **Dell.com/support**.
3. Click **Product Support**, enter the Service Tag of your tablet/desktop/notebook, and then click **Submit**.

NOTE: If you do not have the Service Tag, use the auto detect feature or manually browse for your tablet/desktop/notebook model.

4. Click **Drivers and Downloads**.
5. Select the operating system installed on your tablet/desktop/notebook.
6. Scroll down the page and select the driver to install.
7. Click **Download File** to download the driver for your tablet/desktop/notebook.
8. After the download is complete, navigate to the folder where you saved the driver file.
9. Double-click the driver file icon and follow the instructions on the screen.

Dell Command Configure

Dell Command | Configure (Command | Configure) is a packaged software offering that provides configuration capability to business client platforms. This product consists of a Command Line Interface (CLI) and Graphical User Interface (GUI) to configure various BIOS features. You can use Command | Configure on Microsoft Windows Pre-installation Environment (Windows PE), Windows 7, Windows 8, and Windows 8.1, Windows 10 operating systems, and Red Hat Enterprise Linux environments.

What's new with Dell Command | Configure

The new features for the Dell Command | Configure includes:

- Dell Client Configuration Toolkit (CCTK) is re-branded as Dell Command | Configure (DCC).
- New User Interface.
- Support for Red Hat Enterprise Linux 7.0 Client version (64-bit) operating system.
- Support for x6 client platforms
- Support for Advanced System Management (ASM) 2.0 on Dell Precision™ Workstations for setting the non-critical upper threshold values for cooling probes.
- Support for additional arguments: **medium_high** and **medium_low** for configuring the fan speed using **--fanspeed** option.
- Support for the following BIOS options:
 - --backcamera.
 - --fnlock
 - --fnlockmode
 - --gpsradio
 - --keyboardbacklightonacpower
 - --rearusb
 - --sideusb
 - --unmanagedhnic

Platforms Supported

These are the business clients platforms supported:

- Latitude™
- OptiPlex™
- Dell Precision Workstation Mobile
- Dell Precision Workstation

NOTE: Dell Command | Configure will not be pre-loaded for the customer upon purchase. Customers will be able to download the software from the Dell support website.

Command | Configure Graphical User Interface

The **Dell Command | Configure** Graphical User Interface (Command | Configure GUI) displays all Basic Input/Output System (BIOS) configurations supported by Command | Configure. Using the GUI, you can perform the following tasks:

- Create BIOS configuration for client systems
- Validate the BIOS configuration against the BIOS configuration of the host system
- Export the customized BIOS configurations as a configuration file (.ini/.cctk), Self-Contained Executable (SCE), shell script, or report

NOTE: To apply the configuration using Command Line Interface (CLI), run the required file (.ini, .cctk, or sce).

Accessing Command | Configure From a Windows System

Click **Start > All Programs > Dell > Command | Configure > Command Configure Command Wizard**.

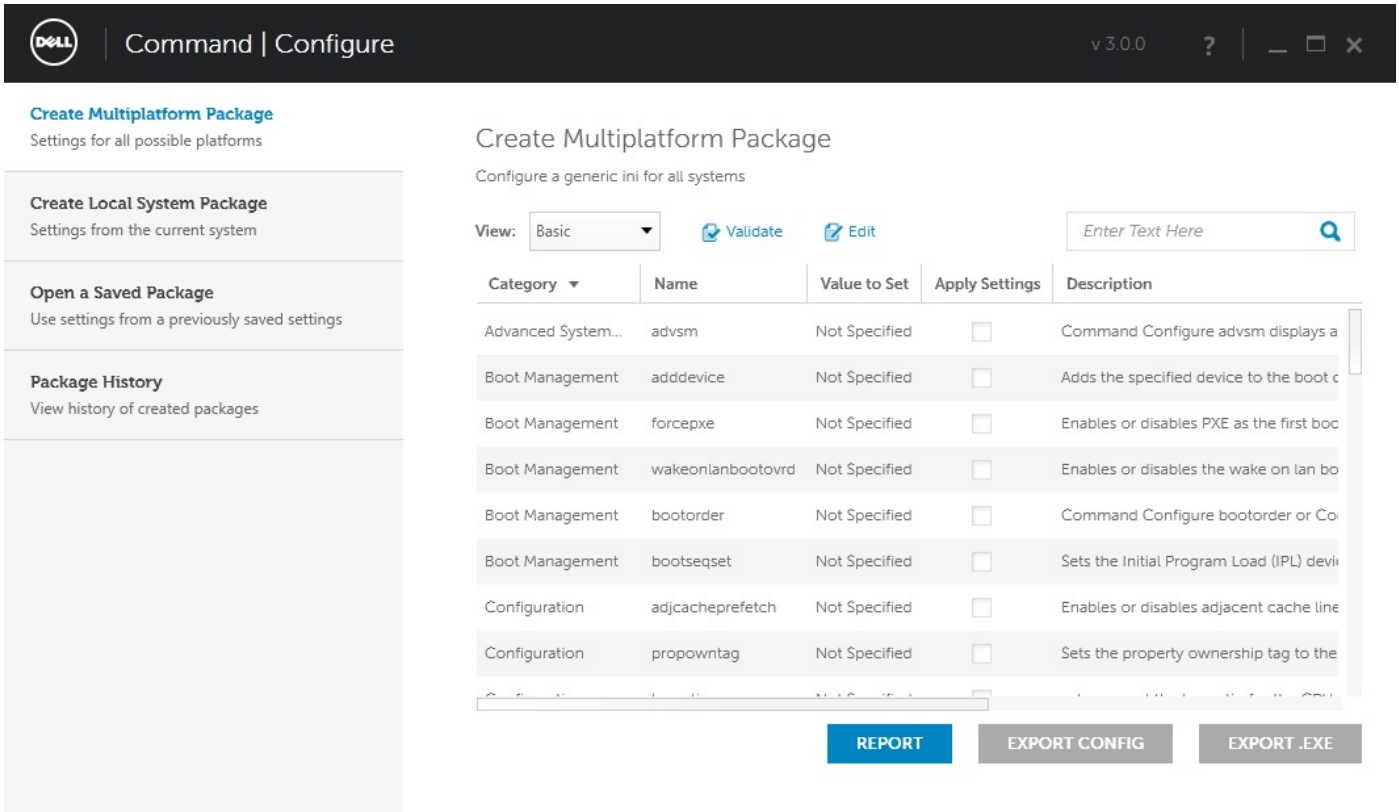

Accessing Command | Configure From a Linux System

Navigate to the `/opt/Dell/toolkit/bin` directory.

Files And Folders of Command | Configure

The following table displays the files and folders of Command | Configure on a Windows system.

Table 7. Files And Folders configuration

Files/Folders	Description
Command Configure Command Prompt	Allows access to the Command Configure command prompt.
Configuration Wizard	Allows access to the Command Configure GUI.
Command Configure WINPE	Allows access to the Windows PE scripts to create a bootable image. For more details, see the Dell Command Configure Installation Guide.
Uninstall	Uninstalls Command Configure.
User's Guide Online	Provides access to the Command Configure online documentation.

Launching The Command | Configure GUI

NOTE: The Command | Configure GUI is supported only on systems running the Windows operating system.

To launch the GUI, click **Start > All Programs > Dell > Command Configure > Configuration Wizard** or double-click the **Dell Configuration Wizard** on the desktop. The below screen appears:



Create Multiplatform Package

Settings for all possible platforms

Create Local System Package

Settings from the current system

Open a Saved Package

Use settings from a previously saved settings

Package History

View history of created packages

Create Multiplatform Package

Configure a generic ini for all systems

View: Basic ▾



Enter Text Here



Category ▾	Name	Value to Set	Apply Settings	Description
Advanced System...	advsm	Not Specified	<input type="checkbox"/>	Command Configure advsm displays a
Boot Management	adddevice	Not Specified	<input type="checkbox"/>	Adds the specified device to the boot c
Boot Management	forcepxe	Not Specified	<input type="checkbox"/>	Enables or disables PXE as the first boc
Boot Management	wakeonlanbootovrd	Not Specified	<input type="checkbox"/>	Enables or disables the wake on lan bo
Boot Management	bootorder	Not Specified	<input type="checkbox"/>	Command Configure bootorder or Co
Boot Management	bootseqset	Not Specified	<input type="checkbox"/>	Sets the Initial Program Load (IPL) devi
Configuration	adjcacheprefetch	Not Specified	<input type="checkbox"/>	Enables or disables adjacent cache line
Configuration	propowntag	Not Specified	<input type="checkbox"/>	Sets the property ownership tag to the

REPORT

EXPORT CONFIG

EXPORT .EXE

Command Line Interface

This chapter provides a general overview of the Command Line Interface (CLI) utility. It explains how to run the commands and the syntax details of the command line options used to configure BIOS settings for the client systems.

Running Command | Configure Commands

You can run the Command | Configure commands in two ways:

- Using Command Prompt
- Using Bootable Image

Command Prompt

To run Command | Configure commands:

1. Click Start → All Program → Dell → Command Configure → Command Configure Command Prompt.
2. Navigate to the x86 or x86_64 directory depending on the architecture of the operating system.
3. Run the Command | Configure commands.

Bootable Image



To run Command | Configure commands:

1. Copy Dell Command | Configure with the International Organization for Standardization (ISO) image to a Compact Disc (CD). For more information, see Dell Command | Configure Installation Guide.
2. Boot the system that you want to configure from the CD.
3. Navigate to the Command Configure\x86 or Command Configure\x86_64 directory.
4. Run the Command | Configure commands.

Turning off your computer

Turning off your computertablet tablet— Windows

 **CAUTION:** To avoid losing data, save and close all open files and exit all open programs before you turn off your computer or remove the side cover.

1. Click or tap .
2. Click or tap  and then click or tap **Shut down**.

 **NOTE:** Ensure that the computer and all attached devices are turned off. If your computer and attached devices did not automatically turn off when you shut down your operating system, press and hold the power button for about 6 seconds to turn them off.

Major components of your system

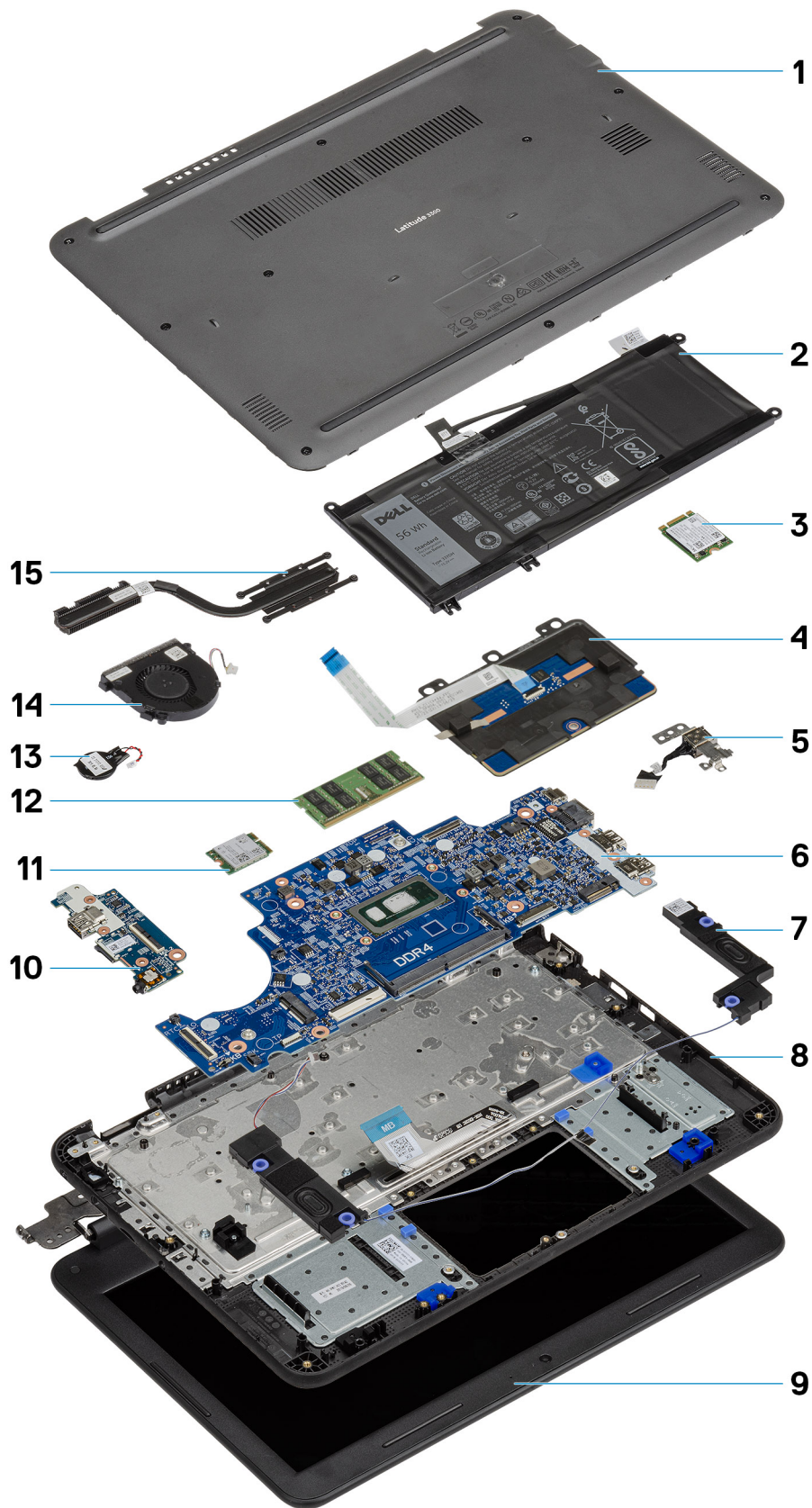

1. Base Cover
2. Battery
3. Solid state drive
4. Touchpad
5. DC-in cable
6. System board
7. Speakers
8. Palmrest
9. Display assembly
10. I-O Daughterboard
11. WLAN Card
12. Memory Module
13. Coin Cell
14. System Fan
15. Heatsink







i **NOTE:** Dell provides a list of components and their part numbers for the original system configuration purchased. These parts are available according to warranty coverages purchased by the customer. Contact your Dell sales representative for purchase options.

Disassembly and reassembly

Screw List

The following table shows the screw list and the images for Latitude 3300, for different components and locations.

Table 8. Screw Size List

Component	Quantity	Screw type	Image
<ul style="list-style-type: none"> · Touchpad Frame to palmrest · 3 · System board to Palmrest · 2 · I/O Board to palmrest · 1 		M2.0*2.0	
<ul style="list-style-type: none"> · LCD Panel to back cover · 4 · Touchpad Frame to palmrest · 3 · Mis trigger Bkt to SSD Bracket · 2 		M2.0*3.0	
Hinges to LCD back cover	4	M2.5*3.5	
Touchpad to Palmrest	3	M2.0*3.0 (large head)	
Hinges to palmrest	6	M2.5*5.0	
<ul style="list-style-type: none"> · LCD Bezel to back Cover · 2 · Fan to Palmrest · 2 · DC-in Bracket to MB · 1 · I/O Board to palmrest · 1 · System board to Palmrest · 1 · Mis trigger Bkt to SSD · 1 		M2.0*4.0	
Base cover to Palmrest	10	M2.5*8.0	Captive screws (Part of the base cover)

Recommended tools

The procedures in this document require the following tools:

- Phillips #0 screwdriver
- Phillips #1 screwdriver
- Plastic scribe

NOTE: The #0 screw driver is for screws 0-1 and the #1 screw driver is for screws 2-4.



microSD card

Installing the microSD card

Slide the microSD card into its slot until it clicks into place.

Removing the microSD card

1. Press in on the microSD card to release it from the computer.



2. Remove the microSD card from the computer.

Base Cover

Removing the base cover

1. Follow the procedure in [Before working inside your computer](#).
2. Remove the:
 - a) [microSD card](#)
3. Loosen the 10 'M2.5xL8.5' captive screws that secure the base cover to the computer.

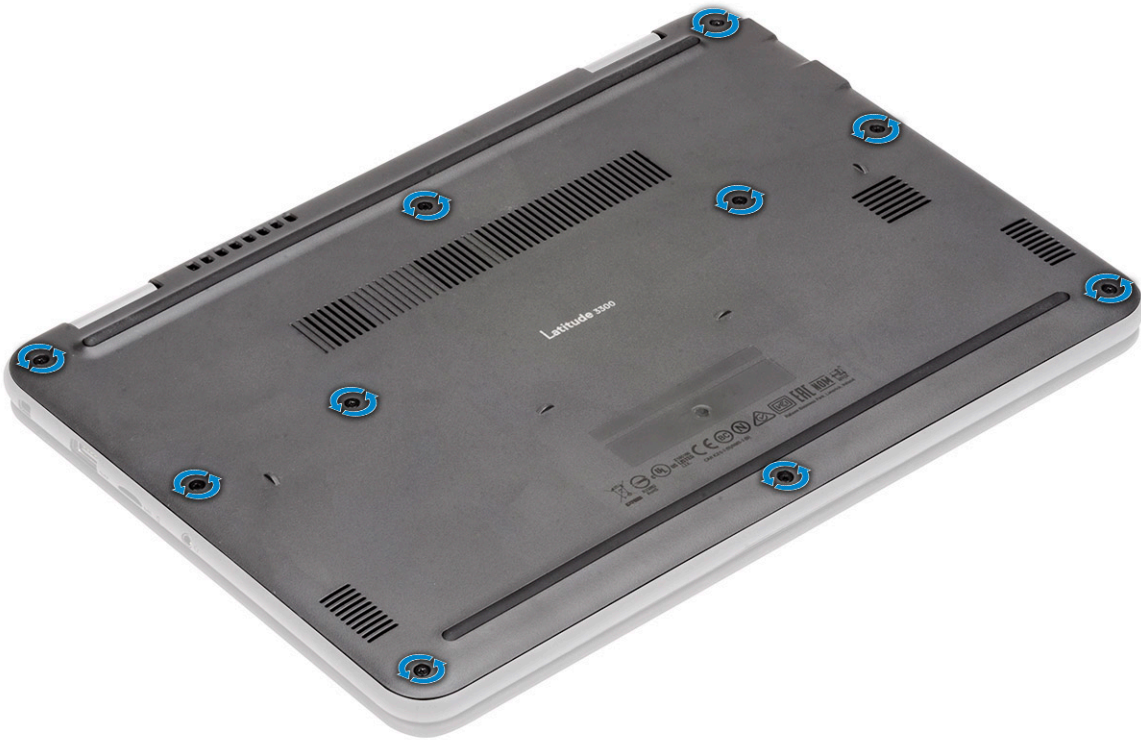

4. Use a plastic scribe [1] to pry the base cover along the edges [2] to separate the base cover from the computer.

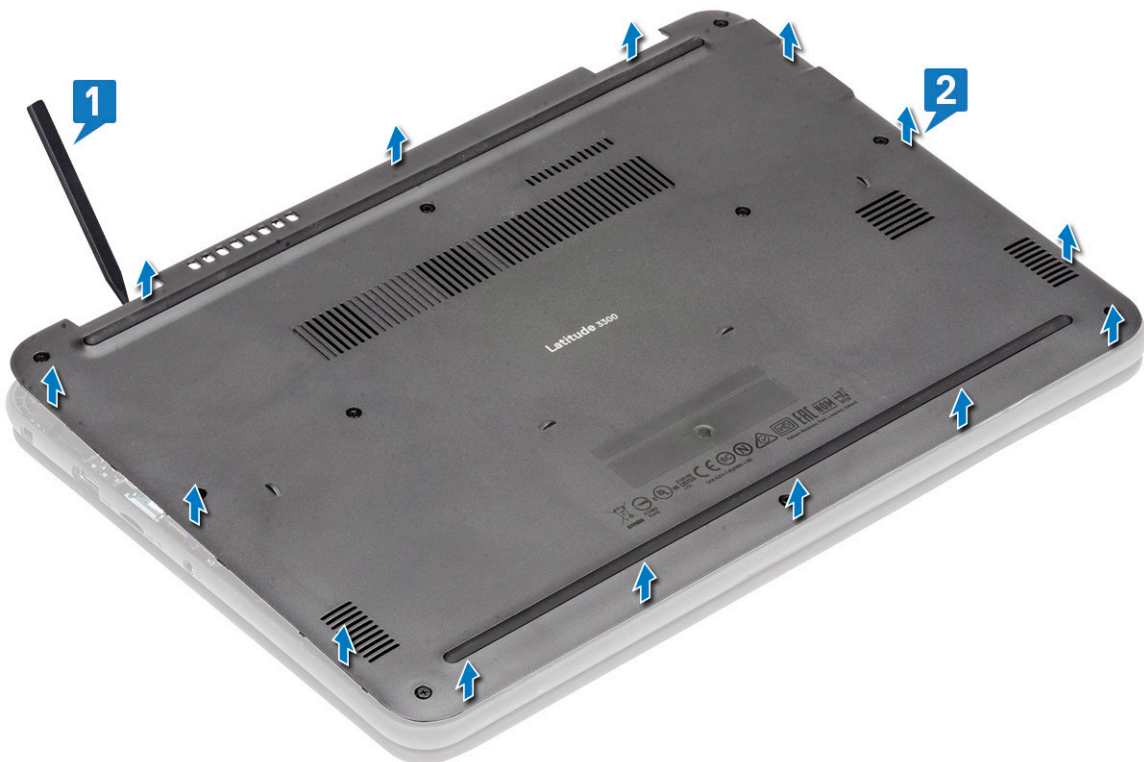

5. Lift the base cover up and away from the computer.



Installing the base cover

1. Align the base cover and place it on the computer.



2. Press down along the edges of the base cover until it clicks into place.

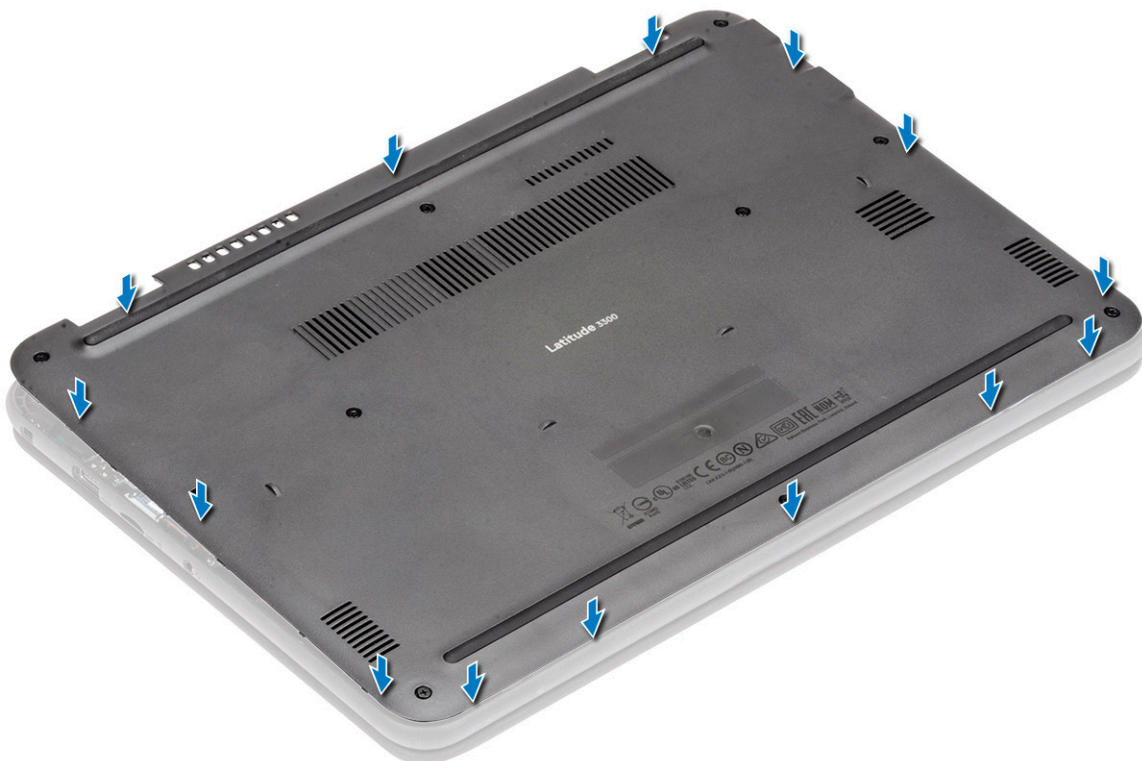

3. Tighten the 10 'M2.5xL8.5' captive screws to secure the base cover to the computer.

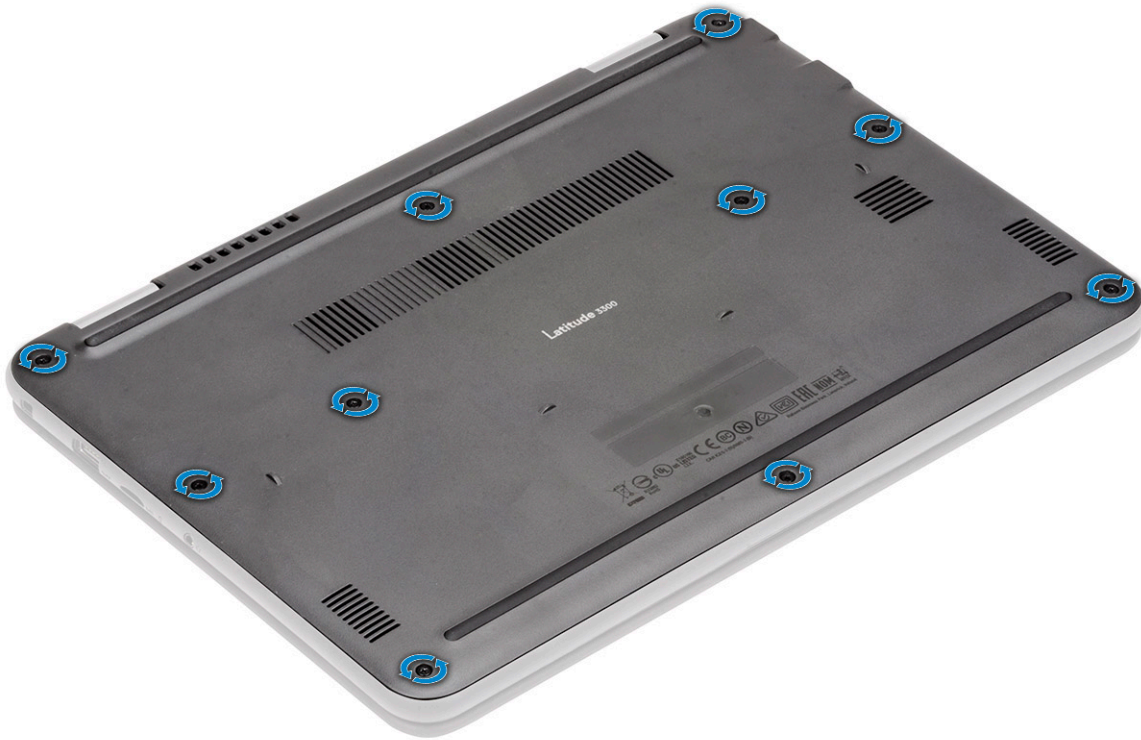

4. Install the:
 - a) [microSD card](#)
5. Follow the procedure in [After working inside your computer](#).

Battery

Removing the battery

1. Follow the procedure in [Before working inside your computer](#).
2. Remove the:
 - a) [microSD card](#)
 - b) [base cover](#)
3. Peel off the tape [1] and disconnect the battery cable from the system board [2].
4. Peel off the piece of tape [3] on the memory module bracket and unroute the battery cable.

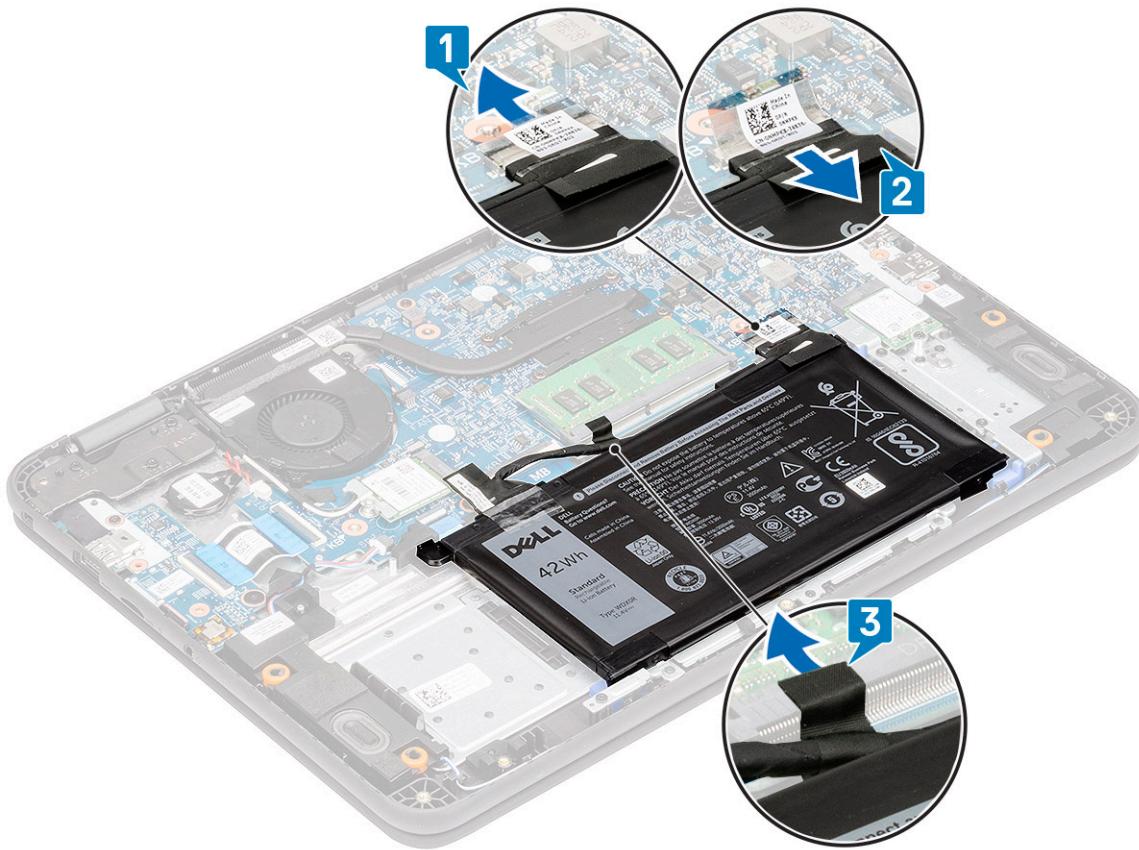

5. **NOTE:** This procedure shows a 3-cell 42 WHr battery removal. The 4-cell 56 WHr battery is slightly bigger in size and mounts to different mounts on the palmrest.

Remove the single M2.0x3.0 screw [1] and remove the metallic bracket [2] retaining battery to the palmrest.

6. Remove the two M2.0x3.0 screws [3] and separate the battery support bracket [4] from the palmrest.

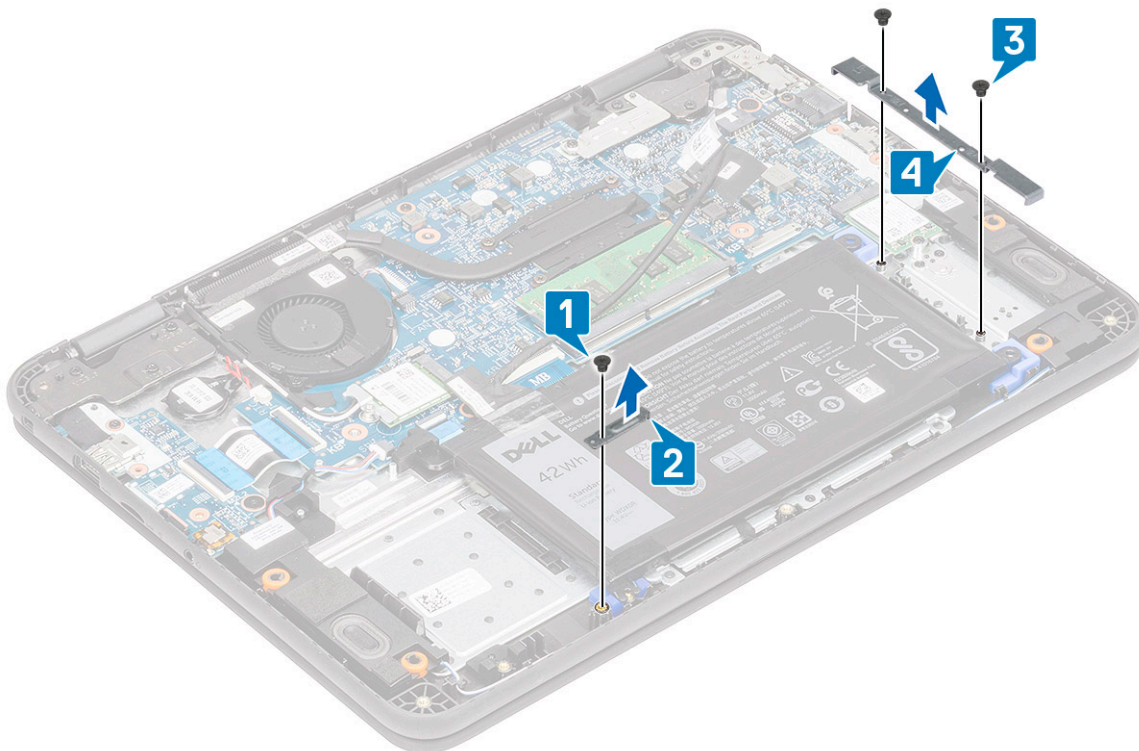

7. Lift the battery away from the computer.

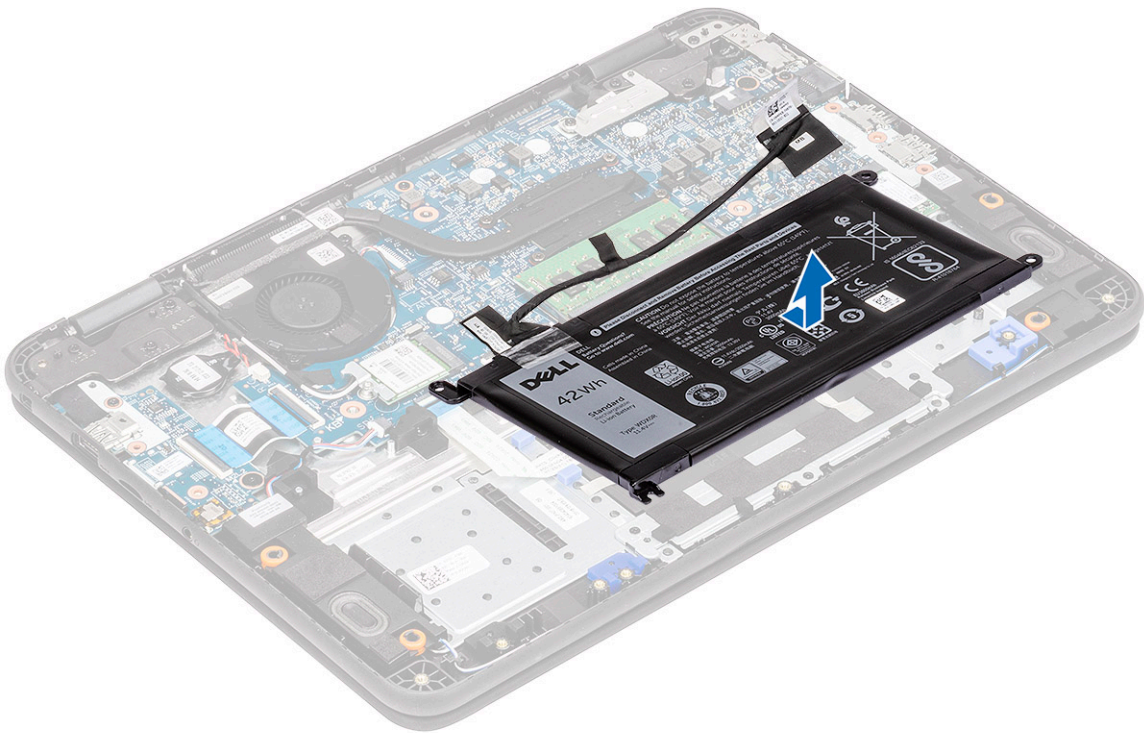

8. Peel off the tape [1] and disconnect the battery cable from the battery [2].



Installing the battery

1. Install the battery cable on the battery [1] and secure it using a piece of tape [2].



2. ⓘ **NOTE:** This procedure illustrates a 3-cell 42 WHr battery, a 4-cell 56 WHr battery mounts is slightly bigger in size and mounts to different mount points on the palmrest.

Insert the battery into the slot on the computer [1] and align the battery and the screw hole on the palmrest [2].

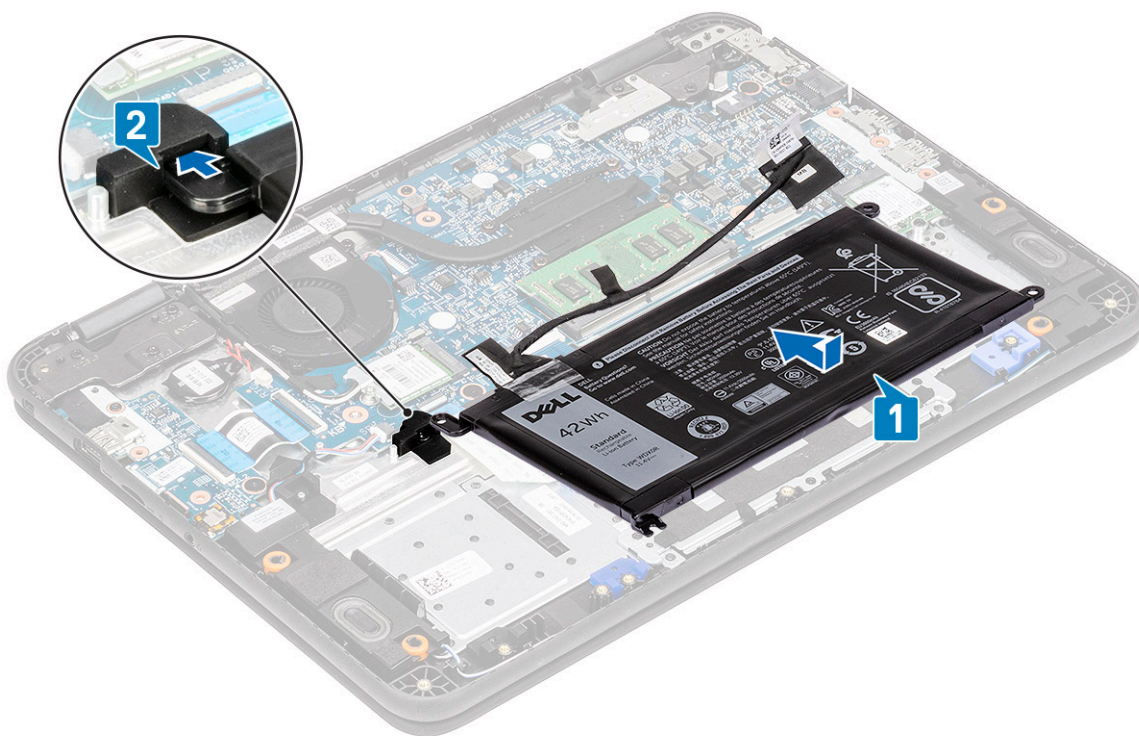

3. Install the battery support bracket [1] and install the two M2.0xL3 screws securing the battery to the palmrest [2].
 4. Install the metallic bracket [3] and the single M2.0xL3 screw to retain the battery [4] to the palmrest.

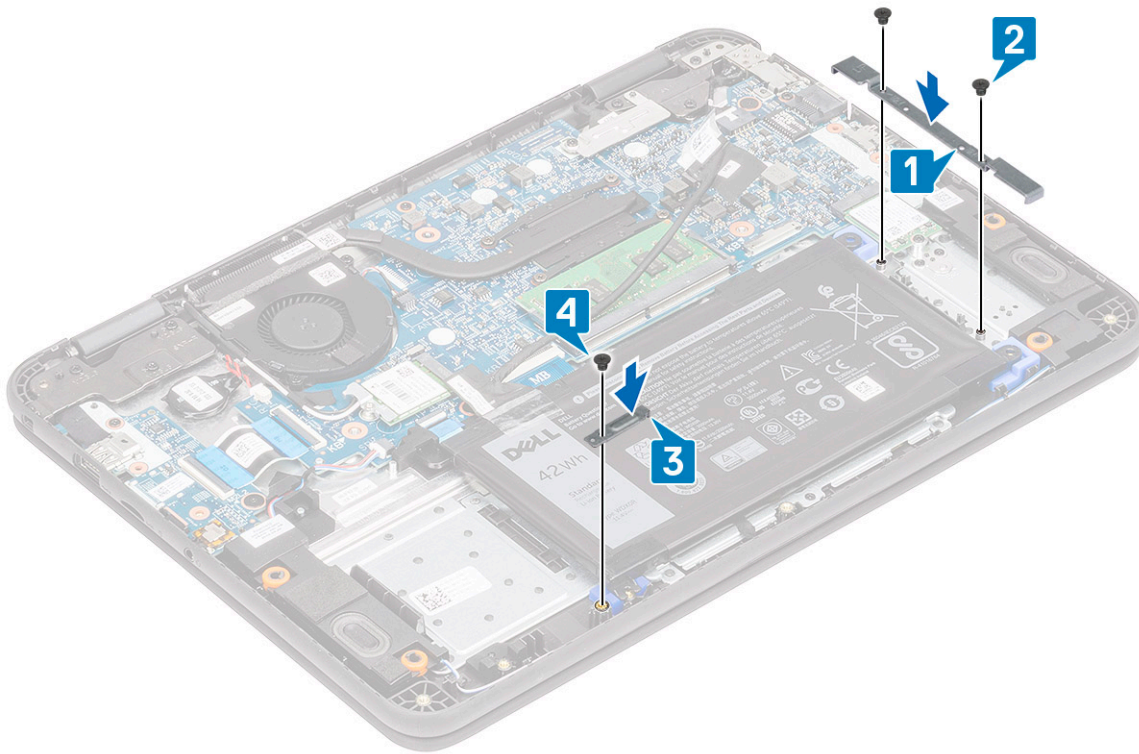

5. Connect the battery cable to the system board [1] and secure it using a piece of tape [2].
6. Route the battery cable along the memory module bracket and secure it using a piece of tape [3].

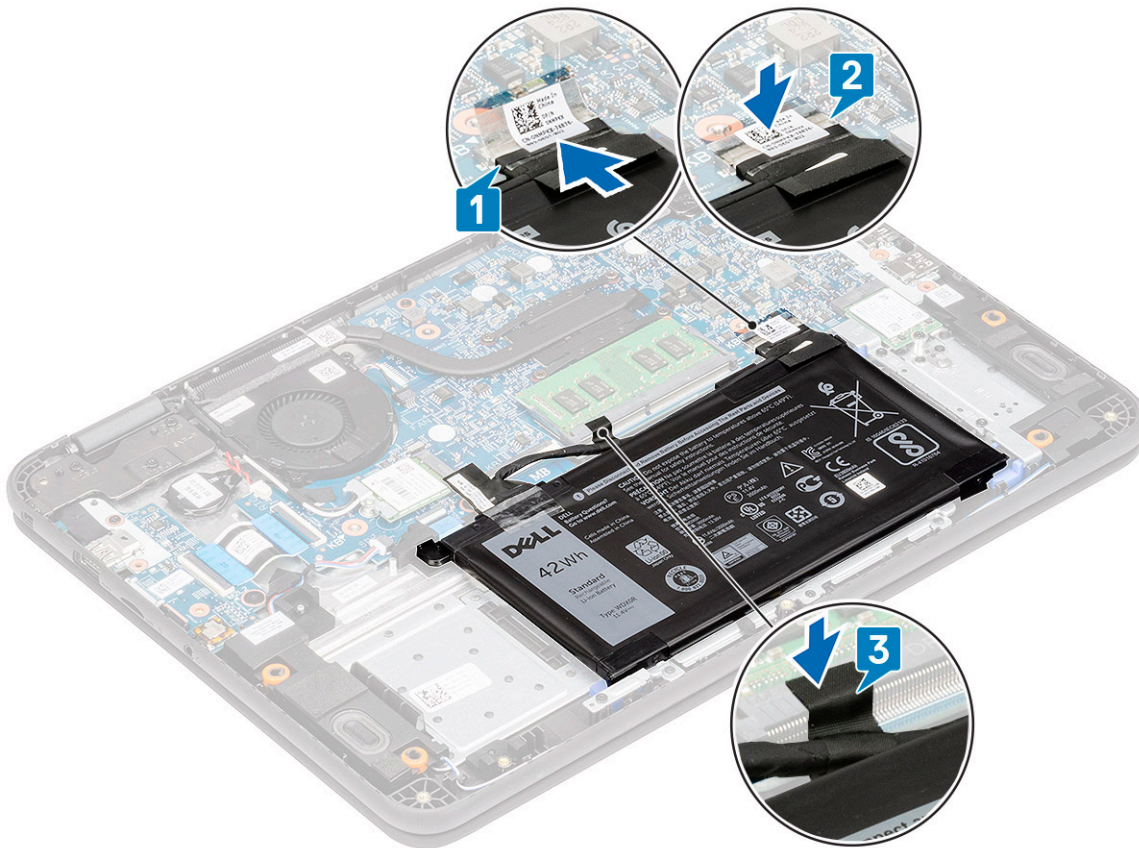

7. Install the:
 - a) base cover
 - b) microSD card

8. Follow the procedure in [After working inside your computer](#).

Coin Cell

Removing the coin cell

1. Follow the procedure in [Before working inside your computer](#).
2. Remove the:
 - a) [microSD card](#)
 - b) [base cover](#)
 - c) [battery](#)
3.  **CAUTION: Backup the data before removing the coin cell. Removal of coin cell will resets the BIOS and may cause No Boot, No POST or potential loss of data or lockout.**

Disconnect the battery cable from its connector on the system board [1].

4. Lift and remove the coin cell from the system [2].

 **NOTE: A strong adhesive is used on the coin cell; a bit of force is needed to peel up the battery from the palmrest.**

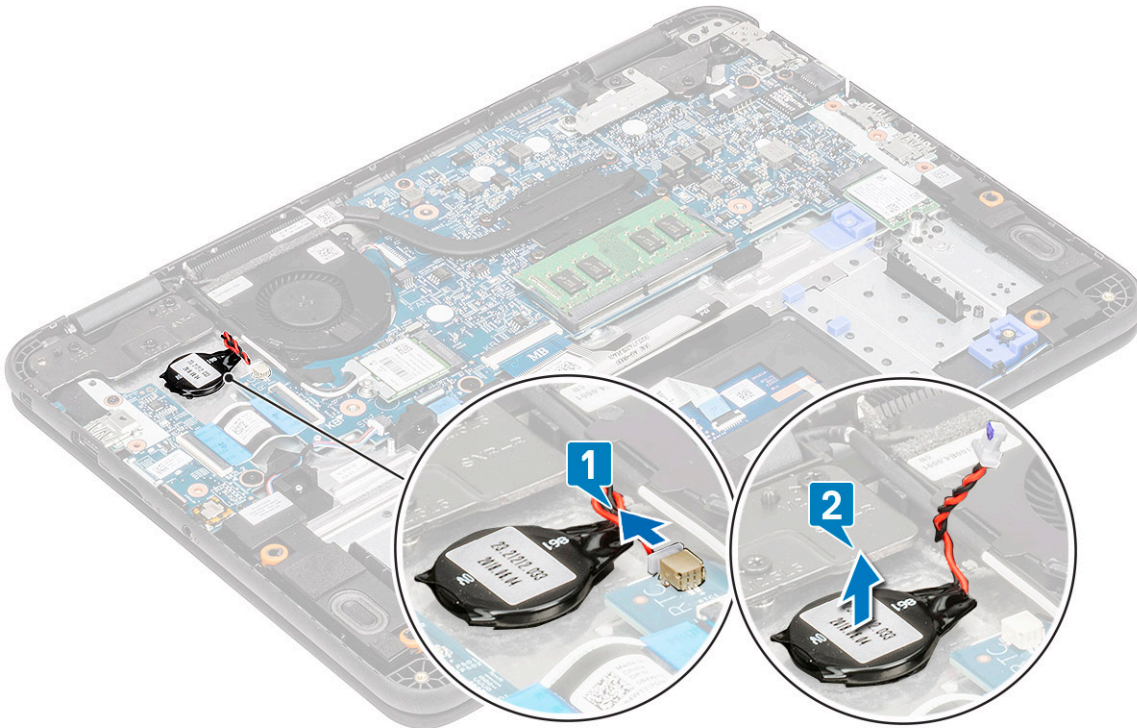

Installing the coin cell

1. Place the coin cell battery into the system [1].
2. Connect the coin cell battery cable to the connector on the system board [2].

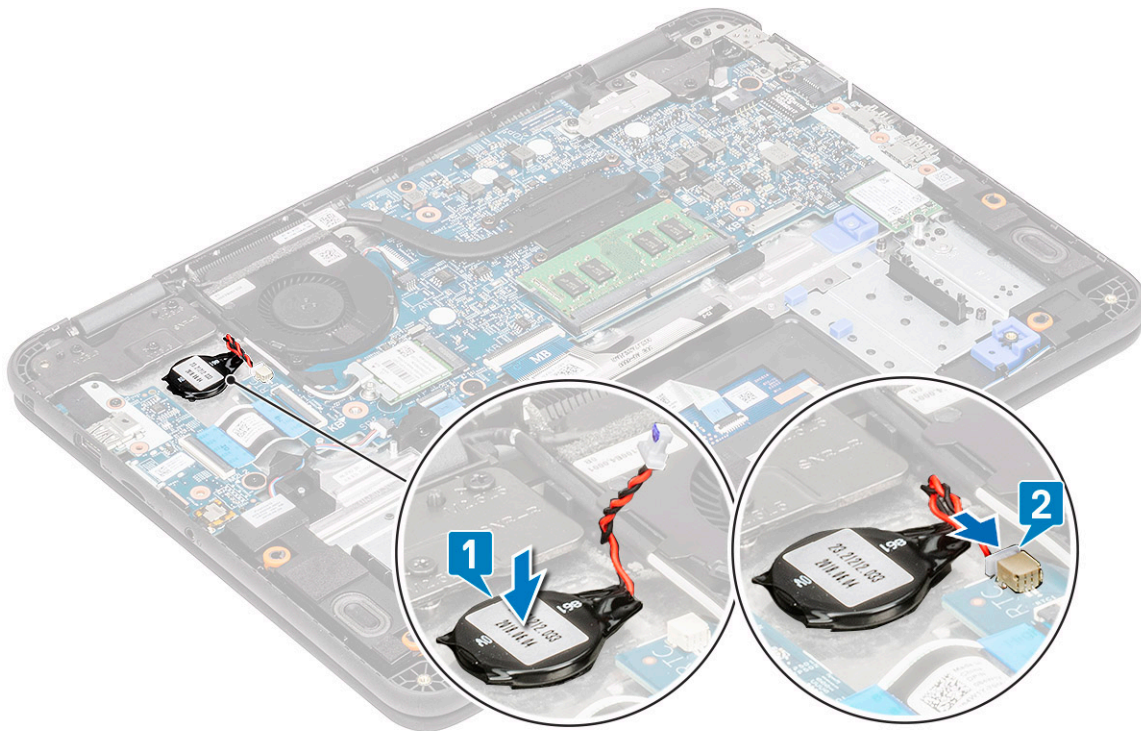

3. Install the:
 - a) [battery](#)
 - b) [base cover](#)
 - c) [microSD card](#)
4. Follow the procedure in [After working inside your computer](#).

Memory Module

Removing the memory module

1. Follow the procedure in [Before working inside your computer](#).
2. Remove the:
 - a) [microSD card](#)
 - b) [base cover](#)
 - c) [battery](#)
3. Pry apart the memory module latches [1].
4. Lift and remove the memory module from the system board [2].

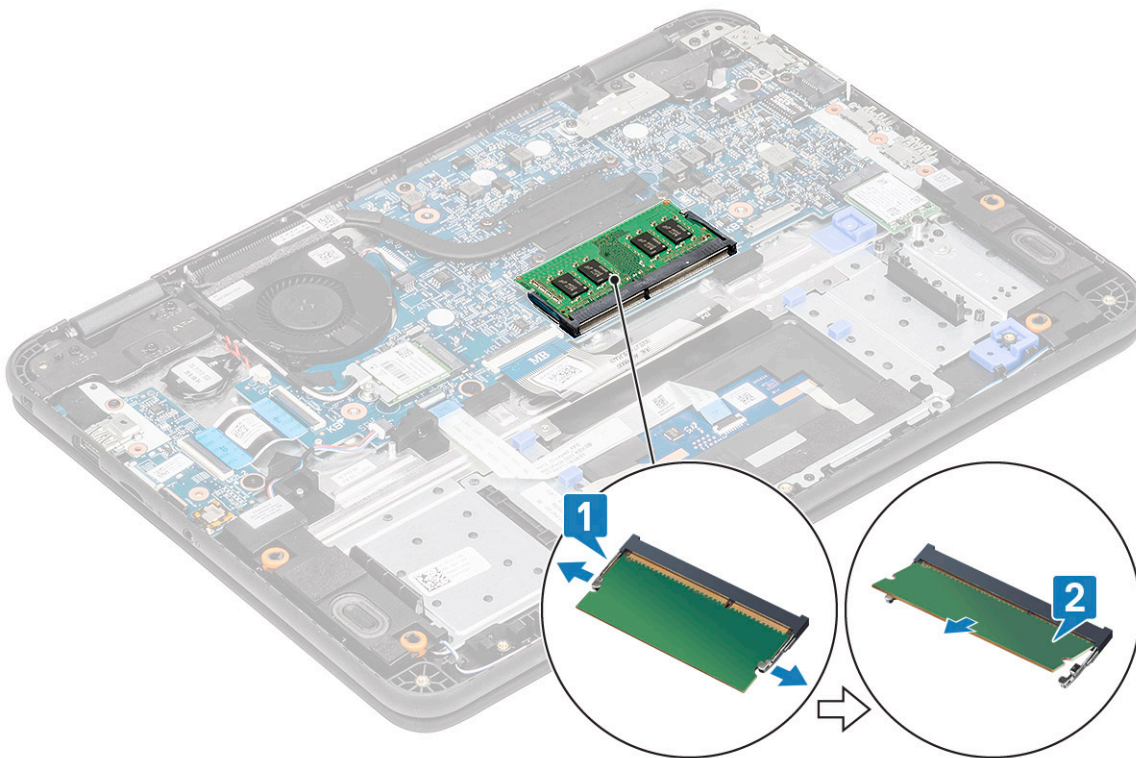

Installing the memory module

1. Insert the memory module at an acute angle into the connector on the system board [1].
2. Gently push the memory module until the latches snap it into place [2].

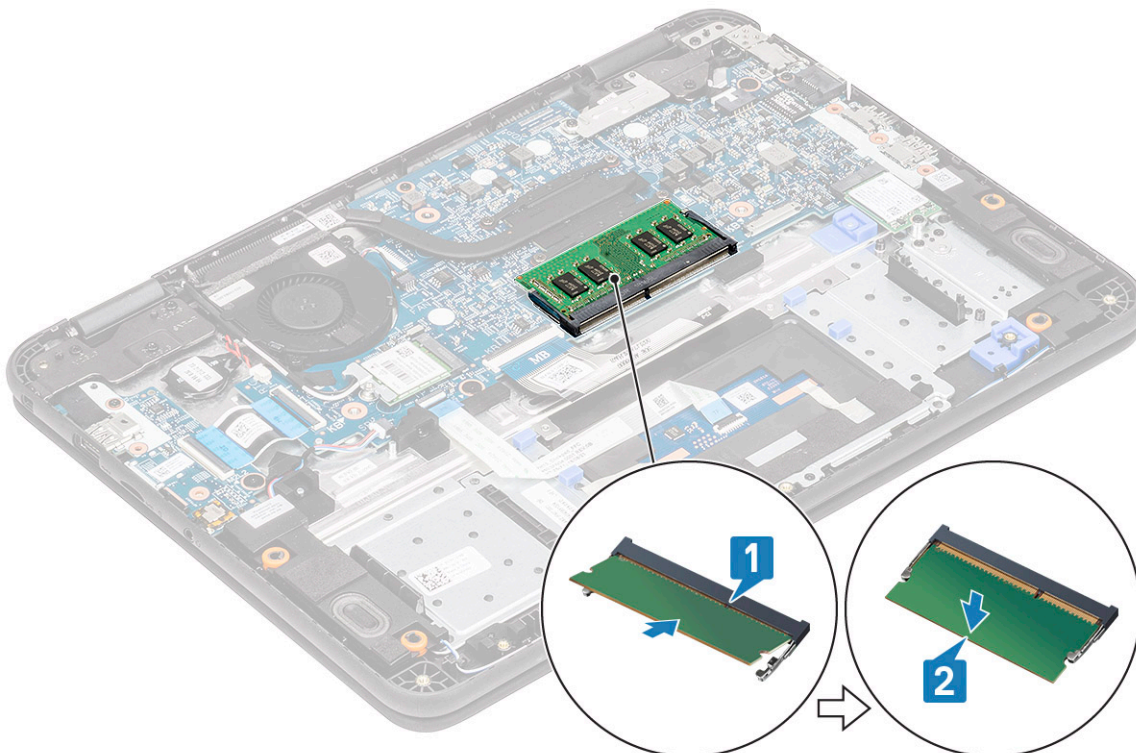

3. Install the:
 - a) battery
 - b) base cover

c) microSD card

4. Follow the procedure in [After working inside your computer.](#)

Solid state drive (SSD)

Removing the SSD

1. **NOTE:** This system has option to fit two form factors (M.2 2242 and M.2 2230) SSD / eMMC cards. This is achieved by removing, inverting and, installing the extender to an alternate location as marked on the palmrest.

Follow the procedure in [Before working inside your computer.](#)

2. Remove the:
 - a) microSD card
 - b) base cover
 - c) battery
3. Remove the single M2xL4 screw securing the SSD on the extender [1].
4. Remove the SSD from the M.2 slot on the system board [2].

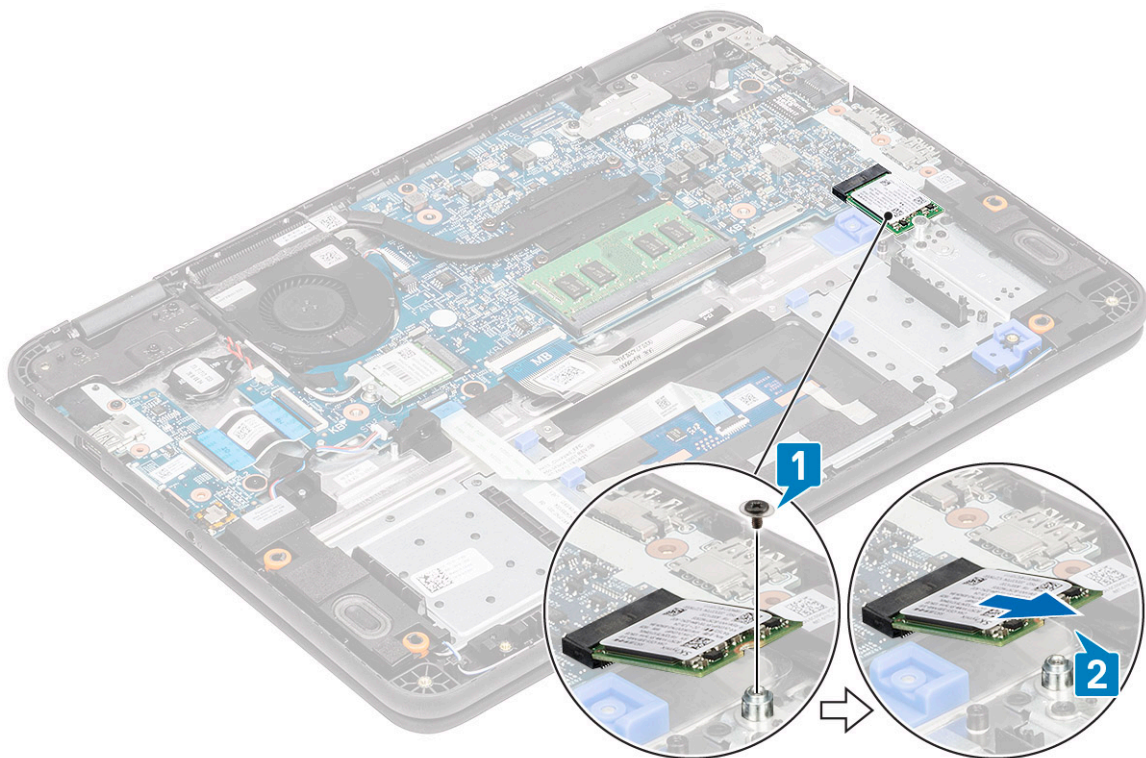

Figure 11. M.2 2230 SSD

Installing the SSD

1. Install the SSD in the M.2 bracket [1] and secure it using the single M2xL4 screw [2] securing it to the extender.

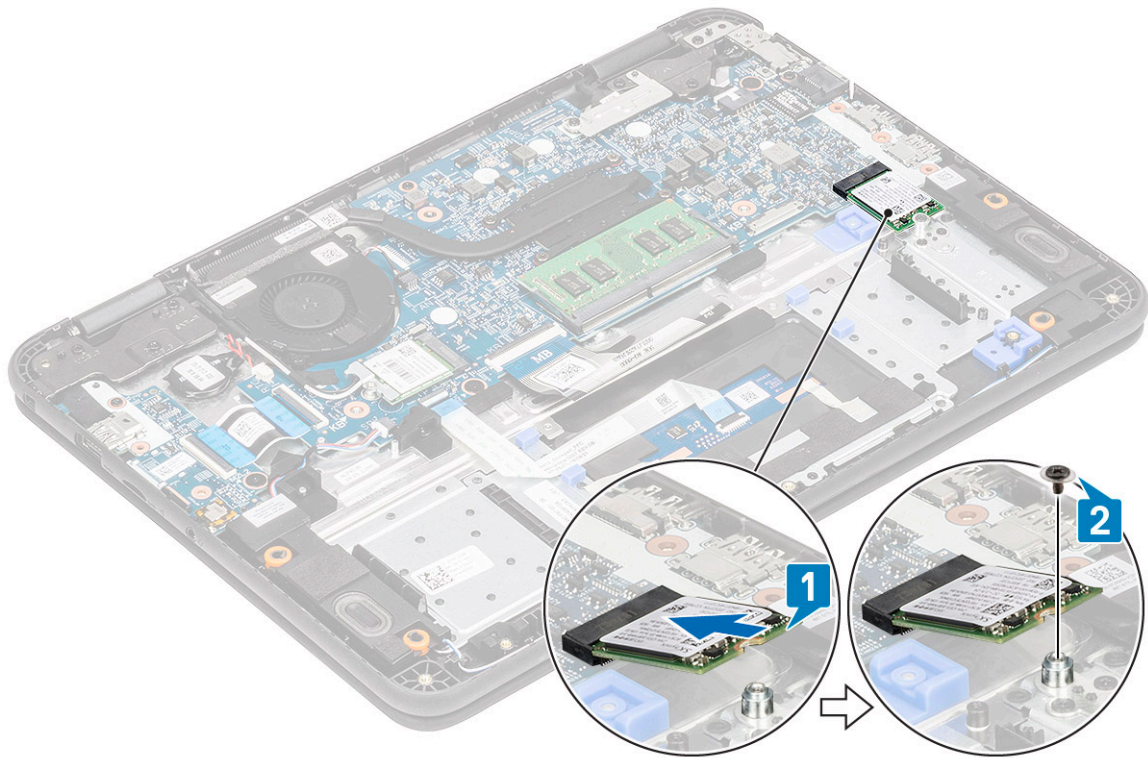



Figure 12. M.2 2230 SSD

2. Install the:
 - a) battery
 - b) base cover
 - c) microSD card
3. Follow the procedure in [After working inside your computer](#).

SSD bracket

Removing the SSD bracket

1.  **NOTE:** This system has option to fit two form factors (M.2 2242 and M.2 2230) SSD / eMMC cards.
Follow the procedure in [Before working inside your computer](#).
2. Remove the:
 - a) microSD card
 - b) base cover
 - c) battery
 - d) SSD
3. Remove the two M2xL3 screws securing the SSD bracket on the palmrest [1].
4. Remove the SSD bracket from the palmrest [2].

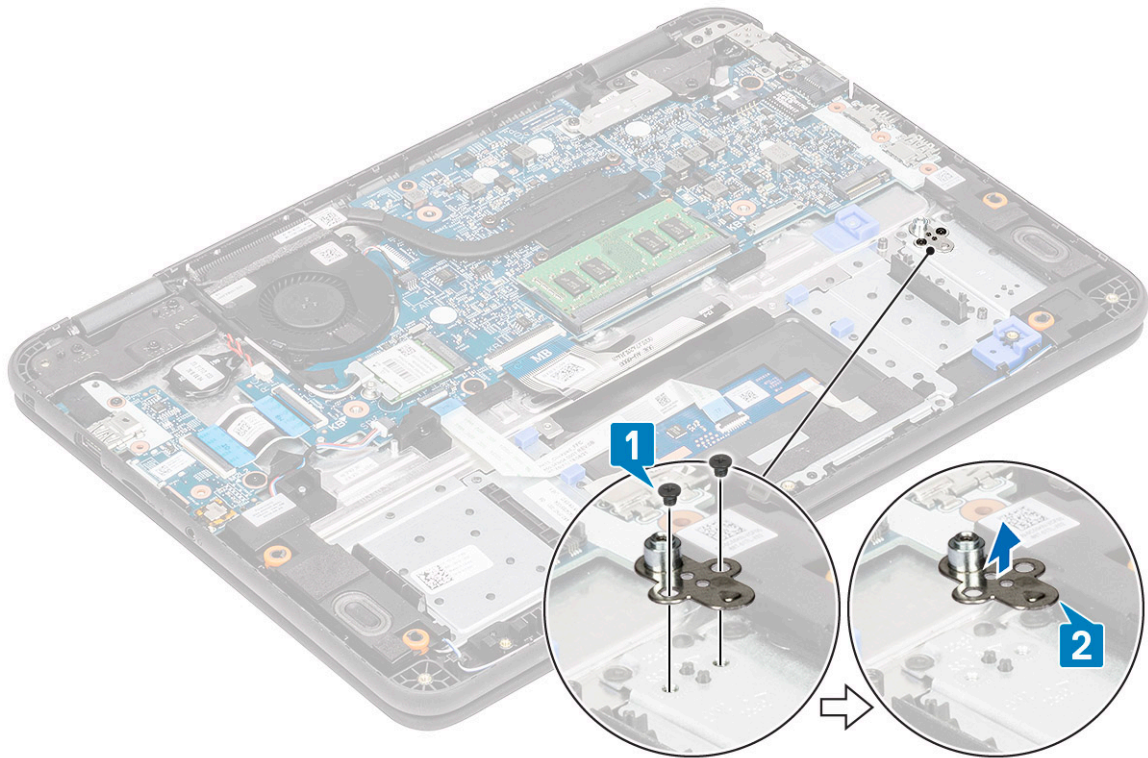

Figure 13. M.2 2230 SSD

Installing the SSD bracket

1. Install the SSD bracket in the palmrest [1].
2. Install the two M2xL3 screws securing the SSD bracket to the palmrest [2].

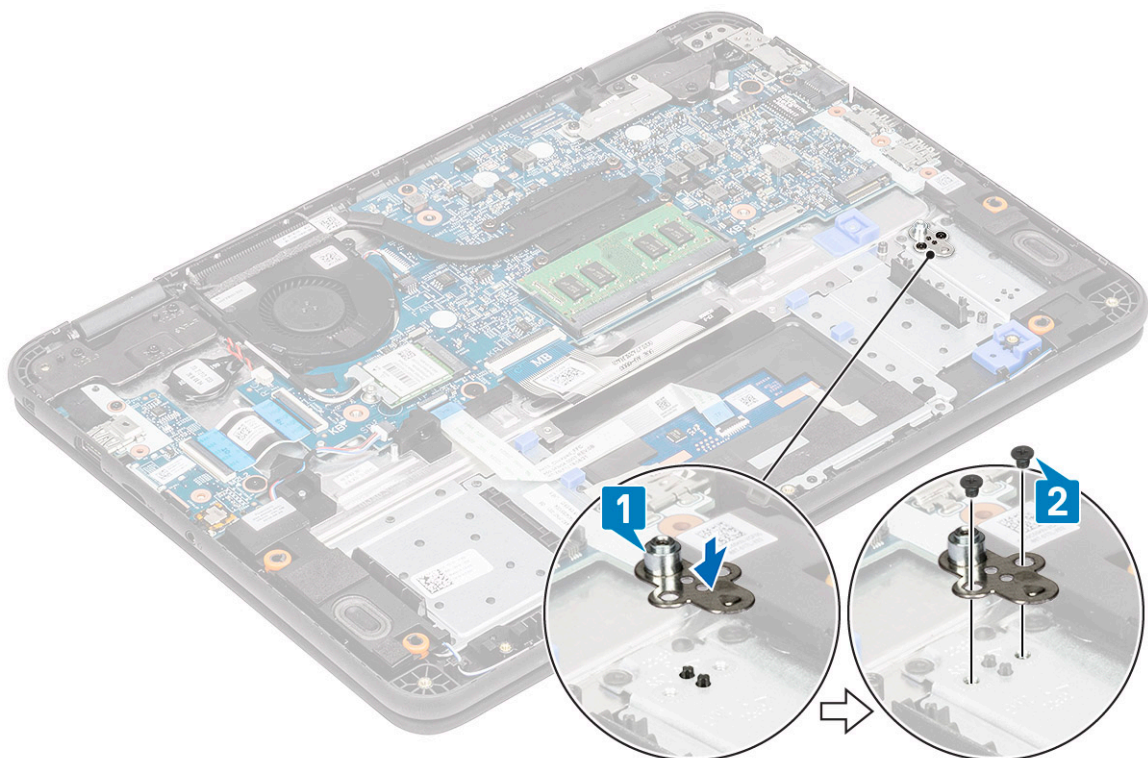

Figure 14. M.2 2230 SSD

3. Install the:

- a) SSD
 - b) battery
 - c) base cover
 - d) microSD card
4. Follow the procedure in [After working inside your computer](#).

Keyboard

Removing the keyboard

1. Follow the procedure in [Before working inside your computer](#).
2. Remove the:
 - a) microSD card
 - b) base cover
 - c) battery
3. Disconnect the keyboard cable from the system board [1].
4. Hold the sides of the palmrest securely while pushing into the two release holes using a plastic scribe [2].

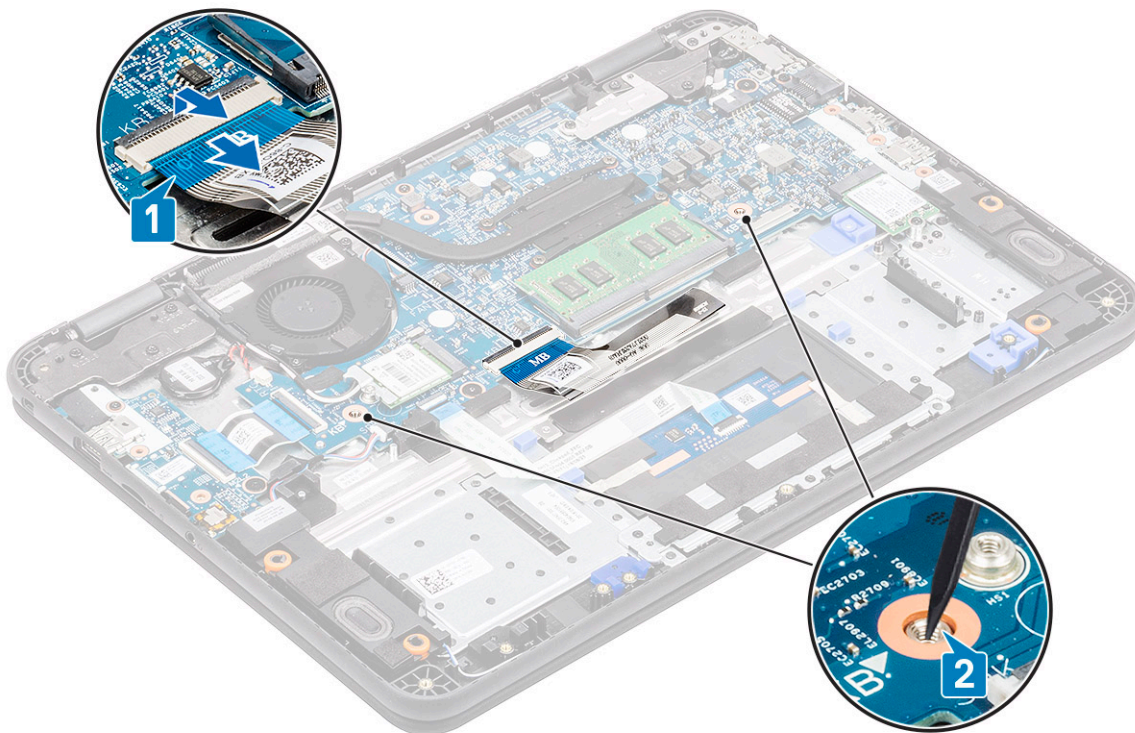

NOTE: It takes some force to push out the keyboard through the two release holes. Exercise due caution.

NOTE: Picture for representational purpose to show exact location of keyboard latches. It is not necessary to remove the heat sink, hard drive, or system board to access the keyboard release holes.

5. Gently pry up the lower edge of the keyboard from the computer.



6. Gently remove the keyboard cable from underneath the keyboard.



i | **NOTE:** Unroute the keyboard cable from the touchpad bracket before proceeding.

7. Slide the keyboard towards the touchpad [1] and lift it up [2] to remove it from the computer.



Installing the keyboard

1. Install the keyboard on the computer [1] and slide in the retention tabs in the holes on the palmrest [2].



2. Tuck in the keyboard cable and route it along the touchpad bracket.



3. Press the keyboard until it clicks in place.



4. Insert the keyboard cable in its connector on the system board.

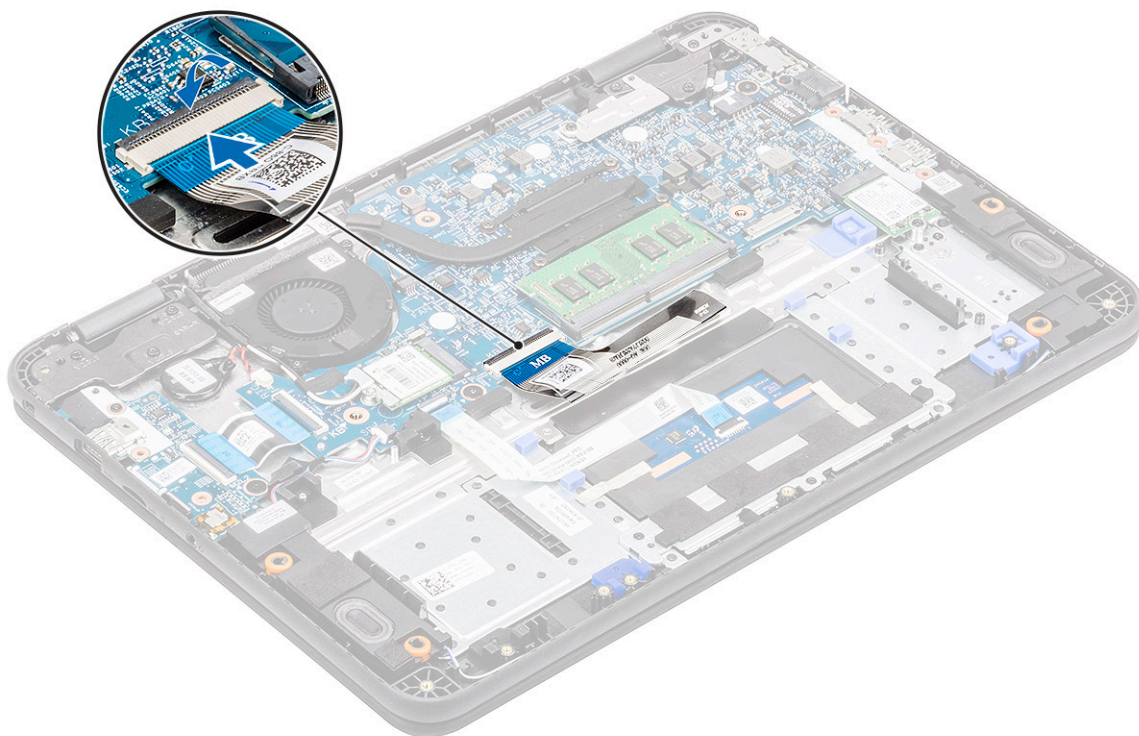

NOTE: Keyboard cable must be inserted parallel to the connector.

NOTE: Remove the anti adhesive paper on the keyboard before inserting the cable.

NOTE: After the cable is inserted, the operator must hold the cable with the left and press the actuator down by the right hand to avoid loosening the cable.

5. Install the:
 - a) battery
 - b) base cover
 - c) microSD card
6. Follow the procedure in [After working inside your computer](#).

Touchpad

Removing the touchpad

1. Follow the procedure in [Before working inside your computer](#).
2. Remove the:
 - a) microSD card
 - b) base cover
 - c) battery
3. Lift the actuator and disconnect the touchpad cable from the system board [1].
4. Remove the tape [2,3,4] securing the touchpad to the chassis.

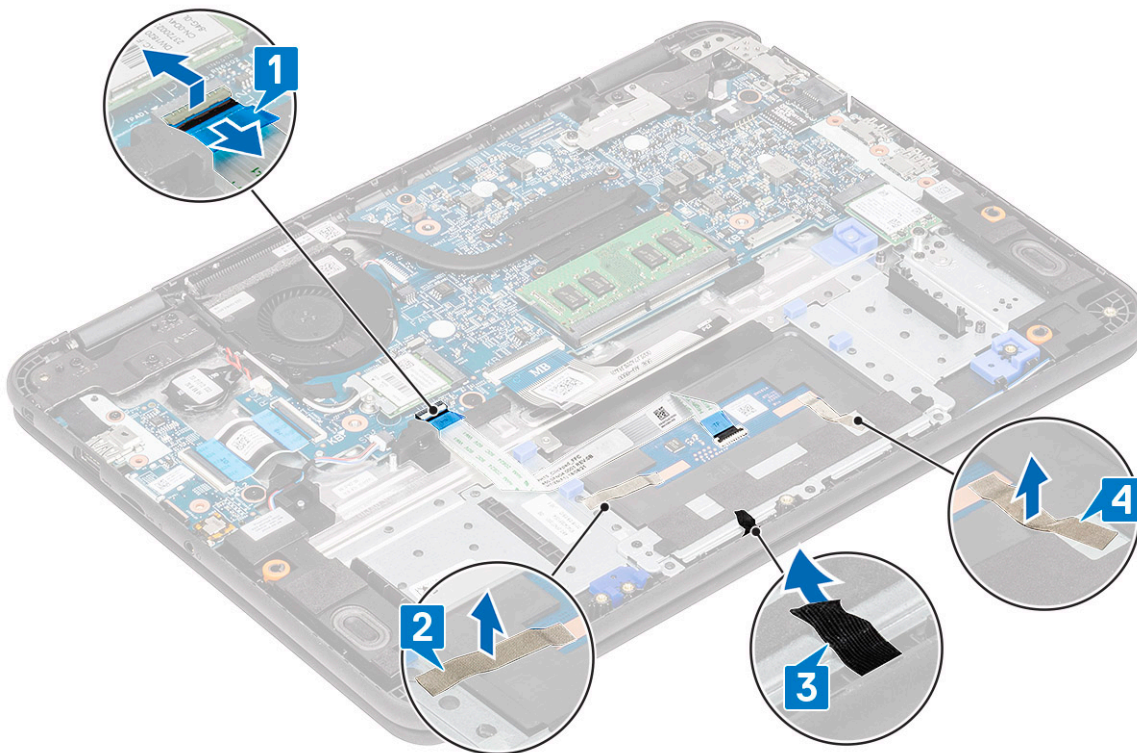

5. Remove the three M2xL3 screws [1] that secure the metal bracket to the touchpad on the computer.

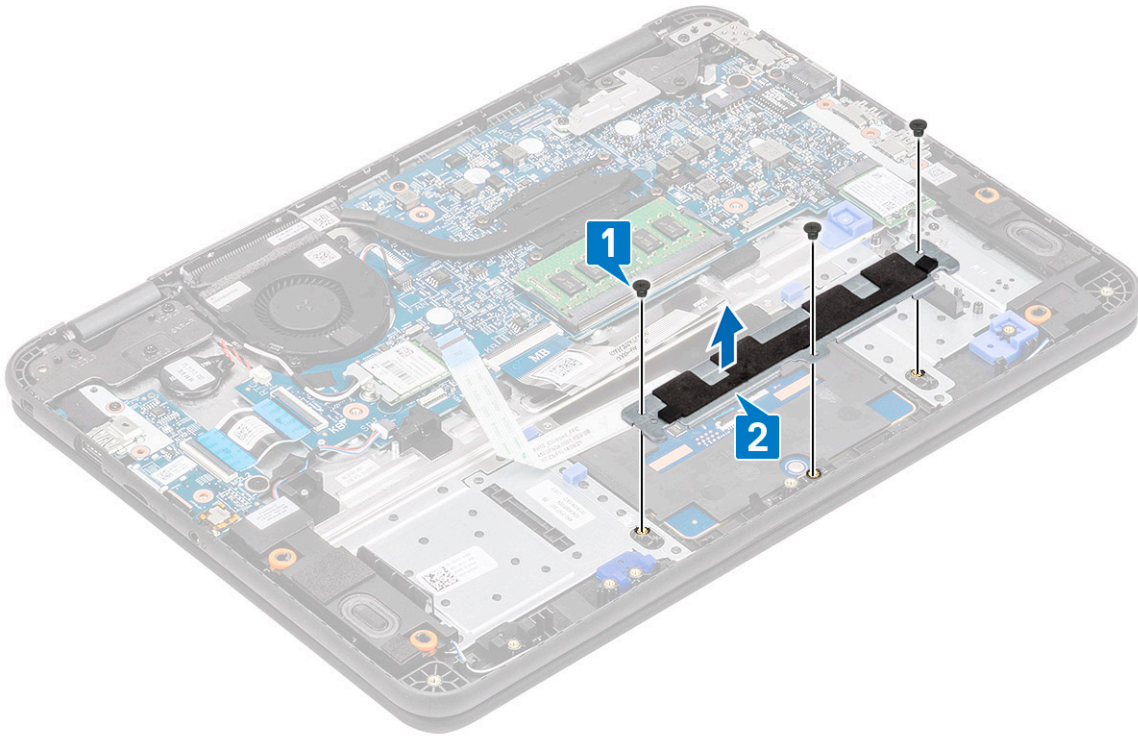

6. Peel off the tape from the touchpad.

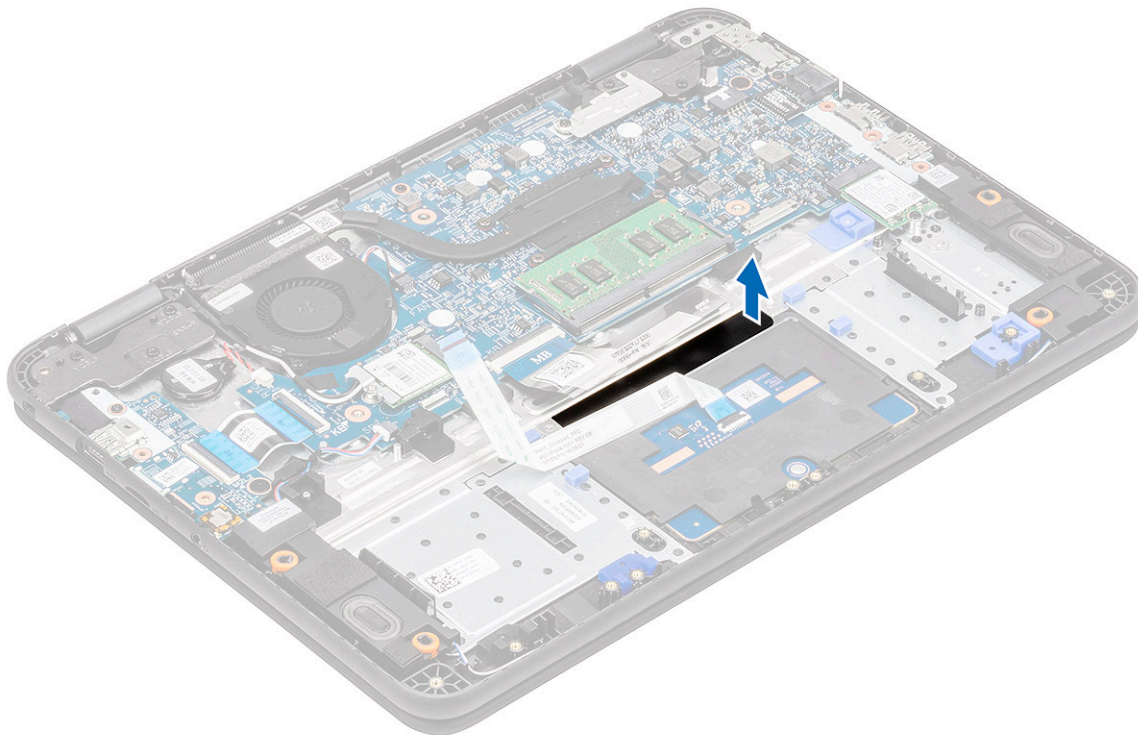

7. Remove the M2xL3 screws(large head) [1] that secure the touchpad to the system and then lift the touch pad from the system [2].

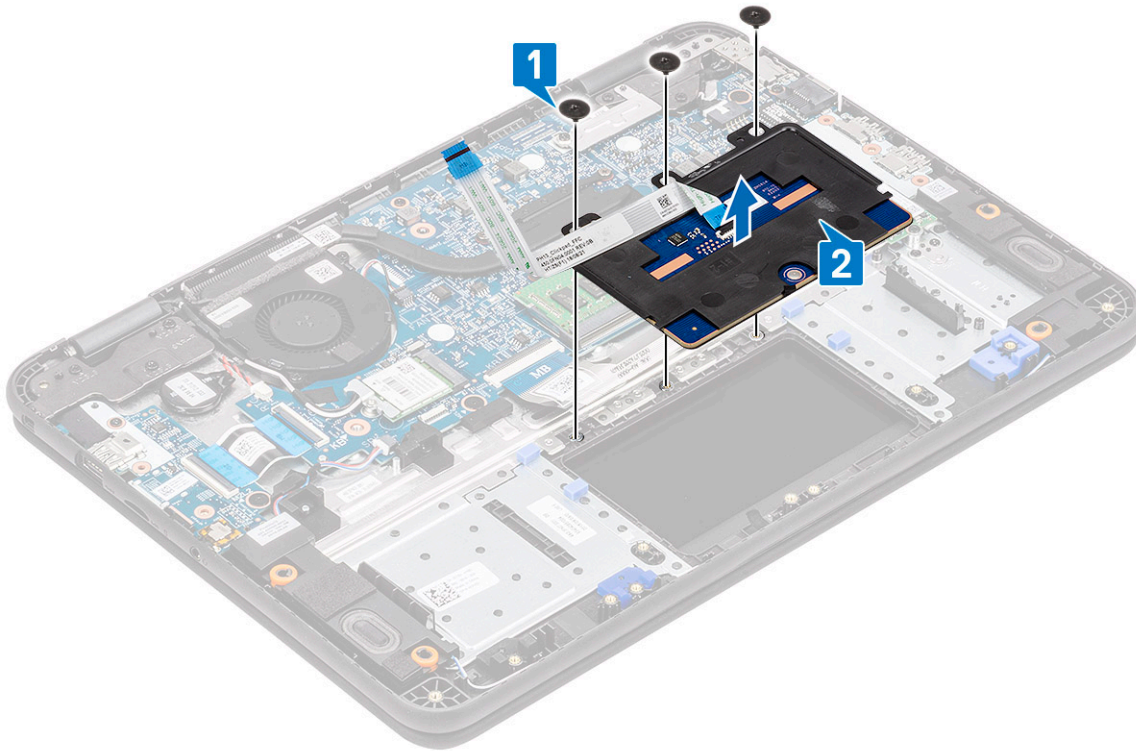

8. Lift the actuator [1] and remove the touchpad FFC cable [2] from the module.

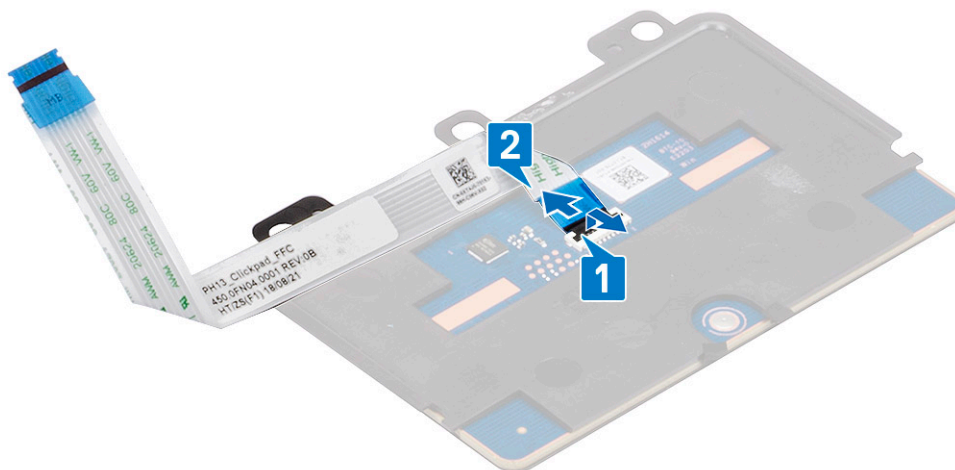

Installing the touchpad

1. Install the touch pad FFC cable on its slot on the touchpad module [1] and close the actuator [2] to secure it.

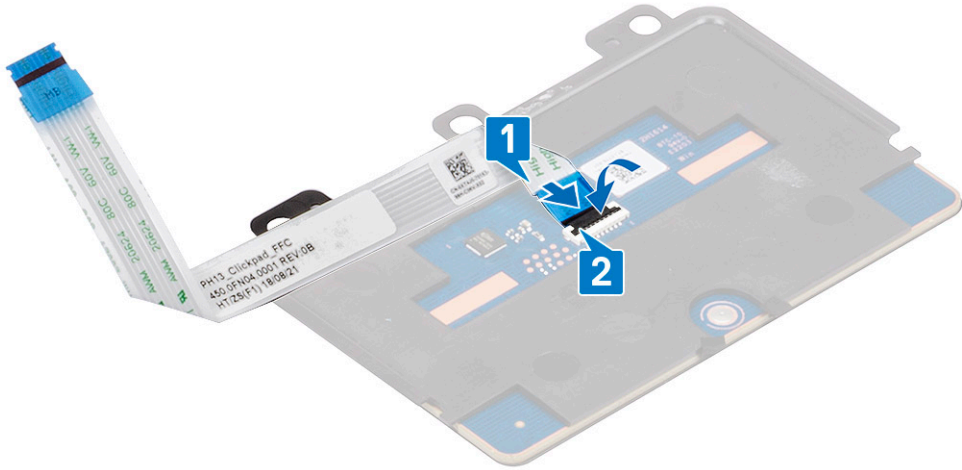

2. Place the touchpad into the slots on the computer [1] and tighten the three M2xL3 screws [2] that secure the touchpad to the system.

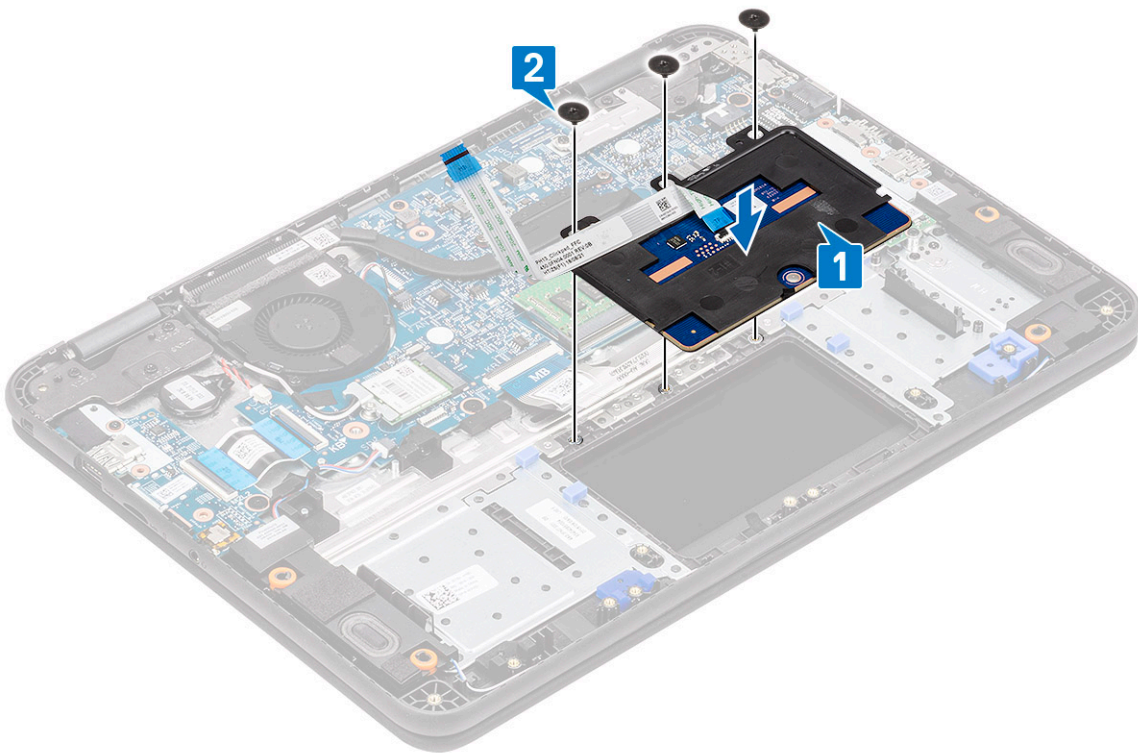

3. Secure the touchpad using a piece of tape.

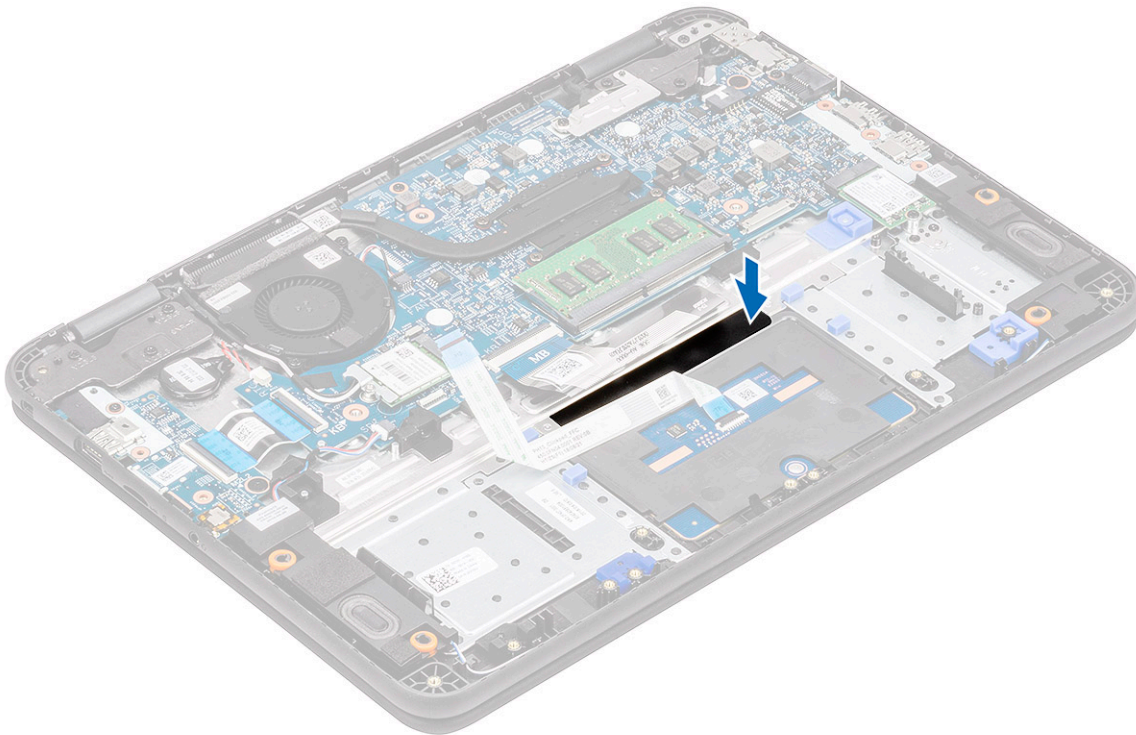

4. Affix the bottom bracket [1] that secures the touchpad to the computer.
5. Install the three M2xL3 screws [2] securing the touchpad to the system.

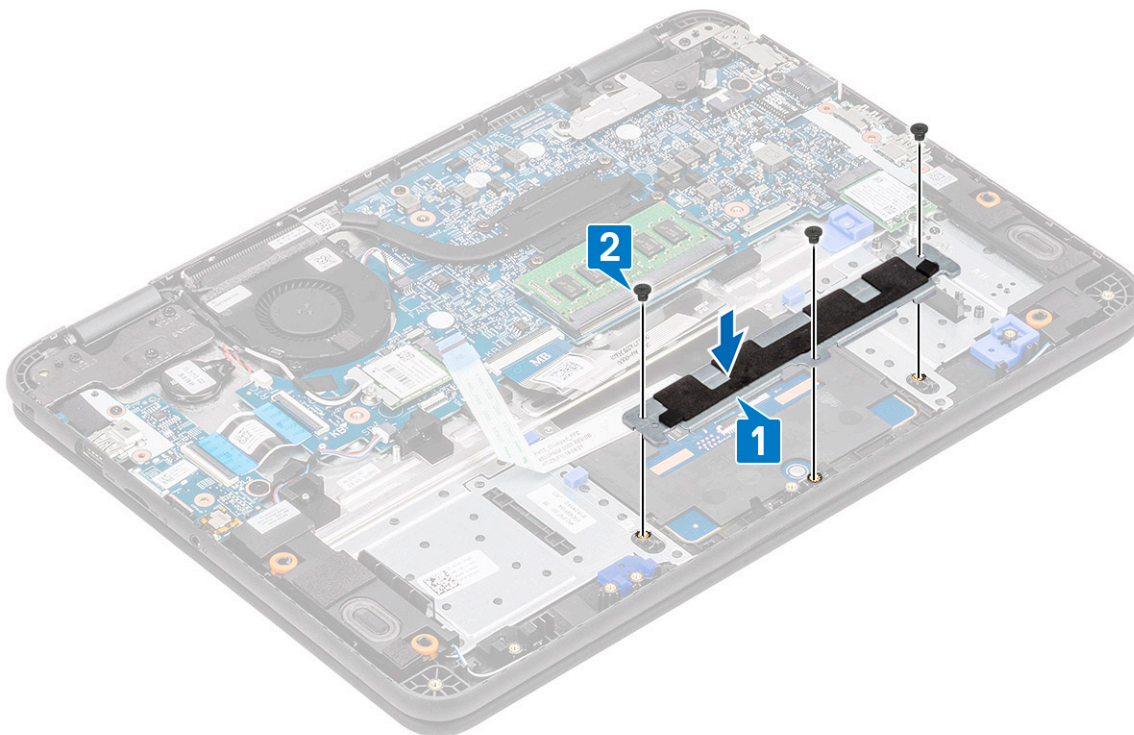

6. Affix the tapes [1,2,3] on the touch pad and connect the touchpad cable [4] to the connector on the system board.

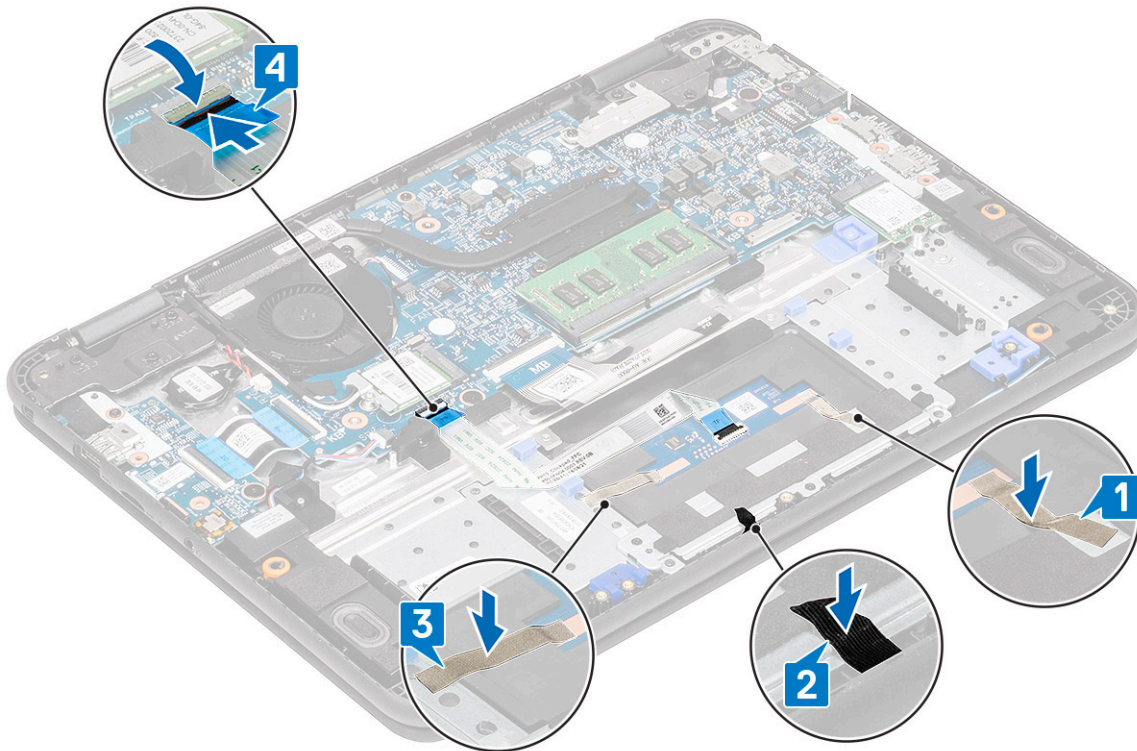

7. Install the:
 - a) [battery](#)
 - b) [base cover](#)
 - c) [microSD card](#)
8. Follow the procedure in [After working inside your computer](#).

Speakers

Removing the speakers

1. Follow the procedure in [Before working inside your computer](#).
2. Remove the:
 - a) [microSD card](#)
 - b) [base cover](#)
 - c) [battery](#)
3. Disconnect the speaker cable from the connector on the system board [1] and lift the speaker cable off from the cable guide [2].
4. Unroute the speaker cable from the routing channel [3] along the bottom of touchpad on the palmrest.

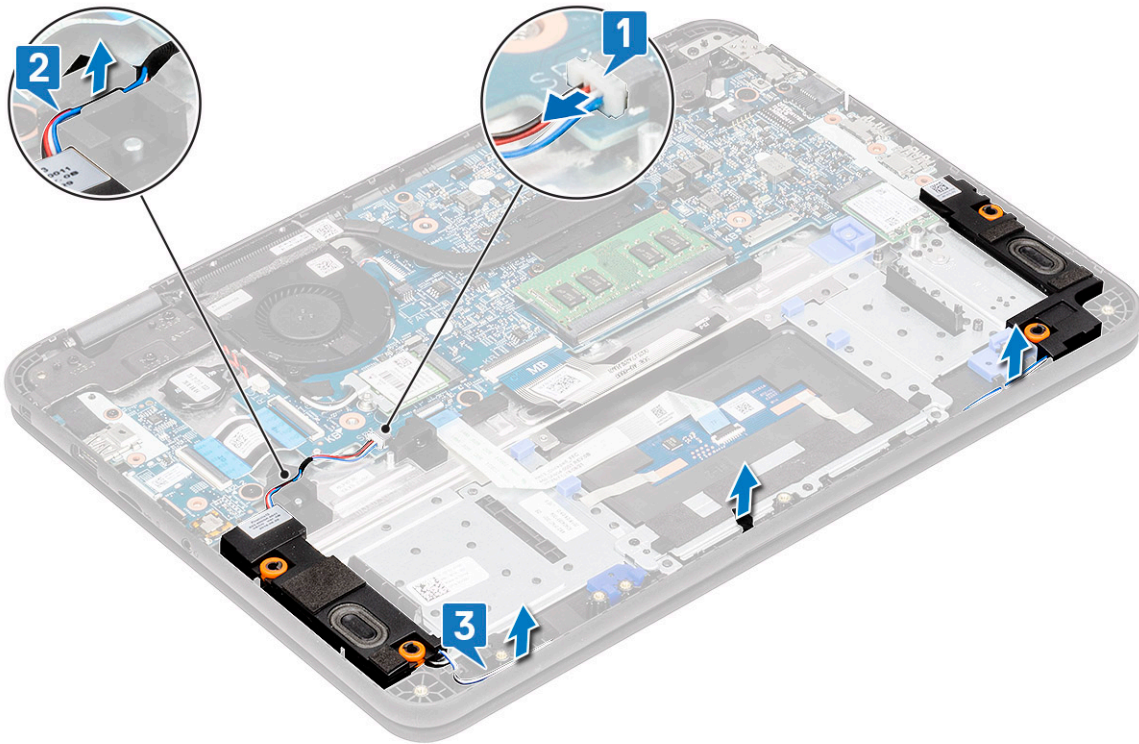

5. Remove the speakers along with the cable from the computer.

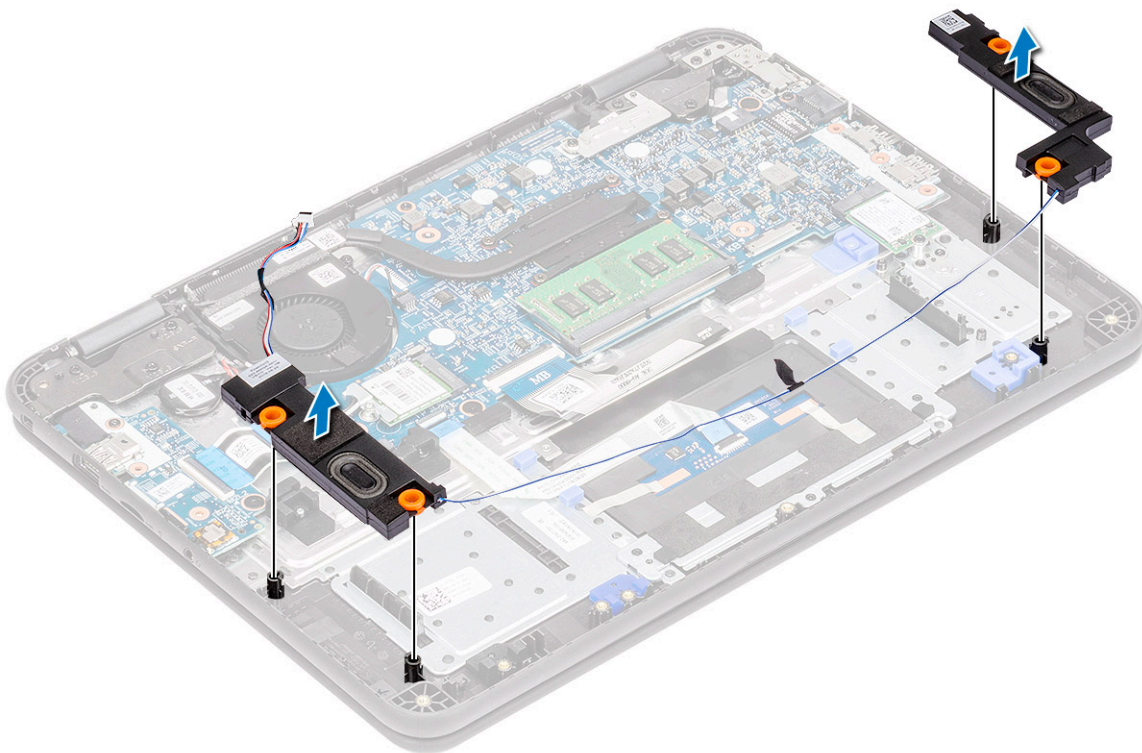

Installing the speakers

1. Place the speakers into the slots on the computer.

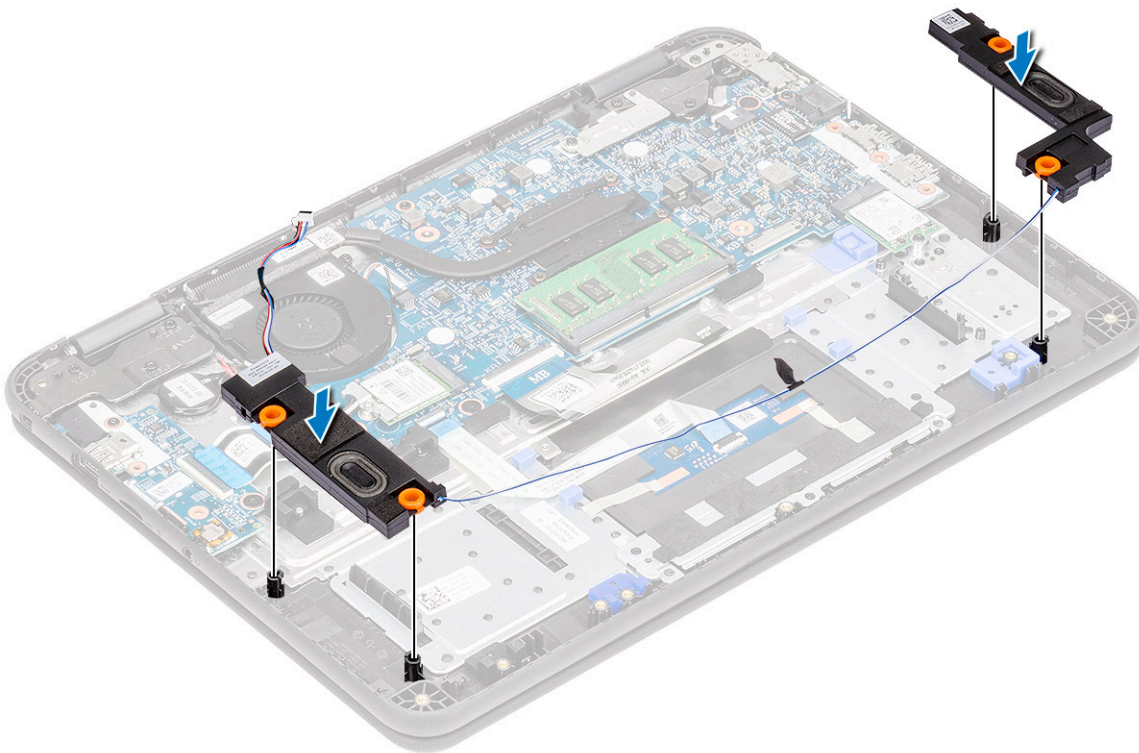

2. Route the speaker cable through the routing channel along the bottom of touchpad on the palmrest [1].
3. Route and secure the speaker cable into the cable guide [2] and connect the cable to the connector on the system board [3].

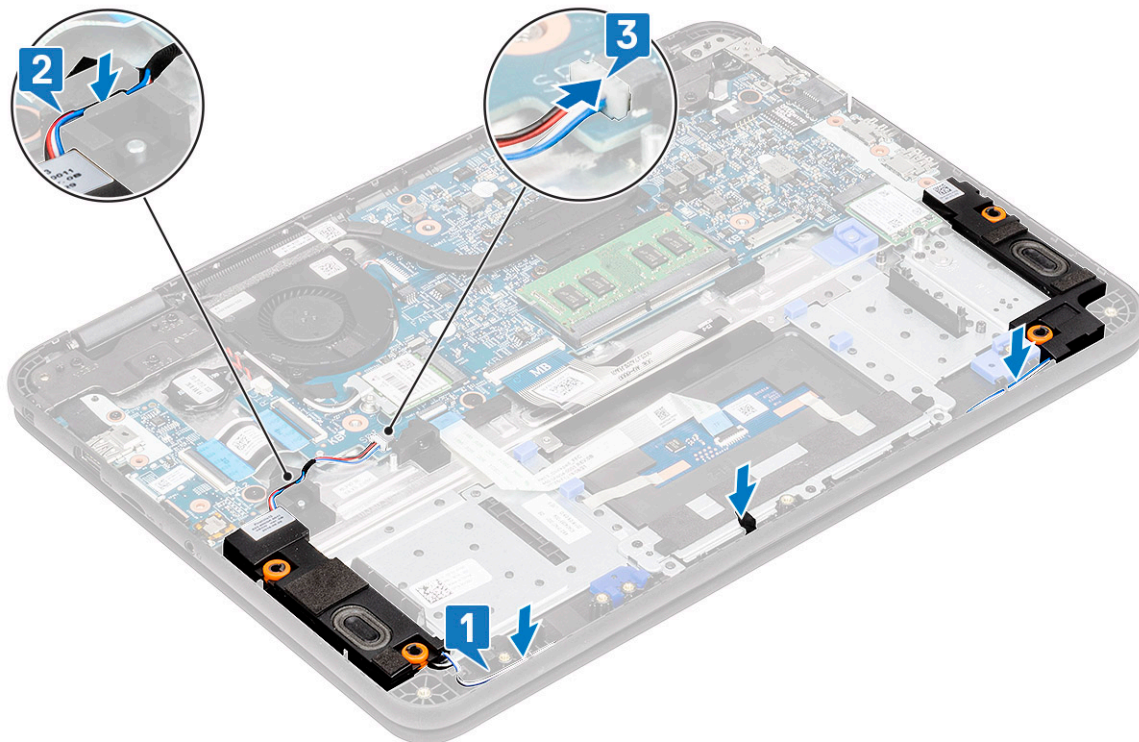

4. Install the:
 - a) [battery](#)
 - b) [base cover](#)
 - c) [microSD card](#)
5. Follow the procedure in [After working inside your computer](#).

I/O Daughterboard

Removing the I-O daughterboard

1.  **NOTE: Power button is located on this PCB.**

Follow the procedure in [Before working inside your computer](#).

2. Remove the:
 - a) [microSD card](#)
 - b) [base cover](#)
 - c) [battery](#)
3. Disconnect the I/O daughterboard cable from its connector on the system board.

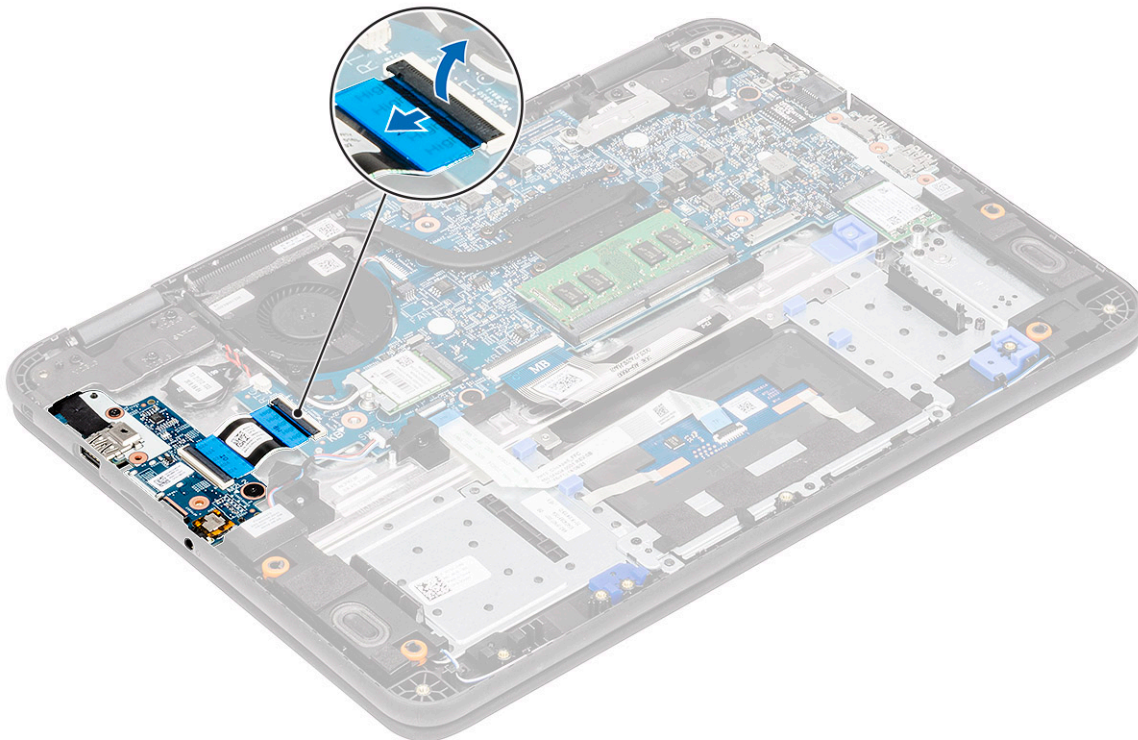

4. Open the actuator [1] and remove the FFC cable from the I/O board [2].

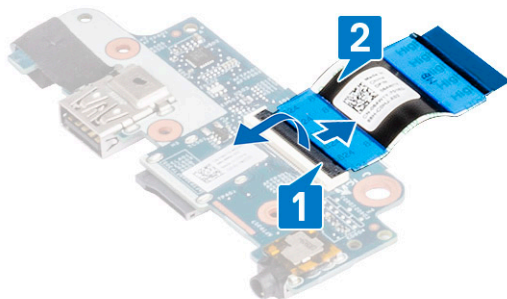

5. Remove the two M2xL3 screws that secure the I/O daughterboard to the system board [1].
6. Lift and remove the I/O daughterboard from the computer [2].

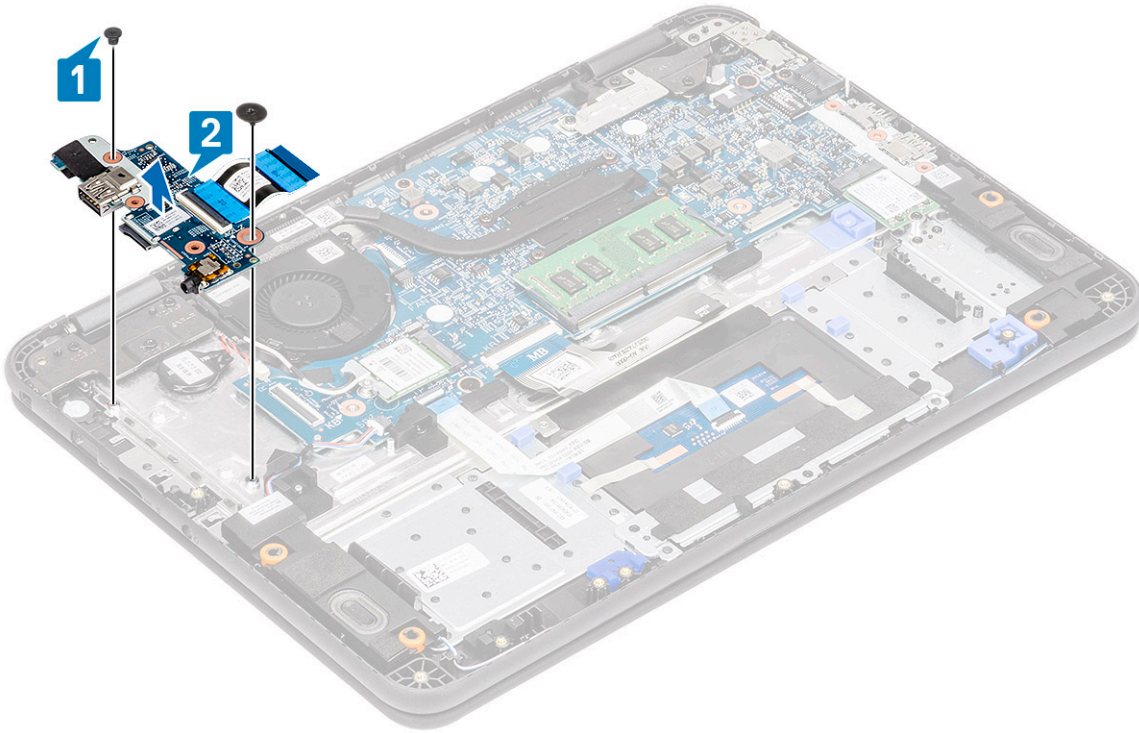

Installing the I-O daughterboard

1. Place the I/O daughterboard in its place on the computer [1] and tighten the two M2xL3 screws that secure the I/O daughterboard to the system board [2].

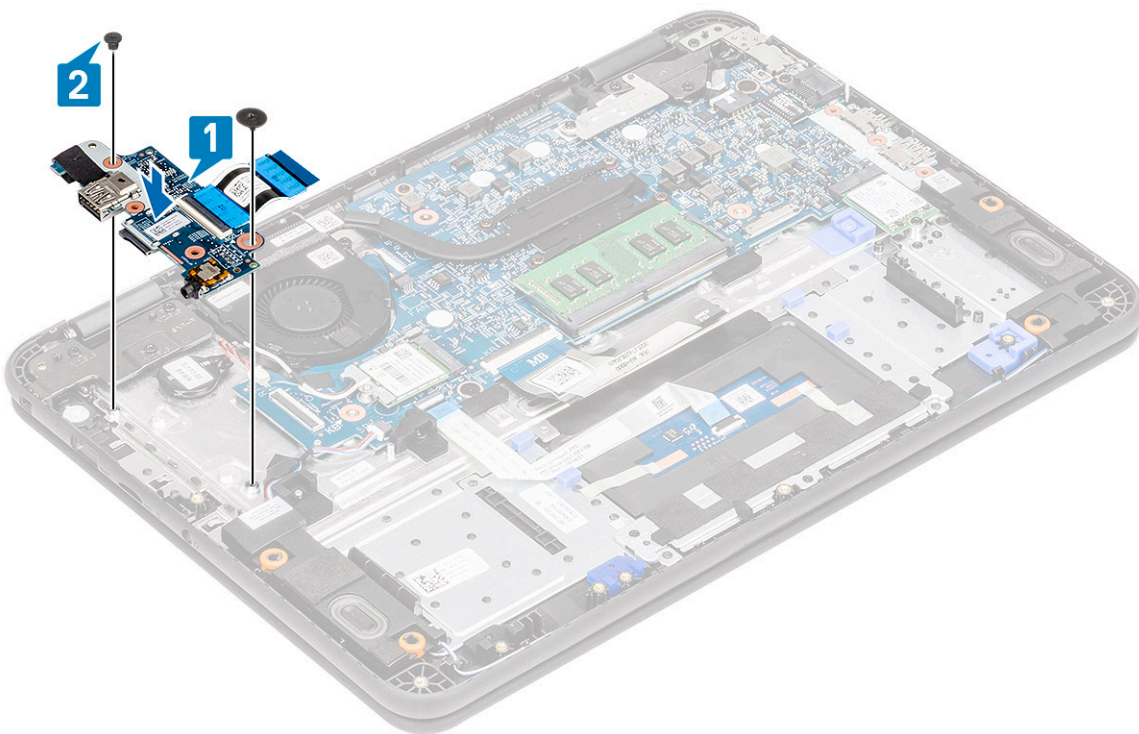

2. Install the FFC cable in the I/O board [1] and flip close the actuator [2].

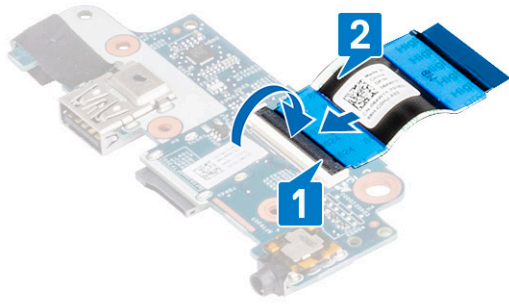

3. Connect the I/O daughterboard FFC cable to the system board.

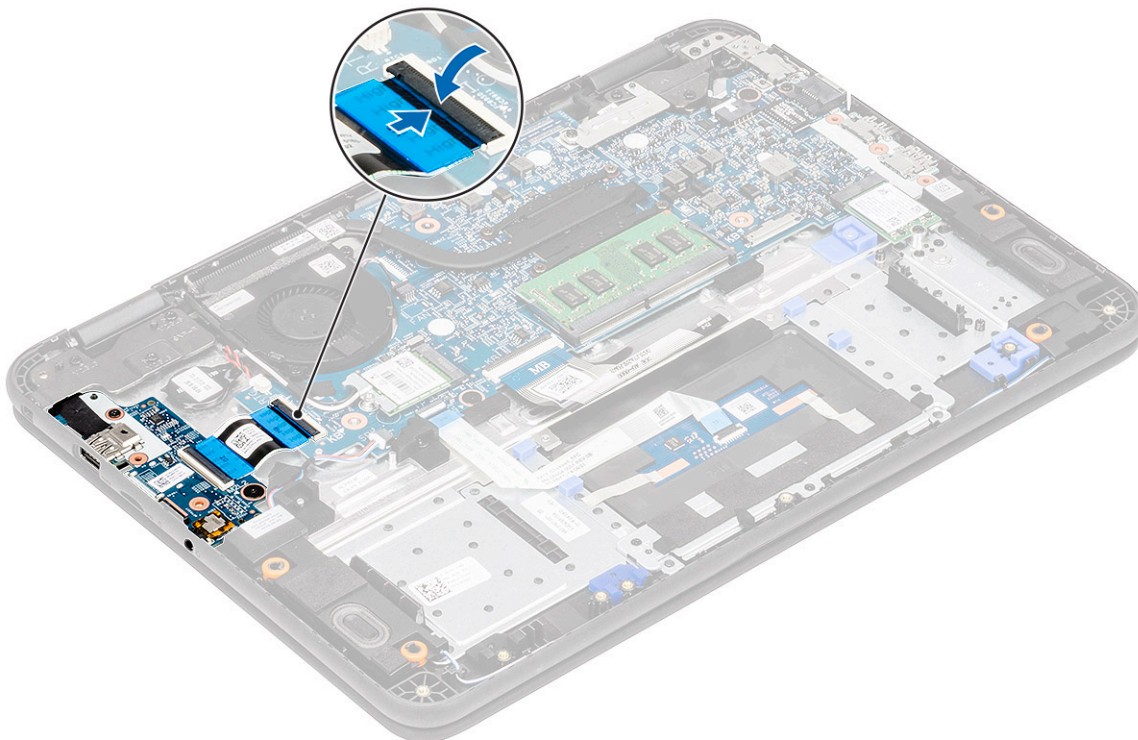

4. Install the:
 - a) battery
 - b) base cover
 - c) microSD card
5. Follow the procedure in [After working inside your computer](#).

Dc-in cable

Removing the DC-in cable

1. Follow the procedure in [Before working inside your computer](#).
2. Remove the:
 - a) microSD card
 - b) base cover

c) **battery**

3. Disconnect the DC-in cable from its connector on the system board [1].
4. Remove the two M2L4 screws securing the DC-in port to the palmrest and the system board [2].
5. Flip over the metal bracket on the USB Type-C port of the system board [3].
6. Lift to remove the DC-in port from the computer [4].

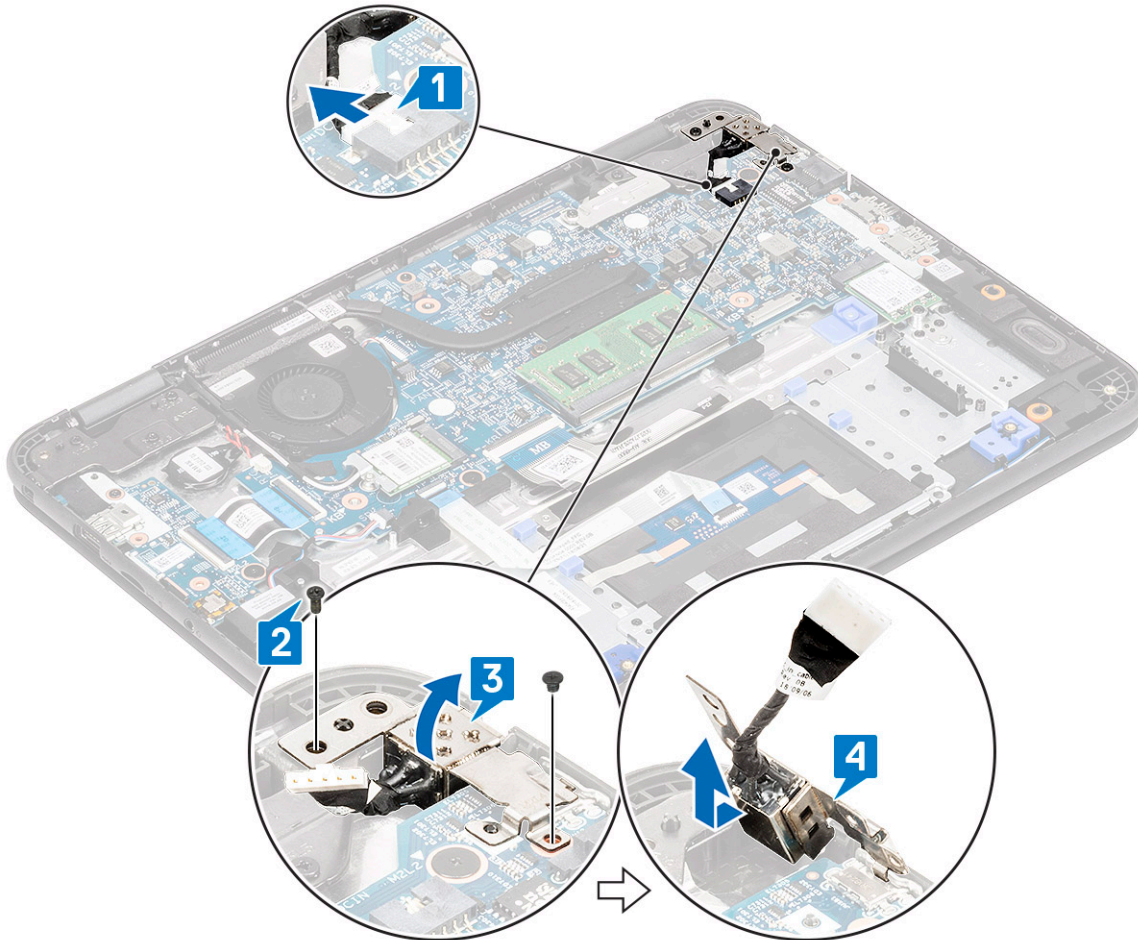

Installing the DC-in cable

1. Install the DC-in port in the computer aligning it with the notch in the chassis [1].
2. Ensure that the metal bracket sits flush on the USB Type-C port, aligning with screw holes on the system board [2].
3. Tighten the two M2xL4 screws securing the DC-in to the motherboard and palmrest [3].
4. Connect the DC-in cable to the system board [4].

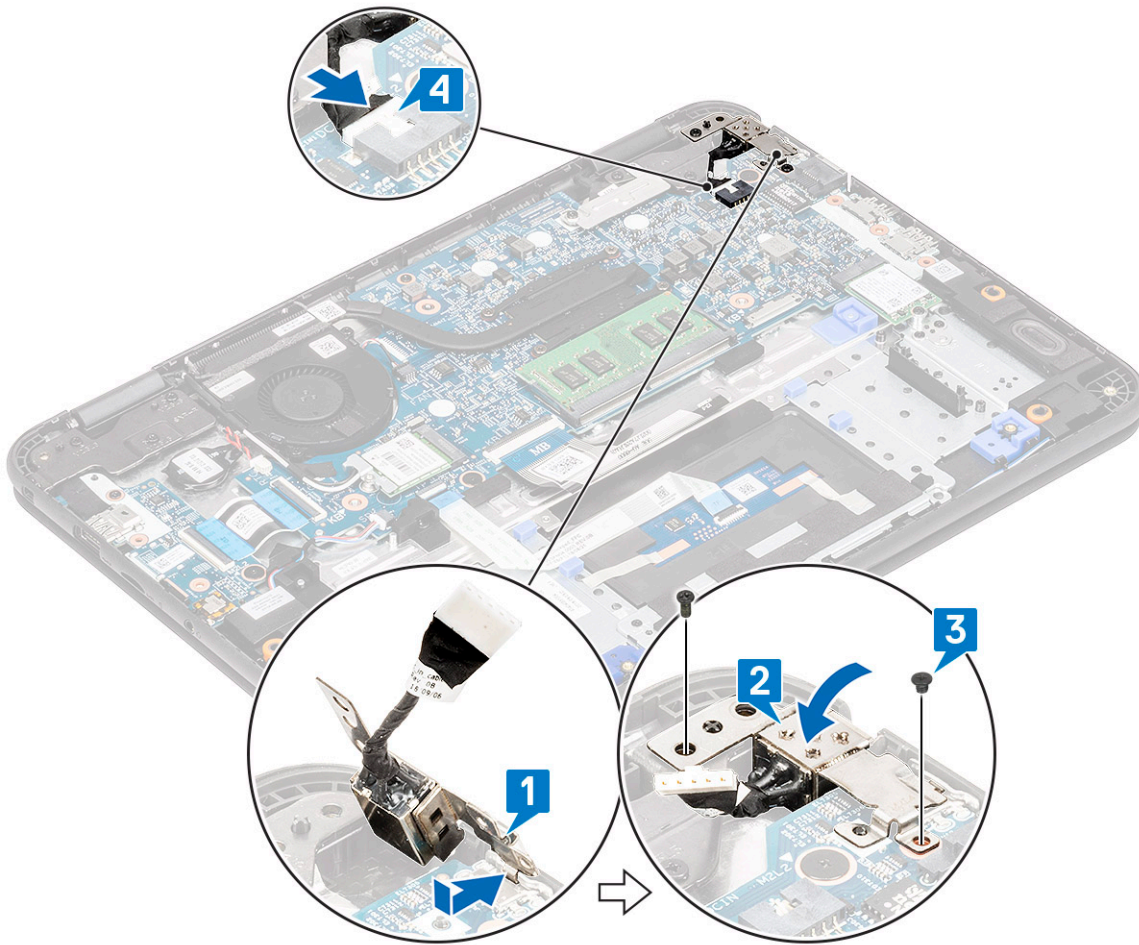

5. Install the:
 - a) battery
 - b) base cover
 - c) microSD card
6. Follow the procedure in [After working inside your computer](#).

Heat sink

Removing the heatsink

1. Follow the procedure in [Before working inside your computer](#).
2. Remove the:
 - a) microSD card
 - b) base cover
 - c) battery
3. **NOTE: Follow the diagonal pattern to loosen the screws.**
 Loosen the four captive M2.5x2.5 screws that secure the heat sink to the computer [1].
4. Lift the heatsink away from the computer [2].

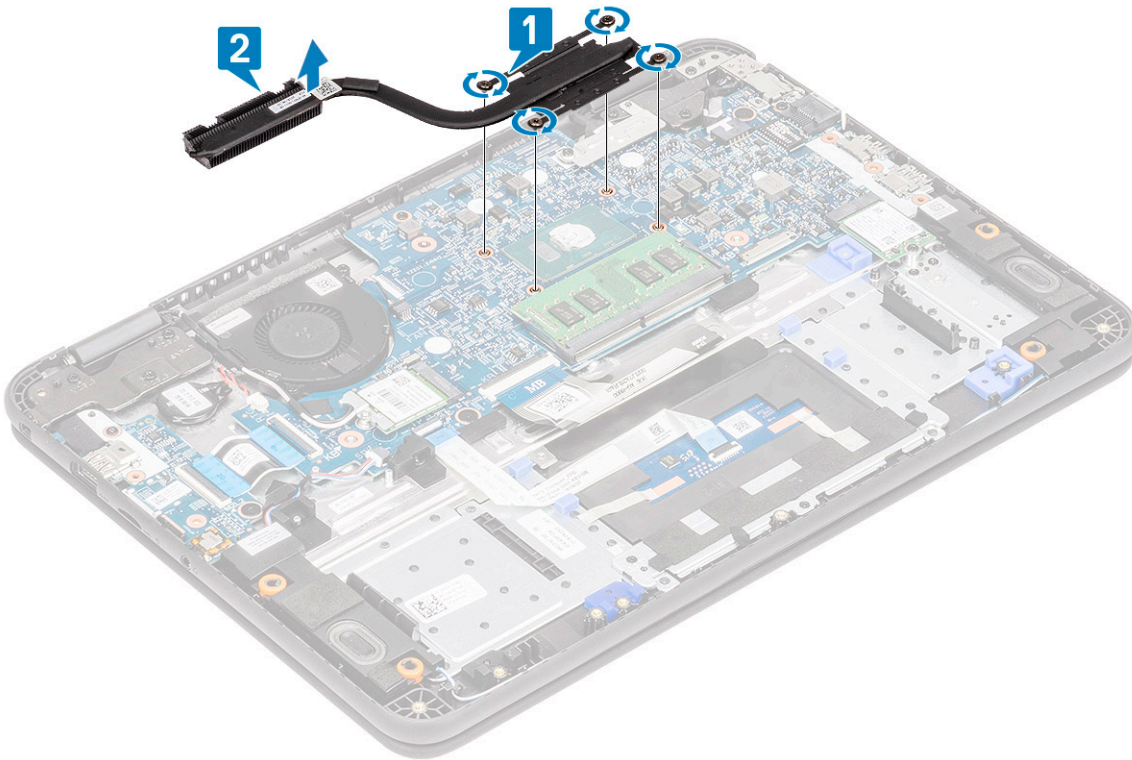

Installing the heatsink

1. Insert the heatsink into the slot on the computer [1].
2. Install the four M2.5x2.5 screws [2] to secure the heatsink to the computer.

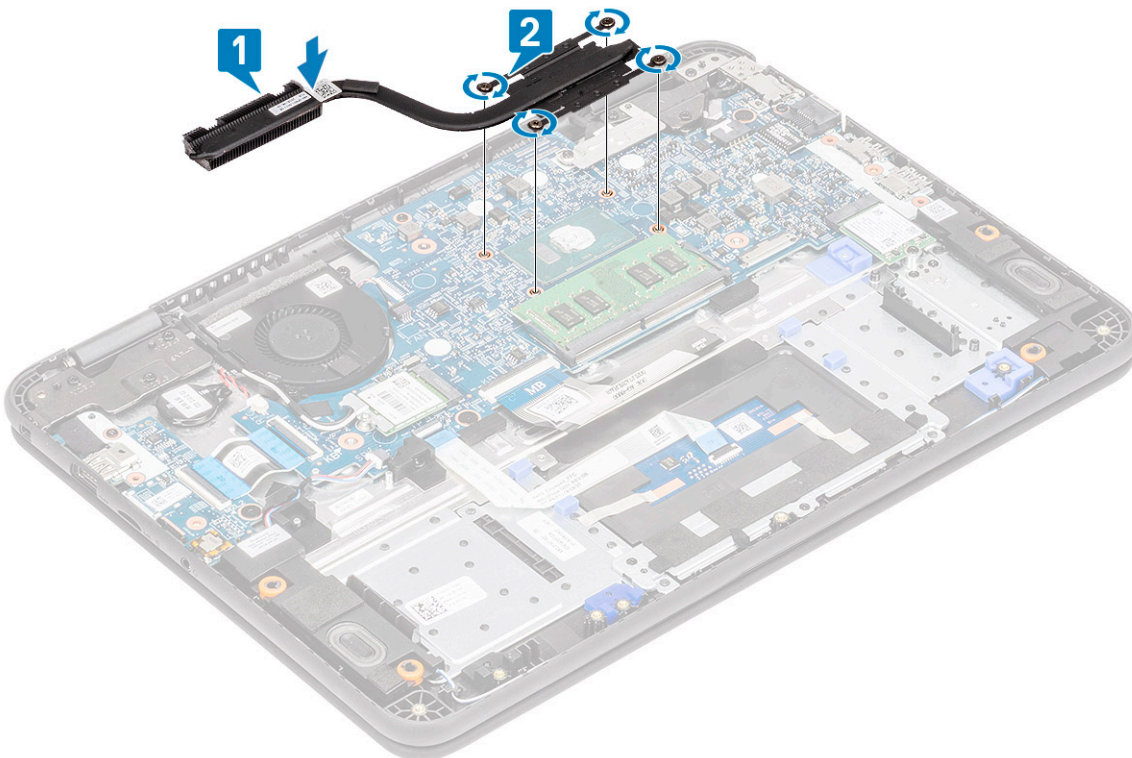

NOTE: Follow the diagonal pattern to tighten the screws, similar to the pattern followed to loosen the screws in "Removing heatsink".

3. Install the:

- a) battery
 - b) base cover
 - c) microSD card
4. Follow the procedure in [After working inside your computer](#).

System Fan

Removing the system fan

1. Follow the procedure in [Before working inside your computer](#).
2. Remove the:
 - a) microSD card
 - b) base cover
 - c) battery
3. Unroute and pry out the WLAN antennae cable from the hook near the fan case [1].
4. Disconnect the system fan connector from the system board [2].

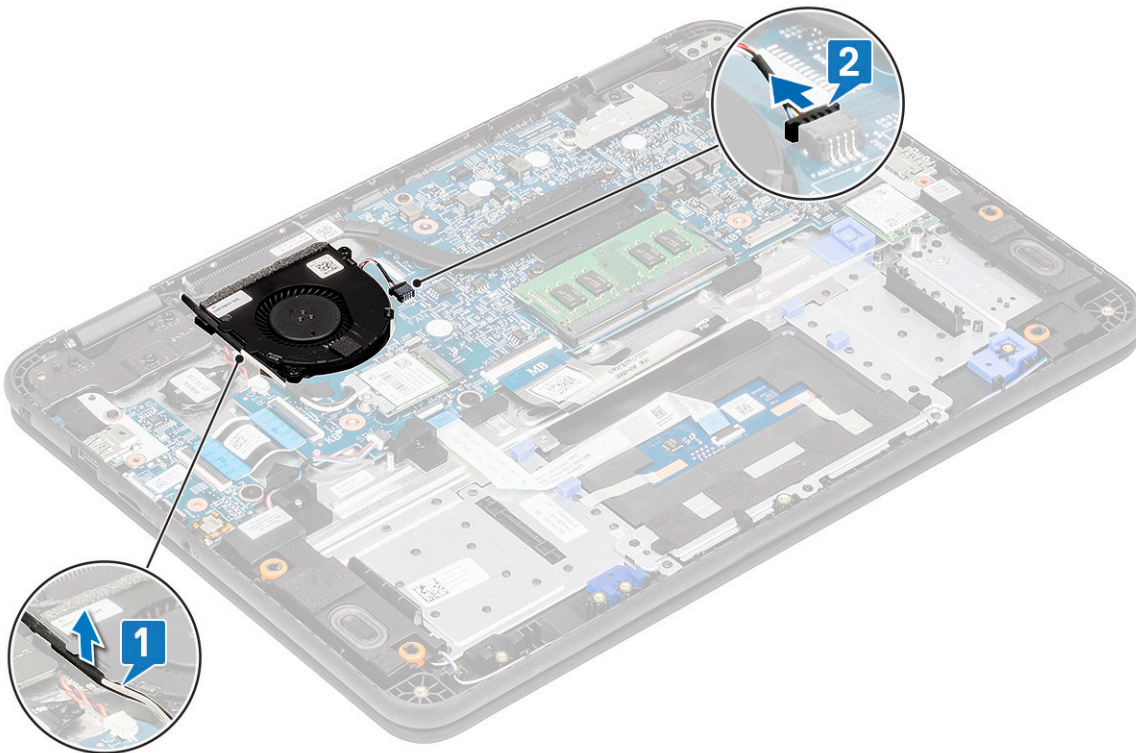

5. Remove the two M2xL3 screws [1] that secure the system fan to the palmrest.
6. Lift the system fan off from the palmrest [2].

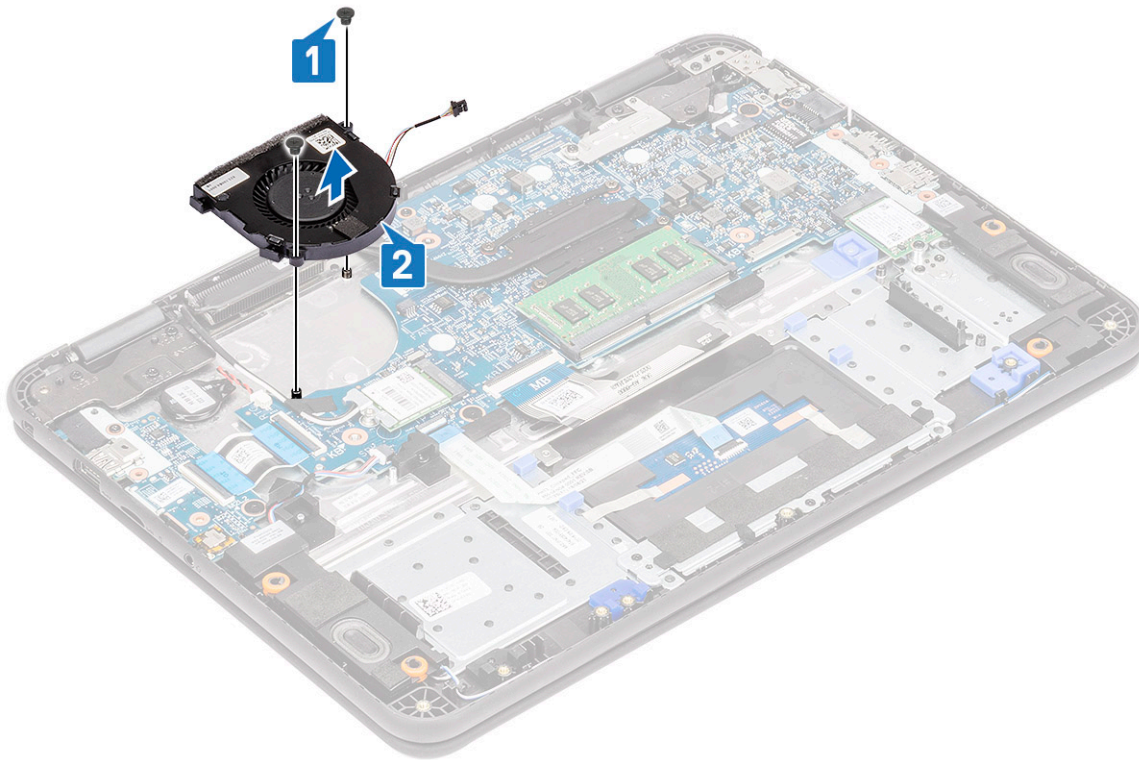

Installing the system fan

1. Place the system fan on the palmrest [1].
2. Install the two M2xL3 screws [2] to secure the system fan to the palmrest.

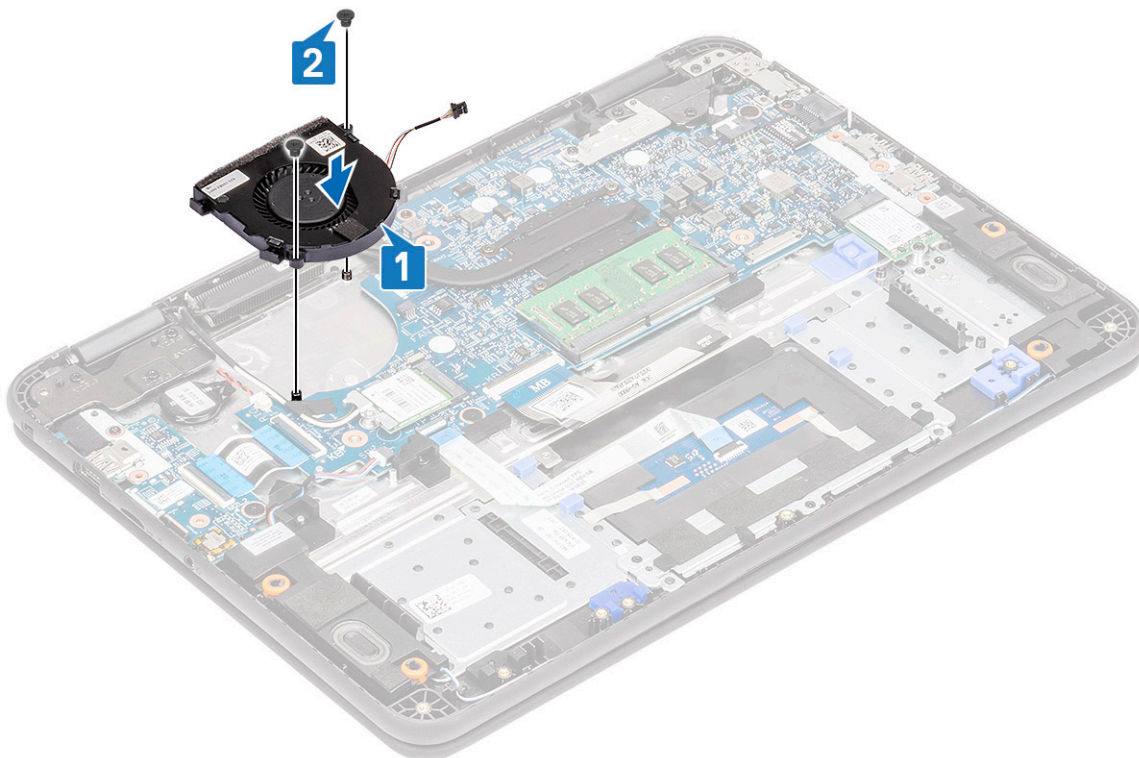

3. Connect the fan cable to the system board [1].
4. Route the WLAN antennae cable along the fan case onto its hook on the system board [2].

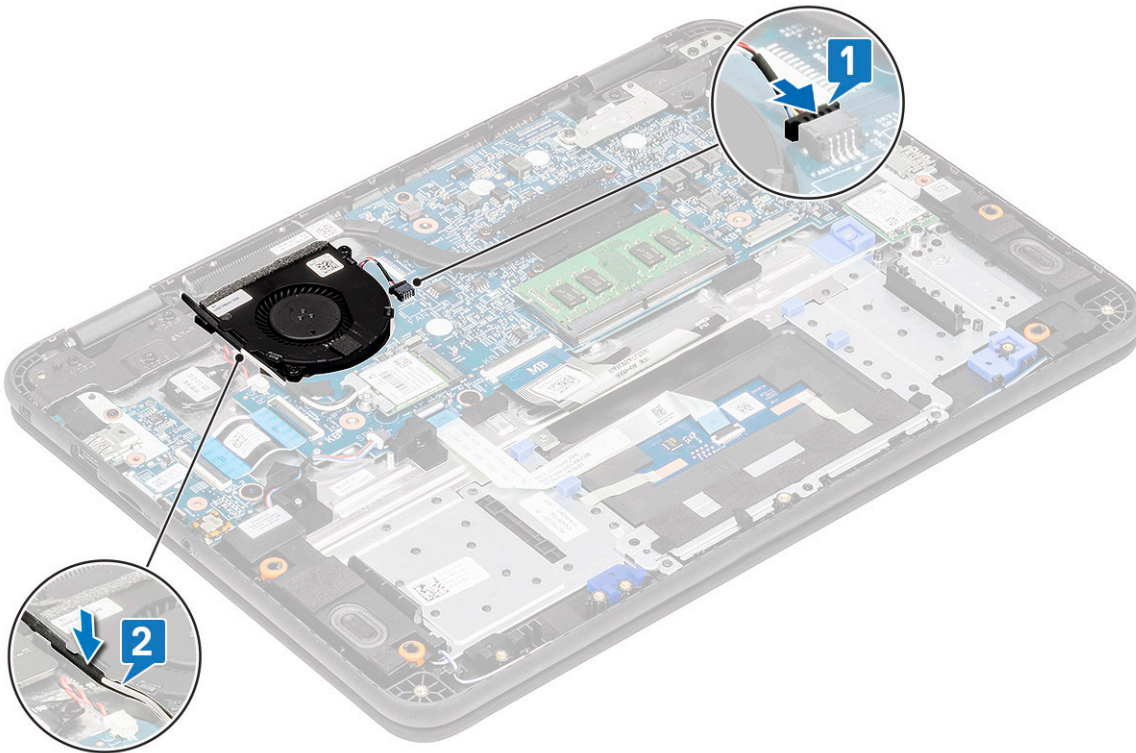

5. Install the:
 - a) [battery](#)
 - b) [base cover](#)
 - c) [microSD card](#)
6. Follow the procedure in [After working inside your computer](#).

WLAN Card

Removing the WLAN card

1. Follow the procedure in [Before working inside your computer](#).
2. Remove the:
 - a) [microSD card](#)
 - b) [base cover](#)
 - c) [battery](#)
3. Remove the single M2xL3 screw that secures the WLAN metal bracket to the computer [1] and lift and remove the metal bracket off the WLAN card [2].
4. Disconnect the two antenna cables [3] and remove the WLAN card from M.2 connector on the system board [4].

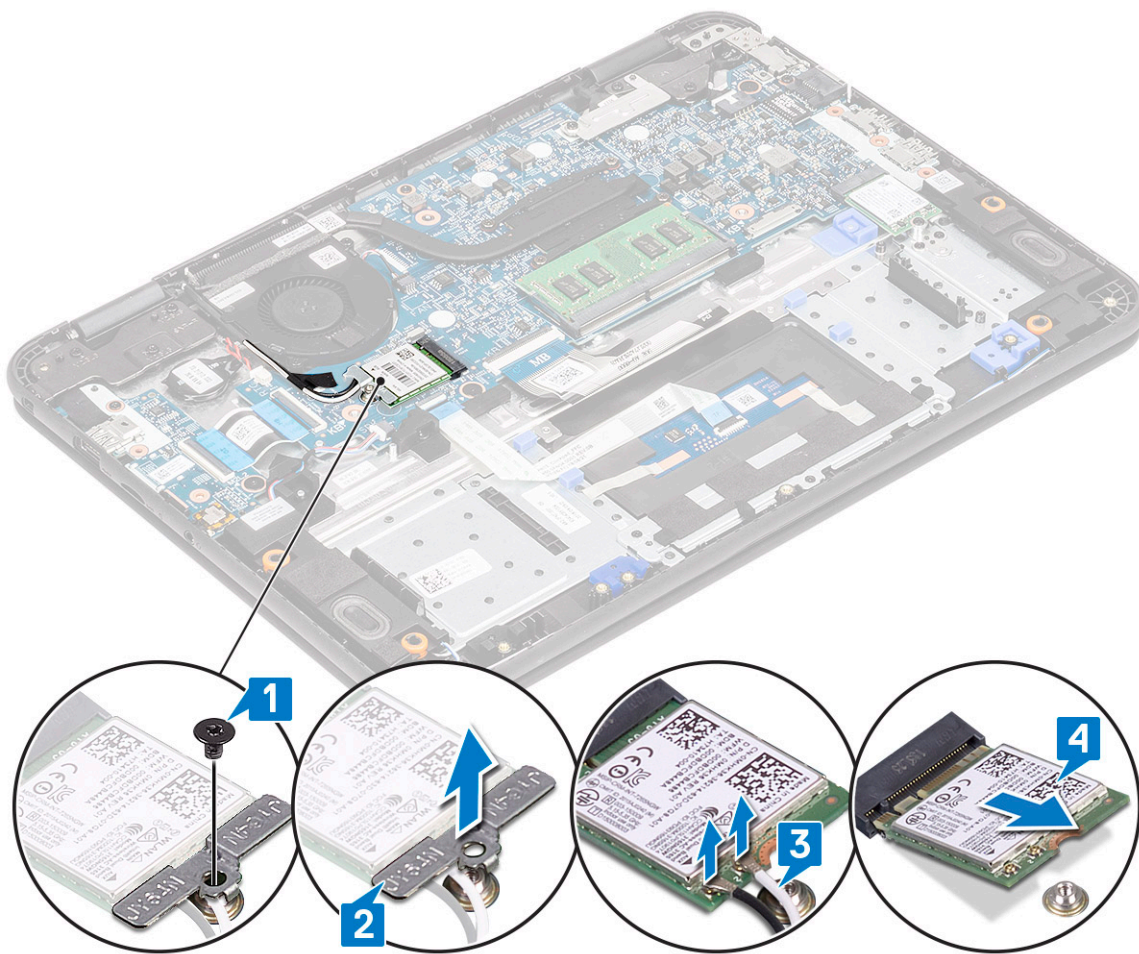

Installing the WLAN card

1. Insert the WLAN card into the M.2 connector on the system board [1].
2. Connect the two antenna cables to the WLAN card [2].
3. Replace the metal bracket on the WLAN [3].
4. Tighten the M2xL3 screw to secure the WLAN card and bracket to the system board [4].

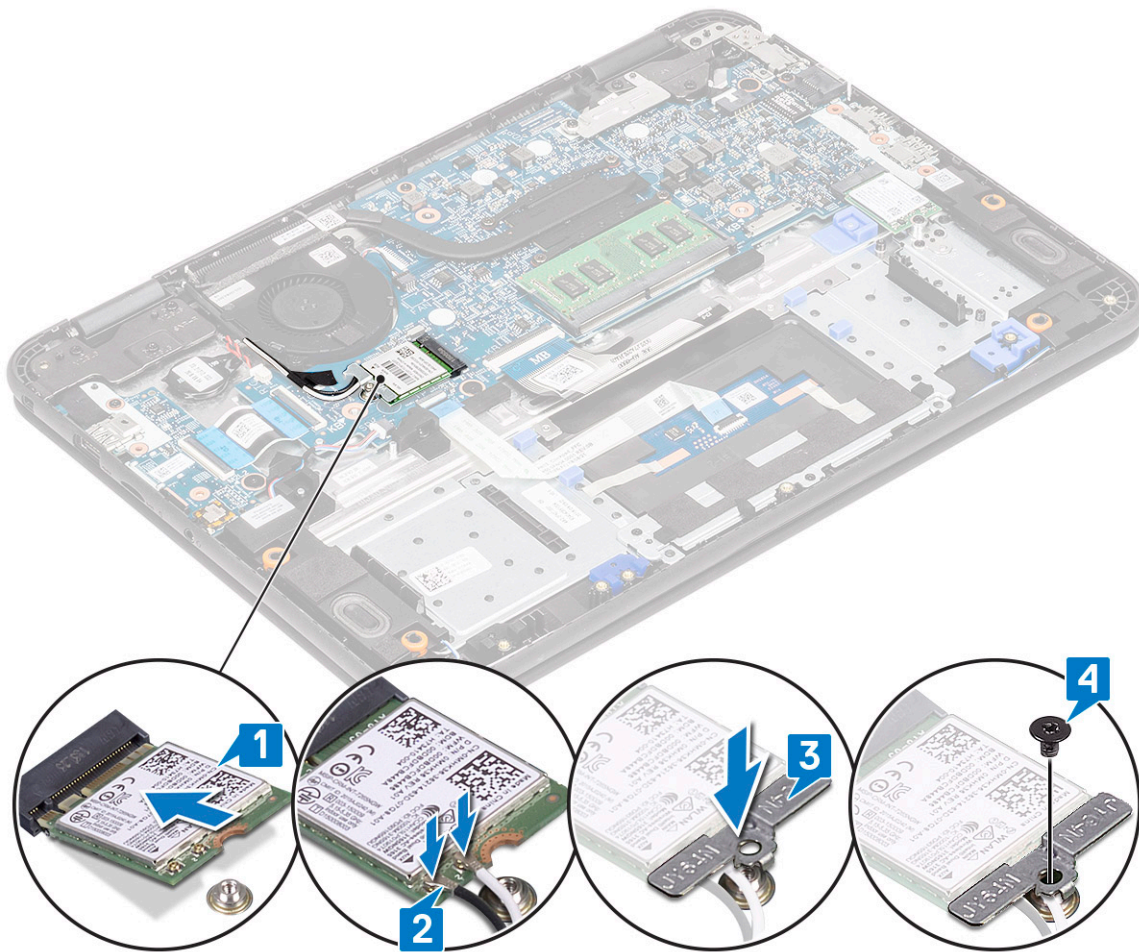

5. Install the:
 - a) battery
 - b) base cover
 - c) microSD card
6. Follow the procedure in [After working inside your computer](#).

Display assembly

Removing the display assembly

NOTE: This process is for both touch and non-touch LCDs.

1. Follow the procedure in [Before working inside your computer](#).
2. Remove the:
 - a) microSD card
 - b) base cover
 - c) battery
 - d) WLAN card
 - e) DC-in cable
3. Remove the tape [1] and unrout the antennae cable [2] near the fan case.
4. Remove the single screw that secures the EDP bracket [3] and remove it off the EDP connector on the system board [4].
5. Disconnect the EDP cable from the system board [5].

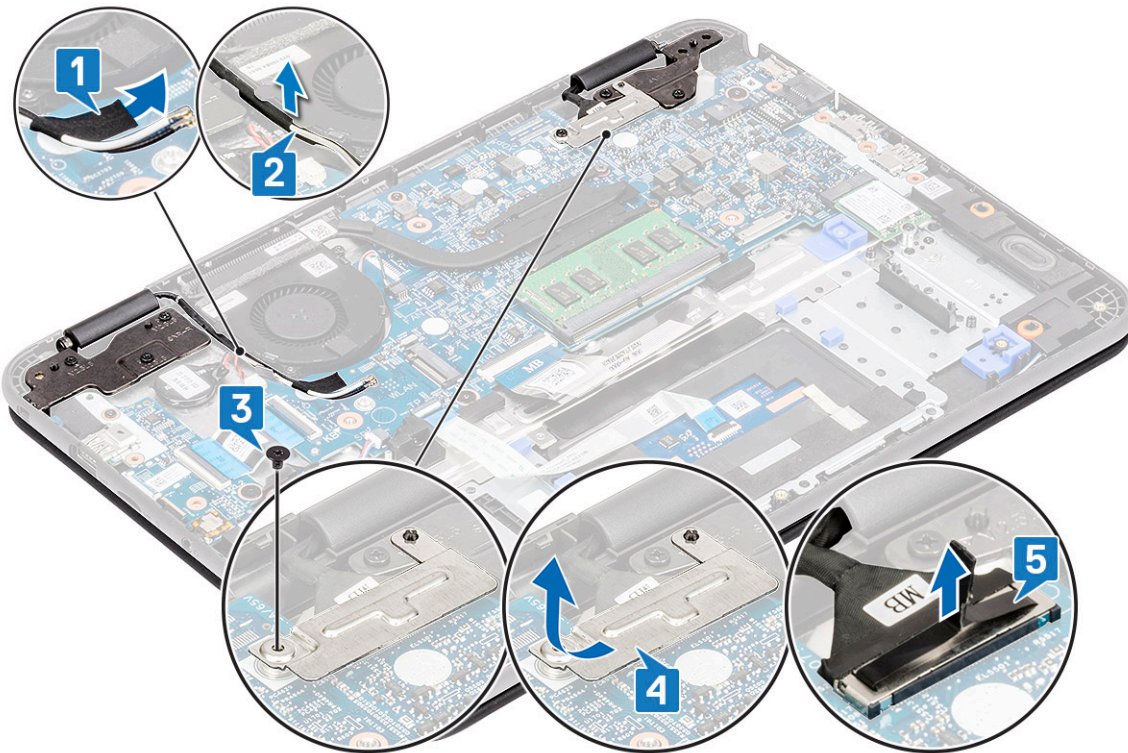

6. Remove the five M1.6xL2 screws securing the LCD hinges to the computer.

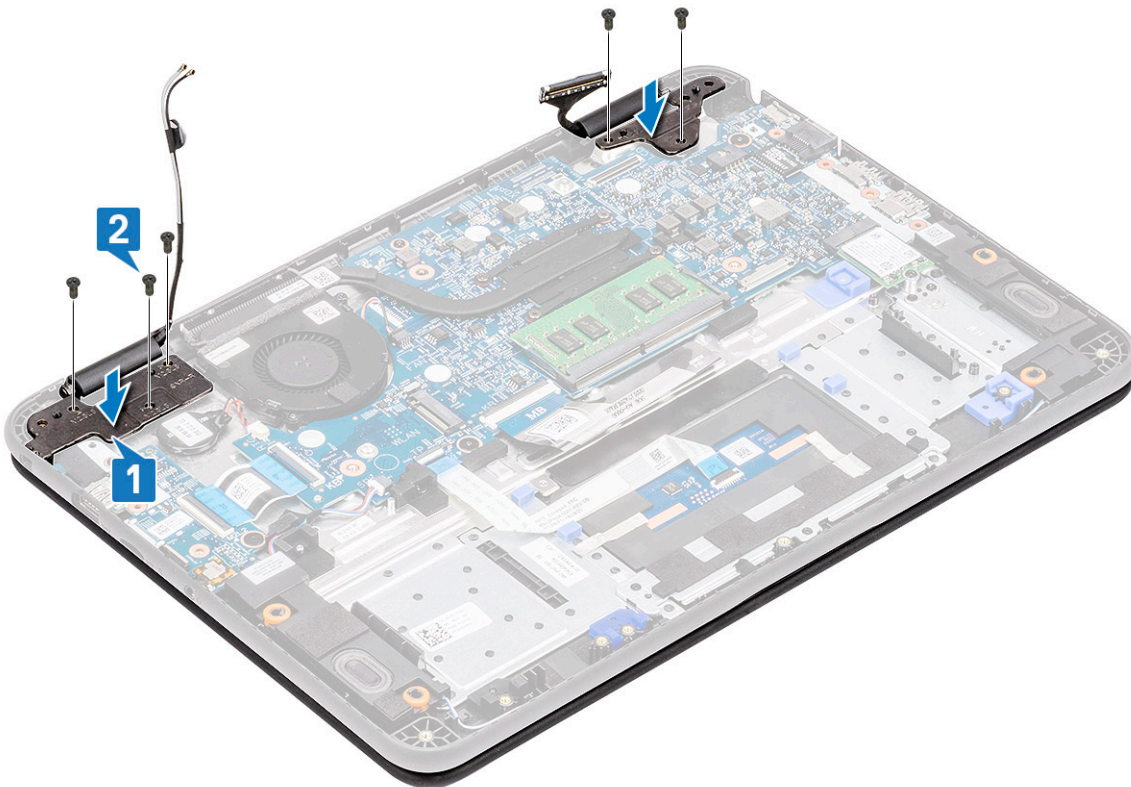

7. Open the lid slightly.



8. Separate the hinges from the palmrest and separate the display assembly from the computer.

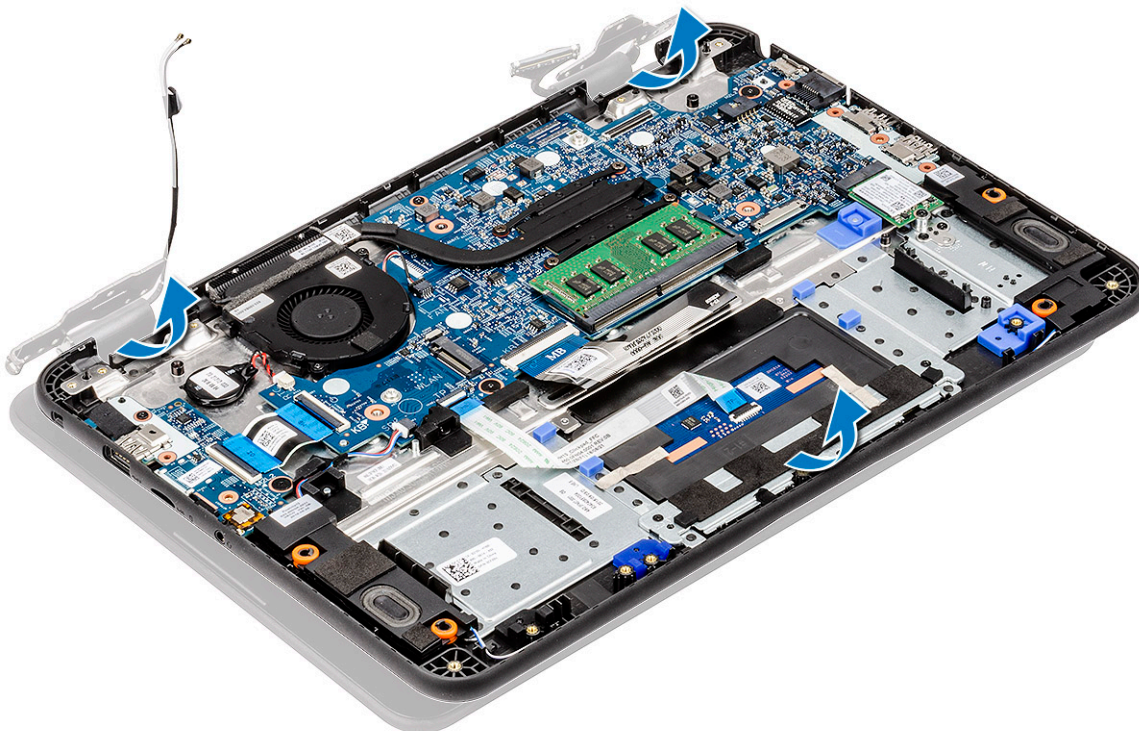

Installing the display assembly

1. Install the display assembly aligning the hinges caps on the palmrest.

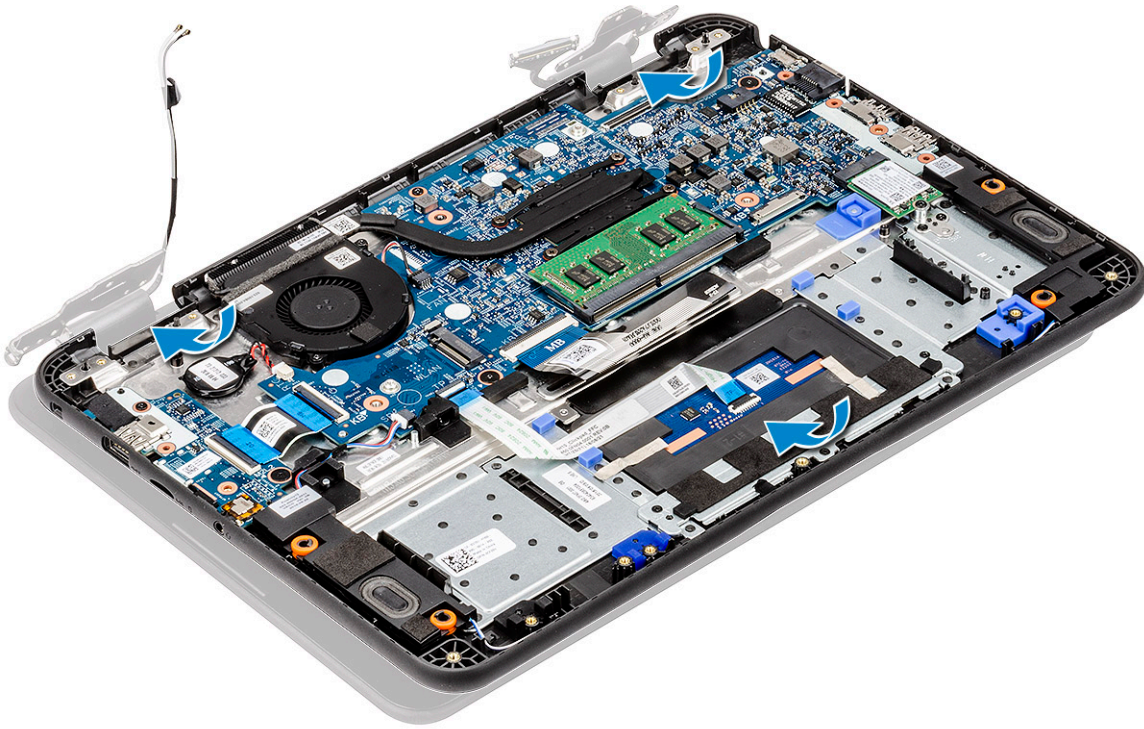

2. Align the hinges to the screw holes on the system board [1] and tighten the five M1.6xL2 screws [2] to secure the display assembly to the computer.

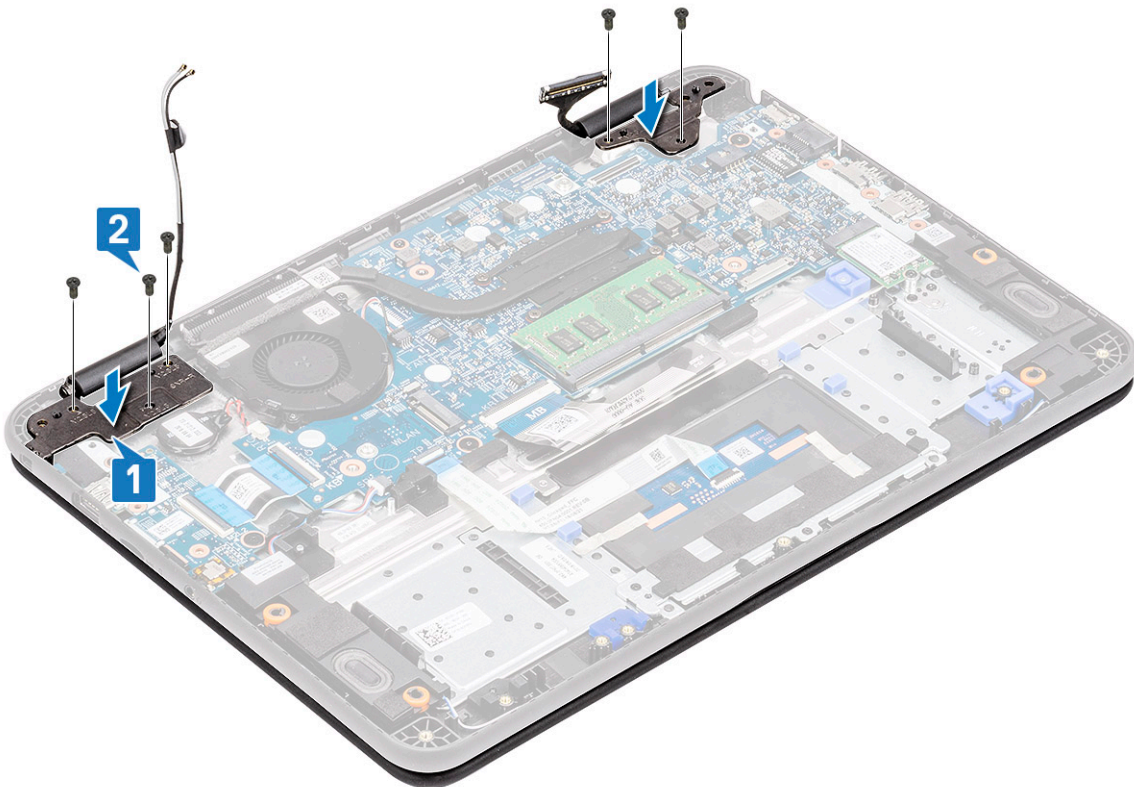

3. Route the antennae cable along the edges of the fan case [1] and stick a piece of tape [2] to secure it to the system board.
4. Connect the EDP cable [3] and place the EDP bracket on the connector [4] and secure it to system board using the single screw [5].

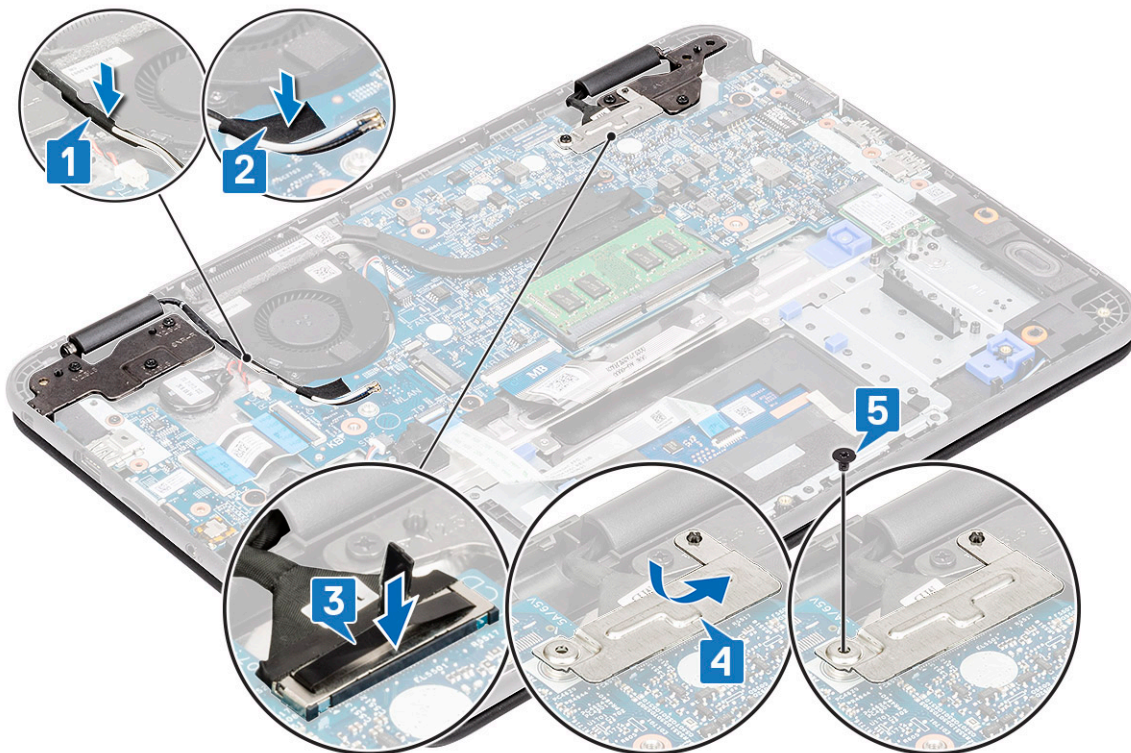

5. Install the:
 - a) DC-in cable
 - b) WLAN card
 - c) battery
 - d) base cover
 - e) microSD card
6. Follow the procedure in [After working inside your computer](#).

Display bezel

Removing the display bezel

1. Follow the procedure in [Before working inside your computer](#).
2. Remove the:
 - a) microSD card
 - b) base cover
 - c) battery
 - d) WLAN card
 - e) DC-in cable
 - f) display assembly
3. Remove the screw protector caps [1] and remove the two M2L4 screws securing the bezel [2] to the back cover.

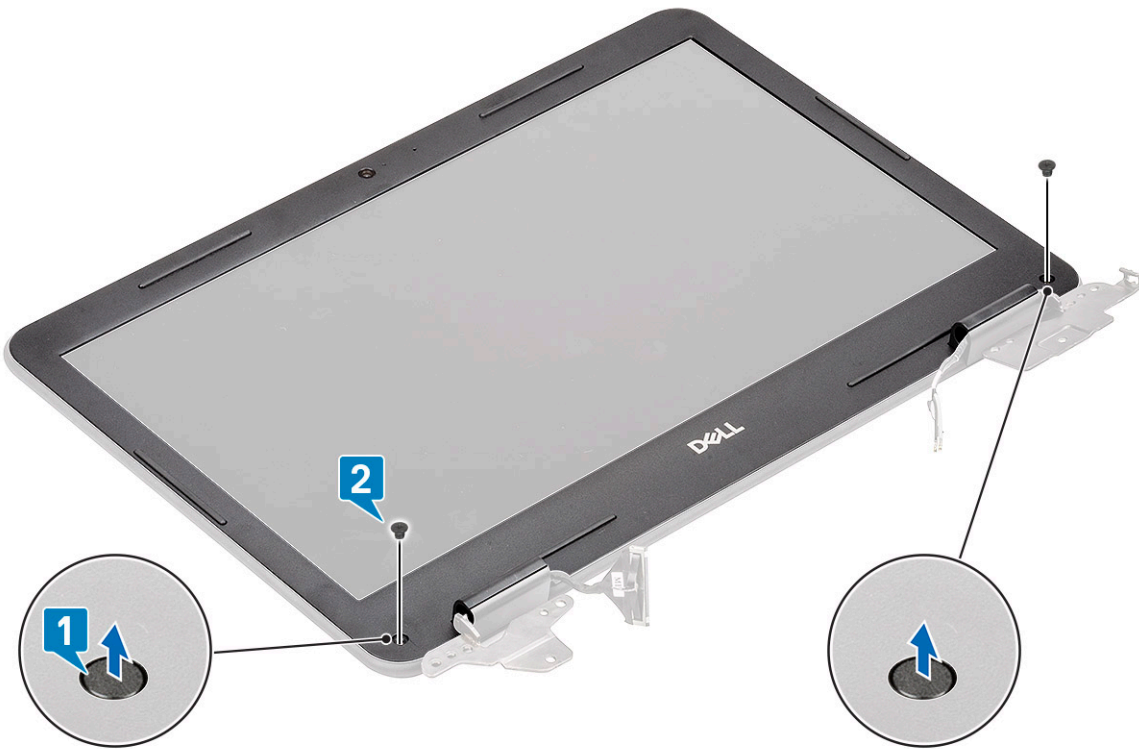

4. Pry from all sides along the inside of the LCD panel to separate the LCD bezel from the back cover.



5. Lift and remove the display bezel from the display assembly.



Installing the display bezel

1. Place the bezel on the LCD back cover preassembled with LCD panel.



2. Press along the edges of the LCD to clip the LCD back cover to the bezel.

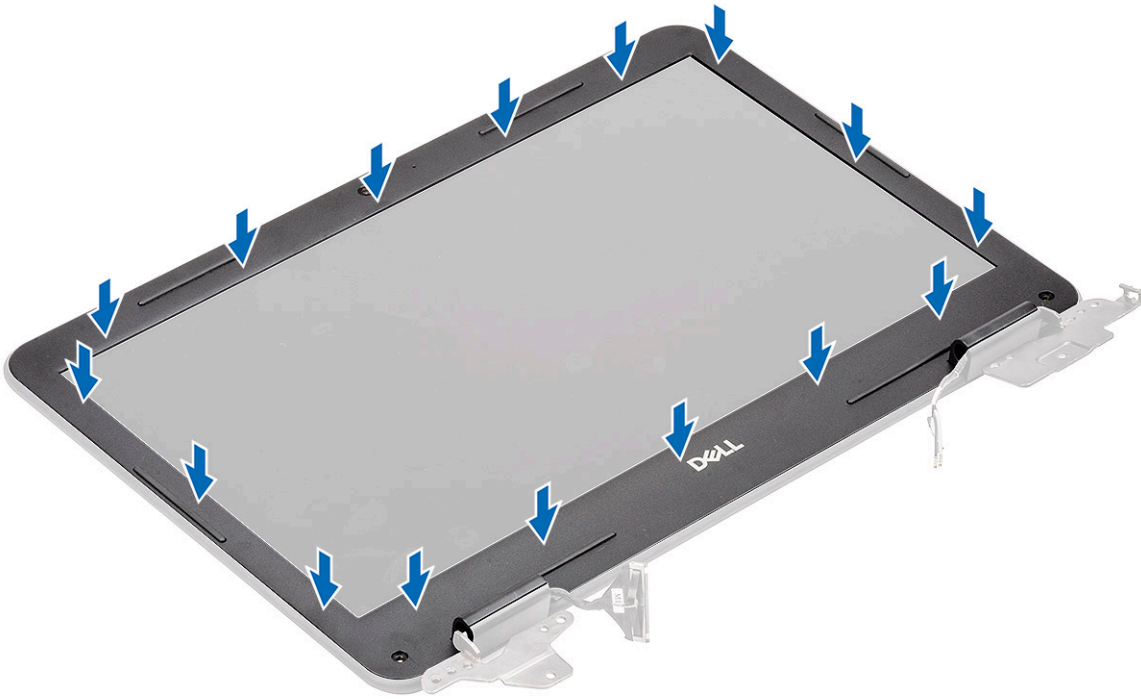

3. Install the two M2L4 screws [1] securing the display bezel to the back cover and install the screw protector caps [2].



4. Install the:
- a) [display assembly](#)
 - b) [DC-in cable](#)
 - c) [WLAN card](#)
 - d) [battery](#)
 - e) [base cover](#)
 - f) [microSD card](#)
5. Follow the procedure in [After working inside your computer](#).

Camera microphone module

Removing the camera-microphone module

1. Follow the procedure in [Before working inside your computer](#).
2. Remove the:
 - a) [microSD card](#)
 - b) [base cover](#)
 - c) [battery](#)
 - d) [WLAN card](#)
 - e) [DC-in cable](#)
 - f) [display assembly](#)
 - g) [display bezel](#)
3. Disconnect the EDP cable from the microphone-camera module [1].
4. Lift the microphone-camera module from the display assembly [2].

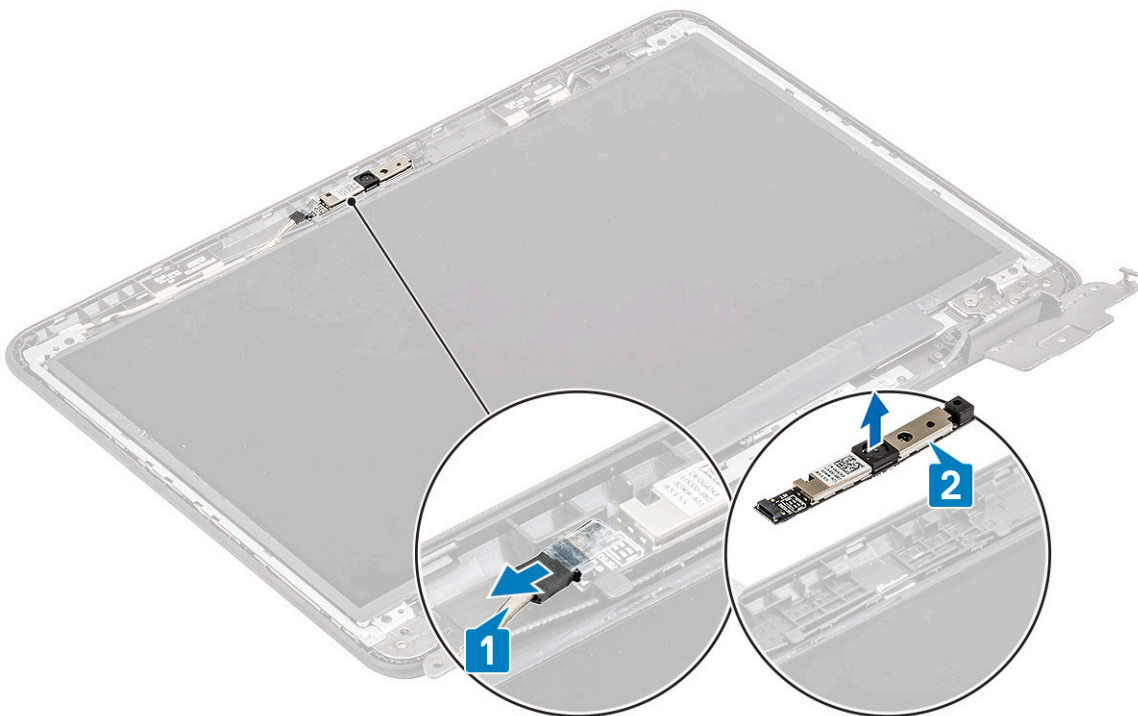

5. Follow the procedure in [After working inside your computer](#).

Installing the camera-microphone module

1. Align and place the camera-microphone module on the LCD back cover assembly [1].
2. Connect the EDP cable to the camera-microphone module [2].

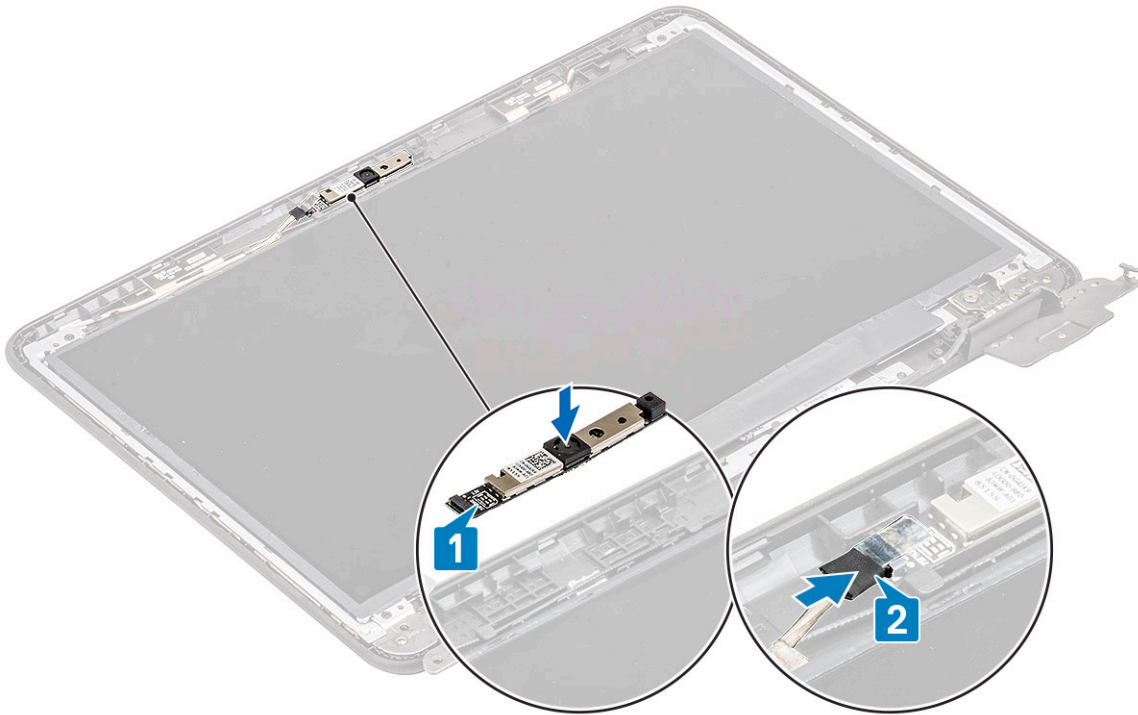

3. Install the:
 - a) display bezel
 - b) display assembly
 - c) DC-in cable
 - d) WLAN card
 - e) battery
 - f) base cover
 - g) microSD card
4. Follow the procedure in [After working inside your computer](#).

LCD panel

Removing the LCD panel

1. Follow the procedure in [Before working inside your computer](#).
2. Remove the:
 - a) microSD card
 - b) base cover
 - c) battery
 - d) WLAN card
 - e) DC-in cable
 - f) display assembly
 - g) LCD bezel
3. Remove the four M2L3 screws [1] securing the LCD panel to the LCD back cover and flip it over [2].

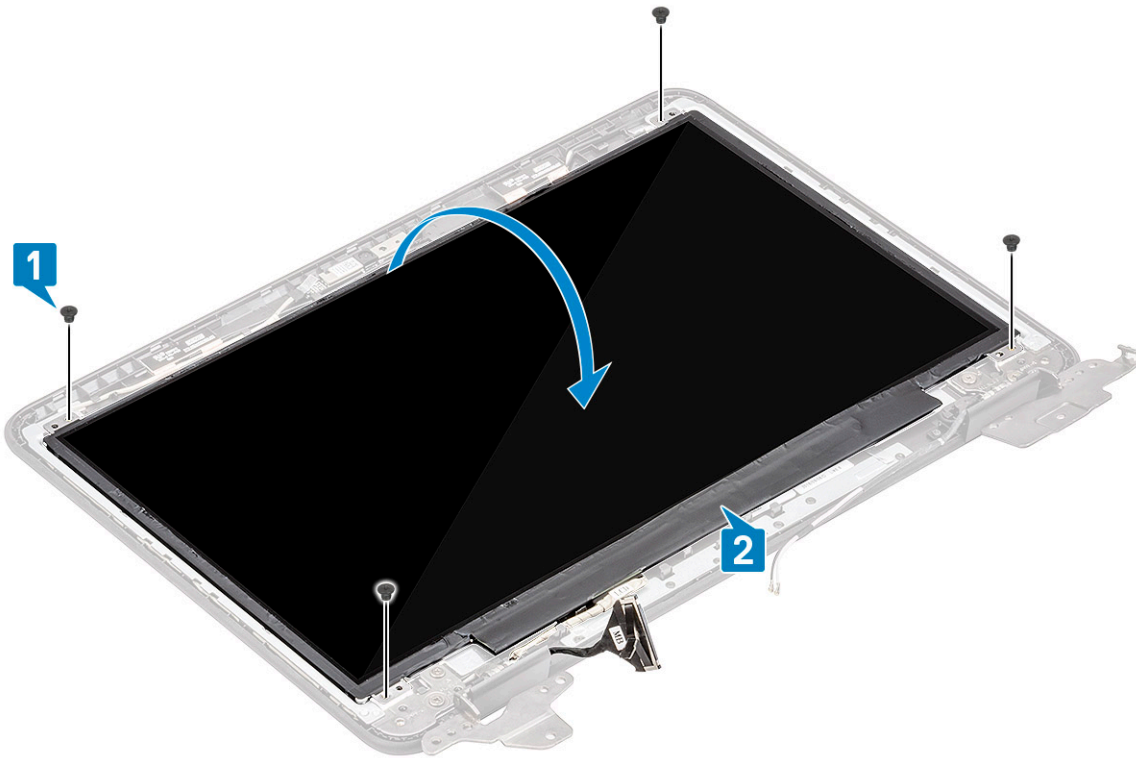

4. Peel off the tape from the EDP connector [1] and open the actuator [2] to disconnect the EDP cable from the system board [3].
5. Lift the LCD panel up and away from the computer [4].

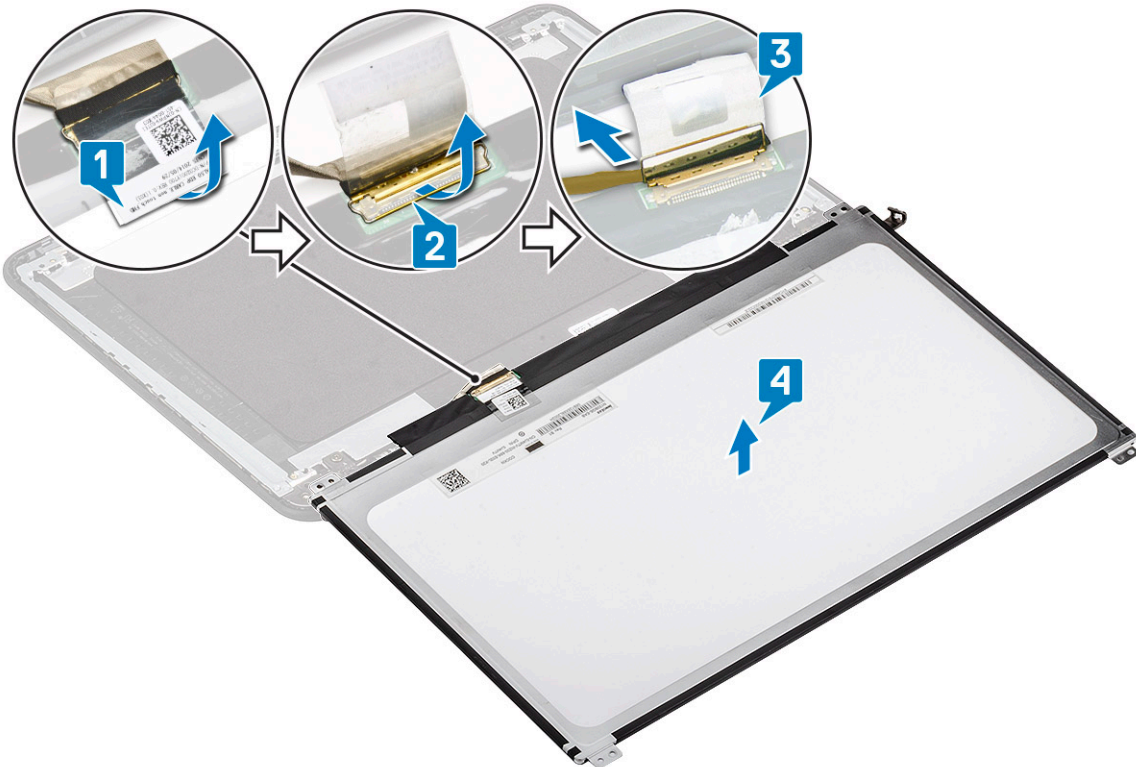

Installing the LCD panel

1. Connect the eDP cable to the system board [1] and while holding the cable close the actuator on the connector [2].
2. Stick the tape on the connector [3] securing the eDP cable to the LCD panel and flip over the LCD panel to rest on the LCD back cover [4].

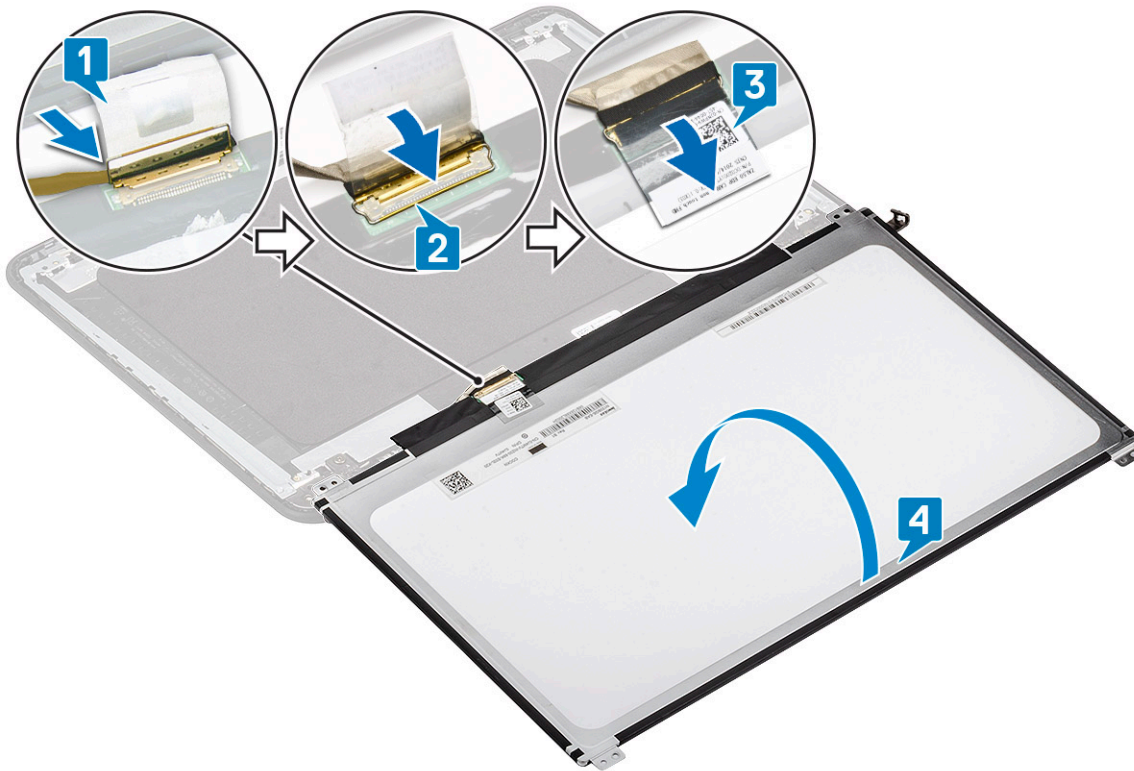

3. Align the LCD panel to the back cover [1] and install the four M2L3 screws to secure the LCD panel to the LCD back cover [2].

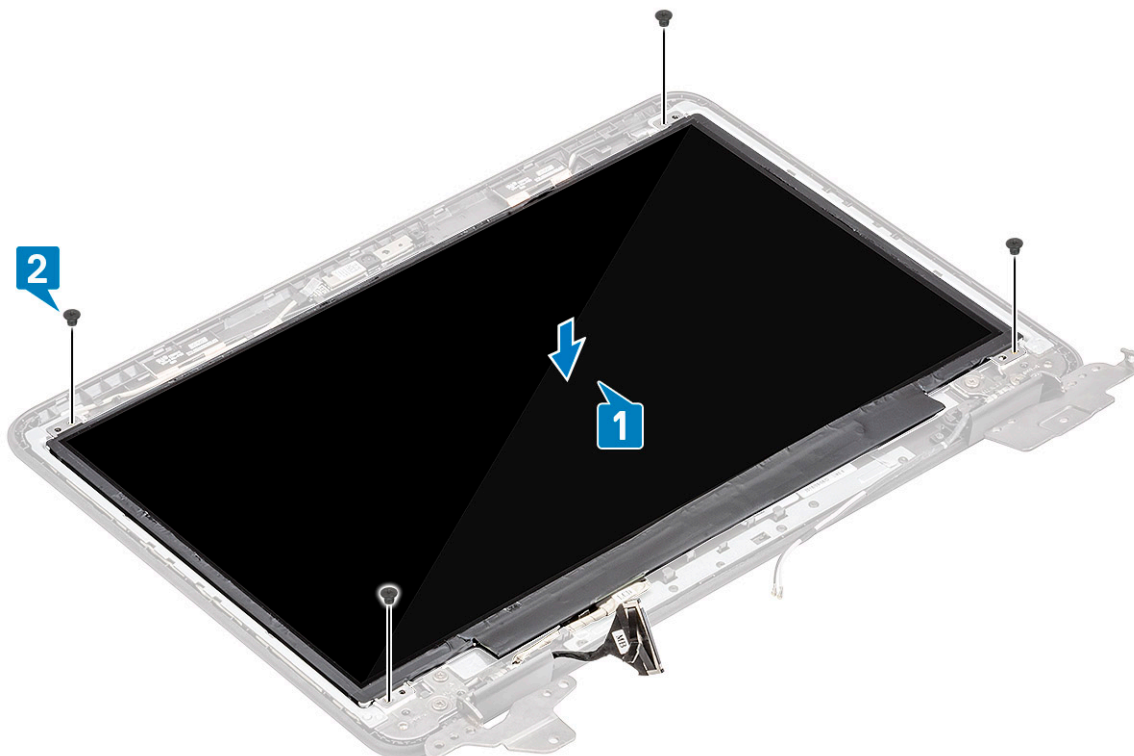

4. Install the:
- a) display bezel
 - b) display assembly
 - c) DC-in cable
 - d) WLAN card
 - e) battery
 - f) base cover

- g) microSD card
- 5. Follow the procedure in [After working inside your computer](#).

eDP cable

Removing the eDP cable

1. Follow the procedure in [Before working inside your computer](#).
2. Remove the:
 - a) microSD card
 - b) base cover
 - c) battery
 - d) WLAN card
 - e) DC-in cable
 - f) display assembly
 - g) LCD bezel
 - h) LCD panel
 - i) Display hinges
3. Peel off the tape securing the eDP cable to the back cover [1] and remove the metal foil [2].

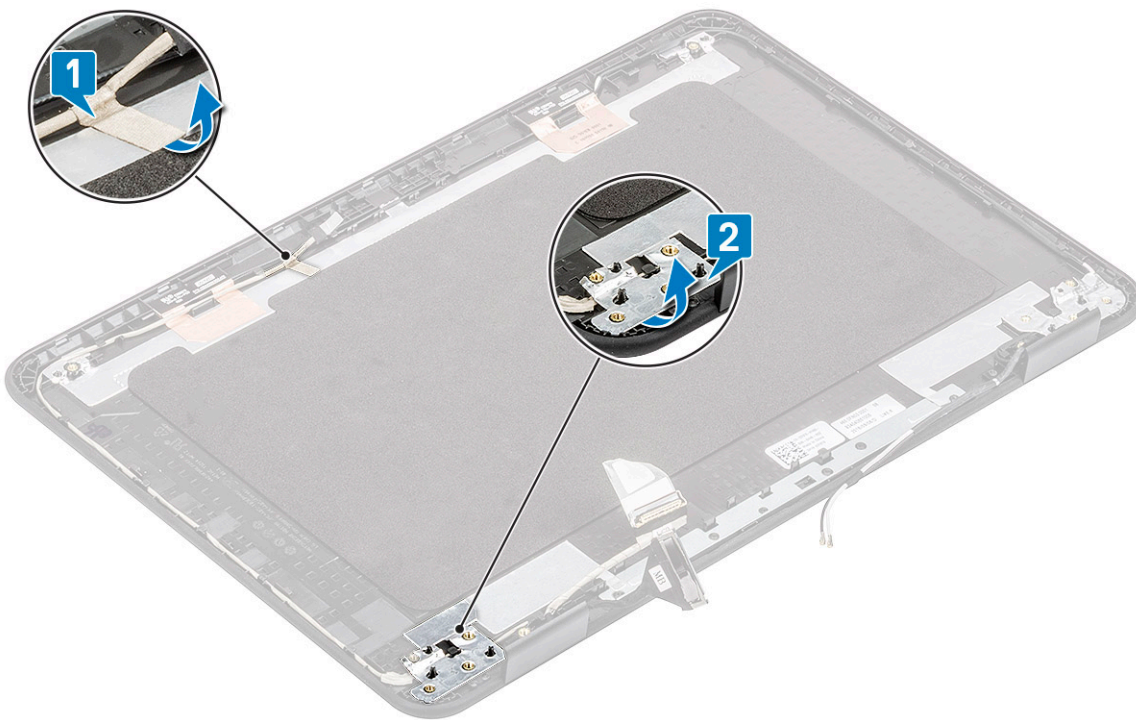

4. Un-route the eDP cable tucked along the back cover and remove the eDP cable from the computer.

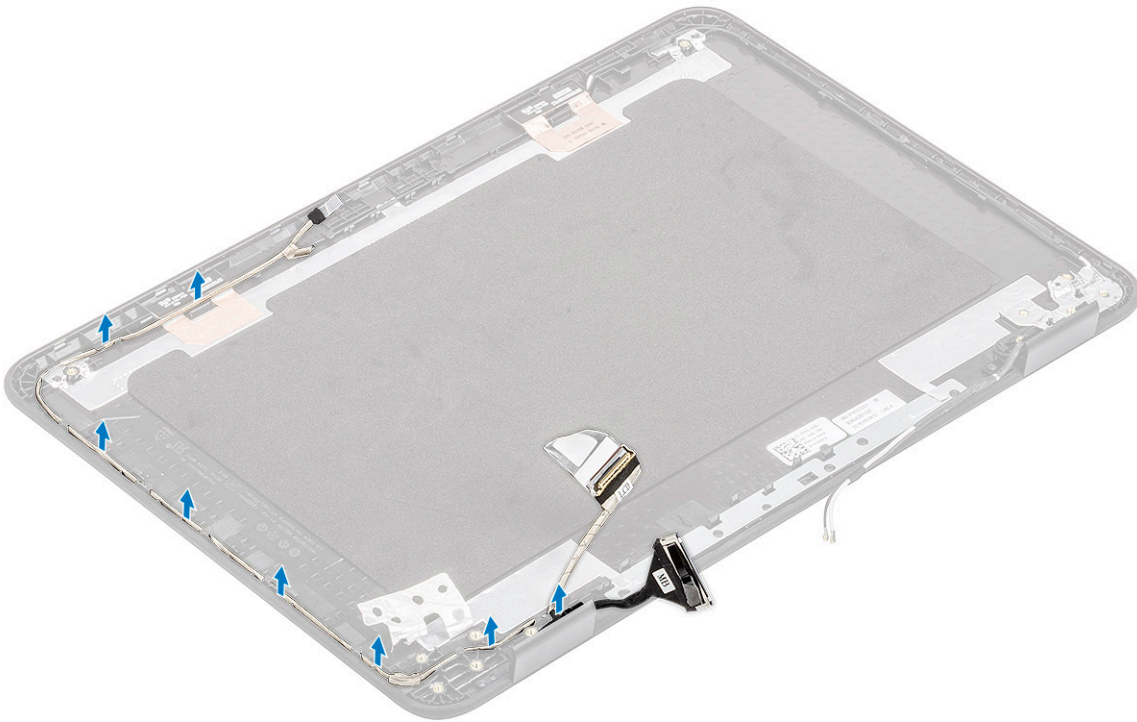

Installing the eDP cable

1. Route the eDP cable along the edges of the LCD back cover.

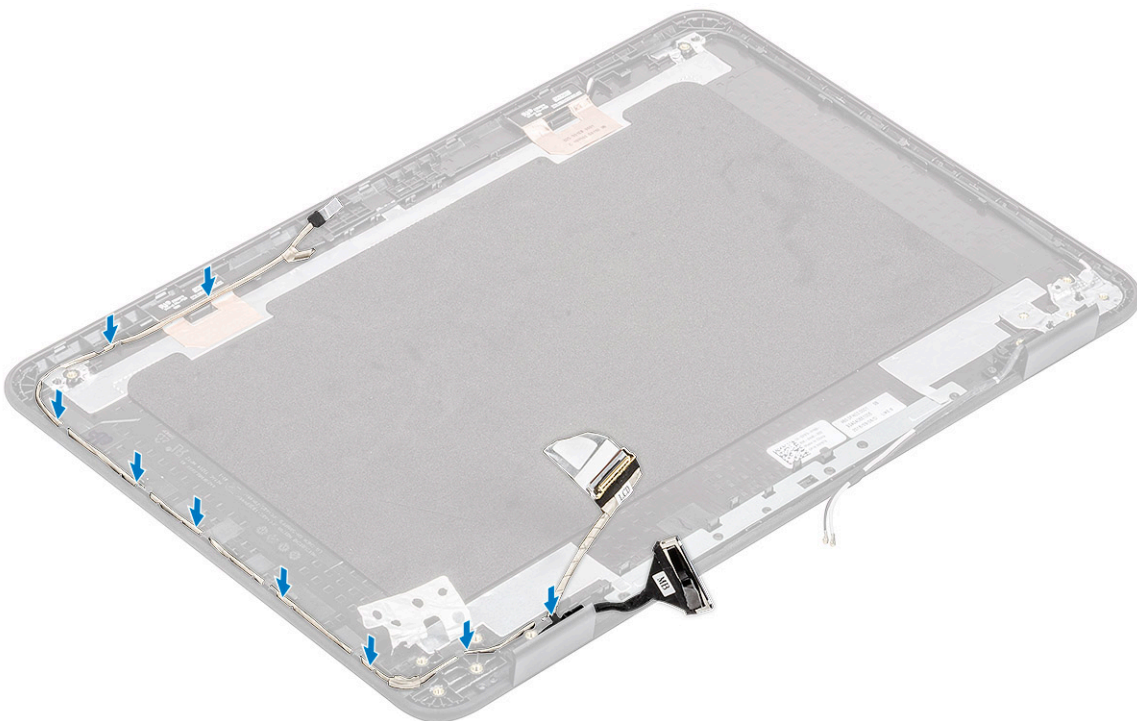

2. Stick the tape securing the eDP cable to the back cover [1] and install the metal foil to secure the eDP cable to the LCD back cover [2].

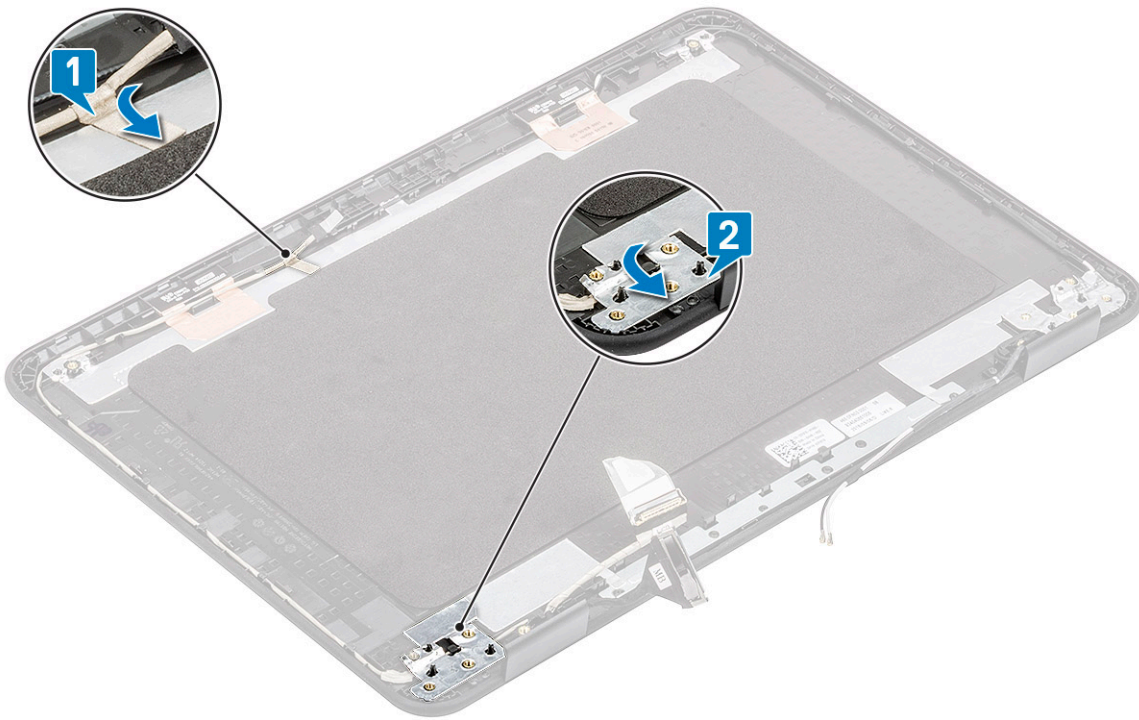

3. Install the:
 - a) [Display hinges](#)
 - b) [LCD panel](#)
 - c) [display bezel](#)
 - d) [display assembly](#)
 - e) [DC-in cable](#)
 - f) [WLAN card](#)
 - g) [battery](#)
 - h) [base cover](#)
 - i) [microSD card](#)
4. Follow the procedure in [After working inside your computer](#).

Display hinges

Removing the display hinges

1. Follow the procedure in [Before working inside your computer](#).
2. Remove the:
 - a) [microSD card](#)
 - b) [base cover](#)
 - c) [battery](#)
 - d) [WLAN card](#)
 - e) [DC-in cable](#)
 - f) [display assembly](#)
 - g) [LCD bezel](#)
 - h) [LCD panel](#)
3. Remove the six M2.5L5 screws on either side securing the hinges to the back cover [1].
4. Angle the hinges and lift the hinges up and away from the back cover [2].

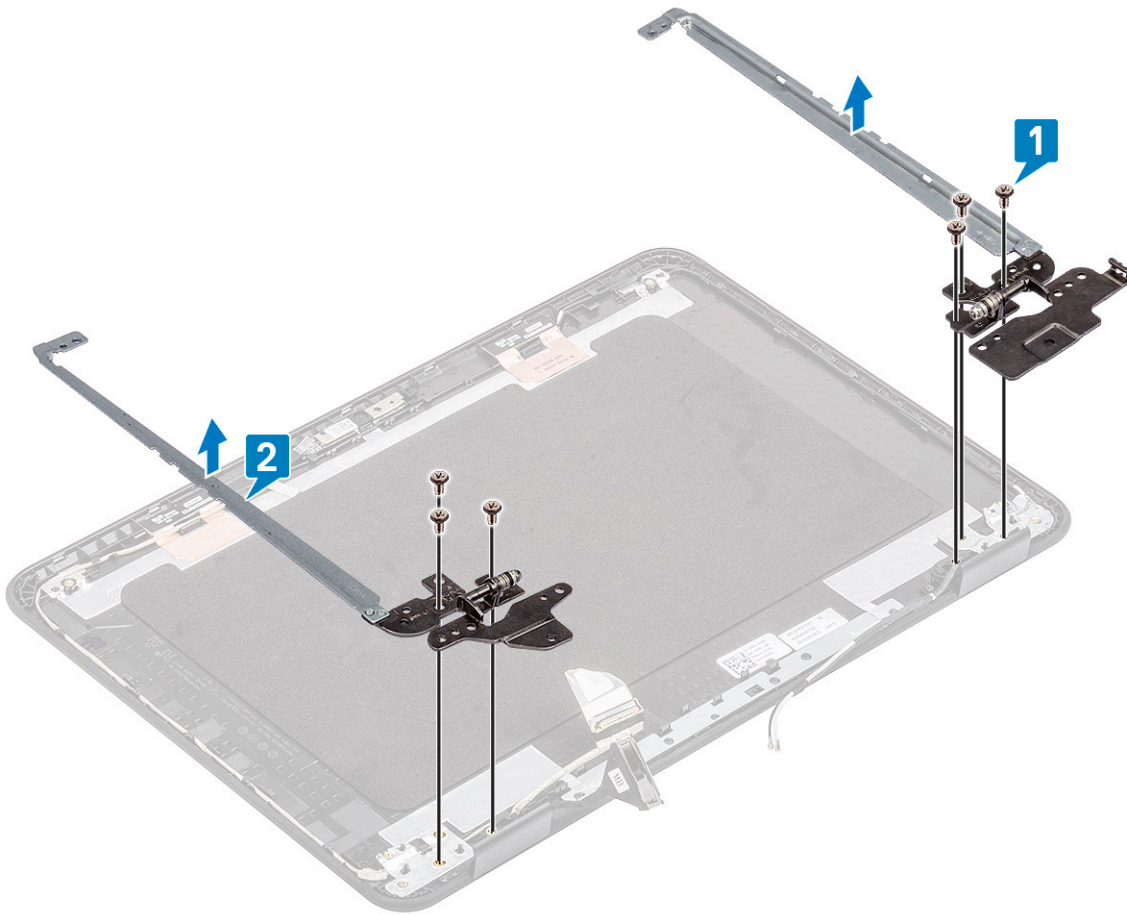

Installing the display hinges

1. Angle the hinges and install the hinges on the LCD back cover [1].
2. Install the six M2.5L5 screws securing the hinges to the LCD back cover [2].

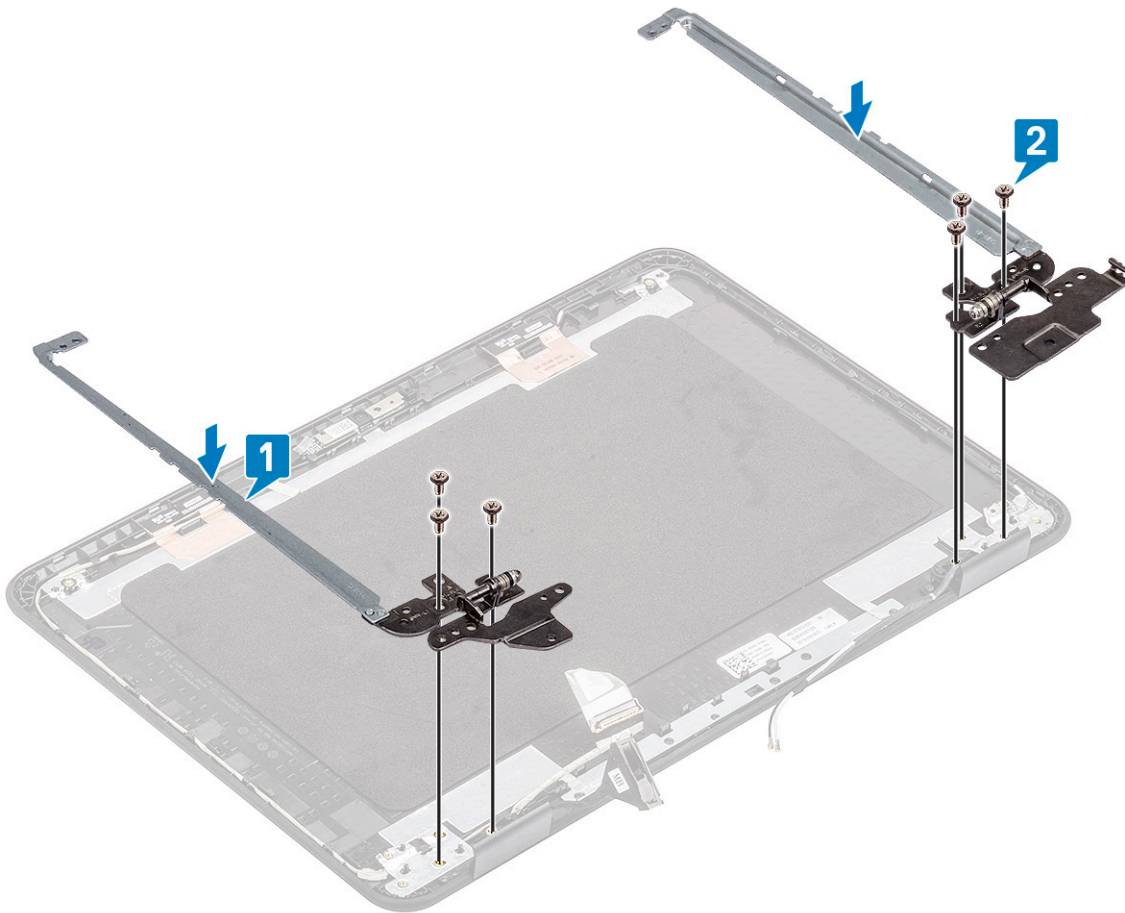

3. Install the:
 - a) LCD panel
 - b) display bezel
 - c) display assembly
 - d) DC-in cable
 - e) WLAN card
 - f) battery
 - g) base cover
 - h) microSD card
4. Follow the procedure in [After working inside your computer](#).

Display back cover

1. **i NOTE: After disassembling the hinges you are left with Display back cover which is one complete unit along with antennae cables.**

Follow the procedure in [Before working inside your computer](#).

2. Remove the :
 - a) microSD card
 - b) base cover
 - c) battery
 - d) WLAN card
 - e) DC-in cable
 - f) display assembly
 - g) LCD bezel
 - h) LCD panel
 - i) Display hinges
 - j) eDP cable

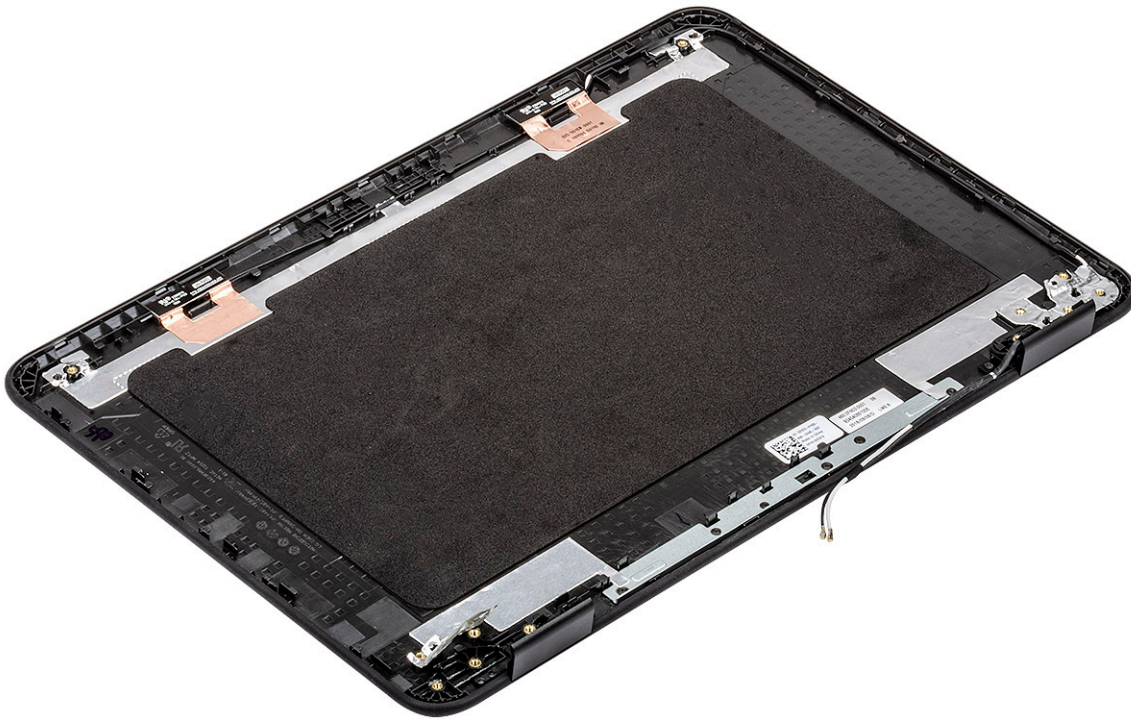

3. Install the display back cover assembly.
4. Install the:
 - a) eDP cable
 - b) Display hinges
 - c) LCD panel
 - d) display bezel
 - e) display assembly
 - f) DC-in cable
 - g) WLAN card
 - h) battery
 - i) base cover
 - j) microSD card
5. Follow the procedure in [After working inside your computer](#).

System board

Removing the system board

1. Follow the procedure in [Before working inside your computer](#).
2. Remove the:
 - a) microSD card
 - b) base cover
 - c) battery
 - d) WLAN card
 - e) SSD
 - f) memory module
 - g) heat sink
 - h) fan
 - i) DC-in
3. Disconnect the following cables and connectors:

- a) Coin cell connector [1]
- b) I/O board cable [2]
- c) Speaker cable connector [3]
- d) Touchpad cable connector [4]
- e) Keyboard cable connector [5]

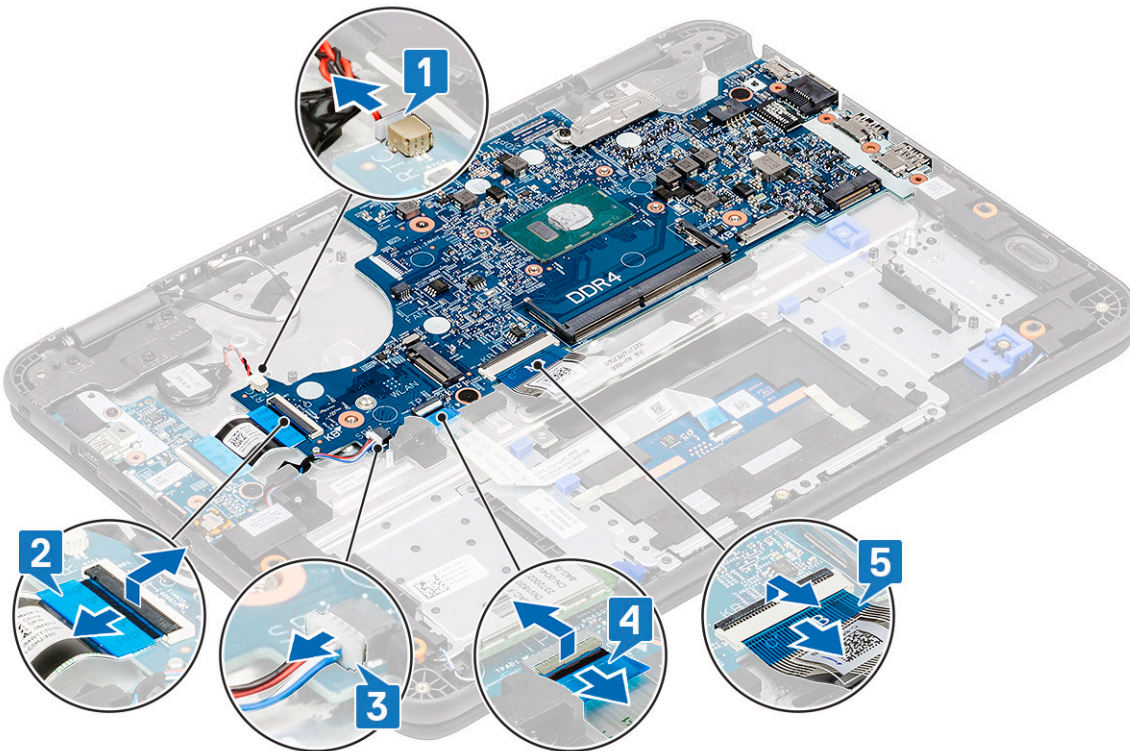

- 4. Remove the single screw [1] securing the EDP bracket on the system board.
- 5. Remove the EDP bracket [2] and disconnect the EDP cable [3] from the system board.

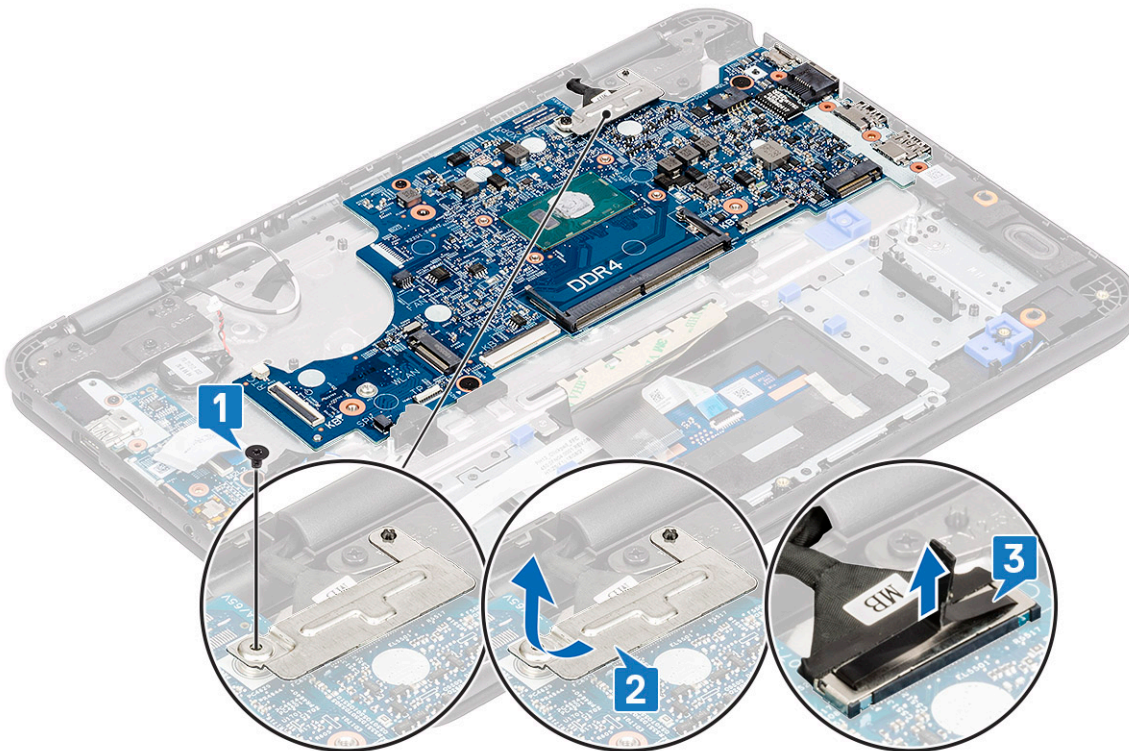

- 6. Remove the single M2xL4 screw and two M2xL2 (large head) screws [1] and lift the system board slightly [2].

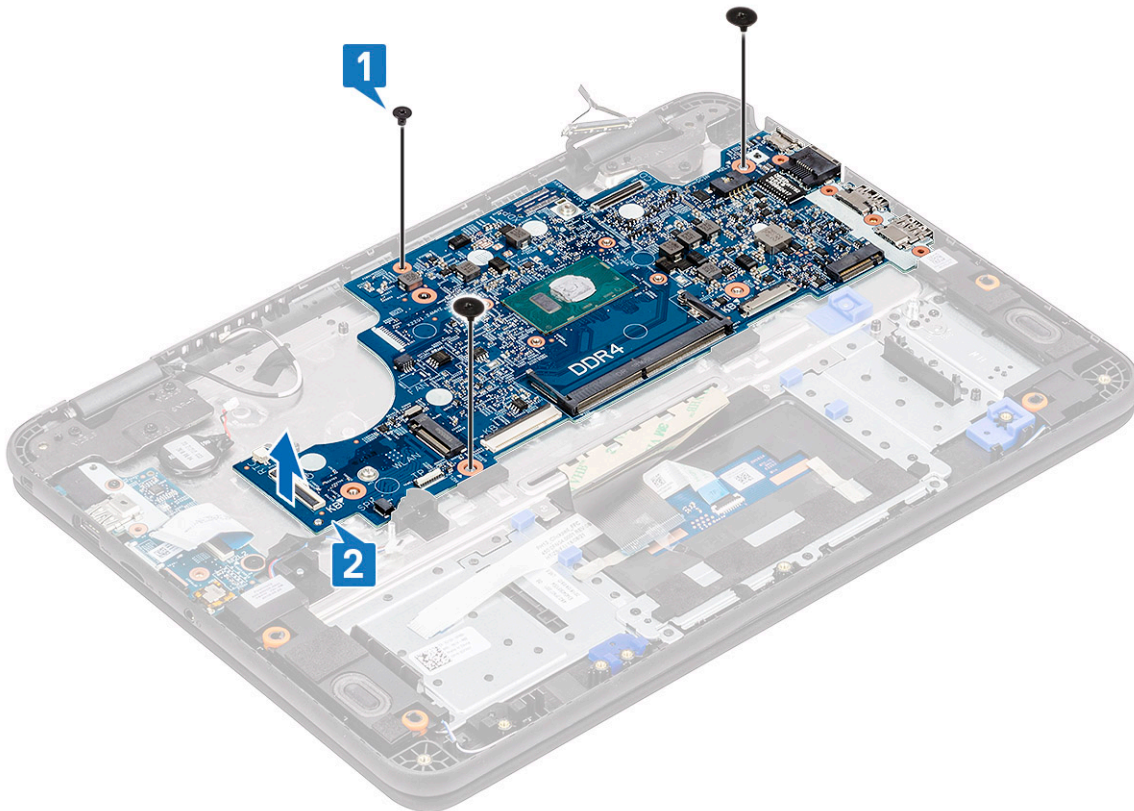

7. Incline the system board and remove the system board from the computer.

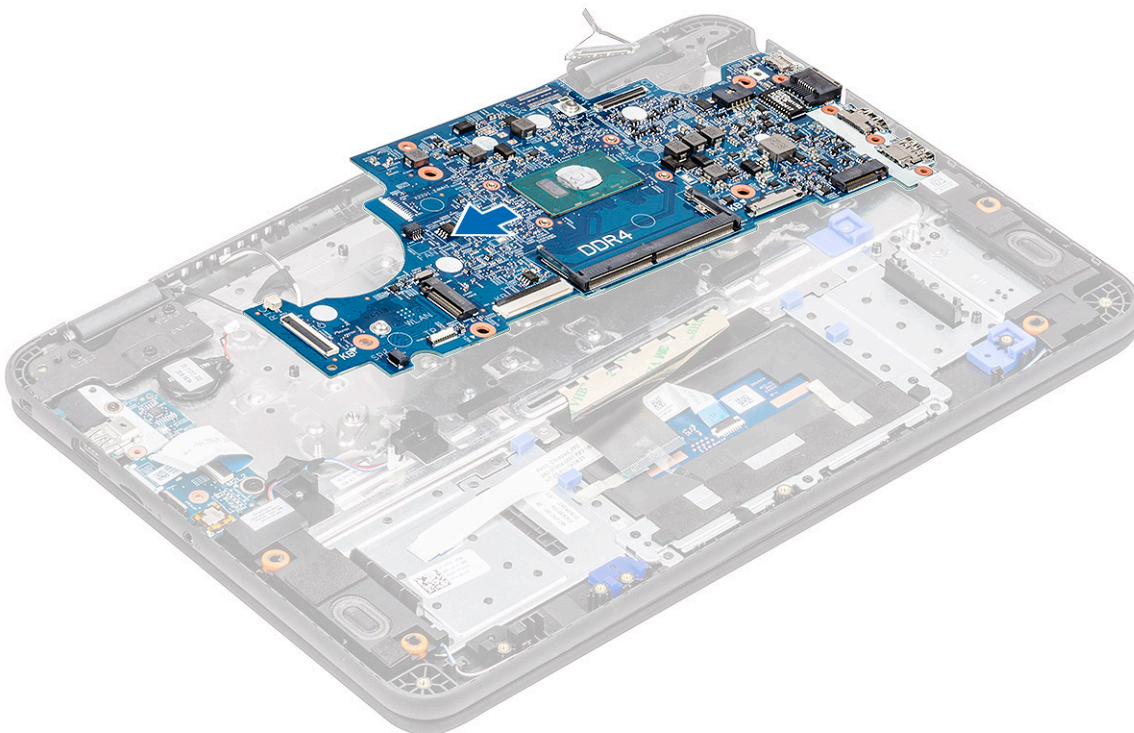

Installing the system board

1. Incline the system board slightly and install it on the computer.

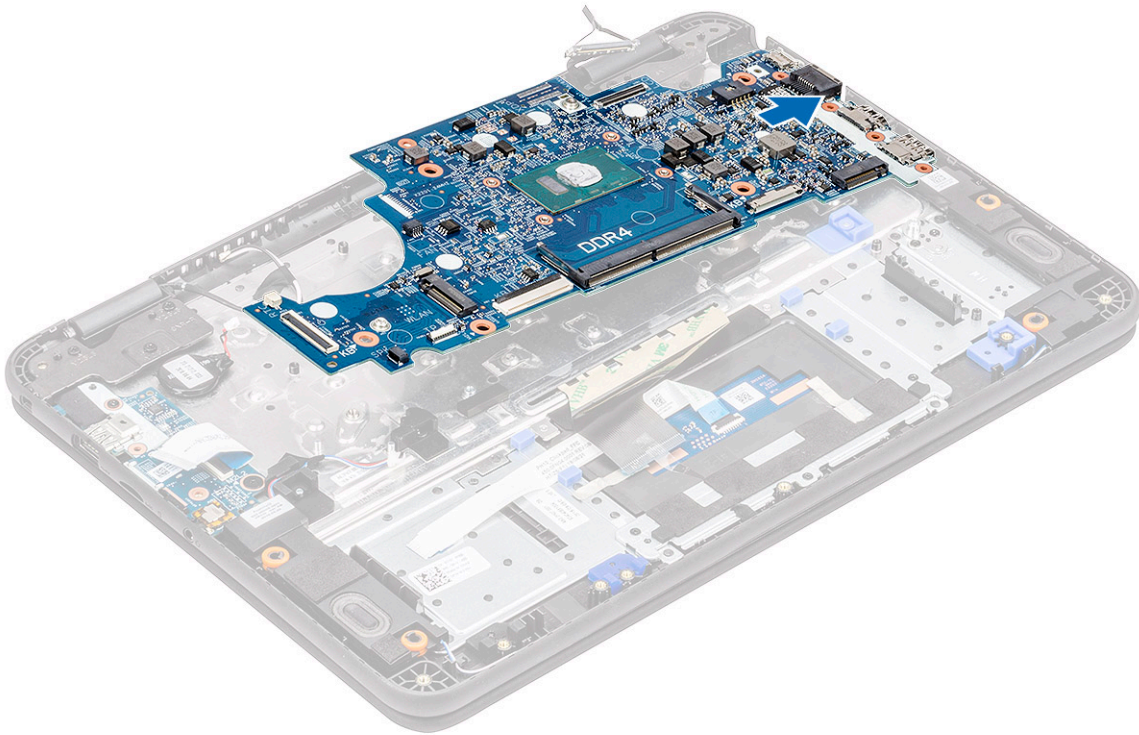

2. Press down the system board [1] to install the single M2xL4 screw and two M2xL2 (large head) screws [2] securing it to the palmrest.

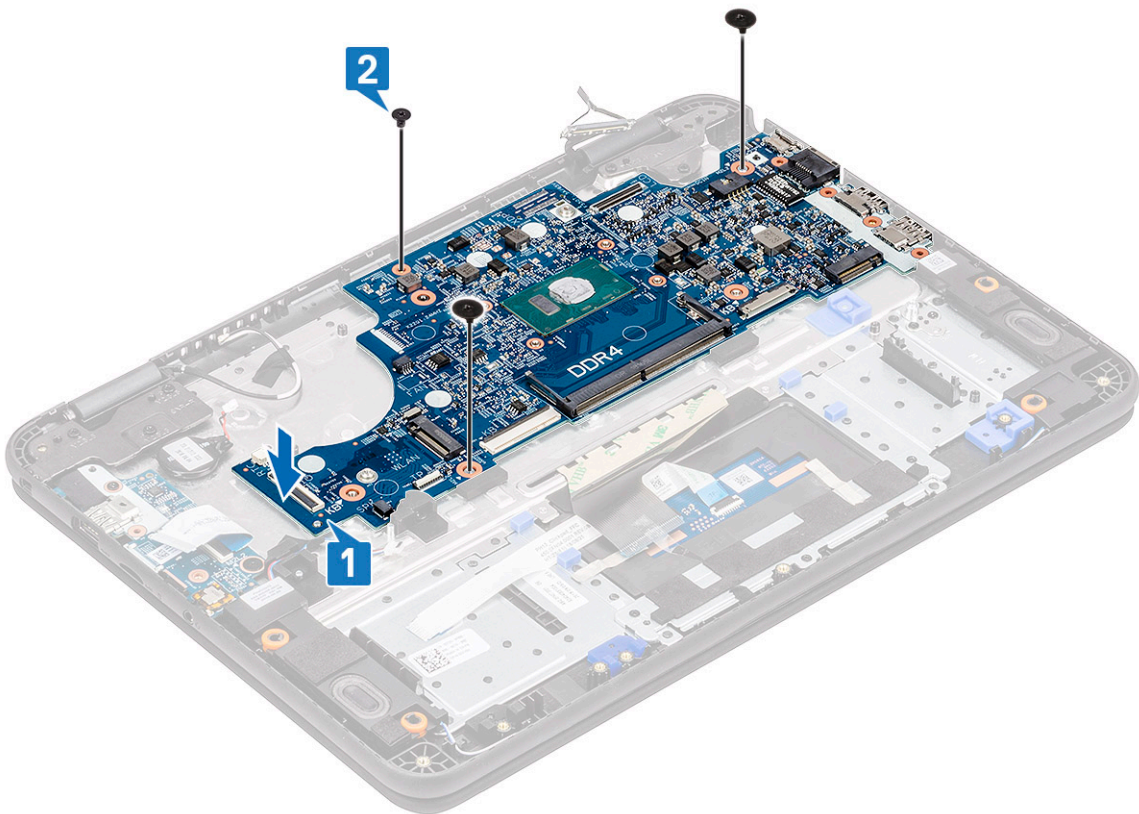

3. Connect the EDP cable to the connector on the system board [1].
4. Align and place the EDP bracket on the connector [2] and tighten it using the single screw [3] securing the system board to the computer.

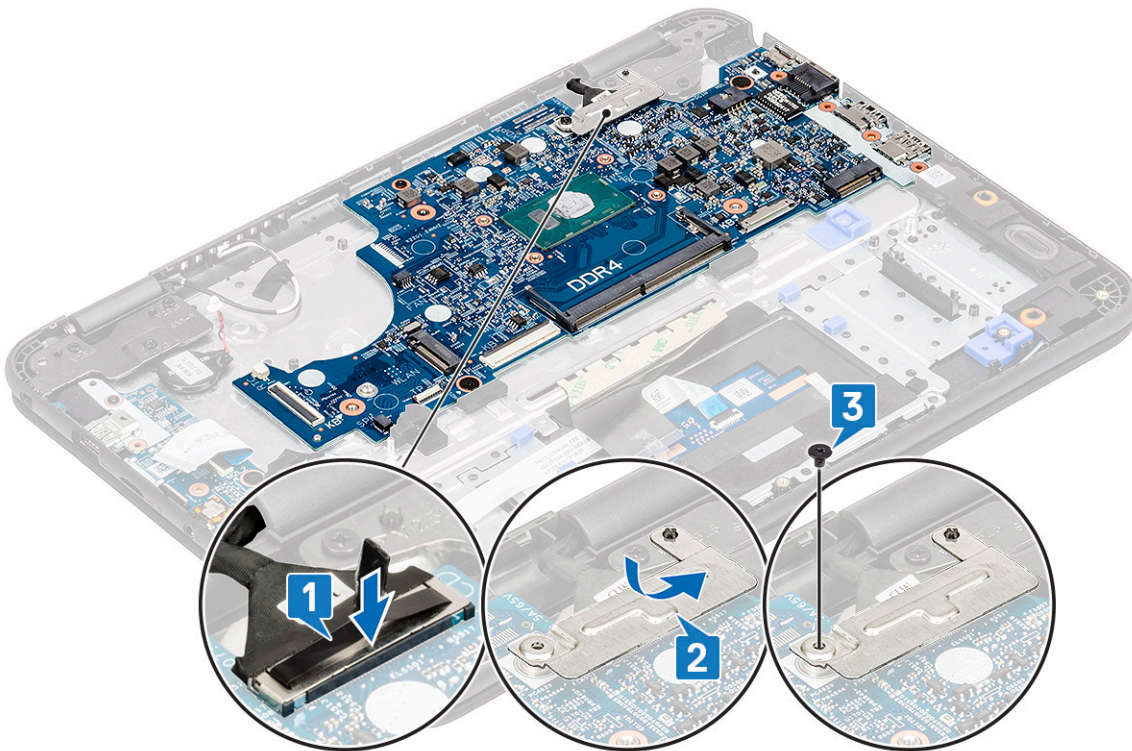

5. Connect the following cables and connectors:

- a) Keyboard cable connector [1]
- b) Touchpad cable connector [2]
- c) Speaker cable connector [3]
- d) I/O board cable [4]
- e) Coin cell connector [5]

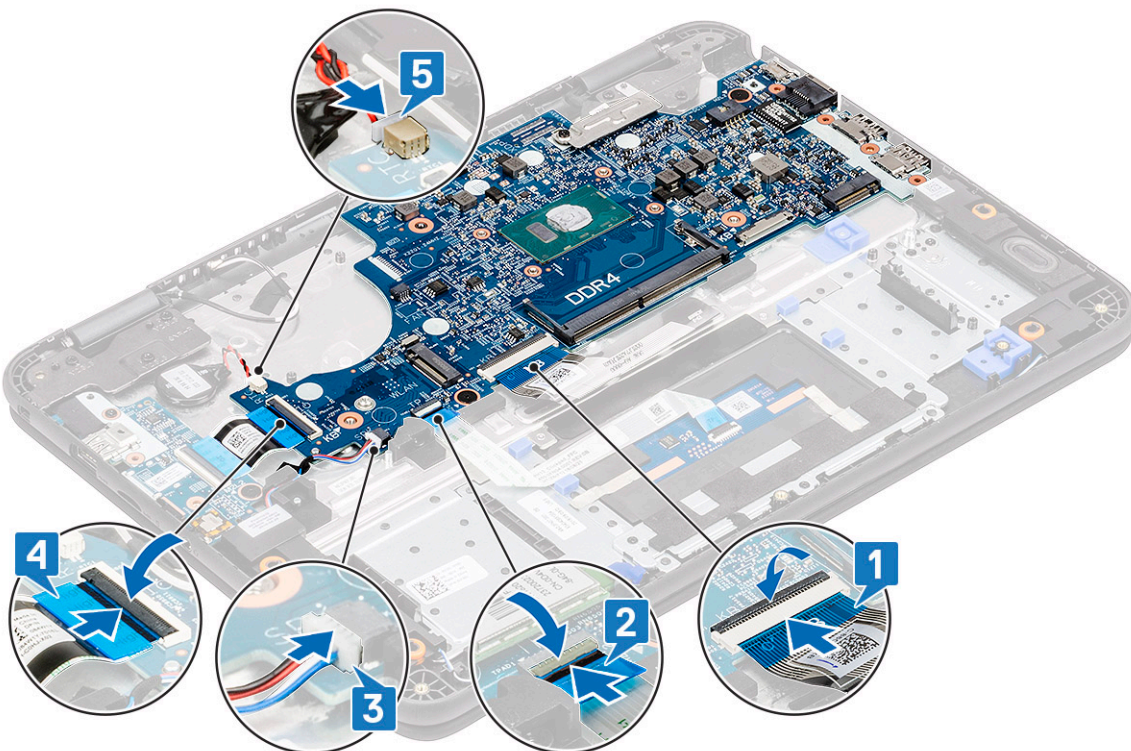

6. Install the:

- a) DC-in cable

- b) fan
 - c) heat sink
 - d) memory module
 - e) SSD
 - f) WLAN card
 - g) battery
 - h) base cover
 - i) microSD card
7. Follow the procedure in [After working inside your computer](#).

Palmrest

1. **NOTE:** After disassembling the system board you are left with palmrest which is one complete unit.

Follow the procedure in [Before working inside your computer](#).

2. Remove the:
- a) microSD card
 - b) base cover
 - c) battery
 - d) coin cell
 - e) WLAN card
 - f) SSD
 - g) speakers
 - h) i-o daughterboard
 - i) keyboard
 - j) touchpad
 - k) display assembly
 - l) memory module
 - m) heat sink
 - n) fan
 - o) DC-in
 - p) system board
3. Install the palmrest.



4. Install the:
 - a) [system board](#)
 - b) [DC-in cable](#)
 - c) [fan](#)
 - d) [heat sink](#)
 - e) [memory module](#)
 - f) [display assembly](#)
 - g) [touchpad](#)
 - h) [keyboard](#)
 - i) [i-o daughterboard](#)
 - j) [speakers](#)
 - k) [SSD](#)
 - l) [WLAN card](#)
 - m) [coin cell](#)
 - n) [battery](#)
 - o) [base cover](#)
 - p) [microSD card](#)
5. Follow the procedure in [After working inside your computer](#).

Diagnostics

This chapter details the built in troubleshooting features to diagnose the Dell systems. It also lists the invoking instructions along with related information for each diagnostics method.

Topics:

- [Battery Status Lights](#)
- [WiFi power cycle](#)
- [Diagnostic LEDs](#)
- [M-BIST](#)
- [Self-Heal](#)
- [BIOS recovery](#)
- [LCD Built-in Self Test](#)
- [ePSA Diagnostics](#)

Battery Status Lights

If the computer is connected to an electrical outlet, the battery light operates as follows:

Alternately blinking amber light and green light	An unauthenticated or unsupported non-Dell AC adapter is attached to your laptop.
Alternately blinking amber light with steady green light	Temporary battery failure with AC adapter present.
Constantly blinking amber light	Fatal battery failure with AC adapter present.
Light off	Battery in full charge mode with AC adapter present.
green light on	Battery in charge mode with AC adapter present.

WiFi power cycle

If your computer is unable to access the Internet due to WiFi connectivity issues, a WiFi power cycle procedure may be performed. The following procedure provides the instructions on how to conduct a WiFi power cycle:

i **NOTE: Some ISPs (Internet Service Providers) provide a modem/router combo device.**

1. Turn off your computer.
2. Turn off the modem.
3. Turn off the wireless router.
4. Wait for 30 seconds.
5. Turn on the wireless router.
6. Turn on the modem.
7. Turn on your computer.

Diagnostic LEDs

Instead of beep codes, errors are indicated via the bicolor Battery Charge/Status LED. A specific blink pattern is followed by flashing a pattern of flashes in amber, followed by white. The pattern then repeats.

NOTE: The diagnostic pattern will consist of a two-digit number being represented by a first group of LED blinks (1 through 9) in amber, followed by a 1.5 second pause with the LED off, and then a second group of LED blinks (1 through 9) in white. This is then followed by a three second pause, with the LED off, before repeating over again. Each LED blink takes 1.5 seconds.

The system will not shutdown when displaying the Diagnostic Error Codes.

Diagnostic Error Codes will always supersede any other use of the LED. For instance, on laptops, battery codes for Low Battery or Battery Failure situations will not be displayed when Diagnostic Error Codes are being displayed.

Table 9. Diagnostic LEDs

Blinking Pattern		Problem Description	Suggested Resolution
Amber	White		
2	1	CPU failure	Replace the system board.
2	2	System board failure (included BIOS corruption or ROM error)	Flash latest BIOS version. If problem persists, replace the system board.
2	3	No memory/RAM detected	Confirm that the memory module is installed properly. If problem persists, replace the memory module.
2	4	Memory/RAM failure	Replace the memory module.
2	5	Invalid memory installed	Replace the memory module.
2	6	System board/Chipset error	Replace the system board.
2	7	LCD failure	Replace the LCD module.
2	8	LCD Power rail failure	Replace the system board.
3	1	CMOS battery failure	Replace the RTS battery.
3	2	PCI or Video card/chip failure	Replace the system board.
3	3	BIOS Recovery Image not found	Flash latest BIOS version. If problem persists, replace the system board.
3	4	BIOS Recovery Image found but invalid	Flash latest BIOS version. If problem persists, replace the system board.

NOTE: For diagnostics pattern 2-amber, 8-white connect an external monitor to isolate between system board or graphics controller failure.

M-BIST

M-BIST (Built In Self-Test) diagnostics tool, featuring improved accuracy in system board failures.

NOTE: M-BIST can be manually initiated before POST (Power On Self Test).

How to run M-BIST

NOTE: M-BIST must be initiated on the system from a power-off state either connected to AC power or with battery only.

1. Press and hold both the **M** key on the keyboard and the **power button** to initiate M-BIST.
2. With both the **M** key and the **power button** that is held down, the battery indicator LED may exhibit two states:
 - a. OFF: No fault detected with the system board

- b. AMBER: Indicates a problem with the system board

Self-Heal

Course Introduction

Self-Heal is an option that helps recover a Dell Latitude system from a No Post, No Power, No Video situation.

Self-Heal Instruction

1. Remove the primary battery and the AC adapter.
2. Disconnect the CMOS battery.
3. Release the flea power. Press and hold the power button down for 10 seconds or leave the system idle for 45 seconds.
4. Make sure the CMOS and primary battery are not plugged into the system.
5. Plug in the AC adapter. The system will auto power-on when the AC adapter inserted.
6. The system will start with a blank screen for a while and will shut down automatically. Watch for the LED lights (power, Wi-Fi, and HDD). It will turn on.
7. The system will try to restart twice and will boot on the third attempt.
8. Place the CMOS battery and the AC adapter back in the system.
9. If self-heal recovers the failure, update the system with the latest BIOS, and perform ePSA to ensure proper functionality of the system.

NOTE:

- During installation or removal of any hardware, always ensure all data is backed up properly.
- For instructions on how to remove or replace parts, visit the [Assembly Disassembly](#).
- Before beginning to work on the computer, follow the [Safety Instructions](#).

Supported Latitude Models

NOTE:

- Before replacing the system board, perform self-heal as a mandatory step.
- Latitude Self-Heal can be avoided when complete system tear-down is required to access the coin-cell battery.
- For the Latitude E7 Series (XX70), BIOS Recovery 2.0 should be performed as the primary step.
- In order to reduce troubleshooting time associated with Self-Heal, there is no mandatory requirement to reassemble the system. Technicians can initiate Self-Heal even with the system board exposed.
- Do not touch any of the exposed components or the system board to avoid shorting and static.
- If Self-Heal is unable to recover the failure, proceed with replacing the system board.

NOTE:

Front-line Agent Action: Front-line agents must encourage the customer to perform this step before isolating the issue as a motherboard failure. If the customer is not comfortable performing the Self-Heal procedure, then please document the dispatch being created in 5GL. Advise the onsite engineers to perform the Self-Heal procedure as one of the mandatory initial steps. Advise them that if the Self-Heal procedure is unsuccessful, to continue with the regular troubleshooting before part replacement.

Onsite Engineer Action: The Latitude Self-Heal procedure has to be a mandatory initial step. If the Self-Heal procedure is unsuccessful, continue with the regular troubleshooting before part replacement. Document Self-Heal results in the call closure log (Self-Heal Pass or Fail).

BIOS recovery

The BIOS recovery is designed to fix the main BIOS, and cannot work if the boot is damaged. The BIOS recovery will not work in the event of EC corruption, ME corruption, or a hardware related issue. The BIOS recovery image should be available on the unencrypted partition on the drive for BIOS recovery feature.

Rollback BIOS feature

Two versions of the BIOS recovery image are saved on the hard drive:

- Current running BIOS (old)
- To-be-updated BIOS (new)

The old version is already stored on the hard drive. The BIOS adds new version to the hard drive, maintains the old version, and deletes other existing versions. For example, A00 and A02 versions are already on the hard drive, A02 is the running BIOS. The BIOS adds A04, maintains A02, and deletes A00. Having two BIOS version enables the Rollback BIOS feature.

If the recovery file cannot be stored (hard drive is out of space), the BIOS sets a flag to indicate this condition. The flag is reset in the event it later becomes possible to store the recovery file. The BIOS notifies the user during POST and in BIOS Setup, the BIOS recovery is degraded. BIOS recovery through hard drive may not be possible, however BIOS recovery through USB flash drive is still possible.

For USB key: root directory or "\"

BIOS_IMG.rcv: the recovery image stored on the USB key.

BIOS recovery using hard drive

NOTE: Ensure that you have the previous version and the latest version of the BIOS from the Dell support site available to use.

NOTE: Ensure that you have the file type extensions visible in the operating system (OS).

1. Browse to the location of the BIOS update executable (.exe) files.
2. Rename the BIOS executable files to **BIOS_PRE.rcv** for the earlier version of the BIOS and **BIOS_CUR.rcv** for the latest version of the BIOS.

For example, if the latest version's file name is **PowerEdge_T30_1.0.0.exe**, rename it to **BIOS_CUR.rcv** and if the previous version's file name is **PowerEdge_T30_0.0.9.exe**, rename it to **BIOS_PRE.rcv**

NOTE:

- a. If the hard drive is new, there will be no operating system installed.
- b. If the hard drive has been partitioned at the Dell factory, there will be a Recovery Partition available.

3. Disconnect the hard drive and install the hard drive into another system that has a full operational operating system.
4. Start up the system and in the Windows operating system environment follow these steps to copy the BIOS recovery file to the **Recovery Partition**.

- a) Open a Windows Command Prompt window.
- b) At the prompt, type **diskpart** to start the **Microsoft DiskPart**.
- c) At the prompt, type **list disk** to list out the available hard drives.
Select the hard drive that was installed in Step 3.
- d) At the prompt, type **list partition** to view the available partitions on this hard drive.
- e) Select **Partition 1** which is the **Recovery Partition**. The size of the partition will be 39 MB.
- f) At the prompt, type **set id=07** to set the partition ID.

NOTE: The partition will be visible to the operating system as **Local Disk (E)** to read and write data.

- g) Create the following folders in **Local Disk (E)**, **E:\EFI\Del\BIOS\Recovery**.
- h) Copy both the BIOS files **BIOS_CUR.rcv** and **BIOS_PRE.rcv** to the recovery folder on **Local Disk (E)**.
- i) In the **Command Prompt** window, at the **DISKPART** prompt, type **set id=DE**.

After the executing this command, the partition **Local Disk (E)** will not be accessible by the OS.

5. Shut the system down, remove the hard drive, and install the hard drive into the original system.
6. Start the system up and boot to System Setup, in the **Maintenance** section ensure that **BIOS Recovery from Hard Drive** is enabled in the **BIOS Recovery** section of the setup.

7. Press the power button to shut the system down.
8. Holding the **Ctrl and Esc** keys, press the power button to start the system up. Keep holding the **Ctrl and Esc** keys until the **BIOS Recovery Menu** page is displayed.
Ensure that the **Recover BIOS** radio button is selected and click **Continue** to start the BIOS recovery.

BIOS recovery using USB drive

NOTE: Ensure that you have the file type extensions visible in the operating system.

NOTE: Ensure that you have downloaded the latest BIOS from the Dell support site and save it on your system.

1. Browse to the location of the downloaded BIOS update executable (.exe) file.
2. Rename the file to BIOS_IMG.rcv.
For example, if the file name is PowerEdge_T30_0.0.5.exe, rename it to BIOS_IMG.rcv
3. Copy the BIOS_IMG.rcv file to the root directory of the USB key.
4. If not plugged in, plug in the USB drive, restart the system, press F2 to enter the System Setup, and then press power button to shut down the system.
5. Start the system.
6. While the system is starting up, press the **Ctrl+Esc** keys while holding the power button until the **BIOS Recovery Menu** dialog box is displayed.
7. Click **Continue** to start the BIOS recovery process.

NOTE: Ensure that the **Recovery BIOS** option is selected in the **BIOS Recovery Menu** dialog box.

8. Select the path on the USB drive where BIOS recovery file is stored(root directory or "\") and follow the on-screen instructions.

LCD Built-in Self Test

Overview : LCD Built-in Self Test (BIST)

Dell laptop have a built-in diagnostic tool that helps you determine if the screen abnormality you are experiencing is an inherent problem with the LCD (screen) of the Dell laptop or with the video card (GPU) and PC settings .

When you notice screen abnormalities like flickering, distortion, clarity issues, fuzzy or blurry image, horizontal or vertical lines, color fade etc., it is always a good practice to isolate the LCD (screen) by running the Built-In Self Test (BIST).

How to invoke LCD BIST Test

1. Power off the Dell laptop.
2. Disconnect any peripherals connected to the laptop. Connect only the AC adapter (charger) to the laptop.
3. Make sure that the LCD (screen) is clean (no dust particles on the surface of the screen).
4. Press and hold **D** key and **Power on** the laptop to enter LCD built-in self test (BIST) mode. Continue to hold the D key, until you see color bars on the LCD (screen).
5. The screen will display multiple color bars and change colors on the entire screen to red, green, and blue.
6. Carefully inspect the screen for abnormalities.
7. Press **Esc** key to exit.

NOTE: Dell ePSA upon launch, initiates a LCD BIST first, expecting an user intervention confirm functionality of the LCD.

ePSA Diagnostics

The ePSA diagnostics (also known as system diagnostics) performs a complete check of your hardware. The ePSA is embedded with the BIOS and is launched by the BIOS internally. The embedded system diagnostics provides a set of options for particular devices or device groups allowing you to:

- Run tests automatically or in an interactive mode

- Repeat tests
- Display or save test results
- Run thorough tests to introduce additional test options to provide extra information about the failed device(s)
- View status messages that inform you if tests are completed successfully
- View error messages that inform you of problems encountered during testing

NOTE: The Enhanced Pre-boot System Assessment window displays, listing all devices detected in the computer. The diagnostics starts running the tests on all the detected devices.

Running ePSA diagnostics

Invoke diagnostics by either of the methods that are suggested below:

- Tap **F12** key on keyboard, as the Dell splash screen appears, until you get the message **Diagnostic Boot Selected**.
 - On the one-time boot menu screen, use the Up/Down arrow key to select the **Diagnostics** option and then press **Enter**.
- Press and Hold **Function (Fn)** key on the keyboard and press the **Power button** to power on the system.

ePSA User Interface

This section contains information on ePSA 3.0's Basic and Advanced Screen.

ePSA opens the basic screen on start. You can switch to the advanced screen using the arrow icon at the bottom of the screen. The advanced screen shows detected devices on the left column. Specific test can be included or excluded only in the interactive mode.

ePSA Basic Screen

The Basic Screen has minimal controls which allows easy navigation for the user to start or stop the diagnostics.

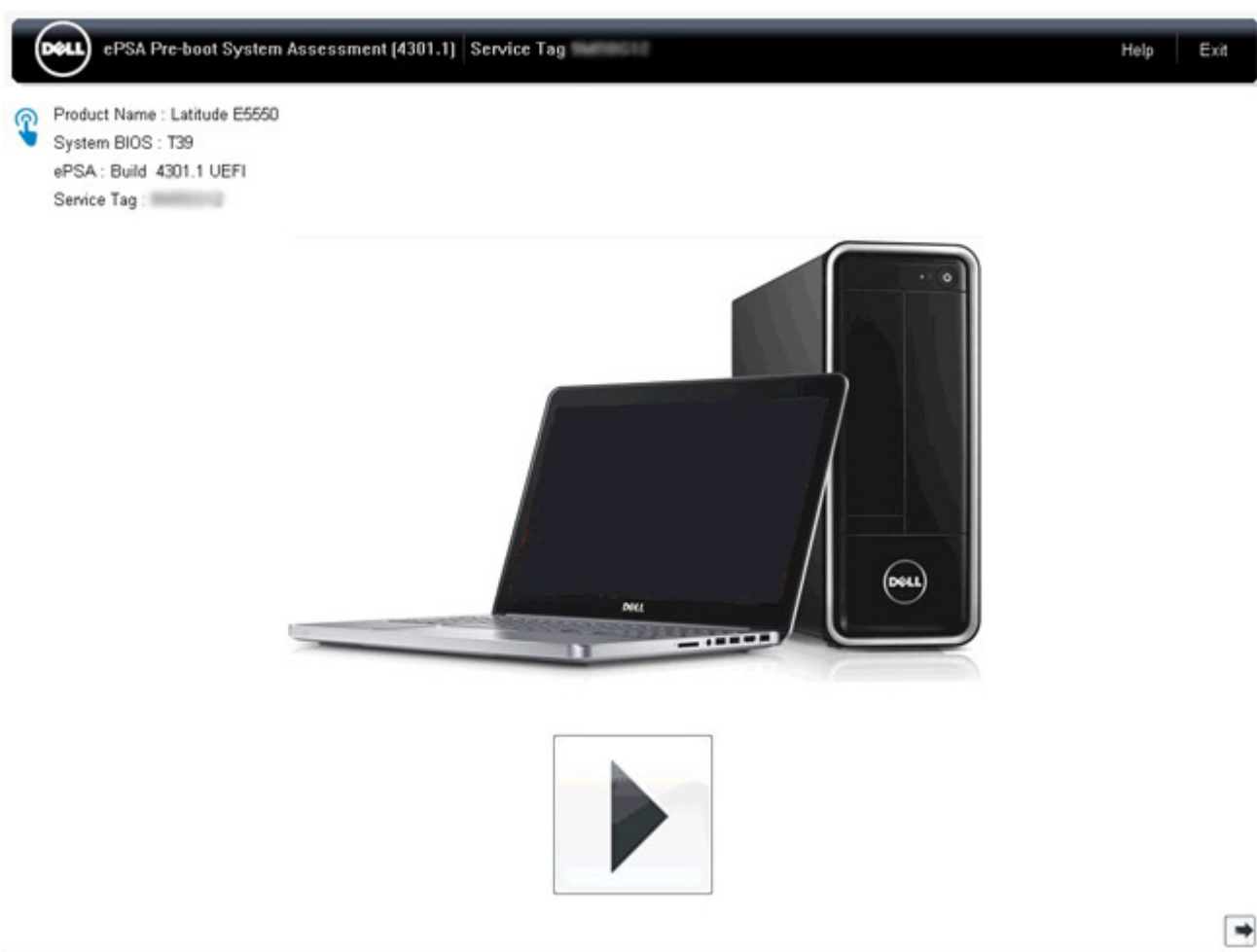

ePSA Advanced Screen

The advanced screen allows more directed testing and contains more detailed information about the overall health of the system. The user can get to this screen by simply swiping a finger to the left on touchscreen systems or clicking the next page button on the lower right hand side of the basic screen.

Battery and AC Adapter

Sensor	Current	High	Low
Primary Battery Charge	96%	96%	89%
Primary Battery Health	80%	80%	80%
Primary Battery Voltage	8455 mV	8455 mV	8390 mV
Primary Battery Current Flow	935 mA	2247 mA	935 mA
Primary Battery Charging State	Charging	n/a	n/a
AC adapter	65 watt adapter	n/a	n/a

Fans

Sensor	Current	High	Low
Processor Fan	2704 RPM	3352 RPM	0 RPM

Thermals

Sensor	Current	High	Low
Hard Drive 0	34 C	36 C	34 C
Primary Battery Thermistor	31 C	32 C	31 C
CPU Thermistor	58 C	61 C	57 C
Ambient Thermistor	49 C	50 C	48 C
SODIMM Thermistor	43 C	44 C	43 C
Other Thermistor	36 C	36 C	35 C
Video Thermistor	53 C	57 C	53 C

To run the test on specific device or run a specific test

1. To run a diagnostic test on a specific device, press Esc and click **Yes** to stop the diagnostic test.
2. Select the device from the left pane and click **Run Tests** or use **Advanced Option** to include or exclude any test.

ePSA Error Messages

When the Dell ePSA Diagnostic detects an error while running, it will pause the test and the following window is displayed:

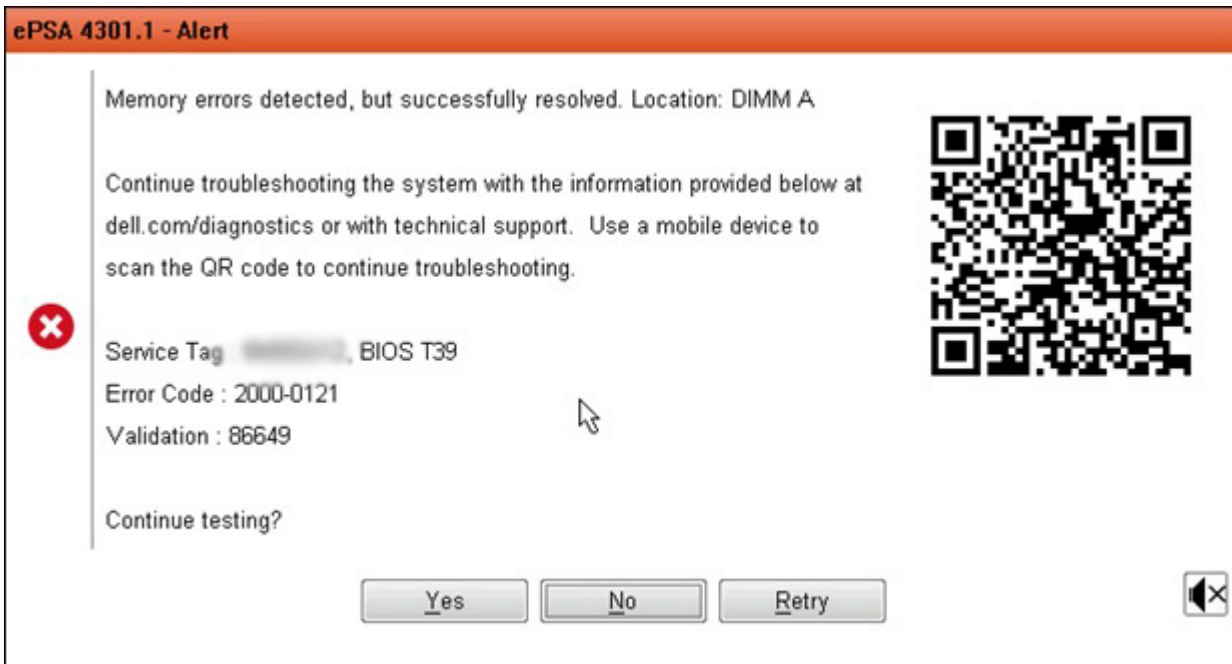

- By responding **Yes**, the diagnostic will continue testing the next device and the error details will be available in the summary report.
- By responding **No**, the diagnostic will stop testing the remaining untested device.
- By responding **Retry**, the diagnostic will ignore the error and rerun the last test.

Capture the error code with Validation code or Scan QR code and Contact Dell.

NOTE: As part of the new feature, user can now mute the beeping sound code when there is an error by clicking on  at the bottom right side of the error window.

NOTE: Some tests for specific devices require user interaction. Always ensure that you are present before the computer when the diagnostic tests are performed.

Validation Tools

This section contains information on how to validate the ePSA error codes.

Error code verification can be done using below two methods :

- [Online Enhanced Preboot System Assessment Validation Tool.](#)
- [QR scanning using QR APP on Smart Phone.](#)

Online ePSA Validation Tool

Usage Guide

1. User to obtain information from ePSA error windows.

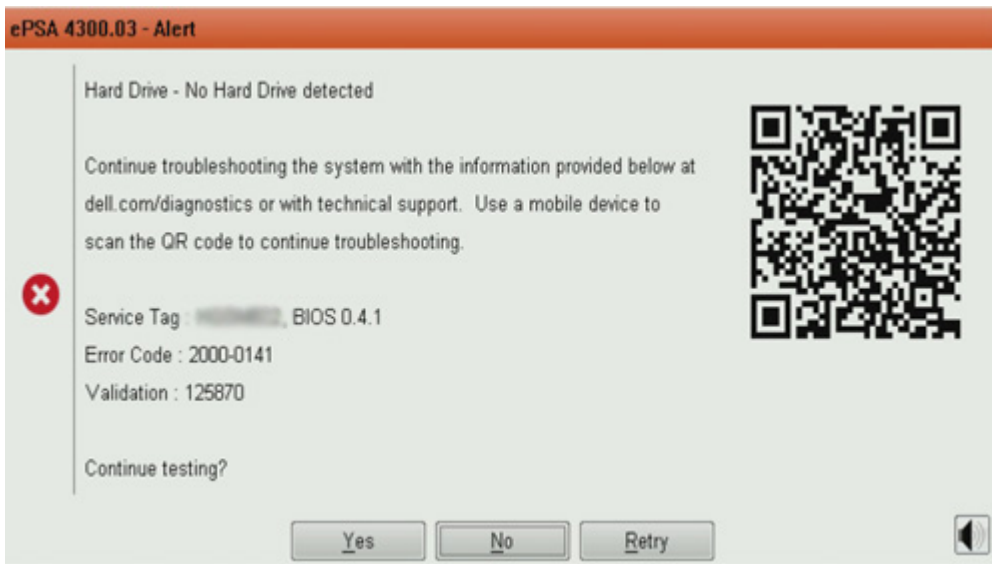

2. Navigate to [Online ePSA Validation Tool](http://www.dell.com/support/home/us/en/04/epsa).

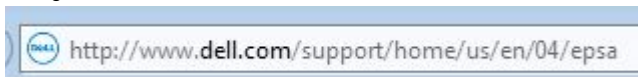

3. Enter error code, validation code, and service tag. Part serial number is optional.

Error Code (without 2000-prefix) *	<input type="text" value="Error Code (without 2000-prefix)"/>
Validation Code *	<input type="text" value="Validation Code"/>
Service Tag ⓘ *	<input type="text" value="Service Tag"/>
Part Serial # (optional)	<input type="text" value="Part Serial # (optional)"/>
<input type="submit" value="Submit"/>	

[View System Requirements](#) and [Privacy And Legal Information](#)

ⓘ | **NOTE:** For error code, use only the last 3 or 4 digits of the code. (user can enter 0142 or 142 instead of 2000-0142.)

4. Click on **Submit** once all the necessary information is entered.

Error Code (without 2000-prefix) *

Validation Code *

Service Tag  *

Part Serial # (optional)

Submit

[View System Requirements and Privacy And Legal Information](#)

Valid Error Code Example



Vostro 20 All-in-One 3055

Service Tag: [XXXXXXXXXX](#) | Express Service Code: [XXXXXXXXXX](#)

[Add to My Products List](#)

[View a different product](#)

[Manuals](#)
[Warranty](#)
[System configuration](#)

Diagnostics

Support topics & articles

Drivers & downloads

General maintenance

Parts & accessories

 Your system is currently Out of Warranty. Please contact Dell Technical Support for further assistance.

Result: Issues Found.

Your result requires attention. Review the affected hardware below and follow the instructions to troubleshoot problems or you may be presented with a request to replace parts. [Clear results](#)

 Needs Attention: System maintenance

Needs Attention

A potential error has been found. [Click here](#) to view a list of steps that can help resolve your issue.

See full scan results.

Diagnostics Completed

Hardware

Diagnostic Name	Error Code	Serial #	Result
EP5A	141		 Failed

After entering the correct information, the online tools will direct the user to the above screen which contains information on :

- Confirmation of the error code and result outcome
- Suggested Part Replacement

- If customer is still covered under Dell Warranty
- Case reference number if there is an open case under the service tag

Invalid Error Code Example

Error Code (without 2000-prefix) *	<input type="text" value="0141"/>
Validation Code *	<input type="text" value="123456"/>
Service Tag ⓘ *	<input type="text" value="XXXXXXXX"/>
Part Serial # (optional)	<input type="text" value="Part Serial # (optional)"/>

 You have entered an invalid ePSA request, please check your details and try again.

Submit

QR APP Validation Tool

Besides using the online tool, customers can also validate the error code by scanning the QR code with a QR APP a smartphone.

1. User to obtain the QR code from ePSA error screen.



2. User can use any QR code scanner application through the smartphone to scan the QR code.

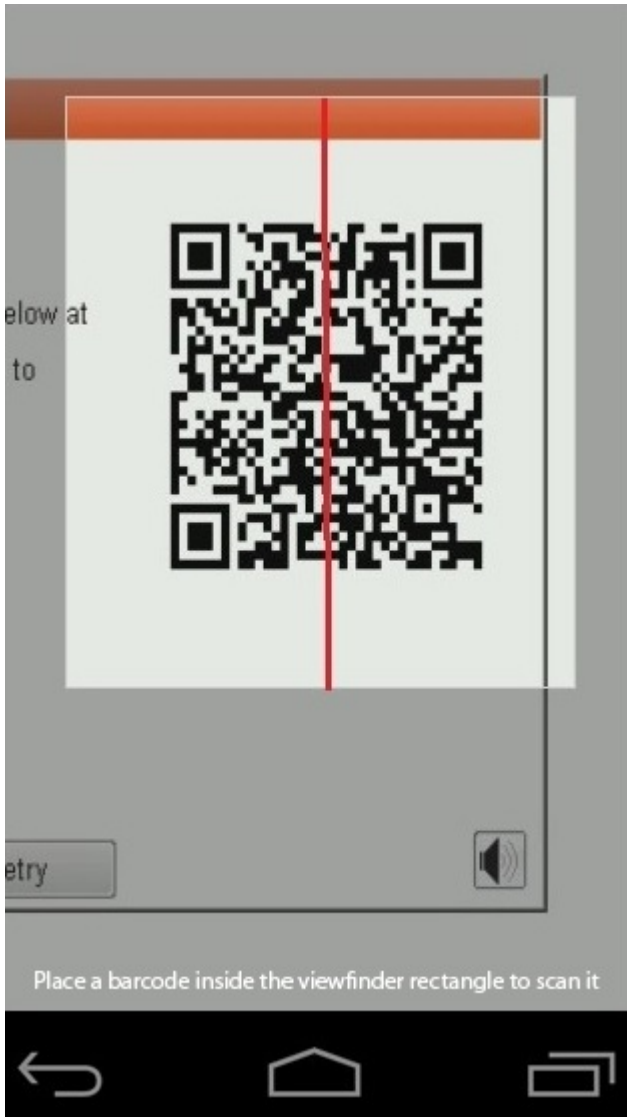

3. The QR code scanner application will scan the code and automatically generate a link. Click the link to proceed.

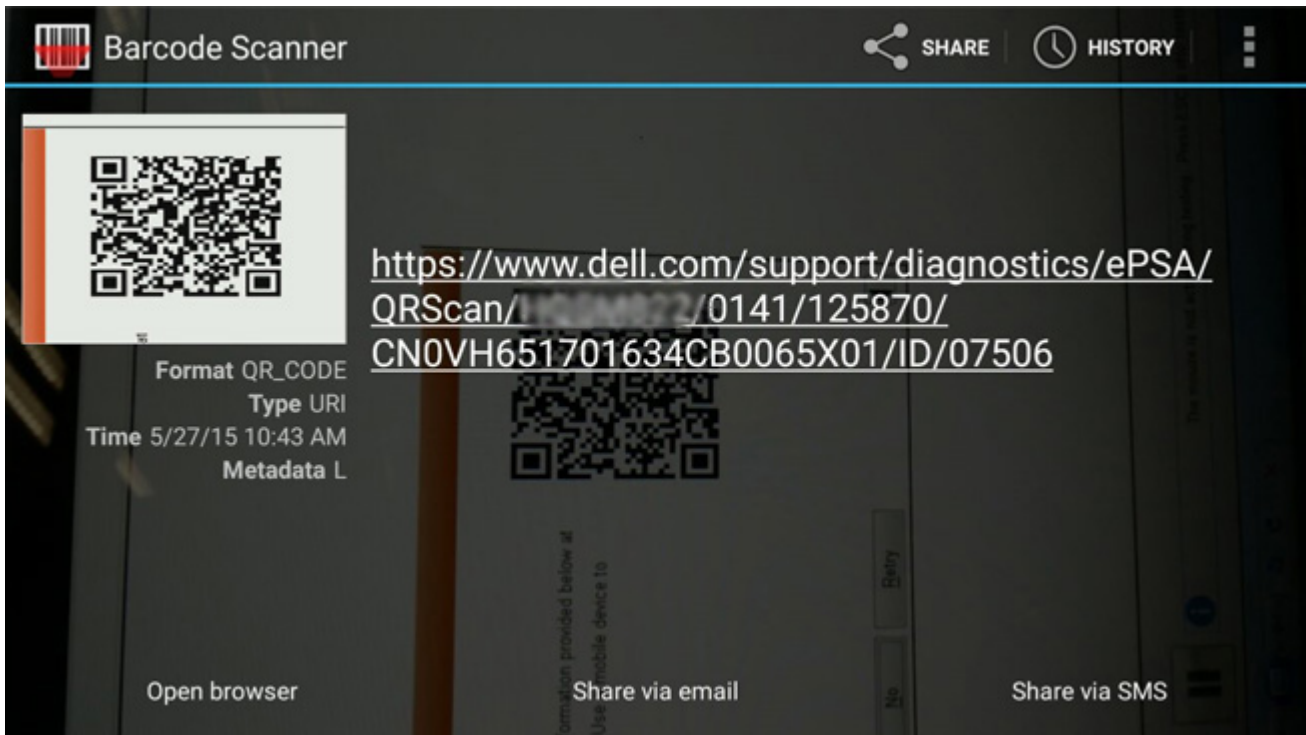

The link generated will take the customer to the Dell Support website which contains information on:

- Confirmation of the error code and result outcome
- Suggested Part Replacement
- If customer is still covered under Dell Warranty
- Case reference number if there is an open case under the service tag



Vostro 20 All-in-One 3055

Service Tag: **XXXXXXXXXX** | Express Service Code: **XXXXXXXXXX**

[Add to My Products List](#)

[View a different product](#)

[Manuals](#)

[Warranty](#)

[System configuration](#)

Diagnostics

Support topics & articles

Drivers & downloads

General maintenance

Parts & accessories

⚠ Your system is currently Out of Warranty. Please contact Dell Technical Support for further assistance.

Result: Issues Found.

Your result requires attention. Review the affected hardware below and follow the instructions to troubleshoot problems or you may be presented with a request to replace parts.

[Clear results](#)

⚠ Needs Attention: System maintenance

Needs Attention

A potential error has been found. [Click here](#) to view a list of steps that can help resolve your issue.

See full scan results.

Diagnostics Completed

Hardware

Diagnostic Name	Error Code	Serial #	Result
EP5A	141		Failed

Getting help

Topics:

- [Contacting Dell](#)

Contacting Dell

 **NOTE: If you do not have an active Internet connection, you can find contact information on your purchase invoice, packing slip, bill, or Dell product catalog.**

Dell provides several online and telephone-based support and service options. Availability varies by country and product, and some services may not be available in your area. To contact Dell for sales, technical support, or customer service issues:

1. Go to **Dell.com/support**.
2. Select your support category.
3. Verify your country or region in the **Choose a Country/Region** drop-down list at the bottom of the page.
4. Select the appropriate service or support link based on your need.