



# User Guide

DSL Internet Box

TD-W9960v

# Contents

About This Guide .....	1
<b>Chapter 1. Get to Know Your Modem Router .....</b>	<b>3</b>
1.1. Product Overview .....	4
1.2. Physical Appearance .....	4
1.2.1. Top Panel .....	4
1.2.2. Back Panel .....	6
1.2.3. Side Panel .....	7
<b>Chapter 2. Connect the Hardware .....</b>	<b>8</b>
2.1. Position Your Modem Router .....	9
2.2. Connect Your Modem Router .....	9
<b>Chapter 3. Log In to Your Modem Router .....</b>	<b>12</b>
<b>Chapter 4. Set Up Internet Connections .....</b>	<b>14</b>
4.1. Use Quick Setup Wizard .....	15
4.2. Manually Set Up an Internet Connection .....	15
4.3. Test Internet Connectivity .....	16
4.4. Set Up an IPv6 Connection .....	17
4.5. Operation Mode .....	18
<b>Chapter 5. TP-Link Cloud Service .....</b>	<b>19</b>
5.1. Register a TP-Link ID .....	20
5.2. Change Your TP-Link ID Information .....	20
5.3. Manage the User TP-Link IDs .....	21
5.3.1. Add an TP-Link ID to Manage the Router .....	22
5.3.2. Remove TP-Link ID(s) From Managing the Router .....	22
5.4. Manage the Router via TP-Link Tether App .....	23
<b>Chapter 6. Telephony .....</b>	<b>24</b>
6.1. Connecting the Telephone .....	25
6.2. DECT .....	25
6.2.1. Registering DECT Handset .....	25
6.2.2. Configuring DECT Settings .....	26

6.3.	Entering Telephone Information .....	27
6.4.	Telephone Book .....	31
6.4.1.	Telephone Book .....	31
6.4.2.	Emergency Calls.....	32
6.5.	Telephony Devices Management.....	33
6.6.	Call Log .....	35
6.7.	Calling via Which Number .....	35
6.8.	Call Blocks.....	36
6.8.1.	Do Not Disturb.....	36
6.8.2.	Blocking Certain Calls .....	37
6.8.3.	Prevent from Dialing .....	38
6.9.	Forwarding Calls.....	39
6.10.	Call Through.....	40
6.11.	tpPhone .....	42
6.12.	Voice Mail .....	42
<b>Chapter 7. Guest Network.....</b>		<b>45</b>
7.1.	Create a Network for Guests.....	46
7.2.	Customize Guest Network Options.....	46
<b>Chapter 8. Parental Controls .....</b>		<b>48</b>
<b>Chapter 9. Bandwidth Control .....</b>		<b>52</b>
9.1.	Set Bandwidth Control of the Network .....	53
9.2.	Create a Bandwidth Control Rule for an IP Range .....	53
<b>Chapter 10. Network Security .....</b>		<b>55</b>
10.1.	Firewall & DoS Protection .....	56
10.2.	Service Filtering .....	57
10.3.	Access Control .....	58
10.4.	IP & MAC Binding .....	60
10.5.	IPv6 Firewall .....	61
<b>Chapter 11. NAT Forwarding.....</b>		<b>63</b>
11.1.	Translate Address and Port by ALG.....	64
11.2.	Share Local Resources over the Internet by Virtual Server.....	65
11.3.	Open Ports Dynamically by Port Triggering.....	66
11.4.	Make Applications Free from Port Restriction by DMZ .....	67
11.5.	Make Xbox Online Games Run Smoothly by UPnP .....	68

<b>Chapter 12.VPN Server .....</b>	<b>70</b>
12. 1. Use OpenVPN to Access Your Home Network.....	71
12. 2. Use PPTP VPN to Access Your Home Network .....	72
12. 3. Use IPSec VPN to Access Your Home Network .....	76
<b>Chapter 13.Specify Your Network Settings.....</b>	<b>80</b>
13. 1. LAN Settings .....	81
13. 1. 1. Change the LAN IP Address.....	81
13. 1. 2. Use the Modem Router as a DHCP Server.....	82
13. 1. 3. Reserve LAN IP Addresses.....	83
13. 2. IPv6 LAN Settings .....	83
13. 2. 1. Configure the RADVD Address Type .....	84
13. 2. 2. Configure the DHCPv6 Server Address Type.....	84
13. 3. DSL Settings .....	85
13. 4. Wireless Settings.....	86
13. 4. 1. Specify Basic Wireless Settings.....	86
13. 4. 2. Use WPS for Wireless Connection .....	88
13. 4. 3. Schedule Your Wireless Function .....	89
13. 4. 4. View Wireless Information .....	90
13. 4. 5. Advanced Wireless Settings .....	91
13. 5. Set Up a Dynamic DNS Service Account .....	92
13. 6. Create Static Routes.....	93
13. 7. Set Up the IPv6 Tunnel.....	95
13. 7. 1. Use the Public IPv6 Tunnel Service-6to4 .....	96
13. 7. 2. Specify the 6rd Tunnel with Parameters Provided by Your ISP.....	97
<b>Chapter 14.Administrate Your Network .....</b>	<b>98</b>
14. 1. Set System Time .....	99
14. 2. Update the Firmware.....	100
14. 2. 1. Online Upgrade .....	100
14. 2. 2. Local Upgrade .....	101
14. 3. Back up and Restore Configuration Settings .....	101
14. 4. Change the Administrator Account.....	102
14. 5. Local Management .....	103
14. 6. Remote Management.....	104
14. 7. System Log.....	105
14. 8. CWMP Settings.....	106
14. 9. SNMP Settings .....	108

Appendix: Troubleshooting .....	110
---------------------------------	-----







# About This Guide

This guide is a complement to Quick Installation Guide. The Quick Installation Guide provides instructions for quick internet setup, while this guide contains details of each function and demonstrates how to configure them in typical scenarios.

Note: Features available in the router may vary by model and software version. Router availability may also vary by region or ISP. All images, steps, and descriptions in this guide are only examples and may not reflect your actual Router experience.

## Conventions

In this guide, the following conventions are used:

Convention	Description
<u>Underline</u>	Hyperlinks are in teal and underlined. You can click to redirect to a website or a specific section.
Teal	Key information appears in teal, including management page text such as menus, items, buttons and so on.
>	The menu structures to show the path to load the corresponding page. For example, <a href="#">Advanced</a> > <a href="#">Wireless</a> > <a href="#">MAC Filtering</a> means the MAC Filtering function page is under the Wireless menu that is located in the Advanced tab.
 Note:	Ignoring this type of note might result in a malfunction or damage to the device.
 Tips:	Indicates important information that helps you make better use of your device.
Symbols on the web page	<ul style="list-style-type: none"><li> click to edit the corresponding entry.</li><li> click to delete the corresponding entry.</li><li> click to enable or disable the corresponding entry.</li><li> click to view more information about items on the page.</li></ul>

\*Maximum wireless signal rates are the physical rates derived from IEEE Standard 802.11 specifications. Actual wireless data throughput and wireless coverage are not guaranteed and will vary as a result of 1) environmental factors, including building materials, physical objects, and obstacles, 2) network conditions, including local interference, volume and density of traffic, product location, network complexity, and network overhead, and 3) client limitations, including rated performance, location, connection, quality, and client condition.

## More Info

The latest software, management app and utility can be found at [Download Center](#) at <https://www.tp-link.com/us/support/download/>.

The Quick Installation Guide can be found where you find this guide or inside the package of the router.

Specifications can be found on the product page at <https://www.tp-link.com>.

TP-Link Community is provided for you to discuss our products and share knowledge at <https://community.tp-link.com>.

Our Technical Support contact information can be found at the [Contact Technical Support](#) page at <https://www.tp-link.com/support/>.

## Chapter 1

---

# Get to Know Your Modem Router

---

This chapter introduces the modem router by detailing its main features and appearance.

It contains the following sections:

- [Product Overview](#)
- [Physical Appearance](#)



## 1.1. Product Overview

TP-Link's modem router is a combined wired/wireless network connection device with wireless router and DSL modem capabilities.

With DSL and WAN ports, the modem router is compatible with DSL connections and fiber/cable access.

Ethernet ports and adjustable antennas enable the modem router to provide wired and wireless access for multiple computers and mobile devices.

With an array of additional features, the modem router is the perfect hub for your home or business network.

With telephony feature, the modem router allows you to call via the internet.







## 1.2. Physical Appearance

### 1.2.1. Top Panel



The modem router's LEDs are located on the top panel. You can check the modem router's working status by following the LED Explanation table.

## LED Explanation

Name	Status	Indication
 Power	On	The system has started up successfully.
	Blinking	The system is starting up or firmware is being upgraded. Do not disconnect or power off your modem router.
	Off	Power is off. Please ensure that the power adapter is connected correctly.
 DSL	On	DSL synchronization is complete.
	Blinking	DSL synchronization is in progress.
	Off	DSL synchronization failed. Please refer to <a href="#">Note 1</a> for troubleshooting.
 Internet	On	Internet service is available.
	Off	No internet connection.
 Wi-Fi	On	Wireless function is working properly.
	Blinking	WPS connection is in progress (about 2 minutes).
	Off	Wireless function is disabled.
 Phone	On	The phone is off-hook or DECT handset is busy.
	Blinking	The phone is ringing or DECT cordless phone is ringing or registering.
	Off	The phone is on-hook.
 LAN	On	At least one LAN port is connected.
	Off	No LAN port is connected.

**Note:**

1. If the DSL LED is off, please check your internet connection. Refer to [Connect Your Modem Router](#) for more information about how to connect to the internet correctly. If you have already made a successful connection, please contact your ISP to make sure your internet service is available now.
2. If the Internet LED is off, please check your DSL LED first. If your DSL LED is also off, please refer to [Note 1](#). If your DSL LED is ON, reconnect your modem router correctly by referring to related guide.

## 1.2.2. Back Panel



The modem router's back panel shows the connection ports, buttons and antennas. Refer to the following for detailed instructions.

Item	Description
POWER	For connecting the modem router to a power socket via the provided power adapter.
RESET	Press and hold down for 5 seconds to reset the modem router into factory default settings.
DECT	Press and hold for about 3 seconds until the Phone LED flashes to register your DECT handset. Press briefly to page your registered DECT handsets.
WPS/ Wi-Fi ON/OFF	Press for 1 second to start a WPS synchronization. Press and hold for over 5 seconds to turn on or off Wi-Fi. Wi-Fi is turned on by default.
LAN1, LAN2, LAN3, LAN4/WAN	For connecting the modem router to your PC or other Ethernet network devices. In wireless router mode, the LAN4/WAN port is used for connecting to a Cable/FTTH/VDSL/ADSL device.
DSL	For connecting the modem router to the internet. Connect the port to the splitter or directly connect the port to the phone jack via a phone cable. For details, please refer to <a href="#">Connect Your Modem Router</a> .
Antennas	Used for wireless data transmission. Position them upright for the best performance.

### 1.2.3. Side Panel

The modem router's side panel shows ports. Refer to the following for detailed instructions.

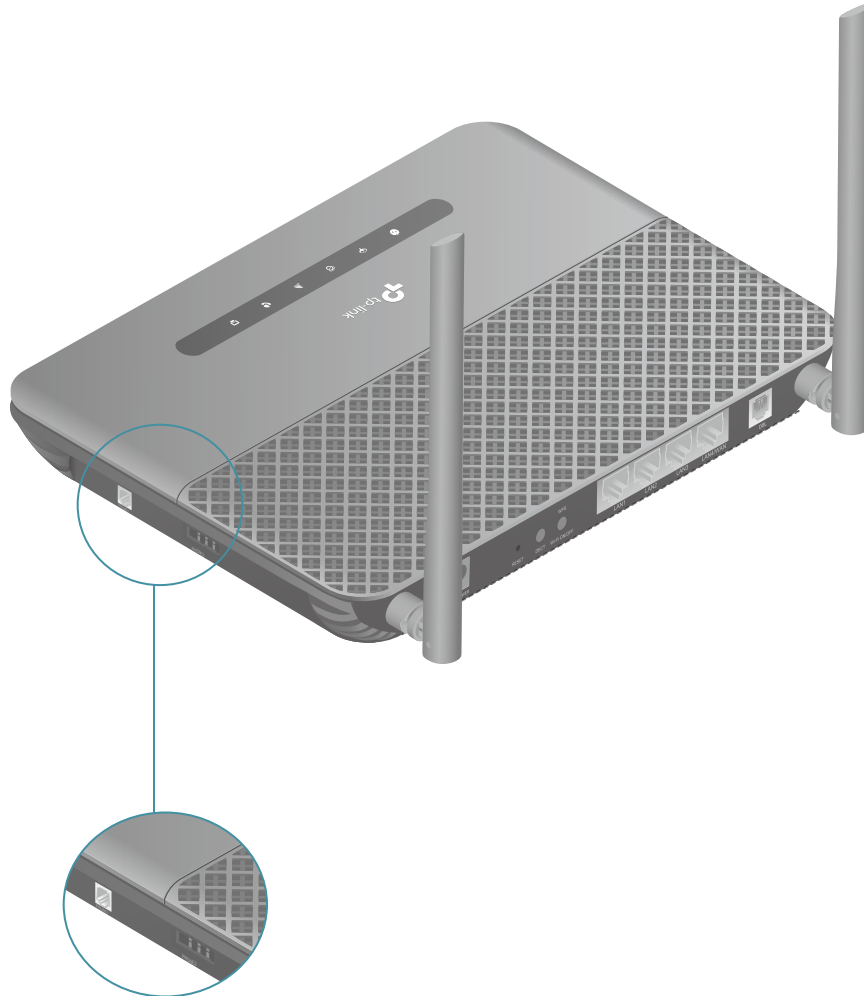

Item	Description
PHONE1/PHONE2	For connecting your analog phone to the modem router. Connect your analog phones to the TAE port or RJ11 port on the side panel. Note that the two ports cannot be conected simultaneously.

## Chapter 2

---

# Connect the Hardware

---

This chapter contains the following sections:

- [Position Your Modem Router](#)
- [Connect Your Modem Router](#)

## 2.1. Position Your Modem Router

With the modem router, you can access your network from anywhere within the wireless network coverage. However, the wireless signal strength and coverage varies depending on the environment your modem router is in. Obstacles may limit the range of the wireless signal, for example, concrete structures, thick walls.

For your security and best Wi-Fi performance, please:

- Do NOT locate the router in a place where it will be exposed to moisture or excessive heat.
- Keep the product away from strong electromagnetic radiation and devices that emit electromagnetic waves.
- Place the router in a location where it can be connected to the various devices as well as to a power source.
- Make sure the cables and power cord are safely placed out of the way to avoid a tripping hazard.

Generally, the router is placed on a horizontal surface, such as on a shelf or desktop. The device also can be mounted on the wall as shown in the following figure.

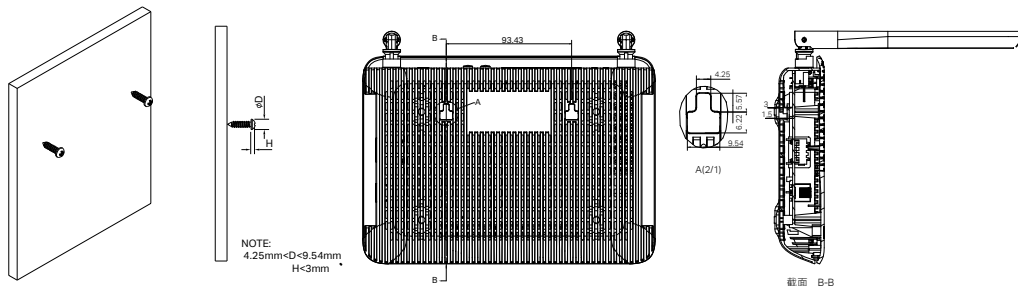

### Note:

The diameter of the screw,  $4.25\text{mm} < D < 9.54\text{mm}$ , and the distance of two screws is  $93.43\text{mm}$ . The screw that project from the wall need around  $10\text{mm}$  based, and the length of the screw need to be at least  $20\text{mm}$  to withstand the weight of the product.

## 2.2. Connect Your Modem Router

Follow the steps below to connect your modem router.

1. Connect the DSL line and power adapter. The electrical outlet shall be installed near the device and shall be easily accessible.

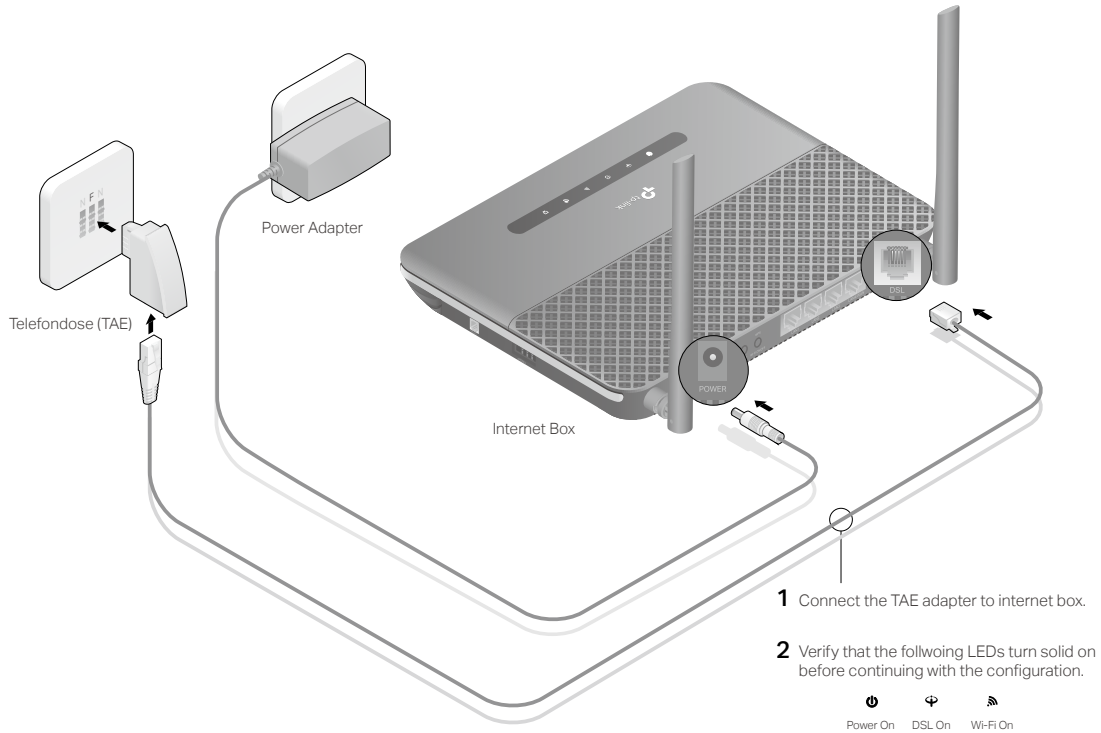

2. Connect your computer to the modem router.

**Method 1: Wired**

Connect your computer's Ethernet port to the LAN port on the modem router via the Ethernet cable.



**Method 2: Wirelessly**

Use the default SSID (Wireless Network Name) and Password printed on the included Wi-Fi Info Card or on the product label of the modem router to connect wirelessly.

Computer

Smart Device

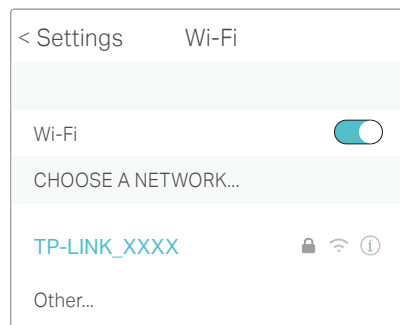
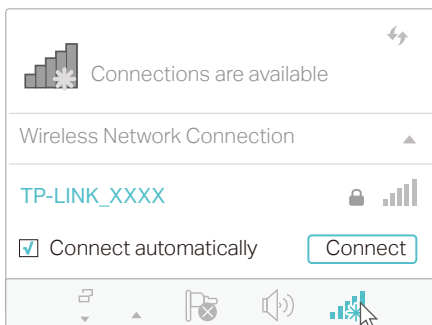

### Method 3: Use the WPS button

Wireless devices that support WPS, including Android phones, tablets, most USB network cards, can be connected to your router through this method. (WPS is not supported by iOS devices.)

**Note:**

The WPS function cannot be configured if the wireless function of the router is disabled. Also, the WPS function will be disabled if your wireless encryption is WEP. Please make sure the wireless function is enabled and is configured with the appropriate encryption before configuring the WPS.

- 1) Tap the WPS icon on the device's screen.
- 2) Immediately press the WPS button on your modem router.
- 3) The wireless LEDs flash for about two minutes during the WPS process.
- 4) When the wireless LEDs stabilize and remain on, the client device has successfully connected to the modem router.

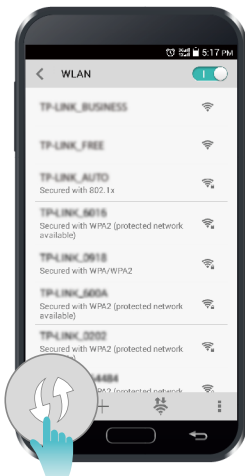



## Chapter 3

---

# Log In to Your Modem Router

---

With the web management page, it is easy to configure and manage the modem router. The web management page can be used on any Windows, Macintosh or UNIX OS with a Web browser, such as Microsoft Internet Explorer, Mozilla Firefox or Apple Safari.

Follow the steps below to log in to your modem router.

1. If the TCP/IP Protocol on your computer is set to the static (fixed) IP address, you need to change its settings to obtain an IP address automatically. Refer to [Appendix: Troubleshooting](#) to configure your computer.
2. Launch a web browser and go to <http://tplinkmodem.net> or <http://192.168.1.1>. Create a strong password and click **Los geht's** to log in.

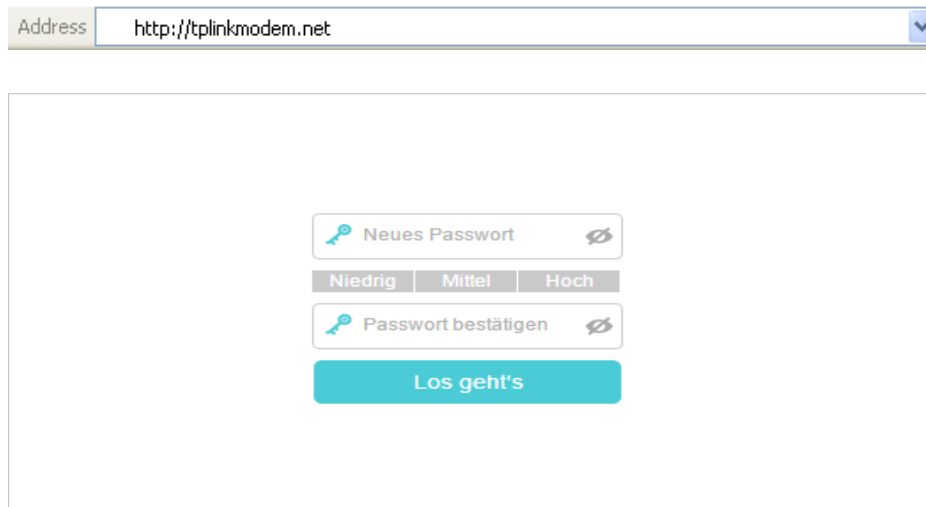

The screenshot shows a web browser window with the address bar containing 'http://tplinkmodem.net'. Below the address bar is a large white rectangular area containing a password creation form. The form consists of the following elements from top to bottom: a text input field labeled 'Neues Passwort' with a key icon and a clear button; a strength indicator with three buttons labeled 'Niedrig', 'Mittel', and 'Hoch'; a second text input field labeled 'Passwort bestätigen' with a key icon and a clear button; and a large teal button labeled 'Los geht's'.

**Note:**

1. If you have registered a TP-Link ID and bind your cloud router to it, the login password you created here should be ineffective. Please log in to the cloud router using your TP-Link ID.
2. You can change the display language of the product according to your needs. In this guide we use English as the display language of the product to illustrate the features.

## Chapter 4

---

# Set Up Internet Connections

---

This chapter introduces how to connect your modem router to the internet. The modem router is equipped with a web-based Quick Setup wizard. It has many ISP information built in, automates many of the steps and verifies that those steps have been successfully completed. Furthermore, you can also set up an IPv6 connection if your ISP provides IPv6 service.

This chapter includes the following sections:

- [Use Quick Setup Wizard](#)
- [Manually Set Up an Internet Connection](#)
- [Test Internet Connectivity](#)
- [Set Up an IPv6 Connection](#)
- [More Operation Modes](#)

## 4.1. Use Quick Setup Wizard

1. Visit <http://tplinkmodem.net>, and log in with the password you set for the modem router.
2. Click **Quick Setup** on the top of the page. Then follow the step-by-step instructions to connect your router to the internet and configure the VoIP parameters.
3. To enjoy a more complete service from TP-Link (remote management, TP-Link DDNS, etc.), log in with your TP-Link ID or click **Register Now** to get one. Then follow the instructions to bind the modem router to your TP-Link ID.

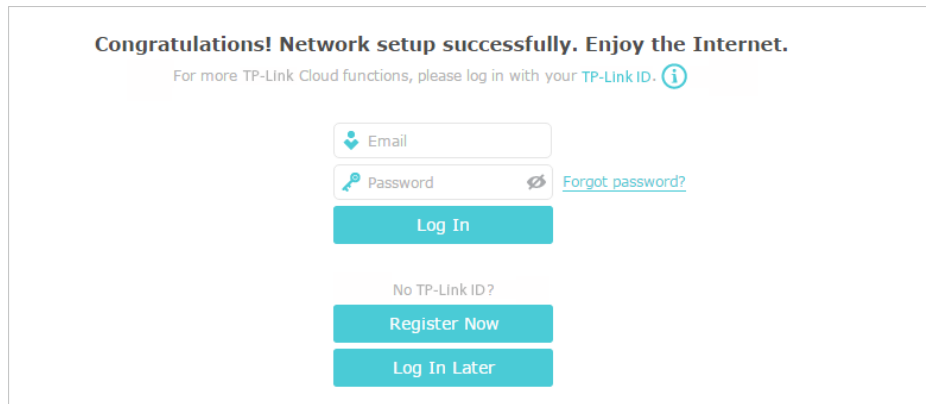

**Congratulations! Network setup successfully. Enjoy the Internet.**

For more TP-Link Cloud functions, please log in with your TP-Link ID. [i](#)

Email

Password  [Forgot password?](#)

**Log In**

No TP-Link ID?

**Register Now**

**Log In Later**

### Note:

1. To learn more about the TP-Link Cloud service, please refer to the TP-Link Cloud section.
2. If you do not want to register a TP-Link ID for now, you may click **Log In Later** to proceed.
3. If you have changed the preset wireless network name (SSID) and wireless password during the Quick Setup process, all your wireless devices must use the new SSID and password to connect to the router.

## 4.2. Manually Set Up an Internet Connection

1. Visit <http://tplinkmodem.net>, and log in with the password you set for the modem router.
2. Go to **Basic > Internet** page. Select your ISP, and related information will be automatically filled in. For some ISPs, you may need to manually specify some information provided. If you can't find your ISP in the **ISP List**, select **Other** and then enter the information provided by your ISP.

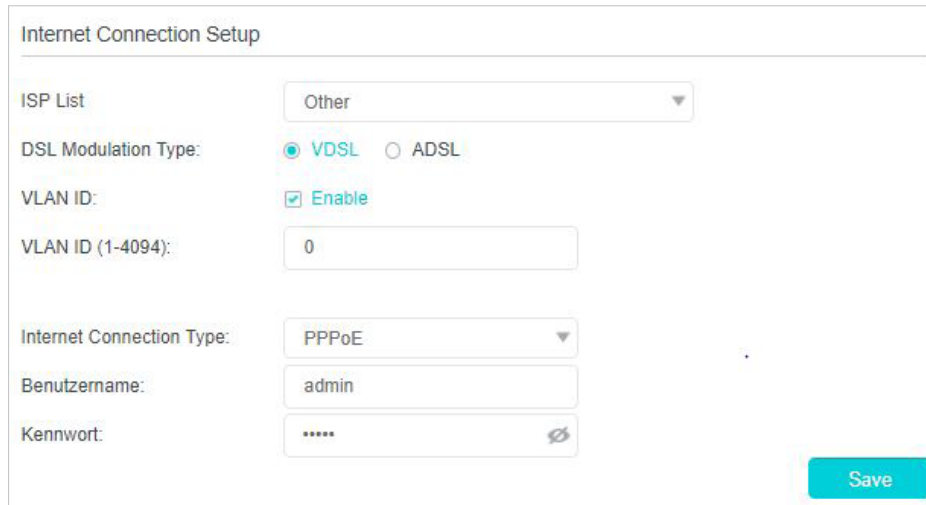

Internet Connection Setup

ISP List: Other

DSL Modulation Type:  VDSL  ADSL

VLAN ID:  Enable

VLAN ID (1-4094): 0

Internet Connection Type: PPPoE

Benutzername: admin

Kennwort: \*\*\*\*\*

Save

3. Click [Save](#) to make the settings effective, and you can refer to [Test Internet Connectivity](#) to test the internet connection.

 **Tips:** You can view and edit all internet connection settings on the [Advanced > Network > Internet](#) page.

## 4.3. Test Internet Connectivity

After manually setting up the internet connection, you need to test the internet connectivity. The modem router provides a diagnostic tool to help you locate the source of any problems.

1. Visit <http://tplinkmodem.net>, and log in with the password you set for the modem router.
2. Go to [Advanced > System Tools > Diagnostics](#) page.

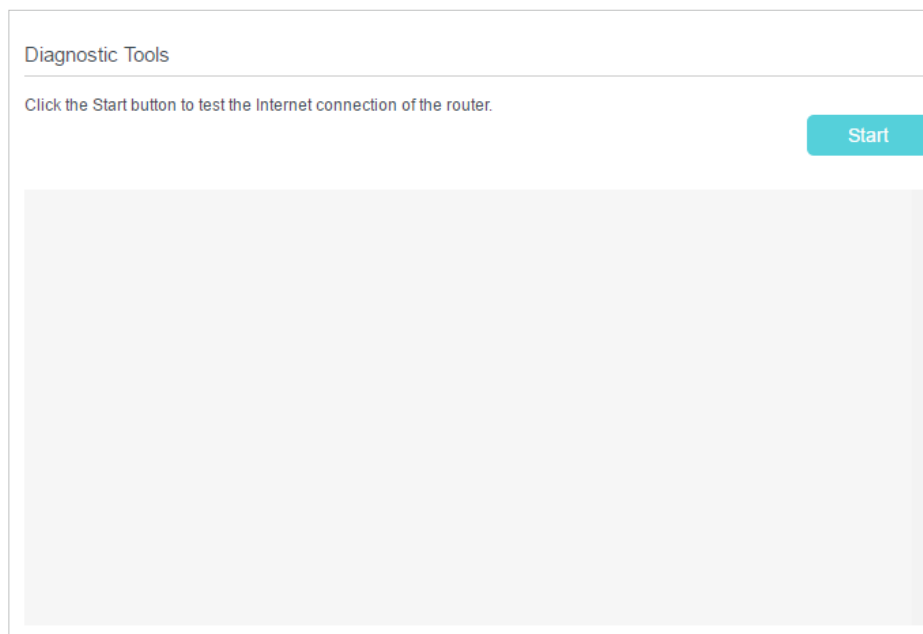

Diagnostic Tools

Click the Start button to test the Internet connection of the router.

Start

3. Click [Start](#) to test the internet connectivity and you will see the test result in the gray box.

## 4.4. Set Up an IPv6 Connection

If your ISP has provided a DSL line that supports IPv6 connection as well as some detailed IPv6 parameters, you can manually set up an IPv6 connection.

If your ISP provides an IPv4-only connection or IPv6 tunnel service, permit IPv6 connection by referring to [Set Up the IPv6 Tunnel](#).

Follow the steps below to set up an IPv6 connection:

1. Make sure you have set up an IPv4 connection either manually or by using the Quick Setup wizard before setting up an IPv6 connection.
2. Visit <http://tplinkmodem.net>, and log in with the password you set for the modem router.
3. Go to [Advanced](#) > [Network](#) > [Internet](#) page.

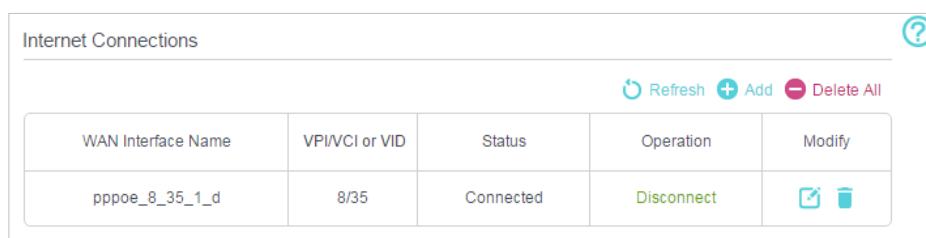

WAN Interface Name	VPI/VCI or VID	Status	Operation	Modify
pppoe_8_35_1_d	8/35	Connected	Disconnect	

4. Select your WAN Interface Name (**Status** should be **Connected**) and click the (Edit) icon.
5. Scroll down the page, enable **IPv6**, and configure the IPv6 parameters.

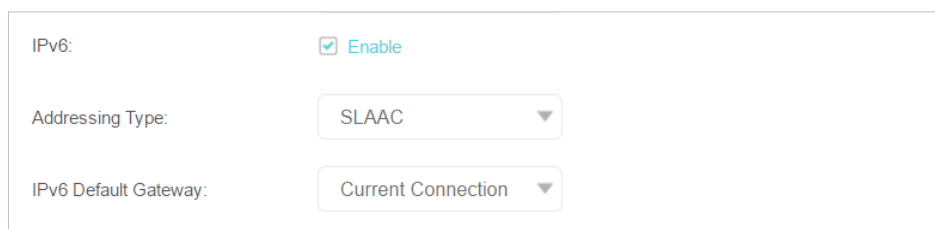

IPv6:  Enable

Addressing Type:

IPv6 Default Gateway:

- **Addressing Type:** Consult your ISP for the addressing type (DHCPv6 or SLAAC). SLAAC is the most commonly used addressing type.
- **IPv6 Default Gateway:** Keep the default setting as **Current Connection**.

**Note:** If your ISP has provided the IPv6 address, click [Advanced](#) to reveal more settings. Check to use IPv6 specified by ISP and enter the parameters provided by your ISP.

6. Click **OK** to make the settings effective. Now IPv6 service is available for your network.

## 4.5. Operation Mode

The modem router also supports Wireless Router mode. You can change the mode according to your needs.

If you already have a modem or your internet comes via an Ethernet jack on the wall, you can set up the modem router as a regular wireless router to share the internet.

1. Find the WAN port (labeled as LAN4/WAN) on the modem router, and connect it to your existing modem or the Ethernet jack on the wall. Then connect the power adapter and turn on the modem router.
2. Connect your computer to the modem router. For details, refer to [Connect Your Modem Router](#).
3. Visit <http://tplinkmodem.net>, and log in with the password you set for the modem router.
4. Go to [Advanced](#) > [Operation Mode](#), select the [Wireless Router Mode](#), and click [Save](#). The modem router will reboot.

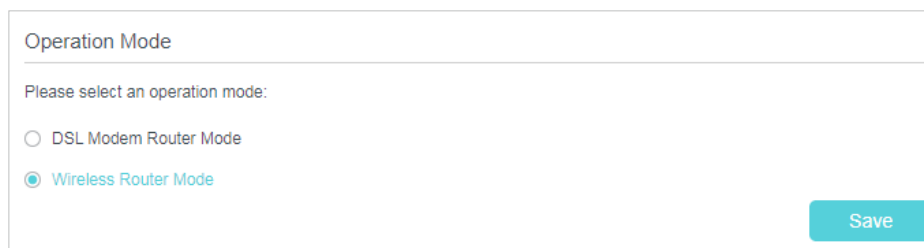

Operation Mode

Please select an operation mode:

DSL Modem Router Mode

Wireless Router Mode

Save

5. Go to [Basic](#) > [Internet](#), select the [Connection Type](#), and enter the information provided by your ISP.

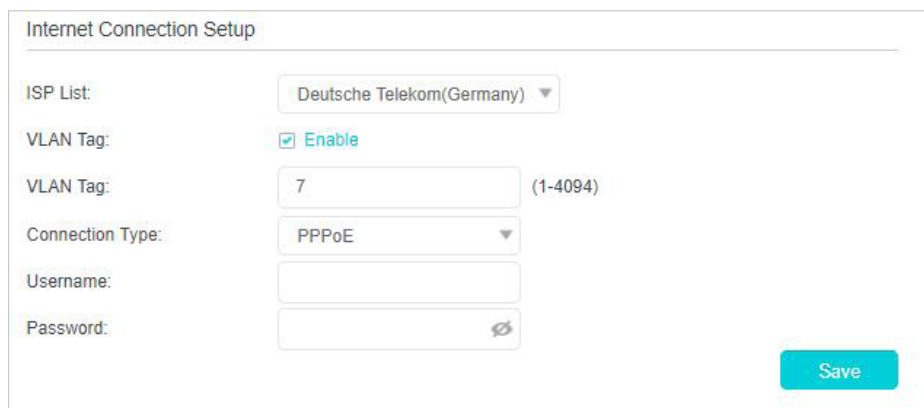

Internet Connection Setup

ISP List: Deutsche Telekom(Germany)

VLAN Tag:  Enable

VLAN Tag: 7 (1-4094)

Connection Type: PPPoE

Username:

Password:

Save

6. Click [Save](#) to make the settings effective.

### Tips:

1. You can view and edit all internet connections on [Advanced](#) > [Network](#) > [Internet](#) page.
2. In the Wireless Router Mode, you can also permit IPv6 connection by setting up an IPv6 connection or the IPv6 tunnel just as in the DSL Modem Router Mode. For details, refer to [Set Up an IPv6 Connection](#) and [Set Up the IPv6 Tunnel](#).

## Chapter 5

---

# TP-Link Cloud Service

---

TP-Link Cloud service provides a better way to manage your cloud devices. Log in to your router with a TP-Link ID, and you can easily monitor and manage your home network when you are out and about via the Tether app on your smartphone or tablet. To ensure that your router stays new and gets better over time, the TP-Link Cloud will notify you when an important firmware upgrade is available. Surely you can also manage multiple TP-Link Cloud devices with a single TP-Link ID.

This chapter introduces how to register a new TP-Link ID, bind or unbind TP-Link IDs to manage your router, and how to manage your home network via the Tether app wherever you are.

It contains the following sections:

- [Register a TP-Link ID](#)
- [Change Your TP-Link ID Information](#)
- [Manage the User TP-Link IDs](#)
- [Manage the Router via TP-Link Tether App](#)



## 5.1. Register a TP-Link ID

If you have skipped the registration during the Quick Setup process, you can:

1. Visit <http://tplinkmodem.net>, and log in with the password you set for the router.
2. Go to [Basic > TP-Link Cloud](#).
3. Click [Register Now](#) and follow the instructions to register a TP-Link ID.

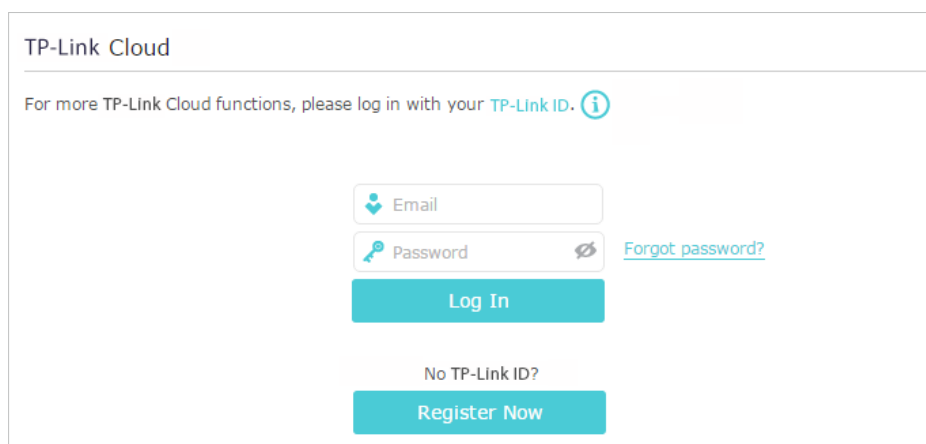

TP-Link Cloud

For more TP-Link Cloud functions, please log in with your TP-Link ID. [i](#)

Email

Password [Forgot password?](#)

Log In

No TP-Link ID?

Register Now

4. After activating your TP-Link ID, come back to the TP-Link Cloud page to log in. The first-time login TP-Link ID will be bound automatically to your cloud router as an [Admin](#).

**Note:**

- Once the router is bound to your TP-Link ID, you need to log in to the router with the TP-Link ID.
- The TP-Link ID also can be registered via the TP-Link Tether app. Please refer to [Install the Tether App on Your Smartphones or Tablets](#) to install the app. Launch the app, tap  in the top-left corner of the screen and tap [Login](#), and then click [New User](#) to register a new one.
- If you want to unbind the admin TP-Link ID from your router, please go to [Basic > TP-Link Cloud](#), click [Unbind](#) in the [Device Information](#) section.

## 5.2. Change Your TP-Link ID Information

Follow the steps below to change your email address and password of your TP-Link ID as needed.

1. Visit <http://tplinkmodem.net>, and log in with your TP-Link ID.
2. Go to [Basic > TP-Link Cloud](#), and focus on the [Account Information](#) section.

- **Change your email address**

1. Click  behind the Email.
2. Enter the password of your TP-Link ID, then the new email address. And click [Save](#).

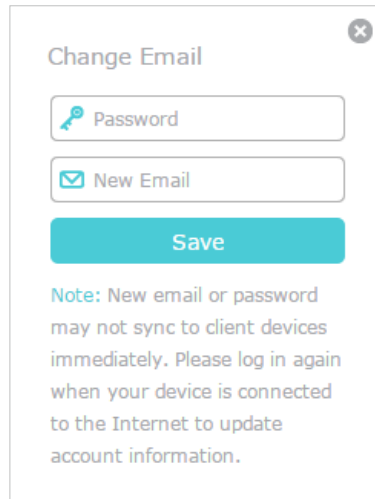

Change Email

Password

New Email

Save

Note: New email or password may not sync to client devices immediately. Please log in again when your device is connected to the Internet to update account information.

- **Change your password**

1. Click  behind the Password.
2. Enter the current password, then a new password twice. And click [Save](#).

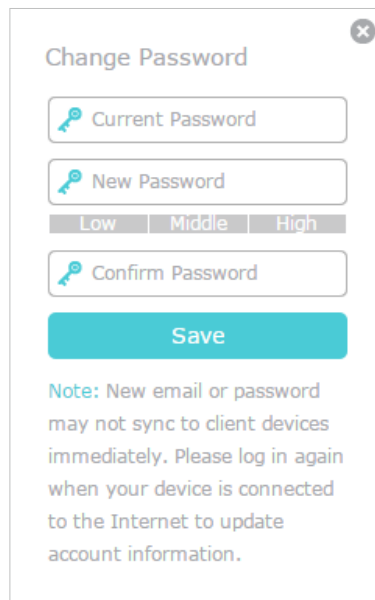

Change Password

Current Password

New Password

Low Middle High

Confirm Password

Save

Note: New email or password may not sync to client devices immediately. Please log in again when your device is connected to the Internet to update account information.

### 5.3. Manage the User TP-Link IDs

The first-time login TP-Link ID will be bound automatically to your router as an [Admin](#) account. An admin account can add or remove other TP-Link IDs to the same router as [Users](#). Admin account and User accounts both can monitor and manage the router locally or remotely, except that user accounts cannot:

- Reset the router to its factory default settings from the web management page or the Tether app.

- Add/remove other TP-Link IDs to/from the router.

### 5.3.1. Add an TP-Link ID to Manage the Router

1. Visit <http://tplinkmodem.net>, and log in with your TP-Link ID.
2. Go to **Basic** > **TP-Link Cloud**, and focus on the **Bound Accounts** section.
3. Click **+ Bind**, enter another TP-Link ID as needed and click **Save**.

**Note:**

If you need another TP-Link ID, please refer to [Install the Tether App on Your Smartphones or Tablets](#) to install the app. Launch the app, tap  in the top-left corner of the screen and tap **Login**, and then click **New User** to register a new one.

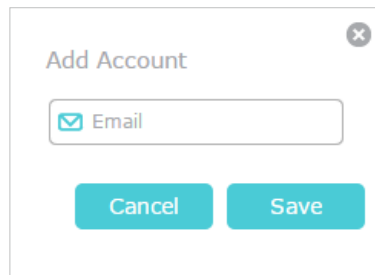

4. The new TP-Link ID will be displayed in the Bound Accounts table as a **User**.

Bound Accounts				
<span style="color: teal;">+</span> Bind <span style="color: red;">-</span> Unbind				
<input type="checkbox"/>	ID	Email	Binding Date	Role
<input type="checkbox"/>	1	*****@****.com	16/11/2016	Admin
<input type="checkbox"/>	2	*****@****.com	16/11/2016	User

### 5.3.2. Remove TP-Link ID(s) From Managing the Router

1. Visit <http://tplinkmodem.net>, and log in with your TP-Link ID.
2. Go to **Basic** > **TP-Link Cloud**, and focus on the **Bound Accounts** section.
3. Check the box(es) of the TP-Link ID(s) you want to remove and click **Unbind**.

Bound Accounts				
<span style="color: teal;">+</span> Bind <span style="color: red;">-</span> Unbind				
<input type="checkbox"/>	ID	Email	Binding Date	Role
<input type="checkbox"/>	1	*****@****.com	16/11/2016	Admin
<input checked="" type="checkbox"/>	2	*****@****.com	16/11/2016	User

## 5.4. Manage the Router via TP-Link Tether App

The Tether app runs on iOS and Android devices like smartphones and tablets.

1. Launch the Apple App Store or Google Play store and search “TP-Link Tether” or simply scan the QR code to download and install the app.



2. Connect your device to the router’s wireless network.
3. Launch the Tether app, select the model of your router and log in with your TP-Link ID or the password your set for the router.
4. Manage your router as needed.

■ Note: If you need to remotely access your router from your smart devices, you need to:

- Log in with your TP-Link ID. If you don’t have one, refer to [Register a TP-Link ID](#).
- Make sure your smartphone or tablet can access the internet with cellular data or a Wi-Fi network.

## Chapter 6

---

# Telephony

---

This chapter guides you on how to make telephone calls via internet.

- [Connecting the Telephone](#)
- [DECT](#)
- [Entering Telephone Information](#)
- [Telephone Book](#)
- [Telephony Devices Management](#)
- [Call Log](#)
- [Calling via Which Number](#)
- [Call Blocks](#)
- [Forwarding Calls](#)
- [Call Through](#)
- [tpPhone](#)
- [Voice Mail](#)

## 6.1. Connecting the Telephone

Connect your telephone to the TAE ports or RJ11 ports on the side panel. Note that the RJ-11 and TAE ports cannot be connected simultaneously.

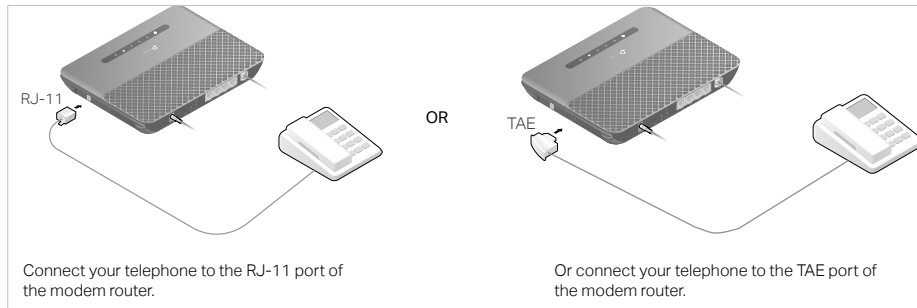

## 6.2. DECT

The modem router is integrated with DECT (Digital Enhanced Cordless Telecommunications) function. With this function enabled, you can register your cordless phone on the modem router and make calls via internet.

### 6.2.1. Registering DECT Handset

There are two ways to register your DECT handset.

#### Method 1: Via DECT Button

1. Set your DECT handset in the registration mode, and then press and hold the DECT button on the DSL router for about 3 seconds until the Phone LED  flashes.

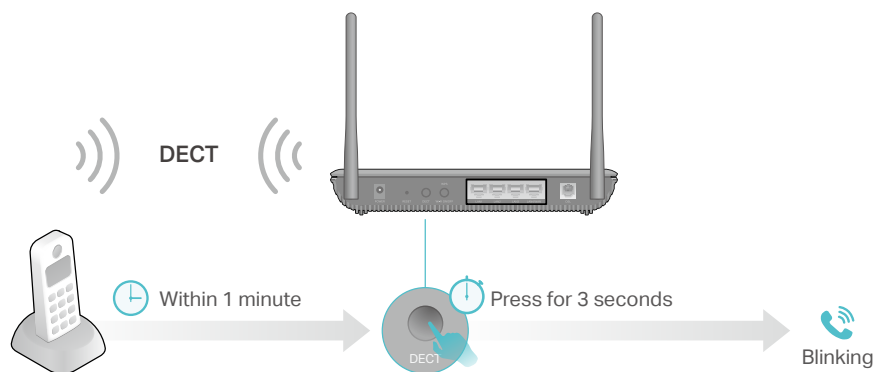

2. Enter the PIN (Default: 0000) on the DECT handset if required.

#### Notes:



1. Up to six DECT handsets can be registered on the modem router and up to 4 DECT handsets can make or receive calls simultaneously.
2. If you press the DECT button for more than 4 seconds, and the Phone LED still does not light, release the button and try again. If the problem persists, please reboot the modem router and try again.

## Method 2: Via Web Management Interface

Follow the steps below to register:

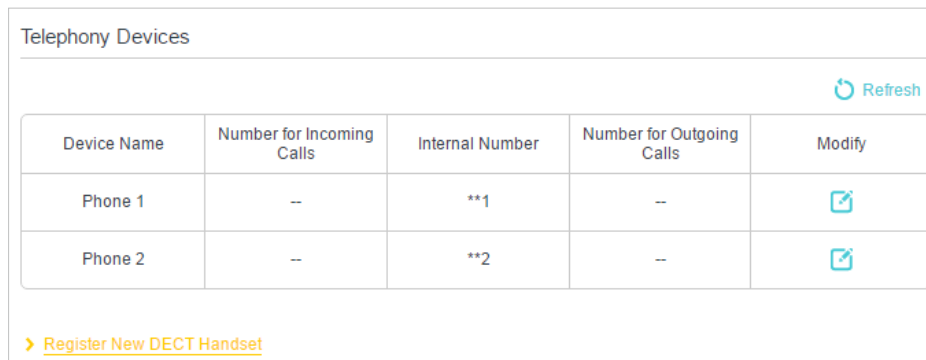
1. Visit <http://tplinkmodem.net>, and log in with your TP-Link ID or the password you set for the router.
2. Go to [Advanced](#) > [Telephony](#) > [Telephony Devices](#) to open the registration page.



Device Name	Number for Incoming Calls	Internal Number	Number for Outgoing Calls	Modify
Phone 1	--	**1	--	
Phone 2	--	**2	--	

[> Register New DECT Handset](#)

3. Click [Register New DECT Handset](#) and follow instructions on the page to register your DECT handset.

### 6.2.2. Configuring DECT Settings

Configure DECT settings on the web management page of the modem router.

Follow the steps below to configure:

1. Visit <http://tplinkmodem.net>, and log in with your TP-Link ID or the password you set for the router.
2. Go to [Advanced](#) > [Telephony](#) > [DECT](#), and you will see the following screen.

DECT Settings

DECT:

Registration

Your tpPhone must be registered on the product for you to make calls. For registration, a PIN is required. Define the PIN here (create a new one or keep the default 0000) and enter it on the tpPhone during registration.

PIN:

Radio Field Strength

Radio Field Strength  Reduce DECT Field Strength  Eco DECT

Security

Encryption  Enable (Recommended)

Save

3. Enable **DECT**.
4. The **PIN** code is needed when registering your cordless phone. The default is 0000. Change it by entering a new one.
5. **Reduce DECT Field Strength**: Check the box to enable this function. In this mode, base transmit power will be decreased. Then the DECT Handset will have signal within a small distance.
6. **Eco DECT**: Only when all handsets support Eco Mode, will it take effect. In this mode, if all the handsets standby for more than one minutes, DECT Base and DECT Handsets would be in Eco Mode and do not emit any signal. It will wake up automatically when there is a call.
7. **Security**: Check the box if you want the DECT/CAT-iq encrypt security to take effect.
8. Click **Save** to make the settings effective.

### 6.3. Entering Telephone Information

Before using telephony services, you should first enter your telephone information provided by your telephony service provider.

Follow the steps below to enter information:

1. Visit <http://tplinkmodem.net>, and log in with your TP-Link ID or the password you set for the router.
2. Go to **Advanced > Telephony > Telephone Numbers** to open the configuration page.
3. In the **Telephone Numbers** section, click **Add**.



4. Choose your **Telephony Provider** and enter the necessary information as required.

The screenshot shows the 'Telephone Numbers' configuration interface. At the top, there are buttons for 'Refresh', '+ Add', and '- Delete All'. Below this is a table with columns: Status, Telephone Number, Provider, and Modify. The table contains one row with dashes in all cells. Below the table, the 'Telephony Provider' dropdown is set to 'Telekom'. The 'Number' section has two input fields: 'Area code' and 'Phone Number'. At the bottom are 'Cancel' and 'Save' buttons.

If your telephony provider is not listed here, choose **Other** and enter the information as required.

The screenshot shows the 'Telephone Numbers' configuration interface with 'Other' selected as the provider. The 'Number' section now includes four additional input fields: 'Phone Number', 'Registrar Address', 'Authentication ID', and 'Password'. The 'Area Code' field is also present. A note below the 'Area Code' field states: 'By entering your area code, you can make a local call without dialing the area code first. The area code is added as the prefix automatically each time you make a local call.' There is a 'Advanced' toggle button and 'Cancel' and 'Save' buttons at the bottom.

**Phone Number:** The number you use to dial and answer.

**Registrar Address:** Usually a domain name, if not, an IP address.

**Authentication ID and Password:** Not necessary information, but if you have, fill them in.

**Area Code:** The area code of your city or region.

**Advanced:** Click to have more configuration.

- (Optional) In [IPv6 Settings](#) section, enable IPv6 Settings if you want to use IPv6 instead of IPv4 service for VoIP calls. Please contact your service provider to make sure they have deployed IPv6 service for VoIP calls, or you can't use the VoIP calls.

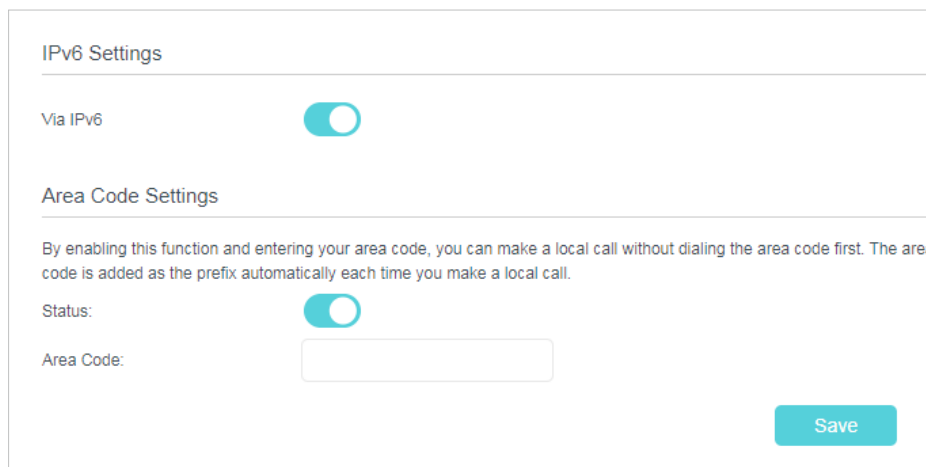

The screenshot shows the 'IPv6 Settings' configuration panel. At the top, the title 'IPv6 Settings' is displayed. Below it, there is a toggle switch labeled 'Via IPv6' which is currently turned on. Underneath, the 'Area Code Settings' section is visible. It includes a descriptive text: 'By enabling this function and entering your area code, you can make a local call without dialing the area code first. The area code is added as the prefix automatically each time you make a local call.' Below this text, there is a 'Status:' label with a toggle switch that is turned on, and an 'Area Code:' label with an empty text input field. A blue 'Save' button is located at the bottom right of the panel.

- In the [Area Code Settings](#) section, enable this function and enter the area code of your city or region. This can spare you the trouble of including the area code each time you make a local call over the internet.
- (Optional) If you have entered an area code, you can also make exceptions for specific numbers. Then these numbers will not be added with an area code automatically. By default, the three exceptional numbers have been added: 110, 112, 116117.

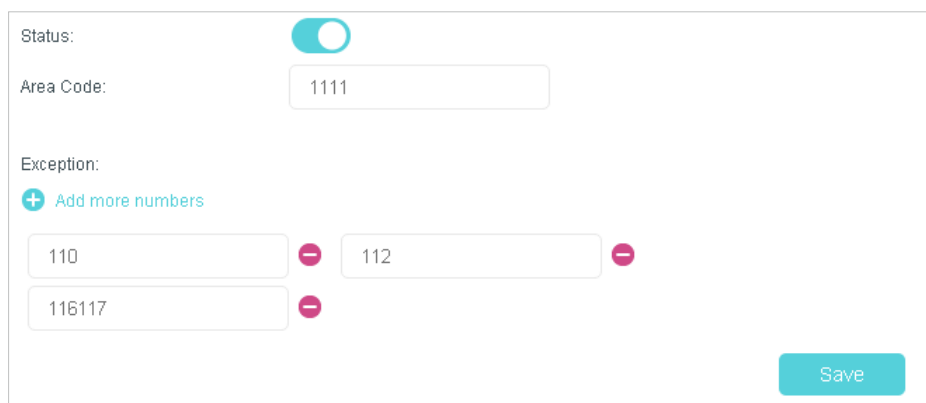

The screenshot shows the 'Area Code Settings' configuration panel. It features a 'Status:' label with a toggle switch that is turned on. Below this, there is an 'Area Code:' label with a text input field containing the value '1111'. Underneath, the 'Exception:' section is visible, starting with a blue plus icon and the text '+ Add more numbers'. Below this, there are three text input fields, each containing a number: '110', '112', and '116117'. Each input field has a red minus icon to its right, indicating that these numbers can be removed from the list of exceptions. A blue 'Save' button is located at the bottom right of the panel.

- Click [Save](#) to make the settings effective.

### To have more configuration on telephony settings

Click [Advanced](#) in the [Advanced Settings](#) section to configure more telephony settings.

Advanced Settings

---

⬆️ Advanced

Bound Interface:

Locale Selection:

DSCP for SIP:

DSCP for RTP:

DTMF Relay Setting:

Registry Expiration Time:  (300-3600 seconds)

Registry Retry Interval:  (30-300 seconds)

No Answer Time:  (5-60 seconds)

T.38 Support:  Enable

End with #:  Enable

**Bound Interface:** Bound Interface decides where to send/receive the VoIP traffic. An easy way to select the interface is to check the location of the SIP (Session Initiation Protocol) server. If it locates somewhere on the internet then select [Any\\_WAN](#). If it is on the local network, select [LAN](#).

**Locale Selection:** Select a country where you are located. The modem router is embedded with some default parameters according to different countries such as ring tones. The default country is Germany.

**DSCP for SIP/RTP:** DSCP (Differentiated Services Code Point) is the first 6 bits in the ToS byte. DSCP marking allows users to assign specific application traffic to be executed in priority by the next Router based on the DSCP value. Select DSCP for the SIP (Session Initiation Protocol) and RTP (Real-time Transport Protocol) respectively. If you are unsure, please always keep the default value.

**DTMF Relay Setting:** DTMF is Dual Tone Multi Frequency. Options available are SIP-Info, RFC2833, and In-band. If you are unsure which one to choose, please always keep the default value.

- **SIP INFO:** If it is selected, the modem router will capture the DTMF tone and transfer it into SIP form. Then it will be sent to the remote end with SIP message.
- **RFC2833:** If it is selected, the modem router will capture the keypad number you pressed and transfer it into digital form then send to the other side; the receiver will generate the tone according to the digital form it receives. This function is very useful when the network traffic congestion occurs and it still can remain the accuracy of DTMF tone.

- **In-band:** If it is selected, the modem router will send the DTMF tone as audio directly when you press the keypad on the phone.

**Registry Expiration Time:** Expiration time for the registration message sending.

**Registration Retry Interval:** Set the time duration for your SIP Registrar server to keep your registration record. Before the time expires, the Modem Router will send another register request to SIP Registrar again. If you are unsure of it, please always keep the default value.

**No Answer Time:** Set a time period, after which the caller is told that the call is not answered and he or she can leave a message if the voice mail function is enabled.

**T. 38 support:** Select the check box to enable this function. T. 38 specifies a protocol for transmitting a fax across IP network in real time. It allows the transfer of fax documents in real-time between two standard Group 3 facsimile terminals over the internet or other networks using IP protocols. It will only function when both sites support this feature and are enabled.

**End With #:** Choose whether to use “#” as the end signal of your dialing or not.

When the **Status** column change to , your telephone information is successfully registered. At this time, you can pick up your phone, dial the number, and call via internet!

## 6.4. Telephone Book

You can store all contacts on your modem router, have a telephone book, set speed dial number for some contacts and enable emergency calls.

### 6.4.1. Telephone Book

Follow the steps below to have a telephone book on the modem router.

1. Visit <http://tplinkmodem.net>, and log in with your TP-Link ID or the password you set for the router.
2. Go to **Advanced > Telephony > Telephone Book**. Click **Add** to enter a new contact's information.

The screenshot shows the 'Telephone Book' interface. At the top, there is a search bar with a magnifying glass icon. To the right of the search bar are buttons for 'Import', 'Export', 'Add', and 'Delete All'. Below this is a table with the following columns: 'Name', 'Telephone Number', 'Speed Dial Number', and 'Modify'. The table currently contains one row with dashes in each cell. Below the table is a form for adding or editing a contact. The form includes the following fields: 'First Name:' with a text input, 'Last Name:' with a text input, 'Private Phone Number:' with a text input, 'Work Phone Number:' with a text input, 'Mobile Phone Number:' with a text input, 'Speed Dial Number Type:' with a dropdown menu showing '-Please Select-', and 'Speed Dial Number:' with a text input. At the bottom right of the form are two buttons: 'Cancel' and 'Save'.

3. You can set speed dial number for certain numbers. Speed dial function allows you to reach the desired party by dialing the reduced number of keys rather than a long phone number.
4. Click [Save](#) to save the settings.

You can quickly find the number you want by searching keyword on the upper left corner.

### 6.4.2. Emergency Calls

#### I want to:

Make my telephone automatically call a specific contact when the handset is picked up but no operation is done within a period of time. In this way the old, the kids, the patient or the pregnant in house are able to send signals for help when emergencies occur.

#### How can I do that?

1. Visit <http://tplinkmodem.net>, and log in with your TP-Link ID or the password you set for the router.
2. Go to [Advanced](#) > [Telephony](#) > [Telephone Book](#).

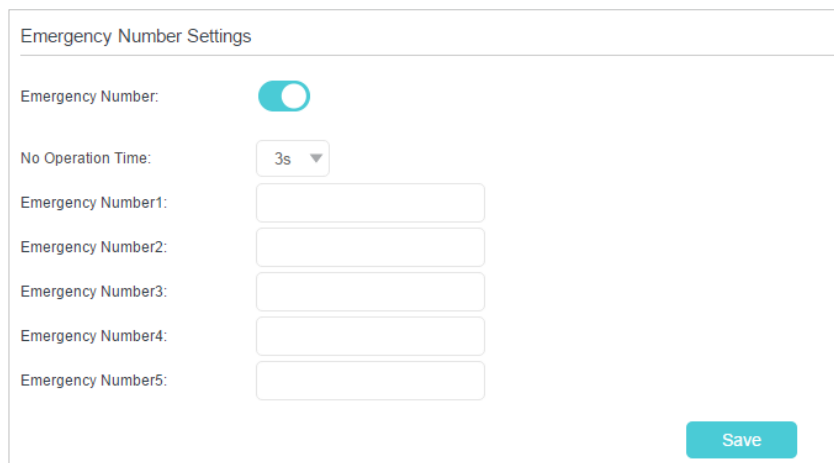

Emergency Number Settings

Emergency Number:

No Operation Time: 3s ▼

Emergency Number1:

Emergency Number2:

Emergency Number3:

Emergency Number4:

Emergency Number5:

Save

3. Enable Emergency Number.
4. **No Operation Time:** Set how long should the telephone wait before the first number is automatically dialed).
5. **Emergency Number:** Set the number to be automatically reached. If more than one number is set, the modem router will automatically call the next one if the previous is not answered.
6. Click **Save** to make the settings effective.

## Done!

From now on, if you pick up your phone but do not dial within the no operation time, your phone will automatically call the emergency number!

## 6. 5. Telephony Devices Management

### I want to:

Bind different telephony devices with different incoming and outgoing call numbers, because I have more than one telephone number and telephony device and I don't want all telephones ring at the same time when a number is called.

### How can I do that?

1. Visit <http://tplinkmodem.net>, and log in with your TP-Link ID or the password you set for the router.
2. Go to **Advanced > Telephony > Telephony Devices**.

Telephony Devices				
Device Name	Number for Incoming Calls	Internal Number	Number for Outgoing Calls	Modify
Phone 1	--	**1	--	
Phone 2	--	**2	--	

[Register New DECT Handset](#)

- Click to manage your telephony devices.

Telephony Devices				
Device Name	Number for Incoming Calls	Internal Number	Number for Outgoing Calls	Modify
Phone 1	--	**1	--	
<p>Device name: <input type="text" value="Phone 1"/></p> <p>Number for Outgoing Calls: <input type="text" value="Auto"/></p> <p>Number for Incoming Calls: <input type="checkbox"/></p> <p>VAD Support: <input checked="" type="checkbox"/> Enable VAD</p> <p>Speaker Gain: <input type="range" value="50"/></p> <p>Mic Gain: <input type="range" value="50"/></p> <p><input type="button" value="Cancel"/> <input type="button" value="Save"/></p>				
Phone 2	--	**2	--	

[Register New DECT Handset](#)

- Device Name:** Name the telephone device here.
- Number for Outgoing Calls:** Assign an outgoing number for this phone.
- Number for Incoming Calls:** Tick the incoming number for this phone.
- VAD Support:** VAD (Voice Activation Detection) prevents transmitting the silence packets to consume the bandwidth. It is also known as Silence Suppression, a software application that ensures bandwidth when voice activity is activated.
- Adjust the **Speaker Gain** slider to control the speaker sound.
- Adjust the **Mic Gain** slider to control the speaker sound of microphone.
- Click **Save** to make the settings effective.

## Done!

Now your telephony devices are bound to different incoming call numbers and outgoing call numbers.

 Tips:

Internal number showed on the table are used to make calls between telephony devices connected to the same modem router. It is preset and cannot be changed.

## 6.6. Call Log

### I want to:

Have a call list recording detailed information of incoming calls and outgoing calls on your modem router.

### How can I do that?

1. Visit <http://tplinkmodem.net>, and log in with your TP-Link ID or the password for the router.
2. Go to [Advanced](#) > [Telephony](#) > [Call Log](#).

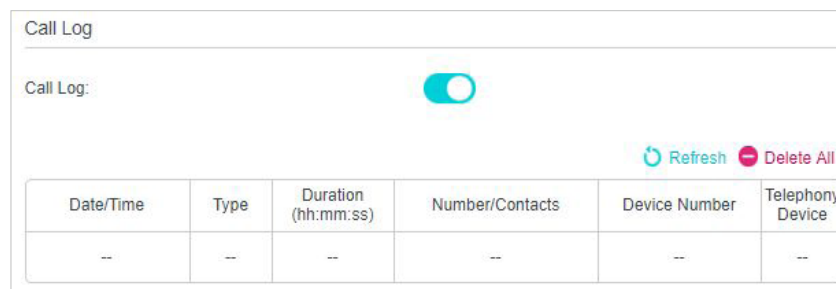

Date/Time	Type	Duration (hh:mm:ss)	Number/Contacts	Device Number	Telephony Device
--	--	--	--	--	--

3. Enable Call Log.

### Done!

From now on, all calls in and out are recorded here. If you've already had a telephone book, name of the contact would be shown on the call list.

 Tips:

You can enable [Push Notification via E-mail for Missed Calls](#) to have e-mail sent to you informing you of missed calls. You should first go to [Advanced](#) > [System Tools](#) > [Push Service](#) page to enable [Push Notification via E-mail](#), and click  to see the help page for detailed configuration about Push Service.

## 6.7. Calling via Which Number

### I want to:

Use different outgoing numbers to call different types of numbers.

[For example](#), one of my phone number has a relatively low charge in making long distance calls. I want all long distance calls to be dialed via this number.



## How can I do that?

1. Visit <http://tplinkmodem.net>, and log in with your TP-Link ID or the password you set for the router.
2. Go to [Advanced](#) > [Telephony](#) > [Call Rules](#). Click [Add](#) to set call rules.

3. Choose [Long Distance](#) in [Call Type or Prefix](#). Prefixes and call types can vary according to your own circumstances.
4. In [Number for Outgoing Calls](#), choose the number that has low charge in making long distance calls.
5. Click [Save](#) to make the settings effective.

### Done!

From now on, whenever you are dialing a long distance call, the call is made via the number you chose in step 5.

### In addition:

Call type can vary according to your circumstances. You can also set prefix by choosing [Calls with Specific Number Prefix](#) in [Call Type or Prefix](#). When a prefix is set, all numbers with this prefix is called via the assigned number.

## 6.8. Call Blocks

When you do not want calls to be received or dialed, use call block functions. This part consists of three functions: Do Not Disturb, Block Certain Calls and Prevent from Dialing.

### 6.8.1. Do Not Disturb

#### I want to:

Have no telephone ring at a certain period of time.

## How can I do that?

1. Visit <http://tplinkmodem.net>, and log in with your TP-Link ID or the password you set for the router.
2. Go to [Advanced](#) > [Telephony](#) > [DND & Call Blocking](#).

DND (Do Not Disturb)

DND:

Daily

Saturday and Sunday

Monday to Friday

From: 0 : 0

To: 6 : 0

Save

3. Enable [DND](#).
4. Set the time when DND is enabled.
5. Click [Save](#) to make the settings effective.

## Done!

Now, within this period of time, no telephone will ring, but all incoming calls would be recorded in call log. Enjoy your peaceful time and when you are back, check the call log to see what was missed.

### 6. 8. 2. Blocking Certain Calls

#### I want to:

Block certain calls, for example, the anonymous calls, or calls from the annoying salesmen.

#### How can I do that?

1. Visit <http://tplinkmodem.net>, and log in with your TP-Link ID or the password you set for the router.
2. Go to [Advanced](#) > [Telephony](#) > [DND & Call Blocking](#).

Call Blocking

Incoming Calls Outgoing Calls

+ Add - Delete All + Add - Delete All

Number	Modify
--	--

Call Type or Prefix	Modify
--	--

3. Click **Add** under **Incoming Calls**.
4. Choose to block a specific number or anonymous calls.

Call Blocking

Incoming Calls Outgoing Calls

+ Add - Delete All + Add - Delete All

Number	Modify
--	--

Call Type or Prefix	Modify
--	--

Select the incoming number to be blocked:

Specific Number ▼

Number:

Cancel
Save

5. Click **Save** to make the settings effective.

**Done!**

From now on, these calls are all automatically blocked by your modem router.

### 6.8.3. Prevent from Dialing

**I want to:**

Prevent my modem router from dialing a certain type of numbers.

*For example*, it costs a lot to call a mobile phone via my telephone number, so I don't want anyone to call a mobile phone using my number.

**How can I do that?**

1. Visit <http://tplinkmodem.net>, and log in with your TP-Link ID or the password you set for the router.
2. Go to **Advanced > Telephony > DND & Call Blocking**.

Call Blocking

Incoming Calls Outgoing Calls

+ Add - Delete All + Add - Delete All

Number	Modify
--	--

Call Type or Prefix	Modify
--	--

3. Click **Add** under **Outgoing Calls**.
4. Choose to prevent mobile phone from being dialed. Number type may vary according to your circumstances.

Call Blocking

Incoming Calls Outgoing Calls

+ Add - Delete All + Add - Delete All

Number	Modify
--	--

Call Type or Prefix	Modify
--	--

Call Type:

Mobilephone ▼

Cancel
Save

5. Click **Save** to make the settings effective.

## Done!

Now your modem router will prevent all mobile phone from being dialed.

## In addition:

Number type may vary according to your circumstances. You can also set prefix by choosing **Calls with Specific Number Prefix**. When a prefix is set, all numbers with this prefix is prevented from being called.

## 6.9. Forwarding Calls

### I want to:

Forward some incoming calls to a designated telephone number. **For example**, when no one answers the incoming call, it would be forwarded to my mobile phone so that I won't miss it.

### How can I do that?

1. Visit <http://tplinkmodem.net>, and log in with your TP-Link ID or the password you set for the router.

- Go to [Advanced](#) > [Telephony](#) > [Call Forwarding](#). Click [Add](#) to set how calls should be forwarded.

Call Forwarding + Add - Delete All

Calls	Forward via	Destination Number	Forward Type	Status	Modify
--	--	--	--	--	--

Select the incoming calls to be forwarded.

All Incoming Calls

Calls to the Telephone Number -Please Select- ▼

Calls to the Phone -Please Select- ▼

Calls from a Person in the Telephone Book -Please Select- ▼

Calls from the Telephone Number

Set Forwarding Rules:

Destination Telephone Number:

Forward the Calls via: Auto ▼

Call Forward Condition: Unconditional ▼

Cancel
Save

- [Select the incoming calls to be forwarded](#): Choose to forward which call or call type.
- [Destination Telephone Number](#): Set the destination where calls should be forwarded.
- [Forward the Calls via](#): Choose via which phone number the calls will be forwarded.
- [Call Forward Condition](#): Choose the forwarding type (Unconditional or No Answer) of the entry.
- Click [Save](#) to make the settings effective.

## Done!

Now your modem router will automatically forward the call according to your rule.

## 6. 10. Call Through

### I want to:

Call someone through my telephone number registered on my modem router.

*For example*, I am away from home, and want to call a friend who is aboard. I can call the friend using my mobile phone of course, but that would cost a huge sum. Meantime, my telephone number has a low charge in making international calls. So it would be great if

I can call the friend using my mobile phone and my telephone number.

## How can I do that?

1. Visit <http://tplinkmodem.net>, and log in with your TP-Link ID or the password for the router.
2. Go to **Advanced > Telephony > Call Through**. Enable **Call Through**.

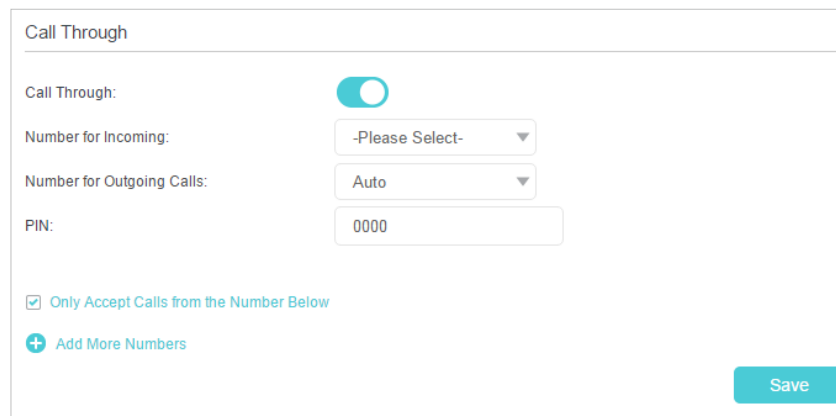

The screenshot shows the 'Call Through' configuration page. It features a toggle switch for 'Call Through' which is turned on. Below it are three fields: 'Number for Incoming' with a dropdown menu showing '-Please Select-', 'Number for Outgoing Calls' with a dropdown menu showing 'Auto', and 'PIN' with a text input field containing '0000'. There is a checkbox labeled 'Only Accept Calls from the Number Below' which is checked. At the bottom left, there is a '+ Add More Numbers' button, and at the bottom right, there is a 'Save' button.

3. **Number for Incoming:** Select the number you are going to use to call home via your mobile.
4. **Number for Outgoing Calls:** Select the number you are going to use to call your friend who is abroad.
5. If you tick **Only Accept Calls from the Number below**, you should add numbers that are allowed to use Call Through function on your modem router. In this example, add your mobile number.
6. Click **Save** to make the settings effective.

## Done!

Now you could follow the process below to call your friend using your mobile phone and telephone number:

1. Use your mobile to call the incoming number you selected in step 4.
2. Put in the PIN code when you hear the tone, remember to end the PIN with a "#". Change of the default PIN code is recommended.
3. Dial the number of your friend.
4. At this time, your friend will receive a call from the outgoing number you selected in step 5. You can talk to your friend from your mobile phone.

## 6.11. tpPhone

tpPhone is an app allowing you to make and receive calls through VoIP modem router. Follow the steps below to configure tpPhone settings:

1. Visit <http://tplinkmodem.net>, and log in with your TP-Link ID or the password for the router.
2. Go to **Advanced** > **Telephony** > **tpPhone** and you will see the following screen.

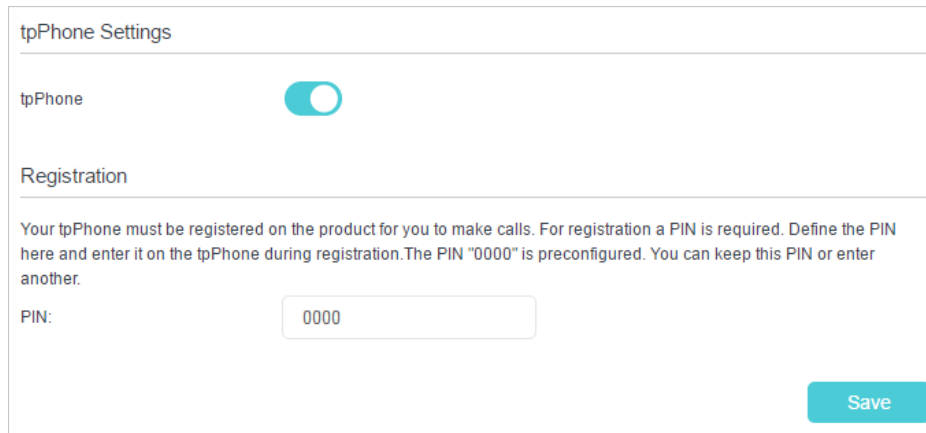

3. Make sure **tpPhone** is enabled.
4. Note down the default **PIN** code or set a new one. You need to use this PIN code when registering tpPhone on the modem router.
5. Click **Save** to make the settings effective.

You can go to the App Store or Google Play or scan the QR code below to download tpPhone and start to make phones over the internet.



## 6.12. Voice Mail

**I want to:**

Allow the caller who is not answered to leave a voice mail.

*For example*, I'm on my vocation, and cannot receive any call at the moment. If people who called can leave a voice mail, I would know what was going on when I was absent from home.

## How can I do that?

1. Visit <http://tplinkmodem.net>, and log in with the account you set for the router.
2. Go to [Advanced](#) > [Telephony](#) > [Voice Mail](#).

Voice Mail Settings

Voice Mail:

No Answer Time:  (5-60s)

Greeting for Voice Mail:  

**Note:** Pick up the phone (analog phone or DECT handset) and dial \*30 to record a personalized greeting for your voice mail.

Voice Mail Duration:  (20-120s)

Remote Access to Voice Mail:

Remote Access PIN:

**Note:** To access your voice mail remotely, dial the number for incoming calls. When your personal greeting starts, press \*. Enter your Remote Access PIN when prompted.

Push Notification via E-mail for Voice Mails:

The router can record voice messages with a total length of 1 hours 40 minutes. Pick up the phone and dial \*20 to listen to voice messages.

[Save](#)

Voice Mail List

[Refresh](#) [Delete All](#)



Stored in	Date/Time	Incoming Number	Telephone Number	Duration (hh:mm:ss)	Setting
--	--	--	--	--	--

3. Enable [Voice Mail](#).
4. Set the [No answer Time](#). A time period. If the call is not answered within this time period, the caller can leave a voice mail.
5. Choose greetings for your Voice Mail. You can record the greeting by dialing \*30 on the keyboard of your telephone.
6. Set how long a voice mail can last at [Voice Mail Duration](#).
7. If you want to access your voice mail remotely, enable [Remote Access Voice Mail](#) and create a new [Remote Access PIN](#) to make this function available. You need to enter this new PIN when listening to your voice mails remotely.
8. You can enable [Push Notification via E-mail for Voice Mails](#) to have e-mail sent to you informing you of voice mails. You should first go to [Advanced](#) > [System Tools](#) > [Push Service](#) page to enable [Push Notification via E-mail](#), and click  to see the help page for detailed configuration about Push Service.
9. Click [Save](#) to make the settings effective.

## Done!

When a voice mail is recorded, the modem router will display it in the following table.



Voice Mail List					
 Refresh  Delete All					
Stored in	Date/Time	Incoming Number	Telephone Number	Duration (hh:mm:ss)	Setting
--	--	--	--	--	--

There are five ways to listen to these voice mails.

- Click  on the table to listen.
- Press \*20 on the telephone keyboard to listen.
- Dial the number of your telephone, press \* when you hear the greeting and follow the voice prompt to enter the Remote Access PIN to listen.
- Launch the tpPhone app to listen.
- Use the Push Service feature to have the voice messages sent to you via email and listen.

## Chapter 7

---

# Guest Network

---

This function allows you to provide Wi-Fi access for guests without disclosing your main network. When you have guests in your house, apartment, or workplace, you can create a guest network for them. In addition, you can assign network authorities and bandwidth for guests to ensure network security, privacy, and fluency.

- [Create a Network for Guests](#)
- [Customize Guest Network Options](#)

## 7.1. Create a Network for Guests

1. Visit <http://tplinkmodem.net>, and log in with your TP-Link ID or the password you set for the router.
2. Go to [Advanced](#) > [Guest Network](#). Locate the [Wireless Settings](#) section.
3. Create 2.4GHz guest network.

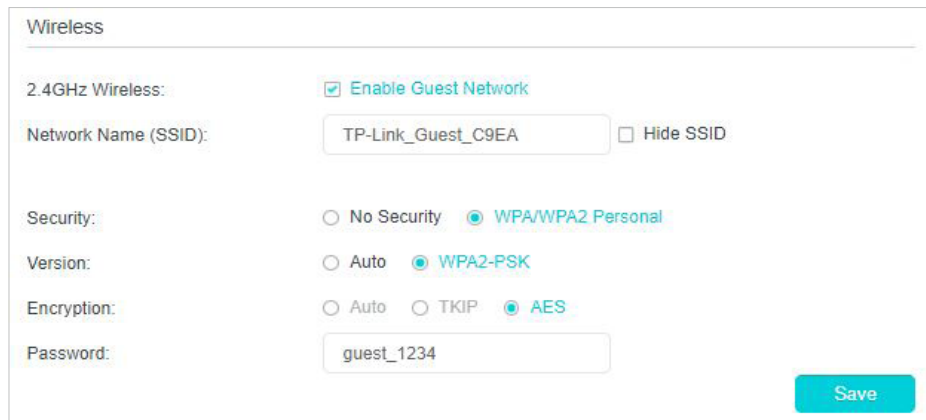

The screenshot shows the 'Wireless' settings page for a TP-Link router. The '2.4GHz Wireless' section is active. The 'Enable Guest Network' checkbox is checked. The 'Network Name (SSID)' is set to 'TP-Link\_Guest\_C9EA', and the 'Hide SSID' checkbox is unchecked. Under 'Security', 'WPA/WPA2 Personal' is selected. Under 'Version', 'WPA2-PSK' is selected. Under 'Encryption', 'AES' is selected. The 'Password' field contains 'guest\_1234'. A 'Save' button is located at the bottom right of the form.

- 1) Tick [Enable Guest Network](#).
- 2) Set an easy-to-identify SSID. Don't select [Hide SSID](#) unless you want your guests and other people to manually input this SSID for Wi-Fi access.
- 3) Set [Security](#) to [WPA/WPA2 Personal](#), keep the default [Version](#) and [Encryption](#) values, and set an easy-to-remember password.
4. Click [Save](#). Now your guests can access your guest network using the SSID and password you set!

### Tips:

To view guest network information, go to [Advanced](#) > [Status](#) and find the [Guest Network](#) section.

## 7.2. Customize Guest Network Options

1. Visit <http://tplinkmodem.net>, and log in with your TP-Link ID or the password you set for the router.
2. Go to [Advanced](#) > [Guest Network](#).

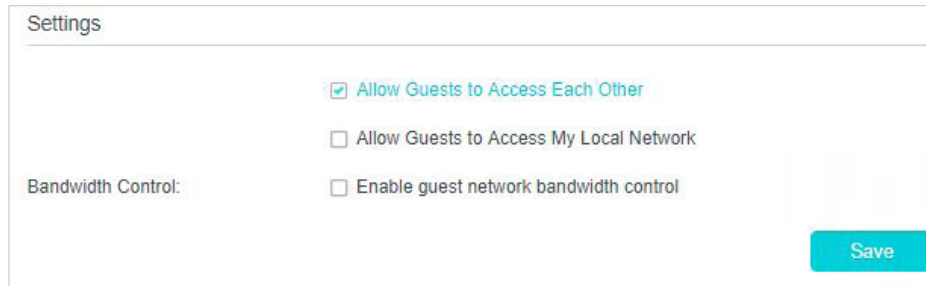

Settings

- Allow Guests to Access Each Other
- Allow Guests to Access My Local Network

Bandwidth Control:

- Enable guest network bandwidth control

Save

3. Assign network authorities and bandwidth according to your needs.

- [Allow Guests to Access Each Other](#)

Select this check box to allow the clients in your guest network to access each other's files.

- [Allow Guests to Access My Local Network](#)

Select this check box to allow the clients in your guest network to access your local network, not just the internet.

- [Enable Guest Network for Bandwidth Control](#)

Select this check box to set the upstream and downstream bandwidth range of the guest network. This option is available only when bandwidth control is enabled on the [Advanced > Bandwidth Control](#) page.



Bandwidth Control:

- Enable guest network bandwidth control

Upstream (kbps): 100 - 200

Downstream (kbps): 100 - 200

Save

4. Click [Save](#). Now users in your guest network can enjoy only the network authorities at the priority you assigned!

 Tips:

To view guest network information, go to [Advanced > Status](#) and find the [Guest Network](#) section.

## Chapter 8

---

# Parental Controls

---

This function allows you to block inappropriate, explicit and malicious websites and limit internet access during specified time periods.

## I want to:

Control what types of websites my children or other home network users can visit and the time of day they are allowed to access the internet.

For example, I want to allow my children's devices (for example, a computer or a tablet) to access only [www.tp-link.com](http://www.tp-link.com) and [wikipedia.org](http://wikipedia.org) from 18:00 (6PM) to 22:00 (10PM) on weekdays and not other time.

## How can I do that?

1. Visit <http://tplinkmodem.net>, and log in with your TP-Link ID or the password you set for the router.
2. Go to [Basic](#) or [Advanced](#) > [Parental Controls](#) and enable [Parental Controls](#).

Parental Controls

---

Parental Controls:

Devices Under Parental Controls

The Effective Time is based on the time of the router. The time can be set in "Advanced > System Tools > Time Settings".

[Refresh](#)
[+](#) Add
 [-](#) Delete

<input type="checkbox"/>	ID	Device Name	MAC Address	Effective Time	Description	Status	Modify
--	--	--	--	--	--	--	--

Content Restriction

---

Content Restriction:

Restriction Policy:
  Blacklist
  Whitelist

[+](#) Add a New Keyword

[Save](#)

3. Click [Add](#).

Devices Under Parental Controls

The Effective Time is based on the time of the router. The time can be set in "Advanced > System Tools > Time Settings".

Refresh + Add - Delete

<input type="checkbox"/>	ID	Device Name	MAC Address	Effective Time	Description	Status	Modify
--	--	--	--	--	--	--	--

Device Name:  Scan

MAC Address:

Effective Time:

Description:

Enable This Entry

Cancel Save

- Click **Scan**, and add **+** the device to be controlled. Or, enter the **Device Name** and **MAC Address** manually.
- Click the **🕒** icon to set the Effective Time. Drag the cursor over the appropriate cell(s) and click **OK**.

System Time: 01/01/2016 00:03:41

	Sun	Mon	Tue	Wed	Thu	Fri	Sat
0:00							
1:00							
2:00							
3:00							
4:00							
5:00							
6:00							
7:00							
8:00							
9:00							
10:00							
11:00							
12:00							
13:00							
14:00							
15:00							
16:00							
17:00							
18:00							
19:00							
20:00							
21:00							
22:00							
23:00							
24:00							

Effective Time

Reset OK

- Enter a **Description** for the entry.
- Select the check box to enable this entry and click **Save**.
- Enable **Content Restriction** and select the restriction mode.
  - In **Blacklist** mode, the controlled devices cannot access any websites containing the specified keywords during the Effective Time period.

- 2) In **Whitelist** mode, the controlled devices can only access websites containing the specified keywords during the Effective Time period.

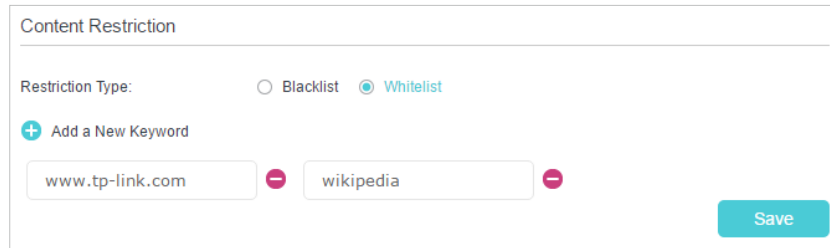

Content Restriction

Restriction Type:  Blacklist  Whitelist

+ Add a New Keyword

www.tp-link.com - wikipedia -

Save

9. Click **Add a New Keyword**. You can add many keywords for both Blacklist and Whitelist. Below are some sample entries to allow access.
  - 1) Enter a web address (for example, `www.tp-link.com`) or a web address keyword (for example, `wikipedia`) to only allow or block access to the websites containing that keyword.
  - 2) Specify the domain suffix (for example, `.edu` or `.org`) to allow access only to the websites with that suffix.
10. Enter the keywords or websites you want to add and click **Save**.

## Done!

Now you can control your children's internet access according to your needs.



## Chapter 9

---

# Bandwidth Control

---

This chapter explains how to create a QoS (Quality of Service) rule to prioritize your online activities, which minimizes the impact caused by heavy internet traffic.

It contains the following sections:

- [Set Bandwidth Control of the Network](#)
- [Create a Bandwidth Control Rule for an IP Range](#)

## 9.1. Set Bandwidth Control of the Network

Bandwidth control allows you to configure the upstream and downstream bandwidth of the network, and the combined throughput should not exceed 1,000,000 Kbps. For optimal bandwidth control, please select the correct Line Type and consult your ISP for the total allowed bandwidth for upstream and downstream.

1. Visit <http://tplinkmodem.net>, and log in with your TP-Link ID or the password you set for the router.
2. Go to [Advanced > Bandwidth Control](#).
3. Enable [Bandwidth Control](#).

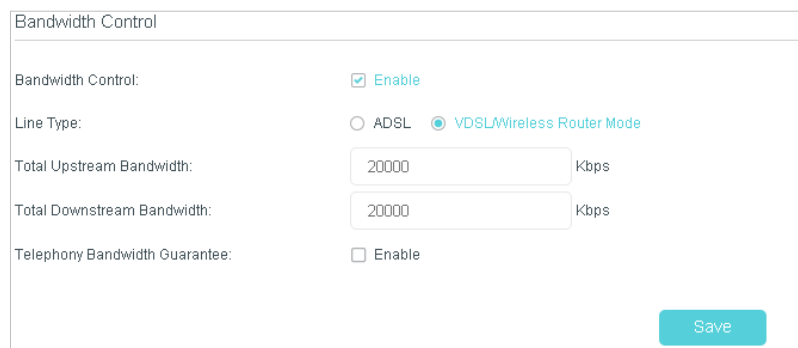

The screenshot shows the 'Bandwidth Control' configuration page. It includes the following fields and options:

- Bandwidth Control:**  Enable
- Line Type:**  ADSL  VDSL/Wireless Router Mode
- Total Upstream Bandwidth:**  Kbps
- Total Downstream Bandwidth:**  Kbps
- Telephony Bandwidth Guarantee:**  Enable

A 'Save' button is located at the bottom right of the form.

4. Choose your [Line Type](#).
5. Input the total upload and download speed through the WAN port in the [Total Upstream Bandwidth](#) and [Total Downstream Bandwidth](#) fields.
6. (Optional) Enable [Telephony Bandwidth Guarantee](#) to ensure sufficient bandwidth for Telephony service.
7. Click [Save](#).

## 9.2. Create a Bandwidth Control Rule for an IP Range

You can add a controlling rule to limit the bandwidth available for IP ranges.

1. Visit <http://tplinkmodem.net>, and log in with your TP-Link ID or the password you set for the router.
2. Go to [Advanced > Bandwidth Control](#).
3. Click [Add](#) in the [Controlling Rules](#) area.

Controlling Rules

+ Add - Delete

□	IP Range/Port Range	Priority	Up (min/max)	Down (min/max)	Status	Modify
--	--	--	--	--	--	--

IP Range:  -

Port Range:  -  (1-65535)

Protocol: ALL ▼

Priority: 5 ▼ (1 means the highest priority.)

Upstream:  to  Kbps

Downstream:  to  Kbps

Enable This Entry

Cancel
Save

4. Enter a range of IP addresses to be controlled in the **IP Range** fields.
5. Enter a range of port numbers to be controlled in the **Port Range** fields.
6. Select a protocol type for this rule.
7. Enter the minimum and maximum upload (in Kbps) through the WAN port in the **Upstream** fields.
8. Enter the minimum and maximum download (in Kbps) through the WAN port in the **Downstream** fields.
9. Select **Enable This Entry** and click **Save**.

**Note:**

If you want to disable this entry, click in the **Status** column.

## Chapter 10

---

# Network Security

---

This chapter guides you on how to protect your home network from unauthorized users by implementing these five network security functions. You can use Firewall and DoS Protection to protect your home network from cyber attacks, use Service Filtering to prevent certain users from accessing the specified service and even block internet access completely, or use Access Control to block or allow specific client devices to access your wired and wireless networks. You can also prevent ARP spoofing and ARP attacks by using IP & MAC Binding and protect your IPv6 network through IPv6 Firewall.

- [Firewall & DoS Protection](#)
- [Service Filtering](#)
- [Access Control](#)
- [IP & MAC Binding](#)
- [IPv6 Firewall](#)

## 10.1. Firewall & DoS Protection

The SPI (Stateful Packet Inspection) Firewall and DoS (Denial of Service) Protection protect the router from cyber attacks.

The SPI Firewall can prevent cyber attacks and validate the traffic that is passing through the router based on the protocol. This function is enabled by default, and it's recommended to keep the default settings.

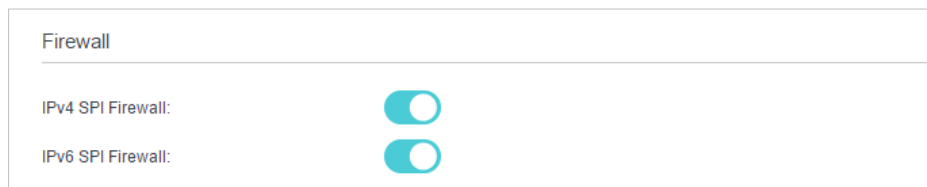

DoS Protection can protect your home network against DoS attacks from flooding your network with server requests. Follow the steps below to configure DoS Protection.

1. Visit <http://tplinkmodem.net>, and log in with your TP-Link ID or the password you set for the router.
2. Go to **Advanced > Security > Firewall & DoS Protection**.

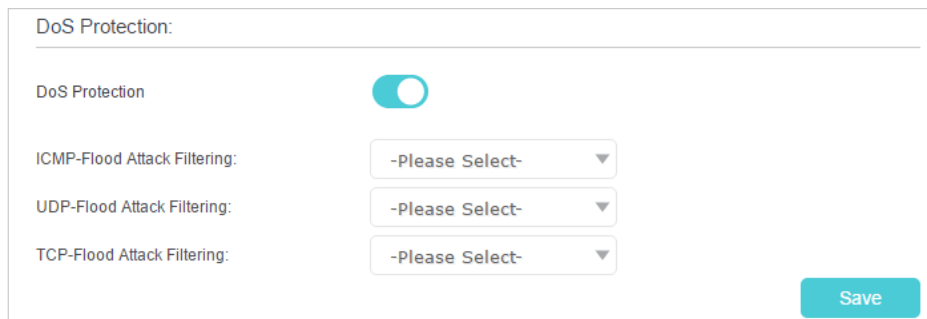

3. Enable **DoS Protection**.
4. Set the level (**Low**, **Middle** or **High**) of protection for **ICMP-Flood Attack Filtering**, **UDP-Flood Attack Filtering** and **TCP-Flood Attack Filtering**.
  - **ICMP-Flood Attack Filtering** - Enable to prevent the ICMP (Internet Control Message Protocol) flood attack.
  - **UDP-Flood Attack Filtering** - Enable to prevent the UDP (User Datagram Protocol) flood attack.
  - **TCP-Flood Attack Filtering** - Enable to prevent the TCP (Transmission Control Protocol) flood attack.
5. Click **Save**.

 **Tips:**

1. The level of protection is based on the number of traffic packets. Specify the level at **DoS Protection Level Settings**.

### Dos Protection Level Settings

---

ICMP-Flood Protection Level:	Low:	1200	(5-3600) packets/sec
	Middle:	2400	(5-3600) packets/sec
	High:	3600	(5-3600) packets/sec
UDP-Flood Protection Level:	Low:	1200	(5-3600) packets/sec
	Middle:	2400	(5-3600) packets/sec
	High:	3600	(5-3600) packets/sec
TCP-SYN-Flood Protection Level:	Low:	1200	(5-3600) packets/sec
	Middle:	2400	(5-3600) packets/sec
	High:	3600	(5-3600) packets/sec

Save

2. The protection will be triggered immediately when the number of packets exceeds the preset threshold value, and the vicious host will be displayed in the [Blocked DoS Host List](#).

### Blocked DoS Host List

---

Host Number: 0 [Refresh](#) [Delete](#)

<input type="checkbox"/>	ID	IP Address	MAC Address
--	--	--	--

## 10.2. Service Filtering

With Service Filtering, you can prevent certain users from accessing the specified service, and even block internet access completely.

1. Visit <http://tplinkmodem.net>, and log in with your TP-Link ID or the password you set for the router.
2. Go to [Advanced](#) > [Security](#) > [Service Filtering](#).
3. Toggle on [Service Filtering](#).
4. Click [Add](#).

Filtering List

Refresh + Add - Delete

<input type="checkbox"/>	ID	Service Type	Port	IP Address	Status	Modify
--	--	--	--	--	--	--

Service Type: Any(ALL) ▼

Protocol: TCP/UDP ▼

Starting Port: 1 (1-65535)

Ending Port: 65535 (1-65535)

Service Type: Any(ALL)

Filter Service For:  Single IP Address  IP Address Range  All IP Addresses

Cancel Save

5. Select a **Service Type** from the drop-down list and the following four fields will be auto-populated. Select **Custom** when your desired service type is not listed, and enter the information manually.
6. Specify the IP address(es) that this filtering rule will apply to.
7. Click **Save**.

Note: If you want to disable this entry, click the  icon.

### 10.3. Access Control

Access Control is used to block or allow specific client devices to access your network (via wired or wireless) based on a list of blocked devices (Blacklist) or a list of allowed devices (Whitelist).

#### I want to:

Block or allow specific client devices to access my network (via wired or wireless).

#### How can I do that?

1. Visit <http://tplinkmodem.net>, and log in with your TP-Link ID or the password you set for the router.
2. Go to **Advanced > Security > Access Control** and enable **Access Control**.

Access Control

Access Control:

Access Mode

Default Access Mode:  Blacklist  Whitelist

Save

Devices in Blacklist

+ Add - Delete

<input type="checkbox"/>	ID	Device Name	MAC Address	Modify
--	--	--	--	--

Devices Online

Refresh Block

<input type="checkbox"/>	ID	Device Name	IP Address	MAC Address	Connection Type
<input type="checkbox"/>	1	Unknown	192.168.1.200	50:E5:49:1E:06:80	Wired
<input type="checkbox"/>	2	Unknown	192.168.1.70	A4:2B:B0:C2:6C:5A	Wired

3. Select the access mode to either block (recommended) or allow the device(s) in the list.

#### To block specific device(s)

- 1) Select **Blacklist** and click **Save**.
- 2) Select the device(s) to be blocked in the **Devices Online** table.
- 3) Click **Block** above the **Devices Online** table. The selected devices will be added to **Devices in Blacklist** automatically.

#### To allow specific device(s)

- 1) Select **Whitelist** and click **Save**.
- 2) Click **Add**.

Devices in Whitelist

+ Add - Delete

<input type="checkbox"/>	ID	Device Name	MAC Address	Modify
--	--	--	--	--

Device Name:  Scan

MAC Address:

Cancel Save

--	1	Unknown#94DE805FB30E_wl	94-DE-80-5F-B3-0E	<input checked="" type="checkbox"/> <input type="checkbox"/>
----	---	-------------------------	-------------------	--



- 3) Click [Scan](#) and select the device from the connected device list. The [Device Name](#) and [MAC Address](#) will be automatically filled in. Or you can enter the [Device Name](#) and [MAC Address](#) manually.
- 4) Click [Save](#).

## Done!

Now you can block or allow specific client devices to access your network (via wired or wireless) using the [Blacklist](#) or [Whitelist](#).

## 10.4. IP & MAC Binding

IP & MAC Binding, namely, ARP (Address Resolution Protocol) Binding, is used to bind a network device's IP address to its MAC address. This will prevent ARP spoofing and other ARP attacks by denying network access to a device with a matching IP address in the Binding list, but an unrecognized MAC address.

### I want to:

Prevent ARP spoofing and ARP attacks.

### How can I do that?

1. Visit <http://tplinkmodem.net>, and log in with your TP-Link ID or the password you set for the router.
2. Go to [Advanced](#) > [Security](#) > [IP & MAC Binding](#) and enable [IP & MAC Binding](#).

Settings

---

IP & MAC Binding:

Binding List

[+](#) Add [-](#) Delete

<input type="checkbox"/>	ID	MAC Address	IP Address	Status	Enable	Modify
<input type="checkbox"/>	--	--	--	--	--	--

ARP List

[↻](#) Refresh [🔗](#) Bind

<input type="checkbox"/>	ID	Device Name	MAC Address	IP Address	Bound	Modify
<input type="checkbox"/>	1	BRCM-CM	E8:94:F6:DE:AD:07	192.168.1.86	Unloaded	
<input type="checkbox"/>	2	Unknown	50:E5:49:1E:06:80	192.168.1.200	Unloaded	
<input type="checkbox"/>	3	Unknown	A4:2B:B0:C2:6C:5A	192.168.1.70	Unloaded	

### 3. Bind your device(s) according to your needs.

#### To bind the connected device(s)

- 1) Select the device(s) to be bound in the [ARP List](#).
- 2) Click [Bind](#) to add to the [Binding List](#).

#### To bind the unconnected device

- 1) Click [Add](#) in the [Binding List](#) section.

The screenshot shows a web interface titled "Binding List". At the top right, there are buttons for "+ Add" and "- Delete". Below this is a table with the following columns: ID, MAC Address, IP Address, Status, Enable, and Modify. The table currently contains one row with dashes in all cells. Below the table is a form to add a new entry. It has two input fields: "MAC Address" with the value "E8:94:F6:DE:AD:07" and "IP Address" with the value "1921.168.1.100". There is also a checked checkbox labeled "Enable". At the bottom right of the form are two buttons: "Cancel" and "OK".

- 2) Enter the [MAC Address](#) and [IP Address](#) that you want to bind.
- 3) Select the check box to enable the entry and click [OK](#).

## Done!

Enjoy the internet without worrying about ARP spoofing and ARP attacks.

## 10.5. IPv6 Firewall

IPv6 Firewall protects your IPv6 network by preventing access from the internet. However, when you're hosting a service, such as a file sharing server in your local network, you can choose to allow access to the server from the internet by adding an IPv6 entry. This feature is available only when you've set up an IPv6 connection.

1. Visit <http://tplinkmodem.net>, and log in with your TP-Link ID or the password you set for the router.
2. Go to [Advanced](#) > [Security](#) > [IPv6 Firewall](#).
3. Click [Add](#).
4. Select an interface name from the drop-down list. Interface names are names of the internet connections you have set up.
5. Click [Scan](#) to select a service from the list to automatically populate the [Port](#) field with an appropriate port number. It is recommended to keep the default Port if you are unsure about which one to use. If the service is not listed, manually enter the [Service Type](#) and the [Port](#) number (e.g. 21 or 21-25).

6. Click [Scan](#) to select the local host device running the service. If the device is not listed, enter its global IPv6 address in the [Internal IP](#) field.
7. Select a protocol for the service from the drop-down list.
8. Select [Enable This Entry](#).
9. Click [Save](#).

**Note:**

1. If you want to diable this entry, click the  icon in the [Status](#) column.
2. If the local host device hosts more than one type of available service, you need to create a rule for each service. Please note that ports should NOT be used by multiple services.

## Chapter 11

---

# NAT Forwarding

---

Modem router's NAT (Network Address Translation) feature makes the devices in the LAN use the same public IP address to communicate in the internet, which protects the local network by hiding IP addresses of the devices. However, it also brings about the problem that external host cannot initiatively communicate with the specified device in the local network.

The modem router can use a forwarding feature to remove the isolation of NAT and allow external internet hosts to intuitively communicate with the devices in the local network, thus enabling some special features.

TP-Link modem router includes four forwarding rules. If two or more rules are set, the priority of implementation from high to low is Virtual Servers, Port Triggering, UPnP and DMZ.

This chapter contains the following sections:

- [Translate Address and Port by ALG](#)
- [Share Local Resources over the Internet by Virtual Server](#)
- [Open Ports Dynamically by Port Triggering](#)
- [Make Applications Free from Port Restriction by DMZ](#)
- [Make Xbox Online Games Run Smoothly by UPnP](#)

## 11. 1. Translate Address and Port by ALG

ALG (Application Layer Gateway) allows customized NAT (Network Address Translation) traversal filters to be plugged into the gateway to support address and port translation for certain application layer “control/data” protocols: FTP, TFTP, H323 etc. Enabling ALG is recommended.

1. Visit <http://tplinkmodem.net>, and log in with your TP-Link ID or the password you set for the router.
2. Go to [Advanced](#) > [NAT Forwarding](#) > [ALG](#).

ALG	
PPTP Pass-through:	<input checked="" type="checkbox"/> Enable
L2TP Pass-through:	<input checked="" type="checkbox"/> Enable
IPSec Pass-through:	<input checked="" type="checkbox"/> Enable
FTP ALG:	<input checked="" type="checkbox"/> Enable
TFTP ALG:	<input checked="" type="checkbox"/> Enable
H323 ALG:	<input checked="" type="checkbox"/> Enable
SIP ALG:	<input checked="" type="checkbox"/> Enable
RTSP ALG:	<input type="checkbox"/> Enable

Save

- **PPTP Pass-through:** If enabled, it allows Point-to-Point sessions to be tunneled through an IP network and passed through the router.
- **L2TP Pass-through:** If enabled, it allows Layer 2 Point-to-Point sessions to be tunneled through an IP network and passed through the router.
- **IPSec Pass-through:** If enabled, it allows IPSec (Internet Protocol Security) to be tunneled through an IP network and passed through the router. IPSec uses cryptographic security services to ensure private and secure communications over IP networks.
- **FTP ALG:** If enabled, it allows FTP (File Transfer Protocol) clients and servers to transfer data via NAT.
- **TFTP ALG:** If enabled, it allows TFTP (Trivial File Transfer Protocol) clients and servers to transfer data via NAT.
- **H323 ALG:** If enabled, it allows Microsoft NetMeeting clients to communicate via NAT.
- **SIP ALG:** If enabled, it allows clients communicate with SIP (Session Initiation Protocol) servers via NAT.

- **RTSP ALG:** If enabled, it allows RTSP (Real-Time Stream Protocol) clients and servers to transfer data via NAT.

## 11.2. Share Local Resources over the Internet by Virtual Server

When you build up a server in the local network and want to share it on the internet, Virtual Server can realize the service and provide it to the internet users. At the same time virtual server can keep the local network safe as other services are still invisible from the internet.

Virtual server can be used for setting up public services in your local network, such as HTTP, FTP, DNS, POP3/SMTP and Telnet. Different service uses different service port. Port 80 is used in HTTP service, port 21 in FTP service, port 25 in SMTP service and port 110 in POP3 service. Please verify the service port number before the configuration.

### I want to:

Share my personal website I've built in a local network with my friends through the internet.

**For example,** the personal website has been built on my home PC (192.168.1.100). I hope that my friends can visit my website. The PC is connected to the modem router with the WAN IP address 218.18.232.154.

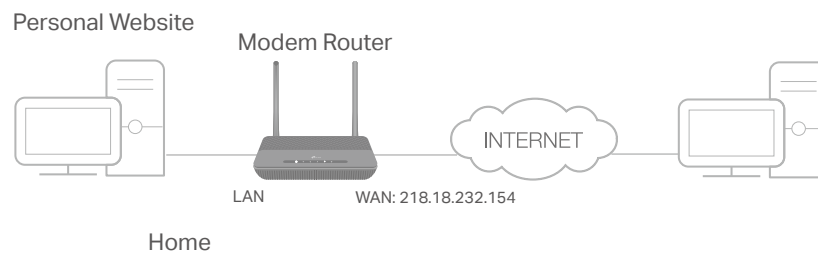

### How can I do that?

1. Assign a static IP address to your PC, for example 192.168.1.100.
2. Visit <http://tplinkmodem.net>, and log in with your TP-Link ID or the password you set for the router.
3. Go to **Advanced > NAT Forwarding > Virtual Servers**, click **Add**.

Virtual Servers

+ Add - Delete

☐	ID	Service Type	External Port	Internal IP	Internal Port	Protocol	Status	Modify
--	--	--	--	--	--	--	--	--

Note: Virtual Server can be configured only when there is an available interface. If the external port is already used for Remote Management or CWMP, Virtual Server will not take effect.

Interface Name:

Service Type:  Scan

External Port:  (XX-XX or XX)

Internal IP:

Internal Port:  (XX or Blank, 1-65535)

Protocol:

Enable This Entry

Cancel
Save

4. Click **Scan**, and choose **HTTP**. The external port, internal port and protocol will be automatically filled with contents. Enter the PC's IP address 192.168.1.100 in the **Internal IP** field.

5. Click **Save**.

**Tips:**

1. It is recommended to keep the default settings of **Internal Port** and **Protocol** if you are not clear about which port and protocol to use.
2. If the service you want to use is not in the **Service Type**, you can enter the corresponding parameters manually. You should verify the port number that the service needs.
3. You can add multiple virtual server rules if you want to provide several services from a modem router. Please note that the **External Port** cannot be overlapped.

## Done!

Internet users can enter **http://WAN IP** (in this example: **http://218.18.232.154**) to visit your personal website.

**Tips:**

1. For a WAN IP that is assigned dynamically by ISP, it is recommended to apply and register a domain name for the WAN by DDNS, go to [Set Up a Dynamic DNS Service Account](#) for more information. Then you can use **http://domain name** to visit the website.
2. If you have changed the default **External Port**, you should use **http://WAN IP: External Port** or **http://domain name: External Port** to visit the website.

## 11.3. Open Ports Dynamically by Port Triggering

Port triggering can specify a triggering port and its corresponding external ports. When a host in the local network initiates a connection to the triggering port, all the external ports will be opened for subsequent connections. The modem router can record the IP address of the host. When the data from the internet returns to the external ports, the

modem router can forward them to the corresponding host. Port triggering is mainly applied to online games, VoIPs and video players. Common applications include MSN Gaming Zone, Dialpad, Quick Time 4 players, and so on.

Follow the steps below to configure the port triggering rules:

1. Visit <http://tplinkmodem.net>, and log in with your TP-Link ID or the password you set for the router.
2. Go to [Advanced](#) > [NAT Forwarding](#) > [Port Triggering](#) and click [Add](#).

Port Triggering

ID	Application	Triggering Port	Triggering Protocol	External Port	External Protocol	Status	Modify
--	--	--	--	--	--	--	--

Interface Name: pppoe\_ptm\_0\_0\_d

Application: MSN Gaming Zone Scan

Triggering Port: 47624 (XX, 1-65535)

Triggering Protocol: TCP

External Port: 2300-2400,28800-29000 (XX or XX-XX, 1-65535, at most 5 pairs)

External Protocol: TCP

Enable This Entry

Cancel Save

3. Click [Scan](#), and select the desired application. The triggering port and protocol, the external port and protocol will be automatically filled with contents. Here we take [MSN Gaming Zone](#) as an example.
4. Click [Save](#).

#### Tips:

1. You can add multiple port triggering rules according to your network need.
2. If the application you need is not listed in the [Existing Applications](#) list, please enter the parameters manually. You should verify the external ports the application uses first and enter them into [External Port](#) field according to the format the page displays.

## 11.4. Make Applications Free from Port Restriction by DMZ

When a PC is set to be a DMZ (Demilitarized Zone) host in the local network, it is totally exposed to the internet, which can realize the unlimited bidirectional communication between internal hosts and external hosts. The DMZ host becomes a virtual server with



all ports opened. When you are not clear about which ports to open in some special applications, like IP camera and database software, you can set the PC to be a DMZ host.

**Note:**

DMZ is most applicable when you don't know which ports to open. When it is enabled, the DMZ host is totally exposed to the internet, which may bring some potential safety hazard. If DMZ is not in use, please disable it in time.

### I want to:

Make the home PC join the internet online game without port restriction.

**For example**, due to some port restriction, when playing the online games, you can login normally but cannot join a team with other players. To solve this problem, set your PC as a DMZ with all ports opened.

### How can I do that?

1. Assign a static IP address to your PC, for example 192.168.1.100.
2. Visit <http://tplinkmodem.net>, and log in with your TP-Link ID or the password you set for the router.
3. Go to **Advanced > NAT Forwarding > DMZ** and select the check box to enable DMZ.



DMZ

DMZ:  Enable DMZ

DMZ Host IP Address:

Save

4. Enter the IP address 192.168.1.100 in the **DMZ Host IP Address** field.
5. Click **Save**.

### Done!

The configuration is completed. You've set your PC to a DMZ host and now you can make a team to game with other players.

## 11.5. Make Xbox Online Games Run Smoothly by UPnP

UPnP (Universal Plug and Play) protocol allows the applications or host devices to automatically find the front-end NAT device and send request to it to open the corresponding ports. With UPnP enabled, the applications or host devices in the both sides of NAT device can freely communicate with each other realizing the seamless connection of the network. You may need to enable the UPnP if you want

to use applications such as multiplayer gaming, peer-to-peer connections, real-time communication (for example, VoIP or telephone conference), or remote assistance.

 **Tips:**

1. UPnP is enabled by default in this modem router.
2. Only the application supporting UPnP protocol can use this feature.
3. UPnP feature needs the support of operating system (e.g. Windows Vista/ Windows 7/ Windows 8, etc. Some of operating system need to install the UPnP components).

For example, when you connect your Xbox to the modem router which has connected to the internet to play online games, UPnP will send request to the modem router to open the corresponding ports allowing the following data penetrating the NAT to transmit. Therefore, you can play Xbox online games without a hitch.

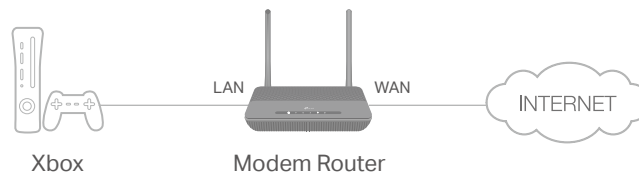

If necessary, you can follow the steps to change the status of UPnP.

1. Visit <http://tplinkmodem.net>, and log in with your TP-Link ID or the password you set for the modem router;
2. Go to **Advanced > NAT Forwarding > UPnP** and toggle on or off according to your needs.

UPnP

---

UPnP:

UPnP Service List

Total Clients: 0  Refresh

ID	Service Description	External Port	Protocol	Internal IP Address	Internal Port
--	--	--	--	--	--

## Chapter 12

---

# VPN Server

---

The VPN (Virtual Private Networking) Server allows you to access your home network in a secured way through the internet when you are out of the house. The router offers three ways to setup VPN connection: OpenVPN, PPTP (Point to Point Tunneling Protocol) VPN and IPSec (Internet Protocol Security) VPN.

OpenVPN is somewhat complex but with greater security and more stability. It is suitable for restricted environment, such as campus network and company intranet.

PPTP VPN is easier to use and its speed is faster. It's compatible with most operating systems and also supports mobile devices. However, its security is poor and packets may be cracked easily. PPTP VPN may be blocked by some ISPs.

IPSec (IP Security) is a set of services and protocols defined by IETF (Internet Engineering Task Force) to provide high security for IP packets and prevent attacks.

This chapter contains the following sections, please choose the appropriate VPN server connection type according to your needs.

- [Use OpenVPN to Access Your Home Network](#)
- [Use PPTP VPN to Access Your Home Network](#)
- [Use IPSec VPN to Access Your Home Network](#)

## 12.1. Use OpenVPN to Access Your Home Network

In an OpenVPN connection, the home network can act as a server, and the remote device can access the server through the router which acts as an OpenVPN Server gateway. To use the VPN feature, you should enable OpenVPN Server on your router, install and run VPN client software on the remote device. Please follow the steps below to set up an OpenVPN connection.

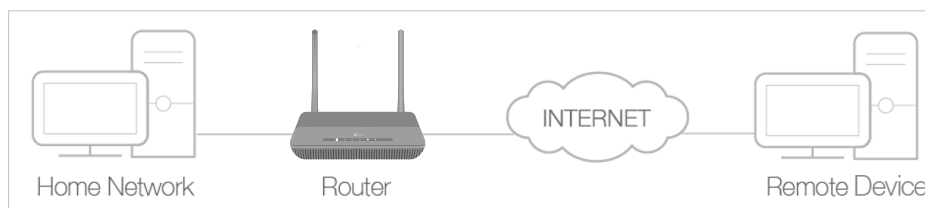

### Step 1. Set up OpenVPN Server on Your Router

1. Visit <http://tplinkmodem.net>, and log in with your TP-Link ID or the password you set for the router.
2. Go to **Advanced > VPN > OpenVPN**, and select **Enable VPN Server**.

#### OpenVPN

**Note:** No certificate currently, please **Generate** one before enabling VPN Server.

**Enable VPN Server**

Service Type:  **UDP**  TCP

Service Port:

VPN Subnet/Netmask:

Client Access:  **Home Network Only**  Internet and Home Network

**Note:**

- Before you enable VPN Server, we recommend you configure Dynamic DNS Service (recommended) or assign a static IP address for your router's WAN port and synchronize your System Time via the internet.
- The first time you configure the OpenVPN Server, you may need to **Generate** a certificate before you enable the VPN Server.

3. Select the **Service Type** (communication protocol) for OpenVPN Server: UDP, TCP.
4. Enter a VPN **Service Port** to which a VPN device connects. The port number should be between 1024 and 65535.
5. In the **VPN Subnet/Netmask** fields, enter the range of IP addresses that can be leased to the device by the OpenVPN server.

6. Select your **Client Access** type. Select **Home Network Only** if you only want the remote device to access your home network; select **Internet and Home Network** if you also want the remote device to access the internet through the VPN Server.
7. Click **Save**.
8. Click **Generate** to get a new certificate.

Certificate

---

Generate the certificate.

**Generate**

**Note:**

If you have already generated one, please skip this step, or click **Generate** to update the certificate.

9. Click **Export** to save the OpenVPN configuration file which will be used by the remote device to access your router.

Configuration File

---

Export the configuration.

**Export**

## Step 2. Configure OpenVPN Connection on Your Remote Device

1. Visit <http://openvpn.net/index.php/download/community-downloads.html> to download the OpenVPN software, and install it on your device where you want to run the OpenVPN client utility.

**Note:**

You need to install the **OpenVPN** client utility on each device that you want to be able to use the VPN function. Mobile devices should download a third-party app from Google Play or Apple App Store.

2. After the installation, copy the file exported from your router to the OpenVPN client utility's "config" folder (for example, **C:\Program Files\OpenVPN\config** on Windows). The path depends on where the OpenVPN client utility is installed.
3. Run the OpenVPN client utility and connect it to OpenVPN Server.

## 12.2. Use PPTP VPN to Access Your Home Network

PPTP VPN Server is used to create a VPN connection for remote devices. To use the VPN feature, you should enable PPTP VPN Server on your router, and configure the PPTP connection on the remote device. Please follow the steps below to set up a PPTP VPN connection.

### Step 1. Set up PPTP VPN Server on Your Router

1. Visit <http://tplinkmodem.net>, and log in with your TP-Link ID or the password you set for the router.
2. Go to **Advanced > VPN > PPTP VPN**, and select **Enable VPN Server**.

**PPTP VPN**

**Enable VPN Server**

Client IP Address:  -10.7.0.  (up to 10 clients)

Username:

Password:

**Note:**

Before you enable [VPN Server](#), we recommend you configure Dynamic DNS Service (recommended) or assign a static IP address for router's WAN port and synchronize your [System Time](#) with internet.

3. In the [Client IP Address](#) field, enter the range of IP addresses (up to 10) that can be leased to the devices by the PPTP VPN server.
4. Enter the [Username](#) and [Password](#) to authenticate clients to the PPTP VPN server.
5. Click [Save](#).

## Step 2. Configure PPTP VPN Connection on Your Remote Device

The remote device can use the Windows built-in PPTP software or a third-party PPTP software to connect to PPTP Server. Here we use the [Windows built-in PPTP software](#) as an example.

1. Go to [Start > Control Panel > Network and Internet > Network and Sharing Center](#).
2. Select [Set up a new connection or network](#).

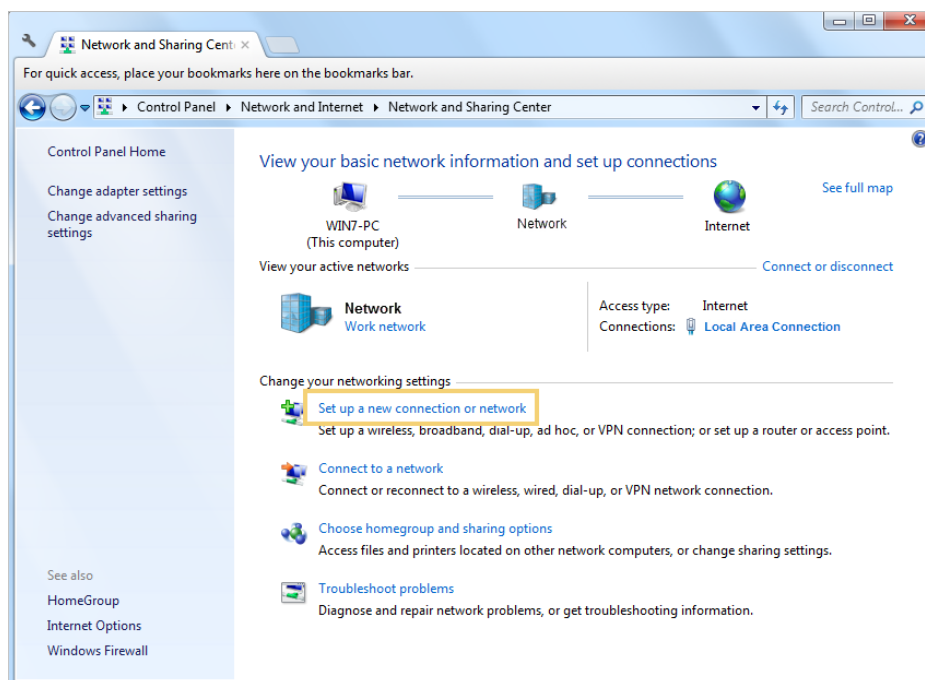

3. Select [Connect to a workplace](#) and click [Next](#).

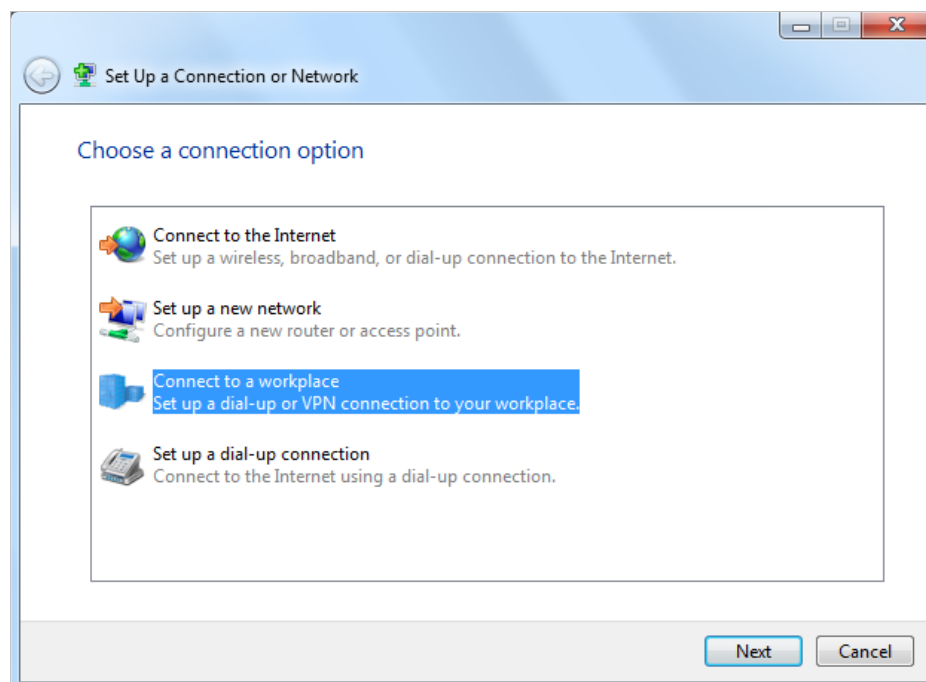

4. Select **Use my Internet connection (VPN)**.

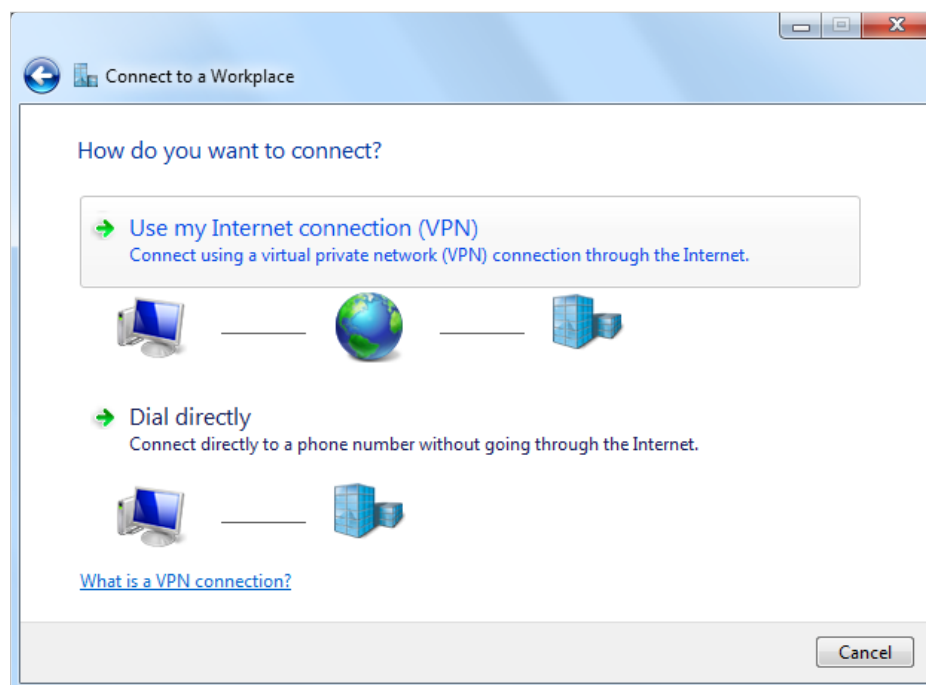

5. Enter the internet IP address of the router (for example: 218.18.1.73) in the **Internet address** field. Click **Next**.

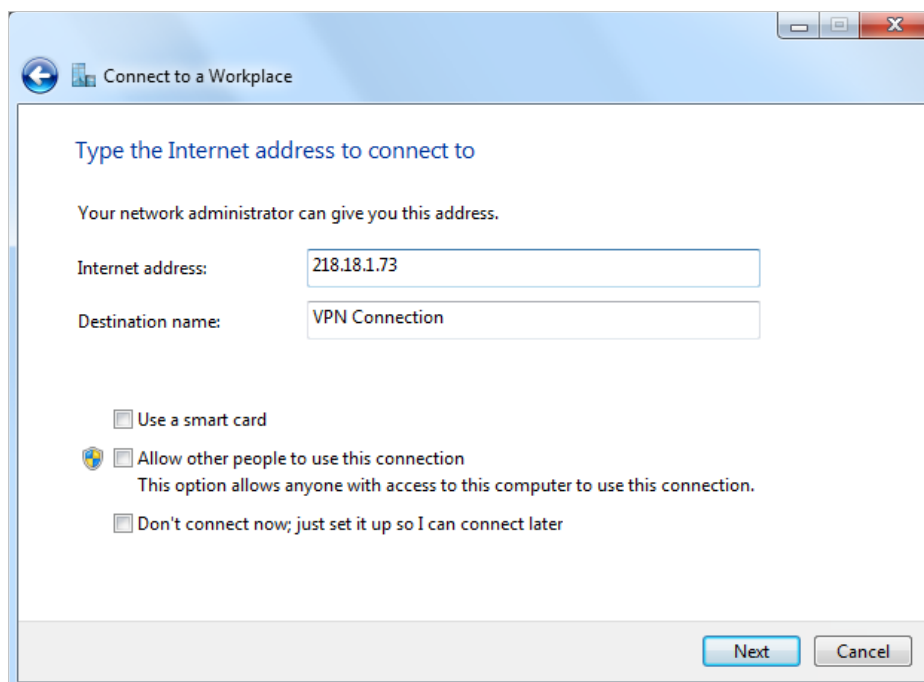

6. Enter the **Username** and **Password** you have set for the PPTP VPN server on your router, and click **Connect**.

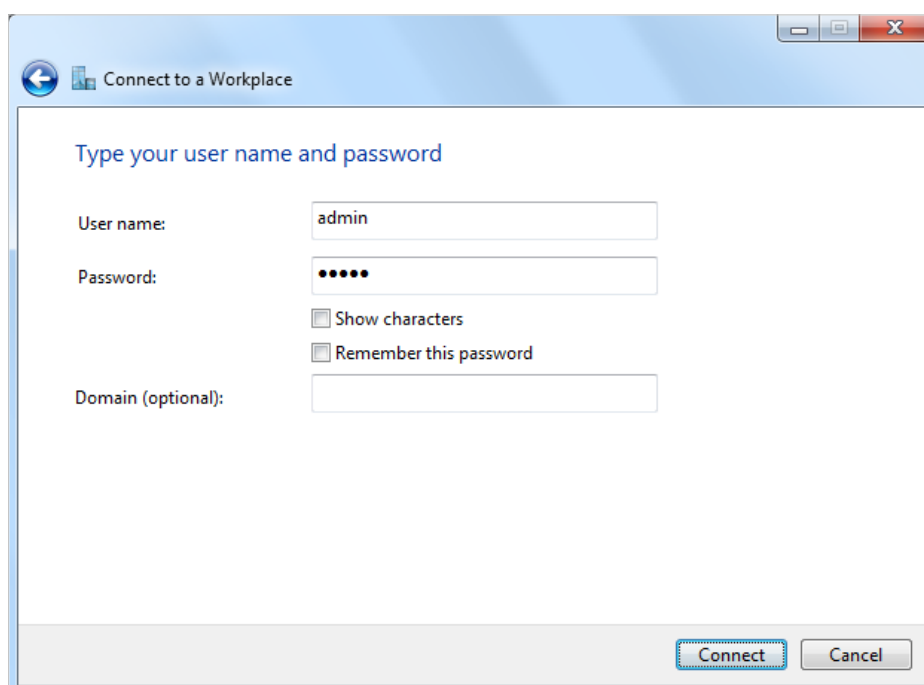

7. The PPTP VPN connection is created and ready to use.



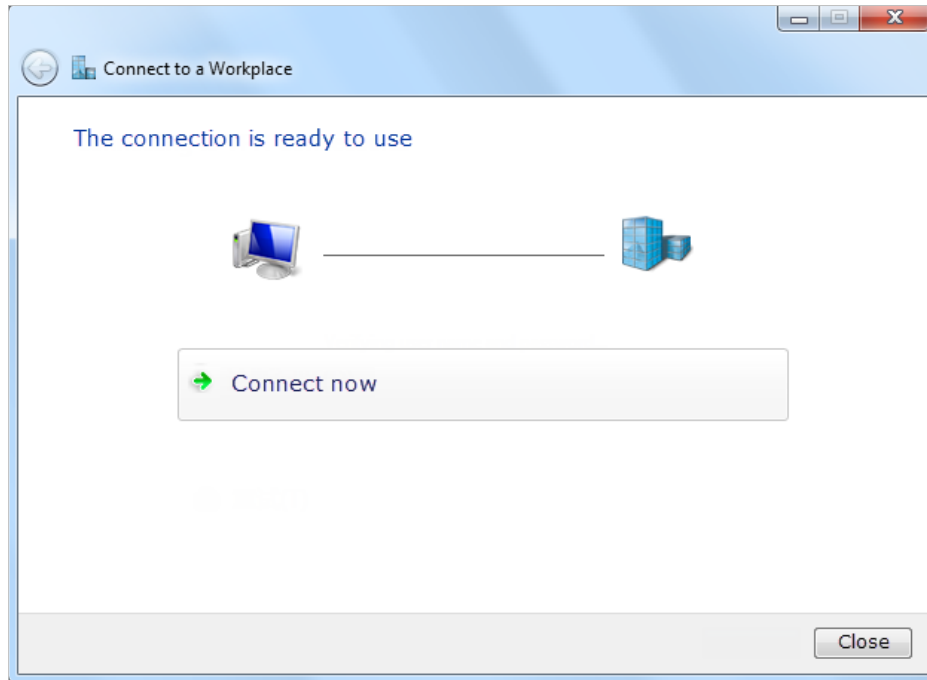

## 12.3. Use IPSec VPN to Access Your Home Network

IPSec VPN is used to create a VPN connection between local and remote networks. To use IPSec VPN, you should check that both local and remote routers support IPSec VPN feature. Then, follow the steps below to set up an IPSec VPN connection.

1. The typical VPN topology is here. Site A refers to local network, and Site B refers to the remote network that is to be connected. Record Site A and Site B's LAN and WAN IP addresses before you start configuration.

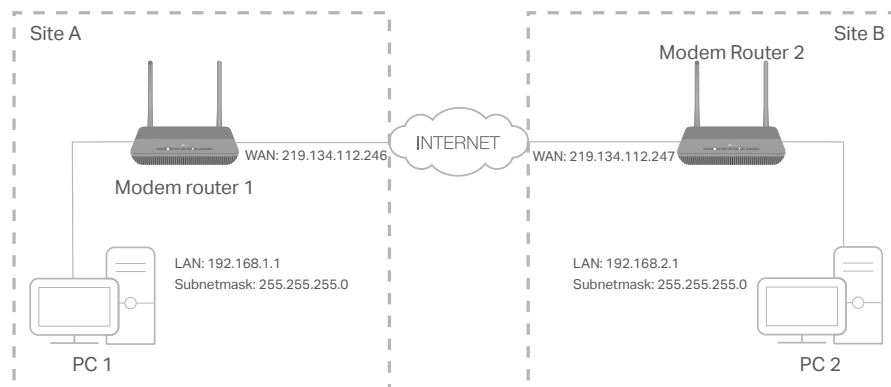

2. Configuration on Site A (local network).

- 1) Visit <http://tplinkmodem.net>, and log in with your TP-Link ID or the password you set for the router.
- 2) Go to **Advanced > VPN > IPSec VPN**, and click **Add**.

IPSec VPN

Dead Peer Detection:

+ Add - Delete

<input type="checkbox"/>	Connection Name	Remote Gateway	Local Address	Remote Address	Status	Enable	Modify
--	--	--	--	--	--	--	--

IPSec Connection Name:

Remote IPSec Gateway (URL):  Site B's WAN IP

Tunnel access from local IP addresses:

IP Address for VPN:  LAN IP range of Site A

Subnet Mask:

Tunnel access from remote IP addresses:

IP Address for VPN:  LAN IP range of Site B

Subnet Mask:

Key Exchange Method:

Authentication Method:

Pre-Shared Key:

Perfect Forward Secrecy:

Advanced

- 3) In the **IPSec Connection Name** column, specify a name.
- 4) In the **Remote IPSec Gateway (URL)** column, Enter Site B's WAN IP address.
- 5) Configure **Site A's LAN**.  
In the **Tunnel access from local IP addresses** column, we take **Subnet Address** as an example. Input the LAN IP range of Site A in the **IP Address for VPN** column, and input **Subnet Mask** of Site A.
- 6) Configure **Site B's LAN**.  
In the **Tunnel access from remote IP addresses** column, we take **Subnet Address** as an example. Input the LAN IP range of Site B in the **IP Address for VPN** column, and input **Subnet Mask** of Site B.
- 7) Select the **Key Exchange Method** for the policy. We select **Auto(IKE)** here.

- 8) Enter the **Pre-Shared Key** for IKE authentication. Then keep **Perfect Forward Secrecy** enabled.

**Note:** Make sure Site A and Site B use the same key.

- 9) Leave the **Advanced Settings** as default value. Then click **Save**.

<input type="checkbox"/>	Connection Name	Remote Gateway	Local Address	Remote Address	Status	Enable	Modify
<input type="checkbox"/>	VPN1	219.134.112.247	192.168.1.0	192.168.2.0	Down		

**Note:** The **Status** column is **Down** after the configuration, and it will change to **UP** only when Site A and Site B are communicating via the VPN connection.

- Configuration on Site B (remote network). Refer to step 2 configuration on Site A and make sure that Site A and Site B use the same **pre-shared keys** and **Perfect Forward Secrecy** settings.
- Check the VPN connection. You can ping site B' LAN IP from your computer in site A to verify that the IPsec VPN connection is set up correctly.

**Tips:** To check the VPN connection, you can do the following.

- On the host in Site A, press **[Windows Logo] + [R]** to open Run dialog. Input "cmd" and hit **OK**.

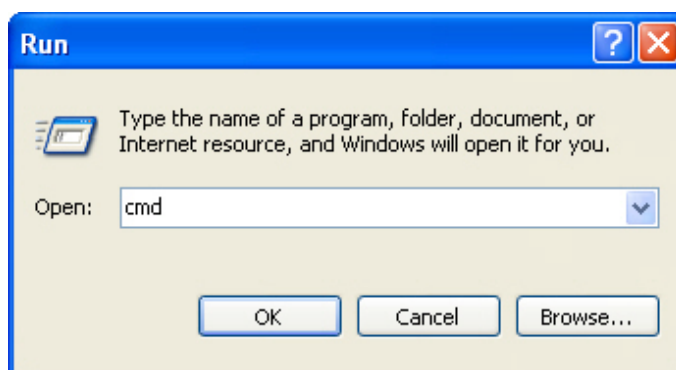

- In the CLI window, type in "ping 192.168.2.x" ("192.168.2.x" can be IP address of any host in Site B). Then press **[Enter]**.

```

C:\WINDOWS\system32\cmd.exe
Microsoft Windows XP [Version 5.1.2600]
(C) Copyright 1985-2001 Microsoft Corp.

C:\Users\Administrator>ping 192.168.2.100

Pinging 192.168.2.100 with 32 bytes of data:

Reply from 192.168.2.100: bytes=32 time<1ms TTL=128
Reply from 192.168.2.100: bytes=32 time<1ms TTL=128
Reply from 192.168.2.100: bytes=32 time<1ms TTL=128
Reply from 192.168.2.100: bytes=32 time<1ms TTL=128

Ping statistics for 192.168.2.100:
    Packets: Sent = 4, Received = 4, Lost = 0 (0% loss),
    Approximate round trip times in milli-seconds:
        Minimum = 0ms, Maximum = 0ms, Average = 0ms

C:\Users\Administrator>

```

- If Ping proceeds successfully (gets replies from host in Site B), the IPsec connection is working properly now.
- Now IPsec VPN is implemented to establish a connection.

**Note:**

1. The product supports a maximum of ten simultaneous connections.
2. If one of the site has been offline for a while, for example, if Site A has been disconnected, on Site B you need to click [Disable](#) and then click [Enable](#) after Site A back on line in order to re-establish the IPSec tunnel.

## Chapter 13

---

# Specify Your Network Settings

---

This chapter introduces how to change the default settings or adjust the basic configuration of the modem router using the web management page.

It contains the following sections:

- [LAN Settings](#)
- [IPv6 LAN Settings](#)
- [DSL Settings](#)
- [Wireless Settings](#)
- [Set Up a Dynamic DNS Service Account](#)
- [Create Static Routes](#)
- [Set Up the IPv6 Tunnel](#)

## 13.1. LAN Settings

### 13.1.1. Change the LAN IP Address

The modem router is preset with a default LAN IP 192.168.1.1, which you can use to log in to its web management page. The LAN IP address together with the Subnet Mask also defines the subnet that the connected devices are on. If the IP address conflicts with another device in your local network or your network requires a specific IP subnet, you can change it.

Follow the steps below to change your IP address.

1. Visit <http://tplinkmodem.net>, and log in with your TP-Link ID or the password you set for the router.
2. Go to [Advanced](#) > [Network](#) > [LAN Settings](#) page and select [IPv4](#).

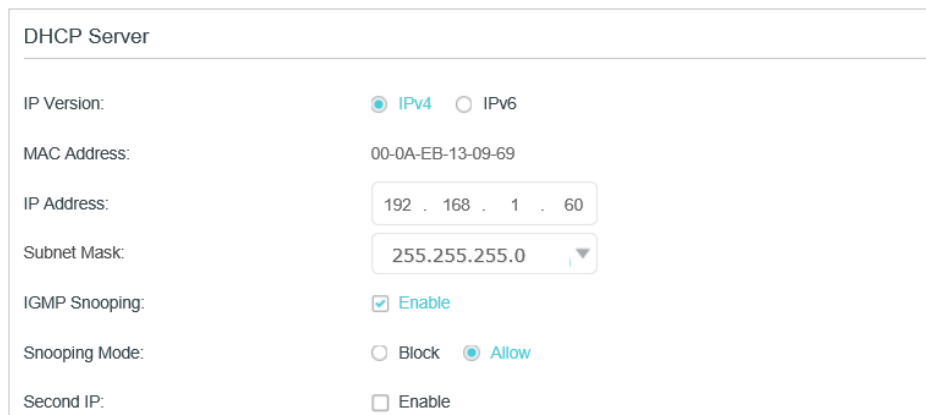

DHCP Server	
IP Version:	<input checked="" type="radio"/> IPv4 <input type="radio"/> IPv6
MAC Address:	00-0A-EB-13-09-69
IP Address:	192 . 168 . 1 . 60
Subnet Mask:	255.255.255.0
IGMP Snooping:	<input checked="" type="checkbox"/> Enable
Snooping Mode:	<input type="radio"/> Block <input checked="" type="radio"/> Allow
Second IP:	<input type="checkbox"/> Enable

3. Type in a new [IP Address](#) appropriate to your needs.
4. Select the [Subnet Mask](#) from the drop-down list. The subnet mask together with the IP address identifies the local IP subnet.
5. Keep [IGMP Snooping](#) enabled by default. IGMP snooping is the process of listening to IGMP (Internet Group Management Protocol) network traffic. The function prevents hosts on a local network from receiving traffic for a multicast group they have not explicitly joined.
6. You can configure the modem router's [Second IP](#) and [Subnet Mask](#) for LAN interface through which you can also access the web management page.
7. Leave the rest of the default settings as they are.
8. Click [Save](#) to make the settings effective.

### 13. 1. 2. Use the Modem Router as a DHCP Server

You can configure the modem router to act as a DHCP server to assign IP addresses to its clients. To use the DHCP server function of the modem router, you must configure all computers on the LAN to obtain an IP Address automatically.

Follow the steps below to configure DHCP server.

1. Visit <http://tplinkmodem.net>, and log in with your TP-Link ID or the password you set for the router.
2. Go to [Advanced](#) > [Network](#) > [LAN Settings](#) page and select [IPv4](#).

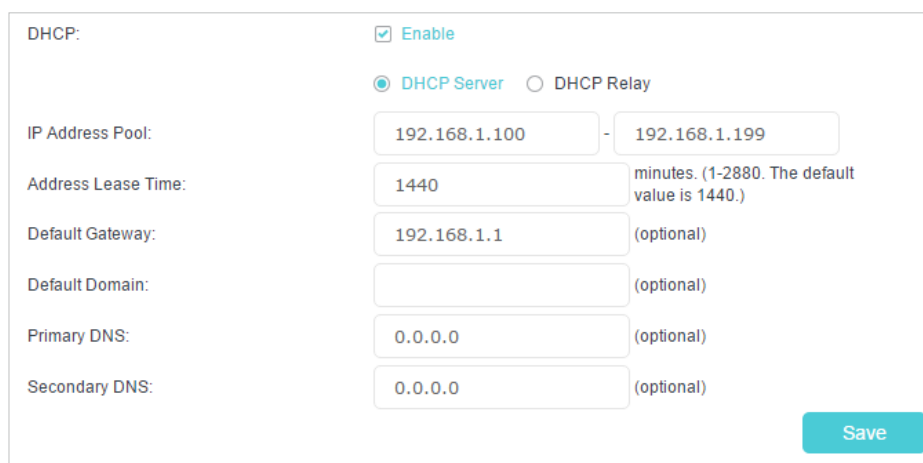

DHCP:  Enable

DHCP Server  DHCP Relay

IP Address Pool: 192.168.1.100 - 192.168.1.199

Address Lease Time: 1440 minutes. (1-2880. The default value is 1440.)

Default Gateway: 192.168.1.1 (optional)

Default Domain: (optional)

Primary DNS: 0.0.0.0 (optional)

Secondary DNS: 0.0.0.0 (optional)

Save

3. Select [DHCP](#) to enable the DHCP function and select [DHCP Server](#).
4. Specify the [IP Address Pool](#), the start address and end address must be on the same subnet with LAN IP. The modem router will assign addresses within this specified range to its clients. It is from 192.168.1.100 to 192.168.1.199 by default.
5. Enter a value for the [Address Lease Time](#). The [Address Lease Time](#) is the amount of time in which a DHCP client can lease its current dynamic IP address assigned by the modem router. After the dynamic IP address expires, the user will be automatically assigned a new dynamic IP address. The default is 1440 minutes.
6. Keep the rest of the settings as default and click [Save](#).

**Note:**

1. The modem router can be configured to work as a [DHCP Relay](#). A DHCP relay is a computer that forwards DHCP data between computers that request IP addresses and the DHCP server that assigns the addresses. Each of the device's interfaces can be configured as a DHCP relay. If it is enabled, the DHCP requests from local PCs will be forwarded to the DHCP server that runs on WAN side.
2. You can also appoint IP addresses within a specified range to devices of the same type by using [Condition Pool](#) feature. For example, you can assign IP addresses within the range (192.168.1.50 to 192.168.1.80) to Camera devices, thus facilitating the network management. Enable DHCP feature and configure the parameters according to your situation on the [Advanced](#) > [Network](#) > [LAN Settings](#) page.

### 13.1.3. Reserve LAN IP Addresses

You can view and add a reserved address for a client. When you specify an IP address for a device on the LAN, that device will always receive the same IP address each time when it accesses the DHCP server. If there are some devices in the LAN that require permanent IP addresses, please configure Address Reservation on the router for the purpose.

Follow the steps below to reserve an IP address for your device.

1. Visit <http://tplinkmodem.net>, and log in with your TP-Link ID or the password you set for the router.
2. Go to [Advanced](#) > [Network](#) > [LAN Settings](#) page and select [IPv4](#).
3. Scroll down to locate the [Address Reservation](#) table and click [Add](#) to add an address reservation entry for your device.

The screenshot shows the 'Address Reservation' configuration page. At the top, there are '+ Add' and '- Delete' buttons. Below is a table with the following columns: a checkbox, MAC Address, Reserved IP Address, Group, Status, and Modify. The table currently contains one row with dashes in all cells. Below the table, there are input fields for 'MAC Address', 'IP Address', and 'Group'. The 'MAC Address' field has a 'Scan' button next to it. The 'Group' field is set to 'Default'. There is a checked checkbox for 'Enable This Entry'. At the bottom right, there are 'Cancel' and 'Save' buttons.

4. Enter the [MAC address](#) of the device for which you want to reserve IP address.
5. Specify the IP address which will be reserved by the router.
6. Check to [Enable this entry](#) and click [Save](#) to make the settings effective.

## 13.2. IPv6 LAN Settings

Based on the IPv6 protocol, the modem router provides two ways to assign IPv6 LAN addresses:

- Configure the RADVD (Router Advertisement Daemon) address type
- Configure the DHCPv6 Server address type



### 13.2.1. Configure the RADVD Address Type

1. Visit <http://tplinkmodem.net>, and log in with your TP-Link ID or the password you set for the router.
2. Go to [Advanced](#) > [Network](#) > [LAN Settings](#).
3. Select [IPv6](#) to configure IPv6 LAN parameters.

DHCP Server

IP Version:  IPv4  IPv6

Group: Default

Address Type:  RADVD  DHCPv6 Server

Enable RDNSS

Enable ULA Prefix

Site Prefix Type:  Delegated  Static

Prefix Delegated WAN Connection: No available interface

Save

- 1) Select the [RADVD](#) address type to make the modem router assign IPv6 address prefixes to hosts.

**Note:**

Do not select the [Enable RDNSS](#) and [Enable ULA Prefix](#) check boxes unless required by your ISP. Otherwise you may not be able to access the IPv6 network. For more information about RDNSS and ULA Prefix, contact our technical support.

- 2) Keep [Site Prefix Type](#) as the default value [Delegated](#). If your ISP has provided a specific IPv6 site prefix, select [Static](#) and enter the prefix.
  - 3) Keep [WAN Connection](#) as the default value.
4. Click [Save](#) to make the settings effective.

### 13.2.2. Configure the DHCPv6 Server Address Type

1. Visit <http://tplinkmodem.net>, and log in with your TP-Link ID or the password you set for the router.
2. Go to [Advanced](#) > [Network](#) > [LAN Settings](#).
3. Select [IPv6](#) to configure IPv6 LAN parameters.

- 1) Select the **DHCPv6 Server** address type to make the modem router assign IPv6 addresses to hosts.
  - 2) Specify the **Start/End IPv6 Address** for the IPv6 suffixes. The modem router will generate IPv6 addresses within the specified range.
  - 3) Keep **Leased Time** as the default value.
  - 4) Keep **Site Prefix Type** as the default value **Delegated**. If your ISP has provided a specific IPv6 site prefix, select **Static** and enter the prefix.
  - 5) Keep **WAN Connection** as the default value.
4. Click **Save** to make the settings effective.

### 13.3. DSL Settings

1. Visit <http://tplinkmodem.net>, and log in with your TP-Link ID or the password you set for the router.
2. Go to **Advanced > Network > DSL Settings** page.

3. Select a **DSL Modulation Type/Annex Type** from the drop-down list. Do not change the default settings unless necessary.

4. Enable **Bit Swap**. With bit-swapping, the router can swap bits around different channels, allowing it to robustly adapt to changing telephone line conditions.
5. Enable **SRA** (Seamless Rate Adaptation) to prevent ADSL data rate interference caused by the cross-talk between telephone lines.
6. Click **Save**.

## 13.4. Wireless Settings

### 13.4.1. Specify Basic Wireless Settings

The modem router's wireless network name (SSID) and password, and security option are preset in the factory. The preset SSID and password can be found on the product label. You can customize the wireless settings according to your needs.

1. Visit <http://tplinkmodem.net>, and log in with your TP-Link ID or the password you set for the router.
2. Go to **Basic > Wireless** page.



Wireless Settings

2.4GHz Wireless Network:  Enable

Network Name (SSID):   Hide SSID

Password:

Save

- **To enable or disable the wireless function:**

Enable the 2.4 GHz Wireless Network. If you don't want to use the wireless function, just deselect the box. If you disable the wireless function, all the wireless settings won't be effective.

- **To change the wireless network name (SSID) and wireless password:**

Enter a new SSID using up to 32 characters. The value is case-sensitive.

**Note:**

If you use a wireless device to change the wireless settings, you will be disconnected after the new settings are effective. Please write down the new SSID and password for future use.

- **To hide SSID:**

Select Hide SSID, and your SSID will not be broadcast. Your SSID won't display on your wireless device when you scan for local wireless network list and you need to manually join the network.

- **To change the mode or channel:**

Go to [Advanced](#) > [Wireless](#) > [Wireless Settings](#) page.

**Mode:** Select the desired mode.

- 802.11n only: Select only if all of your wireless clients are 802.11n devices.
- 802.11gn mixed: Select if you are using both 802.11g and 802.11n wireless clients.
- 802.11bgn mixed: Select if you are using a mix of 802.11b, 11g, and 11n wireless clients.

**Note:** When 802.11n only mode is selected, only 802.11n wireless stations can connect to the modem router. It is strongly recommended that you select 802.11bgn mixed, and all of 802.11b, 802.11g, and 802.11n wireless stations can connect to the modem router.

**Channel:** Select the channel you want to use from the drop-down list. This field determines which operating frequency will be used. It is not necessary to change the wireless channel unless you notice interference problems with another nearby access point.

**Channel Width:** Select the channel width from the drop-down list. The default setting is **Auto**, which can adjust the channel width for your clients automatically.

**Transmit Power:** Select Low, Middle, or High to specify the data transmit power. The default and recommended setting is High.

- **To change the security option:**

1. Go to [Advanced](#) > [Wireless](#) > [Wireless Settings](#) page.
2. Select an option from the **Security** drop-down list. The router provides four options, None, WPA/WPA2 Personal (Recommended), WPA/WPA2 Enterprise, WEP. WPA2 uses the newest standard and the security level is the highest. We recommend you don't change the default settings unless necessary.

### 13.4.2. Use WPS for Wireless Connection

You can use WPS (Wi-Fi Protected Setup) to add a new wireless device to your existing network quickly and easily.

#### Method 1: Use the WPS button

Use this method if your client device has a WPS button.

1. Press the WPS button the modem router for 1 second.
2. Press the WPS button of the client device directly.
3. The wireless LEDs flash for about 2 minutes during the WPS process.
4. When the wireless LEDs stabilize and remain on, the client device has successfully connected to the modem router.

#### Method 2: Use the WPS button on the web management page

Use this method if your client device has a WPS button.

1. Visit <http://tplinkmodem.net>, and log in with your TP-Link ID or the password you set for the router.
2. Go to [Advanced](#) > [Wireless](#) > [WPS](#) page.

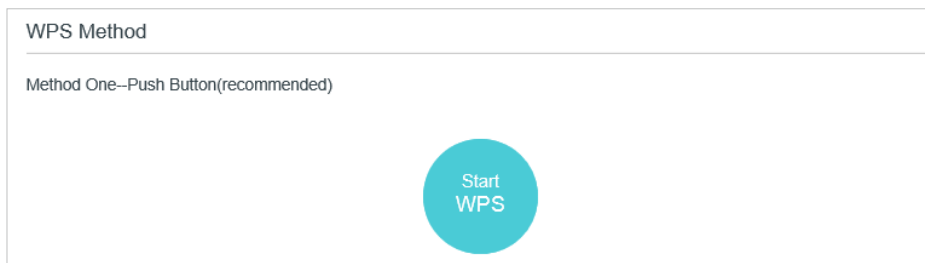

3. Click [Start WPS](#) on the page.
4. Press the WPS button of the client device directly.
5. The wireless LEDs flash for about 2 minutes during the WPS process.
6. When the wireless LEDs stabilize and remain on, the client device has successfully connected to the modem router.

#### Method 3: Enter the modem router's PIN on your client device

Use this method if your client device asks for the modem router's PIN.

1. Visit <http://tplinkmodem.net>, and log in with your TP-Link ID or the password you set for the router.
2. Go to [Advanced](#) > [Wireless](#) > [WPS](#) page. Click [Method Two--PIN](#).

Router's PIN    Client's PIN  
 Router's PIN   
 Router's PIN:

3. Take a note of the Current PIN of the modem router. You can also click the [Generate](#) button to get a new PIN.
4. On the client device, enter the modem router's PIN. (The default PIN is also printed on the label of the modem router.)
5. The wireless LEDs flash for about 2 minutes during the WPS process.
6. When the wireless LEDs stabilize and remain on, the client device has successfully connected to the modem router.

**Note:**

The WPS function cannot be configured if the wireless function of the modem router is disabled. Please make sure the wireless function is enabled before configuring WPS.

#### Method 4: Enter the client device's PIN on the modem router

1. Visit <http://tplinkmodem.net>, and log in with your TP-Link ID or the password you set for the router.
2. Go to [Advanced](#) > [Wireless](#) > [WPS](#) page. Click [Method Two--PIN](#).

Method Two--PIN  
 Router's PIN    Client's PIN  
 Enter the client's PIN:

3. Select [Client's PIN](#).
4. Enter the client device's PIN in the field. Then click the [Connect](#) button.
5. [Device has been added successfully!](#) will appear on the above screen, which means the client device has successfully connected to the modem router.

#### 13.4.3. Schedule Your Wireless Function

You can automatically turn off your wireless network (both 2.4GHz and 5GHz) when you do not need the wireless connection.

1. Visit <http://tplinkmodem.net>, and log in with your TP-Link ID or the password you set for the router.
2. Go to [Advanced](#) > [Wireless](#) > [Wireless Schedule](#) page.
3. Toggle on the button to enable the Wireless Schedule feature.

### Wireless Schedule

Wireless Schedule:

### Wireless Off Time

+ Add - Delete

<input type="checkbox"/>	ID	Wireless Off Time	Repeat	Modify
--	--	--	--	--

From:

To:

Repeat:  Every Day  Selected Day

Selected Day:  Sun  Mon  Tue  Wed  Thu  Fri  Sat

4. Click [Add](#) to set the [Wireless Off Time](#), and click [Save](#) to save the settings.

5. Repeat steps 3 and 4 to set another entry.

**Note:**

1. Make sure that the time of the router is correct before using this function. For details, refer to [Set System Time](#).
2. The wireless LED will turn off if the corresponding wireless network is disabled.
3. The wireless network will be automatically turned on after the time period you set.

### 13.4.4. View Wireless Information

• **To view the detailed wireless network settings:**

1. Visit <http://tplinkmodem.net>, and log in with your TP-Link ID or the password you set for the router.
2. Go to [Advanced](#) > [Status](#) page. You can see the [Wireless](#) box.

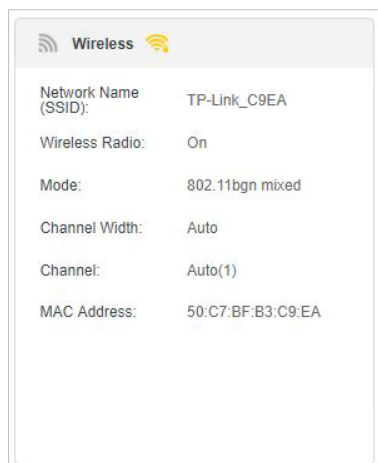

🔗 Tips: You can also see the wireless details by clicking the router icon on [Basic > Network Map](#).

- **To view the detailed information of the connected wireless clients:**

1. Visit <http://tplinkmodem.net>, and log in with your TP-Link ID or the password you set for the router.
2. Go to [Advanced > Wireless > Statistics](#) page.
3. You can view the detailed information of the wireless clients, including its connected wireless band and security option as well as the packets transmitted.

🔗 Tips: You can also see the wireless details by clicking the wireless clients icon on [Basic > Network Map](#).

### 13.4.5. Advanced Wireless Settings

Advanced wireless settings are for those who have a network concept. If you are not familiar with the settings on this page, it's strongly recommended that you keep the provided default values; otherwise it may result in lower wireless network performance.

1. Visit <http://tplinkmodem.net>, and log in with your TP-Link ID or the password you set for the router.
2. Go to [Advanced > Wireless > Advanced Settings](#) page.



The screenshot shows the 'Advanced Settings' page for a wireless network. At the top right, there are tabs for '2.4GHz' and '5GHz'. The settings are as follows:

Setting	Value	Range
Beacon Interval:	100	(25-1000)
RTS Threshold:	2346	(1-2346)
DTIM Interval:	1	(1-255)
Group Key Update Period:	0	seconds

Below the input fields are three checkboxes:

- WMM:  Enable
- Short GI:  Enable
- AP Isolation:  Enable

A blue 'Save' button is located at the bottom right of the settings area.

- **Beacon Interval:** Enter a value between 25 and 1000 in milliseconds to determine the duration between which beacon packets are broadcasted by the router to synchronize the wireless network. The default is 100 milliseconds.
- **RTS Threshold:** Enter a value between 1 and 2346 to determine the packet size of data transmission through the router. By default, the RTS (Request to Send) Threshold size is 2346. If the packet size is greater than the preset threshold, the router sends Request to Send frames to a particular receiving station and negotiates the sending of a data frame, or else the packet will be sent immediately.
- **DTIM Interval:** Enter a value between 1 and 255 to determine the interval of the Delivery Traffic Indication Message (DTIM). 1 indicates the DTIM Interval is the same as **Beacon Interval**.
- **Group Key Update Period:** Enter the number of seconds to control the time interval for the encryption key automatic renewal. The default is 0, indicating no key renewal.
- **WMM:** This feature guarantees the packets with high-priority messages being transmitted preferentially. WMM is enabled compulsively under 802.11n or 802.11ac mode.
- **Short GI:** This feature is enabled by default and recommended to increase the data capacity by reducing the Guard Interval (GI) time.
- **AP Isolation:** Select this check box to enable the AP Isolation feature that allows you to confine and restrict all wireless devices on your network from interacting with each other, but still able to access the internet. AP isolation is disabled by default.

## 13.5. Set Up a Dynamic DNS Service Account

Most ISPs (Internet service providers) assign a dynamic IP address to the router and you can use this IP address to access your router remotely. However, the IP address can change any time and you don't know when it changes. In this case, you might need

the DDNS (Dynamic Domain Name Server) feature on the router to allow you and your friends to access your router and local servers (FTP, HTTP, etc.) using domain name, in no need of checking and remembering the IP address.

**Note:** DDNS does not work if the ISP assigns a private WAN IP address (such as 192.168.1.x) to the modem router.

To set up DDNS, please follow the instructions below:

1. Visit <http://tplinkmodem.net>, and log in with your TP-Link ID or the password you set for the router.
2. Go to [Advanced](#) > [Network](#) > [Dynamic DNS](#).
3. Select the [DDNS service provider](#) (TP-Link, Dyndns, NO-IP and many other DNS services).
4. To use TP-Link DDNS service, you should log in with your TP-Link ID.
5. If you choose other DDNS service, you should also log in with your DDNS account, select a service provider and click [Go to register](#). Enter the username, password and domain name of the account (such as lisa.ddns.net).

Dynamic DNS Settings

Service Provider:  [Go to register...](#)

Username:

Password:

Domain Name:

Status: Disconnected

6. Click [Log in](#) and [Save](#).

**Tips:** If you want to use a new DDNS account, please Logout first, then login with the new account.

## 13.6. Create Static Routes

A static route is a pre-determined path that network information must travel to reach a specific host or network. Data from one point to another will always follow the same path regardless of other considerations. Normal internet usage does not require this setting to be configured.

### I want to:

Visit multiple networks and multiple servers at the same time.

[For example](#), in a small office, my PC can surf the internet, but I also want to visit my

company's server. Now I have a switch and another router. I connect the devices as shown in the following figure so that the physical connection between my PC and my company's server is achieved. To surf the internet and visit my company's network at the same time, I need to configure the static routing.

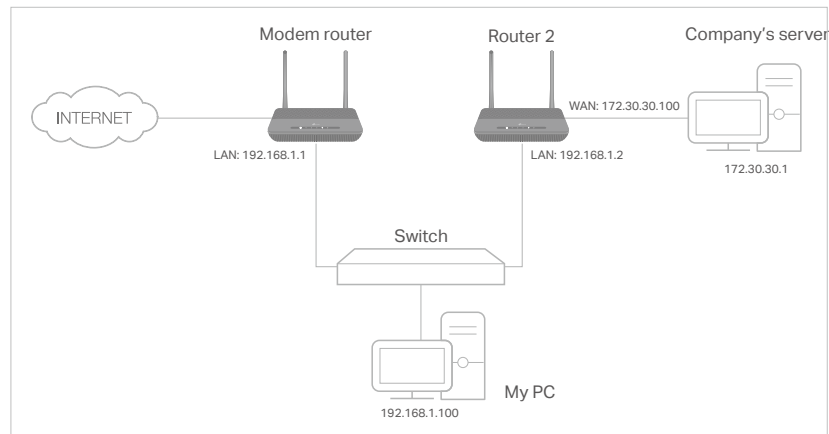

## How can I do that?

1. Make sure the routers use different LAN IP addresses on the same subnet. Disable Router 2's DHCP function.
2. Visit <http://tplinkmodem.net>, and log in with your TP-Link ID or the password you set for the router.
3. Go to **Advanced > Network > Static Routing**. Select your current **WAN Interface** and click **Save**.

Default Gateway Settings IPv4 | IPv6

---

Select a WAN interface as the system default gateway.

Select WAN Interface:  Save

---

Static Routing + Add - Delete

	ID	Network Destination	Subnet Mask	Gateway	Status	Modify
<input type="checkbox"/>	--	--	--	--	--	--

4. Click **Add** to add a new static routing entry. Finish the settings according to the following explanations:

Static Routing

+ Add - Delete

<input type="checkbox"/>	ID	Network Destination	Subnet Mask	Gateway	Status	Modify
--	--	--	--	--	--	--

Network Destination: 172 . 30 . 30 . 1

Subnet Mask: 255 . 255 . 255 . 255

Gateway: 192 . 168 . 1 . 2

Interface: LAN

Enable This Entry

Cancel Save

- **Network Destination:** The destination IP address that you want to assign to a static route. This IP address cannot be on the same subnet with the WAN IP or LAN IP of the router. In the example, the IP address of the company network is the destination IP address, so here enters 172.30.30.1.
  - **Subnet Mask:** Determines the destination network with the destination IP address. If the destination is a single IP address, enter 255.255.255.255; otherwise, enter the subnet mask of the corresponding network IP. In the example, the destination network is a single IP, so here enters 255.255.255.255.
  - **Gateway:** The IP address of the gateway device to which the data packets will be sent. This IP address must be on the same subnet with the router's IP which sends out the data. In the example, the data packets will be sent to the LAN port of Router 2 and then to the Server, so the default gateway should be 192.168.1.2.
  - **Interface:** Determined by the port (WAN/LAN) that sends out the data packets. In the example, the data is sent to the gateway through the LAN port, so LAN should be selected.
5. Select the check box to enable this entry.
  6. Click **Save** to save the settings.

## Done!

Open a web browser on your PC. Enter the company server's IP address to visit the company network.

## 13.7. Set Up the IPv6 Tunnel

The IPv6 Tunnel feature helps you obtain IPv6 resources based on an IPv4 WAN connection or vice versa.

IPv6 Tunnel is a transition mechanism that enables IPv6-only hosts to reach IPv4 services or vice versa and allows isolated IPv6 hosts and networks to reach each other over IPv4-only infrastructure before IPv6 completely supplants IPv4. It is a temporary solution for networks that do not support native dual-stack, where both IPv6 and IPv4 run independently.

The modem router provides three tunneling mechanisms: [6to4](#), [6rd](#) and [DS-Lite](#). The way to set up 6rd and DS-Lite tunnel are similar.

### 13.7.1. Use the Public IPv6 Tunnel Service-6to4

The 6to4 tunnel is a kind of public service. If there are any 6to4 servers on your network, you can use this mechanism to access IPv6 service. If your ISP provides you with an IPv4-only connection but you want to visit IPv6 websites, you can try to set up a 6to4 tunnel.

#### I want to:

Set up the IPv6 tunnel though my ISP doesn't provide me with the tunnel service.

#### How can I do that?

1. Visit <http://tplinkmodem.net>, and log in with your TP-Link ID or the password you set for the router.
2. Go to [Advanced](#) > [Network](#) > [IPv6 Tunnel](#).
3. Tick the check box, select [6to4](#) as the tunneling mechanism and select a WAN connection from the drop-down list, then click [Save](#).

IPv6 Tunnel

Note: You must reconfigure the IPv6 Tunnel settings every time you reboot the router. Make sure the desired WAN connection is connected before the configuration.

IPv6 Tunnel:  Enable

Tunneling Mechanism: 6to4

WAN Connection: pppoe\_8\_31\_1\_d

Save

#### Note:

If there is no available WAN connection to choose, make sure you have connected to the internet and the connection type is not Bridge.

#### Done!

Now you can visit the IPv6 websites with the 6to4 tunnel.

#### Note:

Still not being able to access IPv6 resources means that not any 6to4 public server was found in your network. You can contact your ISP to sign up for IPv6 connection service.

## 13.7.2. Specify the 6rd Tunnel with Parameters Provided by Your ISP

### I want to:

Specify the 6rd tunnel with the parameters provided by my 6rd tunnel service provider.

### How can I do that?

1. Visit <http://tplinkmodem.net>, and log in with your TP-Link ID or the password you set for the router.
2. Go to [Advanced](#) > [Network](#) > [IPv6 Tunnel](#).
3. Tick the check box, select [6rd](#) as the tunneling mechanism and select a WAN connection from the drop-down list.
4. According to the parameters provided by your ISP, choose [Auto](#) or [Manual](#). More parameters are needed if you choose [Manual](#).
5. Click [Save](#).

#### IPv6 Tunnel

Note: You must reconfigure the IPv6 Tunnel settings every time you reboot the router. Make sure the desired WAN connection is connected before the configuration.

IPv6 Tunnel:  Enable

Tunneling Mechanism:

WAN Connection:

Configuration Type:  Auto  Manual

IPv4 Mask Length:

6rd Prefix:

6rd Prefix Length:

Border Relay IPv4 Address:

[Save](#)

#### Note:

If there is no available WAN connection to choose, make sure you have connected to the internet and the connection type is not Bridge.

### Done!

Now you can visit the IPv6 websites with the 6rd tunnel.

#### Tips:

The way to set up DS-Lite tunnel is similar to that of 6rd tunnel. If you are provided with an IPv6-only WAN connection and have signed up for DS-Lite tunnel service, specify the DS-Lite tunnel by referring to the steps above.

## Chapter 14

---

# Administrate Your Network

---

This chapter introduces how to change the system settings and administrate your modem router's network.

This chapter contains the following sections:

- [Set System Time](#)
- [Update the Firmware](#)
- [Back up and Restore Configuration Settings](#)
- [Change the Administrator Account](#)
- [Local Management](#)
- [Remote Management](#)
- [System Log](#)
- [CWMP Settings](#)
- [SNMP Settings](#)

## 14.1. Set System Time

System time is the time displayed while the modem router is running. The system time you configure here will be used for other time-based functions like Parental Controls and Wireless Schedule. You can manually set how to get the system time.

Follow the steps below to set your system time.

1. Visit <http://tplinkmodem.net>, and log in with your TP-Link ID or the password you set for the modem router.
2. Go to [Advanced](#) > [System Tools](#) > [Time Settings](#) page.

The screenshot shows the 'System Time' configuration page. It includes the following fields and buttons:

- Current Time:** 02/02/2017 09:00:16
- Time Zone:** (GMT+01:00) Amsterdam, Berlin, Rome, Stockholm, Paris, Prague, Bratislava (dropdown menu)
- Date:** 2/2/2017 (DD/MM/YY)
- Time:** 9 : 0 : 0 (hour, minute, and second dropdown menus)
- NTP Server I:** ptbtime1.ptb.de (Optional)
- NTP Server II:** ptbtime2.ptb.de (Optional)
- Buttons:** 'Get from PC', 'Get from the Internet', and 'Save'.

3. Configure the system time using the following methods:
  - Manually:** Select your time zone and enter your local time.
  - Get from PC:** Click this button if you want to use the current managing PC's time.
  - Get from the Internet:** Click this button if you want to get time from the internet. Make sure your modem router can access the internet before you select this way to get system time.
4. Click [Save](#).
5. After setting the system time, you can set [Daylight Saving Time](#) according to your needs. Tick the check box to enable [Daylight Saving Time](#), set the start and end time and then click [Save](#) to make the settings effective.

The screenshot shows the 'Daylight Saving Time' configuration page. It includes the following fields and buttons:

- Enable Daylight Saving Time:**
- Start:** 2017, Mar, Last, Sun, 02:00
- End:** 2017, Oct, Last, Sun, 03:00
- Button:** 'Save'.



## 14. 2. Update the Firmware

TP-Link is dedicated to improving product features, giving you a better network experience.

We will inform you through the web management page if there's any update firmware available for your router. The latest firmware can also be downloaded from the [Support](#) page of our website [www.tp-link.com](http://www.tp-link.com) for free.

**Note:**

1. Make sure that you have a stable connection between the router and your computer. It is NOT recommended to upgrade the firmware wirelessly.
2. Back up your router configuration before upgrading the firmware.
3. Do NOT turn off the router during the firmware upgrade.

### 14. 2. 1. Online Upgrade

1. Visit <http://tplinkmodem.net>, and log in with your TP-Link ID or the password you set for the router.
2. If there's any firmware update available for your router, the update icon  will display on the top-right corner of the page. Click the icon to go to the [Firmware Upgrade](#) page.

Alternatively, you can go to [Advanced](#) > [System Tools](#) > [Firmware Upgrade](#), and click [Check for Upgrades](#) to see if there's any new firmware.

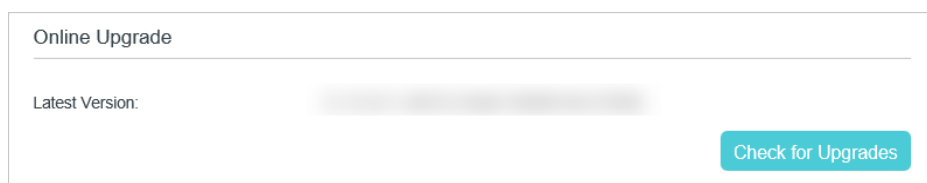

**Tips:**

If there's any new important firmware update for your router, you will see the notification (similar as shown below) on your computer when open a new web page. Click [Upgrade now](#), and log into the web management page. You will see the [Firmware Upgrade](#) page.

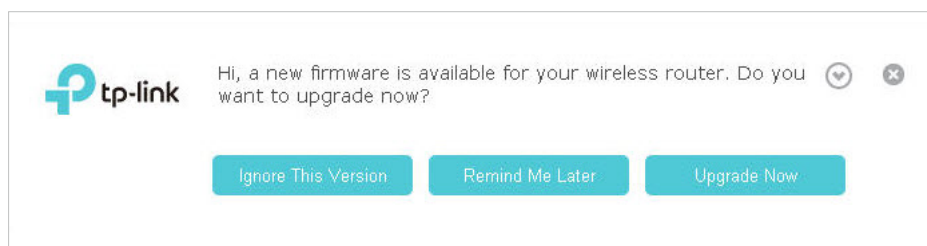

3. Wait a few moments for the upgrading and rebooting.

### 14.2.2. Local Upgrade

1. Download the latest firmware file for the router from our website [www.tp-link.com](http://www.tp-link.com).
2. Visit <http://tplinkmodem.net>, and log in with your TP-Link ID or the password you set for the router.
3. Go to [Advanced](#) > [System Tools](#) > [Firmware Upgrade](#).
4. Focus on the [Device Information](#) section. Make sure the downloaded firmware file matches with the [Hardware Version](#).
5. Focus on the [Local Upgrade](#) section. Click [Browse](#) to locate the downloaded new firmware file, and click [Upgrade](#).

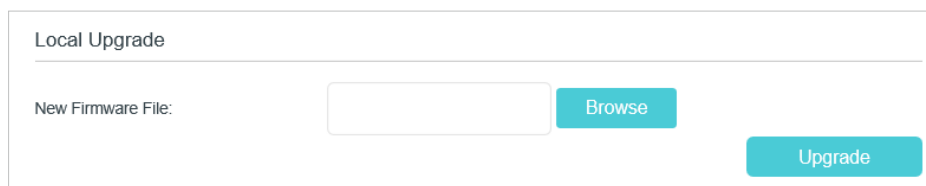

Local Upgrade

New Firmware File:  [Browse](#)

[Upgrade](#)

6. Wait a few moments for the upgrading and rebooting.

## 14.3. Back up and Restore Configuration Settings

The configuration settings are stored as a configuration file in the router. You can back up the configuration file to your computer for future use and restore the modem router to a previous settings from the backup file when needed. Moreover, if needed you can erase the current settings and reset the modem router to the default factory settings.

- **To back up configuration settings**

1. Visit <http://tplinkmodem.net>, and log in with your TP-Link ID or the password you set for the router.
2. Click [Advanced](#) > [System Tools](#) > [Backup & Restore](#) page.



Backup

Save a copy of your current settings.

[Backup](#)

3. Click [Backup](#) to save a copy of the current settings to your local computer. A conf. bin file will be stored to your computer.

- **To restore configuration settings**

1. Visit <http://tplinkmodem.net>, and log in with your TP-Link ID or the password you set for the router.
2. Click [Advanced](#) > [System Tools](#) > [Backup & Restore](#) page.

3. Click [Browse](#) to locate the previous backup configuration file, and click [Restore](#).
  4. Wait for the restoring and then the modem router will automatically reboot.
- **To reset the modem router to factory default settings**
    1. Visit <http://tplinkmodem.net>, and log in with your TP-Link ID or the password you set for the router.
    2. Click [Advanced](#) > [System Tools](#) > [Backup & Restore](#) page and locate the [Factory Default Restore](#) section.

3. Click [Restore](#) to restore all configuration settings to default values, except your login and TP-Link ID information. Click [Factory Restore](#) to reset the modem router.
4. Wait for the reset process to complete, and then the modem router will automatically reboot.

**Note:**

1. During the resetting process, do not turn off the modem router.
2. We strongly recommend you back up the current configuration settings before resetting the modem router.

## 14. 4. Change the Administrator Account

Admin account is used to log in to the modem router's web management page. You are required to set the admin account at first login. You can also change it on the web page.

1. Visit <http://tplinkmodem.net>, and log in with your TP-Link ID or the password you set for the router.
2. Go to [Advanced](#) > [System Tools](#) > [Administration](#) page. Locate the [Account Management](#) section.

Account Management

Old Password:

New Password:   
 Low Middle High

Confirm New Password:

Save

3. Enter the old password. Enter the new password and enter again to confirm.
4. Click [Save](#) to make the settings effective.

## 14.5. Local Management

You can control the local devices' authority to manage the modem router via Local Management feature. By default all local connected devices are allowed to manage the modem router. You can also specify one device to manage the modem router and enable local management over a more secure way, HTTPS.

Follow the steps below to allow only the specific device to manage the router via the local management over HTTPS.

1. Visit <http://tplinkmodem.net>, and log in with your TP-Link ID or the password you set for the router.
2. Go to [Advanced](#) > [System Tools](#) > [Administration](#) page. Locate the [Local Management](#) section.
3. Keep the [Port for HTTP](#) as the default setting. Enable [Local Management over HTTPS](#) and keep the [Port for HTTPS](#) as the default setting. Enter the [IP address](#) or [MAC address](#) of the local device to manage the modem router.

Local Management

Port for HTTP:

Local Management via HTTPS:  Enable

Port for HTTPS:

IP/MAC Address:

Save

4. Click [Save](#).

Now, you can manage the modem router over both HTTP (<http://tplinkmodem.net>) and HTTPS (<https://tplinkmodem.net>).

**Note:**

If you want that all local devices can manage the modem router, just leave the [IP/MAC Address](#) field blank.

## 14.6. Remote Management

By default, the remote devices are not allowed to manage the modem router from the internet. You can enable remote management over HTTP and/or HTTPS if needed. HTTPS is a more secure way to access the router.

**Note:**

If your ISP assigns a private WAN IP address (such as 192.168.x.x or 10.x.x.x), you cannot use the remote management feature because private addresses are not routed on the internet.

Follow the steps below to allow remote devices to manage the modem router over HTTPS.

1. Visit <http://tplinkmodem.net>, and log in with your TP-Link ID or the password you set for the router.
2. Go to [Advanced](#) > [System Tools](#) > [Administration](#) page. Locate the [Remote Management](#) section.

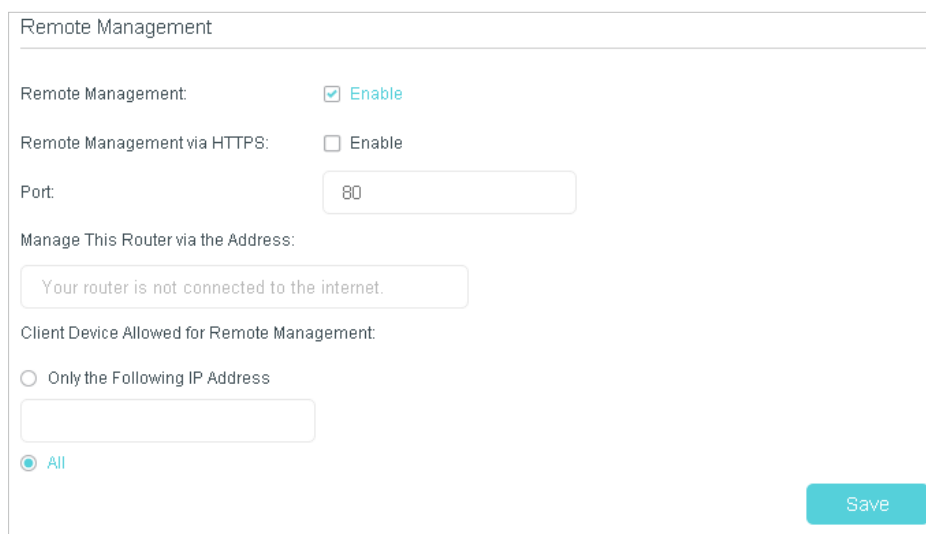

The screenshot shows the 'Remote Management' configuration page. It includes the following settings:

- Remote Management:**  Enable
- Remote Management via HTTPS:**  Enable
- Port:** 80
- Manage This Router via the Address:** Your router is not connected to the internet.
- Client Device Allowed for Remote Management:**
  - Only the Following IP Address
  - All

A 'Save' button is located at the bottom right of the form.

3. Tick the check box to enable [Remote Management](#). Enable [Remote Management via HTTPS](#) to allow for HTTPS connection. Keep the [Port](#) as the default setting.
4. Set the client device allowed for remote management. Select [All](#) to allow all remote devices to manage the modem router. If you just want to allow a specific device to manage the modem router, select [Only the Following IP Address](#) and enter the IP address of the remote device.
5. Click [Save](#).

All devices or the specific device on the internet can log in to your router using the address displayed on the [Manage This Router via the Address](#) field to manage the modem router.

 Tips:

1. If you were warned about the certificate when visiting the web management page remotely, click [Trust](#) (or a similar option) to continue. To avoid this warning, you can download and install the certificate on the modem router's web management page at [Advanced > System Tools > Administration](#).

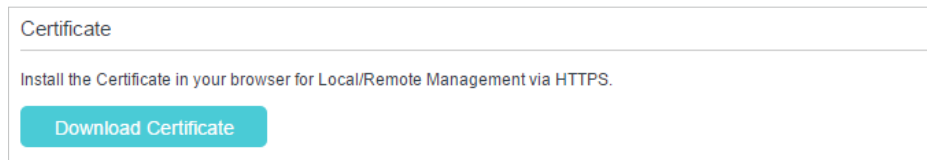

2. The router's WAN IP is usually a dynamic IP. Please refer to [Set Up a Dynamic DNS Service Account](#) if you want to log in to the router through a domain name.

## 14.7. System Log

System Log can help you know what happened to your modem router, facilitating you to locate the malfunctions. For example when your modem router does not work properly, you will need to save the system log and send it to the technical support for troubleshooting.

1. Visit <http://tplinkmodem.net>, and log in with your TP-Link ID or the password you set for the router.
2. Click [Advanced > System Tools > System Log](#) page.

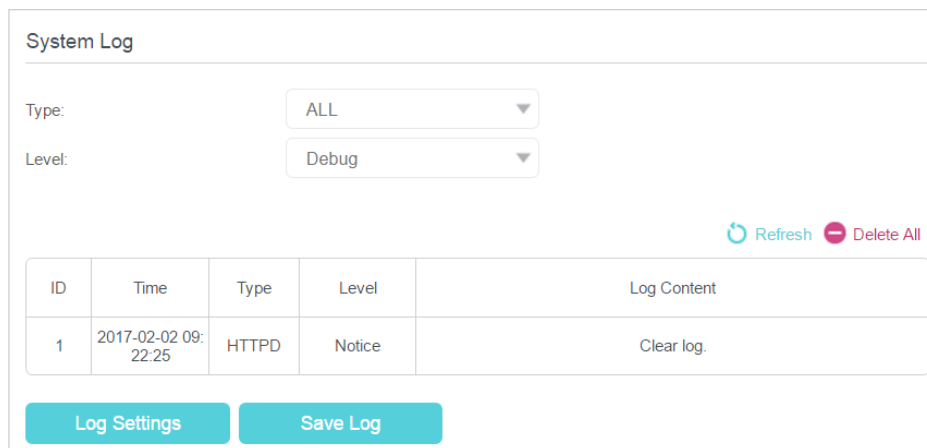

- **To view the system logs:**

You can view specific system logs by selecting the log Type and Level.

Click [Refresh](#) to refresh the log list.

- **To save the system logs:**

You can choose to save the system logs to your local computer or a remote server.

Click [Save Log](#) to save the logs in a txt file to your computer.

Click [Log Settings](#) to set the storage path of logs.

Log Settings

Save Locally

Minimum Level: Information

Save Remotely

Minimum Level: Warning

Server IP: 192.168.1.100

Server Port: 514

Local Facility Name: User

Back Save

- **Save Locally:** Select this option to cache the system log to the router's local memory, select the minimum level of system log to be saved from the drop-down list. The logs will be shown in the table in descending order on the System Log page.
- **Save Remotely:** Select this option to send the system log to a remote server, select the minimum level of system log to be saved from the drop-down list and enter the information of the remote server. If the remote server has a log viewer client or a sniffer tool implemented, you can view and analyze the system log remotely in real-time.

## 14. 8. CWMP Settings

The modem router supports CWMP (CPE WAN Management Protocol), also called TR-069. This collects information, performs diagnostics and configures the devices automatically via ACS (Auto-Configuration Server).

1. Visit <http://tplinkmodem.net>, and log in with your TP-Link ID or the password you set for the router.
2. Go to [Advanced](#) > [System Tools](#) > [CWMP Settings](#) page.

### CWMP Settings

CWMP:	<input type="checkbox"/>
Inform:	<input type="checkbox"/>
Inform Interval:	<input type="text" value="300"/> (seconds)
ACS URL:	<input type="text"/>
ACS Username:	<input type="text" value="admin"/>
ACS Password:	<input type="password" value="****"/>
Interface used by TR-069 client:	<input type="text" value="Any WAN"/> ▼
Display SOAP messages on serial console:	<input type="checkbox"/>
<input checked="" type="checkbox"/> <a href="#">Connection Request Authentication</a>	
Username:	<input type="text" value="admin"/>
Password:	<input type="password" value="****"/>
Path:	<input type="text" value="/tr069"/>
Port:	<input type="text" value="7547"/>
URL:	<input type="text"/>

- **CWMP:** Toggle On to enable the CWMP (CPE WAN Management Protocol) feature.
- **Inform:** Enable this feature to send an Inform message to the ACS (Auto Configuration Server) periodically.
- **Inform Interval:** Enter the time interval in seconds when the Inform message will be sent to the ACS.
- **ACS URL:** Enter the web address of the ACS which is provided by your ISP.
- **ACS Username/Password:** Enter the username/password to log in to the ACS server.
- **Interface used by TR-069 client:** Select which interface to be used by the TR-069 client.
- **Display SOAP messages on serial console:** Toggle to enable or disable this feature.
- **Connection Request Authentication:** Select this check box to enable authentication for the connection request.
- **Username/Password:** Enter the username/password for the ACS server to log in to the router.
- **Path:** Enter the path for the ACS server to connect to the router.
- **Port:** Enter the port for the ACS server to connect to the router.
- **URL:** Enter the URL for the ACS server to connect to the router.



- **Get RPC methods:** Click to get the methods to support CWMP.

Click **Save** to make the settings effective.

## 14.9. SNMP Settings

SNMP (Simple Network Management Protocol) is widely applied in the computer networks of today, and is used for ensuring the transmission of the management information between two nodes. In this way, network administrators can easily search and modify the information on any node on the network. Meanwhile, they can locate faults promptly and implement the fault diagnosis, capacity planning and report generating.

An **SNMP Agent** is an application running on the modem router that performs the operational role of receiving and processing SNMP messages, sending responses to the SNMP manager, and sending traps when an event occurs. So a router contains SNMP "agent" software can be monitored and/or controlled by SNMP Manager using SNMP messages.

1. Visit <http://tplinkmodem.net>, and log in with your TP-Link ID or the password you set for the modem router.
2. Go to **Advanced > System Tools > SNMP Settings** page.

SNMP Settings

SNMP Agent:

SNMP Agent for WAN:

Read-only Community:

Write Community:

System Name:

System Description:

System Location:

System Contact:

Trap Manager IP:

**Save**

- **SNMP Agent:** Toggle On to enable the built-in SNMP agent that allows the router to operate as the operational role in receiving and processing of SNMP messages, sending responses to the SNMP manager, and triggering SNMP traps when an event occurs.

- **Read-only Community:** Displays the default public community string that protects the router from unauthorized access.
- **Write Community:** Displays the default write community string that protects the router from unauthorized changes.
- **System Name:** Displays the administratively-assigned name for this managed device.
- **System Description:** Displays the textual description of the managed device. This value should include the full name and version identification of the system's hardware type, software operating-system, and networking software.
- **System Location:** Displays the physical location of this device (for example, the telephone closet, 3rd floor).
- **System Contact:** Displays the textual identification of the contact person for this managed device, together with information on how to contact this person.
- **Trap Manager IP:** Displays the IP address of the host to receive the traps.

You are suggested to keep the default settings. Click [Save](#) to make the settings effective.

# Appendix: Troubleshooting

## T1. How do I reset my modem router to its factory default settings?

With the modem router powered on, press and hold down the Reset button on the modem router for 5 seconds until all LEDs turn on momentarily, then release the button.

**Note:** Once the modem router is reset, the current configuration settings will be lost and you will need to re-configure the modem router.

## T2. What should I do if I forgot my password?

### Web management page password:

- If you are using a TP-Link ID to log in, click [Forgot password](#) on the login page and then follow the instructions to reset the password.
- Alternatively, refer to T1 to reset the router, and then visit <http://tplinkmodem.net> to create a new login password.

### Wireless network password:

1. The default Wireless Password/PIN is printed on the product label of the modem router.
2. If the default wireless password has been changed, log in to the modem router's web management page and go to [Basic > Wireless](#) to retrieve or reset your password.

## T3. What should I do if I cannot log in to the modem router's web management page?

- Make sure the modem router connects to the computer correctly and the corresponding LED indicator(s) light up.
- Make sure the IP address of your computer is configured to obtain an IP address automatically and obtain the DNS server address automatically.
- Make sure the default access you input is right.
- Check your computer's settings:
  - 1) Go to [Start > Control Panel > Network and Internet](#), and click [View network status and tasks](#);
  - 2) Click [Internet Options](#) on the bottom left;
  - 3) Click [Connections](#), select [Never dial a connection](#);

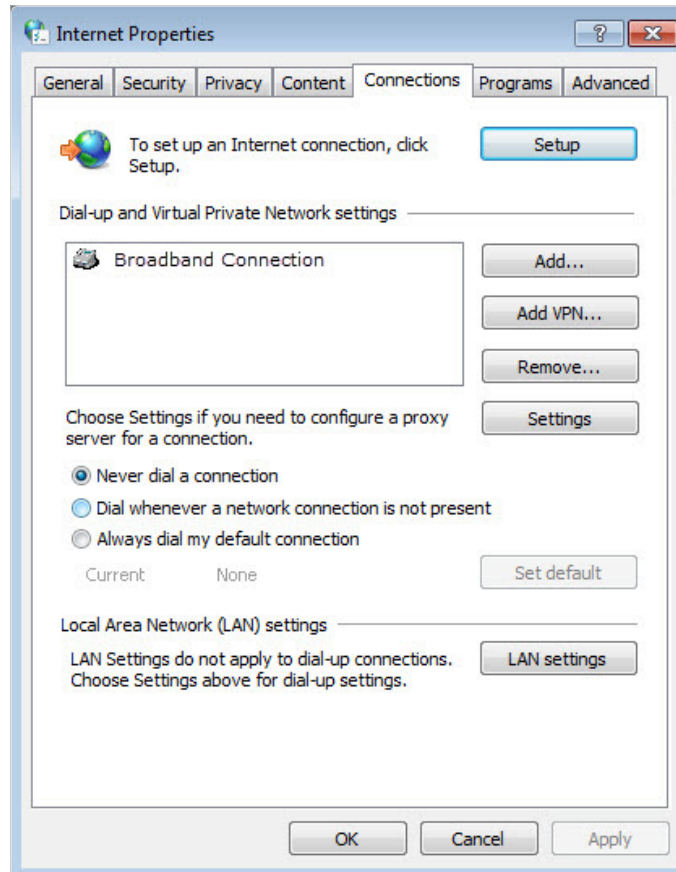

4) Click [LAN settings](#), deselect the following three options and click [OK](#);

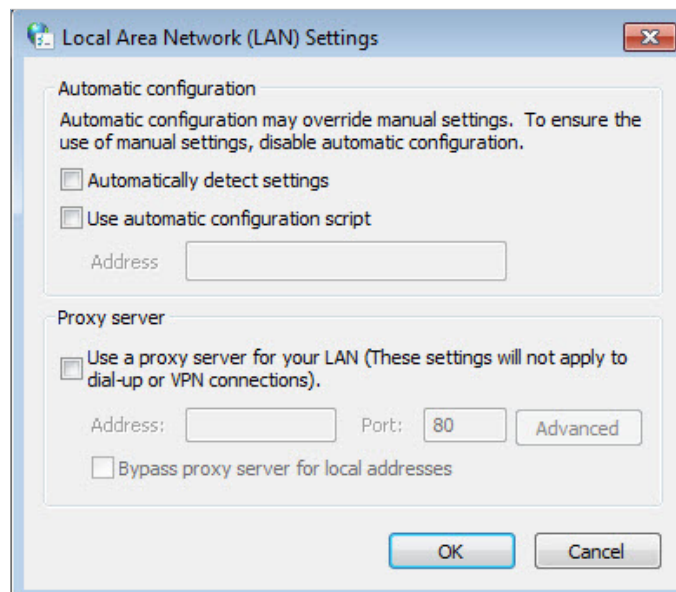

5) Go to [Advanced](#) > [Restore advanced settings](#), click [OK](#) to save the settings.

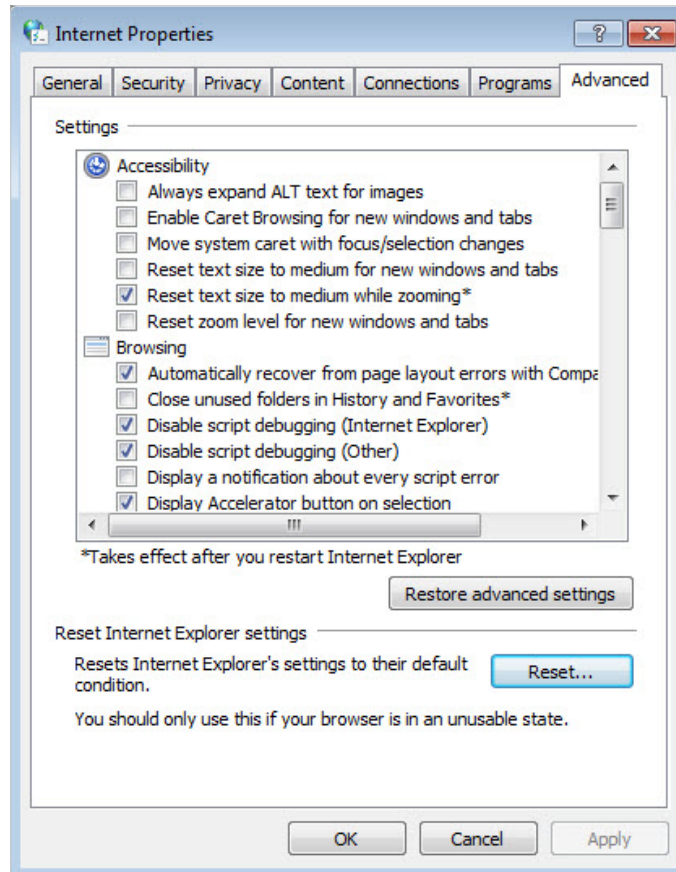

- Change a web browser or computer and log in again.
- Reset the modem router to factory default settings. Open a web browser and log in again. If login fails, please contact our Technical Support.

■ Note: You'll need to reconfigure the modem router to surf the internet once the modem router is reset.

#### T4. What should I do if I cannot access the internet?

1. Ensure all connections are secure, including telephone lines, Ethernet cables and power adapters.
2. Check to see if you can log in to the web management page of the modem router. If you cannot, please adjust your computer's settings according to [T3](#) and then see if you can access the internet. If the problem persists, please go to the next step.
3. Consult your ISP and make sure the VPI/VCI, Connection Type, account username and password are correct. If there are any mistakes, please correct the settings and try again.
4. Refer to [T5](#) to clone the MAC address.
5. If you still cannot access the internet, please restore your modem router to its factory default settings and reconfigure your modem router by following the instructions in [Use Quick Setup Wizard](#).

6. Please contact our Technical Support if the problem persists.

## T5. How do I clone a MAC address?

You can manually change the MAC address of the modem router. It is helpful when your internet access account provided by your ISP is bound to one specific MAC address, in other words, your ISP just permits only one computer with the authenticated MAC address to access the internet. In this case, you can use MAC Clone to allow more computers to access the internet via the same account.

1. Visit <http://tplinkmodem.net>, and log in with your TP-Link ID or the password you set for the modem router.
2. Go to **Advanced > Network > Internet** page. Click the **Add** icon, and scroll down to get the **MAC Clone** section.

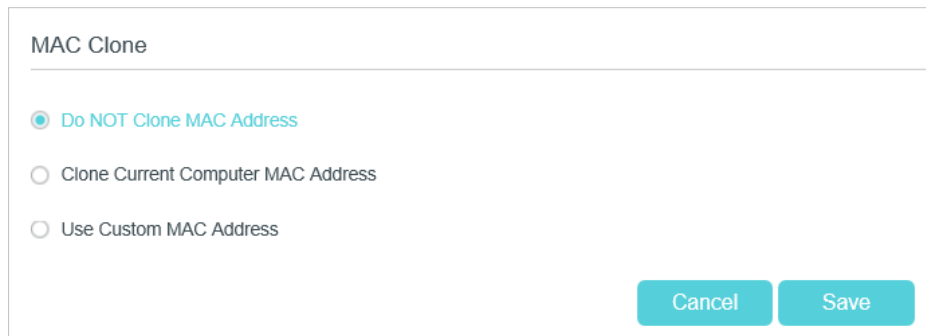

MAC Clone

Do NOT Clone MAC Address

Clone Current Computer MAC Address

Use Custom MAC Address

Cancel Save

- If you are using the computer with the authenticated MAC address to access the modem router, please select **Use Current Computer MAC Address**.
  - If you know the authenticated MAC address, please select **Use Custom MAC Address** and then enter the address.
3. Click **Save** to make the settings effective.

## T6. How can I change my computer's settings to obtain an IP address automatically?

To change the computer's network settings, follow the steps below.

- For MAC OS X:
  - 1) Click the Apple icon, and select **System Preferences** from the drop-down list.
  - 2) Click the Network icon.
  - 3) Select **Ethernet** (for wired connection) or **Wi-Fi** (for wireless connection) in the left panel, then click **Advanced**.
  - 4) Click **TCP/IP**.
  - 5) From the **Configure IPv4** drop-down list, select **Using DHCP**.

- 6) Click **OK**.
  - For Windows 7/8/8.1/10:
    - 1) Right-click the Network icon on the system tray and select [Open Network and Sharing Center](#) > [Change adapter settings](#).
    - 2) Right-click your network connection (wired or wireless) and select [Properties](#).
    - 3) Double-click [Internet Protocol Version 4 \(TCP/IPv4\)](#).
    - 4) Select both [Obtain an IP address automatically](#) and [Obtain DNS server address automatically](#), then click **OK**.
    - 5) Click **OK** again to save your configuration.
  - For Windows XP:
    - 1) Right-click the Network icon on the system tray and select [Open Network Connections](#).
    - 2) Right-click your network connection (wired or wireless) and select [Properties](#).
    - 3) Double-click [Internet Protocol \(TCP/IP\)](#).
    - 4) Select both [Obtain an IP address automatically](#) and [Obtain DNS server address automatically](#), then click **OK**.
    - 5) Click **OK** again to save your configuration.

## **T7. What should I do if I cannot find my wireless network or I cannot connect the wireless network?**

- **If you fail to find any wireless network, follow the steps below:**
  1. Make sure the wireless function is enabled if you're using a laptop with built-in wireless adapter. You can refer to the relevant document or contact the laptop manufacturer.
  2. Make sure the wireless adapter driver is installed successfully and the wireless adapter is enabled. You can refer to the relevant document or contact the wireless adapter manufacturer.
- **If you can find other wireless network except your own, follow the steps below:**
  1. Check the Wi-Fi LED indicator on your wireless router/modem;
  2. Make sure your computer/device is still in range of your router/modem. Move closer if you are currently too far away.
  3. Go to [Basic](#) > [Wireless](#) page, and check the wireless settings, double-check your Wireless Name (SSID) is not hidden.
  4. Connect to wireless network.

- If you can find your wireless network but fail to connect, follow the steps below:

1. Authentication problem: Network Security Key Mismatch.

- 1) Sometimes you will be asked to type in a PIN number when you connect to the wireless network for the first time. This PIN number is different from the Wireless Password/Network Security Key, usually you can only find it on the label of your modem router.



- 2) If you cannot find the PIN or PIN failed, you may choose "Connecting using a security key instead", and then type in the Network Security Key/Wireless Password;



- 3) If you continue to be told there is a network security key mismatch, it is suggested to check the wireless password on your modem router.

**Note:** Wireless password/Network Security Key is case sensitive.





- 4) Connect to wireless network.
2. Windows was unable to connect to XXXX /Cannot join this network/Taking longer than usual to connect to this network.
    - 1) Check the wireless signal strength of your network, if it is weak (1~3 bars), please move the router closer and try again;
    - 2) Change the wireless Channel of the router to 1,6,or 11 to reduce interference from other networks;
    - 3) Re-install or update the driver for your wireless adapter of the computer;
    - 4) Connect to wireless network.

## **COPYRIGHT & TRADEMARKS**

Specifications are subject to change without notice.  **tp-link** is a registered trademark of TP-Link Technologies Co., Ltd. Other brands and product names are trademarks or registered trademarks of their respective holders.

No part of the specifications may be reproduced in any form or by any means or used to make any derivative such as translation, transformation, or adaptation without permission from TP-Link Technologies Co., Ltd. Copyright © 2020 TP-Link Technologies Co., Ltd. All rights reserved.

## CE Mark Warning



This is a class B product. In a domestic environment, this product may cause radio interference, in which case the user may be required to take adequate measures.

## **OPERATING FREQUENCY(the maximum transmitted power)**

2400 MHz -2483.5 MHz(20dBm)

## **RF Exposure Information**

This device meets the EU requirements (2014/53/EU Article 3.1a) on the limitation of exposure of the general public to electromagnetic fields by way of health protection.









The device complies with RF specifications when the device used at 20 cm from your body.

TP-Link hereby declares that the device is in compliance with the essential requirements and other relevant provisions of directives 2014/53/EU, 2009/125/EC, 2011/65/EU and (EU)2015/863.

## **Safety Information**

- Keep the device away from water, fire, humidity or hot environments.
- Do not attempt to disassemble, repair, or modify the device. If you need service, please contact us.
- Do not use damaged charger or USB cable to charge the device.
- Do not use any other chargers than those recommended.
- Do not use the device where wireless devices are not allowed.
- Adapter shall be installed near the equipment and shall be easily accessible.
- Use only power supplies which are provided by manufacturer and in the original packing of this product. If you have any questions, please don't hesitate to contact us.

## Explanation of the symbols on the product label

Symbol	Explanation
	Direct current
	AC voltage
	<p>RECYCLING</p> <p>This product bears the selective sorting symbol for Waste electrical and electronic equipment (WEEE). This means that this product must be handled pursuant to European directive 2012/19/EU in order to be recycled or dismantled to minimize its impact on the environment.</p> <p>User has the choice to give his product to a competent recycling organization or to the retailer when he buys a new electrical or electronic equipment.</p>
	Class II equipment
	Energy efficiency Marking
	Indoor use only
	Caution
	Operator's manual
	Polarity of d.c. power connector