



# Alienware Aurora R8 Service Manual

# Notes, cautions, and warnings

---

-  **NOTE:** A NOTE indicates important information that helps you make better use of your product.
  -  **CAUTION:** A CAUTION indicates either potential damage to hardware or loss of data and tells you how to avoid the problem.
  -  **WARNING:** A WARNING indicates a potential for property damage, personal injury, or death.
-

# Contents

<b>Before working inside your computer</b> .....	<b>9</b>
Before you begin .....	9
<b>After working inside your computer</b> .....	<b>10</b>
<b>Safety instructions</b> .....	<b>11</b>
<b>Recommended tools</b> .....	<b>12</b>
<b>Inside view of your computer</b> .....	<b>13</b>
<b>System-board components</b> .....	<b>14</b>
<b>Screw list</b> .....	<b>15</b>
<b>Removing the stability foot</b> .....	<b>17</b>
Procedure.....	17
<b>Replacing the stability foot</b> .....	<b>18</b>
Procedure.....	18
<b>Removing the left-side cover</b> .....	<b>19</b>
Procedure.....	19
<b>Replacing the left-side cover</b> .....	<b>20</b>
Procedure.....	20
<b>Removing the right-side cover</b> .....	<b>22</b>
Procedure.....	22
<b>Replacing the right-side cover</b> .....	<b>24</b>
Procedure.....	24
<b>Removing the top-cover assembly</b> .....	<b>26</b>
Prerequisites.....	26
Procedure.....	26
<b>Replacing the top-cover assembly</b> .....	<b>29</b>
Procedure.....	29
Post-requisites.....	31

<b>Removing the bottom cover.....</b>	<b>32</b>
Prerequisites.....	32
Procedure.....	32
<b>Replacing the bottom cover.....</b>	<b>34</b>
Procedure.....	34
Post-requisites.....	34
<b>Removing the 3.5-inch hard drive.....</b>	<b>35</b>
Prerequisites.....	35
Procedure.....	35
<b>Replacing the 3.5-inch hard drive.....</b>	<b>37</b>
Procedure.....	37
Post-requisites.....	38
<b>Removing the 2.5-inch hard drive.....</b>	<b>39</b>
Procedure.....	39
Prerequisites.....	40
<b>Replacing the 2.5-inch hard drive.....</b>	<b>41</b>
Procedure.....	41
Post-requisites.....	42
<b>Removing the hard-drive cage.....</b>	<b>43</b>
Prerequisites.....	43
Procedure.....	43
<b>Replacing the hard-drive cage.....</b>	<b>44</b>
Procedure.....	44
Post-requisites.....	44
<b>Removing the power-supply unit.....</b>	<b>45</b>
Prerequisites.....	45
Procedure.....	45
<b>Replacing the power-supply unit.....</b>	<b>49</b>
Procedure.....	49
Post-requisites.....	52
<b>Removing the processor-cooling assembly.....</b>	<b>53</b>
Prerequisites.....	53
Procedure.....	53



<b>Replacing the processor-cooling assembly.....</b>	<b>55</b>
Procedure.....	55
Post-requisites.....	56
<b>Removing the coin-cell battery.....</b>	<b>57</b>
Prerequisites.....	57
Procedure.....	57
<b>Replacing the coin-cell battery.....</b>	<b>58</b>
Procedure.....	58
Post-requisites.....	58
<b>Removing the memory modules.....</b>	<b>59</b>
Prerequisites.....	59
Procedure.....	59
<b>Replacing the memory modules.....</b>	<b>60</b>
Procedure.....	60
Post-requisites.....	61
<b>Removing the solid-state drive.....</b>	<b>62</b>
Prerequisites.....	62
Procedure.....	62
<b>Replacing the solid-state drive.....</b>	<b>63</b>
Procedure.....	63
Post-requisites.....	63
<b>Removing the graphics card.....</b>	<b>64</b>
Prerequisites.....	64
Procedure.....	64
<b>Replacing the graphics card.....</b>	<b>66</b>
Procedure.....	66
Post-requisites.....	67
<b>Removing the VR heat sink.....</b>	<b>68</b>
Prerequisites.....	68
Procedure.....	68
<b>Replacing the VR heat sink.....</b>	<b>69</b>
Procedure.....	69
Post-requisites.....	69

<b>Removing the processor fan and heat-sink assembly.....</b>	<b>70</b>
Prerequisites.....	70
Procedure.....	70
<b>Replacing the processor fan and heat-sink assembly.....</b>	<b>71</b>
Procedure.....	71
Post-requisites.....	71
<b>Removing the processor.....</b>	<b>72</b>
Prerequisites.....	72
Procedure.....	72
<b>Replacing the processor.....</b>	<b>73</b>
Procedure.....	73
Post-requisites.....	73
<b>Removing the wireless card.....</b>	<b>74</b>
Prerequisites.....	74
Procedure.....	74
<b>Replacing the wireless card.....</b>	<b>75</b>
Procedure.....	75
Post-requisites.....	75
<b>Removing the antennas.....</b>	<b>76</b>
Prerequisites.....	76
Procedure.....	76
<b>Replacing the antennas.....</b>	<b>78</b>
Procedure.....	78
Post-requisites.....	79
<b>Removing the front-chassis fan.....</b>	<b>80</b>
Prerequisites.....	80
Procedure.....	80
<b>Replacing the front-chassis fan.....</b>	<b>82</b>
Procedure.....	82
Post-requisites.....	83
<b>Removing the top-chassis fan.....</b>	<b>84</b>
Prerequisites.....	84
Procedure.....	84

<b>Replacing the top-chassis fan.....</b>	<b>86</b>
Procedure.....	86
Post-requisites.....	87
<b>Removing the optical drive.....</b>	<b>88</b>
Prerequisites.....	88
Procedure.....	88
<b>Replacing the optical drive.....</b>	<b>90</b>
Procedure.....	90
Post-requisites.....	91
<b>Removing the front bezel .....</b>	<b>92</b>
Prerequisites.....	92
Procedure.....	92
<b>Replacing the front bezel.....</b>	<b>94</b>
Procedure.....	94
Post-requisites.....	94
<b>Removing the power-button board.....</b>	<b>95</b>
Prerequisites.....	95
Procedure.....	95
<b>Replacing the power-button board.....</b>	<b>96</b>
Procedure.....	96
Post-requisites.....	96
<b>Removing the rear trim cover.....</b>	<b>97</b>
Prerequisites.....	97
Procedure.....	97
<b>Replacing the rear trim cover.....</b>	<b>98</b>
Procedure.....	98
Post-requisites.....	98
<b>Removing the system board.....</b>	<b>99</b>
Prerequisites.....	99
Procedure.....	99
<b>Replacing the system board.....</b>	<b>101</b>
Procedure.....	101
Post-requisites.....	102
Entering the Service Tag in the BIOS setup program.....	102

<b>System setup.....</b>	<b>103</b>
Boot Sequence.....	103
Navigation keys.....	103
BIOS overview.....	103
Entering BIOS setup program.....	104
System setup options.....	104
Clearing CMOS Settings.....	107
Procedure.....	107
Clearing forgotten passwords.....	108
Procedure.....	108
Flashing the BIOS.....	108
<b>Troubleshooting.....</b>	<b>110</b>
Enhanced Pre-Boot System Assessment (ePSA) diagnostics.....	110
Running the ePSA Diagnostics.....	110
System diagnostic lights.....	110
Flashing BIOS (USB key).....	111
Flashing the BIOS.....	111
Backup media and recovery options.....	111
Wi-Fi power cycle.....	112
Flea power release.....	112
<b>Getting help and contacting Dell.....</b>	<b>113</b>
Self-help resources.....	113
Contacting Dell.....	113

# Before working inside your computer

---

 **NOTE:** The images in this document may differ from your computer depending on the configuration you ordered.

## Before you begin

- 1 Save and close all open files and exit all open applications.
- 2 Shut down your computer. Click **Start** →  **Power** → **Shut down**.

 **NOTE:** If you are using a different operating system, see the documentation of your operating system for shut-down instructions.

- 3 Disconnect your computer and all attached devices from their electrical outlets.
- 4 Disconnect all attached network devices and peripherals, such as keyboard, mouse, and monitor from your computer.
- 5 Remove any media card and optical disc from your computer, if applicable.
- 6 After the computer is unplugged, press and hold the power button for 5 seconds to ground the system board.

# After working inside your computer

---









 **CAUTION: Leaving stray or loose screws inside your computer may severely damage your computer.**

- 1 Replace all screws and ensure that no stray screws remain inside your computer.
- 2 Connect any external devices, peripherals, or cables you removed before working on your computer.
- 3 Replace any media cards, discs, or any other parts that you removed before working on your computer.
- 4 Connect your computer and all attached devices to their electrical outlets.
- 5 Turn on your computer.

# Safety instructions

---

Use the following safety guidelines to protect your computer from potential damage and ensure your personal safety.

-  **WARNING:** Before working inside your computer, read the safety information that shipped with your computer. For more safety best practices, see the Regulatory Compliance home page at [www.dell.com/regulatory\\_compliance](http://www.dell.com/regulatory_compliance).
-  **WARNING:** Disconnect all power sources before opening the computer cover or panels. After you finish working inside the computer, replace all covers, panels, and screws before connecting to the electrical outlet.
-  **CAUTION:** To avoid damaging the computer, ensure that the work surface is flat and clean.
-  **CAUTION:** To avoid damaging the components and cards, handle them by their edges, and avoid touching pins and contacts.
-  **CAUTION:** You should only perform troubleshooting and repairs as authorized or directed by the Dell technical assistance team. Damage due to servicing that is not authorized by Dell is not covered by your warranty. See the safety instructions that shipped with the product or at [www.dell.com/regulatory\\_compliance](http://www.dell.com/regulatory_compliance).
-  **CAUTION:** Before touching anything inside your computer, ground yourself by touching an unpainted metal surface, such as the metal at the back of the computer. While you work, periodically touch an unpainted metal surface to dissipate static electricity, which could harm internal components.
-  **CAUTION:** When you disconnect a cable, pull on its connector or on its pull tab, not on the cable itself. Some cables have connectors with locking tabs or thumb-screws that you must disengage before disconnecting the cable. When disconnecting cables, keep them evenly aligned to avoid bending any connector pins. When connecting cables, ensure that the ports and connectors are correctly oriented and aligned.
-  **CAUTION:** Press and eject any installed card from the media-card reader.

# Recommended tools

---

The procedures in this document may require the following tools:

- Philips screwdriver #1
- Flat-head screwdriver
- Plastic scribe



# Inside view of your computer

---

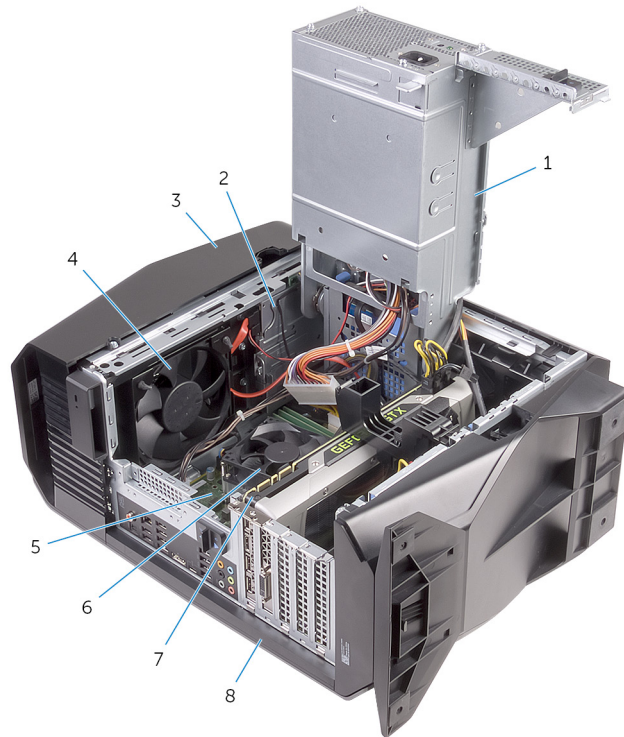

- 1 power-supply unit
- 3 top cover
- 5 system board
- 7 graphics card

- 2 optical-drive assembly
- 4 top-chassis fan
- 6 processor fan and heat-sink assembly
- 8 right-side cover



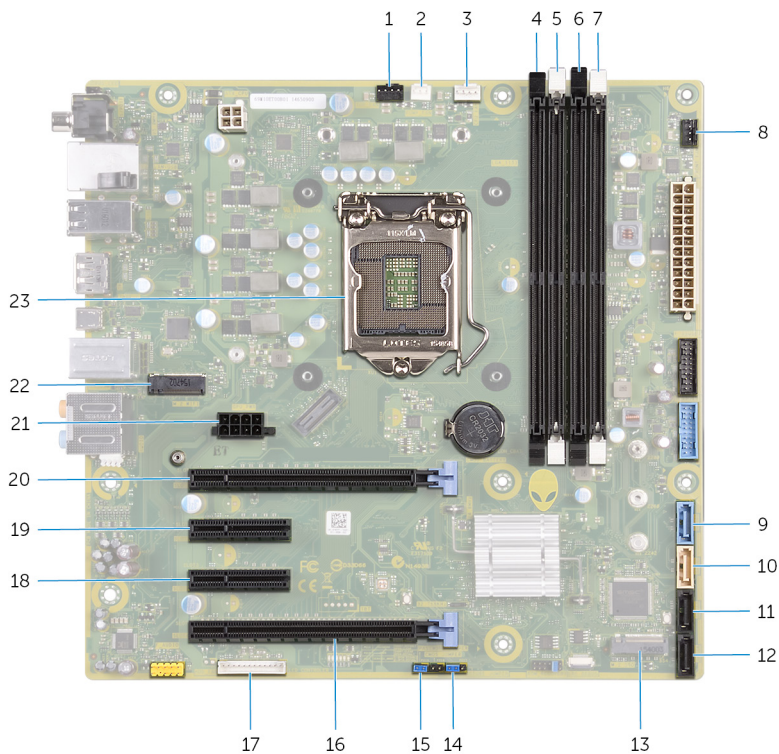











# System-board components









- |    |   |    |  |
|----|---|----|--|
| 1  | top-chassis fan (TOP_FAN)                 | 2  | processor-cooling assembly pump-fan connector (PUMP_FAN) |
| 3  | processor-fan connector (CPU_FAN)         | 4  | memory-module slot 1 (XMM1)                              |
| 5  | memory-module slot 2 (XMM2)               | 6  | memory-module slot 3 (XMM3)                              |
| 7  | memory-module slot 4 (XMM4)               | 8  | front-chassis fan connector (FRONT_FAN)                  |
| 9  | SATA 6 Gbps drive connector (SATA1)       | 10 | SATA 6 Gbps drive connector (SATA2)                      |
| 11 | SATA 6 Gbps drive connector (SATA3)       | 12 | SATA 6 Gbps drive connector (SATA4)                      |
| 13 | solid-state drive slot (M.2 SSD)          | 14 | CMOS reset jumper (CMOS JUMPER)                          |
| 15 | Password reset jumper (PASSWORD JUMPER)   | 16 | PCI-Express x16 mechanical/x8 electrical slot (SLOT4)    |
| 17 | LED controller connector (LED_CONTROLLER) | 18 | PCI-Express x4 slot (SLOT3)                              |
| 19 | PCI-Express x4 slot (SLOT2)               | 20 | PCI-Express x16 mechanical/x8 electrical slot (SLOT1)    |
| 21 | graphics-card power connector (GPU_POWER) | 22 | wireless-card slot (M.2 WIFI)                            |
| 23 | processor socket (CPU1)                   |    |  |

# Screw list

 **NOTE: Screw color may vary with the configuration ordered.**

Component	Secured to	Screw type	Quantity	Screw image
3.5-inch hard-drive cage	Chassis	#6-32 X 1/4"	2	
2.5-inch hard-drive cage	Chassis	#6-32 X 1/4"	4	
Power-supply unit hinge	Chassis	#6-32 X 1/4"	6	
		#6-32 X 1/4" BLK	3	
Power-supply unit	Power-supply unit hinge	#6-32 X 1/4"	4	
Power-supply unit bracket		#6-32 X 1/4"	2	
Optical-drive assembly	Chassis	#6-32 X 1/4"	2	
System board	Chassis	#6-32 X 1/4"	8	
Top cover	Chassis	#6-32 X 1/4"	2	
Top I/O assembly	Chassis	#6-32 X 1/4" BLK	4	
Processor-cooling assembly bracket	Chassis	#6-32 X 1/4" BLK	2	
Processor-cooling assembly radiator	Processor-cooling assembly bracket	#6-32 X 1/4" BLK	4	
Top-chassis fan assembly	Chassis	#6-32 X 1/4"	1	
Top-chassis fan bracket	Chassis	#6-32 X 1/4" BLK	1	
Antenna assembly	Chassis	#6-32 X 1/4"	2	

<b>Component</b>	<b>Secured to</b>	<b>Screw type</b>	<b>Quantity</b>	<b>Screw image</b>
Power-button board	Top cover	M3 X 4	2	
Rubber foot	Bottom cover	M3 X 4	4	
M.2 SSD card	System board	Standoff M2	1	
		M2 X 2.5	1	
Optical-drive bracket	Optical drive	M2 X 2.5	1	
WLAN bracket	System board	M2 X 2.5	1	

# Removing the stability foot

---

**⚠ WARNING:** Before working inside your computer, read the safety information that shipped with your computer and follow the steps in [Before working inside your computer](#). After working inside your computer, follow the instructions in [After working inside your computer](#). For more safety best practices, see the Regulatory Compliance home page at [www.dell.com/regulatory\\_compliance](http://www.dell.com/regulatory_compliance).

## Procedure

- 1 Place the computer on a clean and flat surface with the bottom cover facing up.
- 2 Pull the securing tab to release the stability foot from the slots on the bottom cover.
- 3 Lift the stability foot off the bottom cover.

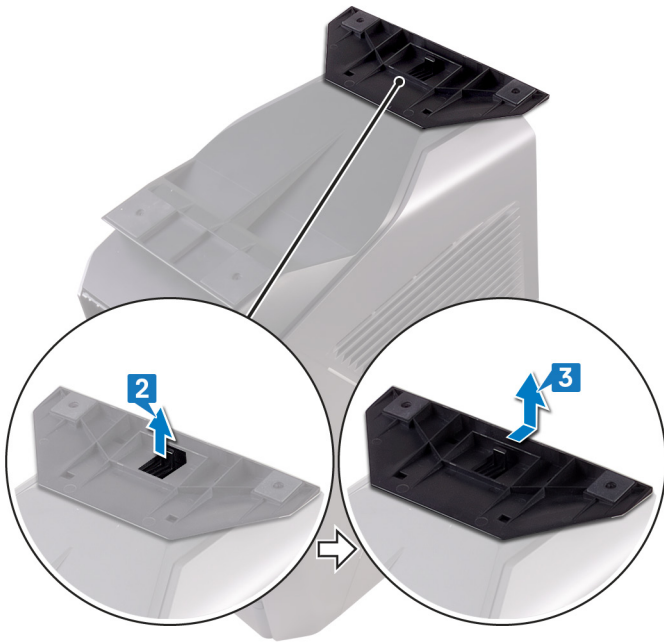

- 4 Lay the computer on its side.

# Replacing the stability foot

---

**⚠ WARNING:** Before working inside your computer, read the safety information that shipped with your computer and follow the steps in [Before working inside your computer](#). After working inside your computer, follow the instructions in [After working inside your computer](#). For more safety best practices, see the Regulatory Compliance home page at [www.dell.com/regulatory\\_compliance](http://www.dell.com/regulatory_compliance).

## Procedure

- 1 Place the computer on a clean and flat surface with the bottom cover facing up.
- 2 Align the tabs on the stability foot with the slots on the bottom cover and snap the stability foot to lock it in place.

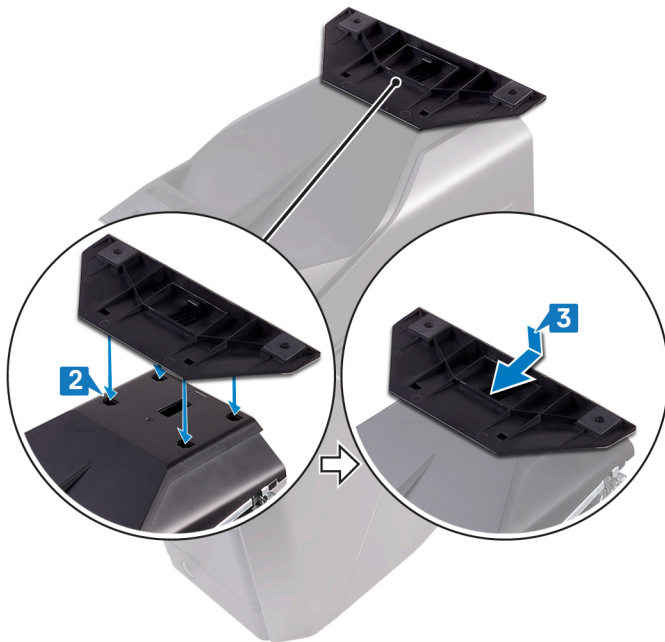

- 3 Turn the computer over and place it in upright position.

# Removing the left-side cover

---

**WARNING:** Before working inside your computer, read the safety information that shipped with your computer and follow the steps in [Before working inside your computer](#). After working inside your computer, follow the instructions in [After working inside your computer](#). For more safety best practices, see the Regulatory Compliance home page at [www.dell.com/regulatory\\_compliance](http://www.dell.com/regulatory_compliance).

## Procedure

**NOTE:** Ensure that you remove the security cable and security screw from the security-cable slot (if applicable).

- 1 Remove the screw (#6-32 X 1/4" BLK) that secures the side-panel release latch to the chassis.
- 2 Pull the side-panel release latch.
- 3 Release the left-side cover away from the chassis and then lift it from the computer.



# Replacing the left-side cover

---

**WARNING:** Before working inside your computer, read the safety information that shipped with your computer and follow the steps in [Before working inside your computer](#). After working inside your computer, follow the instructions in [After working inside your computer](#). For more safety best practices, see the Regulatory Compliance home page at [www.dell.com/regulatory\\_compliance](http://www.dell.com/regulatory_compliance).

## Procedure

- 1 Align the tabs on the left-side cover with the slots on the chassis.
- 2 Rotate the left-side cover towards the chassis until it snaps into place.

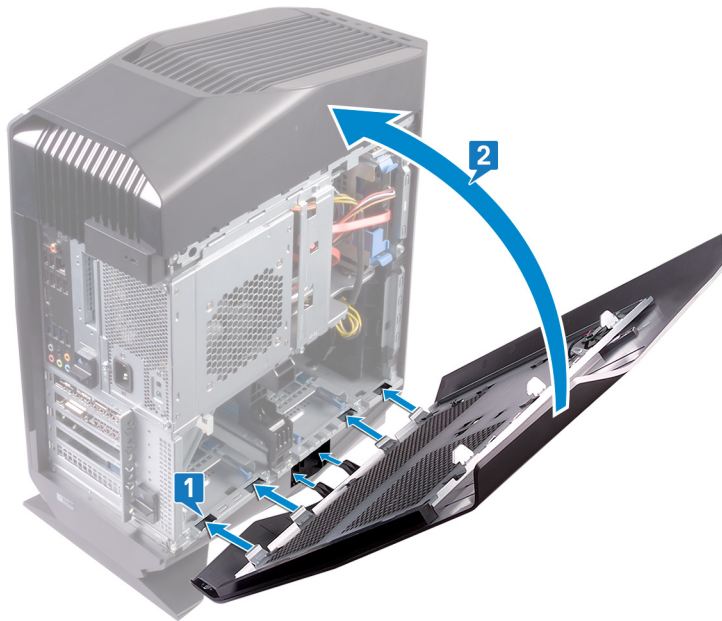



- 3 Replace the screw (#6-32 X 1/4" BLK) that secures the side-panel release latch to the chassis.



# Removing the right-side cover

---

**WARNING:** Before working inside your computer, read the safety information that shipped with your computer and follow the steps in [Before working inside your computer](#). After working inside your computer, follow the instructions in [After working inside your computer](#). For more safety best practices, see the Regulatory Compliance home page at [www.dell.com/regulatory\\_compliance](http://www.dell.com/regulatory_compliance).

## Procedure

- 1 Carefully pry around the edges of the right-side cover from the chassis.

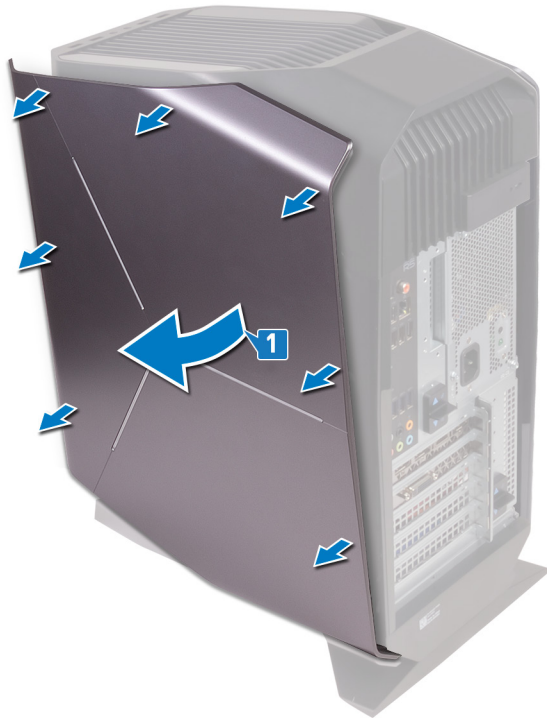

- 2 Disconnect the lighting cable from the right-side cover.

3 Lift the right-side cover off the chassis.



# Replacing the right-side cover

**WARNING:** Before working inside your computer, read the safety information that shipped with your computer and follow the steps in [Before working inside your computer](#). After working inside your computer, follow the instructions in [After working inside your computer](#). For more safety best practices, see the Regulatory Compliance home page at [www.dell.com/regulatory\\_compliance](http://www.dell.com/regulatory_compliance).

## Procedure

- 1 Connect the lighting cable to the right-side cover.
- 2 Align the tabs on the right-side cover with the slots on the chassis

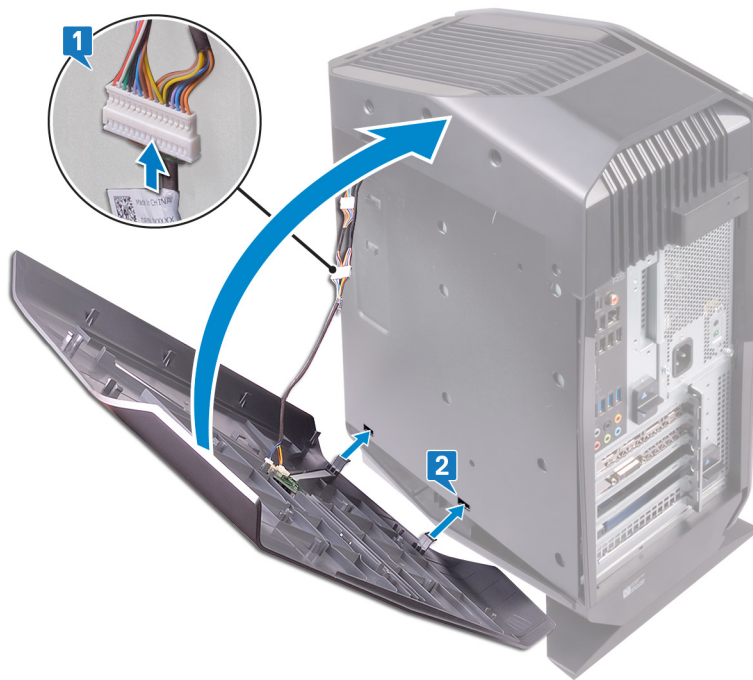

3 Rotate the right-side cover towards the chassis until it snaps into place.



# Removing the top-cover assembly

**WARNING:** Before working inside your computer, read the safety information that shipped with your computer and follow the steps in [Before working inside your computer](#). After working inside your computer, follow the instructions in [After working inside your computer](#). For more safety best practices, see the Regulatory Compliance home page at [www.dell.com/regulatory\\_compliance](http://www.dell.com/regulatory_compliance).

## Prerequisites

- 1 Remove the [left-side cover](#).
- 2 Remove the [right-side cover](#).

## Procedure

- 1 Remove the two screws (#6-32 X 1/4") that secure the top cover to the chassis.
- 2 Disconnect the lighting cable from the top cover.



- 3 Slide the lighting cable through the slot on the chassis.
- 4 Starting from the rear, release the tabs on the top cover from the slots on the chassis.

5 Lift the top cover off the chassis from the rear.



6 Turn the top cover over, release the tabs on the top cover from the slots on the top bezel.





7 Lift the top cover from the top bezel.

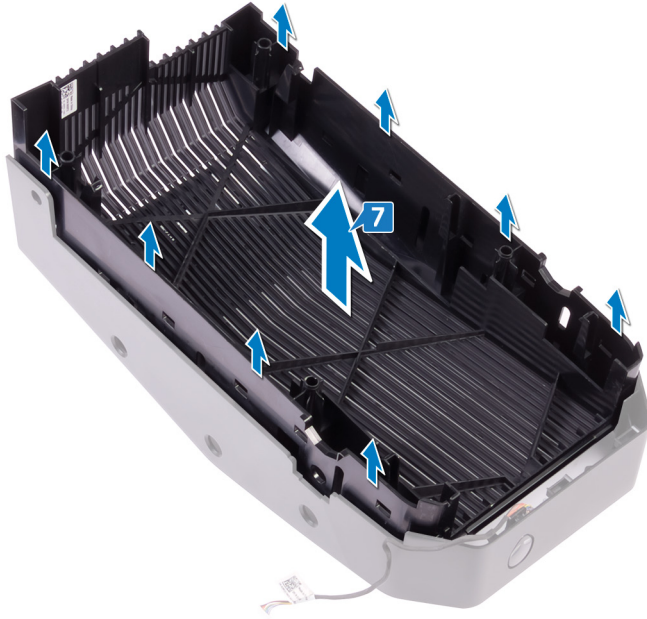

8 You are left with top bezel and top cover.





# Replacing the top-cover assembly

---

**⚠ WARNING:** Before working inside your computer, read the safety information that shipped with your computer and follow the steps in [Before working inside your computer](#). After working inside your computer, follow the instructions in [After working inside your computer](#). For more safety best practices, see the Regulatory Compliance home page at [www.dell.com/regulatory\\_compliance](http://www.dell.com/regulatory_compliance).

## Procedure

- 1 Align the tabs on the top cover with the slots on the top bezel and snap the top cover into place.

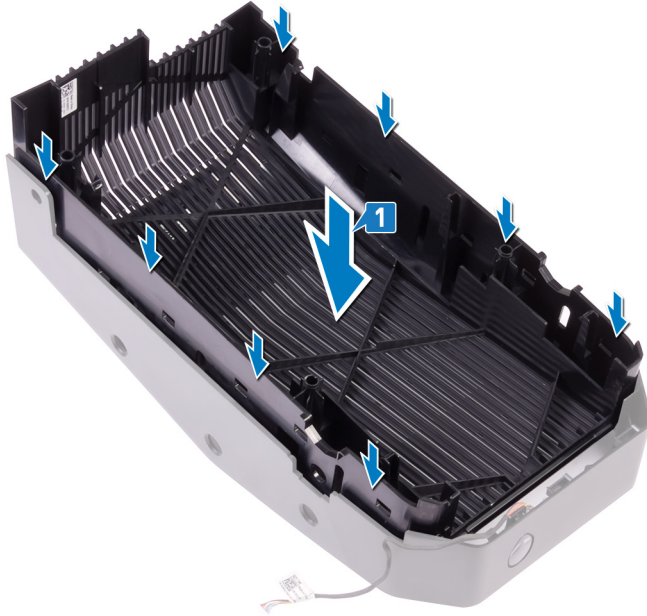

- 2 Slide the lighting cable through the slot on the chassis.

- 3 Align the tabs on the top cover with the slots on the chassis and snap the top cover into place.



- 4 Connect the lighting cable to the top cover.  
5 Replace the two screws (#6-32 X 1/4") that secure the top cover to the chassis.



## Post-requisites

- 1 Replace the [right-side cover](#).
- 2 Replace the [left-side cover](#).

# Removing the bottom cover

**WARNING:** Before working inside your computer, read the safety information that shipped with your computer and follow the steps in [Before working inside your computer](#). After working inside your computer, follow the instructions in [After working inside your computer](#). For more safety best practices, see the Regulatory Compliance home page at [www.dell.com/regulatory\\_compliance](http://www.dell.com/regulatory_compliance).

## Prerequisites

- 1 Remove the [left-side cover](#).
- 2 Remove the two 2.5-inch [hard-drive cages](#).

## Procedure

- 1 Place the computer on a clean and flat surface with the left side facing up.
- 2 Press the securing tabs to release the bottom cover from the slots on the chassis.

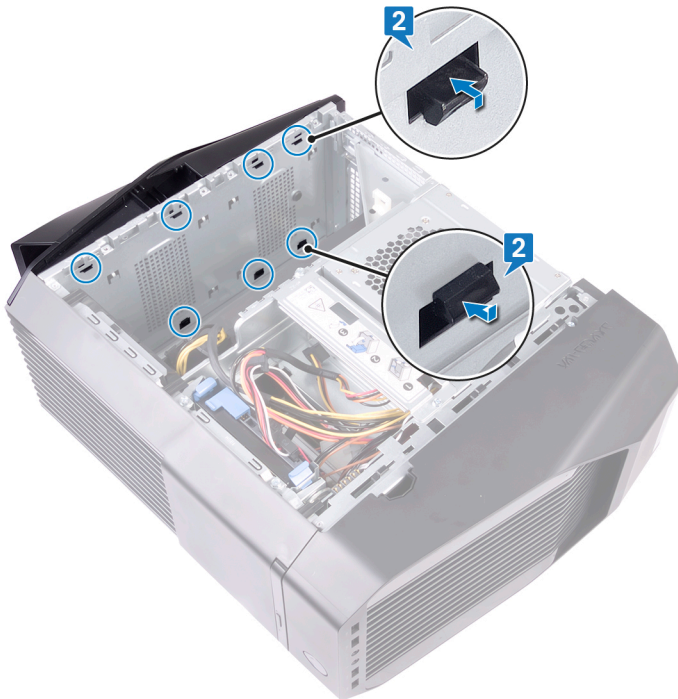

- 3 Turn the computer over until the base is facing up.

- 4 Lift the bottom cover from the chassis.



- 5 Turn the computer back to the upright position.

# Replacing the bottom cover

---

**⚠ WARNING:** Before working inside your computer, read the safety information that shipped with your computer and follow the steps in [Before working inside your computer](#). After working inside your computer, follow the instructions in [After working inside your computer](#). For more safety best practices, see the Regulatory Compliance home page at [www.dell.com/regulatory\\_compliance](http://www.dell.com/regulatory_compliance).

## Procedure

- 1 Turn the computer over until the base is facing up.
- 2 Align the tabs on the bottom cover with the slots on the chassis and snap the bottom cover in place.



- 3 Turn the computer over and place it in upright position.

## Post-requisites

- 1 Replace the two 2.5-inch [hard-drive cages](#).
- 2 Replace the [left-side cover](#).

# Removing the 3.5-inch hard drive

**WARNING:** Before working inside your computer, read the safety information that shipped with your computer and follow the steps in [Before working inside your computer](#). After working inside your computer, follow the instructions in [After working inside your computer](#). For more safety best practices, see the Regulatory Compliance home page at [www.dell.com/regulatory\\_compliance](http://www.dell.com/regulatory_compliance).

## Prerequisites

Remove the [left-side cover](#).

## Procedure

- 1 Disconnect the data and power cables from the hard drive.
- 2 Press the release tabs on the hard-drive carrier and slide the hard-drive carrier out of the hard-drive cage.

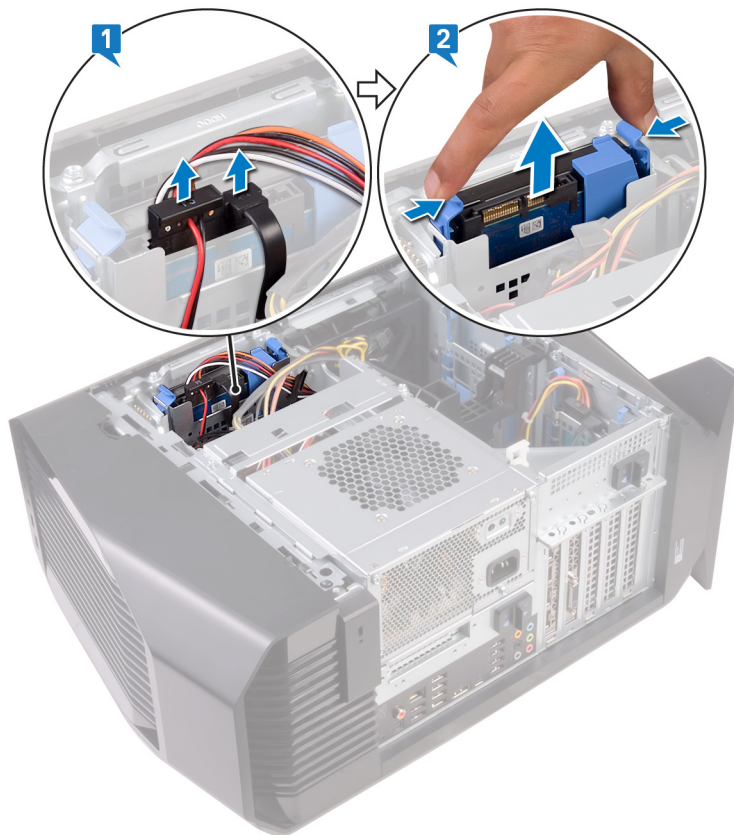

- 3 Pry the hard-drive carrier to release the tabs on the carrier from the slots on the hard drive.

- 4 Lift the hard drive off the hard-drive carrier.

 **NOTE:** Note the orientation of the hard drive so that you can replace it correctly.





# Replacing the 3.5-inch hard drive

---

**WARNING:** Before working inside your computer, read the safety information that shipped with your computer and follow the steps in [Before working inside your computer](#). After working inside your computer, follow the instructions in [After working inside your computer](#). For more safety best practices, see the Regulatory Compliance home page at [www.dell.com/regulatory\\_compliance](http://www.dell.com/regulatory_compliance).

## Procedure

- 1 Place the hard drive into the hard-drive carrier and align the tabs on the carrier with the slots on the hard drive.
- 2 Snap the hard-drive carrier into the hard drive.



- 3 Slide the hard-drive assembly into the hard-drive cage until it snaps into place.

- 4 Connect the data and power cables to the hard drive.

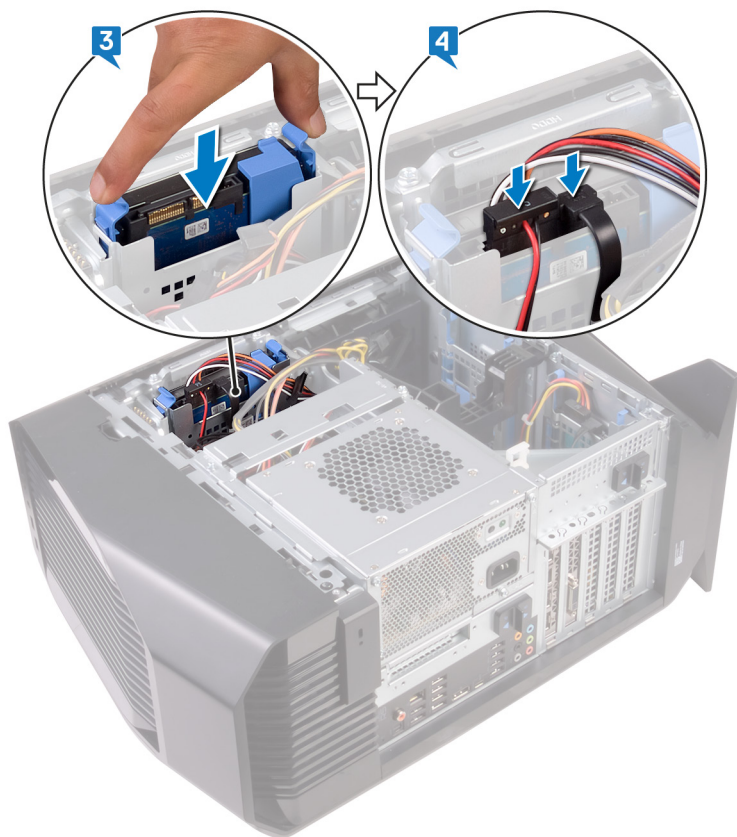

## Post-requisites

Replace the [left-side cover](#).

# Removing the 2.5-inch hard drive

**WARNING:** Before working inside your computer, read the safety information that shipped with your computer and follow the steps in [Before working inside your computer](#). After working inside your computer, follow the instructions in [After working inside your computer](#). For more safety best practices, see the Regulatory Compliance home page at [www.dell.com/regulatory\\_compliance](http://www.dell.com/regulatory_compliance).

## Procedure

- 1 Disconnect the data and power cables from the hard drive.
- 2 Press the release tabs on the hard-drive carrier and slide the hard-drive carrier out of the hard-drive cage.

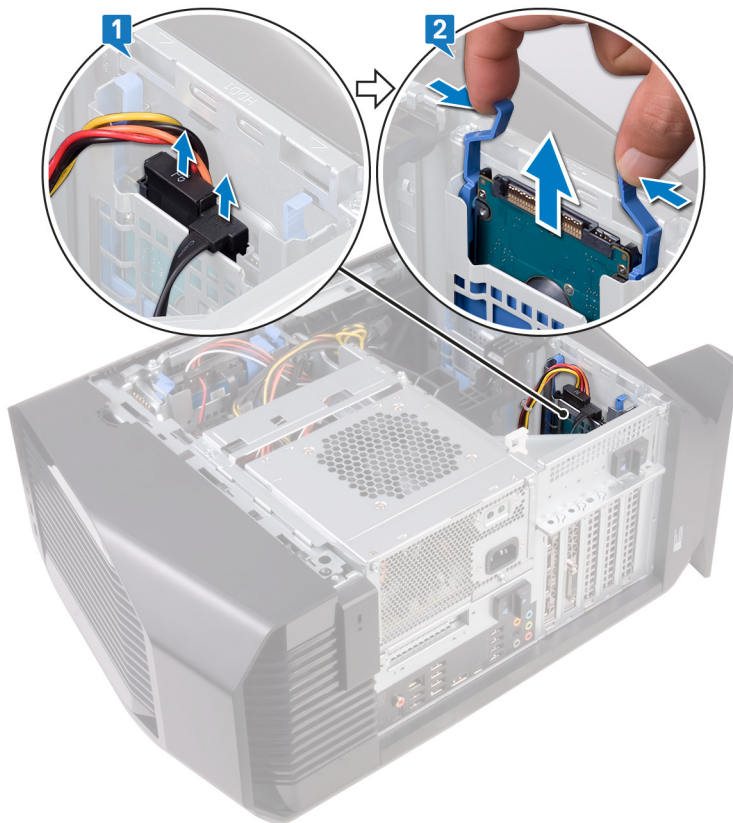

- 3 Pry the hard-drive carrier to release the tabs on the carrier from the slots on the hard drive.

- Lift the hard drive off the hard-drive carrier.

 **NOTE:** Note the orientation of the hard drive so that you can replace it correctly.



## Prerequisites

Remove the [left-side cover](#).

# Replacing the 2.5-inch hard drive

---

**WARNING:** Before working inside your computer, read the safety information that shipped with your computer and follow the steps in [Before working inside your computer](#). After working inside your computer, follow the instructions in [After working inside your computer](#). For more safety best practices, see the Regulatory Compliance home page at [www.dell.com/regulatory\\_compliance](http://www.dell.com/regulatory_compliance).

## Procedure

- 1 Place the hard drive into the hard-drive carrier and align the tabs on the carrier with the slots on the hard drive.
- 2 Snap the hard-drive carrier into the hard drive.



- 3 Slide the hard-drive assembly into the hard-drive cage until it snaps into place.

- 4 Connect the data cable and power cable to the hard drive.

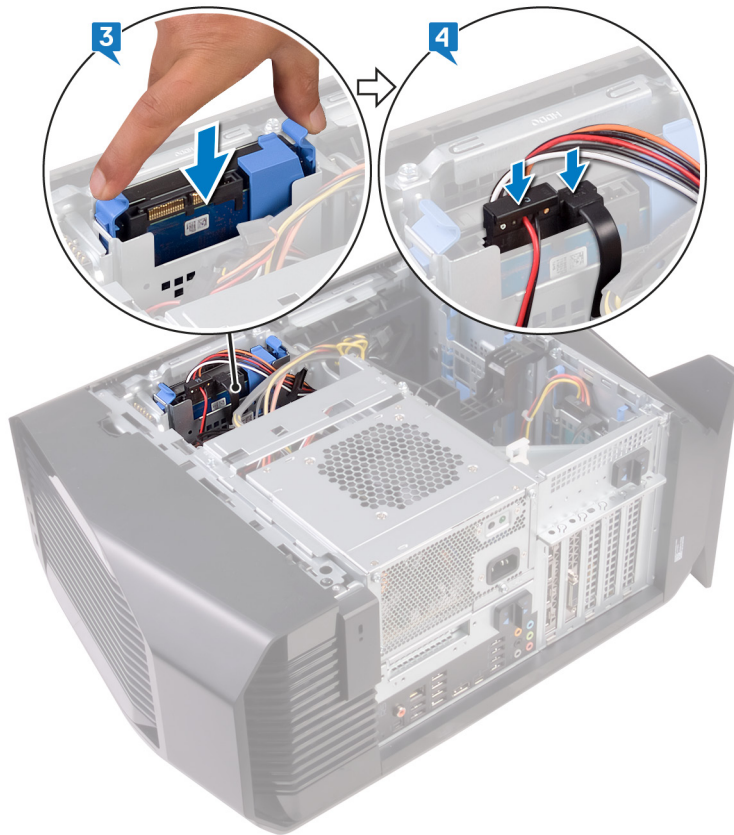

## Post-requisites

Replace the [left-side cover](#).

# Removing the hard-drive cage

---

**WARNING:** Before working inside your computer, read the safety information that shipped with your computer and follow the steps in [Before working inside your computer](#). After working inside your computer, follow the instructions in [After working inside your computer](#). For more safety best practices, see the Regulatory Compliance home page at [www.dell.com/regulatory\\_compliance](http://www.dell.com/regulatory_compliance).

## Prerequisites

- 1 Remove the [left-side cover](#).
- 2 Remove the [3.5-inch hard drive](#).

## Procedure

- 1 Remove the two screws (#6-32 X 1/4") that secure the hard-drive cage to the chassis.
- 2 Lift the hard-drive cage off the chassis.

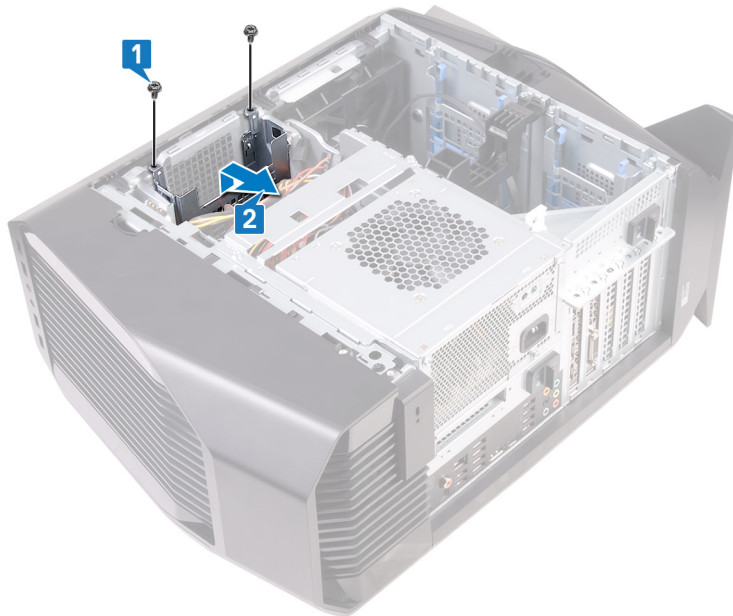

# Replacing the hard-drive cage

**WARNING:** Before working inside your computer, read the safety information that shipped with your computer and follow the steps in [Before working inside your computer](#). After working inside your computer, follow the instructions in [After working inside your computer](#). For more safety best practices, see the Regulatory Compliance home page at [www.dell.com/regulatory\\_compliance](http://www.dell.com/regulatory_compliance).

## Procedure

- 1 Insert the hard-drive cage into its slot on the chassis.
- 2 Align the tabs on the cage with the tabs on the chassis.
- 3 Replace the two screws (#6-32 X 1/4") that secure the hard-drive cage to the chassis.

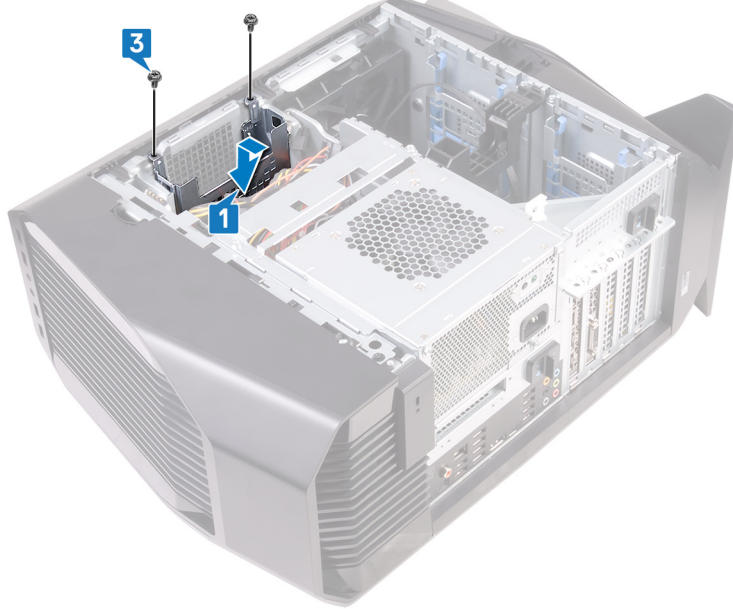

## Post-requisites

- 1 Replace the [3.5-inch hard drive](#).
- 2 Replace the [left-side cover](#).



# Removing the power-supply unit

**⚠ WARNING:** Before working inside your computer, read the safety information that shipped with your computer and follow the steps in [Before working inside your computer](#). After working inside your computer, follow the instructions in [After working inside your computer](#). For more safety best practices, see the Regulatory Compliance home page at [www.dell.com/regulatory\\_compliance](http://www.dell.com/regulatory_compliance).

## Prerequisites

- 1 Remove the [left-side cover](#).
- 2 Remove the [right-side cover](#).
- 3 Remove the [top cover](#).

## Procedure

**✎ NOTE:** Note the routing of all cables as you remove them so that you can reroute them correctly after you replace the power supply.

- 1 Lay the computer on the right side.
- 2 Slide the power-supply unit cage release latches to the unlock position.

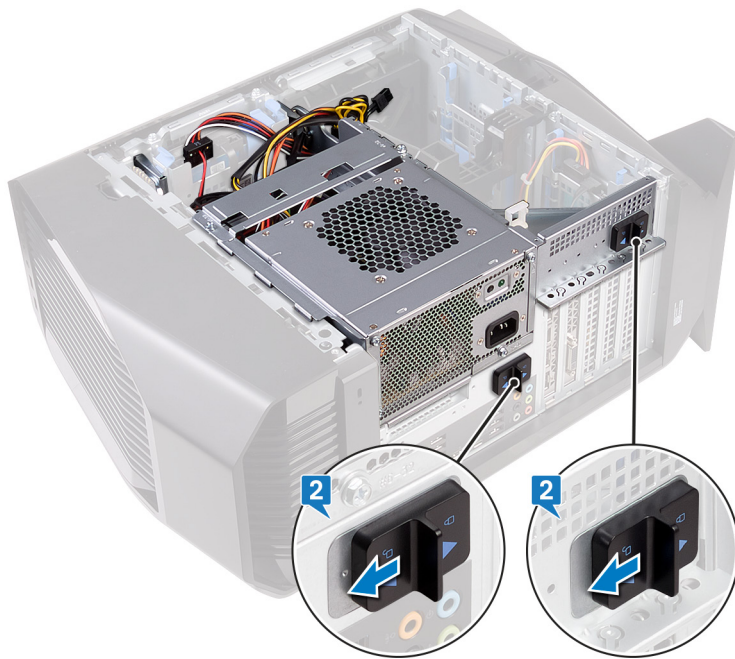

- 3 Lift the power-supply unit cage while pressing and holding the graphics-card bracket.



- 4 Rotate the power-supply unit cage away from the chassis.

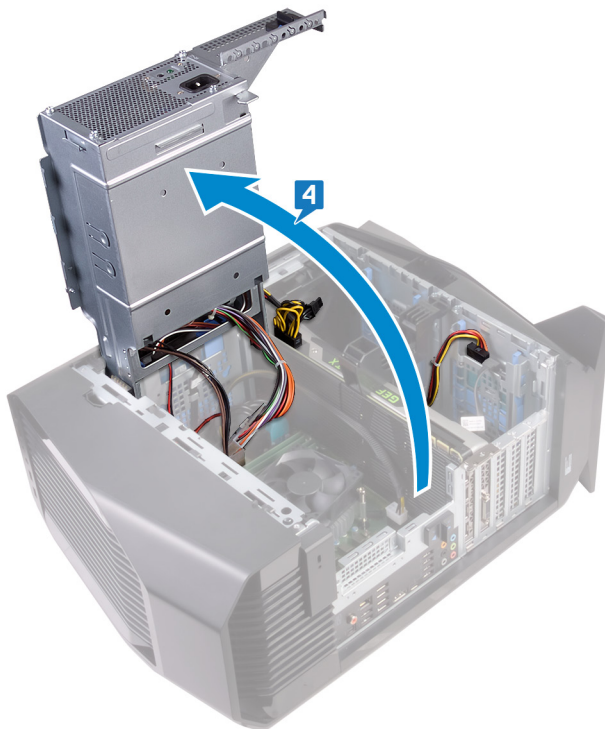

- 5 Press the releasing clip on the power-cable connectors and disconnect the power cables from the graphics card.
- 6 Disconnect the power cables from the optical drive and hard drives.

- 7 Disconnect the processor-power cable and system-board power cable from the system board.

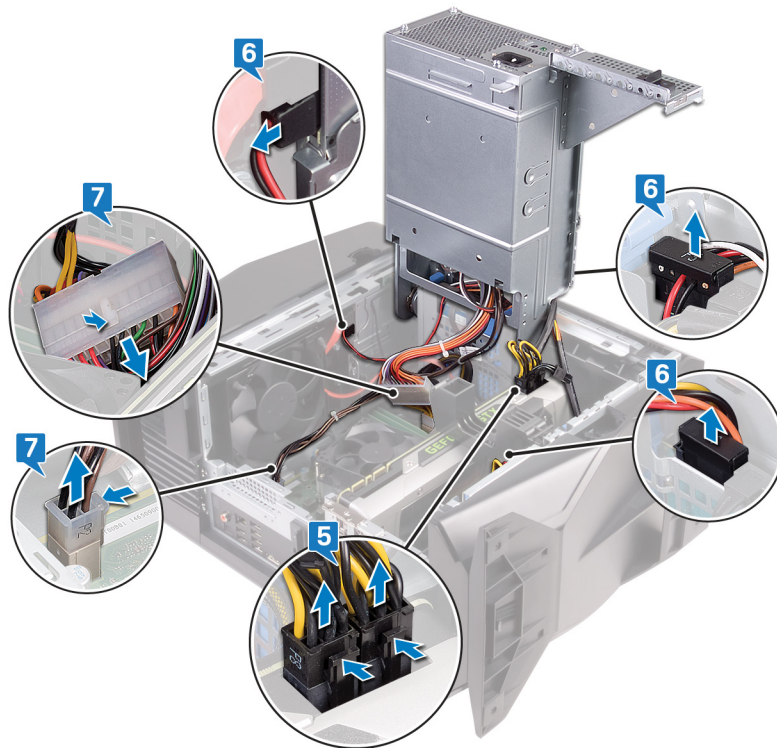

- 8 Rotate the power-supply unit cage towards the chassis until the unit snaps into place.
- 9 Remove the two screws (#6-32 X 1/4") that secure the power-supply unit bracket to the power-supply unit cage.
- 10 Lift the power-supply unit bracket off the power-supply unit cage.

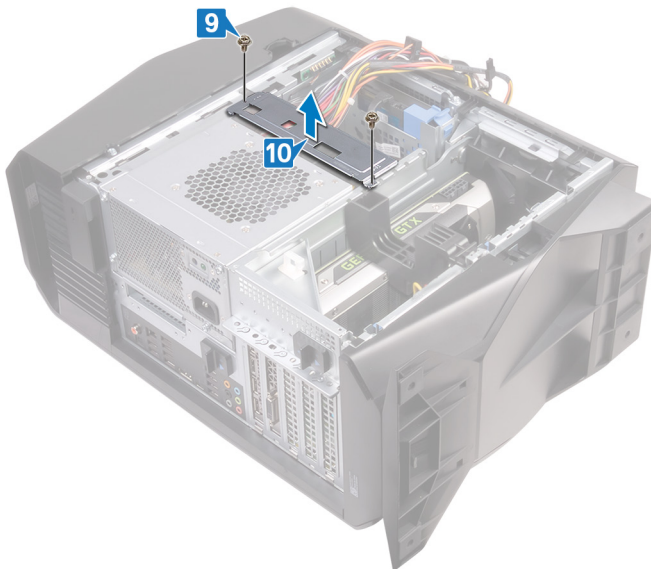

- 11 Remove the four screws (#6-32 X 1/4") that secure the power-supply unit to the chassis.

**12** Lift the power-supply unit, along with the cables, off the chassis.

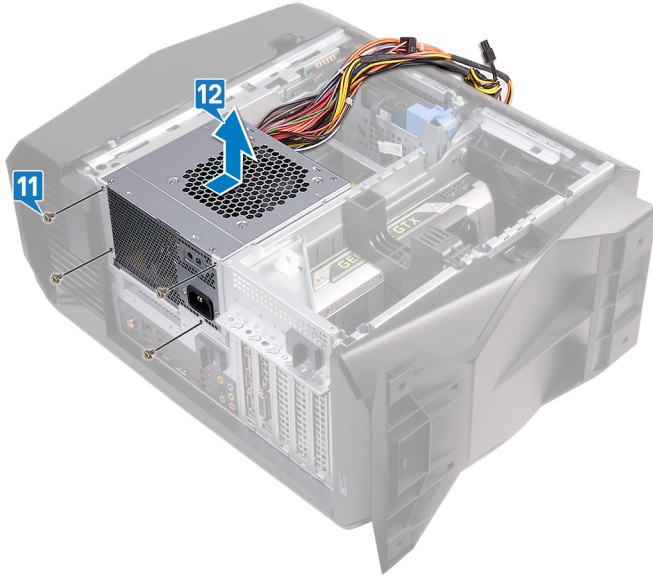

# Replacing the power-supply unit

**WARNING:** Before working inside your computer, read the safety information that shipped with your computer and follow the steps in [Before working inside your computer](#). After working inside your computer, follow the instructions in [After working inside your computer](#). For more safety best practices, see the Regulatory Compliance home page at [www.dell.com/regulatory\\_compliance](http://www.dell.com/regulatory_compliance).

## Procedure

- 1 Place the power supply on the chassis.
- 2 Align the screw holes on the power-supply unit with the screw holes on the chassis.
- 3 Replace the four screws (#6-32 X 1/4") that secure the power-supply unit to the chassis.

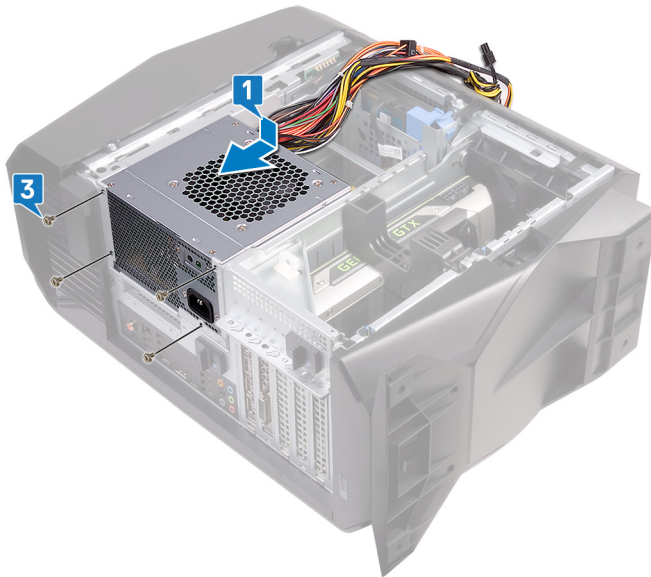

- 4 Align the screw holes on the power-supply unit bracket with the screw holes on the power-supply unit cage.
- 5 Replace the two screws (#6-32 X 1/4") that secure the power-supply unit bracket to the power-supply unit cage.

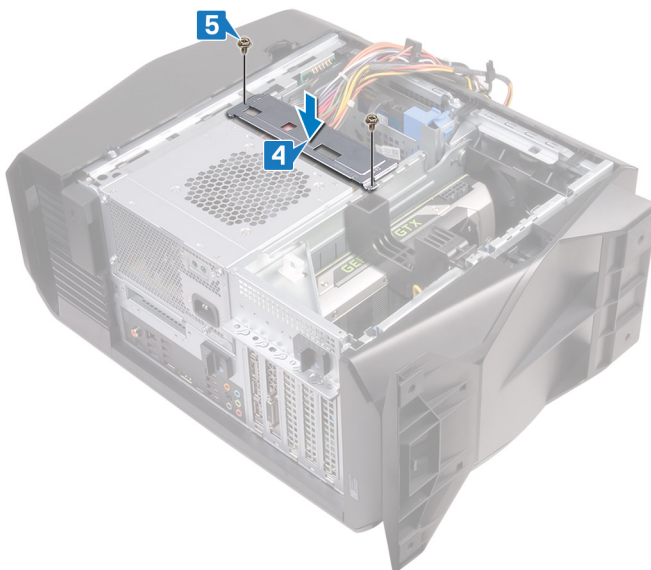



- 6 Slide the power-supply unit release latches towards the unlock position.

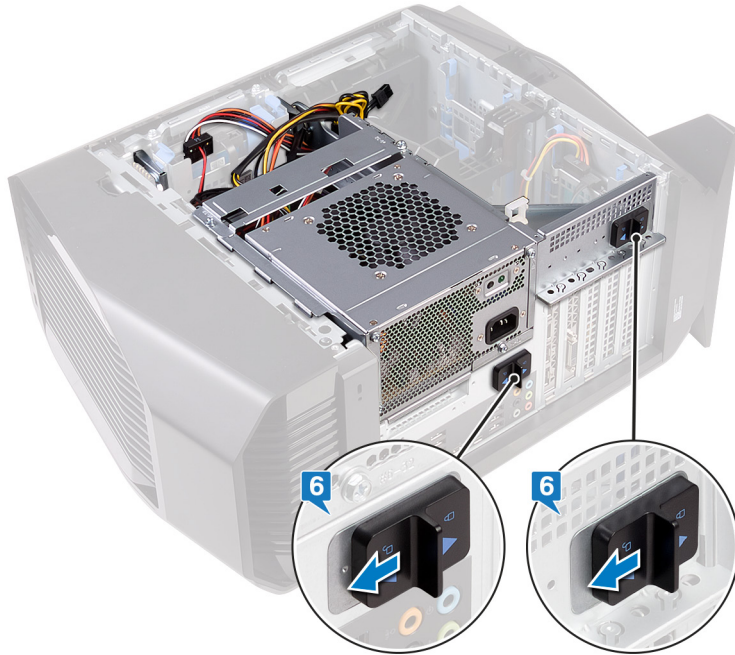

- 7 Lift and rotate the power-supply unit cage away from the chassis while pressing and holding the graphics-card bracket.



- 8 Connect the processor-power cable and system-board power cable to the system board.
- 9 Connect the power cables to the hard drives and optical drive.

**10** Connect the power cables to the graphics card.

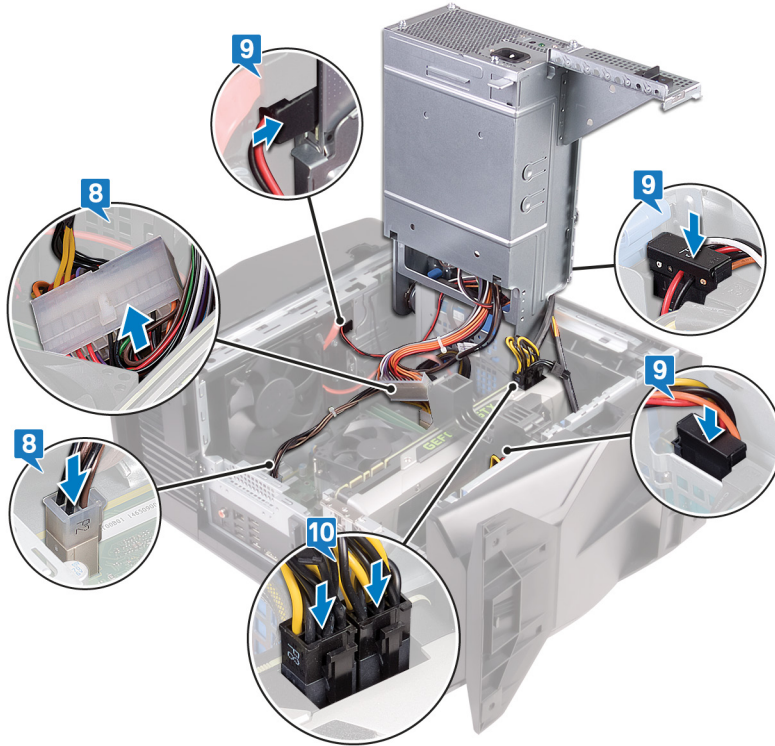

**11** Rotate the power-supply unit cage towards the chassis until the unit snaps into place.

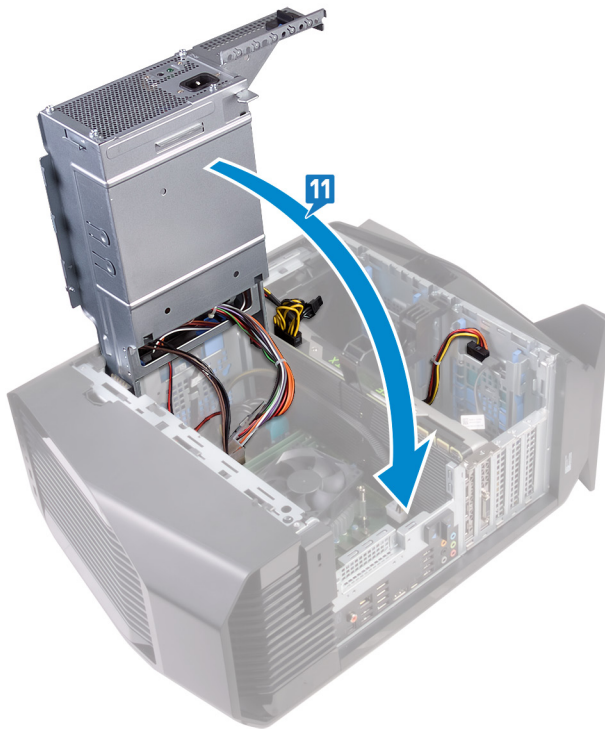

12 Slide the power-supply unit cage release latches towards the locked position.

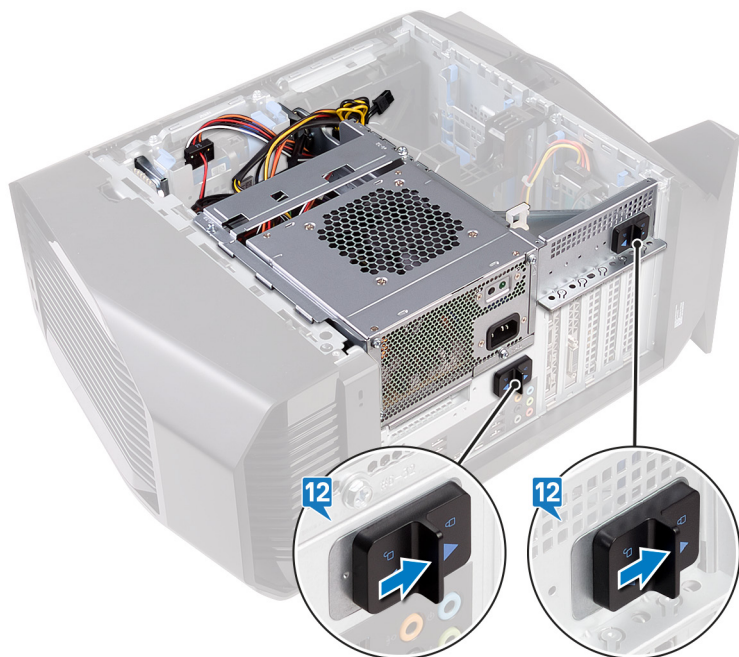

## Post-requisites

- 1 Replace the [top cover](#).
- 2 Replace the [right-side cover](#).
- 3 Replace the [left-side cover](#).



# Removing the processor-cooling assembly

**WARNING:** Before working inside your computer, read the safety information that shipped with your computer and follow the steps in [Before working inside your computer](#). After working inside your computer, follow the instructions in [After working inside your computer](#). For more safety best practices, see the Regulatory Compliance home page at [www.dell.com/regulatory\\_compliance](http://www.dell.com/regulatory_compliance).

## Prerequisites

- 1 Remove the [left-side cover](#).
- 2 Remove the [right-side cover](#).
- 3 Remove the [top cover](#).

## Procedure

- 1 Remove the four screws (#6-32 X 1/4") that secure the radiator and fan assembly to the radiator and fan cage.



- 2 Follow the procedure from step 1 to step 4 in "[Removing the power-supply unit](#)".
- 3 Loosen the two captive screws that secure the VR heat sink to the system board.

- 4 Lift the VR heat sink off the computer.

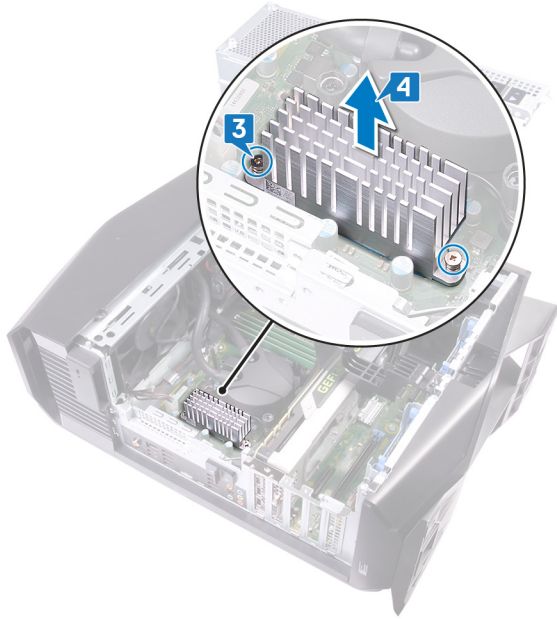

- 5 Disconnect the processor-cooling assembly cables from the system board.
  - 6 In reversed order (as indicated on the processor cooler), loosen the four captive screws that secure the processor cooler to the system board.
- NOTE:** If you are using an electric screwdriver, torque the screws at 6.9 +/-1.15 kilogram-force centimeter (6 +/-1 pound force inch).
- 7 Lift the processor-cooling assembly along with the cables off the computer.

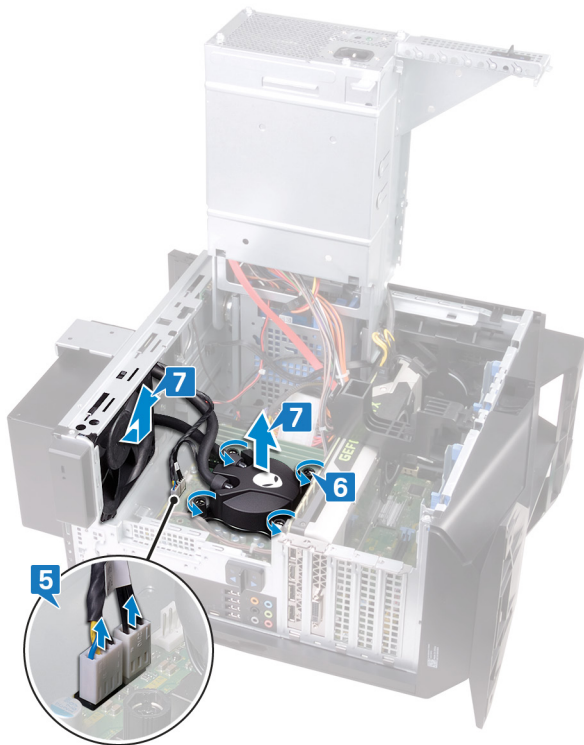

# Replacing the processor-cooling assembly

**WARNING:** Before working inside your computer, read the safety information that shipped with your computer and follow the steps in [Before working inside your computer](#). After working inside your computer, follow the instructions in [After working inside your computer](#). For more safety best practices, see the Regulatory Compliance home page at [www.dell.com/regulatory\\_compliance](http://www.dell.com/regulatory_compliance).

## Procedure

- 1 Slide the radiator and fan assembly into the radiator and fan cage.
- 2 Align the screw holes on the processor cooler with the screws on the system board.
- 3 In sequential order (indicated on the processor cooler), tighten the four captive screws that secure the processor cooler to the system board.

**NOTE:** If you are using an electric screwdriver, torque the screws at 6.9 +/-1.15 kilogram-force centimeter (6 +/-1 pound force inch).

- 4 Connect the processor-cooling assembly cables to the system board.

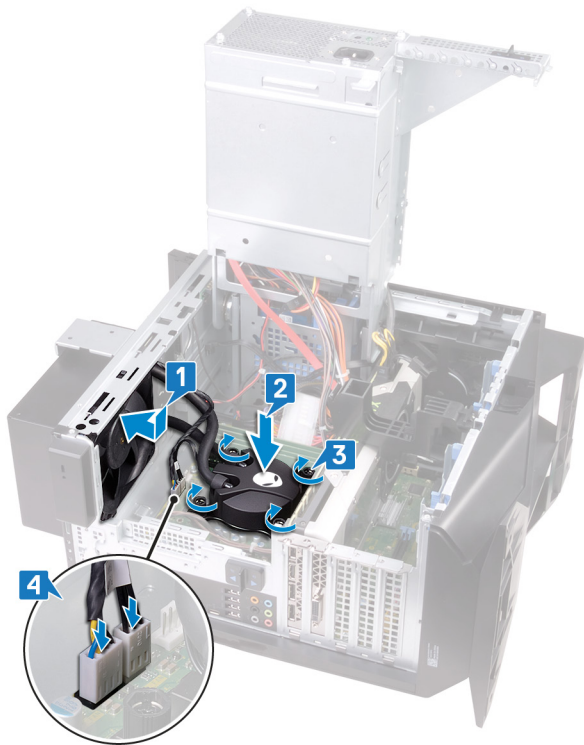

- 5 Align the screw holes on the VR heat sink with the screw holes on the system board.

- 6 Tighten the two captive screws that secure the VR heat sink to the system board.

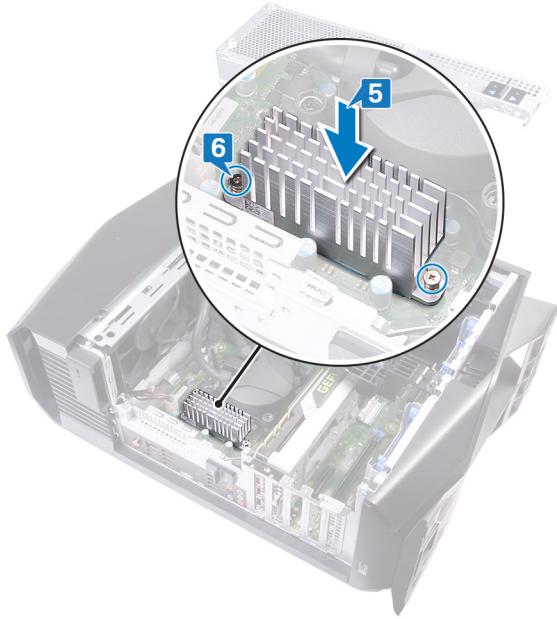

- 7 Follow the procedure from step 10 to step 11 in "[Replacing the power-supply unit](#)".
- 8 Replace the four screws (#6-32 X 1/4") that secure the radiator and fan assembly to the chassis.



## Post-requisites

- 1 Replace the [top cover](#).
- 2 Replace the [right-side cover](#).
- 3 Replace the [left-side cover](#).

# Removing the coin-cell battery

**WARNING:** Before working inside your computer, read the safety information that shipped with your computer and follow the steps in [Before working inside your computer](#). After working inside your computer, follow the instructions in [After working inside your computer](#). For more safety best practices, see the Regulatory Compliance home page at [www.dell.com/regulatory\\_compliance](http://www.dell.com/regulatory_compliance).

**CAUTION:** Removing the coin-cell battery resets the BIOS setup program's settings to default. It is recommended that you note the BIOS setup program's settings before removing the coin-cell battery.

## Prerequisites

- 1 Remove the [left-side cover](#).
- 2 Follow the procedure from step 1 to step 4 in "[Removing the power-supply unit](#)".

## Procedure

- 1 Using a plastic scribe, press the battery-release lever away from the coin-cell battery until the coin-cell battery pops up.
- 2 Lift the coin-cell battery out of its socket.

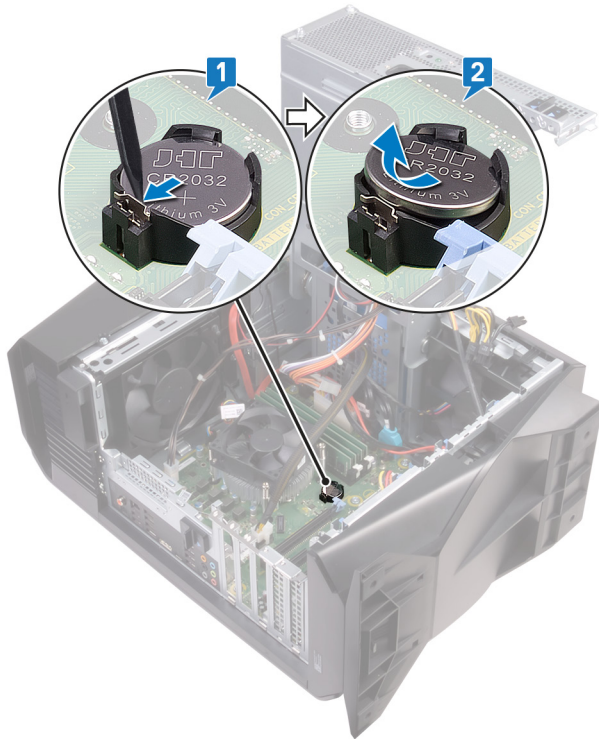

# Replacing the coin-cell battery

---

**⚠ WARNING:** Before working inside your computer, read the safety information that shipped with your computer and follow the steps in [Before working inside your computer](#). After working inside your computer, follow the instructions in [After working inside your computer](#). For more safety best practices, see the Regulatory Compliance home page at [www.dell.com/regulatory\\_compliance](http://www.dell.com/regulatory_compliance).

## Procedure

Insert a new coin-cell battery (CR2032) into the battery socket with the positive side facing up, and snap the battery into place.

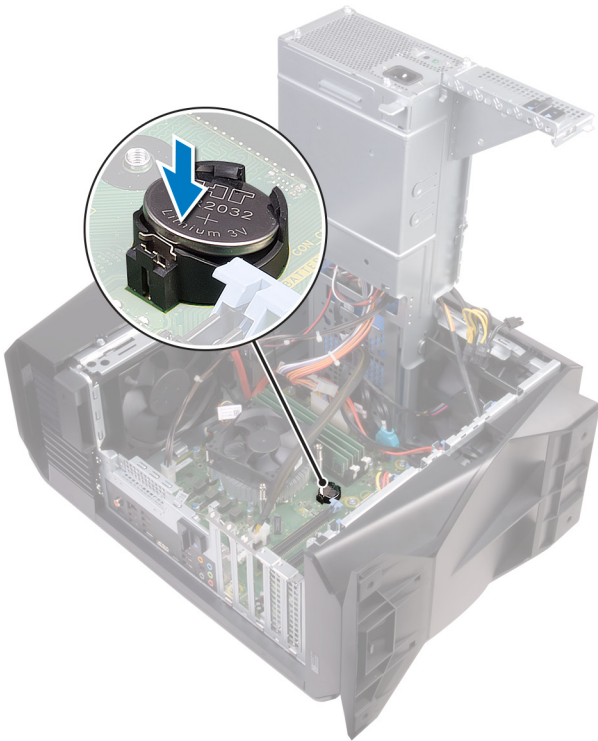

## Post-requisites

- 1 Follow the procedure from step 10 to step 11 in "[Replacing the power-supply unit](#)".
- 2 Replace the [left-side cover](#).



# Removing the memory modules

**WARNING:** Before working inside your computer, read the safety information that shipped with your computer and follow the steps in [Before working inside your computer](#). After working inside your computer, follow the instructions in [After working inside your computer](#). For more safety best practices, see the Regulatory Compliance home page at [www.dell.com/regulatory\\_compliance](http://www.dell.com/regulatory_compliance).

## Prerequisites

- 1 Remove the [left-side cover](#).
- 2 Follow the procedure from step 1 to step 4 in "[Removing the power-supply unit](#)".

## Procedure

- 1 Locate the memory-module slots on the system board. For more information, see "[System-board components](#)".
- 2 Push the securing clips away from the memory module.
- 3 Grasp the memory module near the securing clip, and then gently ease the memory module out of the memory-module slot.

**NOTE:** Repeat step 2 to step 3 to remove any other memory modules installed in your computer.

**CAUTION:** To prevent damage to the memory module, hold the memory module by the edges. Do not touch the components on the memory module.

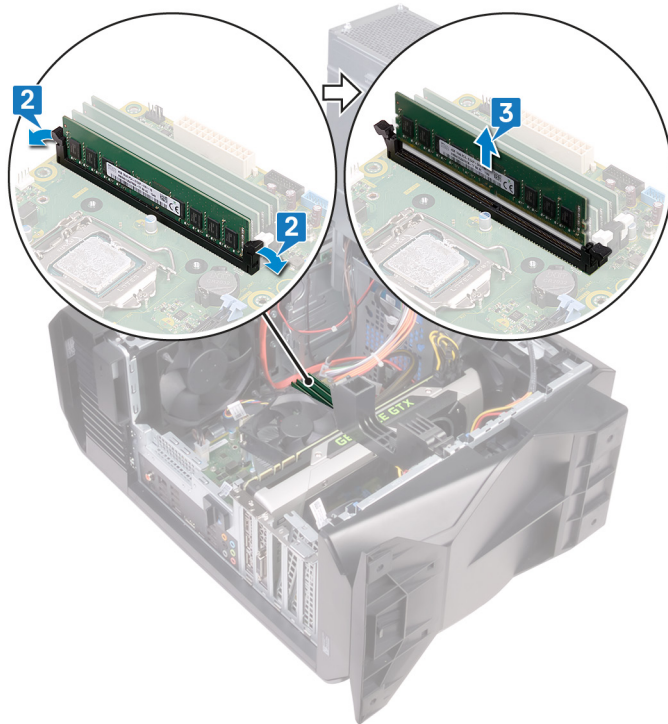

# Replacing the memory modules

---

 **WARNING:** Before working inside your computer, read the safety information that shipped with your computer and follow the steps in [Before working inside your computer](#). After working inside your computer, follow the instructions in [After working inside your computer](#). For more safety best practices, see the Regulatory Compliance home page at [www.dell.com/regulatory\\_compliance](http://www.dell.com/regulatory_compliance).

## Procedure

- 1 Ensure that the securing clips are extended away from the memory-module slot.
- 2 Align the notch on the memory module with the tab on the memory-module slot.



- 3 Insert the memory module into the memory-module slot and press the memory module down until it snaps into position and the securing clips lock in place.

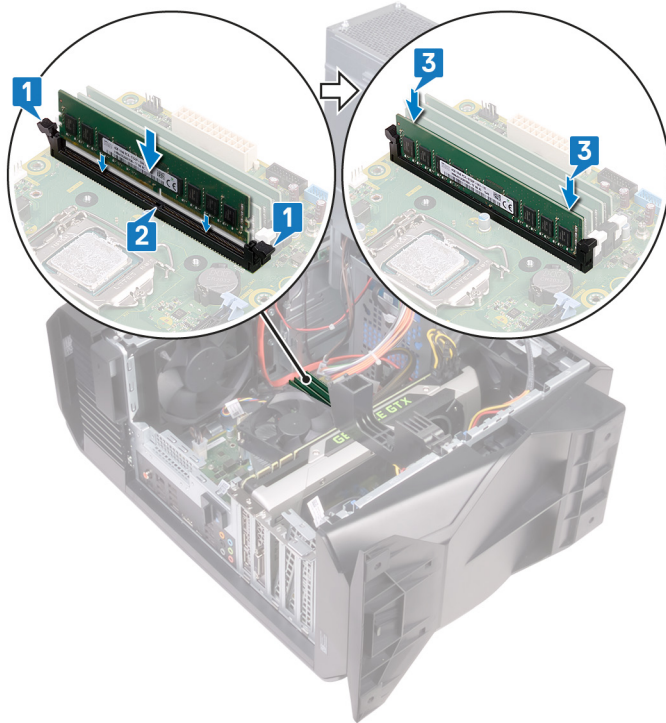

**NOTE:** Use slots XMM1 and XMM2 if you need to use two memory modules. For more information, see [System-board components](#).

The following table lists the available memory configuration matrix:

**Table 1. Memory configuration matrix**

Configuration	Slot			
	DIMM1	DIMM2	DIMM3	DIMM4
8 GB DDR4	8 GB			
16 GB DDR4	8 GB	8 GB		
32 GB DDR4	16 GB	16 GB		
64 GB DDR4	16 GB	16 GB	16 GB	16 GB
16 GB XMP	8 GB	8 GB		
32 GB XMP	16 GB	16 GB		
64 GB XMP	16 GB	16 GB	16 GB	16 GB

## Post-requisites

- 1 Follow the procedure from step 10 to step 11 in "[Replacing the power-supply unit](#)".
- 2 Replace the [left-side cover](#).

# Removing the solid-state drive

**⚠ WARNING:** Before working inside your computer, read the safety information that shipped with your computer and follow the steps in [Before working inside your computer](#). After working inside your computer, follow the instructions in [After working inside your computer](#). For more safety best practices, see the Regulatory Compliance home page at [www.dell.com/regulatory\\_compliance](http://www.dell.com/regulatory_compliance).

**⚠ CAUTION:** Solid-state drives are fragile. Exercise care when handling the solid-state drive.

**⚠ CAUTION:** To avoid data loss, do not remove the solid-state drive while the computer is in sleep or on state.

## Prerequisites

- 1 Remove the [left-side cover](#).
- 2 Follow the procedure from step 1 to step 4 in "[Removing the power-supply unit](#)".
- 3 Remove the [graphics card](#).

## Procedure

- 1 Locate the solid-state drive slot on the system board. For more information, see "[System-board components](#)".
- 2 Remove the screw (M2x2.5) that secures the solid-state drive to the system board.
- 3 Slide and lift the solid-state drive off the system board.

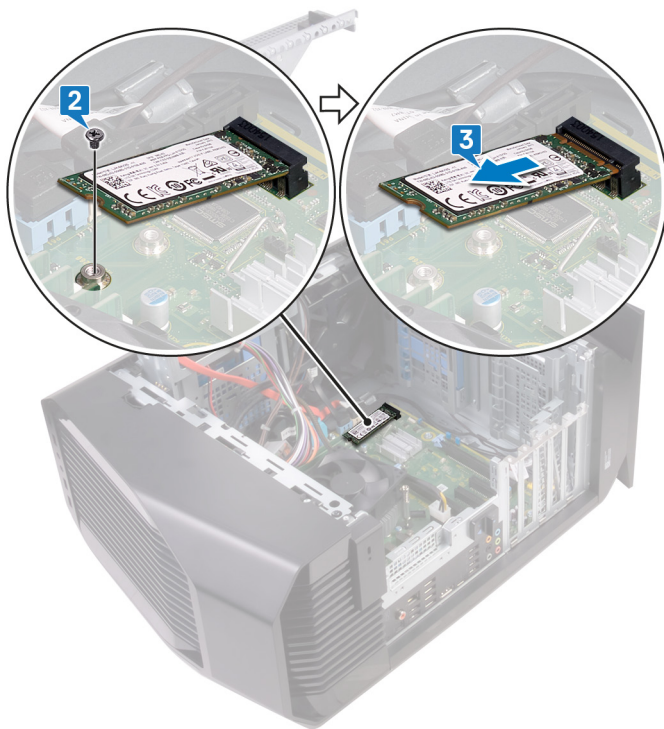

# Replacing the solid-state drive

**WARNING:** Before working inside your computer, read the safety information that shipped with your computer and follow the steps in [Before working inside your computer](#). After working inside your computer, follow the instructions in [After working inside your computer](#). For more safety best practices, see the Regulatory Compliance home page at [www.dell.com/regulatory\\_compliance](http://www.dell.com/regulatory_compliance).

**CAUTION:** Solid-state drives are fragile. Exercise care when handling the solid-state drive.

## Procedure

- 1 Align the notch on the solid-state drive with the tab on the solid-state drive slot.
- 2 Insert the solid-state drive at a 45-degree angle into the system board.
- 3 Press the other end of the solid-state drive down and replace the screw (M2x2.5) that secure the solid-state drive to the system board.

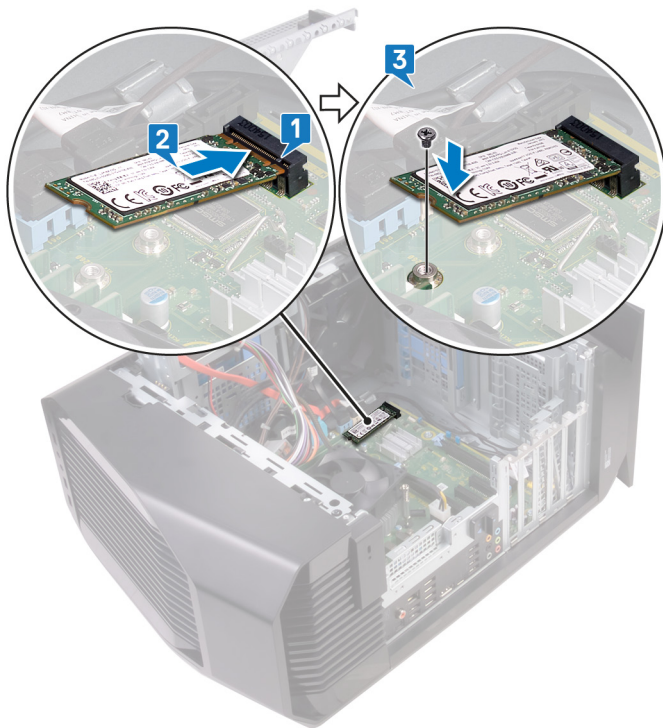

## Post-requisites

- 1 Replace the [graphics card](#).
- 2 Follow the procedure from step 10 to step 11 in "[Replacing the power-supply unit](#)".
- 3 Replace the [left-side cover](#).

# Removing the graphics card

---

**⚠ WARNING:** Before working inside your computer, read the safety information that shipped with your computer and follow the steps in [Before working inside your computer](#). After working inside your computer, follow the instructions in [After working inside your computer](#). For more safety best practices, see the Regulatory Compliance home page at [www.dell.com/regulatory\\_compliance](http://www.dell.com/regulatory_compliance).

## Prerequisites

- 1 Remove the [left-side cover](#).
- 2 Follow the procedure from step 1 to step 4 in "[Removing the power-supply unit](#)".

## Procedure

- 1 Lift to release the graphics-card bracket from the chassis.



- 2 Press the releasing clip on the power-cable connectors and disconnect the power cables from the graphics card.

- 3 Push the securing tab on the PCIe slot away from the graphics card, grasp the card by its top corner, and ease it out of the slot.



# Replacing the graphics card

---

**WARNING:** Before working inside your computer, read the safety information that shipped with your computer and follow the steps in [Before working inside your computer](#). After working inside your computer, follow the instructions in [After working inside your computer](#). For more safety best practices, see the Regulatory Compliance home page at [www.dell.com/regulatory\\_compliance](http://www.dell.com/regulatory_compliance).

## Procedure

- 1 Align the graphics card with the slot on the system board.
- 2 Place the card into the slot and press down firmly until the graphics card snaps into place.
- 3 Connect the power cables to the graphics card.

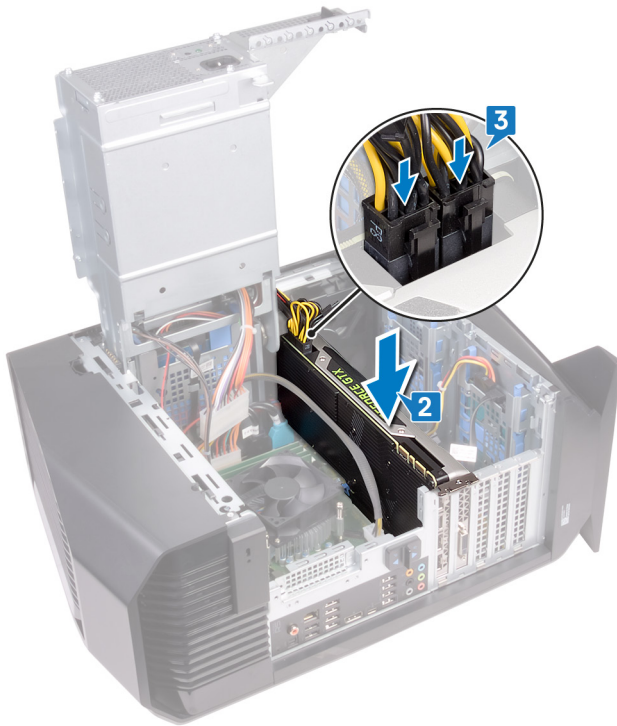

- 4 Slide the tab on the graphics-card bracket into the slot on the chassis and snap it into place.



## Post-requisites

- 1 Follow the procedure from step 10 to step 11 in "[Replacing the power-supply unit](#)".
- 2 Replace the [left-side cover](#).



# Removing the VR heat sink

---

 **WARNING:** Before working inside your computer, read the safety information that shipped with your computer and follow the steps in [Before working inside your computer](#). After working inside your computer, follow the instructions in [After working inside your computer](#). For more safety best practices, see the Regulatory Compliance home page at [www.dell.com/regulatory\\_compliance](http://www.dell.com/regulatory_compliance).

 **WARNING:** The heat sink may become hot during normal operation. Allow sufficient time for the heat sink to cool before you touch it.

 **CAUTION:** For maximum cooling of the processor, do not touch the heat transfer areas on the heat sink. The oils in your skin can reduce the heat transfer capability of the thermal grease.

## Prerequisites

- 1 Remove the [left-side cover](#).
- 2 Follow the procedure from step 1 to step 4 in "[Removing the power-supply unit](#)".

## Procedure

- 1 Loosen the two captive screws that secure the VR heat sink to the system board.
- 2 Lift the VR heat sink from the system board.

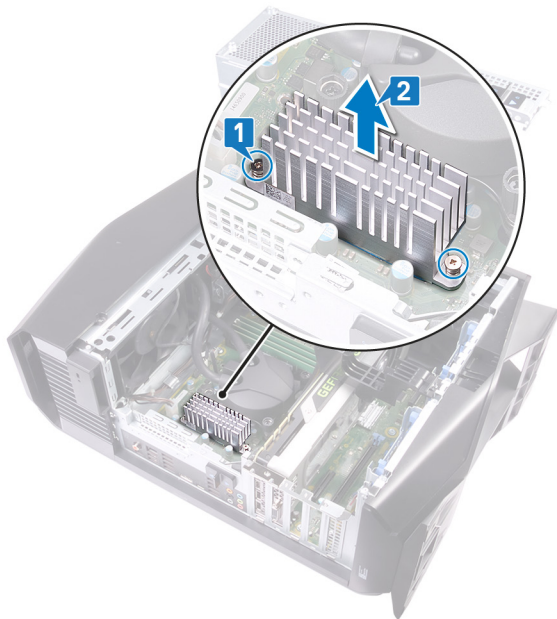



# Replacing the VR heat sink

---

**WARNING:** Before working inside your computer, read the safety information that shipped with your computer and follow the steps in [Before working inside your computer](#). After working inside your computer, follow the instructions in [After working inside your computer](#). For more safety best practices, see the Regulatory Compliance home page at [www.dell.com/regulatory\\_compliance](http://www.dell.com/regulatory_compliance).

## Procedure

- 1 Align and place the VR heat sink on the system board.
- 2 Tighten the two captive screws that secure the VR heat sink to the system board.

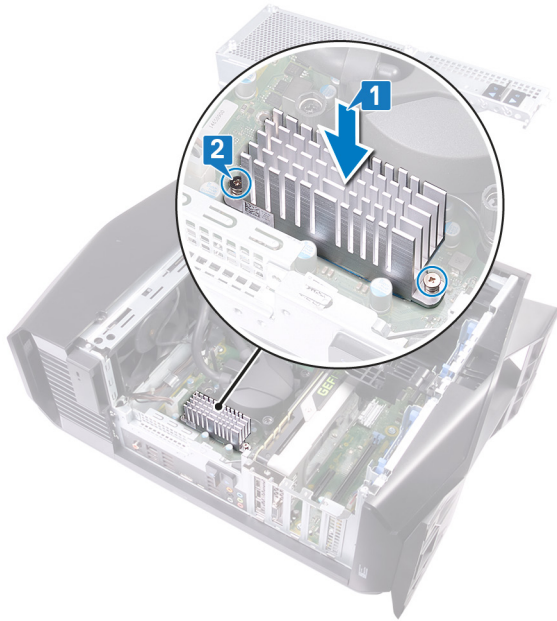

## Post-requisites

- 1 Follow the procedure from step 10 to step 11 in "[Replacing the power-supply unit](#)".
- 2 Replace the [left-side cover](#).

# Removing the processor fan and heat-sink assembly

**WARNING:** Before working inside your computer, read the safety information that shipped with your computer and follow the steps in [Before working inside your computer](#). After working inside your computer, follow the instructions in [After working inside your computer](#). For more safety best practices, see the Regulatory Compliance home page at [www.dell.com/regulatory\\_compliance](http://www.dell.com/regulatory_compliance).

**WARNING:** The heat sink may become hot during normal operation. Allow sufficient time for the heat sink to cool before you touch it.

**CAUTION:** For maximum cooling of the processor, do not touch the heat transfer areas on the heat sink. The oils in your skin can reduce the heat transfer capability of the thermal grease.

## Prerequisites

- 1 Remove the [left-side cover](#).
- 2 Follow the procedure from step 1 to step 4 in "[Removing the power-supply unit](#)".

## Procedure

- 1 Disconnect the processor-fan cable from the system board.
- 2 In a non-adjacent sequence, loosen the four captive screws that secure the processor fan and heat-sink assembly to the system board.
- 3 Lift the processor fan and heat-sink assembly off the system board.

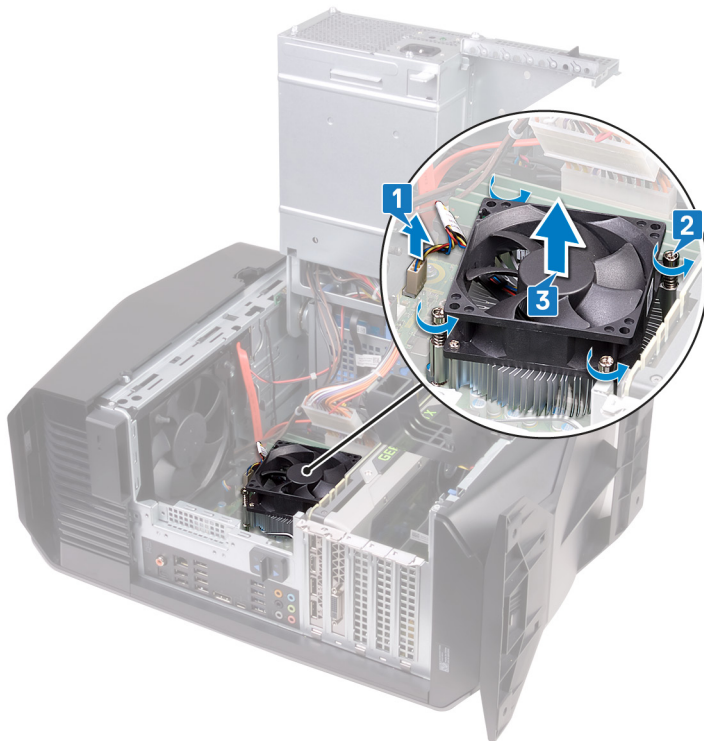

# Replacing the processor fan and heat-sink assembly

**WARNING:** Before working inside your computer, read the safety information that shipped with your computer and follow the steps in [Before working inside your computer](#). After working inside your computer, follow the instructions in [After working inside your computer](#). For more safety best practices, see the Regulatory Compliance home page at [www.dell.com/regulatory\\_compliance](http://www.dell.com/regulatory_compliance).

## Procedure

- NOTE:** The original thermal grease can be reused if the original processor and heat-sink assembly are reinstalled together.
- CAUTION:** If either the processor or the heat-sink assembly is replaced, use the thermal grease provided in the kit to ensure that thermal conductivity is achieved.
- 1 Place the processor fan and heat-sink assembly on the processor.
  - 2 Align the captive screws on the processor fan heat-sink assembly with the screw holes on the system board.
  - 3 In a non-adjacent sequence, tighten the four captive screws that secure the processor fan and heat-sink assembly to the system board.
  - 4 Connect the processor-fan cable to the system board.

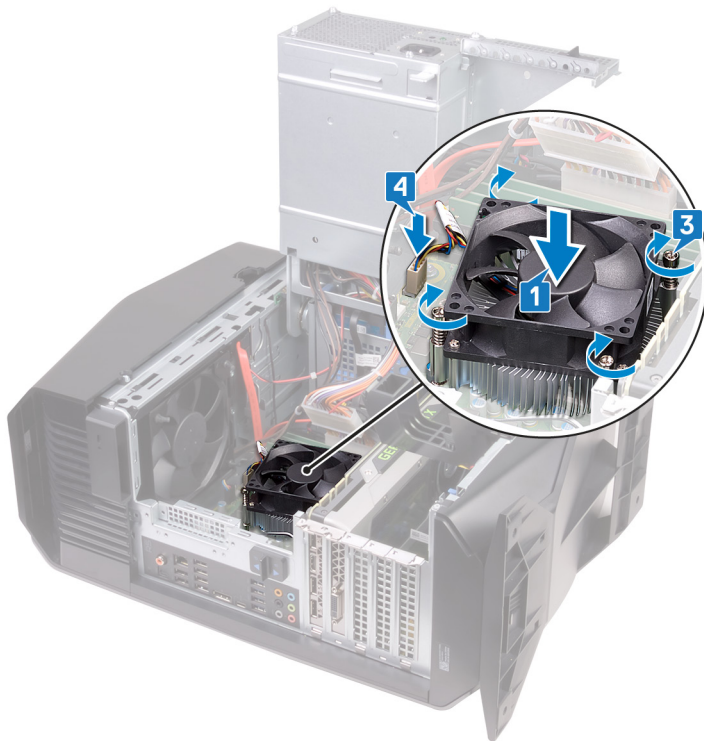

## Post-requisites

- 1 Follow the procedure from step 10 to step 11 in "[Replacing the power-supply unit](#)".
- 2 Replace the [left-side cover](#).

# Removing the processor

---

**⚠ WARNING:** Before working inside your computer, read the safety information that shipped with your computer and follow the steps in [Before working inside your computer](#). After working inside your computer, follow the instructions in [After working inside your computer](#). For more safety best practices, see the Regulatory Compliance home page at [www.dell.com/regulatory\\_compliance](http://www.dell.com/regulatory_compliance).

## Prerequisites



- 1 Remove the [left-side cover](#).
- 2 Follow the procedure from step 1 to step 4 in "[Removing the power-supply unit](#)".
- 3 Remove the [processor fan and heat-sink assembly](#) or [processor-cooling assembly](#) (as applicable).

## Procedure

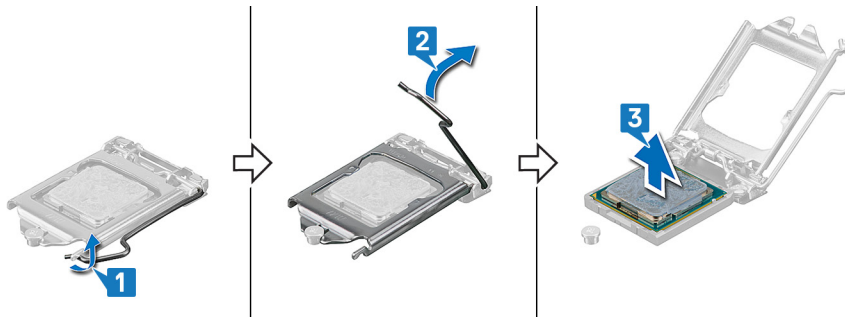

- 1 Press the release lever down and then push it away from the processor to release it from the tab.
- 2 Extend the release lever completely and open the processor cover.
- 3 Lift the processor off the processor socket.



# Replacing the processor

-  **WARNING:** Before working inside your computer, read the safety information that shipped with your computer and follow the steps in [Before working inside your computer](#). After working inside your computer, follow the instructions in [After working inside your computer](#). For more safety best practices, see the Regulatory Compliance home page at [www.dell.com/regulatory\\_compliance](http://www.dell.com/regulatory_compliance).
-  **CAUTION:** If either the processor or the heat sink is replaced, use the thermal grease provided in the kit to ensure that thermal conductivity is achieved.
-  **NOTE:** A new processor ships with a thermal pad in the package. In some cases, the processor may ship with the thermal pad attached to it.

## Procedure

- 1 Ensure that the release lever on the processor socket is fully extended and the processor cover is fully open.
  -  **CAUTION:** Position the processor correctly in the processor socket to avoid permanent damage to the processor.
- 2 Align the pin-1 corner on the processor with the pin-1 corner on the processor socket, and then place the processor in the processor socket.
  -  **CAUTION:** Ensure that the processor-cover notch is positioned underneath the alignment post.
- 3 When the processor is fully seated in the socket, close the processor cover.
- 4 Pivot the release lever down and place it under the tab on the processor cover.

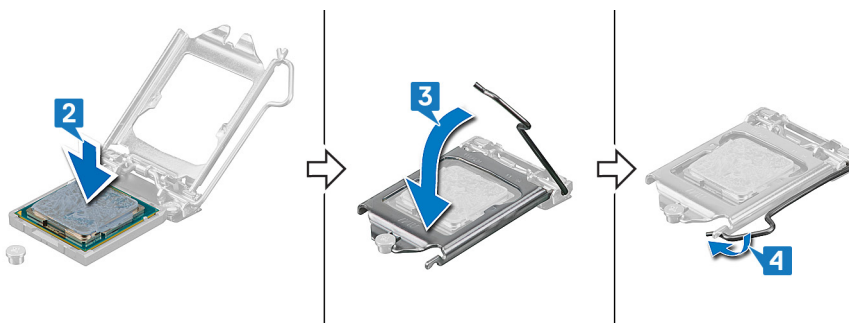

## Post-requisites

- 1 Replace the [processor fan and heat-sink assembly](#) or [processor-cooling assembly](#) (as applicable).
- 2 Follow the procedure from step 10 to step 11 in "[Replacing the power-supply unit](#)".
- 3 Replace the [left-side cover](#).

# Removing the wireless card

---

**WARNING:** Before working inside your computer, read the safety information that shipped with your computer and follow the steps in [Before working inside your computer](#). After working inside your computer, follow the instructions in [After working inside your computer](#). For more safety best practices, see the Regulatory Compliance home page at [www.dell.com/regulatory\\_compliance](http://www.dell.com/regulatory_compliance).

## Prerequisites

- 1 Remove the [left-side cover](#).
- 2 Follow the procedure from step 1 to step 4 in "[Removing the power-supply unit](#)".

## Procedure

- 1 Locate the wireless-card slot on the system board. For more information, see "[System-board components](#)".
- 2 Remove the screw (M2x2.5) that secures the wireless card to the system board.
- 3 Lift the wireless-card bracket off the wireless card.
- 4 Slide and remove the wireless card from the wireless-card slot.
- 5 Disconnect the antenna cables from the wireless card.

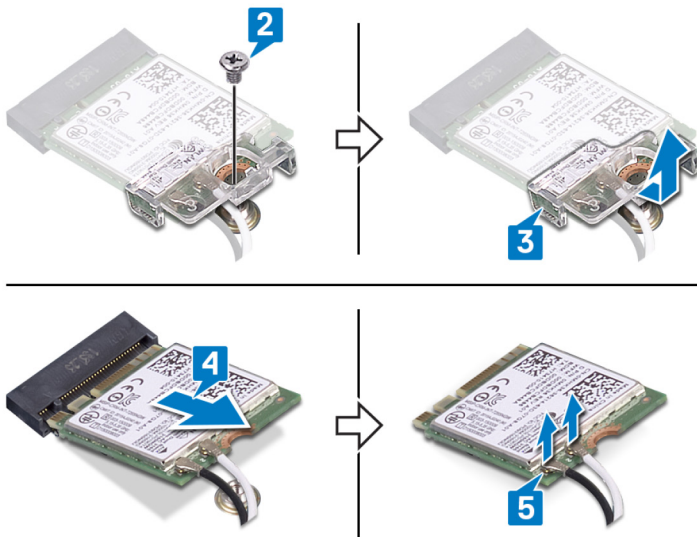

# Replacing the wireless card

**WARNING:** Before working inside your computer, read the safety information that shipped with your computer and follow the steps in [Before working inside your computer](#). After working inside your computer, follow the instructions in [After working inside your computer](#). For more safety best practices, see the Regulatory Compliance home page at [www.dell.com/regulatory\\_compliance](http://www.dell.com/regulatory_compliance).

## Procedure

**CAUTION:** To avoid damaging the wireless card, do not place any cables under it.

- 1 Connect the antenna cables to the wireless card.

The following table provides the antenna-cable color scheme for the wireless card that is supported by your computer.

**Table 2. Antenna-cable color scheme**

Connectors on the wireless card	Antenna-cable color
Main (white triangle)	White
Auxiliary (black triangle)	Black

- 2 Place the wireless-card bracket on the wireless card.
- 3 Align the notch on the wireless card with the tab on the wireless-card slot, and then slide the wireless card at an angle into the wireless-card slot.
- 4 Replace the screw (M2x2.5) that secures the wireless card to the system board.

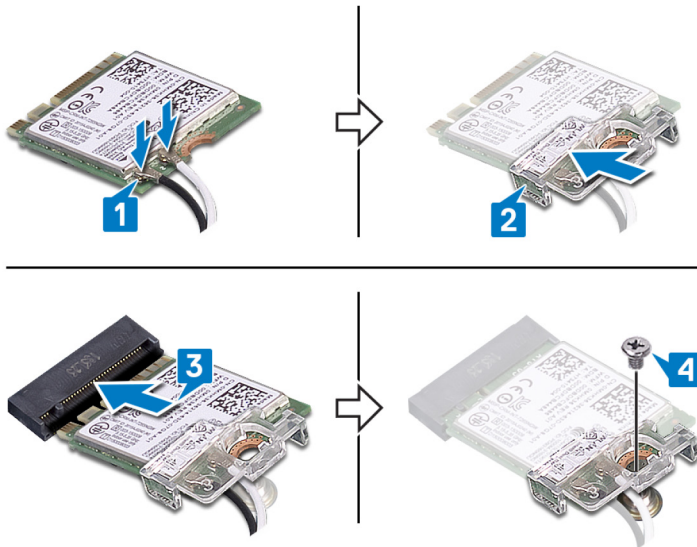

## Post-requisites

- 1 Follow the procedure from step 10 to step 11 in "[Replacing the power-supply unit](#)".
- 2 Replace the [left-side cover](#).

# Removing the antennas

---

**⚠ WARNING:** Before working inside your computer, read the safety information that shipped with your computer and follow the steps in [Before working inside your computer](#). After working inside your computer, follow the instructions in [After working inside your computer](#). For more safety best practices, see the Regulatory Compliance home page at [www.dell.com/regulatory\\_compliance](http://www.dell.com/regulatory_compliance).

## Prerequisites

- 1 Remove the [left-side cover](#).
- 2 Remove the [right-side cover](#).
- 3 Remove the [top cover](#).
- 4 Follow the procedure from step 1 to step 4 in "[Removing the wireless card](#)".

## Procedure

- 1 Note the antenna-cable routing and remove the antenna cables from the routing guides inside the chassis.
- 2 Push down the antenna cables towards the top of the computer through the cable-routing slot on the chassis.

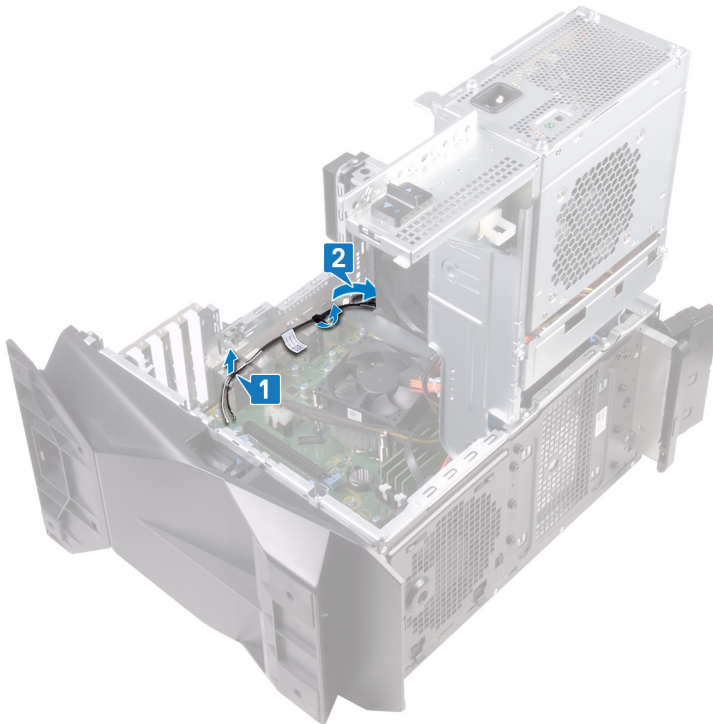

- 3 Remove the antenna cables from the routing guides on the chassis.



4 Pry the antenna off the chassis.



# Replacing the antennas

---

**⚠ WARNING:** Before working inside your computer, read the safety information that shipped with your computer and follow the steps in [Before working inside your computer](#). After working inside your computer, follow the instructions in [After working inside your computer](#). For more safety best practices, see the Regulatory Compliance home page at [www.dell.com/regulatory\\_compliance](http://www.dell.com/regulatory_compliance).

## Procedure

- 1 Adhere the antenna to the chassis.
- 2 Route the antenna cables through the routing guides on the chassis.



- 3 Slide the cables through the cable-routing slot on the chassis, and then route the antenna cables through the routing guides inside the chassis.

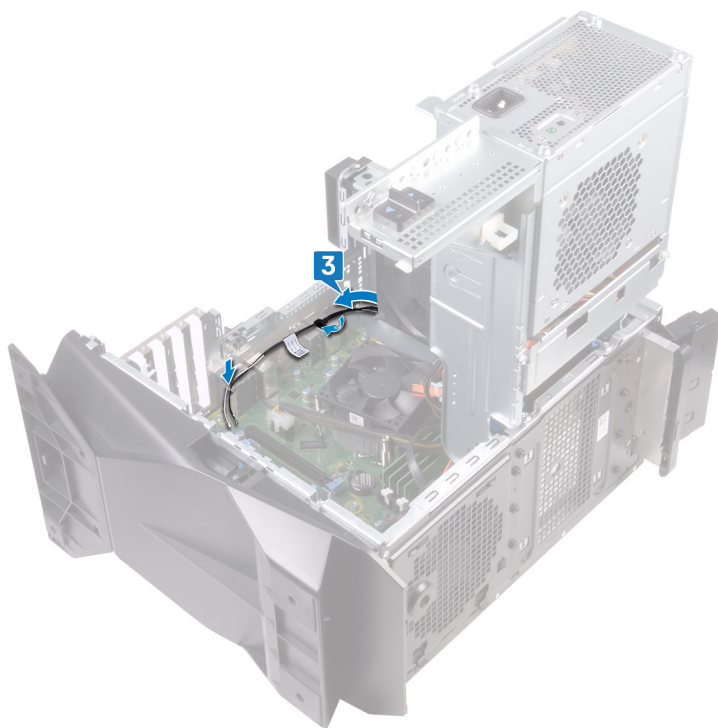

## Post-requisites

- 1 Follow the procedure from step 1 to step 3 in "[Replacing the wireless card](#)".
- 2 Replace the [top cover](#).
- 3 Replace the [right-side cover](#).
- 4 Replace the [left-side cover](#).

# Removing the front-chassis fan

**WARNING:** Before working inside your computer, read the safety information that shipped with your computer and follow the steps in [Before working inside your computer](#). After working inside your computer, follow the instructions in [After working inside your computer](#). For more safety best practices, see the Regulatory Compliance home page at [www.dell.com/regulatory\\_compliance](http://www.dell.com/regulatory_compliance).

## Prerequisites

- 1 Remove the [left-side cover](#).
- 2 Follow the procedure from step 1 to step 4 in "[Removing the power-supply unit](#)".
- 3 Remove the [graphics card](#).

## Procedure

- 1 Disconnect the front-chassis fan cable from the system board.
- 2 Push the tab to release the front-chassis fan from the chassis.
- 3 Slide and lift the chassis fan off the chassis.

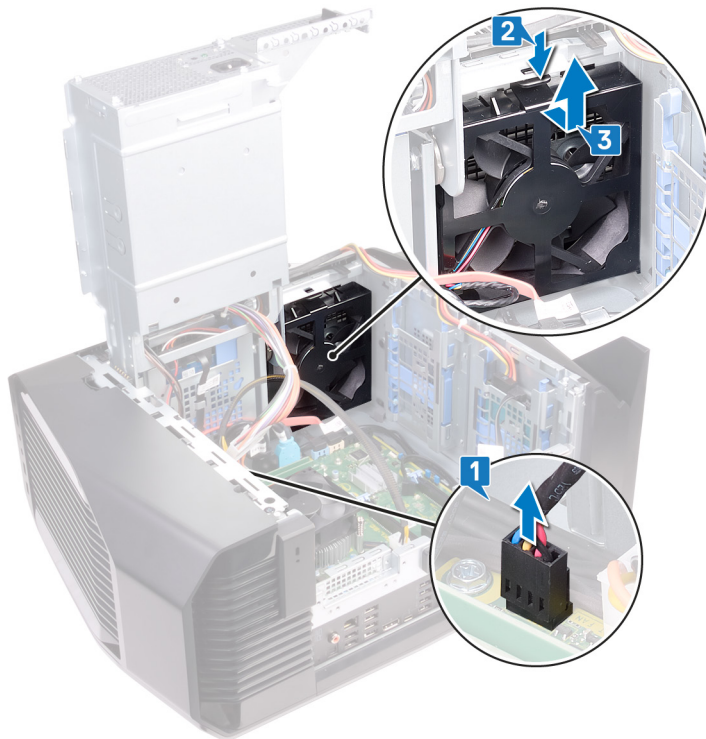

- 4 Spread apart the tabs on the front-chassis fan bracket and lift the front-chassis fan along with its cable off the bracket.

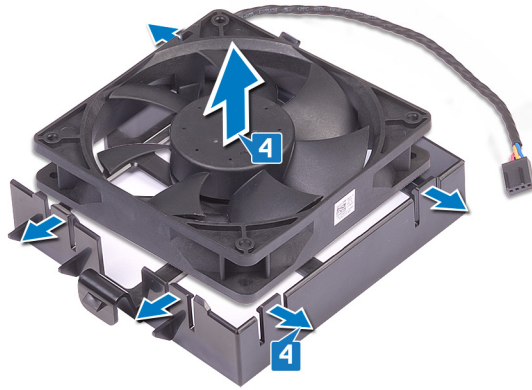

# Replacing the front-chassis fan

**WARNING:** Before working inside your computer, read the safety information that shipped with your computer and follow the steps in [Before working inside your computer](#). After working inside your computer, follow the instructions in [After working inside your computer](#). For more safety best practices, see the Regulatory Compliance home page at [www.dell.com/regulatory\\_compliance](http://www.dell.com/regulatory_compliance).

## Procedure

- 1 Align the tabs on the front-chassis fan bracket with the front-chassis fan and press down on the fan until it snaps into position.

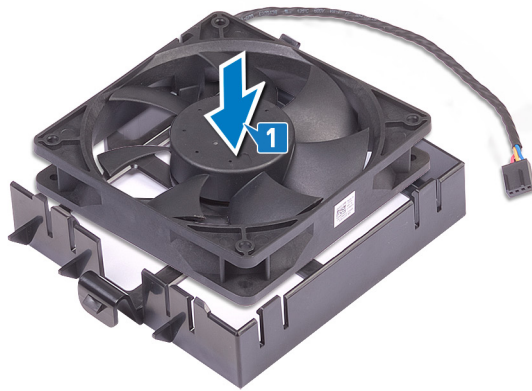

- 2 Align the tabs on the front-chassis fan with the slots on the chassis and slide the fan until it snaps into position.
- 3 Connect the front-chassis fan cable to the system board.

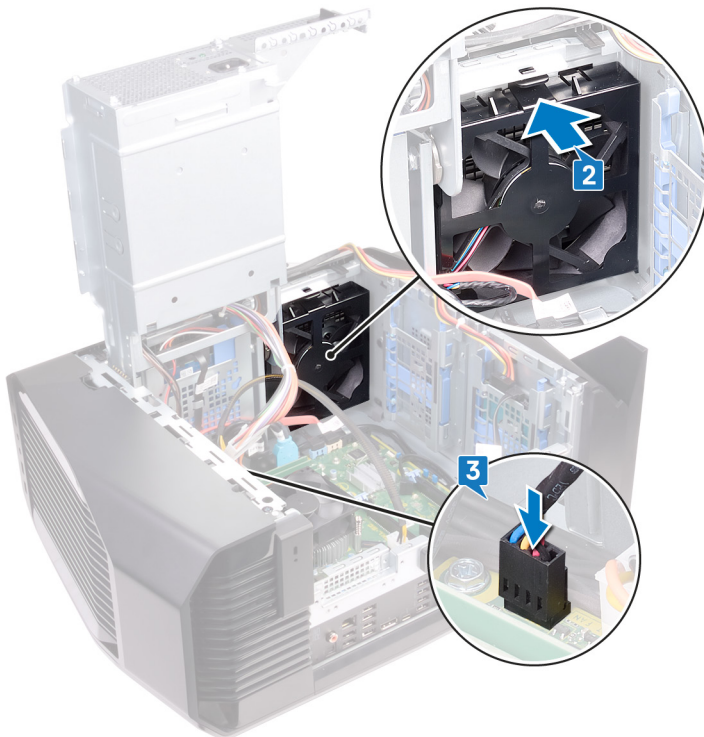

## Post-requisites

- 1 Replace the [graphics card](#).
- 2 Follow the procedure from step 10 to step 11 in "[Replacing the power-supply unit](#)".
- 3 Replace the [left-side cover](#).

# Removing the top-chassis fan

**WARNING:** Before working inside your computer, read the safety information that shipped with your computer and follow the steps in [Before working inside your computer](#). After working inside your computer, follow the instructions in [After working inside your computer](#). For more safety best practices, see the Regulatory Compliance home page at [www.dell.com/regulatory\\_compliance](http://www.dell.com/regulatory_compliance).

## Prerequisites

- 1 Remove the [left-side cover](#).
- 2 Follow the procedure from step 1 to step 4 in "[Removing the power-supply unit](#)".

## Procedure

- 1 Remove the screw (#6-32 X 1/4") that secures the top-chassis fan to the chassis.
- 2 Disconnect the top-chassis fan cable from the system board.
- 3 Remove the top-chassis fan from the chassis.

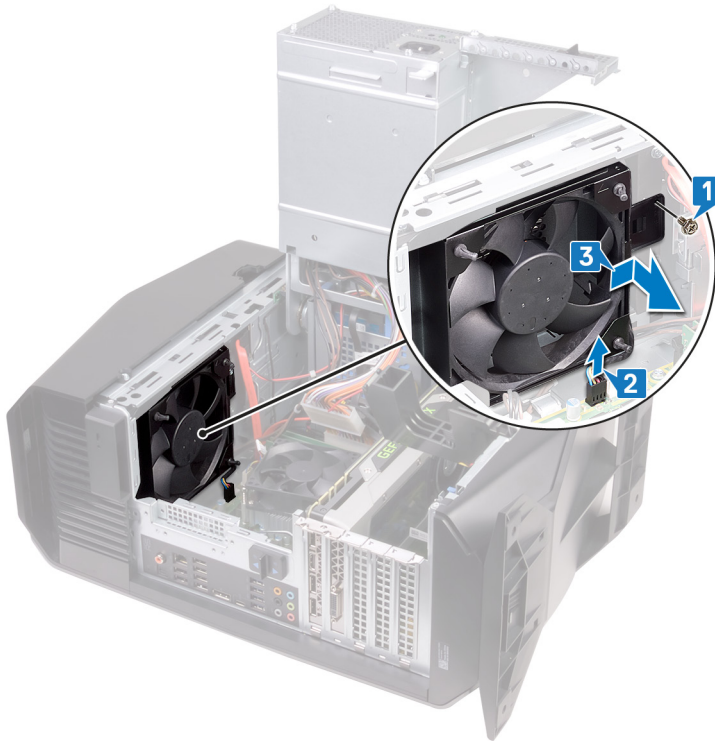

- 4 Remove the top-chassis fan cable from the routing guide on the top-chassis fan bracket.
- 5 Push the rubber grommets through the holes at each corner of the fan to release top-chassis fan from the bracket.



- 6 Lift the top-chassis fan off the top-chassis fan bracket.

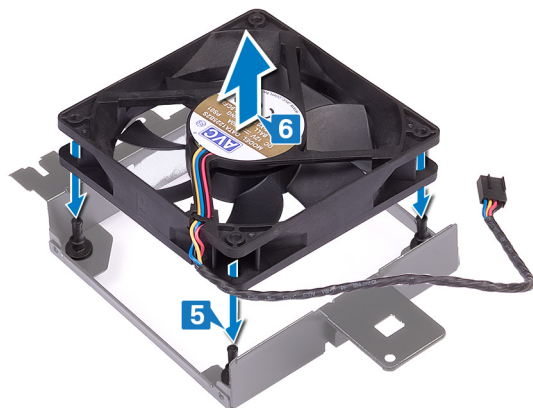

# Replacing the top-chassis fan

---

**WARNING:** Before working inside your computer, read the safety information that shipped with your computer and follow the steps in [Before working inside your computer](#). After working inside your computer, follow the instructions in [After working inside your computer](#). For more safety best practices, see the Regulatory Compliance home page at [www.dell.com/regulatory\\_compliance](http://www.dell.com/regulatory_compliance).

## Procedure

- 1 Align the holes on the top-chassis fan with the holes on the top-chassis fan bracket.
- 2 Insert the ends of the rubber grommets through the holes at each corner of the fan.

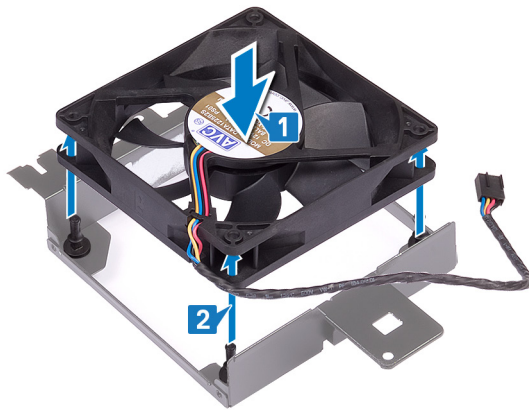

- 3 Align the grommets in the fan with the holes at each corner of the top-chassis fan bracket and pull through until they snap into place.
- 4 Route the top-chassis fan cable through the routing guide on the bracket.
- 5 Align the tabs on the top-chassis fan with the slots on the chassis and slide the fan until it snaps into position.
- 6 Replace the screw (#6-32 X 1/4") that secures the top-chassis fan to the chassis.

- 7 Connect the top-chassis fan cable to the system board.

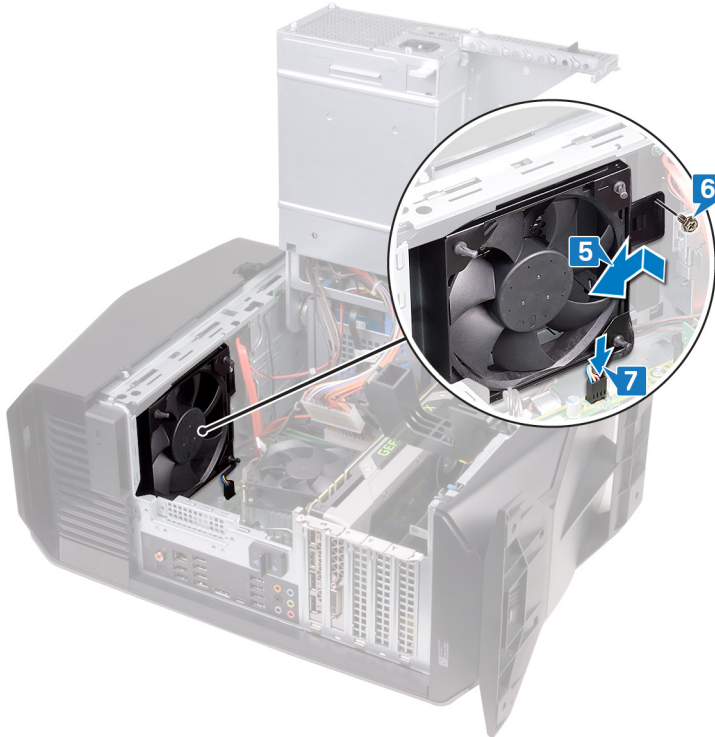

## Post-requisites

- 1 Follow the procedure from step 10 to step 11 in "[Replacing the power-supply unit](#)".
- 2 Replace the [left-side cover](#).

# Removing the optical drive

**WARNING:** Before working inside your computer, read the safety information that shipped with your computer and follow the steps in [Before working inside your computer](#). After working inside your computer, follow the instructions in [After working inside your computer](#). For more safety best practices, see the Regulatory Compliance home page at [www.dell.com/regulatory\\_compliance](http://www.dell.com/regulatory_compliance).

## Prerequisites

- 1 Remove the [left-side cover](#).
- 2 Follow the procedure from step 1 to step 4 in "[Removing the power-supply unit](#)".

## Procedure

- 1 Disconnect the power and data cable from the optical-drive.
- 2 Pull the securing tab to release the optical-drive carrier from the chassis.

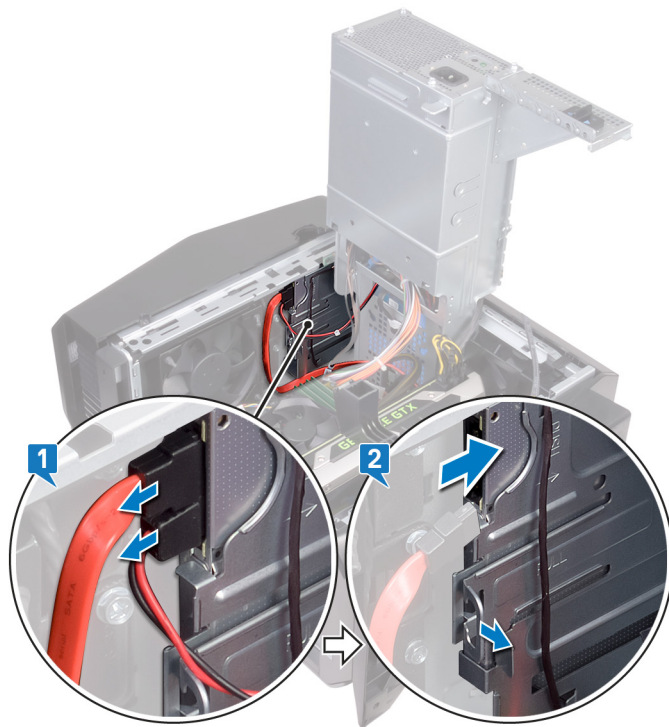

- 3 Push to slide the optical-drive assembly out through the front of the computer.

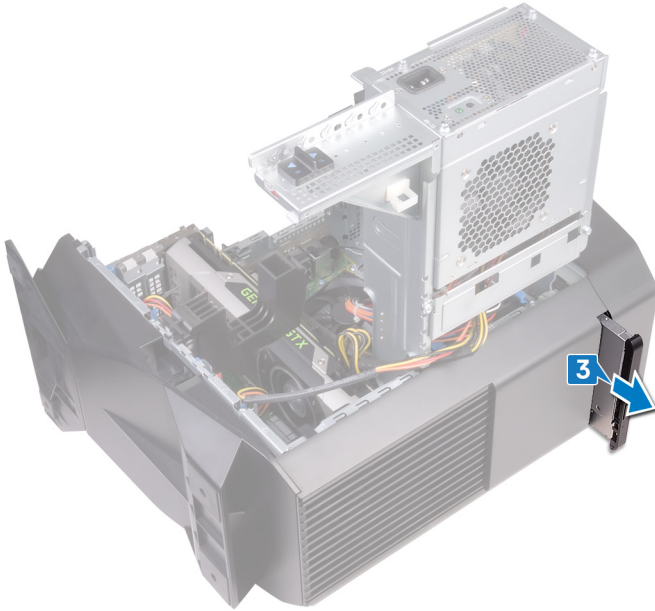

- 4 Remove the screw (M2x2.5) that secures the optical-drive bracket to the optical drive.



- 5 Gently pull and disconnect the optical-drive bezel from the optical drive.



# Replacing the optical drive

---

**WARNING:** Before working inside your computer, read the safety information that shipped with your computer and follow the steps in [Before working inside your computer](#). After working inside your computer, follow the instructions in [After working inside your computer](#). For more safety best practices, see the Regulatory Compliance home page at [www.dell.com/regulatory\\_compliance](http://www.dell.com/regulatory_compliance).

## Procedure

- 1 Align and snap the optical-drive bezel to the optical drive.



- 2 Align the screw hole on the optical-drive bracket with the screw hole on the optical drive.
- 3 Replace the screw (M2x2.5) that secures the optical-drive bracket to the optical drive.



- 4 Slide the optical-drive assembly through the front of the computer until the securing tab snaps into place.

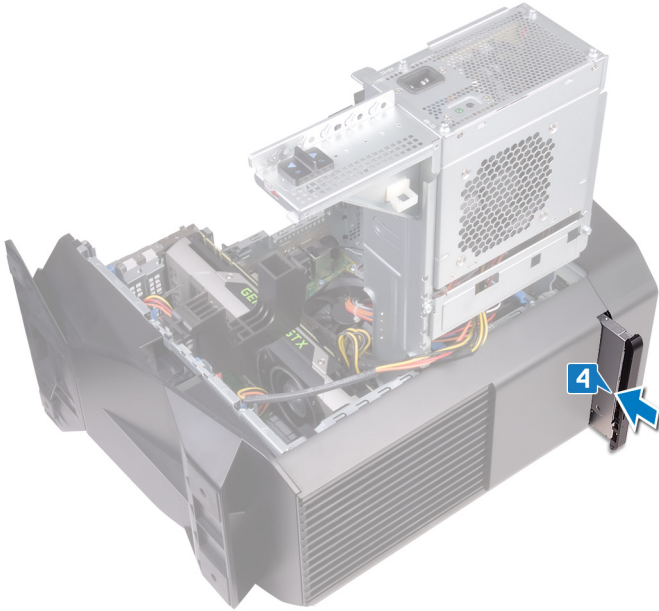

- 5 Connect the data and power cables to the optical drive.

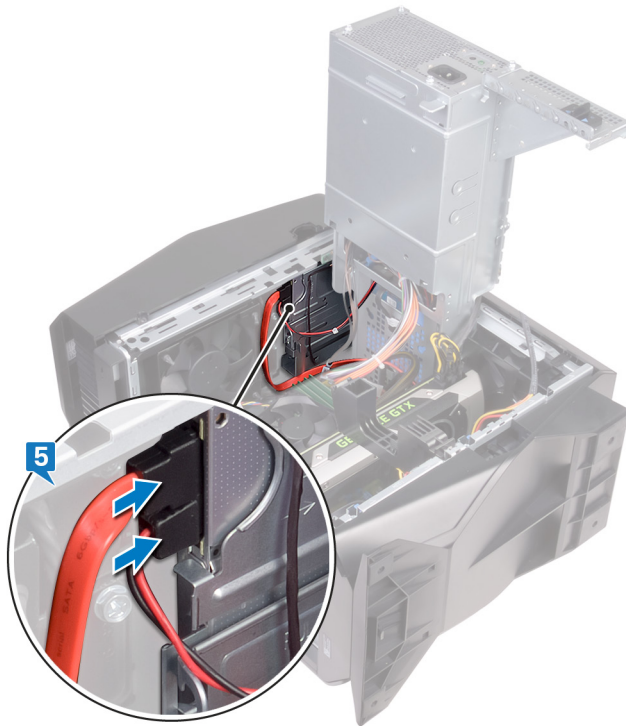

## Post-requisites

- 1 Follow the procedure from step 10 to step 11 in "[Replacing the power-supply unit](#)".
- 2 Replace the [left-side cover](#).



# Removing the front bezel

---

**⚠ WARNING:** Before working inside your computer, read the safety information that shipped with your computer and follow the steps in [Before working inside your computer](#). After working inside your computer, follow the instructions in [After working inside your computer](#). For more safety best practices, see the Regulatory Compliance home page at [www.dell.com/regulatory\\_compliance](http://www.dell.com/regulatory_compliance).

## Prerequisites

- 1 Remove the [left-side cover](#).
- 2 Remove the [right-side cover](#).
- 3 Follow the procedure from step 1 to step 3 in "[Removing the optical drive](#)".
- 4 Remove the [top cover](#).

## Procedure

- 1 Place the computer in an upright position.
- 2 Grasp and release the front bezel tabs sequentially from the top, by moving them outward from the front panel.

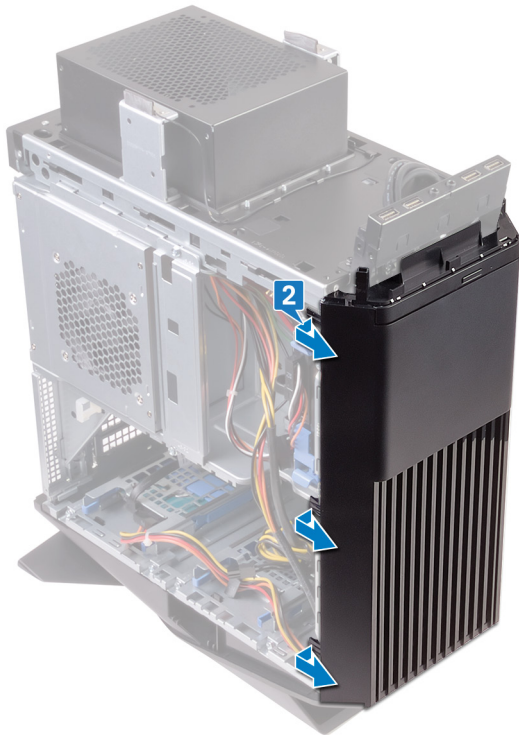



- 3 Rotate and pull the front bezel away from the front of the chassis to release the tabs on the front bezel from the slots on the front panel.

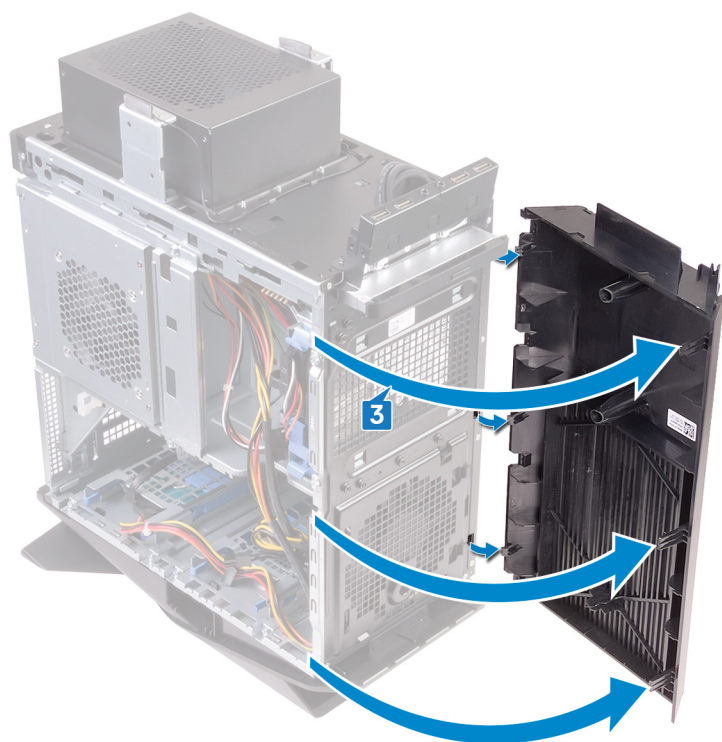

# Replacing the front bezel

**WARNING:** Before working inside your computer, read the safety information that shipped with your computer and follow the steps in [Before working inside your computer](#). After working inside your computer, follow the instructions in [After working inside your computer](#). For more safety best practices, see the Regulatory Compliance home page at [www.dell.com/regulatory\\_compliance](http://www.dell.com/regulatory_compliance).

## Procedure

- 1 Align and insert the front bezel tabs into the front panel slots.
- 2 Rotate the front bezel towards the chassis until the front bezel tabs snap into place.

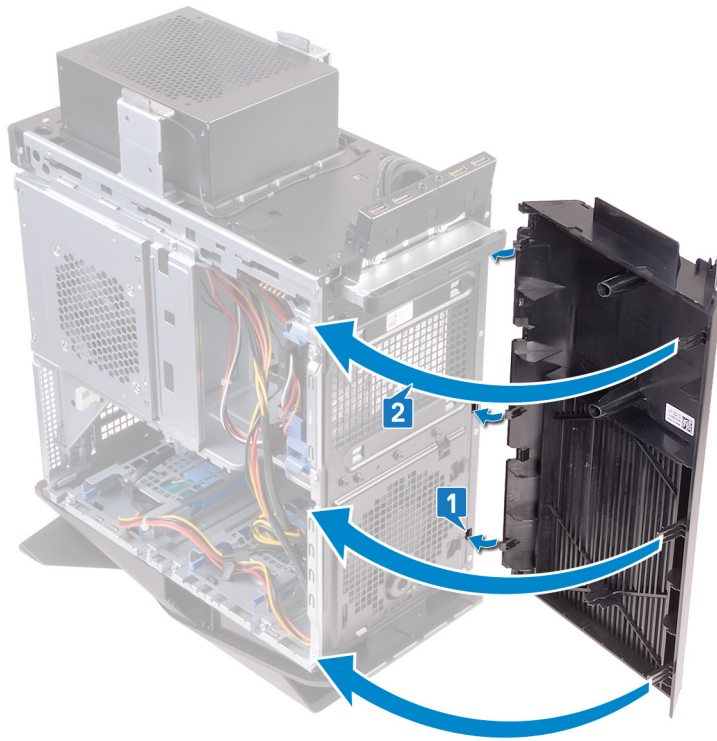

## Post-requisites

- 1 Replace the [top cover](#).
- 2 Follow the procedure from step 4 to step 5 in "[Replacing the optical drive](#)".
- 3 Replace the [right-side cover](#).
- 4 Replace the [left-side cover](#).

# Removing the power-button board

**WARNING:** Before working inside your computer, read the safety information that shipped with your computer and follow the steps in [Before working inside your computer](#). After working inside your computer, follow the instructions in [After working inside your computer](#). For more safety best practices, see the Regulatory Compliance home page at [www.dell.com/regulatory\\_compliance](http://www.dell.com/regulatory_compliance).

## Prerequisites

- 1 Remove the [left-side cover](#).
- 2 Remove the [right-side cover](#).
- 3 Remove the [top cover](#).

## Procedure

- 1 Note the power-button module cable routing and remove the cable from the routing guides on the top cover.
- 2 Remove the two screws (M3x4) that secure the power-button module to the top cover.
- 3 Lift the power-button module off the top cover.

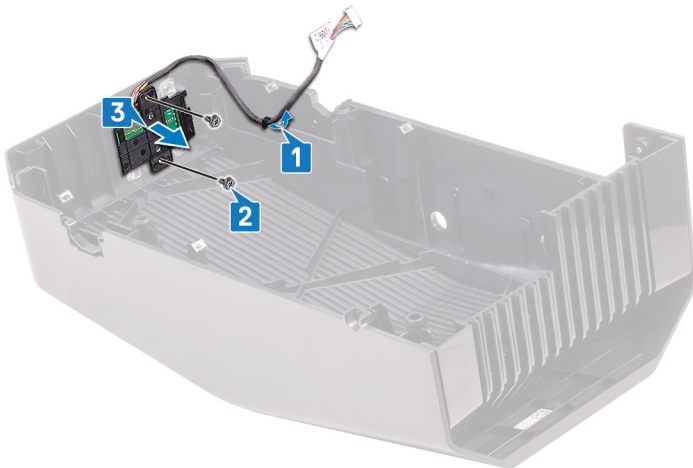

- 4 Release the power-button board from under the tabs on the power-button board bracket.
- 5 Lift the power-button board along with the cable off the power-button board bracket.

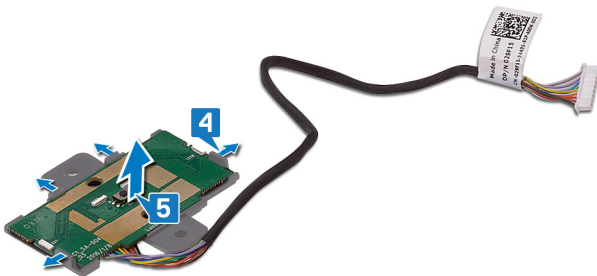



# Removing the rear trim cover

---

**WARNING:** Before working inside your computer, read the safety information that shipped with your computer and follow the steps in [Before working inside your computer](#). After working inside your computer, follow the instructions in [After working inside your computer](#). For more safety best practices, see the Regulatory Compliance home page at [www.dell.com/regulatory\\_compliance](http://www.dell.com/regulatory_compliance).

## Prerequisites

- 1 Remove the [left-side cover](#).
- 2 Remove the [right-side cover](#).
- 3 Remove the [top cover](#).

## Procedure

- 1 Place the computer in an upright position.
- 2 Using the tab, slide and remove the rear trim cover from the chassis.

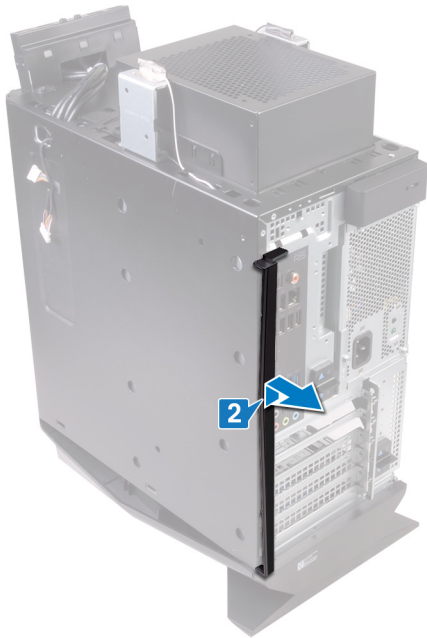

# Replacing the rear trim cover

---

**WARNING:** Before working inside your computer, read the safety information that shipped with your computer and follow the steps in [Before working inside your computer](#). After working inside your computer, follow the instructions in [After working inside your computer](#). For more safety best practices, see the Regulatory Compliance home page at [www.dell.com/regulatory\\_compliance](http://www.dell.com/regulatory_compliance).

## Procedure

Align the tabs on the rear trim cover with the slots on the chassis and snap the cover to lock it in place.



## Post-requisites

- 1 Replace the [top cover](#).
- 2 Replace the [right-side cover](#).
- 3 Replace the [left-side cover](#).

# Removing the system board

---

 **WARNING:** Before working inside your computer, read the safety information that shipped with your computer and follow the steps in [Before working inside your computer](#). After working inside your computer, follow the instructions in [After working inside your computer](#). For more safety best practices, see the Regulatory Compliance home page at [www.dell.com/regulatory\\_compliance](http://www.dell.com/regulatory_compliance).

 **NOTE:** Your computer's Service Tag is stored in the system board. You must enter the Service Tag in the BIOS setup program after you replace the system board.

 **NOTE:** Replacing the system board removes any changes you have made to the BIOS using the BIOS setup program. You must make the appropriate changes again after you replace the system board.

 **NOTE:** Before disconnecting the cables from the system board, note the location of the connectors so that you can reconnect the cables correctly after you replace the system board.

## Prerequisites

- 1 Remove the [left-side cover](#).
- 2 Follow the procedure from step 1 to step 4 in "[Removing the power-supply unit](#)".
- 3 Remove the [memory modules](#).
- 4 Remove the [solid-state drive](#).
- 5 Remove the [wireless card](#).
- 6 Remove the [processor fan and heat-sink assembly](#).
- 7 Remove the [graphics card](#).
- 8 Remove the [processor](#).

## Procedure

 **NOTE:** Note the routing of all cables as you remove them so that you can reroute them correctly after you replace the system board. For information on system board connectors, see "[System-board components](#)".

- 1 Disconnect the top panel USB cables from the system board.
- 2 Disconnect the optical drive data cable from the system board.
- 3 Disconnect the hard drive data cable from the system board.
- 4 Disconnect the front panel audio cable from the system board.
- 5 Disconnect the LED controller cable from the system board.
- 6 Disconnect the graphics-card power cable from the system board.
- 7 Disconnect the processor power cable from the system board.
- 8 Disconnect the top-chassis fan cable from the system board.
- 9 Disconnect the system-board power cable from the system board.



**10** Disconnect the front-chassis fan cable from the system board.

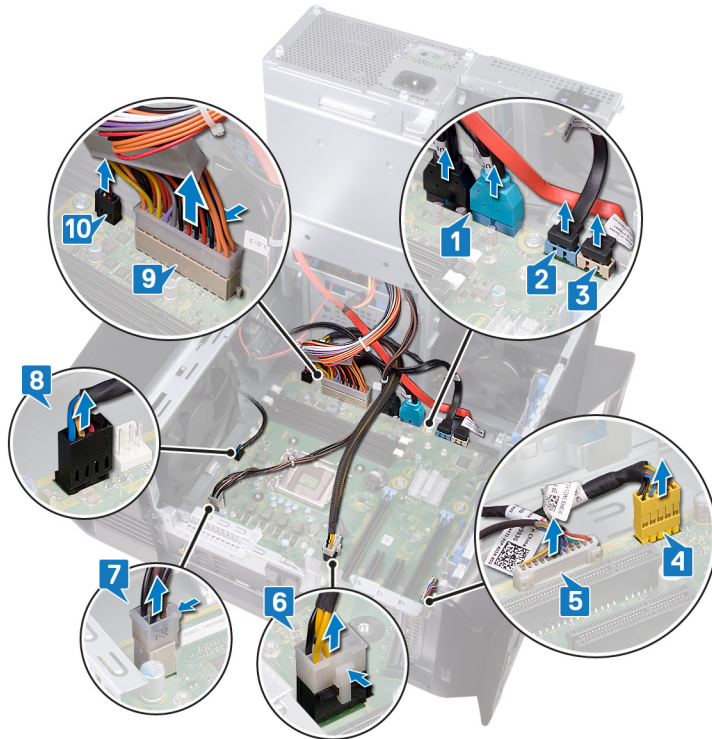

**11** Remove the eight screws (#6-32 X 1/4") that secure the system-board assembly to the chassis.

**12** Lift the system-board assembly out of the chassis.





# Replacing the system board

**⚠ WARNING:** Before working inside your computer, read the safety information that shipped with your computer and follow the steps in [Before working inside your computer](#). After working inside your computer, follow the instructions in [After working inside your computer](#). For more safety best practices, see the Regulatory Compliance home page at [www.dell.com/regulatory\\_compliance](http://www.dell.com/regulatory_compliance).

**✍ NOTE:** Your computer's Service Tag is stored in the system board. You must enter the Service Tag in the BIOS setup program after you replace the system board.

**✍ NOTE:** Replacing the system board removes any changes you have made to the BIOS using the BIOS setup program. You must make the appropriate changes again after you replace the system board.

## Procedure

- 1 Align the system-board assembly with the slots on the chassis and place the system-board assembly in position.
- 2 Slide the system-board assembly to engage the latches that secure it to the chassis.
- 3 Replace the eight screws (#6-32 X 1/4") that secure the system-board assembly to the chassis.



- 4 Route and connect the front-chassis fan cable to the system board.
- 5 Route and connect the system-board power cable to the system board.
- 6 Route and connect the top-chassis fan cable to the system board.
- 7 Route and connect the processor power cable to the system board.
- 8 Route and connect the graphics-card power cable to the system board.
- 9 Route and connect the LED controller cable to the system board.
- 10 Route and connect the front panel audio cable to the system board.
- 11 Route and connect the hard drive data cable to the system board.
- 12 Route and connect the optical drive data cable to the system board.

13 Route and connect the top panel USB cables to the system board.

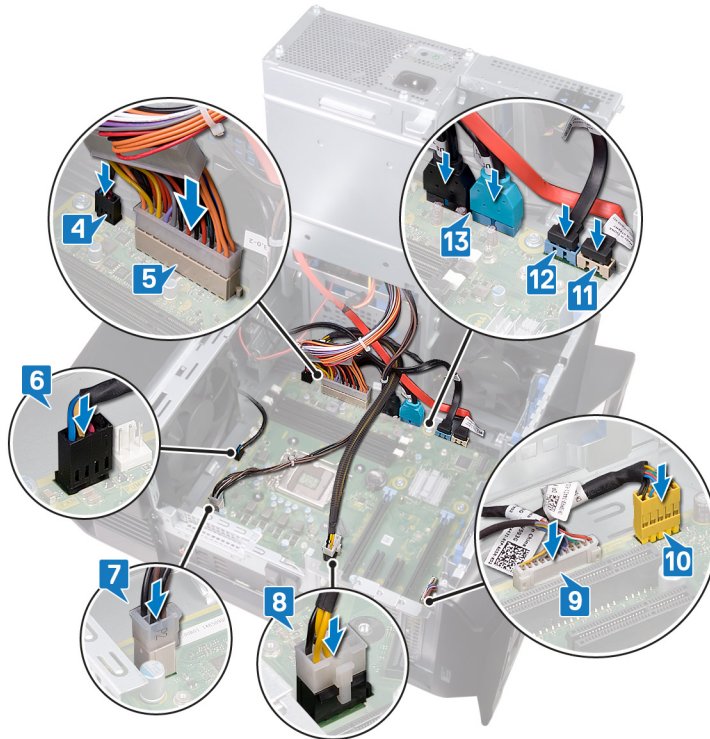

## Post-requisites

- 1 Replace the [processor](#).
- 2 Replace the [graphics card](#).
- 3 Replace the [processor fan and heat-sink assembly](#).
- 4 Replace the [wireless card](#).
- 5 Replace the [solid-state drive](#).
- 6 Replace the [memory modules](#).
- 7 Follow the procedure from step 10 to step 11 in "[Replacing the power-supply unit](#)".
- 8 Replace the [left-side cover](#).

## Entering the Service Tag in the BIOS setup program

- 1 Turn on or restart your computer.
- 2 Press F2 when the AlienHead logo is displayed to enter the BIOS setup program.
- 3 Navigate to the **Main** tab and enter the Service Tag in the **Service Tag Input** field.

# System setup

---

 **NOTE:** Depending on the computer and its installed devices, the items listed in this section may or may not be displayed.

## Boot Sequence

Boot Sequence allows you to bypass the System Setup–defined boot device order and boot directly to a specific device (for example: optical drive or hard drive). During the Power-on Self Test (POST), when the Dell logo appears, you can:

- Access System Setup by pressing F2 key
- Bring up the one-time boot menu by pressing F12 key

The one-time boot menu displays the devices that you can boot from including the diagnostic option. The boot menu options are:

- Removable Drive (if available)
- STXXXX Drive

 **NOTE:** XXX denotes the SATA drive number.

- Optical Drive (if available)
- SATA Hard Drive (if available)
- Diagnostics

 **NOTE:** Choosing Diagnostics, will display the ePSA diagnostics screen.

The boot sequence screen also displays the option to access the System Setup screen.

## Navigation keys

 **NOTE:** For most of the System Setup options, changes that you make are recorded but do not take effect until you restart the system.

Keys	Navigation
Up arrow	Moves to the previous field.
Down arrow	Moves to the next field.
Enter	Selects a value in the selected field (if applicable) or follow the link in the field.
Spacebar	Expands or collapses a drop-down list, if applicable.
Tab	Moves to the next focus area.

 **NOTE:** For the standard graphics browser only.

Esc Moves to the previous page until you view the main screen. Pressing Esc in the main screen displays a message that prompts you to save any unsaved changes and restarts the system.

## BIOS overview

 **CAUTION:** Unless you are an expert computer user, do not change the settings in the BIOS Setup program. Certain changes can make your computer work incorrectly.

 **NOTE:** Before you change BIOS Setup program, it is recommended that you write down the BIOS Setup program screen information for future reference.

Use the BIOS Setup program for the following purposes:

- Get information about the hardware installed in your computer, such as the amount of RAM and the size of the hard drive.
- Change the system configuration information.
- Set or change a user-selectable option, such as the user password, type of hard drive installed, and enabling or disabling base devices.

## Entering BIOS setup program

- 1 Turn on (or restart) your computer.
- 2 During POST, when the DELL logo is displayed, watch for the F2 prompt to appear, and then press F2 immediately.

 **NOTE: The F2 prompt indicates that the keyboard is initialized. This prompt can appear very quickly, so you must watch for it, and then press F2. If you press F2 before the F2 prompt, this keystroke is lost. If you wait too long and the operating system logo appears, continue to wait until you see the desktop. Then, turn off your computer and try again.**

## System setup options

 **NOTE: Depending on your computer and its installed devices, the items listed in this section may or may not appear.**

**Table 3. System setup options—Main menu**

Main	
System Date	Displays the current date in mm/dd/yyyy format.
System Time	Displays the current time in hh:mm:ss format.
<b>BIOS Information</b>	
BIOS Version	Displays the BIOS version number.
<b>Product Information</b>	
Product Name	Displays the product name. Default: Alienware Aurora R8.
Service Tag	Displays the service tag of your computer.
Asset Tag	Displays the asset tag of your computer.
<b>Memory Information</b>	
System Memory	Displays the total computer memory installed.
Memory Speed	Displays the memory speed.
<b>CPU Information</b>	
CPU Type	Displays the processor type
CPU Speed	Displays the speed of the processor.
CPU ID	Displays the processor identification code.
Cache L1	Displays the processor L1 cache size.
Cache L2	Displays the processor L2 cache size.
Cache L3	Displays the processor L3 cache size.

**Table 4. System setup options—Advanced menu**

<b>Advanced</b>	
<b>Advanced BIOS Features</b>	
Intel SpeedStep	Allows you to enable or disable Intel Speedstep Technology. Default: Enabled.  <b>NOTE: If enabled, the processor clock speed and core voltage are adjusted dynamically based on the processor load.</b>
Virtualization	Allows you to enable or disable Intel Virtualization Technology feature for the processor.
VT for Direct I/O	Allows you to enable or disable Intel Virtualization Technology feature for the Direct I/O.
SATA Operation	Allows you to configure the operating mode of the integrated SATA hard drive controller.
Intel Ready Mode Technology	Allows you to enable or disable the Intel Ready Mode Technology.
Intel Software Guard Extensions	Allows you to enable or disable Intel Software Guard Extensions.
BIOS Recovery from Hard Drive	Allows you to enable or disable BIOS Recovery from hard drive.
<b>USB Configuration</b>	
Front USB Ports	Allows you to enable or disable the front USB ports.
Rear USB Ports	Allows you to enable or disable the rear USB ports.
<b>Power Options</b>	
Numlock Key	Allows you to set the status of the Num Lock key during boot to On or Off.
Wake Up by Integrated LAN	Allow the computer to be powered on by special LAN signals.
AC Recovery	Sets what action the computer takes when power is restored.
Deep Sleep Control	Allows you to define the controls when Deep Sleep is enabled.
USB Wake Support (S3)	Allows you to enable the USB devices to wake the system from Standby.
USB PowerShare (S4/S5)	Allows you to charge external devices.
USB PowerShare Wake Support (S4/S5)	Allows you to enable front the USB devices to wake the system from S4/S5.
Auto Power On	
Auto Power On Mode	Allows you to set the computer to turn on automatically every day or on a preselected date. This option can be configured only if the Auto Power On mode is set to Enabled Everyday or Selected Day.
Auto Power On Date	Allows you to set the date on which the computer must turn on automatically. This option can be configured only if the Auto Power On mode is set to Enabled 1 to 31.
Auto Power On Time	Allows you to set the time at which the computer must turn on automatically. This option can be configured only if the Auto Power On mode is set to Enabled hh:mm:ss.

---

**Advanced**

---

**Performance Options**

## Overclocking Feature

Core Over Clocking Level	Allows you enable or disable the OC level1/level2 setting and adjust the processor flex ratio and voltage in the Customization mode.
Computrace	Allows you to enable or disable the Computrace service using the Absolute software.
Core Ratio Limit Override	Allows you to set the core ratio limit.
Single Core	Allows you to select single core or multiple cores.
Core Voltage Mode	Allows you to select between adaptive and override voltage modes.
Core Voltage Offset	Allows you to set the override value of core voltage.
Long Duration PWR Limit	Allows you to set the turbo mode power limit.
Short Duration PWR Limit Options	Allows you to set the turbo mode power limit.
XMP Memory	Allows you to set the XMP memory.

**Table 5. System setup options—Security menu**

---

**Security**

---

Admin Password Status	Displays whether the admin password is set.
System Password Status	Displays whether the system password is set.
HDD Password Status	Displays if the hard drive password is set.
Admin Password	Displays the admin password.
System Password	Displays the system password.
HDD Password	Displays the hard drive password.
Firmware TPM	Displays the firmware TPM.

**Table 6. System setup options—Boot menu**

---

**Boot**

---

Boot List Option	Displays the available boot devices.
File Browser Add Boot Option	Allows you to set the boot path in the boot option list.
File Browser Del Boot Option	Allows you to delete the boot path in the boot option list.
Secure Boot Control	Allows you to enable or disable the secure boot control.
Load Legacy OPROM	Allows you to enable or disable the Legacy Option ROM.
Boot Option Priorities	Displays the available boot devices.
Boot Option #1	Displays the first boot device. Default: UEFI: Windows Boot Manager.
Boot Option #2	Displays the second boot device. Default: Onboard NIC Device.
Boot Option #3	Displays the third boot device. Default: Onboard NIC Device.

**Table 7. System setup options—Exit menu**

Save & Exit	
Save Changes and Reset	Allows you to exit system setup and save your changes.
Discard Changes and Reset	Allows you to exit system setup and load previous values for all system setup options.
Restore Defaults	Allows you to load default values for all system setup options.
Discard Changes	Allows you to exit your changes.
Save Changes	Allows you to save your changes.

## Clearing CMOS Settings

**⚠ WARNING:** Before working inside your computer, read the safety information that shipped with your computer and follow the steps in [Before working inside your computer](#). After working inside your computer, follow the instructions in [After working inside your computer](#). For more safety best practices, see the Regulatory Compliance home page at [www.dell.com/regulatory\\_compliance](http://www.dell.com/regulatory_compliance).

### Procedure

- 1 Locate the CMOS jumper (P217) on the system board.  
For information on the location of the CMOS jumper, see "[System-board components](#)".
- 2 Disconnect the system-board power cable from the system board.
- 3 Remove the jumper plug from pins 217 and replace it on pins 216 (P216).
- 4 Wait for 5 seconds.
- 5 Remove the jumper plug from pins 216 and replace it on pins 217.

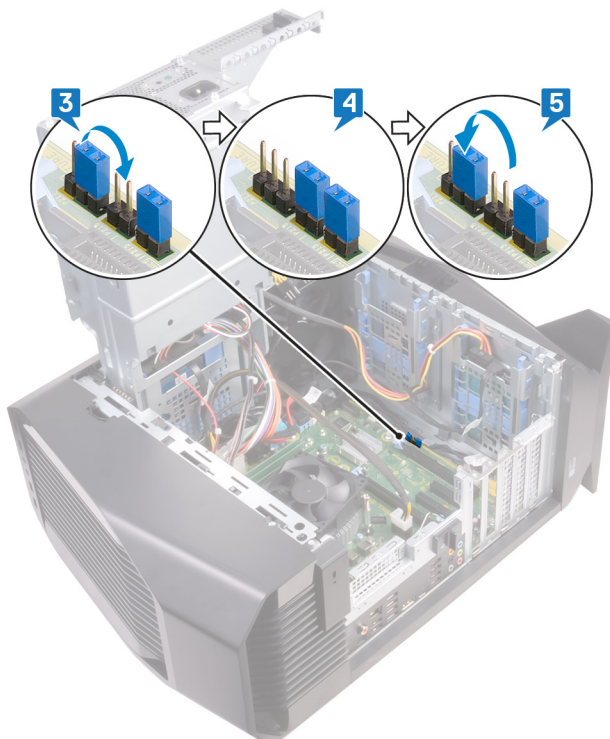

- 6 Connect the system-board power cable to the system board.

# Clearing forgotten passwords

**WARNING:** Before working inside your computer, read the safety information that shipped with your computer and follow the steps in [Before working inside your computer](#). After working inside your computer, follow the instructions in [After working inside your computer](#). For more safety best practices, see the Regulatory Compliance home page at [www.dell.com/regulatory\\_compliance](http://www.dell.com/regulatory_compliance).

## Procedure

- 1 Locate the password jumper (P215) on the system board.  
For information on the location of the Password jumper, see [System-board components](#).
- 2 Remove the jumper plug from pins 215.
- 3 Follow the procedure from step 8 to step 9 in "[Replacing the power-supply unit](#)".
- 4 Replace the [left-side cover](#).
- 5 Turn on your computer and wait until the operating system is completely loaded.
- 6 Shut down your computer.
- 7 Remove the [left-side cover](#).
- 8 Follow the procedure from step 1 to step 3 in "[Removing the power-supply unit](#)".
- 9 Replace the jumper plug on pins 215.

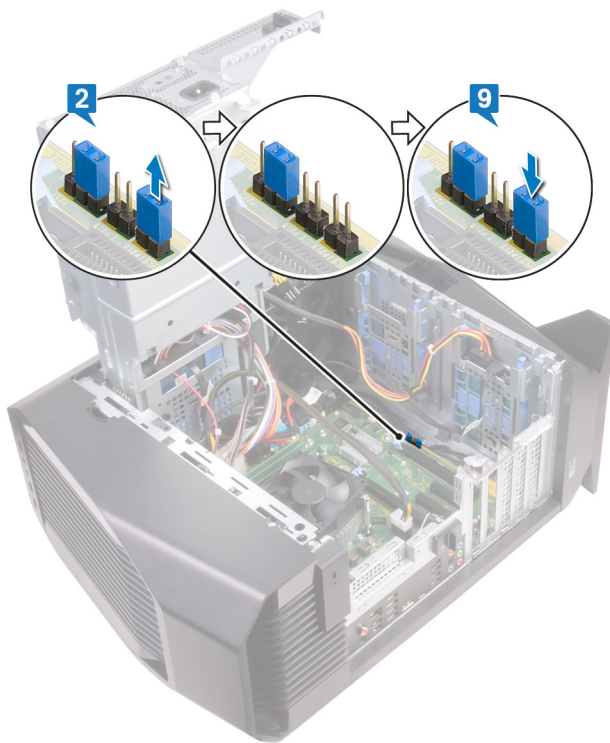

## Flashing the BIOS

You may need to flash (update) the BIOS when an update is available or when you replace the system board. Follow these steps to flash the BIOS:

- 1 Turn on your computer.
- 2 Go to [www.dell.com/support](http://www.dell.com/support).



3 Click **Product support**, enter the Service Tag of your computer, and then click **Submit**.



**NOTE: If you do not have the Service Tag, use the auto-detect feature or manually browse for your computer model.**

4 Click **Drivers & downloads** → **Find it myself**.

5 Select the operating system installed on your computer.

6 Scroll down the page and expand **BIOS**.

7 Click **Download** to download the latest version of the BIOS for your computer.

8 After the download is complete, navigate to the folder where you saved the BIOS update file.

9 Double-click the BIOS update file icon and follow the instructions on the screen.

# Troubleshooting

---

## Enhanced Pre-Boot System Assessment (ePSA) diagnostics

 **CAUTION:** Use the ePSA diagnostics to test only your computer. Using this program with other computers may cause invalid results or error messages.

The ePSA diagnostics (also known as system diagnostics) performs a complete check of your hardware. The ePSA is embedded with the BIOS and is launched by the BIOS internally. The embedded system diagnostics provides a set of options for particular devices or device groups allowing you to:

- Run tests automatically or in an interactive mode
- Repeat tests
- Display or save test results
- Run thorough tests to introduce additional test options to provide extra information about the failed device(s)
- View status messages that inform you if tests are completed successfully
- View error messages that inform you of problems encountered during testing

 **NOTE:** Some tests for specific devices require user interaction. Always ensure that you are present at the computer terminal when the diagnostic tests are performed.

For more information, see [Dell ePSA Diagnostic 3.0](#).

### Running the ePSA Diagnostics

Invoke diagnostics boot by either of the methods that are suggested below:

- 1 Power on the computer.
- 2 As the computer boots, press the F12 key when the Dell logo is displayed.
- 3 In the boot menu screen, use Up/Down arrow key to select the **Diagnostics** option and then press **Enter**.

 **NOTE:** The Enhanced Pre-boot System Assessment window displays, listing all devices detected in the computer. The diagnostics starts running the tests on all the detected devices.

- 4 Press the arrow in the lower-right corner to go to the page listing.  
The detected items are listed and tested.
- 5 To run a diagnostic test on a specific device, press Esc and click **Yes** to stop the diagnostic test.
- 6 Select the device from the left pane and click **Run Tests**.
- 7 If there are any issues, error codes are displayed.  
Note the error code and contact Dell.  
or
- 8 Shut down the computer.
- 9 Press and hold the Fn key, while pressing the power button, and then release both.
- 10 Repeat steps 3–7 above.

### System diagnostic lights

The computer POST (Power On Self Test) ensures that it meets the basic computer requirements and the hardware is working appropriately before the boot process begins. If the computer passes the POST, the computer continues to start in a normal mode. However, if the computer fails the POST, the computer emits a series of LED codes in amber color during the start-up. The following table shows different light patterns and what they indicate.

**Table 8. Diagnostics**

Number of Power LED flashes	Problem description
1	System board: BIOS and ROM failure
2	No memory or RAM detected
3	System board or chipset error
4	Memory or RAM failure
5	CMOS battery failure
6	Video card or chip failure
7	CPU failure
3,6	BIOS recovery image not found
3,7	BIOS recovery image found but invalid

## Flashing BIOS (USB key)

- 1 Follow the procedure from step 1 to step 7 in "[Flashing the BIOS](#)" to download the latest BIOS setup program file.
- 2 Create a bootable USB drive. For more information see the knowledge base article [SLN143196](#) at [www.dell.com/support](http://www.dell.com/support).
- 3 Copy the BIOS setup program file to the bootable USB drive.
- 4 Connect the bootable USB drive to the computer that needs the BIOS update.
- 5 Restart the computer and press **F12** when the Dell logo is displayed on the screen.
- 6 Boot to the USB drive from the **One Time Boot Menu**.
- 7 Type the BIOS setup program filename and press **Enter**.
- 8 The **BIOS Update Utility** appears. Follow the instructions on the screen to complete the BIOS update.

## Flashing the BIOS

You may need to flash (update) the BIOS when an update is available or when you replace the system board. Follow these steps to flash the BIOS:

- 1 Turn on your computer.
- 2 Go to [www.dell.com/support](http://www.dell.com/support).
- 3 Click **Product support**, enter the Service Tag of your computer, and then click **Submit**.  
 **NOTE: If you do not have the Service Tag, use the auto-detect feature or manually browse for your computer model.**
- 4 Click **Drivers & downloads** → **Find it myself**.
- 5 Select the operating system installed on your computer.
- 6 Scroll down the page and expand **BIOS**.
- 7 Click **Download** to download the latest version of the BIOS for your computer.
- 8 After the download is complete, navigate to the folder where you saved the BIOS update file.
- 9 Double-click the BIOS update file icon and follow the instructions on the screen.

## Backup media and recovery options

Dell proposes multiple options for recovering Windows operating system on your Dell PC. For more information, see [Dell Windows Backup Media and Recovery Options](#).

## Wi-Fi power cycle

If your computer is unable to access the internet due to Wi-Fi connectivity issues a Wi-Fi power cycle procedure may be performed. The following procedure provides the instructions on how to conduct a Wi-Fi power cycle:

 **NOTE: Some ISPs (Internet Service Providers) provide a modem/router combo device.**

- 1 Turn off your computer.
- 2 Turn off the modem.
- 3 Turn off the wireless router.
- 4 Wait for 30 seconds.
- 5 Turn on the wireless router.
- 6 Turn on the modem.
- 7 Turn on your computer.

## Flea power release

Flea power is the residual static electricity that remains on the computer even after it has been powered off and the battery has been removed. The following procedure provides the instructions on how to conduct flea power release:

- 1 Turn off your computer.
- 2 Disconnect the power adapter from your computer.
- 3 Press and hold the power button for 15 seconds to drain the flea power.
- 4 Connect the power adapter to your computer.
- 5 Turn on your computer.



# Getting help and contacting Dell

---

## Self-help resources



You can get information and help on Dell products and services using these self-help resources:

**Table 9. Self-help resources**

Information about Dell products and services	<a href="http://www.dell.com">www.dell.com</a>
Dell Help & Support app	
Tips	
Contact Support	In Windows search, type <code>Contact Support</code> , and press Enter.
Online help for operating system	<a href="http://www.dell.com/support/windows">www.dell.com/support/windows</a> <a href="http://www.dell.com/support/linux">www.dell.com/support/linux</a>
Troubleshooting information, user manuals, setup instructions, product specifications, technical help blogs, drivers, software updates, and so on.	<a href="http://www.dell.com/support">www.dell.com/support</a>
Dell knowledge base articles for a variety of computer concerns.	<ol style="list-style-type: none"><li>1 Go to <a href="http://www.dell.com/support">www.dell.com/support</a>.</li><li>2 Type the subject or keyword in the <b>Search</b> box.</li><li>3 Click <b>Search</b> to retrieve the related articles.</li></ol>
Learn and know the following information about your product: <ul style="list-style-type: none"><li>▪ Product specifications</li><li>▪ Operating system</li><li>▪ Setting up and using your product</li><li>▪ Data backup</li><li>▪ Troubleshooting and diagnostics</li><li>▪ Factory and system restore</li><li>▪ BIOS information</li></ul>	<p>See <i>Me and My Dell</i> at <a href="http://www.dell.com/support/manuals">www.dell.com/support/manuals</a>. To locate the <i>Me and My Dell</i> relevant to your product, identify your product through one of the following:</p> <ul style="list-style-type: none"><li>▪ Select <b>Detect Product</b>.</li><li>▪ Locate your product through the drop-down menu under <b>View Products</b>.</li><li>▪ Enter the <b>Service Tag number</b> or <b>Product ID</b> in the search bar.</li></ul>

## Contacting Dell

To contact Dell for sales, technical support, or customer service issues, see [www.dell.com/contactdell](http://www.dell.com/contactdell).

-  **NOTE: Availability varies by country and product, and some services may not be available in your country.**
-  **NOTE: If you do not have an active internet connection, you can find contact information on your purchase invoice, packing slip, bill, or Dell product catalog.**