

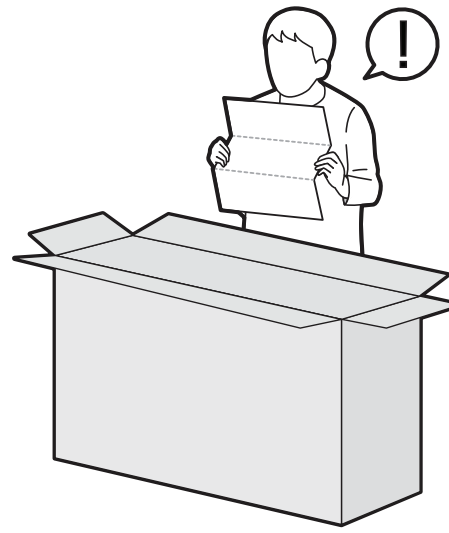

UN74*

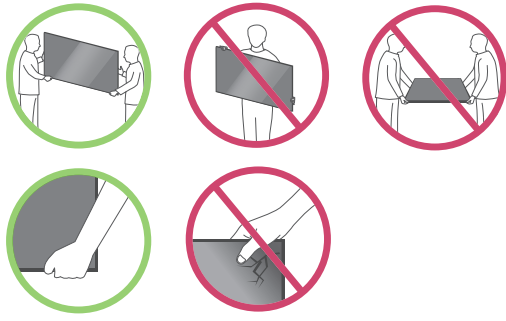

1

43/50/55UN74*

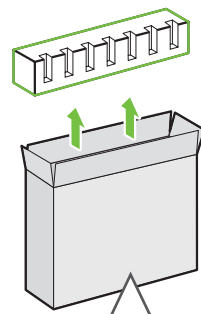

2

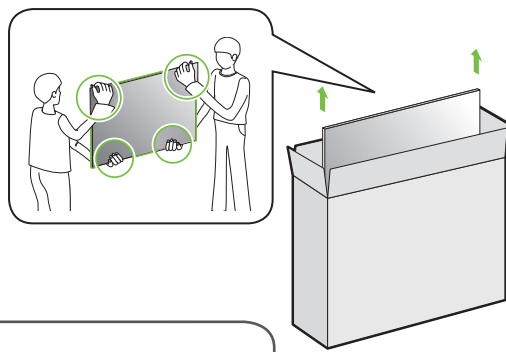

3

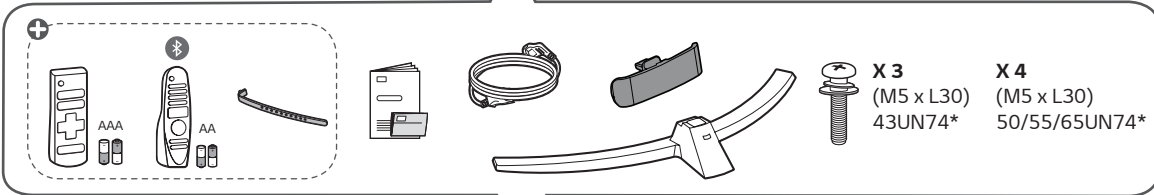
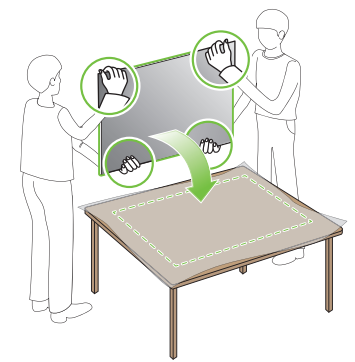

1

65UN74*

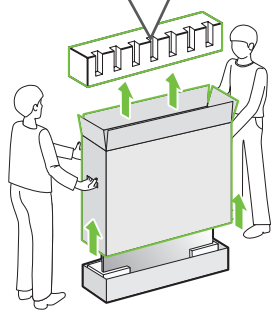

2

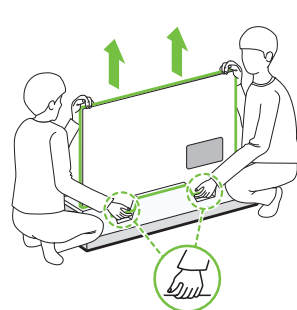

3

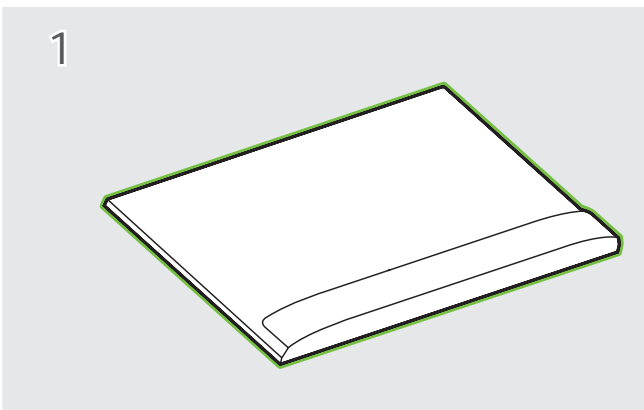
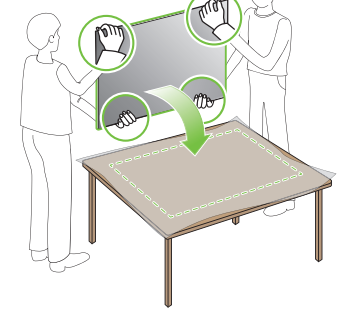

1

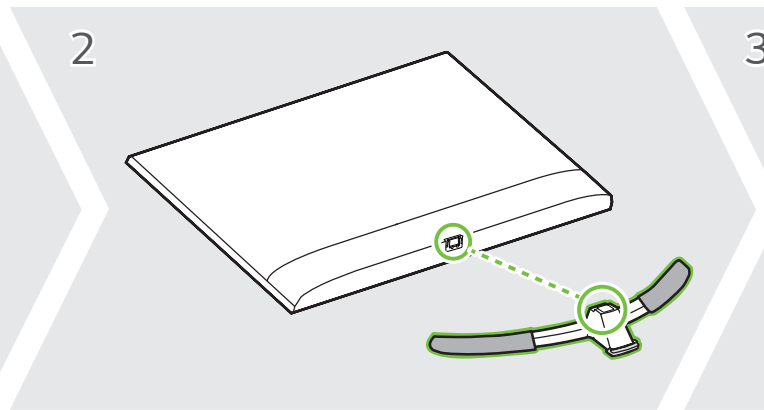

2

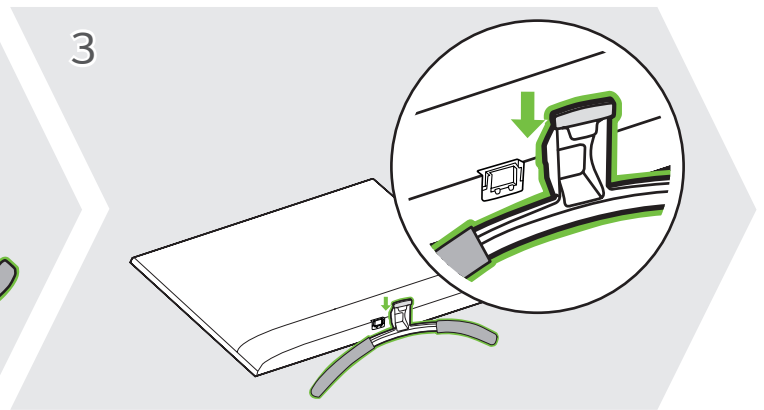

3

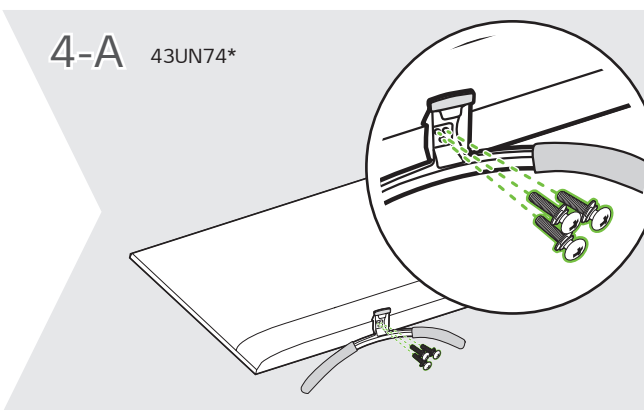

4-A 43UN74*

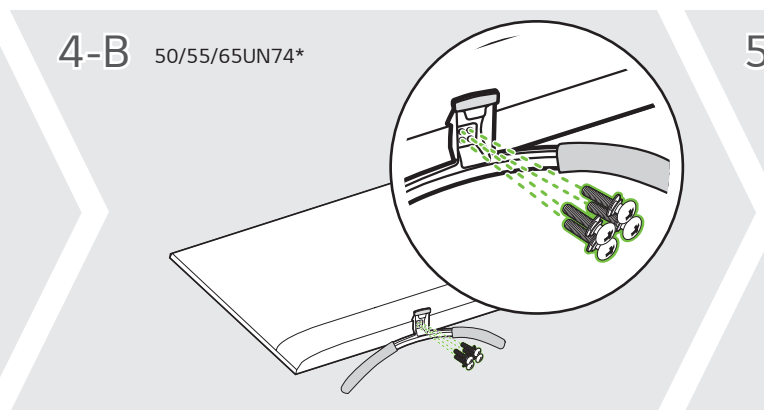

4-B 50/55/65UN74*

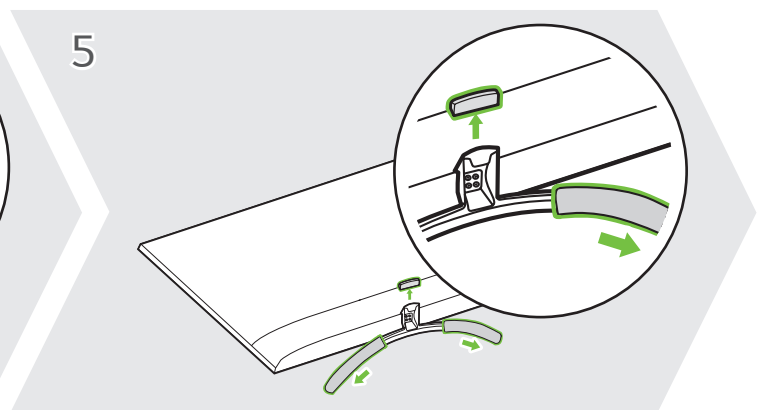

5

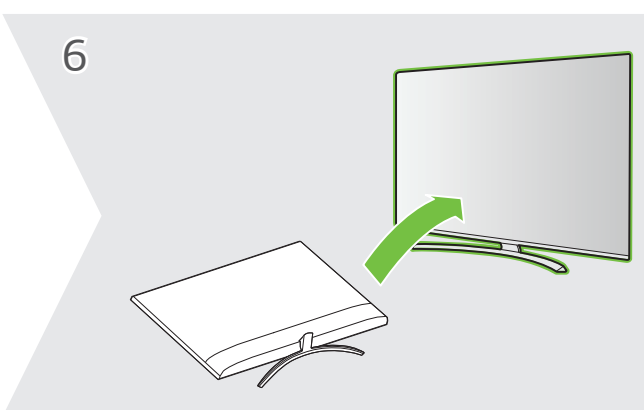

6

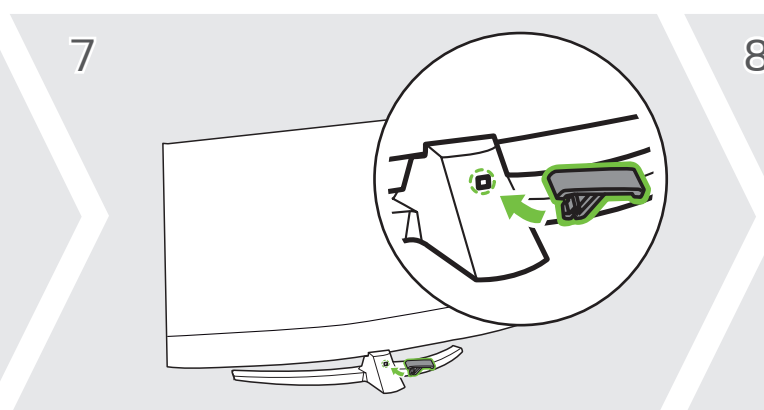

7

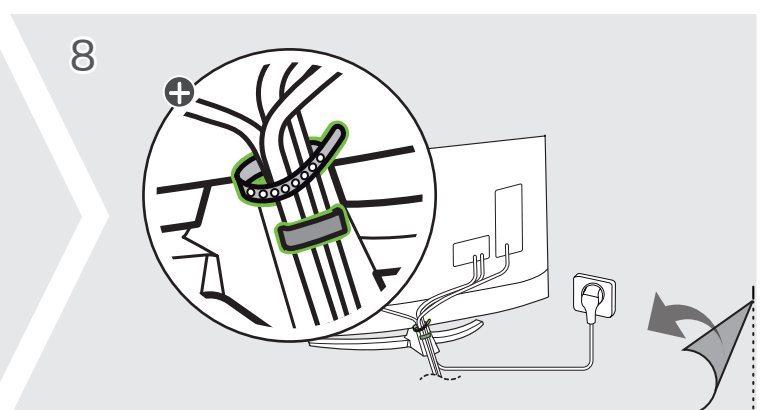

8

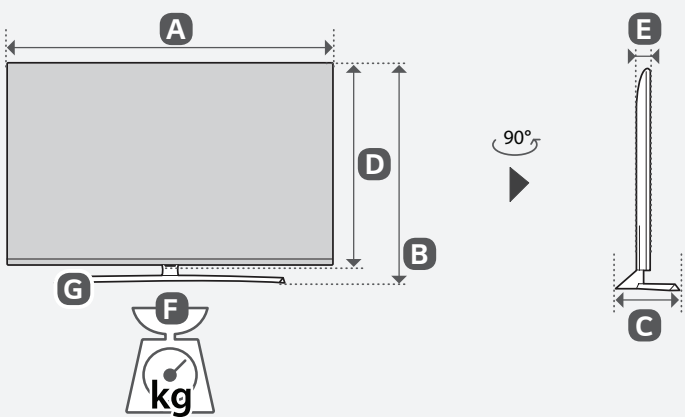
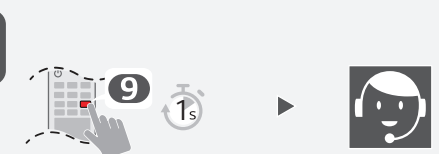
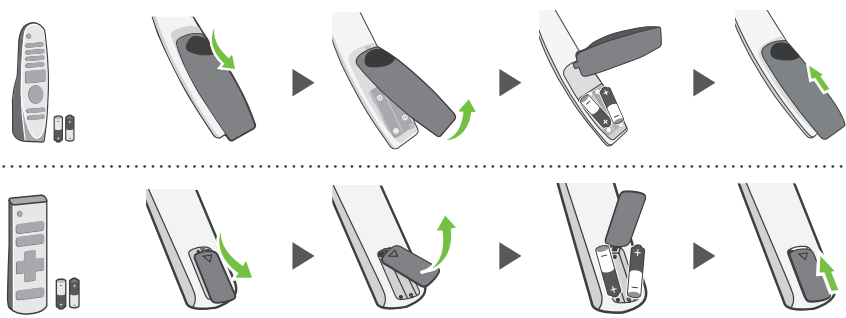
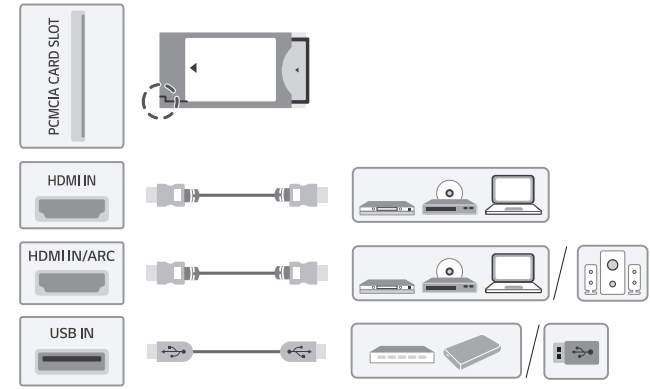
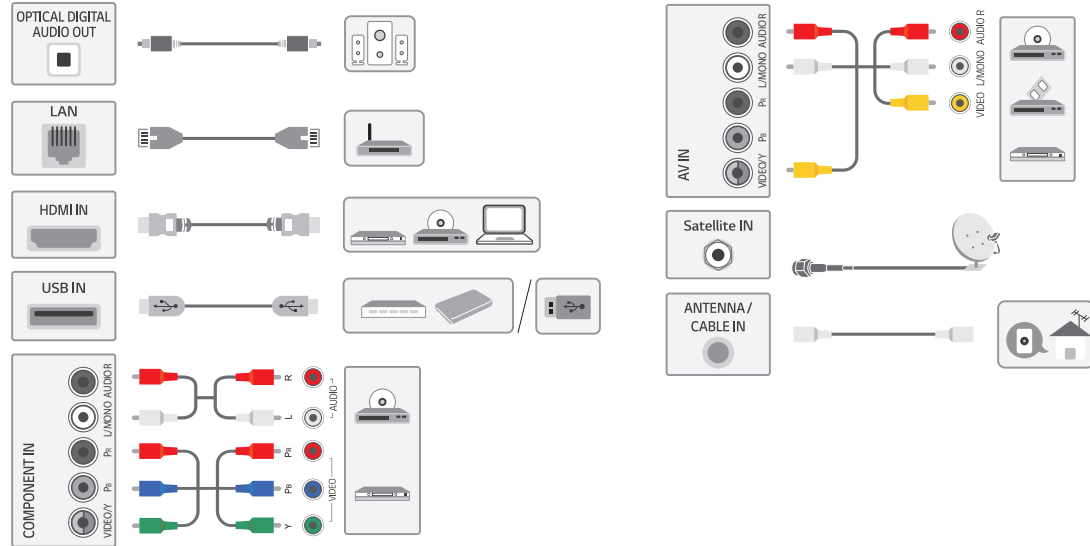

	A	B	C	D	E	F	F-G
	(mm)					(kg)	
43UN74006LB 43UN74003LB 43UN74006LA 43UN74007LB	973	622	221	572	85.0	9.0	8.2
50UN74006LB 50UN74003LB 50UN74006LA 50UN74007LB	1130	728	260	663	86.3	12.5	11.5
55UN74006LB 55UN74003LB 55UN74006LA 55UN74007LB	1244	791	260	726	87.1	15.6	14.6
65UN74006LB 65UN74003LB 65UN74006LA 65UN74007LB	1463	914	340	850	87.8	22.4	21.4
Power requirement				AC 100-240 V - 50 / 60 Hz			



English · Read Safety and Regulatory.

Deutsch · Lesen Sie die **Sicherheitsanweisungen und Richtlinien**.

Français · Lire le document **Sécurité et mesures réglementaires**.

Italiano · Leggere il manuale **Sicurezza e normative**.

Español · Leer **Seguridad y normativa**.

Português · Ler informações sobre a **Segurança e Regulamentos**.

Nederlands · **Veiligheidsinformatie en regelgeving** lezen.

Ελληνικά · Διαβάστε τις **οδηγίες για την ασφάλεια και τους κανονισμούς**.

Slovenščina · Preberite **varnostne in regulativne vidike**.

Hrvatski · Pročitajte **Sigurnost i usklađenost s propisima**.

Shqip · Lexoni paragrafin "**Siguria dhe rregullimi**".

Bosanski · Pročitajte dio **Sigurnost i propisi**.

Македонски · Прочитајте за **безбедноста и регулативата**.

Svenska · Läs **Säkerhet och föreskrifter**.

Magyar · Biztonsági szabályzat megtekintése.

Polski · Prosimy o przeczytanie **Zasad bezpieczeństwa i uwag dotyczących przepisów**.

Česky · Přečtěte si část **Bezpečnost a zákonné předpisy**.

Slovenčina · Prečitajte si **bezpečnostné a regulačné informácie**.

Română · Consultați manualul referitor la **siguranță și reglementare**.

Български · Прочетете **Безопасност и регулаторни стандарти**.

Eesti · Lugege **ohutus- ja normatiivteavet**.

Lietuvių k. · Perskaitykite **Saugos ir norminius reikalavimus**.

Latviešu · Izlasiet sadaļu **Drošība un normatīvi**.

Srpski · Pročitajte odeljak **Bezbednost i regulatorna pitanja**.

Norsk · Les **sikkerhet og forskrifter**.

Dansk · Læs **sikkerhed og lovmæssige bestemmelser**.

Suomi · Lue **Turvallisuus ja säännökset** -osio.

⊕ : Depending on model / Abhängig vom Modell / Selon le modèle / In base al modello / En función del modelo / Dependendo do modelo / Afhankelijk van het model / Αν λογα με το μοντ λο / Odvisno od modela / Tipusfüggő / Zależnie od modelu / Závisí na modelu / V závislosti od modelu / În funcție de model / В зависимости от модели / Sõltub mudelist / Priklauso nuo modelio / Atkarībā no modeļa / U zavisnosti od modela / Ovisno o modelu / Në varësi të modelit / Ovisno o modelu / во зависност од моделот / Beroende på modell / Avhengigt af modellen / Mallin mukaan