

TUF GAMING Z490-PLUS

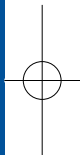

ASUS

Motherboard

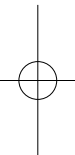
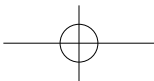

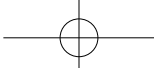

E16552
Revised Edition v2
March 2020

Copyright © 2020 ASUSTeK COMPUTER INC. All Rights Reserved.

No part of this manual, including the products and software described in it, may be reproduced, transmitted, transcribed, stored in a retrieval system, or translated into any language in any form or by any means, except documentation kept by the purchaser for backup purposes, without the express written permission of ASUSTeK COMPUTER INC. ("ASUS").

Product warranty or service will not be extended if: (1) the product is repaired, modified or altered, unless such repair, modification or alteration is authorized in writing by ASUS; or (2) the serial number of the product is defaced or missing.

ASUS PROVIDES THIS MANUAL "AS IS" WITHOUT WARRANTY OF ANY KIND, EITHER EXPRESS OR IMPLIED, INCLUDING BUT NOT LIMITED TO THE IMPLIED WARRANTIES OR CONDITIONS OF MERCHANTABILITY OR FITNESS FOR A PARTICULAR PURPOSE. IN NO EVENT SHALL ASUS, ITS DIRECTORS, OFFICERS, EMPLOYEES OR AGENTS BE LIABLE FOR ANY INDIRECT, SPECIAL, INCIDENTAL, OR CONSEQUENTIAL DAMAGES (INCLUDING DAMAGES FOR LOSS OF PROFITS, LOSS OF BUSINESS, LOSS OF USE OR DATA, INTERRUPTION OF BUSINESS AND THE LIKE), EVEN IF ASUS HAS BEEN ADVISED OF THE POSSIBILITY OF SUCH DAMAGES ARISING FROM ANY DEFECT OR ERROR IN THIS MANUAL OR PRODUCT.

SPECIFICATIONS AND INFORMATION CONTAINED IN THIS MANUAL ARE FURNISHED FOR INFORMATIONAL USE ONLY, AND ARE SUBJECT TO CHANGE AT ANY TIME WITHOUT NOTICE, AND SHOULD NOT BE CONSTRUED AS A COMMITMENT BY ASUS. ASUS ASSUMES NO RESPONSIBILITY OR LIABILITY FOR ANY ERRORS OR INACCURACIES THAT MAY APPEAR IN THIS MANUAL, INCLUDING THE PRODUCTS AND SOFTWARE DESCRIBED IN IT.

Products and corporate names appearing in this manual may or may not be registered trademarks or copyrights of their respective companies, and are used only for identification or explanation and to the owners' benefit, without intent to infringe.

Offer to Provide Source Code of Certain Software

This product contains copyrighted software that is licensed under the General Public License ("GPL"), under the Lesser General Public License Version ("LGPL") and/or other Free Open Source Software Licenses. Such software in this product is distributed without any warranty to the extent permitted by the applicable law. Copies of these licenses are included in this product.

Where the applicable license entitles you to the source code of such software and/or other additional data, you may obtain it for a period of three years after our last shipment of the product, either

(1) for free by downloading it from <https://www.asus.com/support/>

or

(2) for the cost of reproduction and shipment, which is dependent on the preferred carrier and the location where you want to have it shipped to, by sending a request to:

ASUSTeK Computer Inc.
Legal Compliance Dept.
1F., No. 15, Lide Rd.,
Beitou Dist., Taipei City 112
Taiwan

In your request please provide the name, model number and version, as stated in the About Box of the product for which you wish to obtain the corresponding source code and your contact details so that we can coordinate the terms and cost of shipment with you.

The source code will be distributed WITHOUT ANY WARRANTY and licensed under the same license as the corresponding binary/object code.

This offer is valid to anyone in receipt of this information.

ASUSTeK is eager to duly provide complete source code as required under various Free Open Source Software licenses. If however you encounter any problems in obtaining the full corresponding source code we would be much obliged if you give us a notification to the email address gpl@asus.com, stating the product and describing the problem (please DO NOT send large attachments such as source code archives, etc. to this email address).

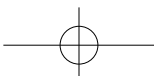

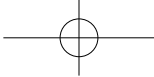

Contents

- Safety information..... iv
- About this guide..... v
- TUF GAMING Z490-PLUS specifications summary..... vi
- Connectors with shared bandwidth x
- Package contents..... xi
- Installation tools and components..... xii

Chapter 1: Product Introduction

- 1.1 Before you proceed 1-1
- 1.2 Motherboard layout..... 1-2

Chapter 2: Basic Installation

- 2.1 Building your PC system..... 2-1
 - 2.1.1 CPU installation..... 2-1
 - 2.1.2 Cooling system installation..... 2-3
 - 2.1.3 DIMM installation..... 2-5
 - 2.1.4 M.2 installation 2-6
 - 2.1.5 Fan bracket installation 2-7
 - 2.1.6 Motherboard installation..... 2-8
 - 2.1.7 ATX power connection 2-10
 - 2.1.8 SATA device connection 2-11
 - 2.1.9 Front I/O connector 2-12
 - 2.1.10 Expansion card installation 2-13
- 2.2 Motherboard rear and audio connections 2-15
 - 2.2.1 Rear I/O connection 2-15
 - 2.2.2 Audio I/O connections 2-16
- 2.3 Starting up for the first time..... 2-19
- 2.4 Turning off the computer 2-19

Chapter 3: BIOS and RAID Support

- 3.1 Knowing BIOS 3-1
- 3.2 BIOS setup program 3-2
- 3.3 ASUS EZ Flash 3 3-3
- 3.4 ASUS CrashFree BIOS 3..... 3-4
- 3.5 RAID configurations 3-5

Appendix

- Notices A-1
- ASUS contact information..... A-6

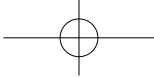

Safety information

Electrical safety

- To prevent electrical shock hazard, disconnect the power cable from the electrical outlet before relocating the system.
- When adding or removing devices to or from the system, ensure that the power cables for the devices are unplugged before the signal cables are connected. If possible, disconnect all power cables from the existing system before you add a device.
- Before connecting or removing signal cables from the motherboard, ensure that all power cables are unplugged.
- Seek professional assistance before using an adapter or extension cord. These devices could interrupt the grounding circuit.
- Ensure that your power supply is set to the correct voltage in your area. If you are not sure about the voltage of the electrical outlet you are using, contact your local power company.
- If the power supply is broken, do not try to fix it by yourself. Contact a qualified service technician or your retailer.

Operation safety

- Before installing the motherboard and adding devices on it, carefully read all the manuals that came with the package.
- Before using the product, ensure all cables are correctly connected and the power cables are not damaged. If you detect any damage, contact your dealer immediately.
- To avoid short circuits, keep paper clips, screws, and staples away from connectors, slots, sockets and circuitry.
- Avoid dust, humidity, and temperature extremes. Do not place the product in any area where it may become wet.
- Place the product on a stable surface.
- If you encounter technical problems with the product, contact a qualified service technician or your retailer.
- Your motherboard should only be used in environments with ambient temperatures between 0°C and 40°C.

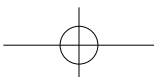

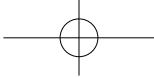

About this guide

This user guide contains the information you need when installing and configuring the motherboard.

How this guide is organized

This guide contains the following parts:

- **Chapter 1: Product Introduction**
This chapter describes the features of the motherboard and the new technology it supports. It includes description of the switches, jumpers, and connectors on the motherboard.
- **Chapter 2: Basic Installation**
This chapter lists the hardware setup procedures that you have to perform when installing system components.
- **Chapter 3: BIOS and RAID Support**
This chapter tells how to boot into the BIOS, upgrade BIOS using the EZ Flash Utility and support on RAID.

Where to find more information

Refer to the following sources for additional information and for product and software updates.

1. **ASUS website**
The ASUS website (www.asus.com) provides updated information on ASUS hardware and software products.
2. **Optional documentation**
Your product package may include optional documentation, such as warranty flyers, that may have been added by your dealer. These documents are not part of the standard package.

Conventions used in this guide

To ensure that you perform certain tasks properly, take note of the following symbols used throughout this manual.



CAUTION: Information to prevent damage to the components and injuries to yourself when trying to complete a task.



IMPORTANT: Instructions that you **MUST** follow to complete a task.



NOTE: Tips and additional information to help you complete a task.

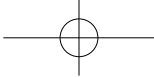

TUF GAMING Z490-PLUS specifications summary

| | |
|--------------------------|---|
| CPU | <p>Intel® Socket LGA1200 for 10th Gen Intel® Core™, Pentium® Gold and Celeron® processors*</p> <p>Supports Intel® 14 nm CPU</p> <p>Supports Intel® Turbo Boost Technology 2.0**</p> <p>* Refer to www.asus.com for CPU support list.</p> <p>** The support of these features depends on the CPU types.</p> |
| Chipset | Intel® Z490 Chipset |
| Memory | <p>4 x DIMM, Max. 128GB, DDR4 4600(O.C.)/4500(O.C.)/4400(O.C.)/4266(O.C.)/4133(O.C.)/4000(O.C.)/3866(O.C.)/3733(O.C.)/3600(O.C.)/3466(O.C.)/3400(O.C.)/3333(O.C.)/3200(O.C.)/3000(O.C.)/2933(O.C.)/2800(O.C.)/2666/2400/2133 MHz Non-ECC, Un-buffered Memory*</p> <p>Dual Channel Memory Architecture</p> <p>Supports Intel® Extreme Memory Profile (XMP)</p> <p>OptiMem II</p> <p>* 10th Gen Intel® Core™ i9/i7 CPUs support 2933/2800/2666/2400/2133 natively. Refer to www.asus.com for the Memory QVL (Qualified Vendors Lists).</p> |
| Graphics | <p>1 x DisplayPort 1.4**</p> <p>1 x HDMI™ 1.4b</p> <p>* Graphics specifications may vary between CPU types.</p> <p>** Support DisplayPort 1.4 with max. resolution of 4096 x 2304 @60Hz. Please refer to www.intel.com for any update.</p> |
| Expansion Slots | <p>Intel® 10th Gen Processors*</p> <p>1 x PCIe 3.0 x16 slot (supports x16 mode)</p> <p>Intel® Z490 Chipset</p> <p>1 x PCIe 3.0 x16 slot (supports x4 mode)</p> <p>3 x PCIe 3.0 x1 slots</p> <p>* Support PCIe bifurcation for RAID on CPU function.</p> |
| Multi-GPU Support | Supports AMD 2-Way CrossFireX™ Technology |
| Storage | <p>Total supports 2 x M.2 slots and 6 x SATA 6Gb/s ports</p> <p>Intel® Z490 Chipset</p> <p>M.2_1 slot (Key M), type 2242/2260/2280/22110 (supports PCIe 3.0 x4 & SATA modes)*</p> <p>M.2_2 slot (Key M), type 2242/2260/2280 (supports PCIe 3.0 x4 & SATA modes)**</p> <p>6 x SATA 6Gb/s ports</p> <p>Intel® Rapid Storage Technology supports Raid 0,1,5,10</p> <p>Intel® Optane™ Memory Ready</p> <p>* M.2_1 shares bandwidth with SATA6G_2. When M.2_1 runs SATA mode, SATA6G_2 will be disabled.</p> <p>** M.2_2 shares bandwidth with SATA6G_56. When M.2_2 is occupied, SATA6G_56 will be disabled.</p> |
| Ethernet | 1 x Intel® I219-V 1Gb Ethernet |

(continued on the next page)

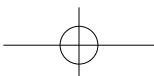

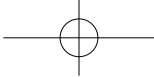

TUF GAMING Z490-PLUS specifications summary

| | |
|--------------------------------|---|
| USB | <p>Rear USB (Total 6 ports) 2 x USB 3.2 Gen 2 ports (1 x Type-A + 1 x USB Type-C®) 4 x USB 3.2 Gen 1 ports (4 x Type-A)</p> <p>Front USB (Total 7 ports) 1 x USB 3.2 Gen 2 front panel connector (supports USB Type-C®) 1 x USB 3.2 Gen 1 header supports additional 2 USB 3.2 Gen 1 ports 2 x USB 2.0 headers support additional 4 USB 2.0 ports</p> |
| Audio | <p>Realtek ALC S1200A 7.1-Channel High Definition Audio CODEC*</p> <ul style="list-style-type: none"> - Supports: Jack detection, Multi-streaming, Front Panel Jack-retasking - Supports up to 24-Bit/192kHz playback <p>Audio Features:</p> <ul style="list-style-type: none"> - Rear optical S/PDIF out port - Premium Japanese audio capacitors - Audio Shielding - Dedicated audio PCB layers - Audio cover <p>* Due to limitations in HDA bandwidth, 32-bit/192kHz is not supported for 7.1-Channel audio.</p> |
| Back Panel I/O Ports | <p>2 x USB 3.2 Gen 2 ports (1 x Type-A + 1 x USB Type-C®) 4 x USB 3.2 Gen 1 ports (4 x Type-A) 1 x DisplayPort 1 x HDMI™ port 1 x Intel® I219-V 1Gb Ethernet port 5 x Audio jacks 1 x Optical S/PDIF out port 1 x PS/2 Keyboard/Mouse combo port</p> |
| Internal I/O Connectors | <p>Fan and cooling-related</p> <ul style="list-style-type: none"> 1 x 4-pin CPU Fan header 1 x 4-pin CPU OPT Fan header 1 x 4-pin AIO Pump header 3 x 4-pin Chassis Fan headers <p>Power related</p> <ul style="list-style-type: none"> 1 x 24-pin Main Power connector 1 x 8-pin +12V Power connector 1 x 4-pin +12V Power connector <p>Storage related</p> <ul style="list-style-type: none"> 2 x M.2 slots (Key M) 6 x SATA 6Gb/s ports <p>USB</p> <ul style="list-style-type: none"> 1 x USB 3.2 Gen 2 Front Panel connector (supports USB Type-C®) 1 x USB 3.2 Gen 1 header supports additional 2 USB 3.2 Gen 1 ports 2 x USB 2.0 headers support additional 4 USB 2.0 ports |

(continued on the next page)

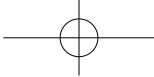

TUF GAMING Z490-PLUS specifications summary

| | |
|---------------------------------------|---|
| <p>Internal I/O Connectors</p> | <p>Miscellaneous</p> <ul style="list-style-type: none"> 1 x AURA Addressable Gen 2 header 2 x AURA RGB headers 1 x Clear CMOS header 1 x COM Port header 1 x Front Panel Audio header (AAFP) 1 x 20-3 pin System Panel header with Chassis intrude function 1 x Thunderbolt header |
| <p>Special Features</p> | <p>ASUS TUF PROTECTION</p> <ul style="list-style-type: none"> - ASUS DIGI+ VRM (- Digital power design with Dr. MOS) - ASUS Enhanced DRAM Overcurrent Protection - ASUS ESD Guards - TUF LANGuard - ASUS Overvoltage Protection - ASUS SafeSlot - ASUS Stainless-Steel Back I/O <p>ASUS Q-Design</p> <ul style="list-style-type: none"> - Q-DIMM - ASUS Q-LED (CPU [red], DRAM [yellow], VGA [white], Boot Device [yellow green]) - ASUS Q-Slot <p>ASUS Thermal Solution</p> <ul style="list-style-type: none"> - Aluminum heatsink design <p>ASUS EZ DIY</p> <ul style="list-style-type: none"> - Procool <p>AURA Sync</p> <ul style="list-style-type: none"> - Standard RGB headers - Addressable Gen 2 RGB header |
| <p>Software Features</p> | <p>ASUS Exclusive Software Features</p> <ul style="list-style-type: none"> Armoury Crate <ul style="list-style-type: none"> - Aura Sync AI Suite 3 <ul style="list-style-type: none"> - Performance And Power Saving Utility Turbo V Evo EPU Digi + VRM Fan Xpert 4 System information - EZ update AI Charger ASUS Turbo LAN DTS Custom for GAMING Headsets WinRAR |

(continued on the next page)

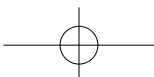

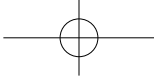

TUF GAMING Z490-PLUS specifications summary

| | |
|--------------------------|--|
| Software Features | UEFI BIOS |
| | ASUS EZ DIY |
| | - ASUS CrashFree BIOS 3 |
| | - ASUS EZ Flash 3 |
| | - ASUS UEFI BIOS EZ Mode |
| BIOS | 192 (128+64) Mb Flash ROM, UEFI AMI BIOS |
| Manageability | WOL by PME, PXE |
| Operating System | Windows® 10 - 64 bit |
| Form Factor | ATX Form Factor |
| | 12 inch x 9.6 inch (30.5 cm x 24.4 cm) |



Specifications are subject to change without notice. Please refer to the ASUS website for the latest specifications.

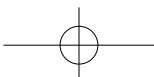
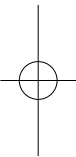
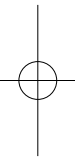

Connectors with shared bandwidth

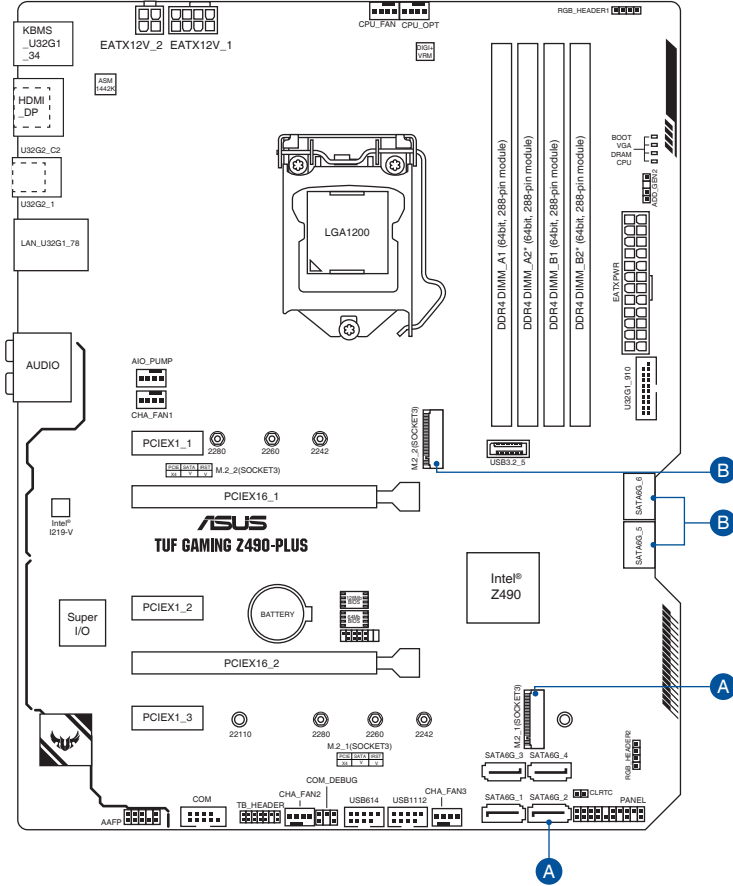

| Configuration | | 1 [Default] | 2 |
|---------------|-----------|-------------|--------------|
| A | M.2_1 | SATA | PCIe x4 mode |
| | SATA6G_2 | - | V |
| Configuration | | 1 [Default] | 2 |
| B | M.2_2 | V | - |
| | SATA6G_56 | - | V |



- M.2_1 shares bandwidth with SATA6G_2. When M.2_1 runs SATA mode, SATA6G_2 will be disabled.
- M.2_2 shares bandwidth with SATA6G_56. When M.2_2 is occupied, SATA6G_56 will be disabled.
- Please adjust BIOS setting for changing onboard device configuration.

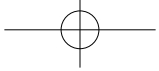

Package contents

Check your motherboard package for the following items.

| | |
|--------------------|--------------------------------------|
| Motherboard | 1 x TUF GAMING Z490-PLUS motherboard |
| Cables | 2 x SATA 6Gb/s cables |
| Miscellaneous | 1 x Fan Bracket |
| | 1 x I/O Shield |
| | 1 x M.2 Rubber Package |
| | 1 x M.2 Screw Package |
| Installation Media | 1 x TUF GAMING sticker |
| | 1 x Support DVD |
| Documentation | 1 x TUF Certification card |
| | 1 x User manual |





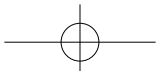
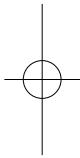
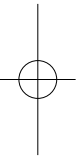

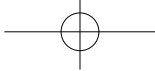
If any of the above items is damaged or missing, contact your retailer.



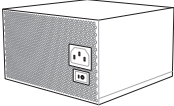
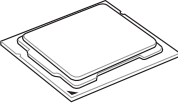
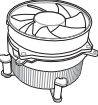
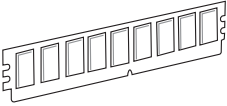
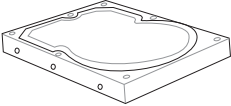
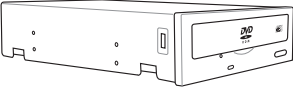
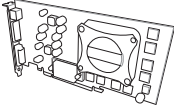

Installation tools and components

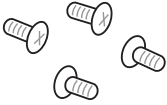
| | |
|---|---|
|  |  |
| | Phillips (cross) screwdriver |
| PC chassis |  |
| | Power supply unit |
|  |  |
| Intel® LGA 1200 CPU | Intel® LGA 1200 compatible CPU Fan |
|  |  |
| DDR4 DIMM | SATA hard disk drive |
|  |  |
| SATA optical disc drive (optional) | Graphics card (optional) |
|  |  |
| M.2 SSD module (optional) | 1 Bag of screws |



The tools and components in the table above are not included in the motherboard package.

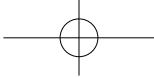

Product Introduction

1

1.1 Before you proceed

Take note of the following precautions before you install motherboard components or change any motherboard settings.



-
- Unplug the power cord from the wall socket before touching any component.
 - Before handling components, use a grounded wrist strap or touch a safely grounded object or a metal object, such as the power supply case, to avoid damaging them due to static electricity.
 - Hold components by the edges to avoid touching the ICs on them.
 - Whenever you uninstall any component, place it on a grounded antistatic pad or in the bag that came with the component.
 - Before you install or remove any component, ensure that the ATX power supply is switched off or the power cord is detached from the power supply. Failure to do so may cause severe damage to the motherboard, peripherals, or components.
-

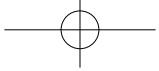

1.2 Motherboard layout

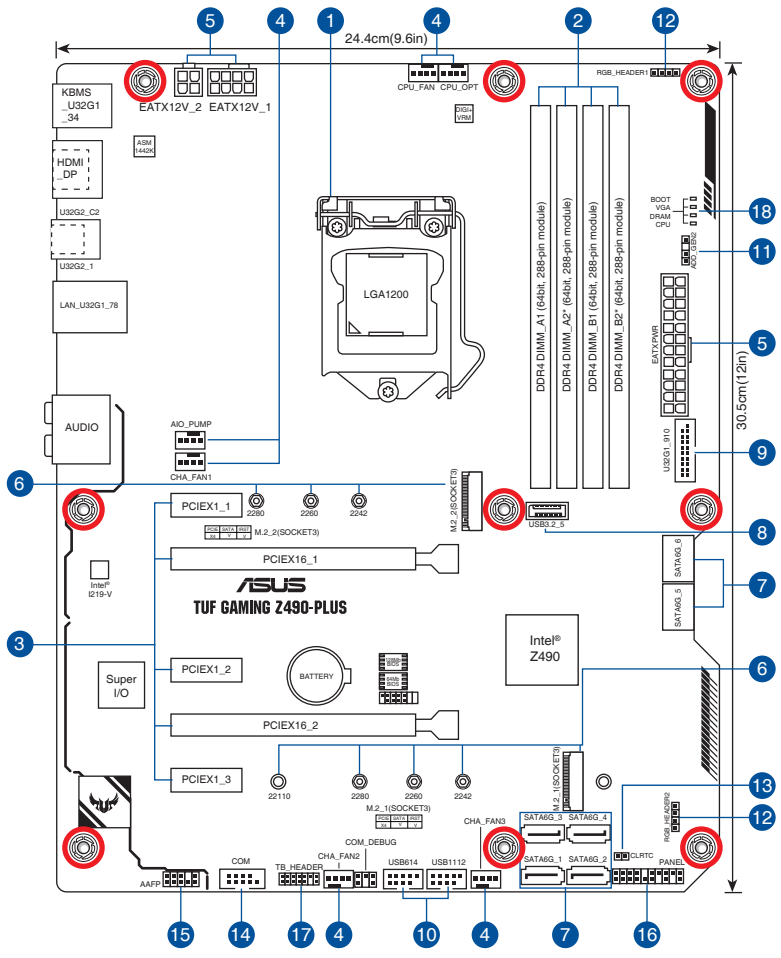

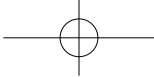

Chapter 1

| Layout contents | Page |
|--|------|
| 1. CPU socket | 1-4 |
| 2. DIMM slots | 1-5 |
| 3. Expansion slots | 1-7 |
| 4. Fan and Pump headers | 1-9 |
| 5. Power connectors | 1-10 |
| 6. M.2 slots (SOCKET 3) | 1-11 |
| 7. SATA 6GB/s ports | 1-12 |
| 8. USB 3.2 Gen 2 Front Panel connector | 1-13 |
| 9. USB 3.2 Gen 1 header | 1-14 |
| 10. USB 2.0 headers | 1-15 |
| 11. AURA Addressable Gen2 header | 1-16 |
| 12. AURA RGB headers | 1-17 |
| 13. Clear CMOS header | 1-18 |
| 14. COM Port header | 1-19 |
| 15. Front Panel Audio header | 1-19 |
| 16. System Panel header | 1-20 |
| 17. Thunderbolt header | 1-21 |
| 18. Q-LEDs | 1-21 |

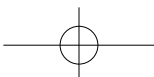
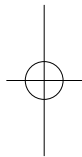
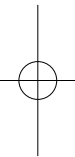

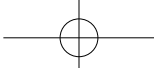

1. CPU socket

The motherboard comes with a LGA1200 socket designed for 10th Gen Intel® Core™, Pentium® Gold and Celeron® Processors.

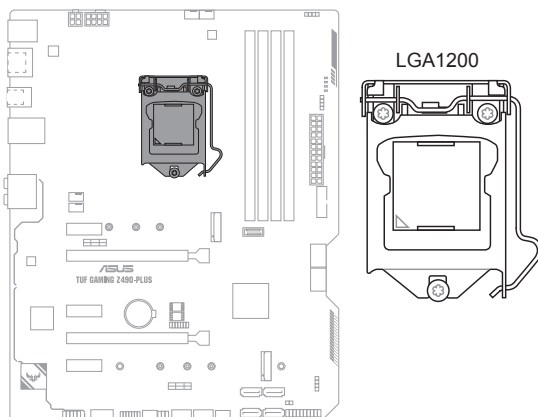

- Ensure that you install the correct CPU designed for LGA1200 socket only. **DO NOT** install a CPU designed for other sockets on the LGA1200 socket.
- The CPU fits in only one correct orientation. **DO NOT** force the CPU into the socket to prevent bending the connectors on the socket and damaging the CPU.
- Ensure that all power cables are unplugged before installing the CPU.
- Upon purchase of the motherboard, ensure that the PnP cap is on the socket and the socket contacts are not bent. Contact your retailer immediately if the PnP cap is missing, or if you see any damage to the PnP cap/socket contacts/motherboard components. ASUS will shoulder the cost of repair only if the damage is shipment/transit-related.
- Keep the cap after installing the motherboard. ASUS will process Return Merchandise Authorization (RMA) requests only if the motherboard comes with the cap on the LGA1200 socket.
- The product warranty does not cover damage to the socket contacts resulting from incorrect CPU installation/removal, or misplacement/loss/incorrect removal of the PnP cap.

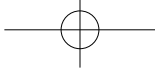

2. DIMM slots

The motherboard comes with Dual Inline Memory Modules (DIMM) slots designed for DDR4 (Double Data Rate 4) memory modules.



A DDR4 memory module is notched differently from a DDR, DDR2, or DDR3 module. DO NOT install a DDR, DDR2, or DDR3 memory module to the DDR4 slot.

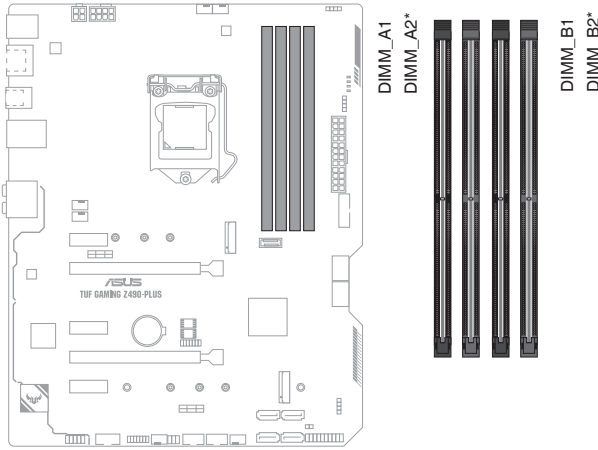

Recommended memory configurations

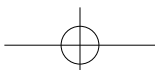
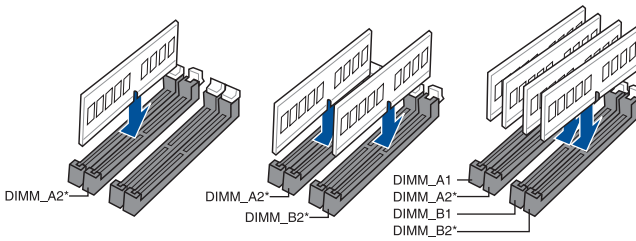

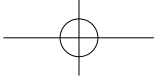

Memory configurations

You may install 4 GB, 8 GB, 16 GB, and 32 GB unbuffered and non-ECC DDR4 DIMMs into the DIMM sockets.



You may install varying memory sizes in Channel A and Channel B. The system maps the total size of the lower-sized channel for the dual-channel configuration. Any excess memory from the higher-sized channel is then mapped for single-channel operation.



- The default memory operation frequency is dependent on its Serial Presence Detect (SPD), which is the standard way of accessing information from a memory module. Under the default state, some memory modules for overclocking may operate at a lower frequency than the vendor-marked value.
- For system stability, use a more efficient memory cooling system to support a full memory load or overclocking condition.
- Always install the DIMMS with the same CAS Latency. For an optimum compatibility, we recommend that you install memory modules of the same version or data code (D/C) from the same vendor. Check with the vendor to get the correct memory modules.
- Visit the [ASUS website](#) for the latest QVL.

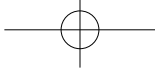

3. Expansion slots



Unplug the power cord before adding or removing expansion cards. Failure to do so may cause you physical injury and damage motherboard components.

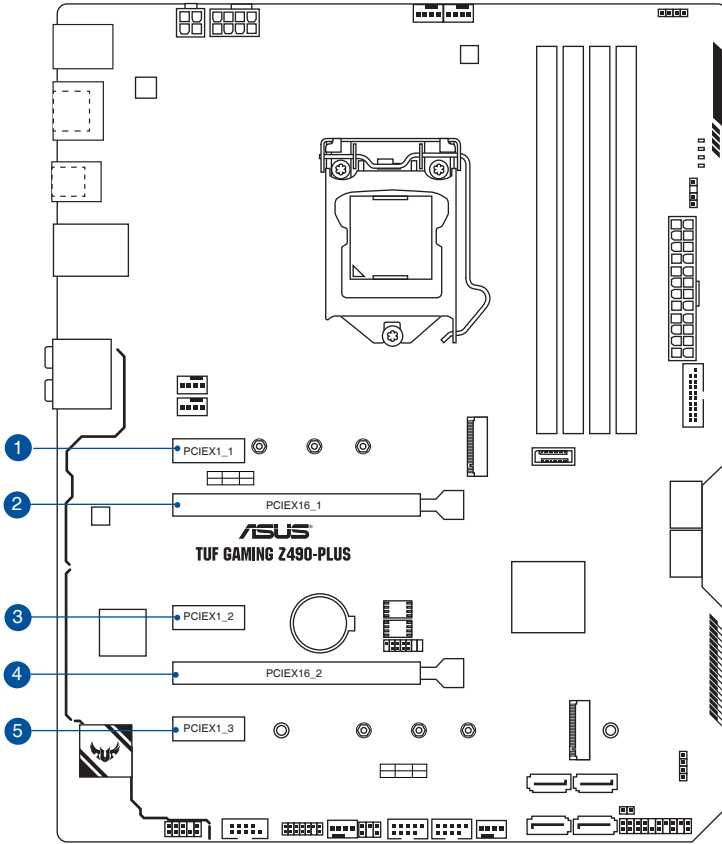

Recommended VGA configuration

| Slot Description | Single VGA | Dual VGA |
|-------------------|------------|----------|
| 2. PCIe 3.0 x16_1 | x16 | x16 |
| 4. PCIe 3.0 x16_2 | - | x4 |



- We recommend that you provide sufficient power when running CrossFireX™ mode.
- Ensure to connect the 8-pin and 4-pin power plugs when running CrossFireX™ mode.
- Connect a chassis fan to the chassis fan connectors when using multiple graphics cards for better thermal environment.

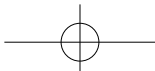

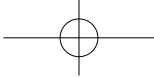

Hyper M.2 X16 series card configuration

| Slot Description | up to 3 Intel® SSD on CPU support |
|-------------------|-----------------------------------|
| 2. PCIe 3.0 x16_1 | x8+x4+x4 |



- The Hyper M.2 X16 series card is sold separately.
- Ensure to install the Hyper M.2 X16 series card to PCIe 3.0 x16_1. If you wish to connect a display, we suggest using the internal VGA or installing a VGA card to PCIe 3.0 x16_2, which will run at x4.
- Enable the Hyper M.2 X16 series card under BIOS settings.

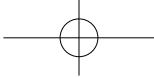

4. Fan and Pump headers

The Fan and Pump headers allow you to connect fans or pumps to cool the system.

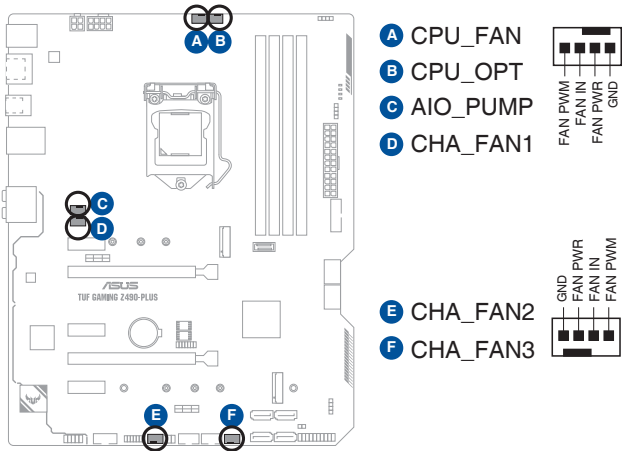

- DO NOT forget to connect the fan cables to the fan headers. Insufficient air flow inside the system may damage the motherboard components. These are not jumpers! Do not place jumper caps on the fan headers!
- Ensure the cable is fully inserted into the header.

| Header | Max. Current | Max. Power | Default Speed | Shared Control |
|----------|--------------|------------|------------------|----------------|
| CPU_FAN | 1A | 12W | Q-Fan Controlled | A |
| CPU_OPT | 1A | 12W | Q-Fan Controlled | A |
| CHA_FAN1 | 1A | 12W | Q-Fan Controlled | - |
| CHA_FAN2 | 1A | 12W | Q-Fan Controlled | - |
| CHA_FAN3 | 1A | 12W | Q-Fan Controlled | - |
| AIO_PUMP | 1A | 12W | Full-Speed | - |

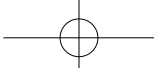

5. Power connectors

These Power connectors allow you to connect your motherboard to a power supply. The power supply plugs are designed to fit in only one orientation. Find the proper orientation and push down firmly until the power supply plugs are fully inserted.

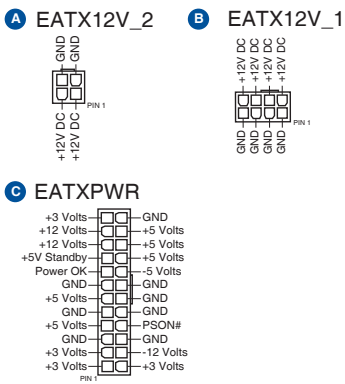
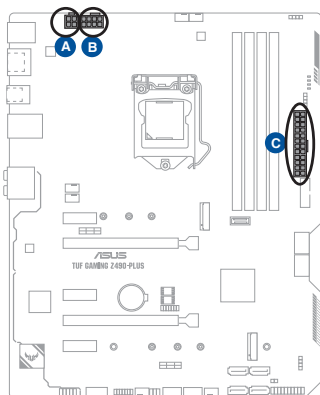

Ensure to connect the 8-pin power plug.



- For a fully configured system, we recommend that you use a power supply unit (PSU) that complies with ATX 12V Specification 2.0 (or later version) and provides a minimum power of 350 W.
- We recommend that you use a PSU with a higher power output when configuring a system with more power-consuming devices. The system may become unstable or may not boot up if the power is inadequate.
- If you want to use two or more high-end PCI Express x16 cards, use a PSU with 1000W power or above to ensure the system stability.

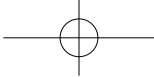

6. M.2 slot

The M.2 slot allows you to install M.2 devices such as M.2 SSD modules.

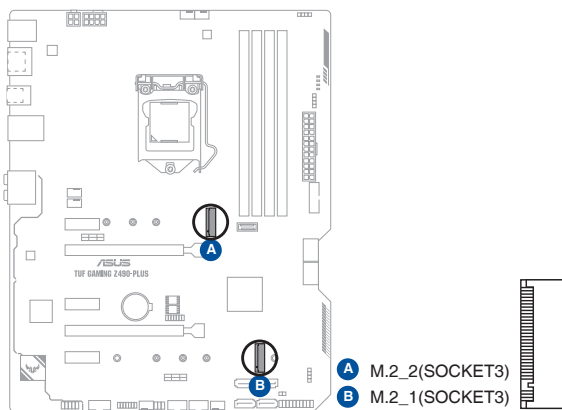

- M.2_1 slot (Key M), type 2242/2260/2280/22110 (supports SATA & PCIe 3.0 x4 mode).
- M.2_2 slot (Key M), type 2242/2260/2280 (supports SATA & PCIe 3.0 x4 mode).
- M.2_1 shares bandwidth with SATA6G_2. When M.2_1 runs SATA mode, SATA6G_2 will be disabled.
- M.2_2 shares bandwidth with SATA6G_56. When M.2_2 is occupied, SATA6G_56 will be disabled.
- M.2 slots support IRST (Intel® Rapid Storage Technology).



The M.2 SSD module is purchased separately.

7. SATA 6Gb/s ports

The SATA 6Gb/s ports allow you to connect SATA devices such as optical disc drives and hard disk drives via a SATA cable.

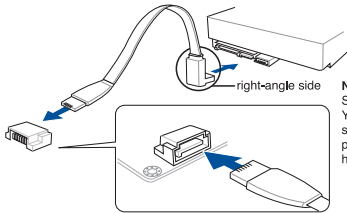
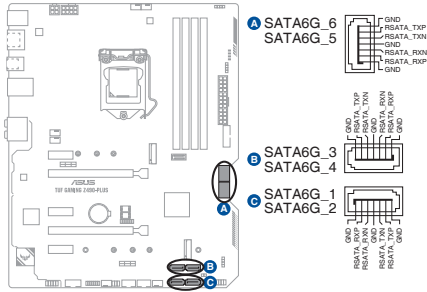

NOTE: Connect the right-angle side of SATA signal cable to SATA device. You may also connect the right-angle side of SATA cable to the onboard SATA port to avoid mechanical conflict with huge graphics cards.

If you installed SATA storage devices, you can create a RAID 0, 1, 5, and 10 configuration with the Intel® Rapid Storage Technology through the onboard Intel® Z490 chipset.

- The slots are set to **[AHCI Mode]** by default. If you intend to create a SATA RAID set using these connectors, set the SATA Mode item in the BIOS to **[Intel RST Premium With Intel Optane System Acceleration(RAID)]**.
- When a device in SATA mode is installed on the M.2_1 socket, SATA6G_2 port cannot be used.
- When a device is installed on the M.2_2 socket, SATA6G_56 ports cannot be used.
- Before creating a RAID set, refer to the **RAID Configuration Guide**. You can download the **RAID Configuration Guide** from the ASUS website.

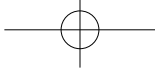

8. USB 3.2 Gen 2 Front Panel connector

The USB 3.2 Gen 2 connector allows you to connect a USB 3.2 Gen 2 module for additional USB 3.2 Gen 2 ports. The USB 3.2 Gen 2 connector provides data transfer speeds of up to 10 Gb/s.

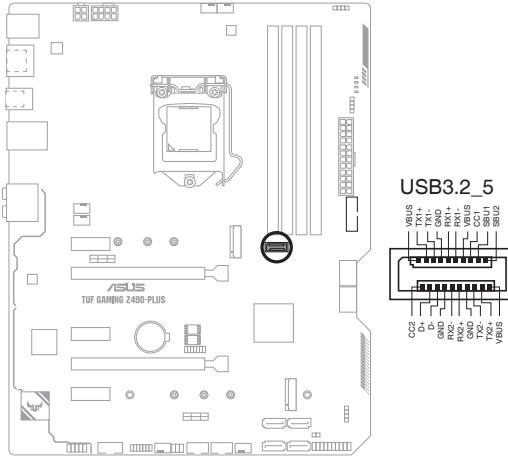

The USB 3.2 Gen 2 module is purchased separately.

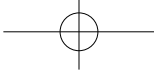

9. USB 3.2 Gen 1 header

The USB 3.2 Gen 1 header allows you to connect a USB 3.2 Gen 1 module for additional USB 3.2 Gen 1 ports. The USB 3.2 Gen 1 header provides data transfer speeds of up to 5 Gb/s.

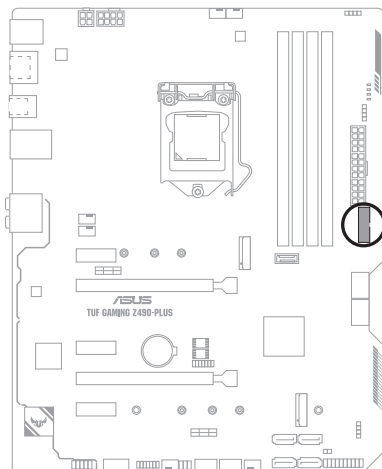

U32G1_910

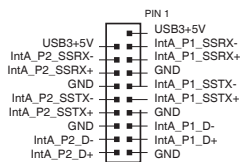

The USB 3.2 Gen 1 module is purchased separately.



The plugged USB 3.2 Gen 1 device may run on xHCI or EHCI mode depending on the operating system's setting.

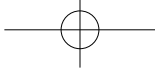

10. USB 2.0 header

The USB 2.0 header allows you to connect a USB module for additional USB 2.0 ports. The USB 2.0 header provides data transfer speeds of up to 480 Mbps connection speed.

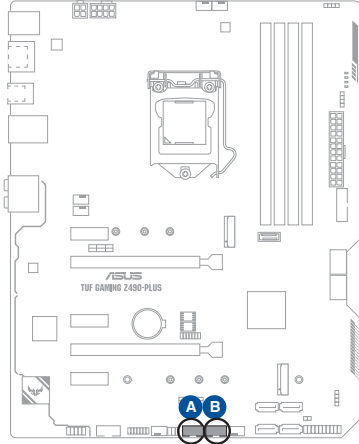

- A** USB614
- B** USB1112

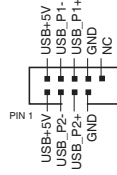

DO NOT connect a 1394 cable to the USB connectors. Doing so will damage the motherboard!



The USB 2.0 module is purchased separately.

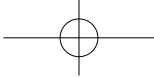

11. Aura Addressable Gen2 header

The Addressable Gen2 header allows you to connect individually addressable RGB WS2812B LED strips or WS2812B based LED strips.

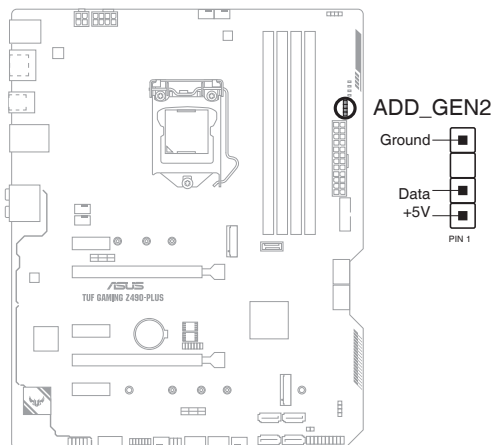

The Addressable Gen2 header supports WS2812B addressable RGB LED strips (5V/Data/Ground), with a maximum power rating of 3A (5V), and the addressable headers on this board can handle a combined maximum of 500 LEDs.



Before you install or remove any component, ensure that the power supply is switched off or the power cord is detached from the power supply. Failure to do so may cause severe damage to the motherboard, peripherals, or components.



- Actual lighting and color will vary with LED strip.
- If your LED strip does not light up, check if the addressable RGB LED strip is connected in the correct orientation, and the 5V connector is aligned with the 5V header on the motherboard.
- The addressable RGB LED strip will only light up when the system is powered on.
- The addressable RGB LED strip is purchased separately.

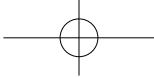

12. AURA RGB LED header

The AURA RGB LED header allows you to connect RGB LED strips.

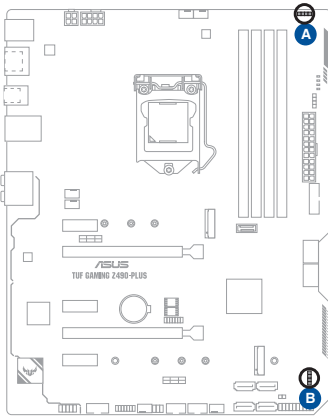

A RGB_HEADER1



B RGB_HEADER2

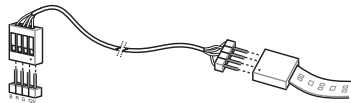

The AURA RGB LED header supports 5050 RGB multi-color LED strips (12V/G/R/B), with a maximum power rating of 3A (12V).



Before you install or remove any component, ensure that the power supply is switched off or the power cord is detached from the power supply. Failure to do so may cause severe damage to the motherboard, peripherals, or components.



- Actual lighting and color will vary with LED strip.
- If your LED strip does not light up, check if the RGB LED extension cable and the RGB LED strip is connected in the correct orientation, and the 12V connector is aligned with the 12V header on the motherboard.
- The LED strip will only light up when the system is powered on.
- The LED strip is purchased separately.

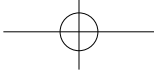

13. Clear CMOS header

This header allows you to clear the Real Time Clock (RTC) RAM in CMOS. You can clear the CMOS memory of date, time, and system setup parameters by erasing the CMOS RTC RAM data. The onboard button cell battery powers the RAM data in CMOS, which include system setup information such as system passwords.

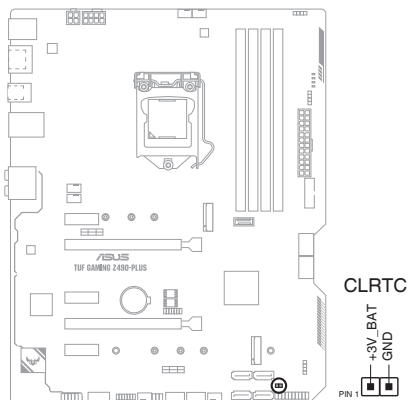

To erase the RTC RAM:

1. Turn OFF the computer and unplug the power cord.
2. Use a metal object such as a screwdriver to short the two pins.
3. Plug the power cord and turn on the computer.
4. Hold down the key during the boot process and enter BIOS setup to re-enter data.



If the steps above do not help, remove the onboard battery and short the two pins again to clear the CMOS RTC RAM data. After clearing the CMOS, reinstall the battery.

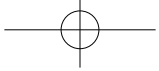

14. COM Port header

This connector is for a serial (COM) port. Connect the serial port module cable to this connector, then install the module to a slot opening at the back of the system chassis.

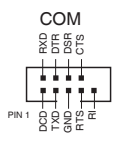
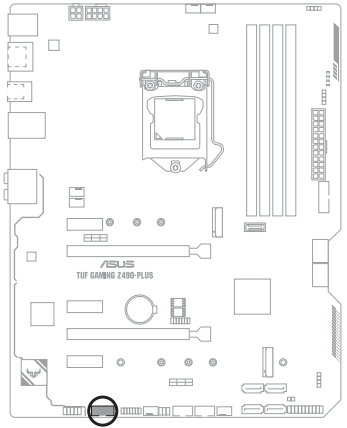

The COM module is purchased separately.

15. Front Panel Audio header

The front panel audio header is for a chassis-mounted front panel audio I/O module that supports HD Audio. Connect one end of the front panel audio I/O module cable to this header.

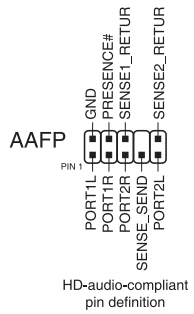
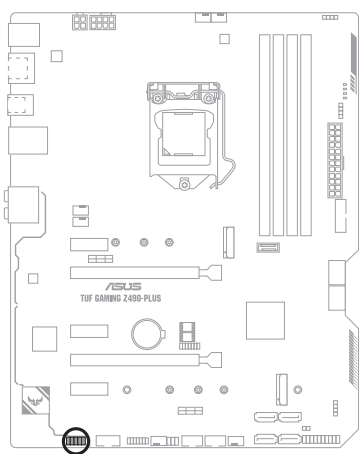

We recommend that you connect a high-definition front panel audio module to this connector to avail of the motherboard's high-definition audio capability.

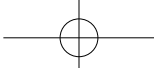

16. System Panel header

The System Panel header supports several chassis-mounted functions.

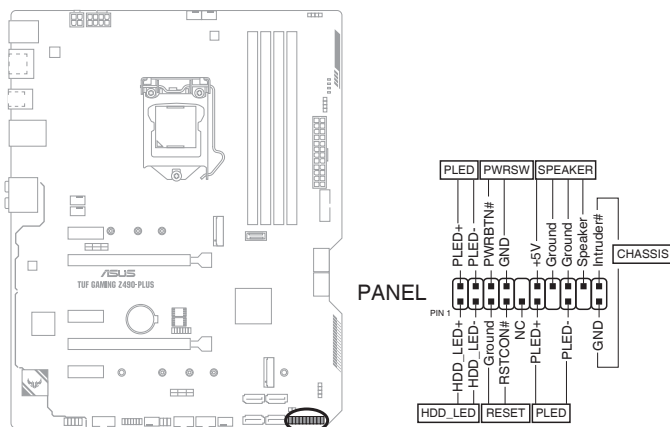

- **System Power LED header (PLED)**
The 2-pin header allows you to connect the System Power LED. The System Power LED lights up when the system is connected to a power source, or when you turn on the system power, and blinks when the system is in sleep mode.
- **Storage Device Activity LED header (HDD_LED)**
The 2-pin header allows you to connect the Storage Device Activity LED. The Storage Device Activity LED lights up or blinks when data is read from or written to the storage device or storage device add-on card.
- **System Warning Speaker header (SPEAKER)**
The 4-pin header allows you to connect the chassis-mounted system warning speaker. The speaker allows you to hear system beeps and warnings.
- **Power Button/Soft-off Button header (PWRSW)**
The 3-1 pin header allows you to connect the system power button. Press the power button to power up the system, or put the system into sleep or soft-off mode (depending on the operating system settings).
- **Reset button header (RESET)**
The 2-pin header allows you to connect the chassis-mounted reset button. Press the reset button to reboot the system.
- **Chassis intrusion header (2-pin CHASSIS)**
This header is for a chassis-mounted intrusion detection sensor or switch. Connect one end of the chassis intrusion sensor or switch cable to this header. The chassis intrusion sensor or switch sends a high-level signal to this connector when a chassis component is removed or replaced. The signal is then generated as a chassis intrusion event.

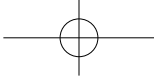

17. Thunderbolt header

The Thunderbolt header allows you to connect an add-on Thunderbolt I/O card that supports Intel's Thunderbolt Technology, allowing you to connect up to six Thunderbolt-enabled devices and a DisplayPort-enabled display in a daisy-chain configuration.

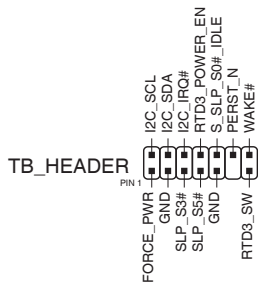
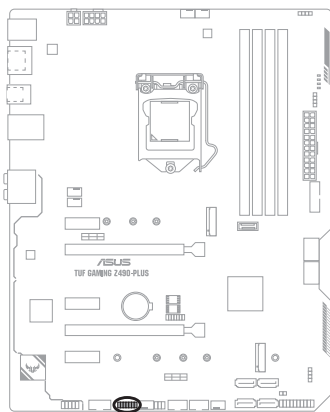

The add-on Thunderbolt I/O card and Thunderbolt cables are purchased separately.

18. Q-LEDs

The Q-LEDs check key components (CPU, DRAM, VGA, and booting devices) during the motherboard booting process. If an error is found, the critical component's LED stays lit up until the problem is solved.

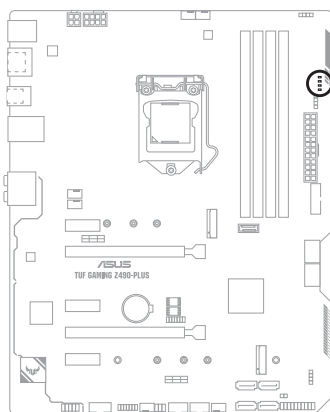

- BOOT (YELLOW GREEN)
- VGA (WHITE)
- DRAM (YELLOW)
- CPU (RED)



The Q-LEDs provide the most probable cause of an error code as a starting point for troubleshooting. The actual cause may vary from case to case.

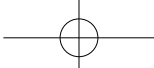

Basic Installation

2

2.1 Building your PC system



The diagrams in this section are for reference only. The motherboard layout may vary with models, but the installation steps are the same for all models.

2.1.1 CPU installation



- Ensure that you install the correct CPU designed for LGA1200 socket only. DO NOT install a CPU designed for LGA1155, LGA1156, and LGA1151 sockets on the LGA1200 socket.
- ASUS will not cover damages resulting from incorrect CPU installation/removal, incorrect CPU orientation/placement, or other damages resulting from negligence by the user.

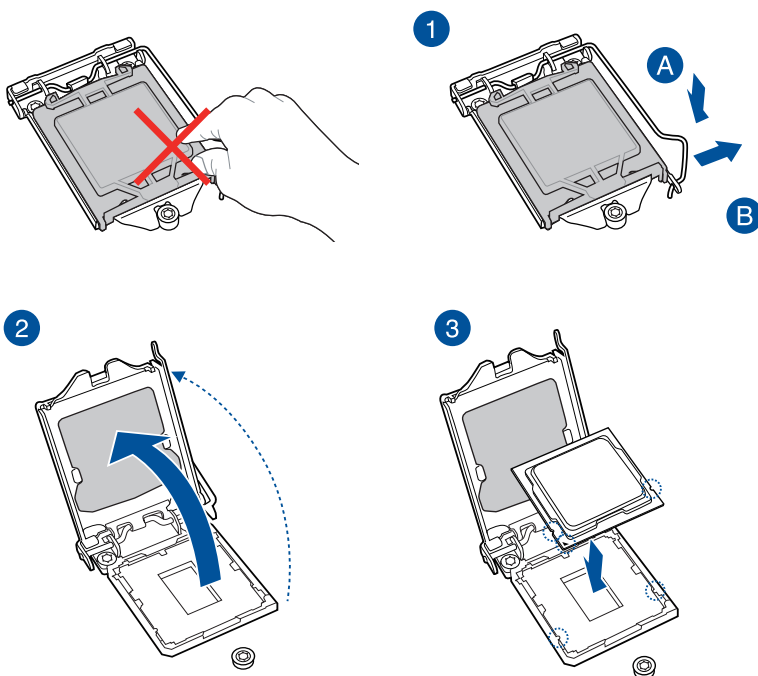

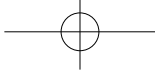

Chapter 2

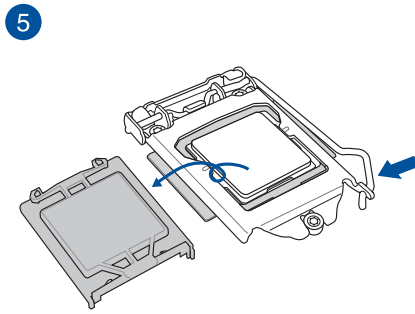
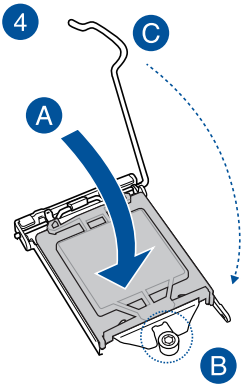

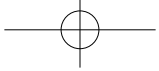

2.1.2 Cooling system installation

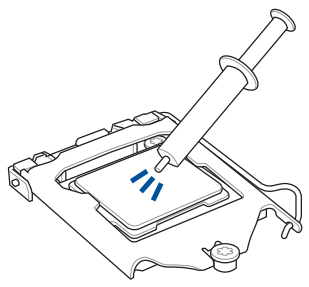

Apply Thermal Interface Material to the CPU cooling system and CPU before you install the cooling system, if necessary.

To install a CPU heatsink and fan assembly

1

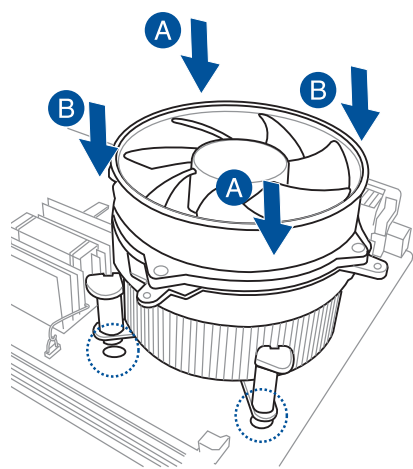

2

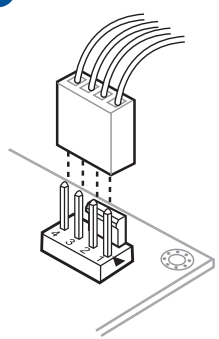

3

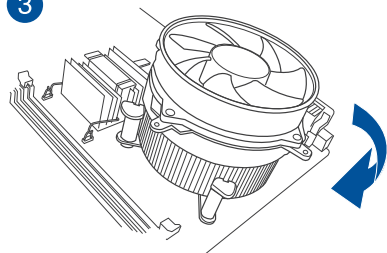

4

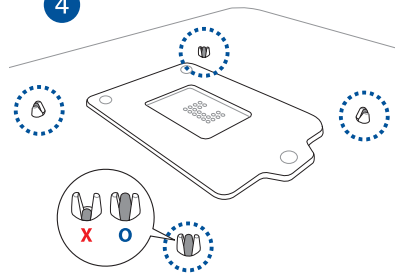

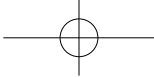

To install an AIO cooler



If you wish to install an AIO cooler, we recommend installing the AIO cooler after installing the motherboard into the chassis.

1

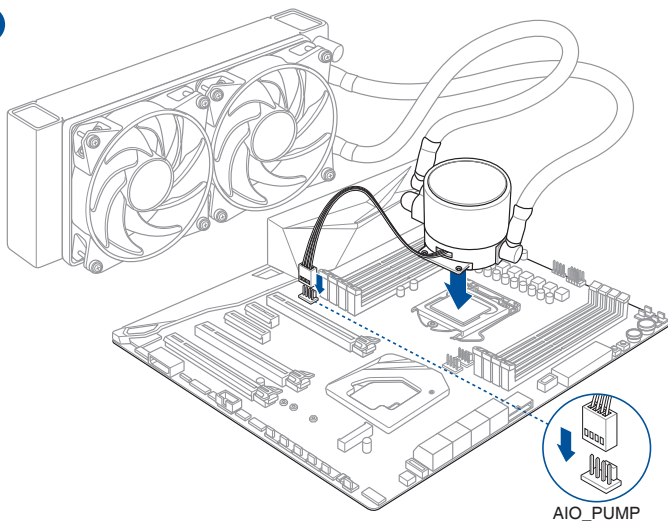

2

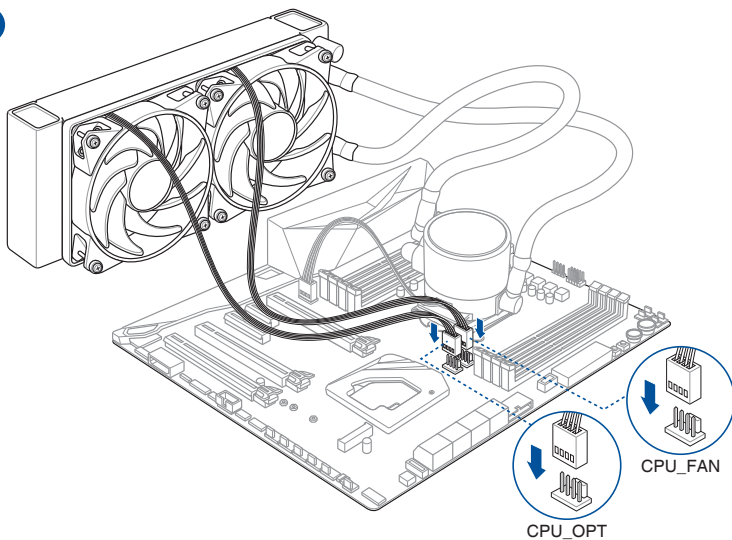

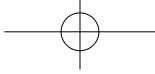

2.1.3 DIMM installation

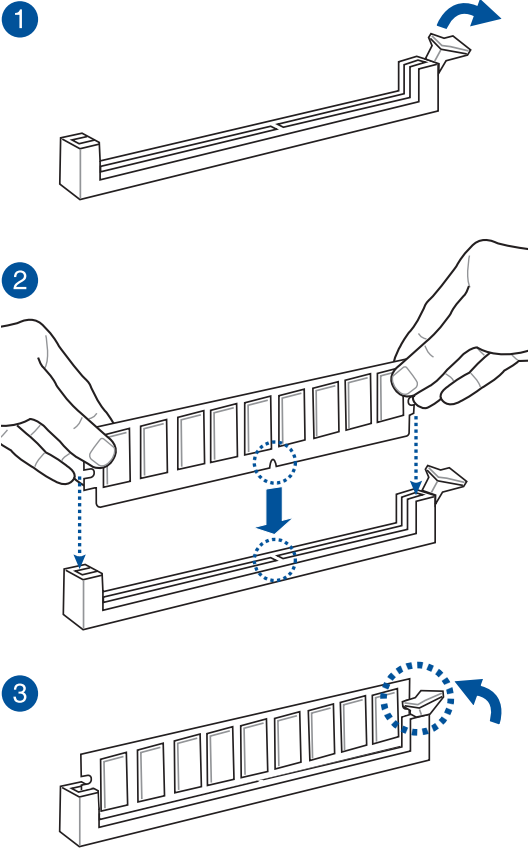

To remove a DIMM

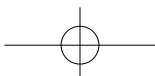
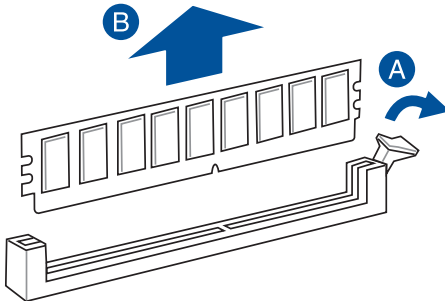

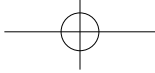

2.1.4 M.2 installation

For type 22110 M.2 on M.2_1 slot

For type 2242 / 2260 / 2280 M.2 on M.2_1 slot

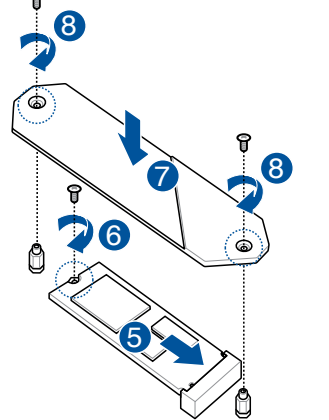
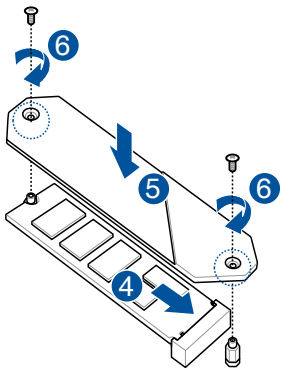
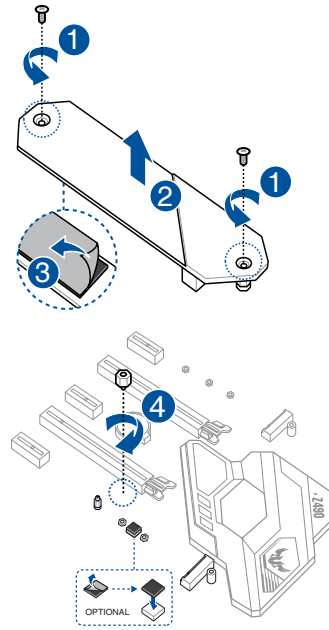
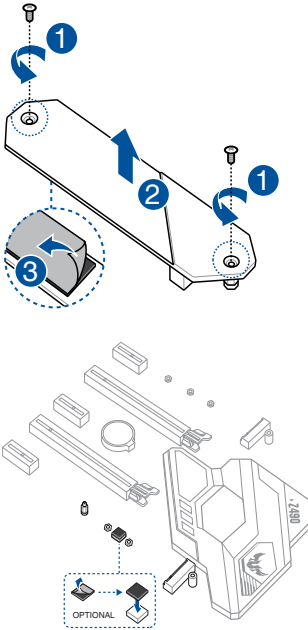

- This M.2 rubber pad is optional for when installing a single sided M.2 storage device. Ensure to install the bundled M.2 rubber pad before installing your single sided M.2 storage device.
- DO NOT install the bundled M.2 rubber pads when installing a double-sided M.2 storage device. The rubber pad installed by default is compatible with double sided M.2 storage devices.
- The M.2 is purchased separately.

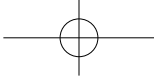

2.1.5 Fan bracket installation

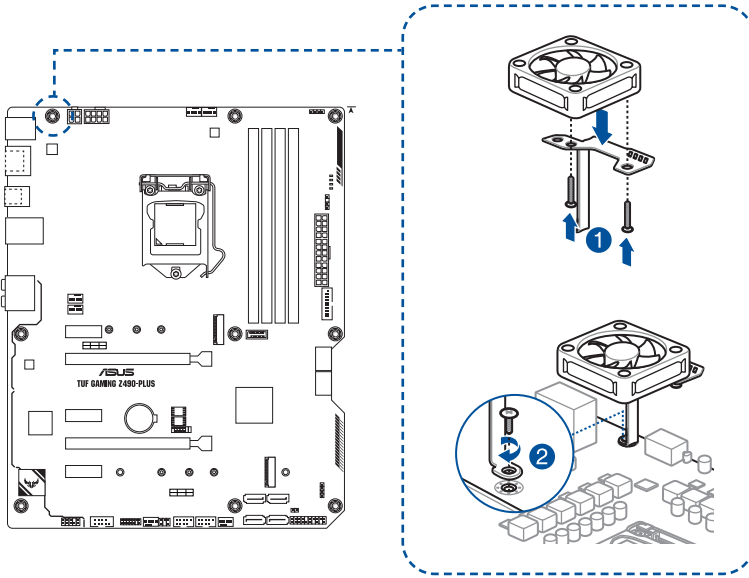

When using high performance settings whilst overclocking, ensure to install the fan holder for additional fan(s).



- You may install 12V (1A, 12W), 40mm x 40mm fans or 50mm x 50mm fans.
- Ensure to use the bundled screws that came with your fans.
- Fans are purchased separately.

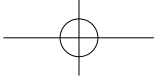

2.1.6 Motherboard installation

1. Install the ASUS I/O Shield to the chassis rear I/O panel.



Some sharp edges and points might cause physical injury. We recommend you put on cut or puncture resistant gloves before motherboard and I/O shield installation.

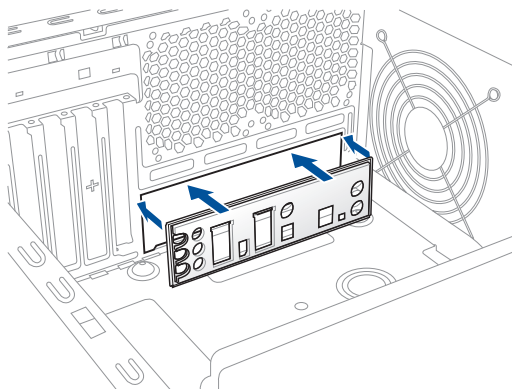

2. Place the motherboard into the chassis, ensuring that its rear I/O ports are aligned to the chassis' rear I/O panel.

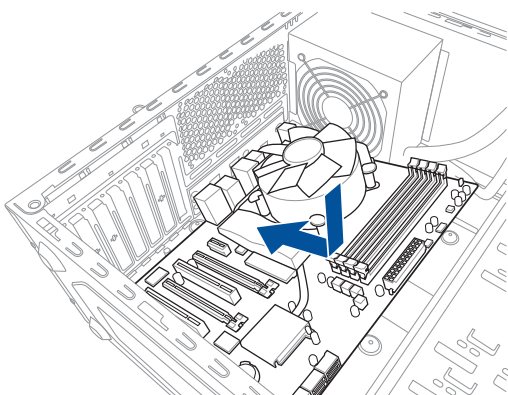

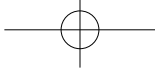

3. Place nine (9) screws into the holes indicated by circles to secure the motherboard to the chassis.

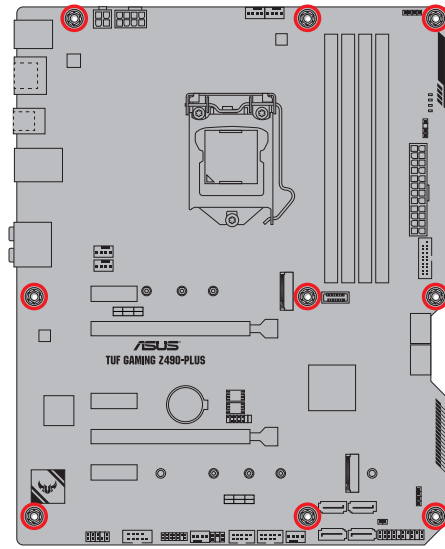
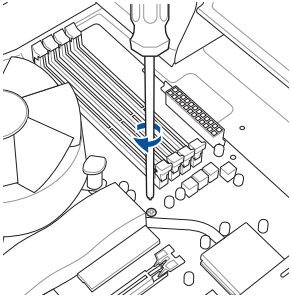

DO NOT over tighten the screws! Doing so can damage the motherboard.

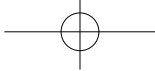

2.1.7 ATX power connection

1

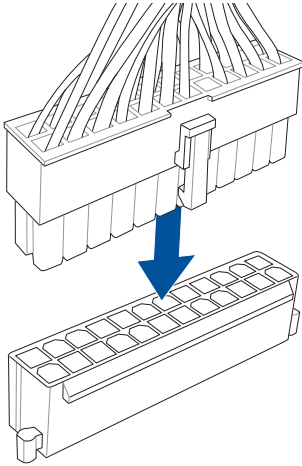

2

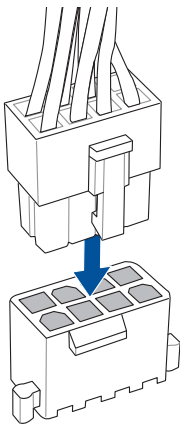

OR

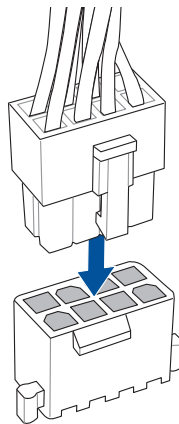

AND

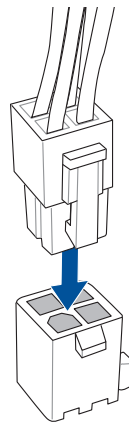

- DO NOT connect the 4-pin power plug only, the motherboard may overheat under heavy usage.
- Ensure to connect the 8-pin power plug, or connect both the 8-pin and 4-pin power plugs.



2.1.8 SATA device connection

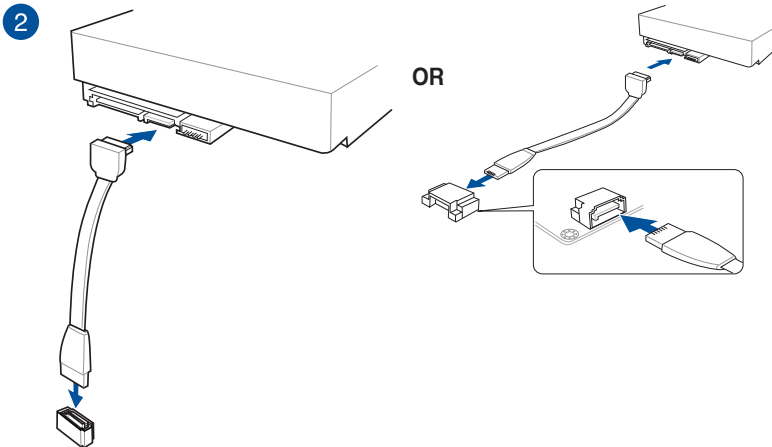
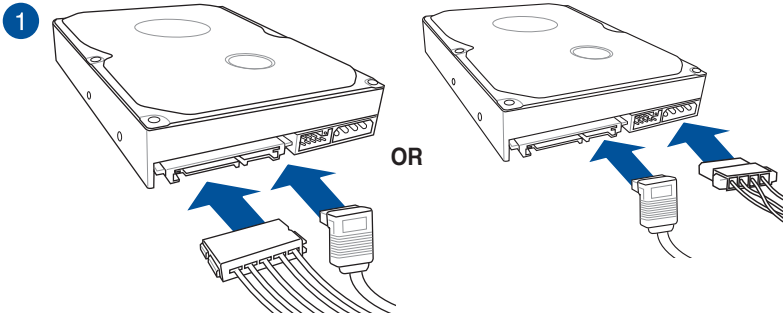

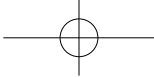

2.1.9 Front I/O connector

To install the front panel header

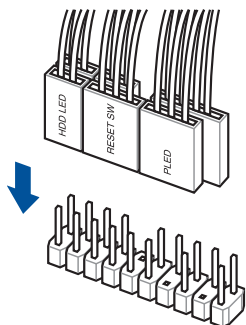

To install USB 3.2 Gen 2 connector

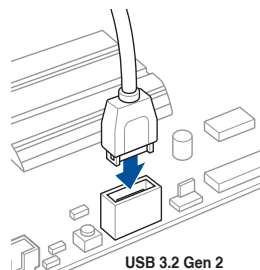

This connector will only fit in one orientation. Push the connector until it clicks into place.

To install USB 3.2 Gen 1 connector

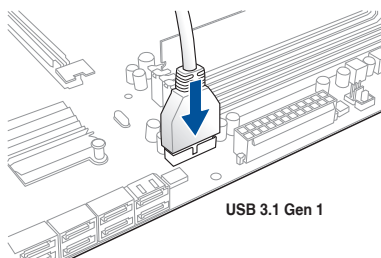

To install USB 2.0 connector

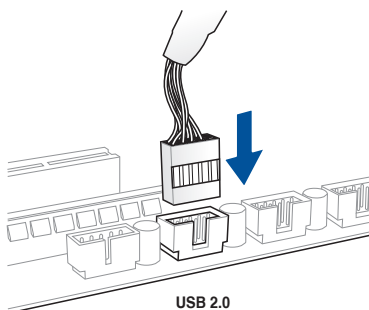

To install front panel audio connector

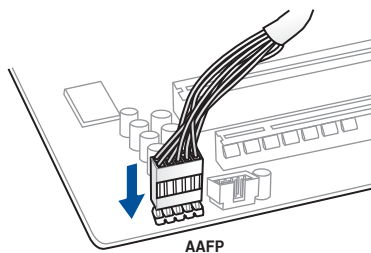

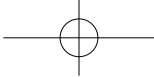

2.1.10 Expansion card installation

To install PCIe x16 cards

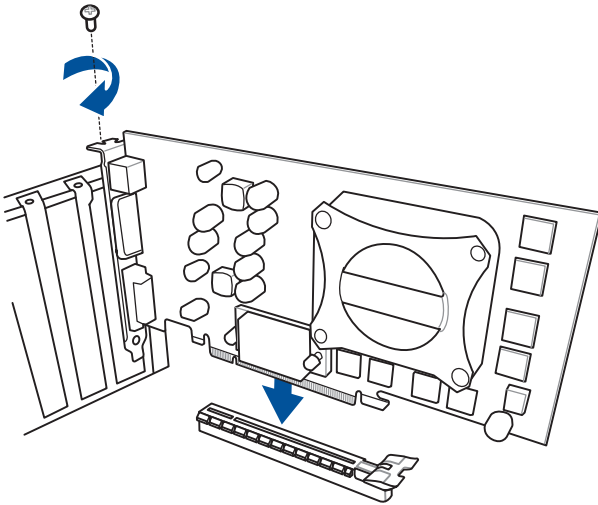

To install PCIe x1 cards

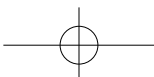
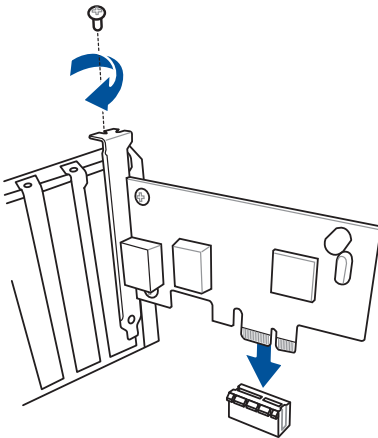

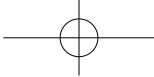

To install ThunderboltEX 3-TR card

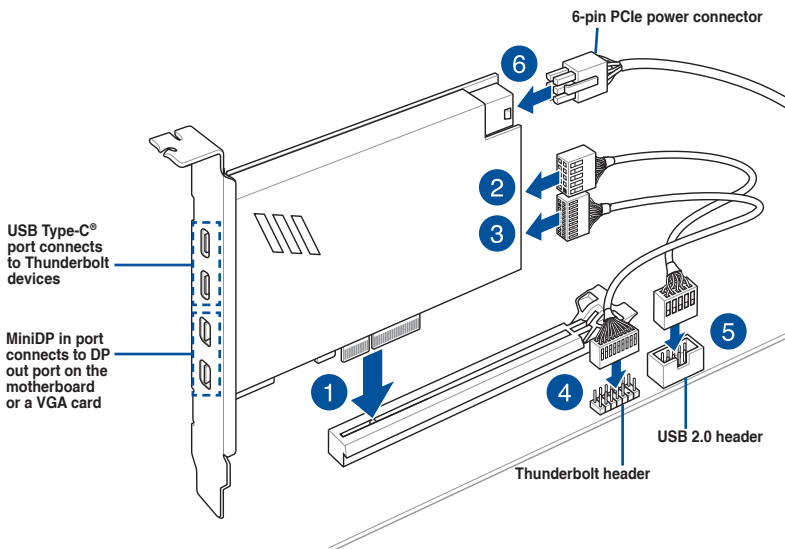

Ensure to install the ThunderboltEX 3-TR card to a PCIe slot from PCH.



- Step 6 is optional, please connect a 6-pin PCIe power connector when you wish to use the USB Type-C® port Thunderbolt quick charge feature to charge a 5V or more device. The ThunderboltEX 3-TR card can support quick charging up to 100W.
- The TypeC_1 port can support up to 20V devices, and the TypeC_2 port can support up to 9V devices when the 6-pin PCIe power connector is connected.
- The Thunderbolt card is sold separately.

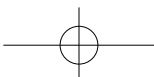

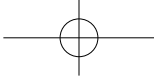

2.2 Motherboard rear and audio connections

2.2.1 Rear I/O connection

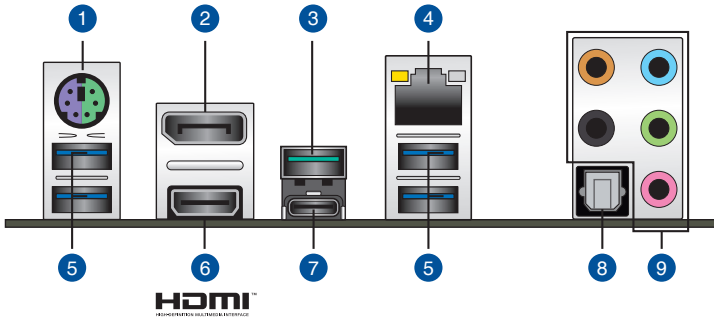

Rear panel connectors

| | |
|----|--------------------------------------|
| 1. | PS/2 mouse/keyboard combo port |
| 2. | DisplayPort |
| 3. | USB 3.2 Gen 2 Type-A port |
| 4. | Ethernet (RJ-45) port* |
| 5. | USB 3.2 Gen 1 Type-A ports 34 and 78 |
| 6. | HDMI™ port |
| 7. | USB Type-C® |
| 8. | Optical S/PDIF OUT port |
| 9. | audio jacks** |

* and **: Refer to the tables on the next page for LAN port LEDs, and audio port definitions.



- We strongly recommend that you connect your devices to ports with matching data transfer rate. Please connect your USB 3.2 Gen 1 devices to USB 3.2 Gen 1 ports and your USB 3.2 Gen 2 devices to USB 3.2 Gen 2 ports for faster and better performance for your devices.
- Due to the design of the Intel chipset, all USB devices connected to the USB 3.2 Gen 1 ports are controlled by the xHCI controller. Some legacy USB devices must update their firmware for better compatibility.

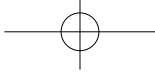

*** Ethernet port LED indications**

| Activity Link LED | | Speed LED | |
|-------------------|---------------|-----------|---------------------|
| Status | Description | Status | Description |
| Off | No link | Off | 10 Mbps connection |
| Orange | Linked | Orange | 100 Mbps connection |
| Blinking | Data activity | Green | 1 Gbps connection |

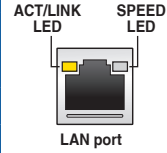

**** Audio 2, 4, 5.1 or 7.1-channel configuration**

| Port | Headset 2-channel | 4-channel | 5.1-channel | 7.1-channel |
|------------|-------------------|-------------------|-------------------|-------------------|
| Light Blue | Line In | Line In | Line In | Side Speaker Out |
| Lime | Line Out | Front Speaker Out | Front Speaker Out | Front Speaker Out |
| Pink | Mic In | Mic In | Mic In | Mic In |
| Orange | – | – | Center/Sub woofer | Center/Sub woofer |
| Black | – | Rear Speaker Out | Rear Speaker Out | Rear Speaker Out |

2.2.2 Audio I/O connections

Audio I/O ports

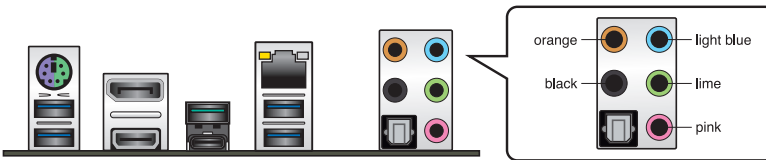

Connect to Headphone and Mic



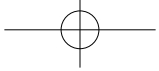

Connect to Stereo Speakers

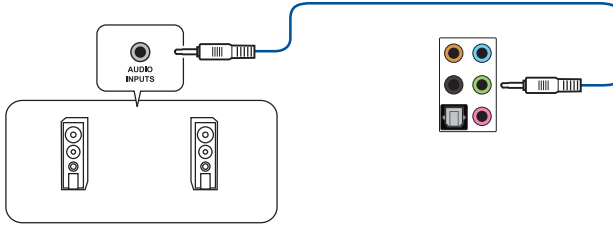

Connect to 2-channel Speakers

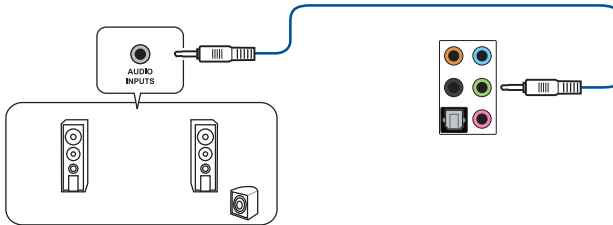

Connect to 4-channel Speakers

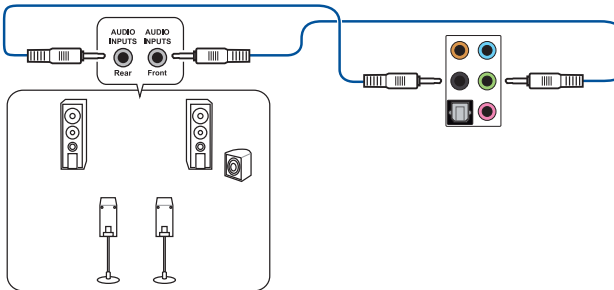

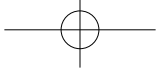

Connect to 5.1-channel Speakers

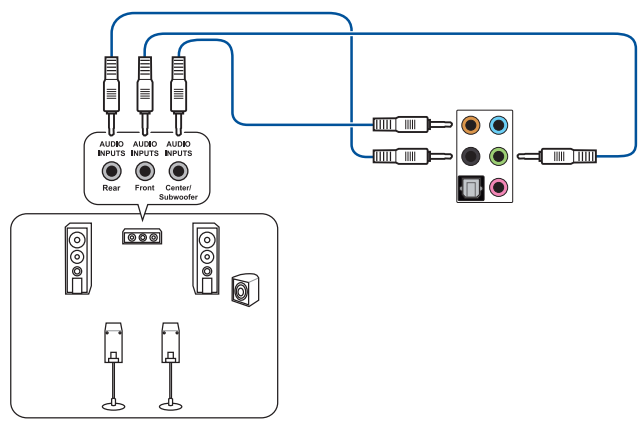

Connect to 7.1-channel Speakers

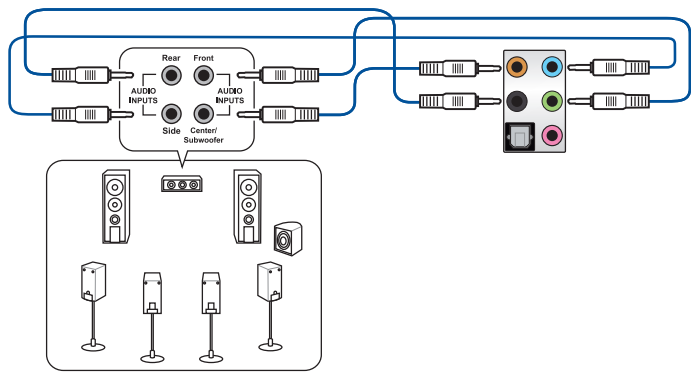

Chapter 2

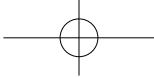

2.3 Starting up for the first time

1. After making all the connections, replace the system case cover.
2. Ensure that all switches are off.
3. Connect the power cord to the power connector at the back of the system chassis.
4. Connect the power cord to a power outlet that is equipped with a surge protector.
5. Turn on the devices in the following order:
 - a. Monitor
 - b. External SCSI devices (starting with the last device on the chain)
 - c. System power
6. After applying power, the system power LED on the system front panel case lights up. For systems with ATX power supplies, the system LED lights up when you press the ATX power button. If your monitor complies with the “green” standards or if it has a “power standby” feature, the monitor LED may light up or change from orange to green after the system LED turns on.

The system then runs the power-on self tests (POST). While the tests are running, the BIOS beeps (refer to the BIOS beep codes table) or additional messages appear on the screen. If you do not see anything within 30 seconds from the time you turned on the power, the system may have failed a power-on test. Check the jumper settings and connections or call your retailer for assistance.

| BIOS Beep | Description |
|---|--|
| One short beep | VGA detected Quick boot set to disabled No keyboard detected |
| One continuous beep followed by two short beeps then a pause (repeated) | No memory detected |
| One continuous beep followed by three short beeps | No VGA detected |
| One continuous beep followed by four short beeps | Hardware component failure |

7. At power on, hold down the <Delete> key to enter the BIOS Setup. Follow the instructions in Chapter 3.

2.4 Turning off the computer

While the system is ON, press the power button for less than four seconds to put the system on sleep mode or soft-off mode, depending on the BIOS setting. Press the power button for more than four seconds to let the system enter the soft-off mode regardless of the BIOS setting.

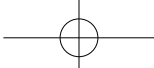

BIOS and RAID Support

3



For more details on BIOS and RAID configurations, please refer to www.asus.com/support.

3.1 Knowing BIOS



The new ASUS UEFI BIOS is a Unified Extensible Interface that complies with UEFI architecture, offering a user-friendly interface that goes beyond the traditional keyboard-only BIOS controls to enable a more flexible and convenient mouse input. You can easily navigate the new UEFI BIOS with the same smoothness as your operating system. The term "BIOS" in this user manual refers to "UEFI BIOS" unless otherwise specified.

BIOS (Basic Input and Output System) stores system hardware settings such as storage device configuration, overclocking settings, advanced power management, and boot device configuration that are needed for system startup in the motherboard CMOS. In normal circumstances, the default BIOS settings apply to most conditions to ensure optimal performance. **DO NOT change the default BIOS settings** except in the following circumstances:

- An error message appears on the screen during the system bootup and requests you to run the BIOS Setup.
- You have installed a new system component that requires further BIOS settings or update.



Inappropriate BIOS settings may result to instability or boot failure. **We strongly recommend that you change the BIOS settings only with the help of a trained service personnel.**



- When downloading or updating the BIOS file, rename it as **TGZ490P.CAP** for this motherboard.
- BIOS settings and options may vary due to different BIOS release versions. Please refer to the latest BIOS version for settings and options.



For more information on BIOS configurations, please refer to <https://www.asus.com/support>, or download the BIOS manual by scanning the QR code.



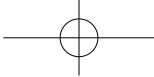

3.2 BIOS setup program

Use the BIOS Setup to update the BIOS or configure its parameters. The BIOS screen include navigation keys and brief onscreen help to guide you in using the BIOS Setup program.

Entering BIOS at startup

To enter BIOS Setup at startup, press <Delete> or <F2> during the Power-On Self Test (POST). If you do not press <Delete> or <F2>, POST continues with its routines.

Entering BIOS Setup after POST

To enter BIOS Setup after POST:

- Press <Ctrl>+<Alt>+<Delete> simultaneously.
- Press the reset button on the system chassis.
- Press the power button to turn the system off then back on. Do this option only if you failed to enter BIOS Setup using the first two options.

After doing either of the three options, press <Delete> key to enter BIOS.



- Ensure that a USB mouse is connected to your motherboard if you want to use the mouse to control the BIOS setup program.
- If the system becomes unstable after changing any BIOS setting, load the default settings to ensure system compatibility and stability. Select the **Load Optimized Defaults** item under the **Exit** menu or press hotkey <F5>.
- If the system fails to boot after changing any BIOS setting, try to clear the CMOS and reset the motherboard to the default value.
- The BIOS setup program does not support Bluetooth devices.

BIOS menu screen

The BIOS Setup program can be used under two modes: **EZ Mode** and **Advanced Mode**. You can change modes from **Setup Mode** in **Boot menu** or by pressing the <F7> hotkey.

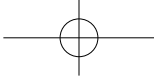

3.3 ASUS EZ Flash 3

The ASUS EZ Flash 3 feature allows you to update the BIOS without using an OS-based utility.



Ensure to load the BIOS default settings to ensure system compatibility and stability. Select the **Load Optimized Defaults** item under the **Exit** menu or press hotkey **<F5>**.

To update the BIOS by USB:



- This function can support devices such as a USB flash disk with FAT 32/16 format and single partition only.
- DO NOT shut down or reset the system while updating the BIOS to prevent system boot failure!

1. Insert the USB flash disk that contains the latest BIOS file to the USB port.
2. Enter the Advanced Mode of the BIOS setup program. Go to the **Tool** menu to select **ASUS EZ Flash 3 Utility** and press **<Enter>**.
3. Select **via Storage Device(s)**.
4. Press **<Tab>** to switch to the **Drive** field.
5. Press the Up/Down arrow keys to find the USB flash disk that contains the latest BIOS, and then press **<Enter>**.
6. Press **<Tab>** to switch to the **Folder** field.
7. Press the Up/Down arrow keys to find the BIOS file, and then press **<Enter>** to perform the BIOS update process. Reboot the system when the update process is done.

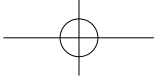

3.4 ASUS CrashFree BIOS 3

The ASUS CrashFree BIOS 3 utility is an auto recovery tool that allows you to restore the BIOS file when it fails or gets corrupted during the updating process. You can restore a corrupted BIOS file using the motherboard support DVD or a USB flash drive that contains the BIOS file.



The BIOS file in the motherboard support DVD may be older than the BIOS file published on the ASUS official website. If you want to use the newer BIOS file, download the file at <https://www.asus.com/support/> and save it to a USB flash drive.

Recovering the BIOS

To recover the BIOS:

1. Turn on the system.
2. Insert the motherboard support DVD to the optical drive, or the USB flash drive containing the BIOS file to the USB port.
3. The utility automatically checks the devices for the BIOS file. When found, the utility reads the BIOS file and enters ASUS EZ Flash 3 automatically.
4. The system requires you to enter BIOS Setup to recover the BIOS setting. To ensure system compatibility and stability, we recommend that you press <F5> to load default BIOS values.



DO NOT shut down or reset the system while updating the BIOS! Doing so can cause system boot failure!

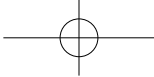

3.5 RAID configurations

The motherboard comes with the Intel® Rapid Storage Technology that supports RAID 0, RAID 1, RAID 5 and RAID 10 configuration.



For more information on configuring your RAID sets, please refer to the **RAID Configuration Guide** which you can find at <https://www.asus.com/support>, or by scanning the QR code.



RAID definitions

RAID 0 (Data striping) optimizes two identical hard disk drives to read and write data in parallel, interleaved stacks. Two hard disks perform the same work as a single drive but at a sustained data transfer rate, double that of a single disk alone, thus improving data access and storage. Use of two new identical hard disk drives is required for this setup.

RAID 1 (Data mirroring) copies and maintains an identical image of data from one drive to a second drive. If one drive fails, the disk array management software directs all applications to the surviving drive as it contains a complete copy of the data in the other drive. This RAID configuration provides data protection and increases fault tolerance to the entire system. Use two new drives or use an existing drive and a new drive for this setup. The new drive must be of the same size or larger than the existing drive.

RAID 5 stripes both data and parity information across three or more hard disk drives. Among the advantages of RAID 5 configuration include better HDD performance, fault tolerance, and higher storage capacity. The RAID 5 configuration is best suited for transaction processing, relational database applications, enterprise resource planning, and other business systems. Use a minimum of three identical hard disk drives for this setup.

RAID 10 is data striping and data mirroring combined without parity (redundancy data) having to be calculated and written. With the RAID 10 configuration you get all the benefits of both RAID 0 and RAID 1 configurations. Use four new hard disk drives or use an existing drive and three new drives for this setup.

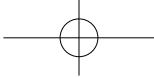

Appendix

Notices

FCC Compliance Information

Responsible Party: Asus Computer International

Address: 48720 Kato Rd., Fremont, CA 94538, USA

Phone / Fax No: (510)739-3777 / (510)608-4555

This device complies with part 15 of the FCC Rules. Operation is subject to the following two conditions: (1) This device may not cause harmful interference, and (2) this device must accept any interference received, including interference that may cause undesired operation.

This equipment has been tested and found to comply with the limits for a Class B digital device, pursuant to part 15 of the FCC Rules. These limits are designed to provide reasonable protection against harmful interference in a residential installation. This equipment generates, uses and can radiate radio frequency energy and, if not installed and used in accordance with the instructions, may cause harmful interference to radio communications. However, there is no guarantee that interference will not occur in a particular installation. If this equipment does cause harmful interference to radio or television reception, which can be determined by turning the equipment off and on, the user is encouraged to try to correct the interference by one or more of the following measures:

- Reorient or relocate the receiving antenna.
- Increase the separation between the equipment and receiver.
- Connect the equipment into an outlet on a circuit different from that to which the receiver is connected.
- Consult the dealer or an experienced radio/TV technician for help.

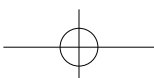

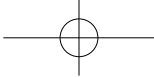

Compliance Statement of Innovation, Science and Economic Development Canada (ISED)

This device complies with Innovation, Science and Economic Development Canada licence exempt RSS standard(s). Operation is subject to the following two conditions: (1) this device may not cause interference, and (2) this device must accept any interference, including interference that may cause undesired operation of the device.

CAN ICES-3(B)/NMB-3(B)

Déclaration de conformité de Innovation, Sciences et Développement économique Canada (ISED)

Le présent appareil est conforme aux CNR d'Innovation, Sciences et Développement économique Canada applicables aux appareils radio exempts de licence. L'exploitation est autorisée aux deux conditions suivantes : (1) l'appareil ne doit pas produire de brouillage, et (2) l'utilisateur de l'appareil doit accepter tout brouillage radioélectrique subi, même si le brouillage est susceptible d'en compromettre le fonctionnement.

CAN ICES-3(B)/NMB-3(B)

VCCI: Japan Compliance Statement

Class B ITE

この装置は、クラスB情報技術装置です。この装置は、家庭環境で使用することを目的としていますが、この装置がラジオやテレビジョン受信機に近接して使用されると、受信障害を引き起こすことがあります。

取扱説明書に従って正しい取り扱いをして下さい。

VCCI-B

KC: Korea Warning Statement

B급 기기 (가정용 방송통신기자재)

이 기기는 가정용(B급) 전자파적합기기로서 주로 가정에서 사용하는 것을 목적으로 하며, 모든 지역에서 사용할 수 있습니다.

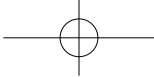

Google™ License Terms

Copyright© 2020 Google Inc. All Rights Reserved.

Licensed under the Apache License, Version 2.0 (the "License"); you may not use this file except in compliance with the License. You may obtain a copy of the License at:

<http://www.apache.org/licenses/LICENSE-2.0>

Unless required by applicable law or agreed to in writing, software distributed under the License is distributed on an "AS IS" BASIS, WITHOUT WARRANTIES OR CONDITIONS OF ANY KIND, either express or implied.

See the License for the specific language governing permissions and limitations under the License.

Declaration of compliance for product environmental regulation

ASUS follows the green design concept to design and manufacture our products, and makes sure that each stage of the product life cycle of ASUS product is in line with global environmental regulations. In addition, ASUS disclose the relevant information based on regulation requirements.

Please refer to <http://csr.asus.com/Compliance.htm> for information disclosure based on regulation requirements ASUS is complied with:

EU REACH and Article 33

Complying with the REACH (Registration, Evaluation, Authorisation, and Restriction of Chemicals) regulatory framework, we published the chemical substances in our products at ASUS REACH website at <http://csr.asus.com/english/REACH.htm>.

EU RoHS

This product complies with the EU RoHS Directive. For more details, see <http://csr.asus.com/english/article.aspx?id=35>

India RoHS

This product complies with the "India E-Waste (Management) Rules, 2016" and prohibits use of lead, mercury, hexavalent chromium, polybrominated biphenyls (PBBs) and polybrominated diphenyl ethers (PBDEs) in concentrations exceeding 0.1% by weight in homogenous materials and 0.01% by weight in homogenous materials for cadmium, except for the exemptions listed in Schedule II of the Rule.

Vietnam RoHS

ASUS products sold in Vietnam, on or after September 23, 2011, meet the requirements of the Vietnam Circular 30/2011/TT-BCT.

Các sản phẩm ASUS bán tại Việt Nam, vào ngày 23 tháng 9 năm 2011 trở về sau, đều phải đáp ứng các yêu cầu của Thông tư 30/2011/TT-BCT của Việt Nam.

Turkey RoHS

AEEE Yönetmeliğine Uygundur

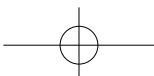

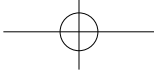

ASUS Recycling/Takeback Services

ASUS recycling and takeback programs come from our commitment to the highest standards for protecting our environment. We believe in providing solutions for you to be able to responsibly recycle our products, batteries, other components as well as the packaging materials. Please go to <http://csr.asus.com/english/Takeback.htm> for detailed recycling information in different regions.



DO NOT throw the motherboard in municipal waste. This product has been designed to enable proper reuse of parts and recycling. This symbol of the crossed out wheeled bin indicates that the product (electrical and electronic equipment) should not be placed in municipal waste. Check local regulations for disposal of electronic products.



DO NOT throw the mercury-containing button cell battery in municipal waste. This symbol of the crossed out wheeled bin indicates that the battery should not be placed in municipal waste.

Regional notice for California



WARNING

Cancer and Reproductive Harm -
www.P65Warnings.ca.gov

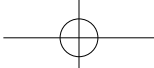

English ASUSTeK Computer Inc. hereby declares that this device is in compliance with the essential requirements and other relevant provisions of related Directives. Full text of EU declaration of conformity is available at: www.asus.com/support

Français ASUSTeK Computer Inc. déclare par la présente que cet appareil est conforme aux critères essentiels et autres clauses pertinentes des directives concernées. La déclaration de conformité de l'UE peut être téléchargée à partir du site Internet suivant : www.asus.com/support

Deutsch ASUSTeK Computer Inc. erklärt hiermit, dass dieses Gerät mit den wesentlichen Anforderungen und anderen relevanten Bestimmungen der zugehörigen Richtlinien übereinstimmt. Der gesamte Text der EU-Konformitätserklärung ist verfügbar unter: www.asus.com/support

Italiano ASUSTeK Computer Inc. con la presente dichiara che questo dispositivo è conforme ai requisiti essenziali e alle altre disposizioni pertinenti con le direttive correlate. Il testo completo della dichiarazione di conformità UE è disponibile all'indirizzo: www.asus.com/support

Русский Компания ASUS заявляет, что это устройство соответствует основным требованиям и другим соответствующим условиям соответствующих директив. Подробную информацию, пожалуйста, смотрите на www.asus.com/support

Български С настоящото ASUSTeK Computer Inc. декларира, че това устройство е в съответствие със съществените изисквания и другите приложими постановления на свързаните директиви. Пълният текст на декларацията за съответствие на ЕС е достъпна на адрес: www.asus.com/support

Hrvatski ASUSTeK Computer Inc. ovim izjavljuje da je ovaj uređaj skladan s bitnim zahtjevima i ostalim odgovarajućim odredbama vezanih direktiva. Cijeli tekst EU izjave o skladnosti dostupan je na: www.asus.com/support

Čeština Společnost ASUSTeK Computer Inc. tímto prohlašuje, že toto zařízení splňuje základní požadavky a další příslušné ustanovení souvisejících směrnic. Plné znění prohlášení o shodě EU je k dispozici na adrese: www.asus.com/support

Dansk ASUSTeK Computer Inc. erklærer hermed, at denne enhed er i overensstemmelse med hovedkravene og andre relevante bestemmelser i de relaterede direktiver. Hele EU-overensstemmelseserklæringen kan findes på: www.asus.com/support

Nederlands ASUSTeK Computer Inc. verklaart hierbij dat dit apparaat voldoet aan de essentiële vereisten en andere relevante bepalingen van de verwante richtlijnen. De volledige tekst van de EU-verklaring van conformiteit is beschikbaar op: www.asus.com/support

Eesti Käesolevaga kinnitab ASUSTeK Computer Inc, et see seade vastab asjakohaste direktiivide oluliste nõuetele ja teistele asjaespuutuvatele sätetele. EL vastavusdeklaratsiooni täielik tekst on saadaval järgmisel aadressil: www.asus.com/support

Suomi ASUSTeK Computer Inc. ilmoittaa täten, että tämä laite on asiaankuuluvien direktiivien olennaisten vaatimusten ja muiden tätä koskevien säädösten mukainen. EU-yhdenmukaisuusilmoituksen koko teksti on luettavissa osoitteessa: www.asus.com/support

Ελληνικά Με το παρόν, η ASUSTeK Computer Inc. δηλώνει ότι αυτή η συσκευή συμμορφώνεται με τις θεμελιώδεις απαιτήσεις και άλλες σχετικές διατάξεις των Οδηγιών της ΕΕ. Το πλήρες κείμενο της δήλωσης συμμόρφωσης είναι διαθέσιμο στη διεύθυνση: www.asus.com/support

Magyar Az ASUSTeK Computer Inc. ezennel kijelenti, hogy ez az eszköz megfelel a kapcsolódó irányelvek lényeges követelményeinek és egyéb vonatkozó rendelkezéseinek. Az EU megfelelőségi nyilatkozat teljes szövege innen letölthető: www.asus.com/support

Latviski ASUSTeK Computer Inc. ar šo paziņo, ka šī ierīce atbilst saistīto Direktīvu būtiskajām prasībām un citiem citiem saistošajiem nosacījumiem. Pilns ES atbilstības paziņojuma teksts pieejams šeit: www.asus.com/support

Lietuvių „ASUSTeK Computer Inc.“ šiuo tvirtina, kad šis įrenginys atitinka pagrindinius reikalavimus ir kitas svarbias susijusių direktyvų nuostatas. Visą ES atitikties deklaracijos tekstą galima rasti: www.asus.com/support

Norsk ASUSTeK Computer Inc. erklærer herved at denne enheten er i samsvar med hovedsaklige krav og andre relevante forskrifter i relaterte direktiver. Fullstendig tekst for EU-samsvarserklæringen finnes på: www.asus.com/support

Polski Firma ASUSTeK Computer Inc. niniejszym oświadcza, że urządzenie to jest zgodne z zasadniczymi wymogami i innymi właściwymi postanowieniami powiązanych dyrektyw. Pełny tekst deklaracji zgodności UE jest dostępny pod adresem: www.asus.com/support

Português A ASUSTeK Computer Inc. declara que este dispositivo está em conformidade com os requisitos essenciais e outras disposições relevantes das Diretivas relacionadas. Texto integral da declaração da UE disponível em: www.asus.com/support

Română ASUSTeK Computer Inc. declară că acest dispozitiv se conformează cerințelor esențiale și altor prevederi relevante ale directivelor conexe. Textul complet al declarației de conformitate a Uniunii Europene se găsește la: www.asus.com/support

Srpski ASUSTeK Computer Inc. ovim izjavljuje da je ovaj uređaj u saglasnosti sa osnovnim zahtjevima i drugim relevantnim odredbama povezanih Direktiva. Pun tekst EU deklaracije o usaglasnosti je dostupan da adresi: www.asus.com/support

Slovensky Spoločnosť ASUSTeK Computer Inc. týmto vyhlasuje, že toto zariadenie vyhovuje základným požiadavkám a ostatým príslušným ustanoveniam príslušných smerníc. Celý text vyhlásenia o zhode pre štáty EÚ je dostupný na adrese: www.asus.com/support

Slovenščina ASUSTeK Computer Inc. izjavlja, da je ta naprava skladna z bistvenimi zahtevami in drugimi ustreznimi določbami povezanih direktiv. Celotno besedilo EU-izjave o skladnosti je na voljo na spletnem mestu: www.asus.com/support

Español Por la presente, ASUSTeK Computer Inc. declara que este dispositivo cumple los requisitos básicos y otras disposiciones pertinentes de las directivas relacionadas. El texto completo de la declaración de la UE de conformidad está disponible en: www.asus.com/support

Svenska ASUSTeK Computer Inc. förklarar härmed att denna enhet överensstämmer med de grundläggande kraven och andra relevanta föreskrifter i relaterade direktiv. Fulltext av EU-försäkran om överensstämmelse finns på: www.asus.com/support

Українська ASUSTeK Computer Inc. заявляє, що цей пристрій відповідає основним вимогам та іншим відповідним положенням відповідних Директив. Повний текст декларації відповідності стандартам ЄС доступний на: www.asus.com/support

Türkçe Asustek Computer Inc., bu aygıtın temel gereksinimleri ve ilgli Yönergelerin diğer ilgili kısıllarına uyumlu olduğunu beyan eder. AB uygunluk bildirimini tam metni şu adreste bulunabilir: www.asus.com/support

Bosanski ASUSTeK Computer Inc. ovim izjavljuje da je ovaj uređaj uskladen sa bitnim zahtjevima i ostalim odgovarajućim odredbama vezanih direktiva. Cijeli tekst EU izjave o uskladenosti dostupan je na: www.asus.com/support

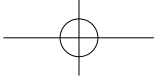

ASUS contact information

ASUSTeK COMPUTER INC.

Address 1F., No. 15, Lide Rd., Beitou Dist., Taipei City 112, Taiwan
Telephone +886-2-2894-3447
Fax +886-2-2890-7798
Web site <https://www.asus.com>

Technical Support

Telephone +86-21-38429911
Online support <https://qr.asus.com/techserv>

ASUS COMPUTER INTERNATIONAL (America)

Address 48720 Kato Rd., Fremont, CA 94538, USA
Telephone +1-510-739-3777
Fax +1-510-608-4555
Web site <https://www.asus.com/us/>

Technical Support

Support fax +1-812-284-0883
Telephone +1-812-282-2787
Online support <https://qr.asus.com/techserv>

ASUS COMPUTER GmbH (Germany and Austria)

Address Harkortstrasse 21-23, 40880 Ratingen, Germany
Web site <https://www.asus.com/de>
Online contact <https://www.asus.com/support/Product/ContactUs/Services/questionform/?lang=de-de>

Technical Support

Telephone (DE) +49-2102-5789557
Telephone (AT) +43-1360-2775461
Online support <https://www.asus.com/de/support>