

# Inspiron 7501

## Service Manual



## Notes, cautions, and warnings

 **NOTE:** A NOTE indicates important information that helps you make better use of your product.

 **CAUTION:** A CAUTION indicates either potential damage to hardware or loss of data and tells you how to avoid the problem.

 **WARNING:** A WARNING indicates a potential for property damage, personal injury, or death.

© 2020 Dell Inc. or its subsidiaries. All rights reserved. Dell, EMC, and other trademarks are trademarks of Dell Inc. or its subsidiaries. Other trademarks may be trademarks of their respective owners.



<b>1 Working inside your computer</b> .....	<b>6</b>
Before working inside your computer.....	6
Safety instructions.....	6
Electrostatic discharge—ESD protection.....	7
ESD field service kit .....	7
After working inside your computer.....	8
<b>2 Removing and installing components</b> .....	<b>9</b>
Recommended tools.....	9
Screw list.....	9
Major components of your system.....	10
Base cover.....	11
Removing the base cover.....	11
Installing the base cover.....	13
Battery.....	15
Lithium-ion battery precautions.....	15
Removing the 3-cell battery.....	16
Installing the 3-cell battery.....	16
Removing the 6-cell battery.....	17
Installing the 6-cell battery.....	18
WLAN card.....	19
Removing the WLAN card.....	19
Installing the WLAN card.....	20
Memory modules.....	21
Removing the memory module (single slot).....	21
Installing the memory module (single slot).....	22
Solid-state drive.....	23
Removing the M.2 2280 solid-state drive (SSD-1).....	23
Installing the M.2 2280 solid-state drive (SSD-1).....	24
Removing the M.2 2230 solid-state drive (SSD-1).....	25
Installing the M.2 2230 solid-state drive (SSD-1).....	26
Replacing the SSD-1 support bracket.....	27
Removing the M.2 2280 solid-state drive (SSD-2).....	28
Installing the M.2 2280 solid-state drive (SSD-2).....	29
Speakers.....	30
Removing the speakers.....	30
Installing the speakers.....	31
GPU fan.....	32
Removing the GPU fan.....	32
Installing the GPU fan.....	33
System fan.....	34
Removing the system fan.....	34
Installing the system fan.....	34
Heat sink.....	35

Removing the heat sink (UMA).....	35
Installing the heat sink (UMA) .....	36
Removing the heat sink (discrete).....	37
Installing the heat sink (discrete).....	38
Coin-cell battery.....	39
Removing the coin-cell battery.....	39
Installing the coin-cell battery.....	40
I/O board.....	41
Removing the I/O board.....	41
Installing the I/O board.....	42
Power button with fingerprint reader (optional).....	44
Removing the power button and optional fingerprint reader.....	44
Installing the power button with optional fingerprint reader.....	45
DC-in port.....	46
Removing the DC-in port.....	46
Installing the DC-in port.....	47
Touchpad.....	49
Removing the touchpad.....	49
Installing the touchpad.....	50
Display assembly.....	51
Removing the display assembly.....	51
Installing the display assembly.....	54
System board.....	56
Removing the system board.....	56
Installing the system board.....	57
Palm-rest and keyboard assembly.....	60
Removing the palm-rest and keyboard assembly.....	60
Installing the palm-rest and keyboard assembly.....	61
<b>3 Drivers and downloads.....</b>	<b>62</b>
<b>4 System setup.....</b>	<b>63</b>
Entering BIOS setup program.....	63
Navigation keys.....	63
Boot Sequence.....	63
One time boot menu.....	64
BIOS setup.....	64
Overview.....	64
Boot configuration.....	65
Integrated Devices.....	66
Storage.....	66
Display.....	67
Connection options.....	67
Power management.....	68
Security.....	69
Password.....	70
Update and Recovery.....	71
System management.....	72
Keyboard.....	72

Pre-boot behavior.....	73
Connection options.....	74
Performance.....	74
System logs.....	75
<b>5 Troubleshooting.....</b>	<b>77</b>
Built-in self-test (BIST).....	77
System board built-in self-test (M-BIST).....	77
Display panel power rail built-in self-test (L-BIST).....	78
Display panel built-in self-test (LCD-BIST).....	78
Outcome.....	79
SupportAssist diagnostics.....	79
Running the SupportAssist diagnostics.....	79
System diagnostic lights.....	79
Recovering the operating system.....	80
Flashing the BIOS.....	81
Flashing BIOS (USB key).....	81
Backup media and recovery options.....	81
WiFi power cycle.....	81
<b>6 Getting help and contacting Dell.....</b>	<b>83</b>



# Working inside your computer

## Before working inside your computer

### About this task









 **NOTE:** The images in this document may differ from your computer depending on the configuration you ordered.

### Steps

1. Save and close all open files and exit all open applications.
2. Shut down your computer. Click **Start** > **Power** > **Shut down**.  
 **NOTE:** If you are using a different operating system, see the documentation of your operating system for shut-down instructions.
3. Disconnect your computer and all attached devices from their electrical outlets.
4. Disconnect all attached network devices and peripherals, such as keyboard, mouse, and monitor from your computer.  
 **CAUTION:** To disconnect a network cable, first unplug the cable from your computer and then unplug the cable from the network device.
5. Remove any media card and optical disc from your computer, if applicable.

## Safety instructions

Use the following safety guidelines to protect your computer from potential damage and to ensure your personal safety. Unless otherwise noted, each procedure included in this document assumes that you have read the safety information that shipped with your computer.

-  **NOTE:** Before working inside your computer, read the safety information that is shipped with your computer. For more safety best practices, see the Regulatory Compliance home page at [www.dell.com/regulatory\\_compliance](http://www.dell.com/regulatory_compliance).
-  **NOTE:** Disconnect your computer from all power sources before opening the computer cover or panels. After you finish working inside the computer, replace all covers, panels, and screws before connecting your computer to an electrical outlet.
-  **CAUTION:** To avoid damaging the computer, ensure that the work surface is flat, dry and clean.
-  **CAUTION:** To avoid damaging the components and cards, handle them by their edges, and avoid touching the pins and the contacts.
-  **CAUTION:** You should only perform troubleshooting and repairs as authorized or directed by the Dell technical assistance team. Damage due to servicing that is not authorized by Dell is not covered by your warranty. See the safety instructions that is shipped with the product or at [www.dell.com/regulatory\\_compliance](http://www.dell.com/regulatory_compliance).
-  **CAUTION:** Before touching anything inside your computer, ground yourself by touching an unpainted metal surface, such as the metal at the back of the computer. While you work, periodically touch an unpainted metal surface to dissipate static electricity which could harm internal components.
-  **CAUTION:** When you disconnect a cable, pull it by its connector or its pull tab, not the cable itself. Some cables have connectors with locking tabs or thumb-screws that you must disengage before disconnecting the cable. When disconnecting cables, keep them evenly-aligned to avoid bending the connector pins. When connecting cables, ensure that the ports and the connectors are correctly oriented and aligned.
-  **CAUTION:** Press and eject any installed card from the media-card reader.

 **NOTE:** The color of your computer and certain components may appear differently than shown in this document.

## Electrostatic discharge—ESD protection

ESD is a major concern when you handle electronic components, especially sensitive components such as expansion cards, processors, memory DIMMs, and system boards. Very slight charges can damage circuits in ways that may not be obvious, such as intermittent problems or a shortened product life span. As the industry pushes for lower power requirements and increased density, ESD protection is an increasing concern.

Due to the increased density of semiconductors used in recent Dell products, the sensitivity to static damage is now higher than in previous Dell products. For this reason, some previously approved methods of handling parts are no longer applicable.

Two recognized types of ESD damage are catastrophic and intermittent failures.

- **Catastrophic** – Catastrophic failures represent approximately 20 percent of ESD-related failures. The damage causes an immediate and complete loss of device functionality. An example of catastrophic failure is a memory DIMM that has received a static shock and immediately generates a "No POST/No Video" symptom with a beep code emitted for missing or nonfunctional memory.
- **Intermittent** – Intermittent failures represent approximately 80 percent of ESD-related failures. The high rate of intermittent failures means that most of the time when damage occurs, it is not immediately recognizable. The DIMM receives a static shock, but the tracing is merely weakened and does not immediately produce outward symptoms related to the damage. The weakened trace may take weeks or months to melt, and in the meantime may cause degradation of memory integrity, intermittent memory errors, etc.

The more difficult type of damage to recognize and troubleshoot is the intermittent (also called latent or "walking wounded") failure.

Perform the following steps to prevent ESD damage:

- Use a wired ESD wrist strap that is properly grounded. The use of wireless anti-static straps is no longer allowed; they do not provide adequate protection. Touching the chassis before handling parts does not ensure adequate ESD protection on parts with increased sensitivity to ESD damage.
- Handle all static-sensitive components in a static-safe area. If possible, use anti-static floor pads and workbench pads.
- When unpacking a static-sensitive component from its shipping carton, do not remove the component from the anti-static packing material until you are ready to install the component. Before unwrapping the anti-static packaging, ensure that you discharge static electricity from your body.
- Before transporting a static-sensitive component, place it in an anti-static container or packaging.

## ESD field service kit

The unmonitored Field Service kit is the most commonly used service kit. Each Field Service kit includes three main components: anti-static mat, wrist strap, and bonding wire.

## Components of an ESD field service kit

The components of an ESD field service kit are:

- **Anti-Static Mat** – The anti-static mat is dissipative and parts can be placed on it during service procedures. When using an anti-static mat, your wrist strap should be snug and the bonding wire should be connected to the mat and to any bare metal on the system being worked on. Once deployed properly, service parts can be removed from the ESD bag and placed directly on the mat. ESD-sensitive items are safe in your hand, on the ESD mat, in the system, or inside a bag.
- **Wrist Strap and Bonding Wire** – The wrist strap and bonding wire can be either directly connected between your wrist and bare metal on the hardware if the ESD mat is not required, or connected to the anti-static mat to protect hardware that is temporarily placed on the mat. The physical connection of the wrist strap and bonding wire between your skin, the ESD mat, and the hardware is known as bonding. Use only Field Service kits with a wrist strap, mat, and bonding wire. Never use wireless wrist straps. Always be aware that the internal wires of a wrist strap are prone to damage from normal wear and tear, and must be checked regularly with a wrist strap tester in order to avoid accidental ESD hardware damage. It is recommended to test the wrist strap and bonding wire at least once per week.
- **ESD Wrist Strap Tester** – The wires inside of an ESD strap are prone to damage over time. When using an unmonitored kit, it is a best practice to regularly test the strap prior to each service call, and at a minimum, test once per week. A wrist strap tester is the best method for doing this test. If you do not have your own wrist strap tester, check with your regional office to find out if they have one. To perform the test, plug the wrist-strap's bonding-wire into the tester while it is strapped to your wrist and push the button to test. A green LED is lit if the test is successful; a red LED is lit and an alarm sounds if the test fails.
- **Insulator Elements** – It is critical to keep ESD sensitive devices, such as plastic heat sink casings, away from internal parts that are insulators and often highly charged.

- **Working Environment** – Before deploying the ESD Field Service kit, assess the situation at the customer location. For example, deploying the kit for a server environment is different than for a desktop or portable environment. Servers are typically installed in a rack within a data center; desktops or portables are typically placed on office desks or cubicles. Always look for a large open flat work area that is free of clutter and large enough to deploy the ESD kit with additional space to accommodate the type of system that is being repaired. The workspace should also be free of insulators that can cause an ESD event. On the work area, insulators such as Styrofoam and other plastics should always be moved at least 12 inches or 30 centimeters away from sensitive parts before physically handling any hardware components
- **ESD Packaging** – All ESD-sensitive devices must be shipped and received in static-safe packaging. Metal, static-shielded bags are preferred. However, you should always return the damaged part using the same ESD bag and packaging that the new part arrived in. The ESD bag should be folded over and taped shut and all the same foam packing material should be used in the original box that the new part arrived in. ESD-sensitive devices should be removed from packaging only at an ESD-protected work surface, and parts should never be placed on top of the ESD bag because only the inside of the bag is shielded. Always place parts in your hand, on the ESD mat, in the system, or inside an anti-static bag.
- **Transporting Sensitive Components** – When transporting ESD sensitive components such as replacement parts or parts to be returned to Dell, it is critical to place these parts in anti-static bags for safe transport.

## ESD protection summary

It is recommended that all field service technicians use the traditional wired ESD grounding wrist strap and protective anti-static mat at all times when servicing Dell products. In addition, it is critical that technicians keep sensitive parts separate from all insulator parts while performing service and that they use anti-static bags for transporting sensitive components.

## After working inside your computer

### About this task

 **CAUTION:** Leaving stray or loose screws inside your computer may severely damage your computer.

### Steps

1. Replace all screws and ensure that no stray screws remain inside your computer.
2. Connect any external devices, peripherals, or cables you removed before working on your computer.
3. Replace any media cards, discs, or any other parts that you removed before working on your computer.
4. Connect your computer and all attached devices to their electrical outlets.
5. Turn on your computer.

# Removing and installing components

## Recommended tools

The procedures in this document may require the following tools:

- Phillips screwdriver #0
- Phillips screwdriver #1
- Plastic scribe

**NOTE:** The #0 screw driver is for screws M0-M1, and the #1 screw driver is for screws M2-M4.











## Screw list







**NOTE:** When removing screws from a component, it is recommended to note the screw type, the quantity of screws, and then place them in a screw storage box. This is to ensure that the correct number of screws and correct screw type is restored when the component is replaced.

**NOTE:** Some computers have magnetic surfaces. Ensure that the screws are not left attached to such surface when replacing a component.

**NOTE:** Screw color may vary with the configuration ordered.

**Table 1. Screw list**

Component	Secured to	Screw type	Quantity	Screw image
Base cover	Palm-rest and keyboard assembly	M2x4	4	
3-cell Battery	Palm-rest and keyboard assembly	M2x5	5	
6-cell Battery	Palm-rest and keyboard assembly	M2x5	8	
Solid-state drive - 1	Palm-rest and keyboard assembly	M2x3	2	
Solid-state drive - 2	System board	M2x3	1	
GPU fan	System board	M2x4	2	
System fan	System board	M2x4	2	
I/O board	Palm-rest and keyboard assembly	M2x3	2	
Power button with fingerprint reader	Palm-rest and keyboard assembly	M1.6x2.5	2	
Touchpad	Palm-rest and keyboard assembly	M2x2	3	
		M1.6x2	2	

Component	Secured to	Screw type	Quantity	Screw image
Display-assembly hinges	Palm-rest and keyboard assembly	M2.5x5	2	
		M2.5x4	2	
Power-adapter port	Palm-rest and keyboard assembly	M1.6x2.5	1	
Wireless-card bracket	Palm-rest and keyboard assembly	M2x3	1	
System board	Palm-rest and keyboard assembly	M2x3	4	
				

## Major components of your system

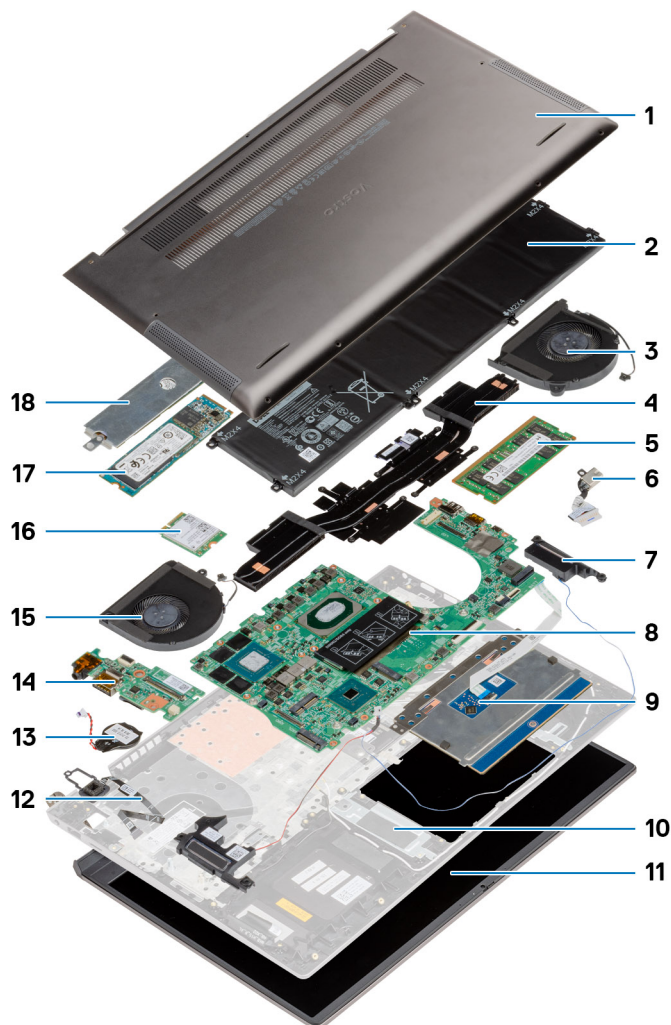

1. Base cover
2. Battery
3. System fan



4. Heat sink
5. Memory module
6. DC-in port
7. Speaker
8. System board
9. Touchpad
10. Palm-rest and keyboard assembly
11. Display assembly
12. Power button with fingerprint reader
13. Coin-cell battery
14. I/O board
15. GPU fan
16. WLAN card
17. M.2 2280 SSD
18. Solid-state drive shield

**i** **NOTE:** Dell provides a list of components and their part numbers for the original system configuration purchased. These parts are available according to warranty coverages purchased by the customer. Contact your Dell sales representative for purchase options.

## Base cover

### Removing the base cover

#### Prerequisites

Follow the procedure in [before working inside your computer](#).

#### About this task

The figure indicates the location of the base cover and provides a visual representation of the removal procedure.

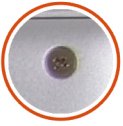

7x  
M2x4

1

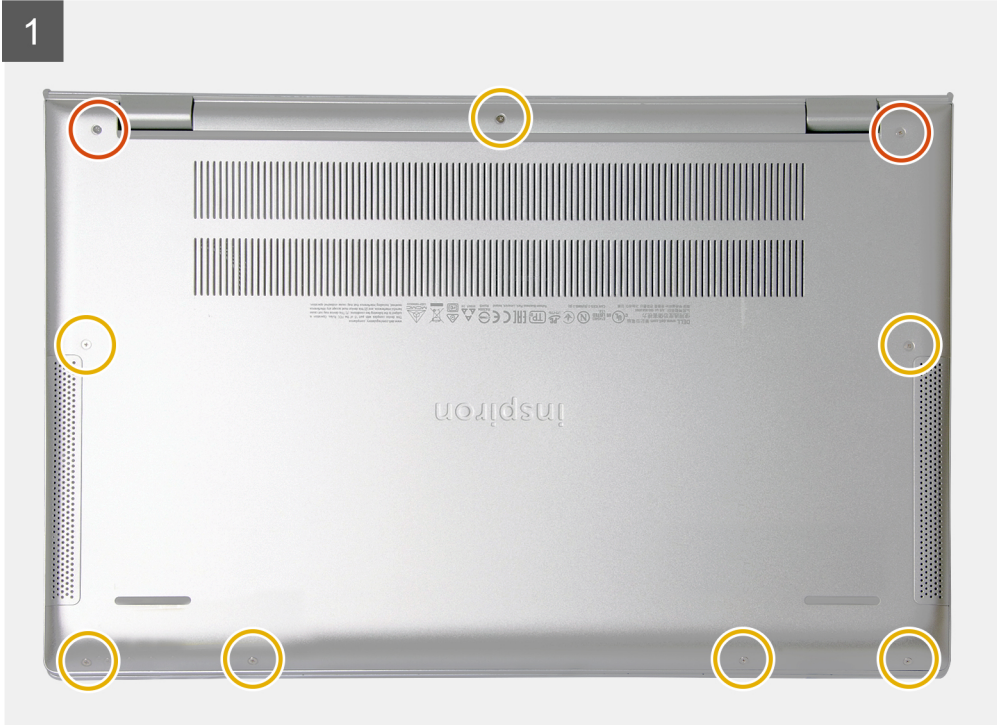

2

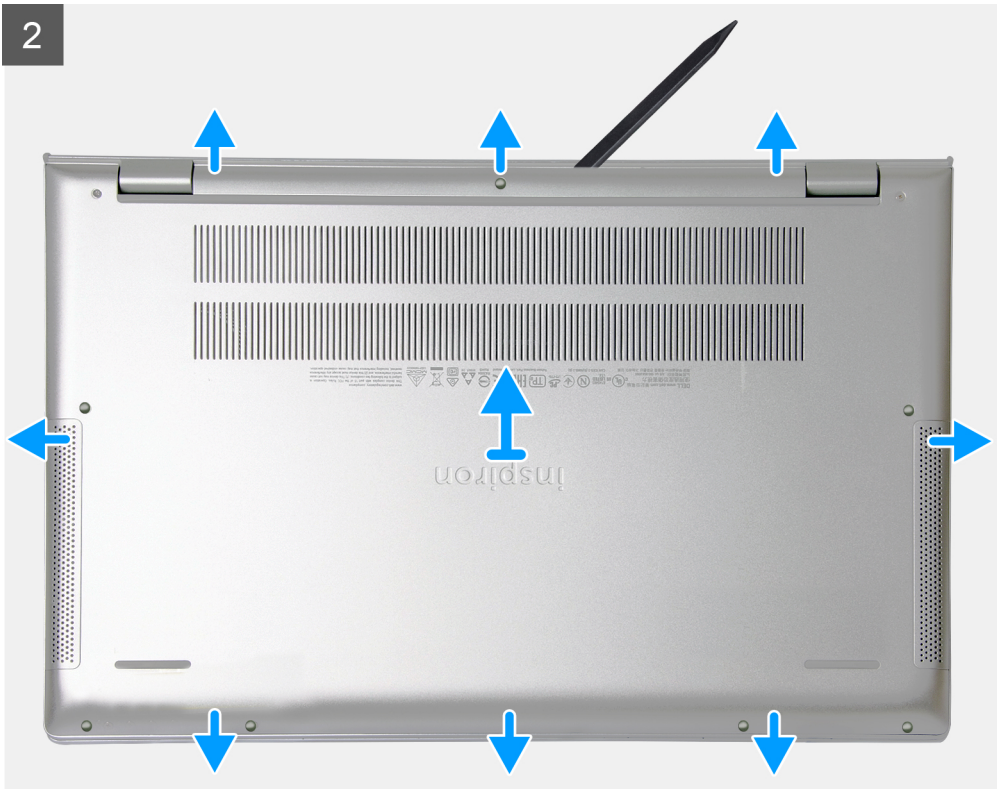

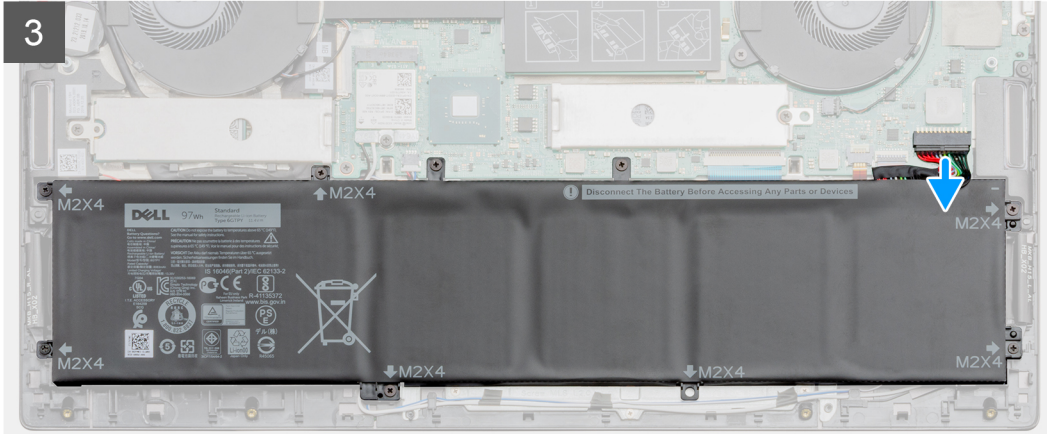
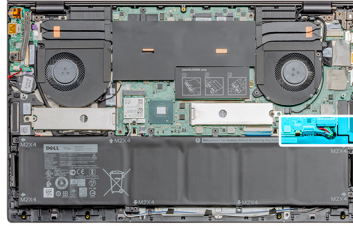

### Steps

1. Remove the seven screws (M2x4) that secure the base cover to the palm-rest and keyboard assembly.
2. Loosen the two captive screws that secure the base cover to the palm-rest and keyboard assembly.
3. Pry the base cover starting from the recess at the hinge area and work your way around.
4. Lift the base cover off away from the laptop.

## Installing the base cover

### Prerequisites

If you are replacing a component, remove the existing component before performing the installation procedure.

### About this task

The figure indicates the location of the base cover and provides a visual representation of the installation procedure.

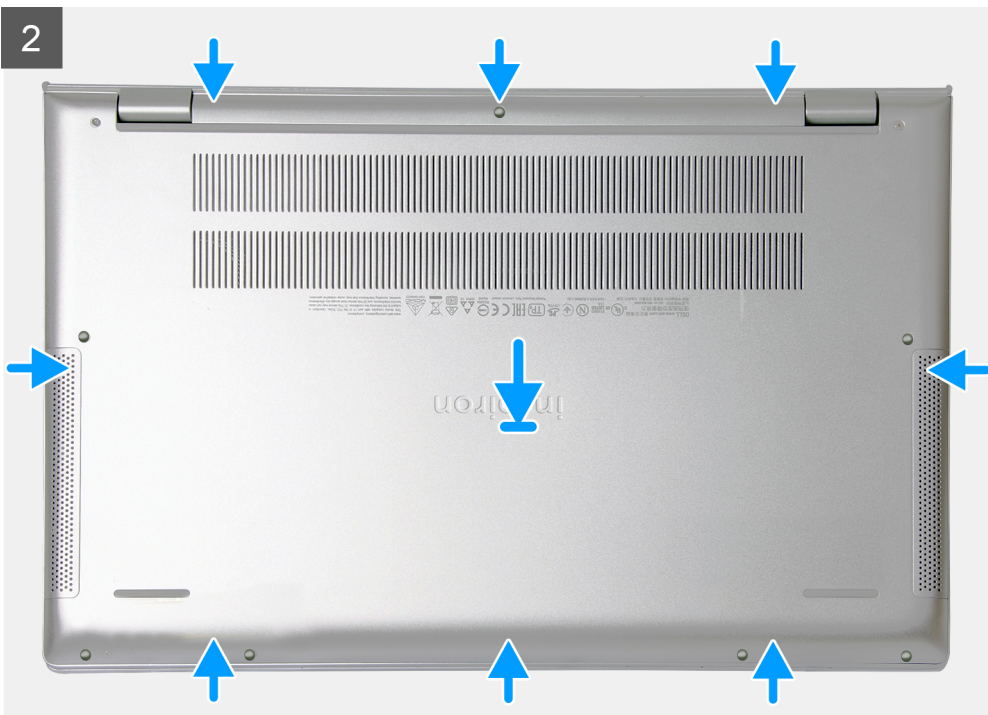
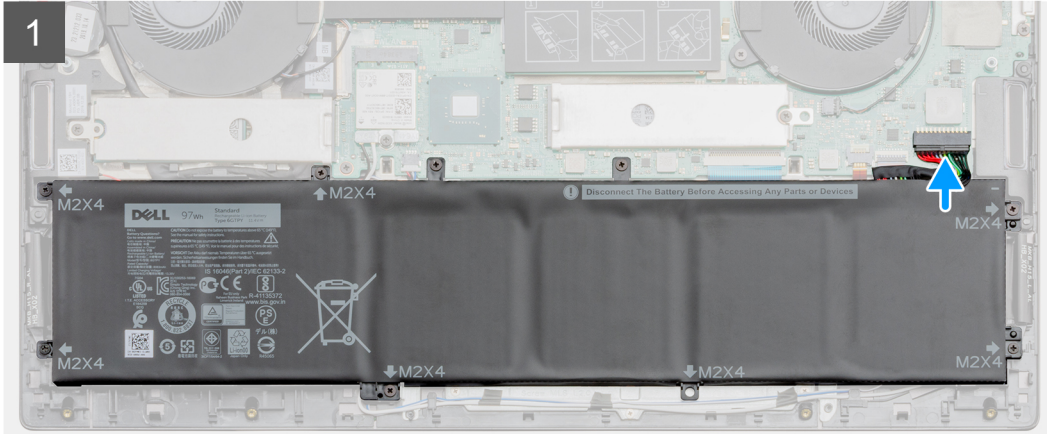
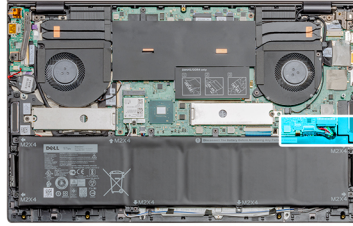



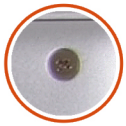

7x  
M2x4

3

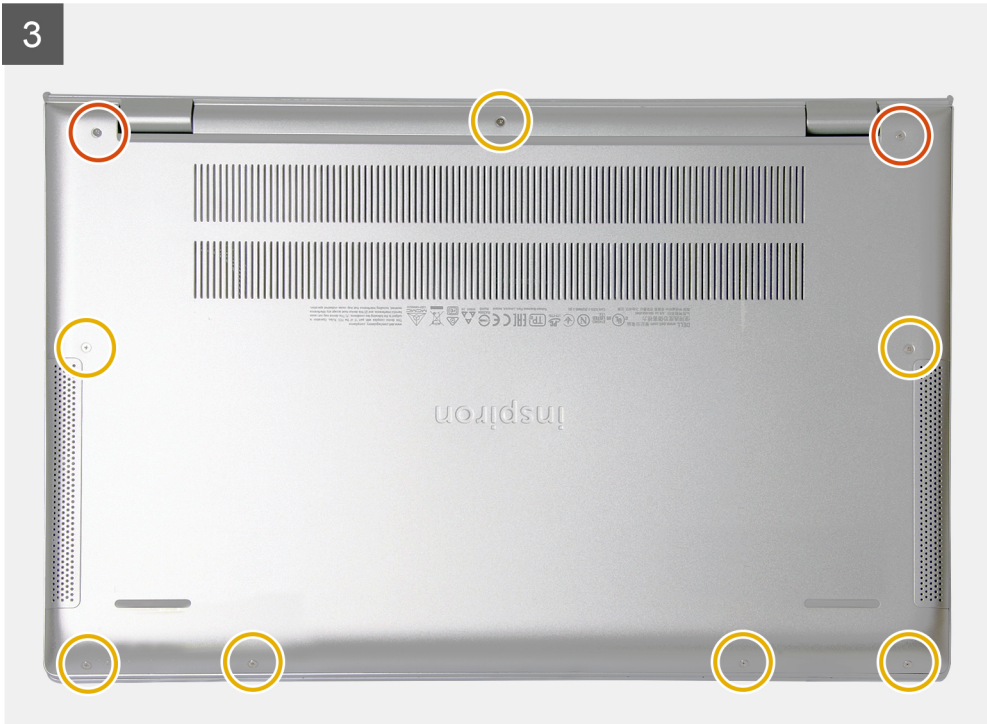

### Steps

1. Place the base cover on the palm-rest and keyboard assembly, and snap the base cover into place.
2. Tighten the two captive screws that secure the base cover to the palm-rest and keyboard assembly.
3. Replace the seven screws (M2x4) that secure the base cover to the palm-rest and keyboard assembly.

### Next steps

Follow the procedure in [after working inside your computer](#).

## Battery

### Lithium-ion battery precautions

#### ⚠ CAUTION:

- Exercise caution when handling Lithium-ion batteries.
- Discharge the battery as much as possible before removing it from the system. This can be done by disconnecting the AC adapter from the system to allow the battery to drain.
- Do not crush, drop, mutilate, or penetrate the battery with foreign objects.
- Do not expose the battery to high temperatures, or disassemble battery packs and cells.
- Do not apply pressure to the surface of the battery.
- Do not bend the battery.
- Do not use tools of any kind to pry on or against the battery.

- Ensure any screws during the servicing of this product are not lost or misplaced, to prevent accidental puncture or damage to the battery and other system components.
- If the battery gets stuck inside your computer as a result of swelling, do not try to release it as puncturing, bending, or crushing a lithium-ion battery can be dangerous. In such an instance, contact Dell technical support for assistance. See [www.dell.com/contactdell](http://www.dell.com/contactdell).
- Always purchase genuine batteries from [www.dell.com](http://www.dell.com) or authorized Dell partners and resellers.

## Removing the 3-cell battery

### Prerequisites

**NOTE:** The battery type in your computer varies depending on the configuration ordered.

1. Follow the procedure in Before working inside your computer.
2. Remove the [base cover](#).

### About this task

The figure indicates the location of the battery and provides a visual representation of the removal procedure.

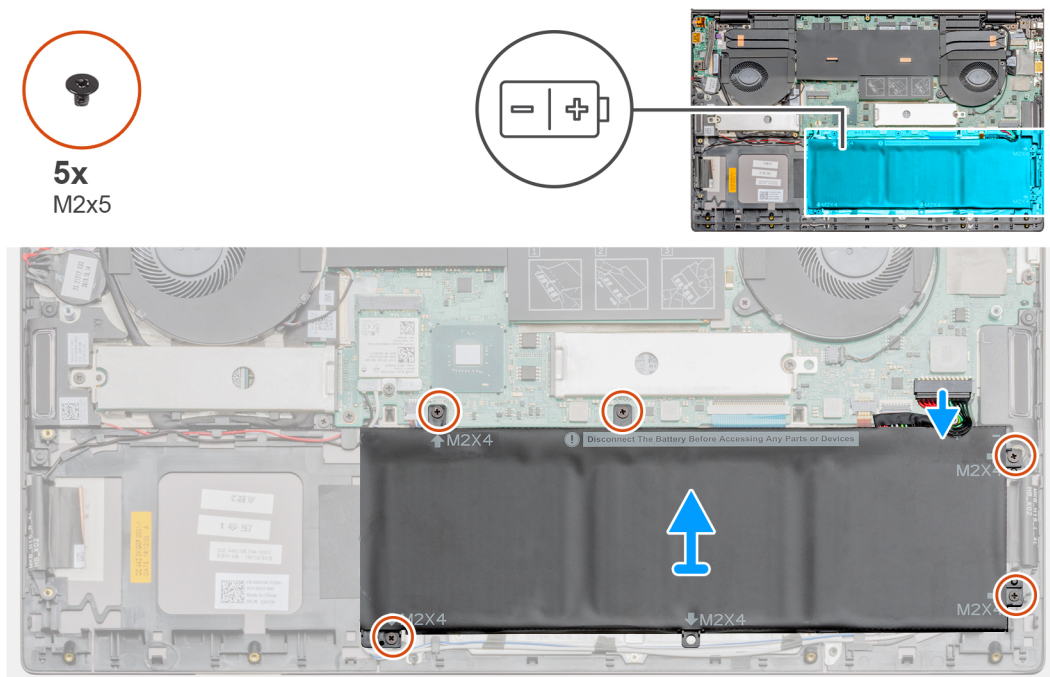

### Steps

1. Disconnect the battery cable from the system board.
2. Remove the four screws (M2x4) that secure the battery to the palm-rest and keyboard assembly.
3. Lift the battery off the palm-rest and keyboard assembly.

## Installing the 3-cell battery

### Prerequisites

If you are replacing a component, remove the existing component before performing the installation procedure.

**NOTE:** The battery type in your computer varies depending on the configuration ordered.

### About this task

The figure indicates the location of the battery and provides a visual representation of the installation procedure.

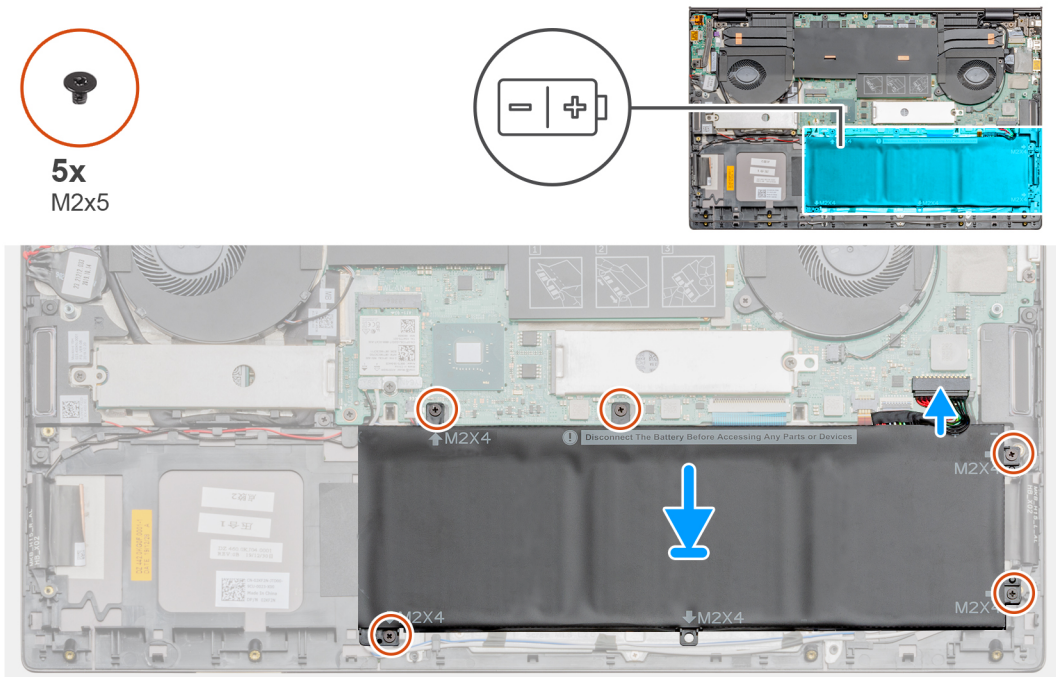

### Steps

1. Place the battery on the palm-rest and keyboard assembly and align the screw holes on the battery with the screw holes on the palmrest and keyboard assembly.
2. Install the four screws (M2x4) that secure the battery to the system board and palm-rest and keyboard assembly.
3. Connect the battery cable to the system board.

### Next steps

1. Install the [base cover](#).
2. Follow the procedure in [After working inside your computer](#).

## Removing the 6-cell battery

### Prerequisites

1. Follow the procedure in [before working inside your computer](#).
2. Remove the [base cover](#).

### About this task

**NOTE:** The battery type in your computer varies depending on the configuration ordered.

The figure indicates the location of the 6-cell battery and provides a visual representation of the removal procedure.





8x  
M2x5

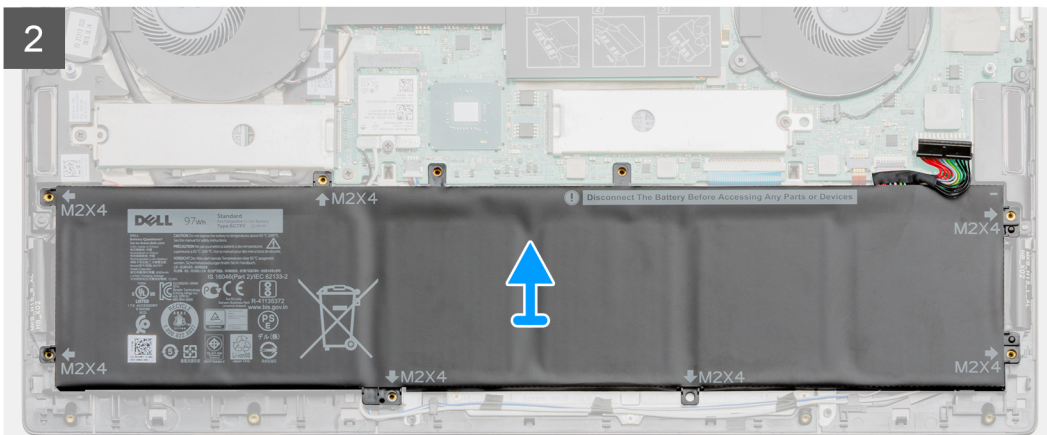
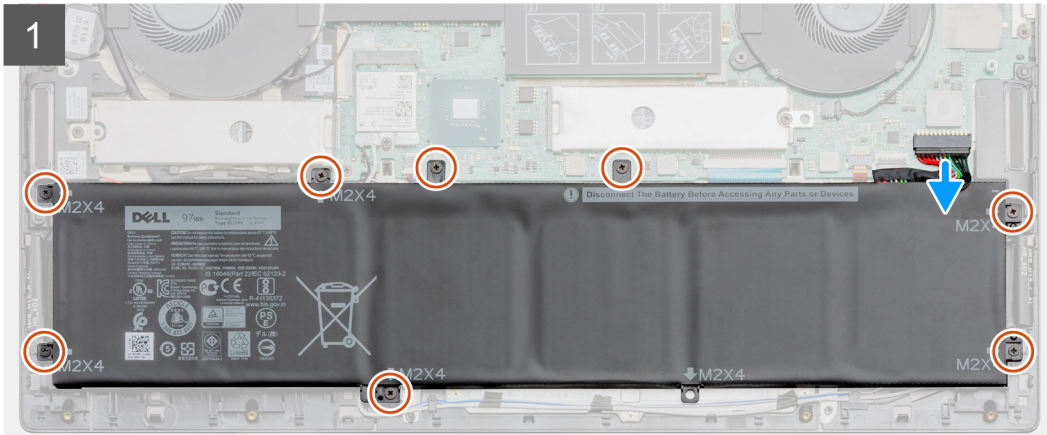
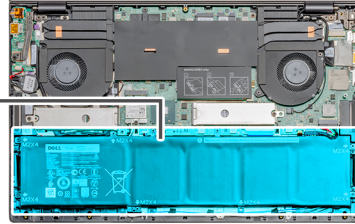
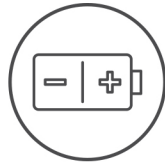

## Steps

1. Disconnect the battery cable from the system board.
2. Remove the eight screws (M2x5) that secure the battery to the palm-rest and keyboard assembly.
3. Lift the battery off the palm-rest and keyboard assembly.

# Installing the 6-cell battery

## Prerequisites

If you are replacing a component, remove the existing component before performing the installation procedure.

## About this task

**NOTE:** The battery type in your computer varies depending on the configuration ordered.

The figure indicates the location of the 6-cell battery and provides a visual representation of the installation procedure.





8x  
M2x5

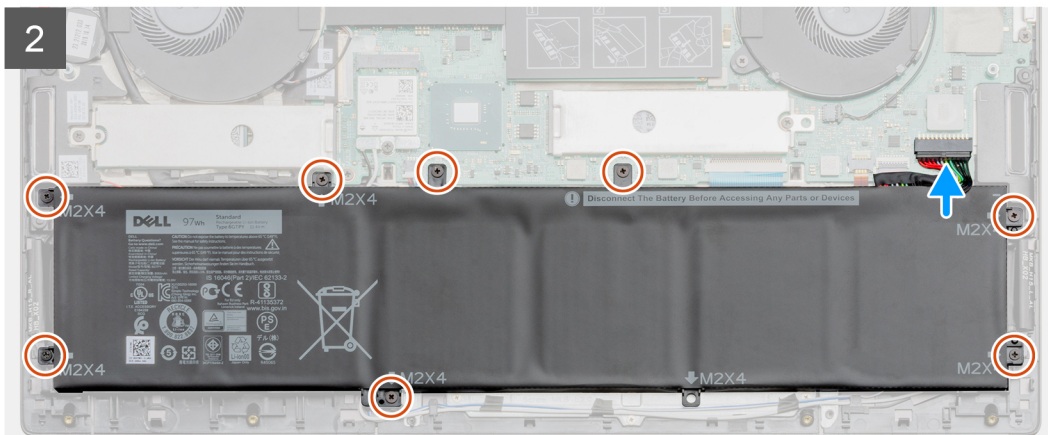
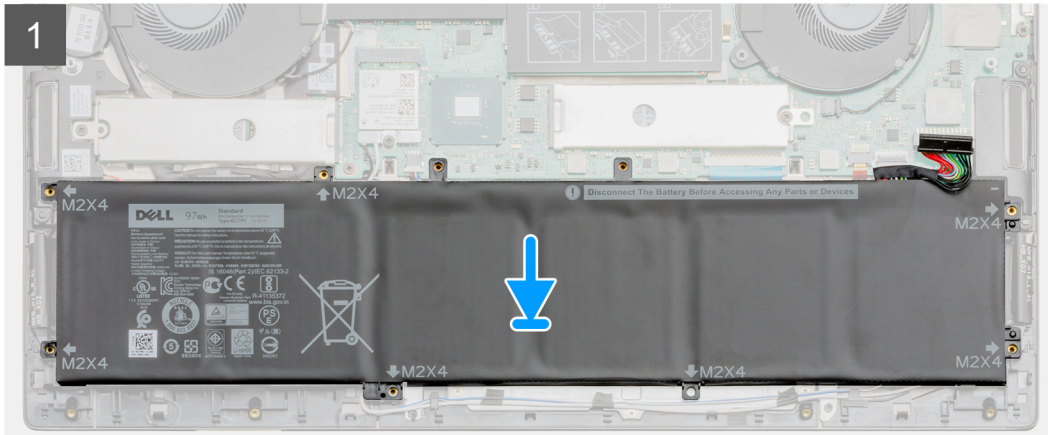
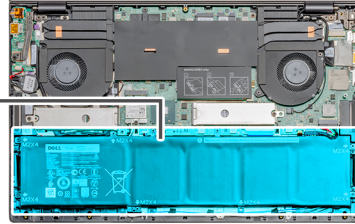
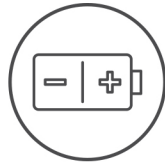

### Steps

1. Place the battery on the palm-rest and keyboard assembly and align the screw holes on the battery with the screw holes on the palmrest and keyboard assembly.
2. Replace the eight screws (M2x5) to secure the battery to the system board and palm-rest and keyboard assembly.
3. Connect the battery cable to the system board.

### Next steps

1. Install the [base cover](#).
2. Follow the procedure in [after working inside your computer](#).

## WLAN card

### Removing the WLAN card

#### Prerequisites

1. Follow the procedure in [before working inside your computer](#).
2. Remove the [base cover](#).

### About this task

The figure indicates the location of the WLAN card and provides a visual representation of the removal procedure.



### Steps

1. Remove the single screw (M2x3) that secures the WLAN card bracket to the WLAN card.
2. Remove the WLAN card bracket from the WLAN card.
3. Disconnect the antenna cables from the WLAN card.
4. Slide and remove the WLAN card from the WLAN card slot.

## Installing the WLAN card

### Prerequisites

If you are replacing a component, remove the existing component before performing the installation procedure.

### About this task

The figure indicates the location of the WLAN card and provides a visual representation of the installation procedure.



1x  
M2x3

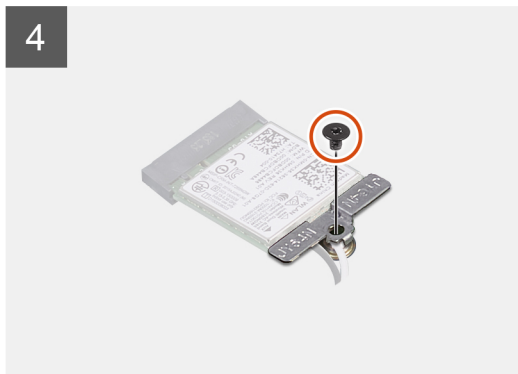
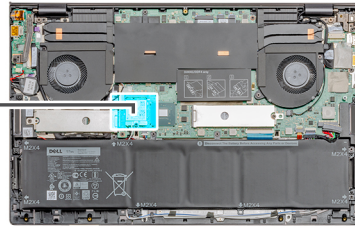

### Steps

1. Align the notch on the WLAN card with the tab on the WLAN card slot and insert the WLAN card at an angle into the WLAN card slot.
2. Connect the antenna cables to the WLAN card.
3. Align and place the WLAN card bracket on the WLAN card.
4. Replace the single screw (M2x3) to secure the WLAN card bracket to the WLAN card.

### Next steps

1. Install the [base cover](#).
2. Follow the procedure in [after working inside your computer](#).

## Memory modules

### Removing the memory module (single slot)

#### Prerequisites

1. Follow the procedure in [before working inside your computer](#).
2. Remove the [base cover](#).

#### About this task

The figure indicates the location of the memory module and provides a visual representation of the removal procedure.

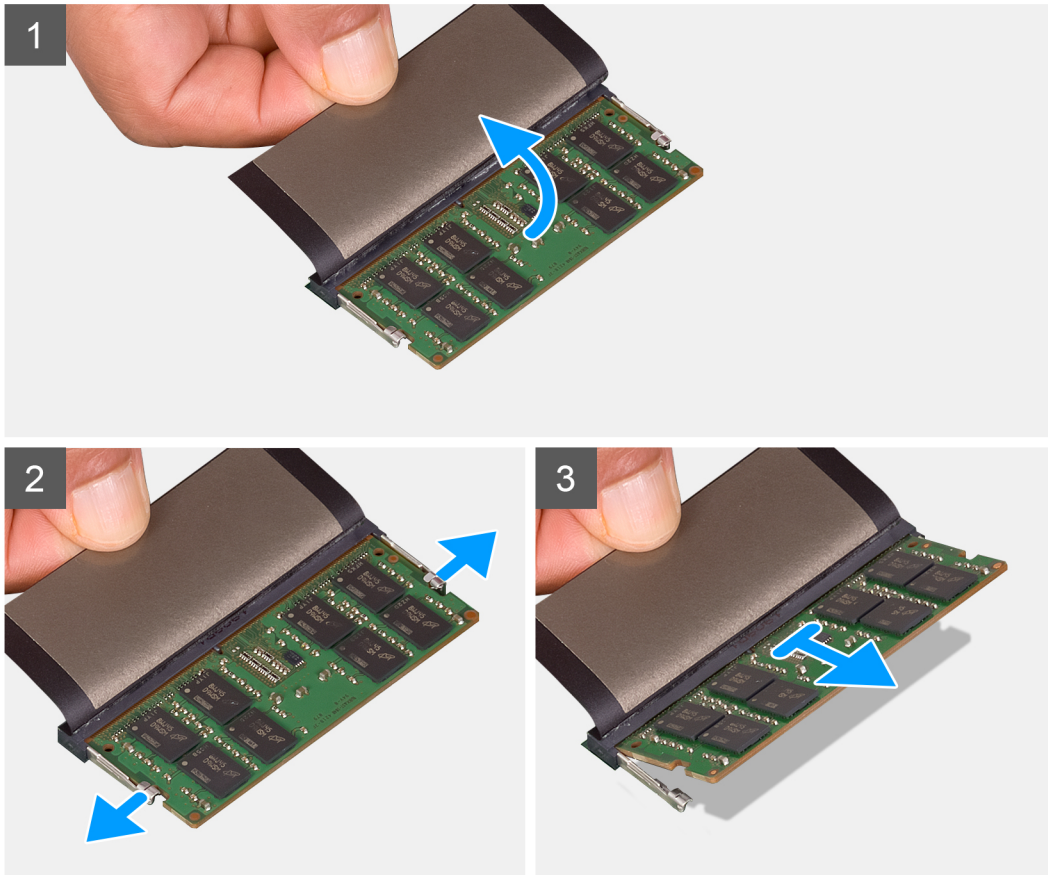
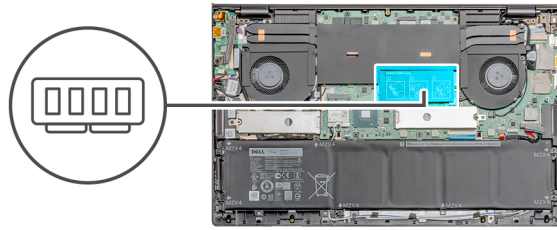

### Steps

1. Lift the mylar.
2. Use your fingertips to carefully spread apart the securing-clips on each end of the memory-module slot until the memory module pops up.
3. Slide and remove the memory module off the memory module slot on the system board.

## Installing the memory module (single slot)

### Prerequisites

If you are replacing a component, remove the existing component before performing the installation procedure.

### About this task

The figure indicates the location of the memory module and provides a visual representation of the installation procedure.



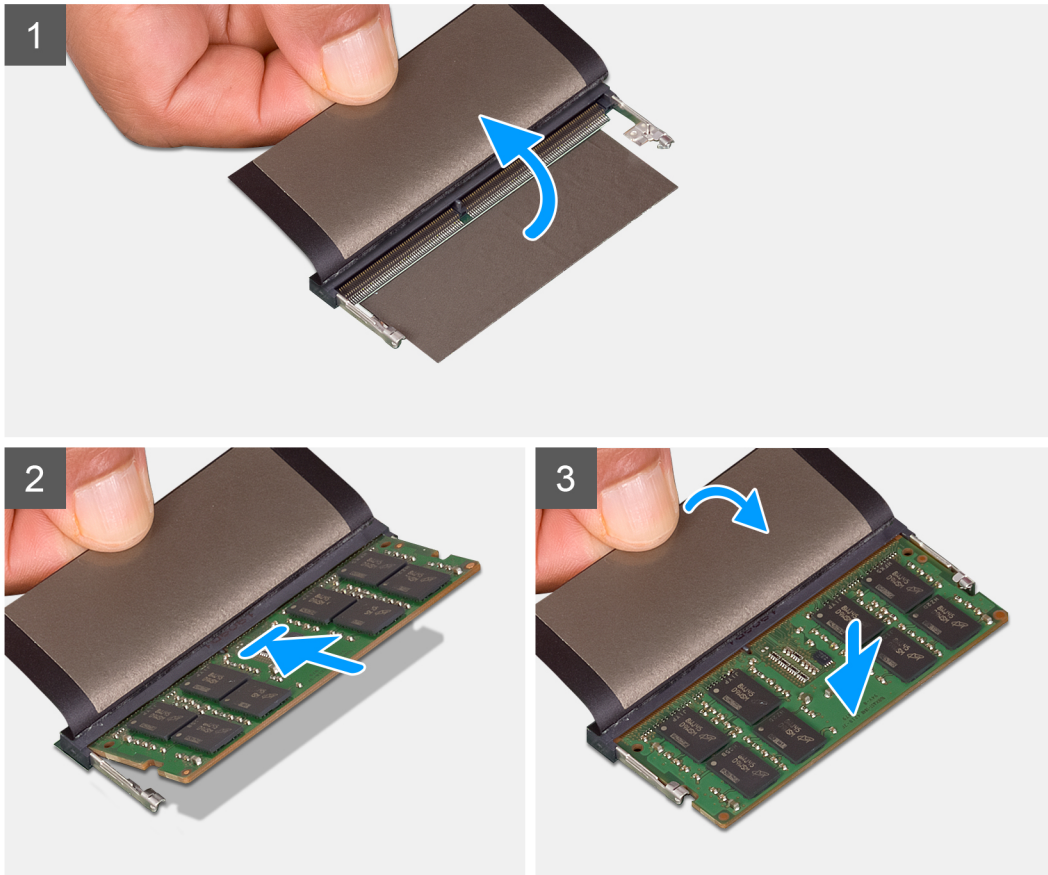
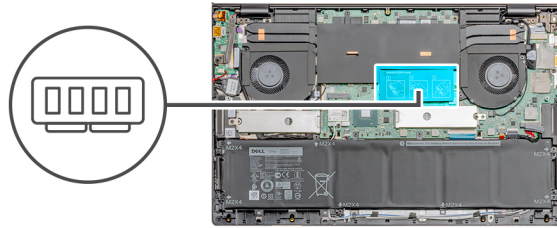

### Steps

1. Lift the mylar, and align the notch on the memory module with the tab on the memory-module slot.
2. Slide the memory module firmly into the slot at an angle.
3. Press the memory module down until it clicks into place.

**NOTE:** If you do not hear the click, remove the memory module and reinstall it.

### Next steps

1. Install the [base cover](#).
2. Follow the procedure in [after working inside your computer](#).

## Solid-state drive

### Removing the M.2 2280 solid-state drive (SSD-1)

#### Prerequisites

1. Follow the procedure in [before working inside your computer](#).

2. Remove the [base cover](#).

### About this task

The figure indicates the location of the solid-state drive and provides a visual representation of the removal procedure of M.2 2280 SSD from slot 1.

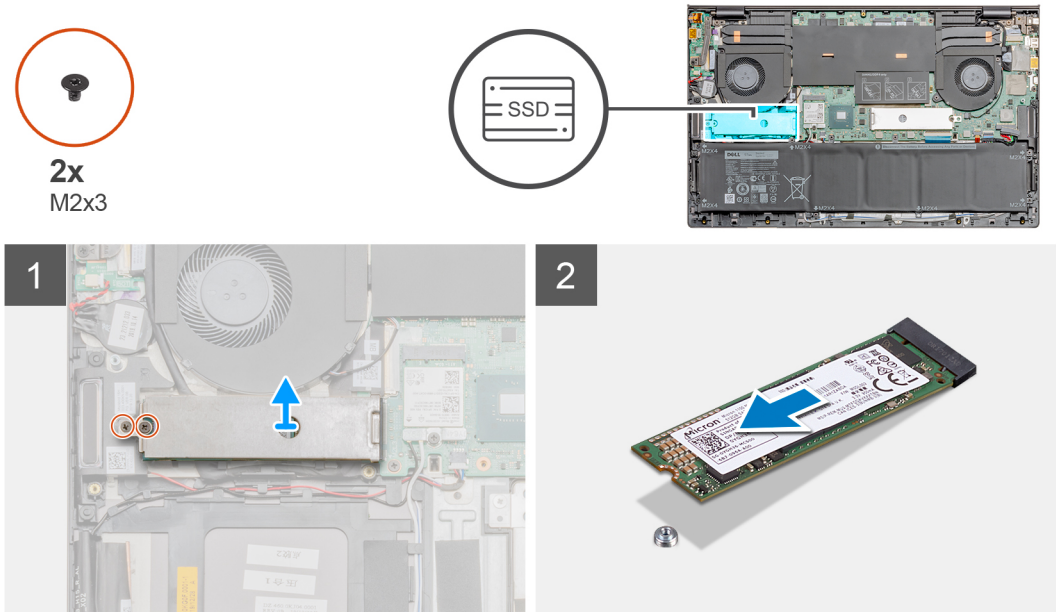

### Steps

1. Remove the two screws (M2x3) that secures the solid-state drive module shield to the palm-rest and keyboard assembly.
2. Lift and remove the solid-state drive module shield from the solid-state drive slot.
3. Slide and remove the solid-state drive module from the solid-state drive slot.

## Installing the M.2 2280 solid-state drive (SSD-1)

### Prerequisites

If you are replacing a component, remove the existing component before performing the installation procedure.

### About this task

The figure indicates the location of the solid-state drive bracket and provides a visual representation of the bracket alignment procedure to accommodate the M.2 2280 solid-state drive in slot 1.



2x  
M2x3

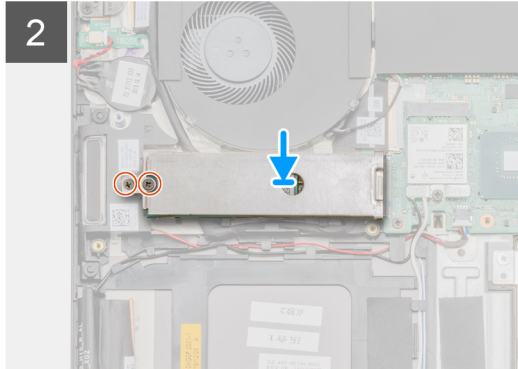
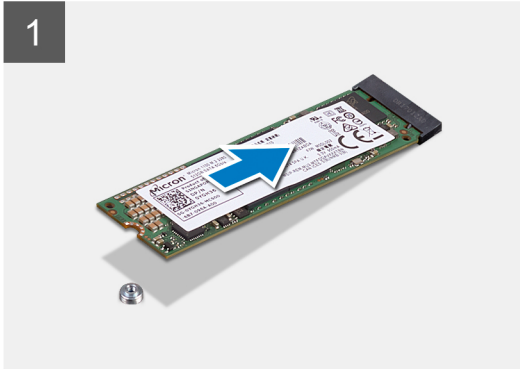
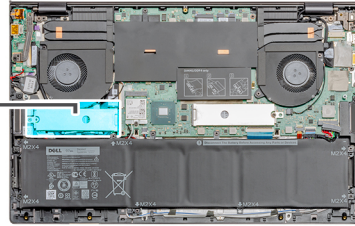

### Steps

1. Align the solid-state drive bracket to accommodate the M.2 2280 solid-state drive.
2. Slide the solid-state drive module firmly into the solid-state drive slot at an angle.
3. Place the solid-state drive module shield.
4. Replace the two screws (M2x3) that secures the solid-state drive module shield to the palm-rest and keyboard assembly.

### Next steps

1. Install the [base cover](#).
2. Follow the procedure in [after working inside your computer](#).

## Removing the M.2 2230 solid-state drive (SSD-1)

### Prerequisites

1. Follow the procedure in [before working inside your computer](#).
2. Remove the [base cover](#).

 **NOTE:** Slot 1 supports both M.2 2280 and M.2 2230 solid-state drives.

### About this task

The figure indicates the location of the solid-state drive and provides a visual representation of the removal procedure of M.2 2280 SSD from slot 1.



2x  
M2x3

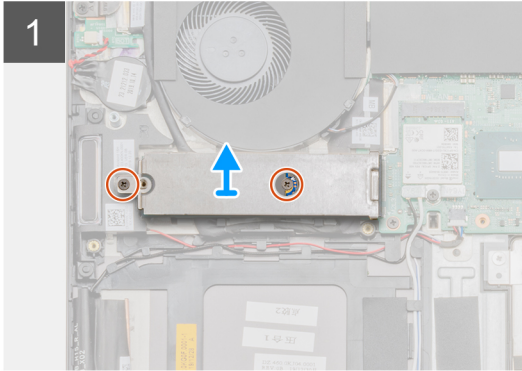
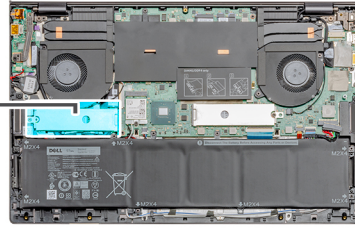

### Steps

1. Remove the two screw (M2x3) that secures the solid-state drive module shield and solid-state drive module to the palm-rest and keyboard assembly.
2. Lift and remove the solid-state drive module shield from the solid-state drive slot.
3. Slide and remove the solid-state drive module from the solid-state drive slot.

## Installing the M.2 2230 solid-state drive (SSD-1)

### Prerequisites

If you are replacing a component, remove the existing component before performing the installation procedure.

 **NOTE:** Slot 1 supports both M.2 2230 and M.2 2280 SSD.

### About this task

The figure indicates the location of the solid-state drive bracket and provides a visual representation of the bracket alignment procedure to accommodate the M.2 2280 solid-state drive from slot 1.





2x  
M2x3

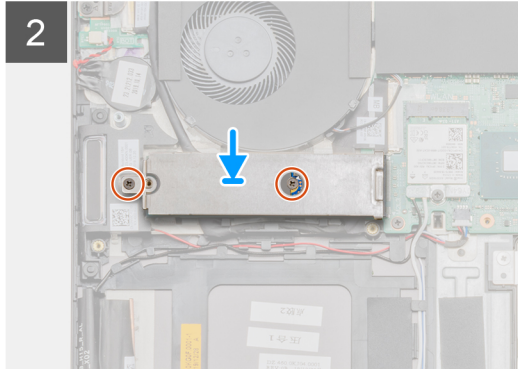
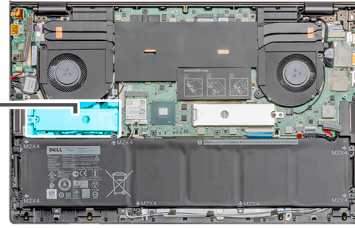

### Steps

1. Align the solid-state drive bracket to accommodate the M.2 2280 solid-state drive.
2. Replace the single (M2x3) screw to secure the solid-state drive to the palm-rest and keyboard assembly.
3. Place the solid-state drive module shield.
4. Replace the single (M2x3) screw to secure the solid-state drive module shield to the palm-rest and keyboard assembly.

### Next steps

1. Install the [base cover](#).
2. Follow the procedure in [after working inside your computer](#).

## Replacing the SSD-1 support bracket

### Prerequisites

1. Follow the procedure in [before working inside your computer](#).
2. Remove the [base cover](#).
3. Remove the [M.2 2280 SSD](#) or [M.2 2230 SSD](#).

### About this task

The figure provides a visual representation of the replace procedure.

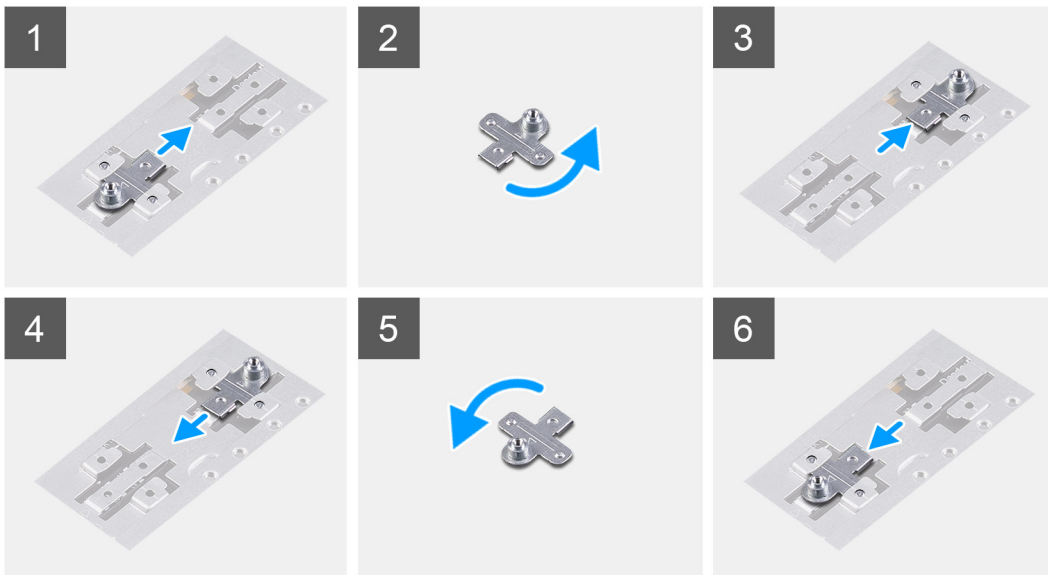

### Steps

1. Slide and remove the SSD support bracket from the support bracket slot.
2. Depending on the type of solid-state drive (M.2 2230/M.2 2280), align and insert the SSD support bracket into the support bracket slot.
3. Install the [SSD-1 \(M.2 2280\)](#) or [SSD-1 \(M.2 2230\)](#).

## Removing the M.2 2280 solid-state drive (SSD-2)

### Prerequisites

1. Follow the procedure in [before working inside your computer](#).
2. Remove the [base cover](#).

### About this task

The figure indicates the location of the solid-state drive and provides a visual representation of the removal procedure of M.2 2280 SSD from slot 2.

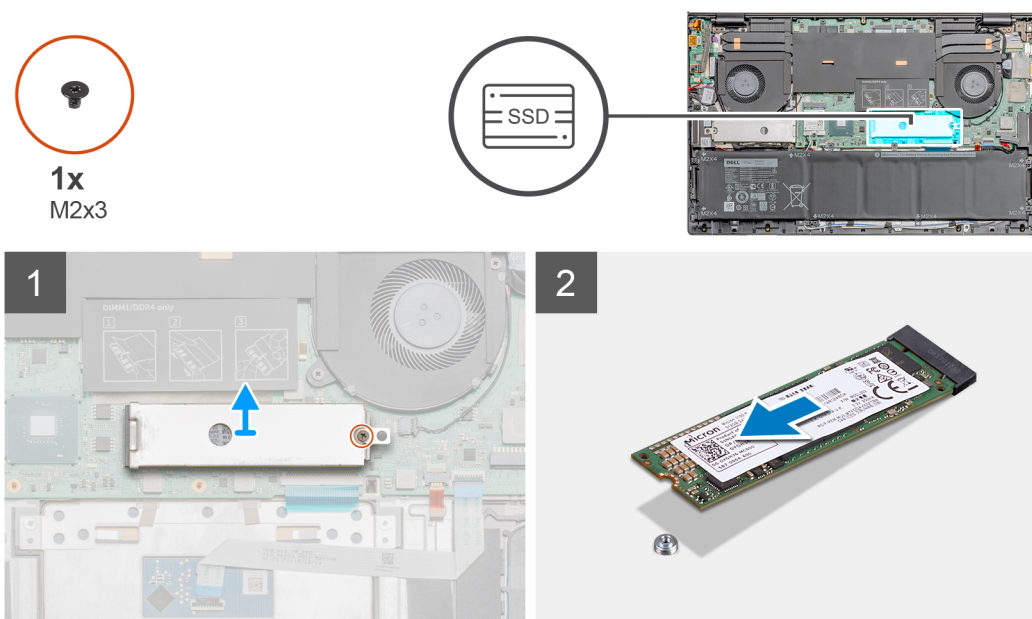

## Steps

1. Remove the single screw (M2x3) that secures the solid-state drive module shield to the palm-rest and keyboard assembly.
2. Lift and remove the solid-state drive module shield from the solid-state drive slot.
3. Slide and remove the solid-state drive module from the solid-state drive slot.

# Installing the M.2 2280 solid-state drive (SSD-2)

## Prerequisites

If you are replacing a component, remove the existing component before performing the installation procedure.

 **NOTE:** Slot 2 supports both M.2 2230 and M.2 2280 SSD.

## About this task

The figure indicates the location of the solid-state drive bracket and provides a visual representation of the bracket alignment procedure to accommodate the M.2 2280 solid-state drive from slot 2.

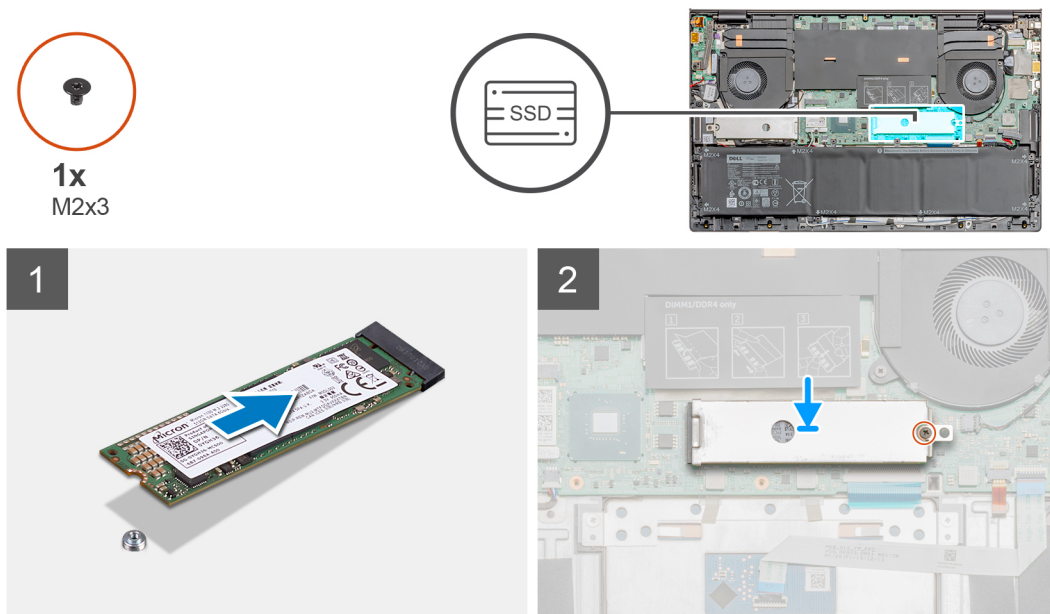

## Steps

1. Align the solid-state drive bracket to accommodate the M.2 2280 solid-state drive.
2. Place the solid-state drive module shield.
3. Replace the single (M2x3) screw to secure the solid-state drive module to the palm-rest and keyboard assembly.

## Next steps

1. Install the [base cover](#).
2. Follow the procedure in [after working inside your computer](#).

# Speakers

## Removing the speakers

### Prerequisites

1. Follow the procedure in [before working inside your computer](#).
2. Remove the [base cover](#).
3. Remove the [battery \(3 cell\)](#) or [battery \(6 cell\)](#).
4. Remove the [WLAN](#).

### About this task

The figure indicates the location of the speakers and provides a visual representation of the removal procedure.

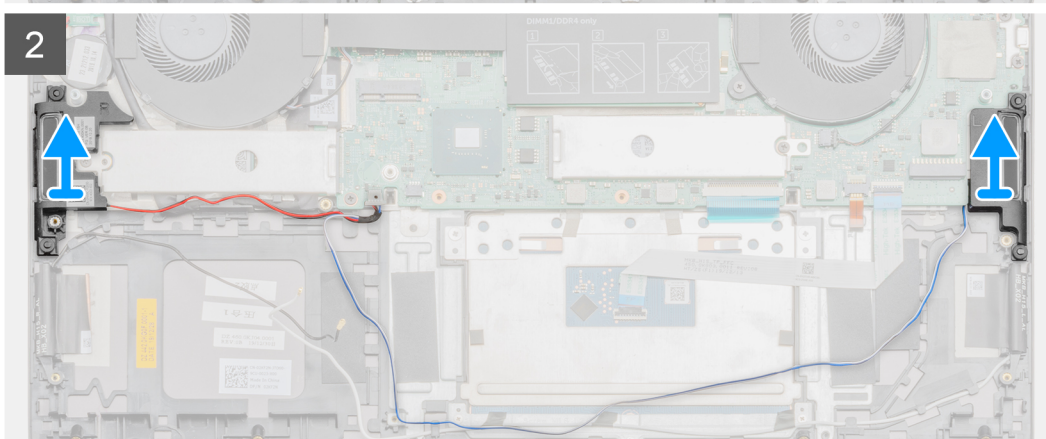
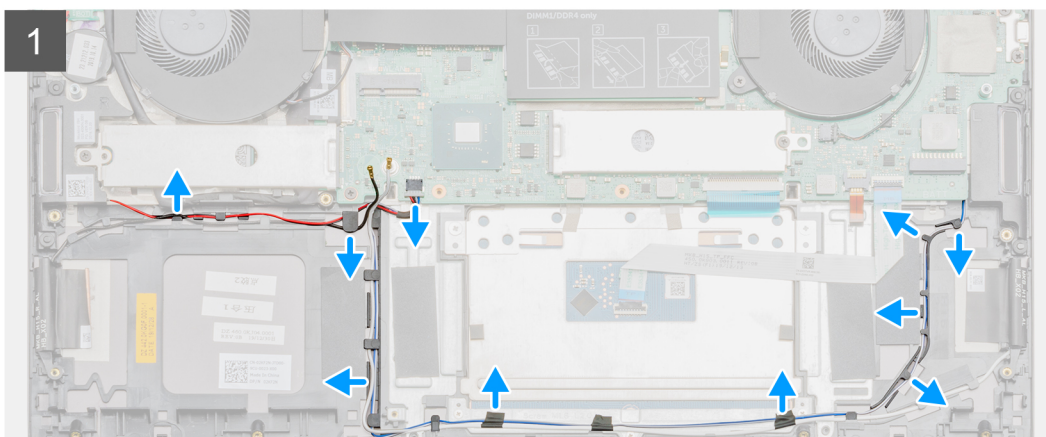
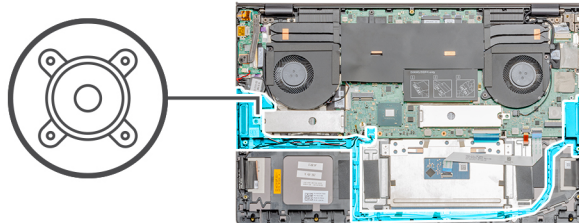

### Steps

1. Disconnect the speaker cable from the system board.
2. Note the routing of the speaker cable, and remove the speaker cable from the routing guides on the palm-rest and keyboard assembly.



**NOTE:** Note the position of the rubber grommets before lifting the speakers.

3. Lift the speakers, along with the cable, off the palm-rest and keyboard assembly.

## Installing the speakers

### Prerequisites

If you are replacing a component, remove the existing component before performing the installation procedure.

### About this task

The figure indicates the location of the speakers and provides a visual representation of the installation procedure.

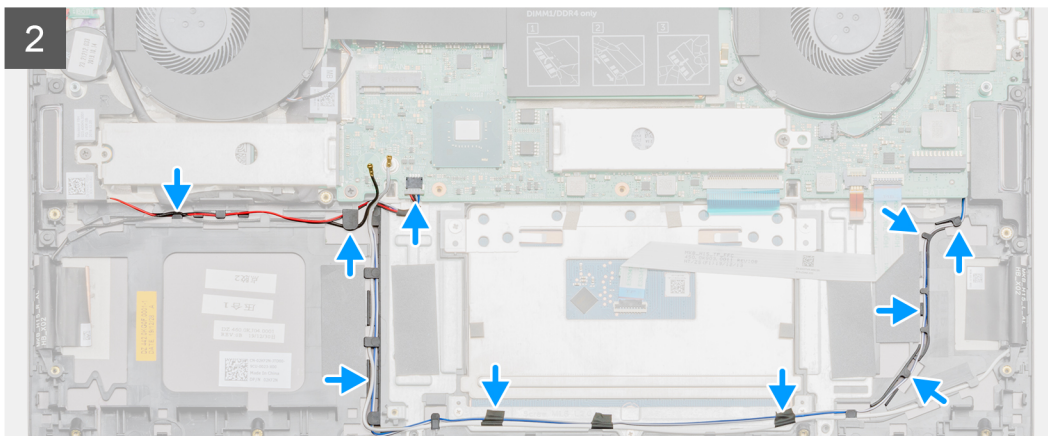
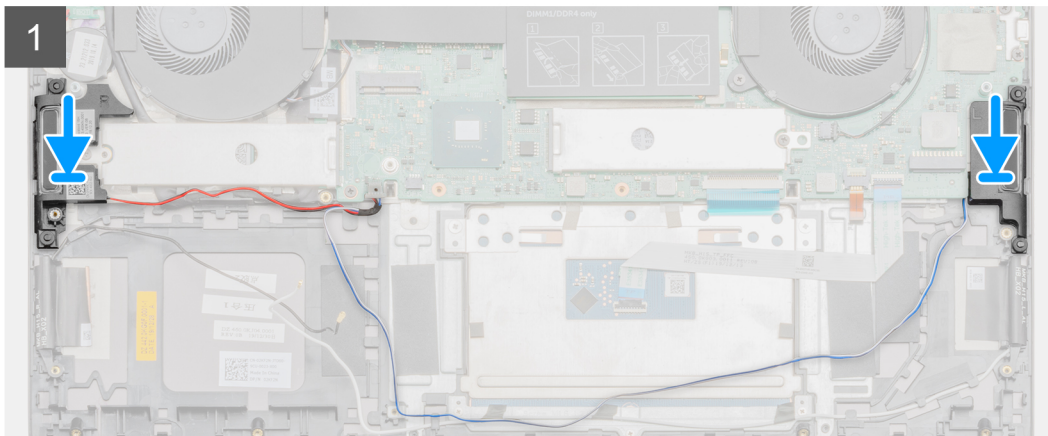
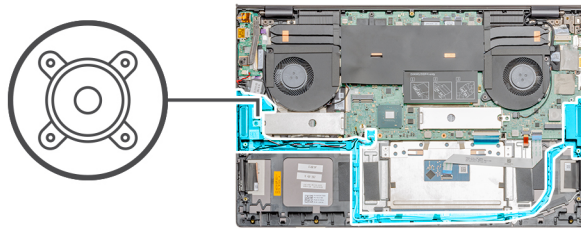

### Steps

1. Using the alignment posts and rubber grommets, place the speakers in the slots on the palm-rest and keyboard assembly.
2. Route the speaker cable through the routing guides on the palm-rest and keyboard assembly.
3. Connect the speaker cable to the system board.

### Next steps

1. Install the [WLAN](#).
2. Install the [battery \(3 cell\)](#) or [battery \(6 cell\)](#).
3. Install the [base cover](#).
4. Follow the procedure in [after working inside your computer](#).

## GPU fan

### Removing the GPU fan

#### Prerequisites

1. Follow the procedure in [before working inside your computer](#).
2. Remove the [base cover](#).

#### About this task

The figure indicates the location of the GPU fan and provides a visual representation of the removal procedure.



2x  
M2x4

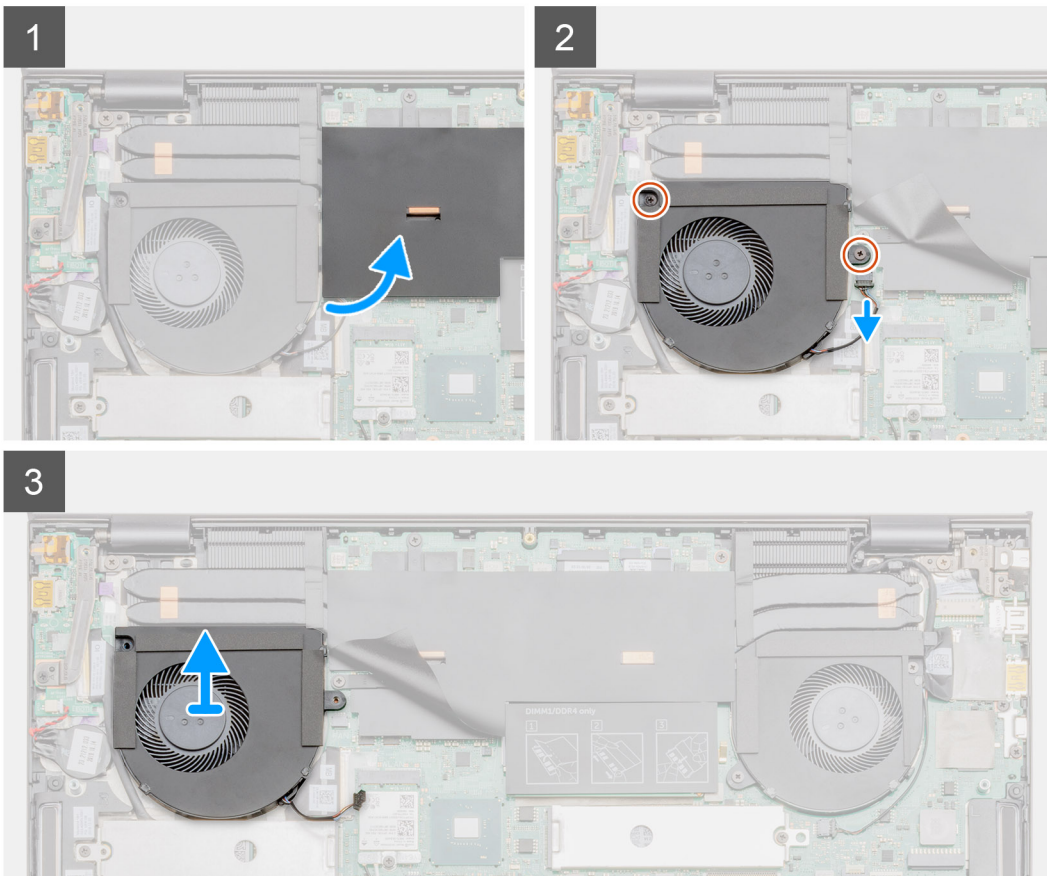
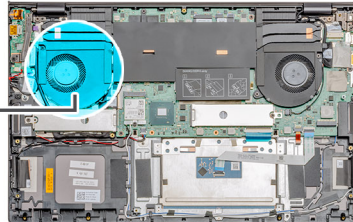
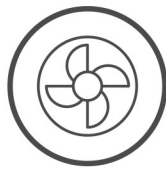

## Steps

1. Flip the mylar cover open.
2. Remove the two (M2x4) screws that secure the GPU fan to the palm-rest and keyboard assembly.
3. Disconnect the GPU fan cable from the system board.
4. Slide and lift the GPU fan off the palm-rest and keyboard assembly.

# Installing the GPU fan

## Prerequisites

If you are replacing a component, remove the existing component before performing the installation procedure.

## About this task

The figure indicates the location of the GPU fan and provides a visual representation of the installation procedure.



2x  
M2x4

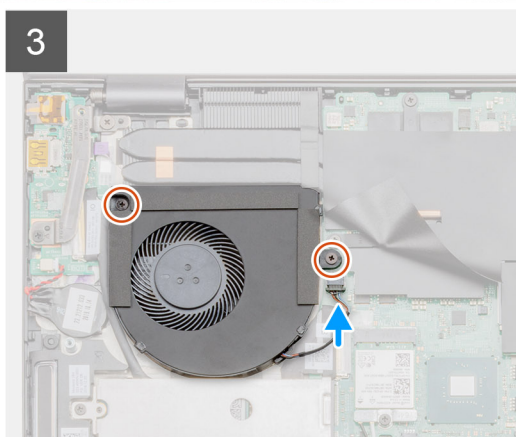
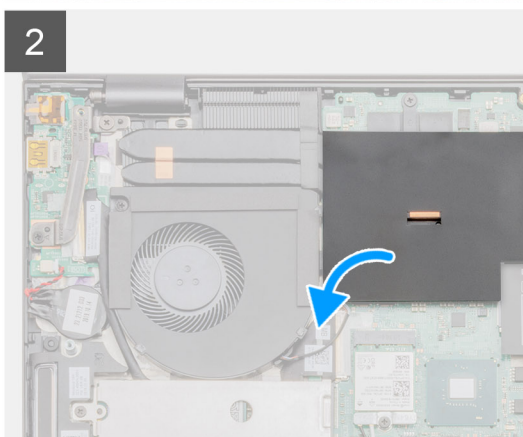
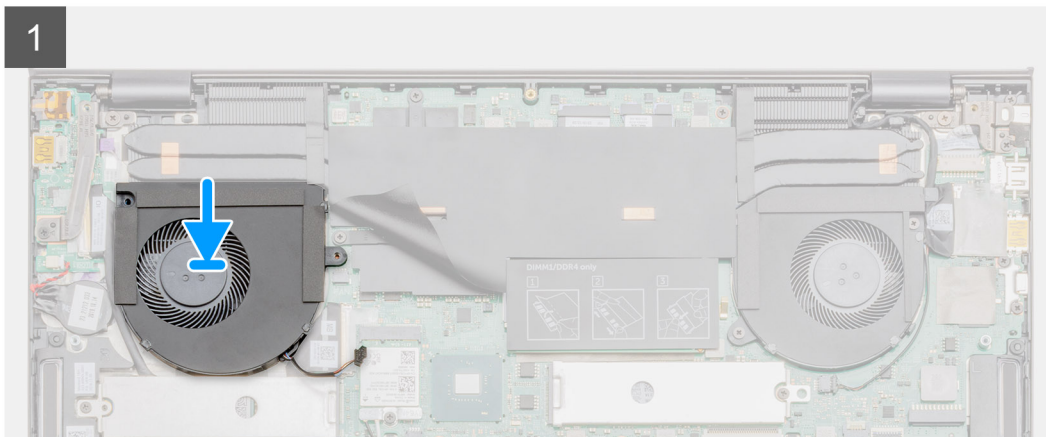
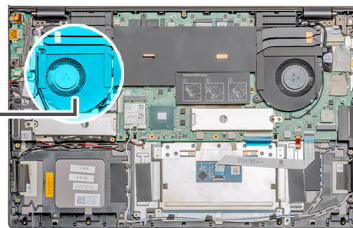

## Steps

1. Slide and place the GPU fan on the palm-rest and keyboard assembly.
2. Align the screw holes on the GPU fan with the screw holes on the palm-rest and keyboard assembly.
3. Replace the two (M2x4) screws to secure the GPU fan to the palm-rest and keyboard assembly.



4. Connect the GPU fan cable to the system board.

#### Next steps

1. Install the [base cover](#).
2. Follow the procedure in [after working inside your computer](#).

## System fan

### Removing the system fan

#### Prerequisites

1. Follow the procedure in [before working inside your computer](#).
2. Remove the [base cover](#).

#### About this task

The figure indicates the location of the system fan and provides a visual representation of the removal procedure.

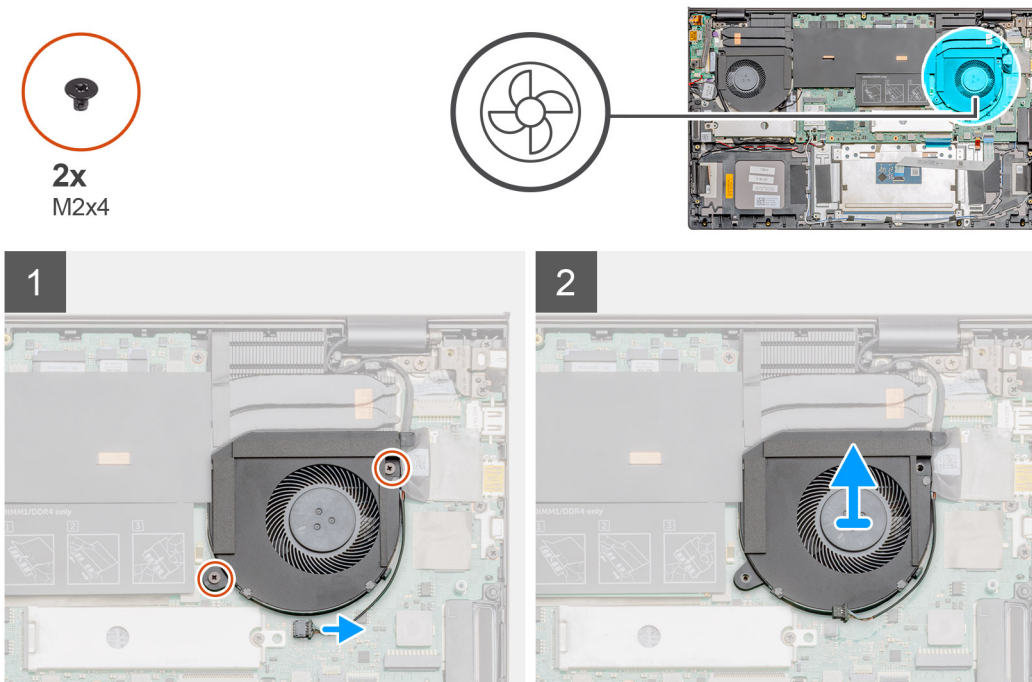

#### Steps

1. Remove the two (M2x4) screws that secure the system fan to the palm-rest and keyboard assembly.
2. Disconnect the system fan cable from the system board.
3. Slide and lift the system fan off the palm-rest and keyboard assembly.

### Installing the system fan

#### Prerequisites

If you are replacing a component, remove the existing component before performing the installation procedure.



### About this task

The figure indicates the location of the system fan and provides a visual representation of the installation procedure.

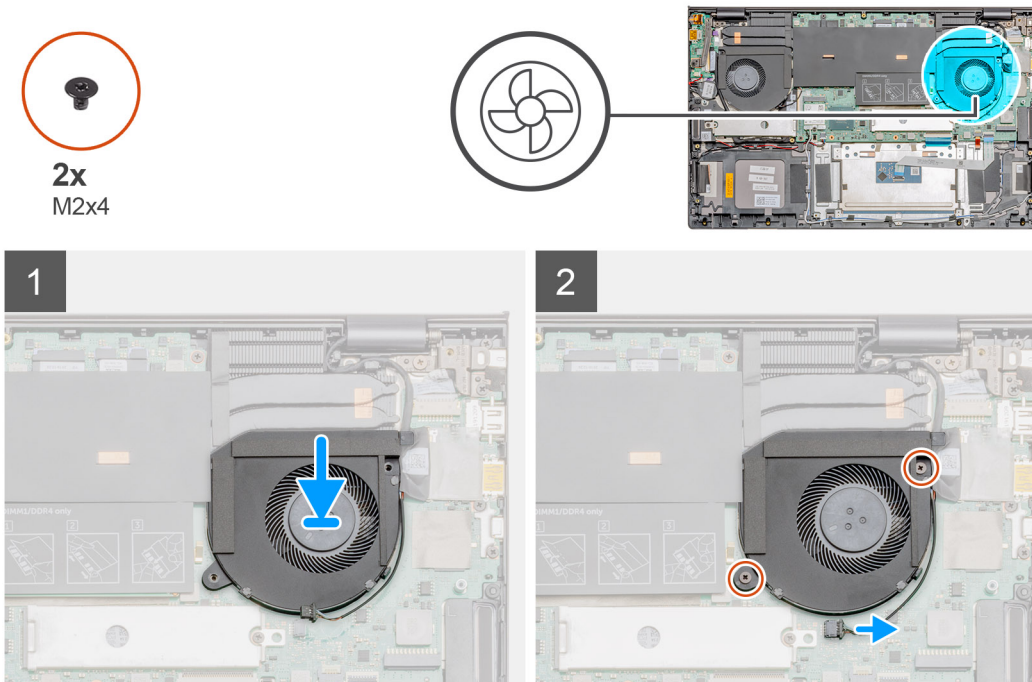

### Steps

1. Slide and place the system fan on the palm-rest and keyboard assembly.
2. Align the screw holes on the system fan with the screw holes on the palm-rest and keyboard assembly.
3. Replace the two (M2x4) screws to secure the system fan to the palm-rest and keyboard assembly.
4. Connect the system fan cable to the system board.

### Next steps

1. Install the [base cover](#).
2. Follow the procedure in [after working inside your computer](#).

## Heat sink

### Removing the heat sink (UMA)

#### Prerequisites

**NOTE:** The heat sink type in your computer varies depending on the configuration ordered.

1. Follow the procedure in [before working inside your computer](#).
2. Remove the [base cover](#).

### About this task

The figure indicates the location of the heat sink and provides a visual representation of the removal procedure.

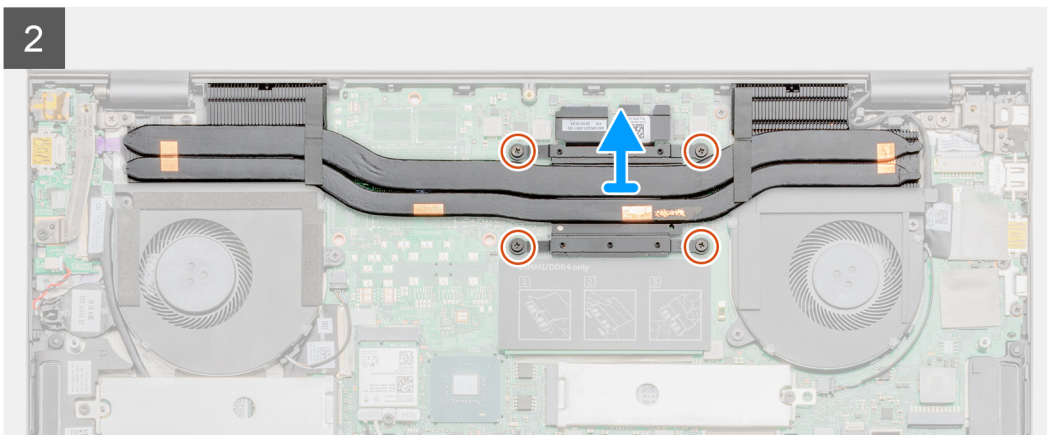
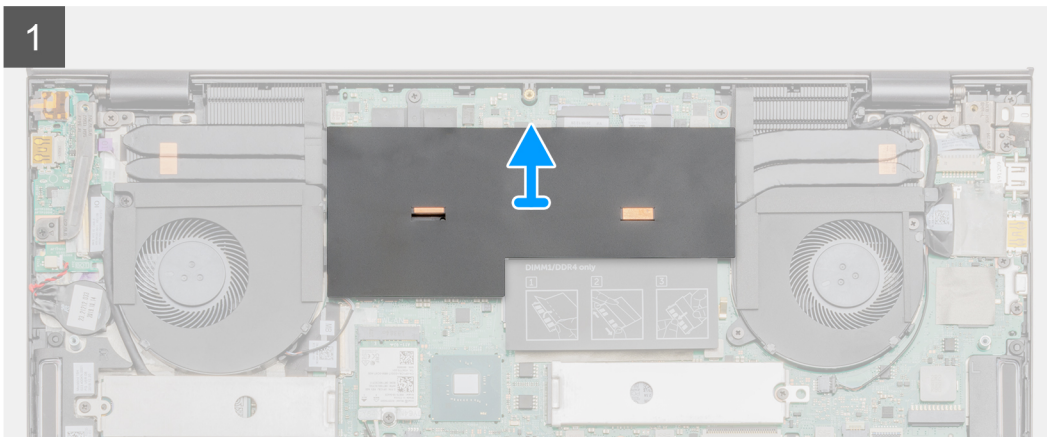
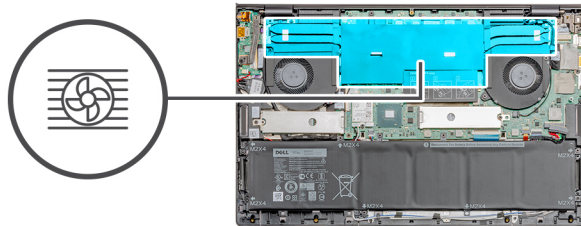

## Steps

1. Flip the mylar cover open.
2. In sequential order (as indicated on the heat sink), loosen the four captive screws that secure the heat sink to the system board.
3. Lift and remove the heat sink off the palm-rest and keyboard assembly.

## Installing the heat sink (UMA)

### Prerequisites

If you are replacing a component, remove the existing component before performing the installation procedure.

### About this task

The figure indicates the location of the heat sink and provides a visual representation of the installation procedure.

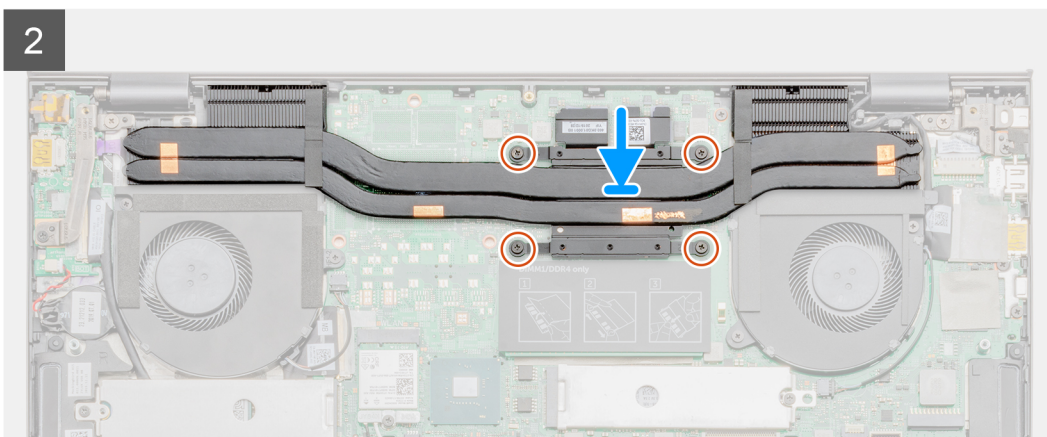
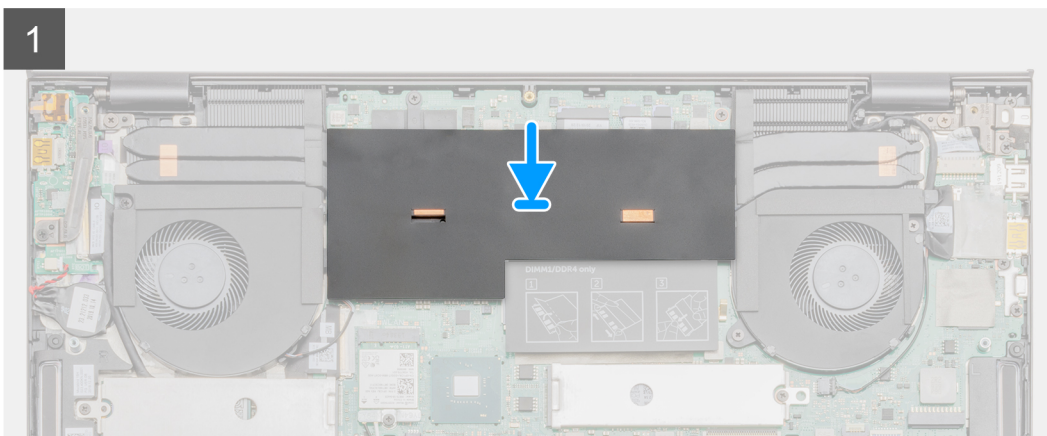
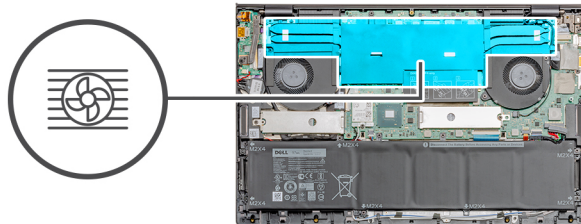

### Steps

1. Place the heat sink on the system board and align the screw holes on the heat sink with the screw holes on the system board.
2. In sequential order (as indicated on the heat sink), tighten the four captive screws that secure the heat sink to the system board.
3. Replace the mylar cover back.

### Next steps

1. Install the [base cover](#).
2. Follow the procedure in [after working inside your computer](#).

## Removing the heat sink (discrete)

### Prerequisites

**i** **NOTE:** The heat sink type in your computer varies depending on the configuration ordered.

1. Follow the procedure in [before working inside your computer](#).
2. Remove the [base cover](#).



**About this task**

The figure indicates the location of the heat sink and provides a visual representation of the removal procedure.

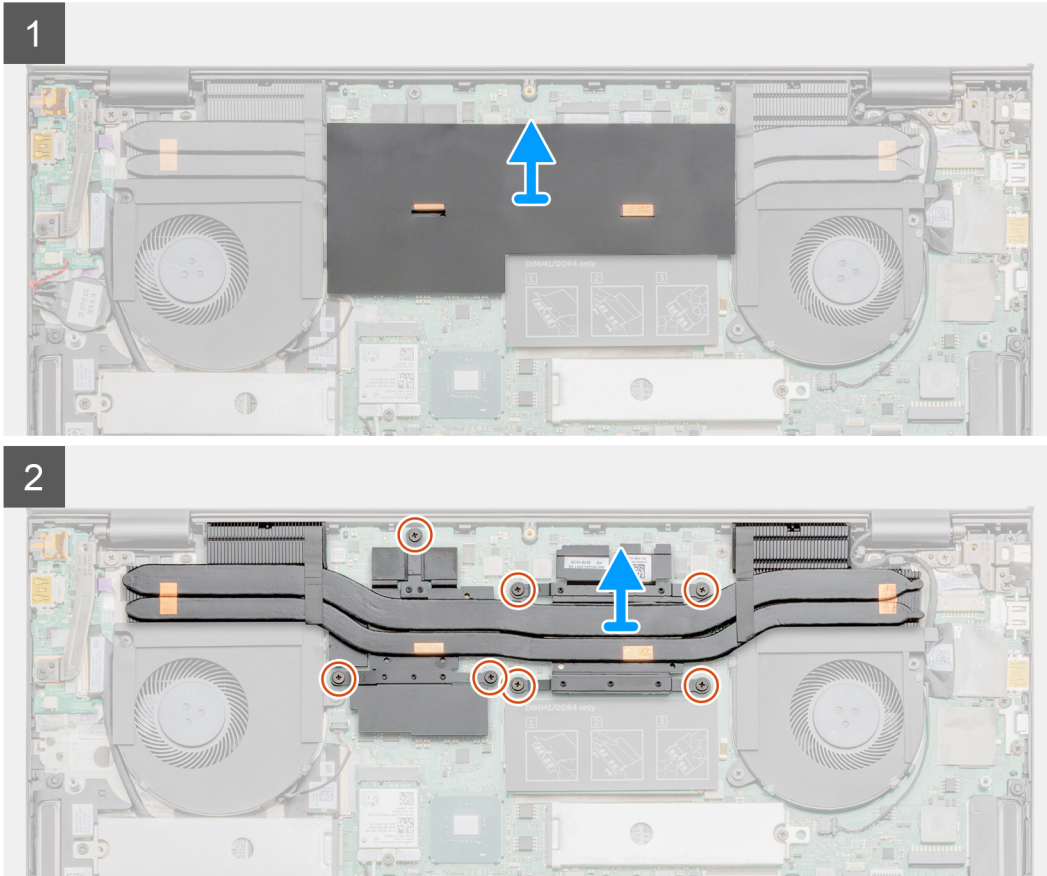
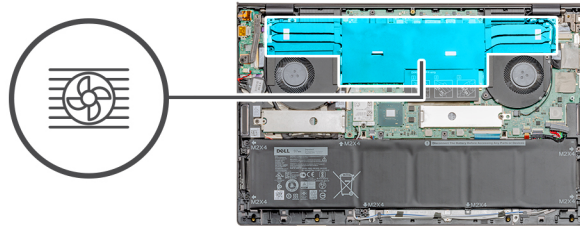

**Steps**

1. Flip the mylar cover open.
2. In sequential order (as indicated on the heat sink), loosen the seven captive screws that secure the heat sink to the system board.
3. Lift and remove the heat sink off the system board.

## Installing the heat sink (discrete)

**Prerequisites**

If you are replacing a component, remove the existing component before performing the installation procedure.

**About this task**

The figure indicates the location of the heat sink and provides a visual representation of the installation procedure.

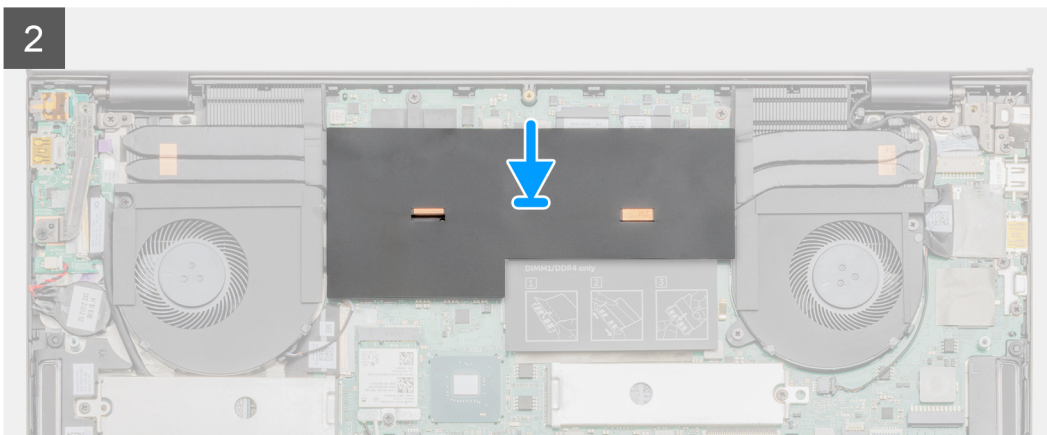
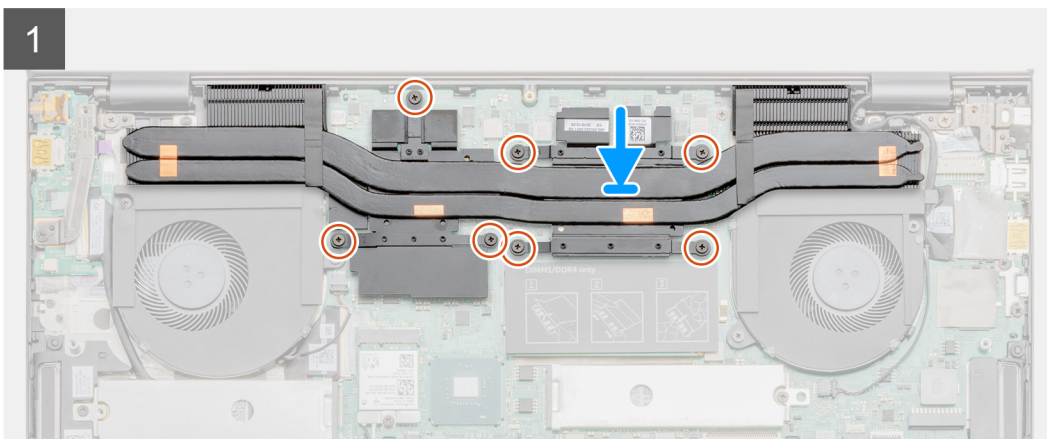
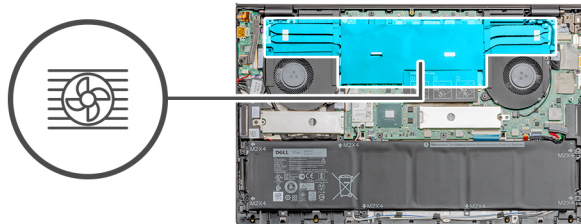

### Steps

1. Place the heat sink on the system board and align the screw holes on the heat sink with the screw holes on the system board.
2. Tighten the seven captive screws that secure the heat sink to the system board in sequential order (as indicated on the heat sink).
3. Replace the mylar cover back.

### Next steps

1. Install the [base cover](#).
2. Follow the procedure in [after working inside your computer](#).

## Coin-cell battery

### Removing the coin-cell battery

#### Prerequisites

1. Follow the procedure in [before working inside your computer](#).
2. Remove the [base cover](#).

**NOTE:** Removing the coin-cell battery resets the BIOS setup program settings to default. It is recommended that you note the BIOS setup program settings before removing the coin-cell battery.

The system does not boot to the operating system if settings are not saved.

#### About this task

The figure indicates the location of the coin-cell battery and provides a visual representation of the removal procedure.

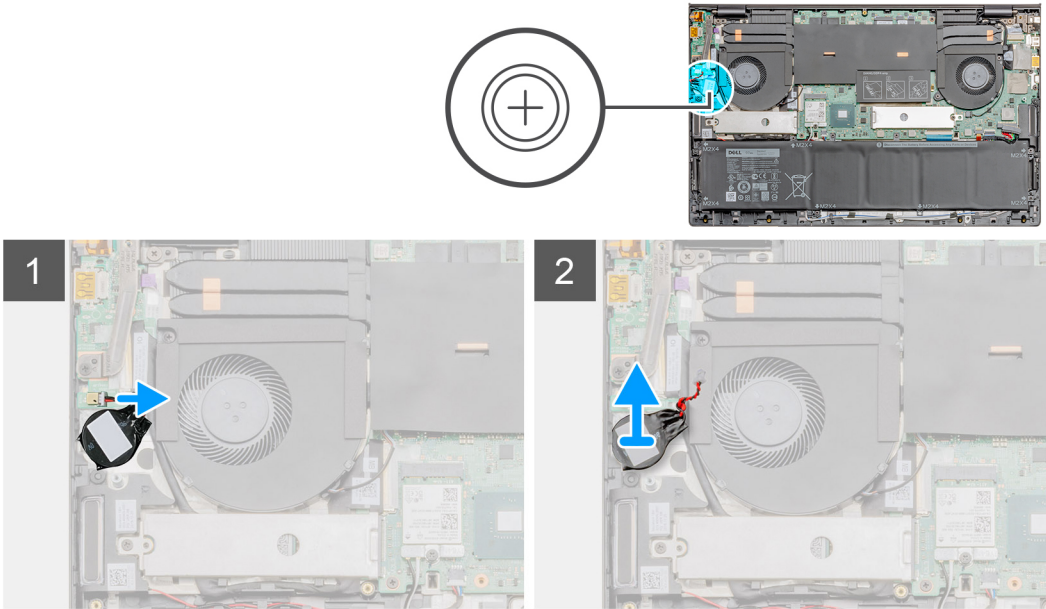

#### Steps

1. Disconnect the coin-cell battery cable from the I/O board.
2. Peel the coin-cell battery off the palm-rest and keyboard assembly.

## Installing the coin-cell battery

#### Prerequisites

If you are replacing a component, remove the existing component before performing the installation procedure.

#### About this task

The figure indicates the location of the coin-cell battery and provides a visual representation of the installation procedure.

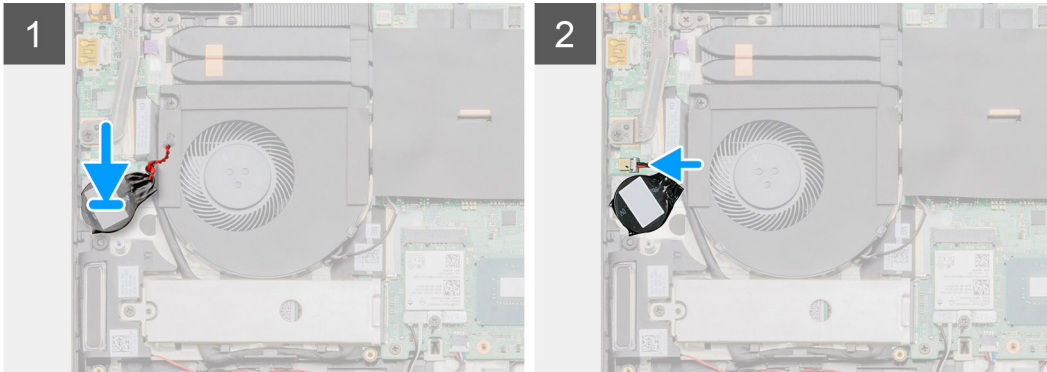
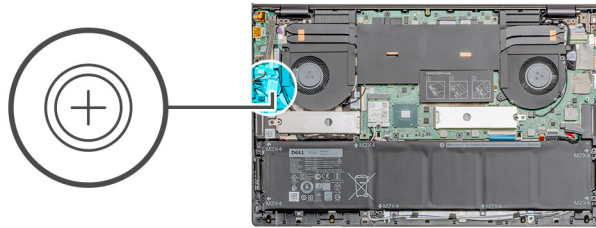

### Steps

1. Adhere the coin-cell battery to the slot on the palm-rest and keyboard assembly.
2. Route the coin-cell battery cable as illustrated and connect it to the I/O board.

### Next steps

1. Install the [base cover](#).
2. Follow the procedure in [after working inside your computer](#).

## I/O board

### Removing the I/O board

#### Prerequisites

1. Follow the procedure in [before working inside your computer](#).
2. Remove the [base cover](#).
3. Remove the [GPU fan](#).

#### About this task

 **NOTE:** Removing the I/O board disconnects the battery from the system board.

The figure indicates the location of the I/O board and provides a visual representation of the removal procedure.





1x  
M2.5x5



1x  
M2.5x4



1x  
M2x3

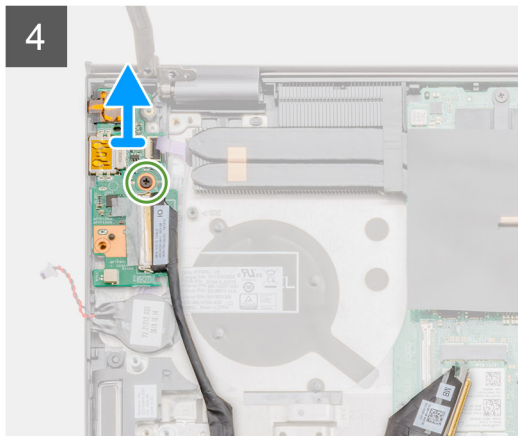
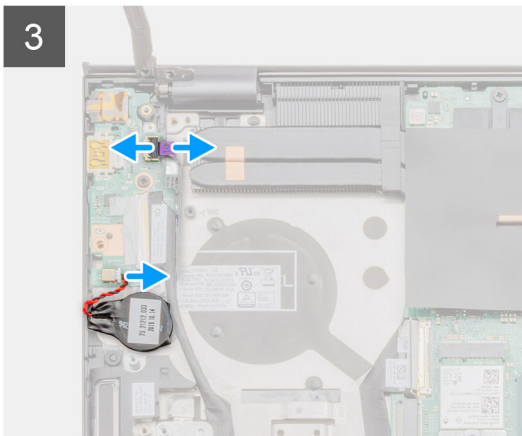
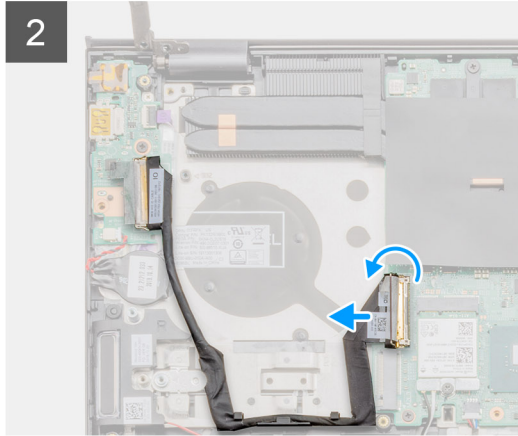
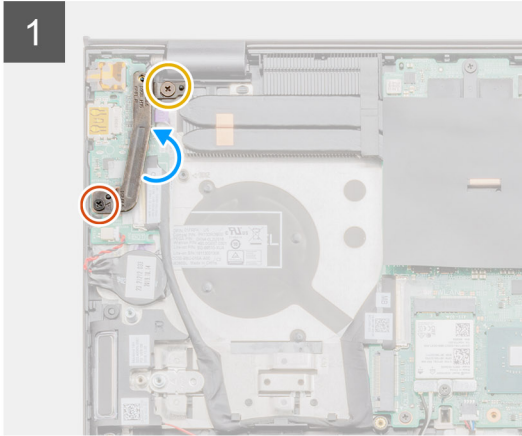
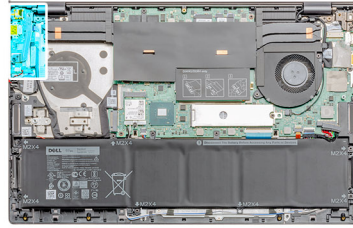

### Steps

1. Remove the two screws (M2.5x5) and (M2.5x4) that secures the left-display hinge to the computer.
2. Lift the left-display hinge up.
3. Open the latch, and disconnect the I/O-board cable from the I/O board.
4. Open the latch, and disconnect the fingerprint-reader board cable from the I/O board.
5. Disconnect the coin-cell battery cable from the I/O board.
6. Remove the single screw (M2x3) that secures the I/O board to the palm-rest and keyboard assembly.
7. Lift the I/O board off the palm-rest and keyboard assembly.

## Installing the I/O board

### Prerequisites

If you are replacing a component, remove the existing component before performing the installation procedure.

### About this task

The figure indicates the location of the I/O board and provides a visual representation of the installation procedure.



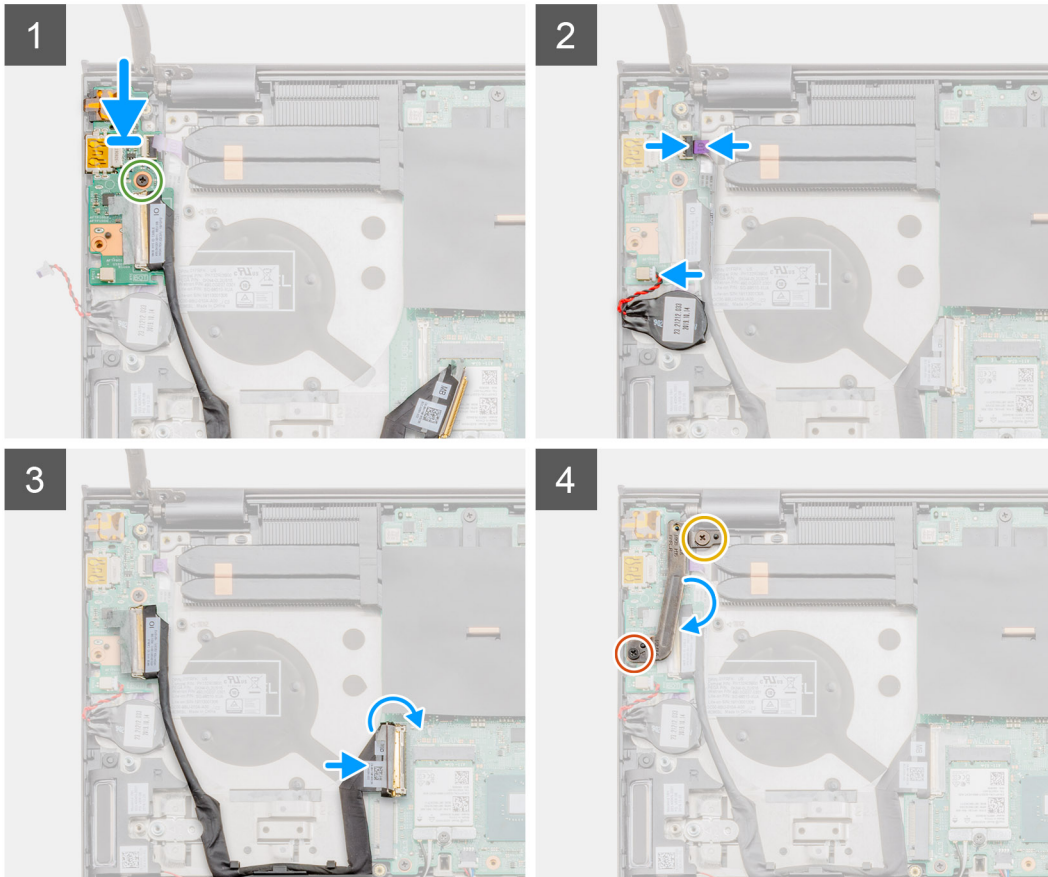
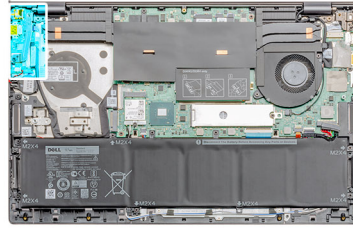
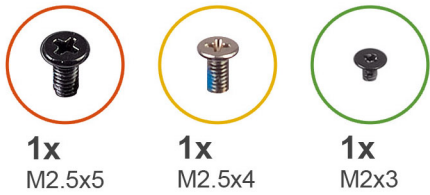

### Steps

1. Place the I/O board on the palm-rest and keyboard assembly.
2. Align the screw holes on the I/O board with the screw holes on the palm-rest and keyboard assembly.
3. Replace the single screw (M2x3) that secure the I/O board to the palm-rest and keyboard assembly.
4. Connect the fingerprint-reader board cable to the I/O board and close the latch to secure the cable.
5. Connect the coin-cell battery cable to the I/O board and adhere the coin-cell battery.
6. Connect the I/O-board cable to the I/O board and close the latch to secure the cable.
7. Lower the left-display hinge.
8. Replace the two screws (M2.5x5) and (M2.5x4) that secure the I/O board to the palm-rest and keyboard assembly.

### Next steps

1. Install the [GPU fan](#).
2. Install the [base cover](#).
3. Follow the procedure in [after working inside your computer](#).

# Power button with fingerprint reader (optional)

## Removing the power button and optional fingerprint reader

### Prerequisites

1. Follow the procedure in [before working inside your computer](#).
2. Remove the [base cover](#).
3. Remove the [GPU fan](#).
4. Remove the [I/O board](#).

### About this task

The figure indicates the location of the power button with optional fingerprint reader and provides a visual representation of the removal procedure.



2x  
M1.6x2

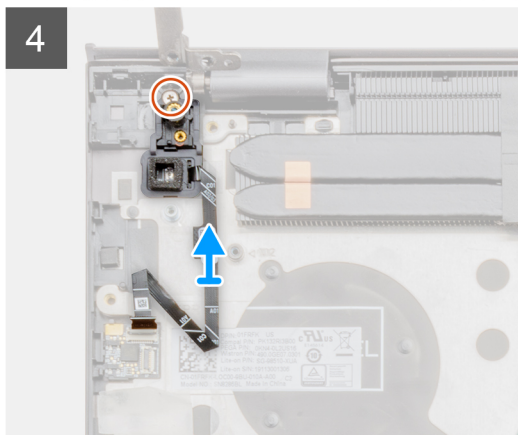
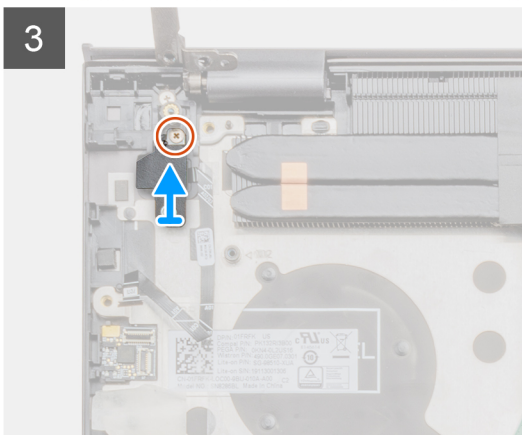
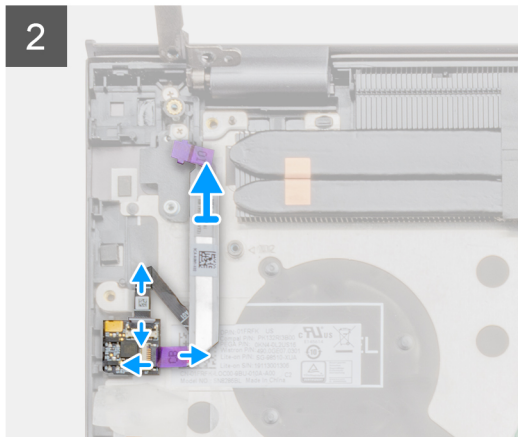
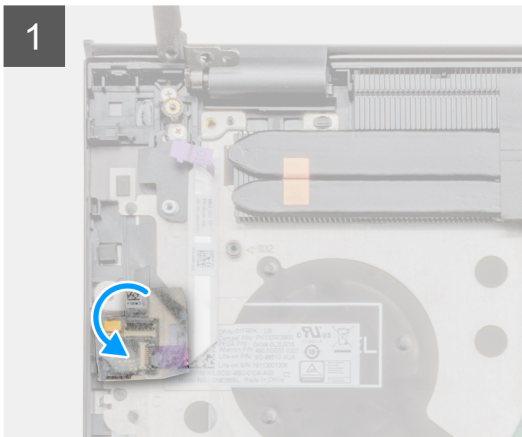
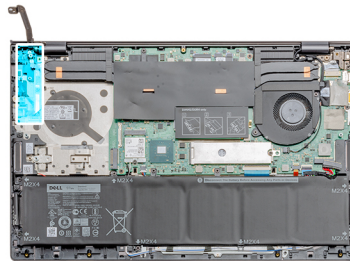

### Steps

1. Remove the transparent adhesive cover over the fingerprint reader.

2. Lift the latch, and disconnect the fingerprint-reader board cable, if installed, from the connector on the palm-rest assembly.

**i** | **NOTE: Remove the fingerprint-reader board cable and keep it aside as it is already disconnected from the other end.**

3. Unplug the power-button cable from the fingerprint-reader board on the palm-rest assembly.

4. Remove the single screw (M1.6x2.5), and lift the bracket.

5. Remove the single screw (M1.6x2.5) that secures the power button with optional fingerprint reader to the palm-rest assembly.

6. Lift the power button with optional fingerprint reader, along with the fingerprint reader cable, off the palm-rest and keyboard assembly.

## Installing the power button with optional fingerprint reader

### Prerequisites

If you are replacing a component, remove the existing component before performing the installation procedure.

### About this task

The figure indicates the location of the power button with fingerprint reader and provides a visual representation of the installation procedure.



**2x**  
M1.6x2

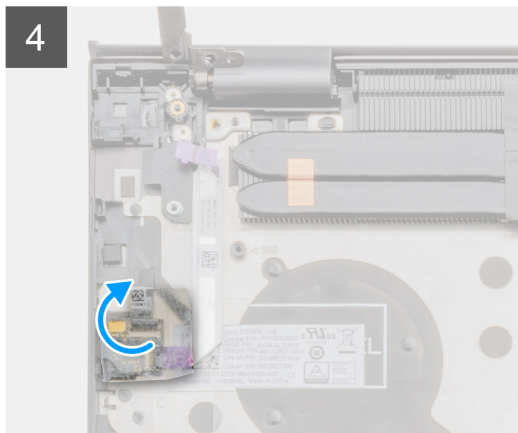
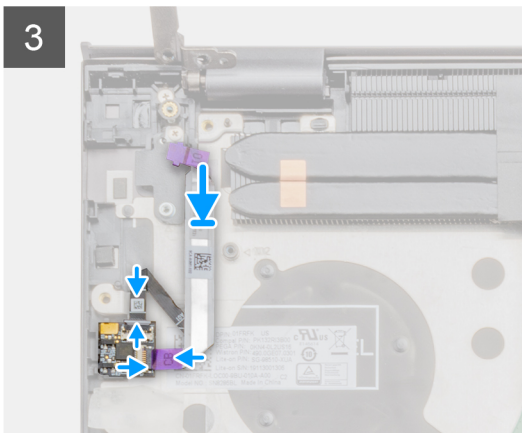
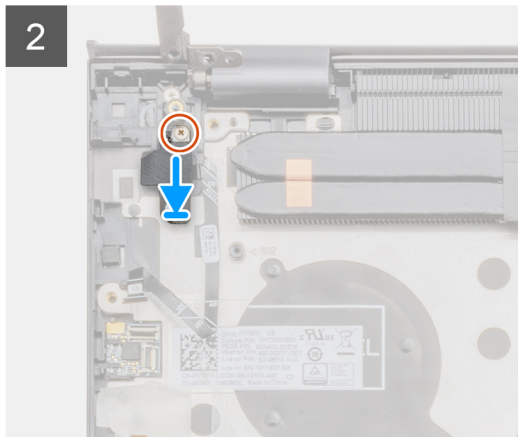
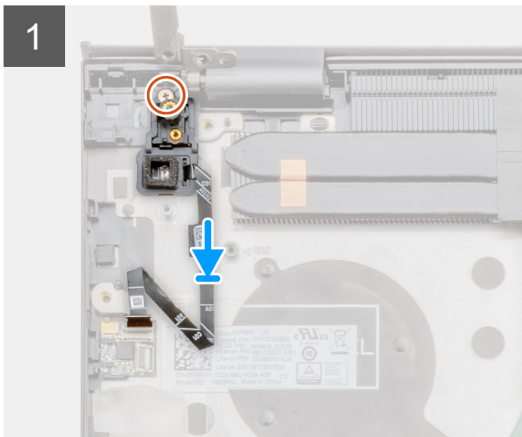
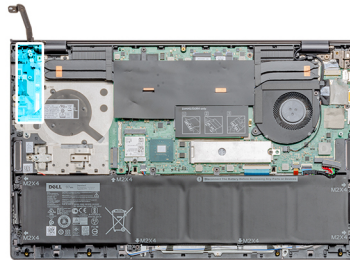

### Steps

1. Using the alignment post, place the power button with optional fingerprint reader on the palm-rest and keyboard assembly.
2. Replace the single screw (M1.6x2.5) to secure the power button with optional fingerprint reader to the palm-rest and keyboard assembly.
3. Replace the bracket and the single screw (M1.6x2.5).
4. Plug the fingerprint reader cable into the fingerprint connector on palm-rest and keyboard assembly.
5. Plug the fingerprint-reader board cable, if installed, into the fingerprint-reader board and close the latch.
6. Replace the transparent adhesive cover back.

### Next steps

1. Install the [I/O board](#).
2. Install the [GPU fan](#).
3. Install the [base cover](#).
4. Follow the procedure in [after working inside your computer](#).

## DC-in port

### Removing the DC-in port

#### Prerequisites

1. Follow the procedure in [before working inside your computer](#).
2. Remove the [base cover](#).

#### About this task

The figure indicates the location of the DC-in port and provides a visual representation of the removal procedure.



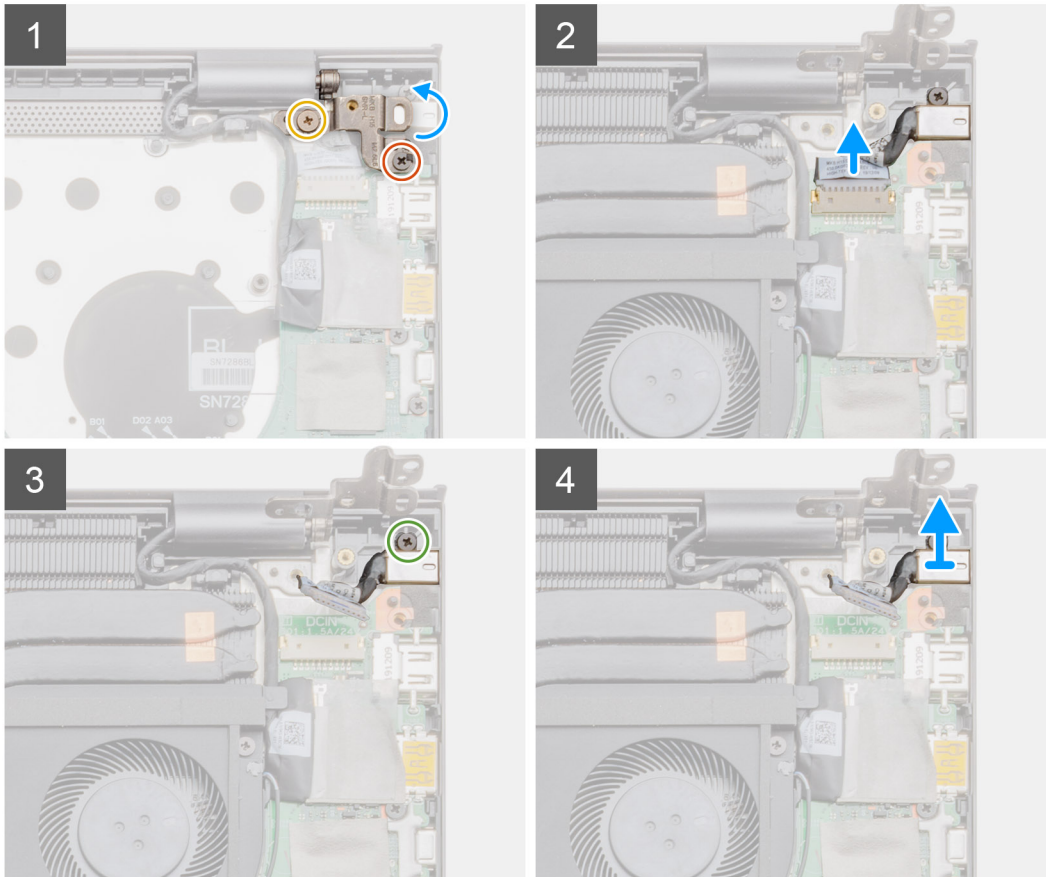
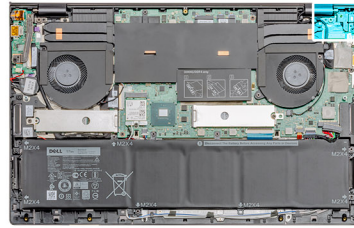
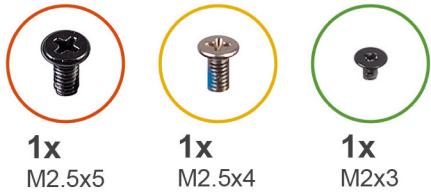

### Steps

1. Remove the two screws (M2.5x5) and (M2.5x4) that secure the left display hinge to the palm-rest and keyboard assembly.
2. Open the left display hinge at an angle of 90 degrees.
3. Disconnect the DC-in port cable from the system board.
4. Remove the single screw (M2x3) that secures the DC-in port to the palm-rest and keyboard assembly.
5. Lift the DC-in port, along with its cable, off the palm-rest and keyboard assembly.

## Installing the DC-in port

### Prerequisites

If you are replacing a component, remove the existing component before performing the installation procedure.

### About this task

The figure indicates the location of the DC-in port and provides a visual representation of the installation procedure.



2x  
M2.5x5



1x  
M2x3

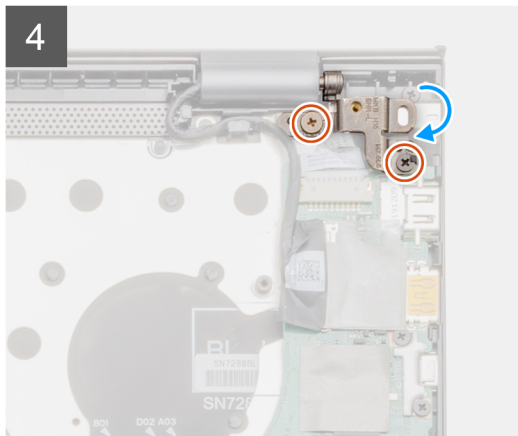
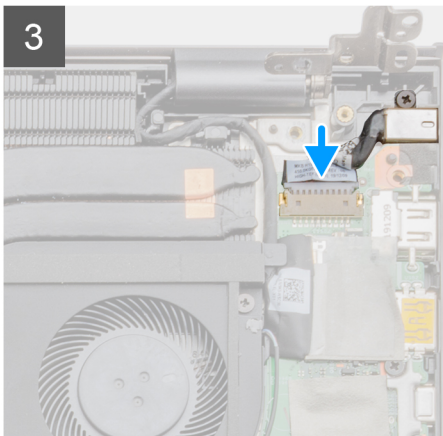
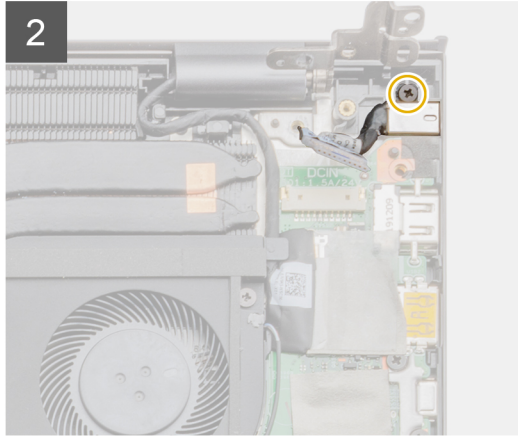
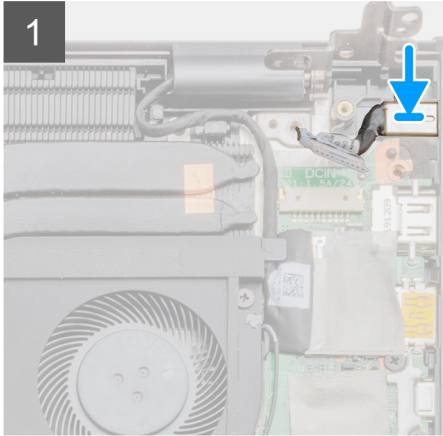
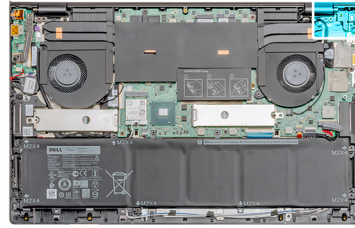

### Steps

1. Place the DC-in port on the palm-rest and keyboard assembly.
2. Replace the single screw (M2x3) that secures the DC-in port to the palm-rest and keyboard assembly.
3. Connect the DC-in port cable to the system board.
4. Using the alignment posts, close the left display hinge.
5. Replace the two screws (M2.5x5) and (M2.5x4) that secure the left display hinge to the system board.

### Next steps

1. Install the [base cover](#).
2. Follow the procedure in [after working inside your computer](#).

# Touchpad

## Removing the touchpad

### Prerequisites

1. Follow the procedure in [before working inside your computer](#).
2. Remove the [base cover](#).
3. Remove the [WLAN](#).

### About this task

The figure indicates the location of the touchpad and provides a visual representation of the removal procedure.

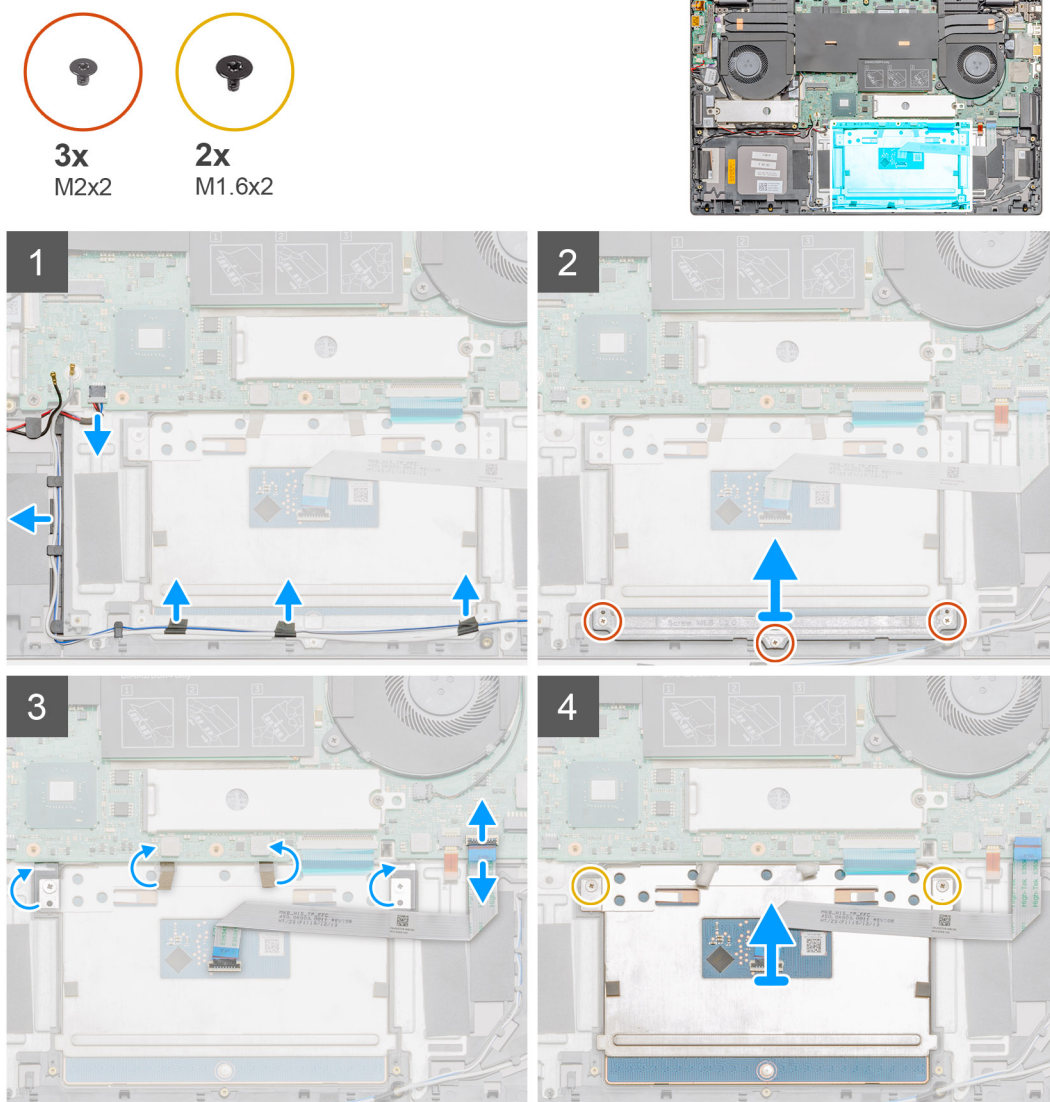

### Steps

1. Unplug the speaker cable from its connector on the system board.
2. Peel the adhesive tape, and unroute the speaker cable.
3. Remove the three (M2x2) screws that secure the touchpad bracket to the palm-rest and keyboard assembly.
4. Lift the touchpad bracket off the palm-rest and keyboard assembly.



5. Remove the adhesive tape from the touchpad.
6. Open the latch, and disconnect the touchpad cable from the system board.
7. Remove the two (M1.6x2) screws that secure the touchpad to the palm-rest and keyboard assembly.
8. Lift the touchpad, along with the cable, off the palm-rest and keyboard assembly.

## Installing the touchpad

### Prerequisites

If you are replacing a component, remove the existing component before performing the installation procedure.

### About this task

The figure indicates the location of the component and provides a visual representation of the installation procedure.

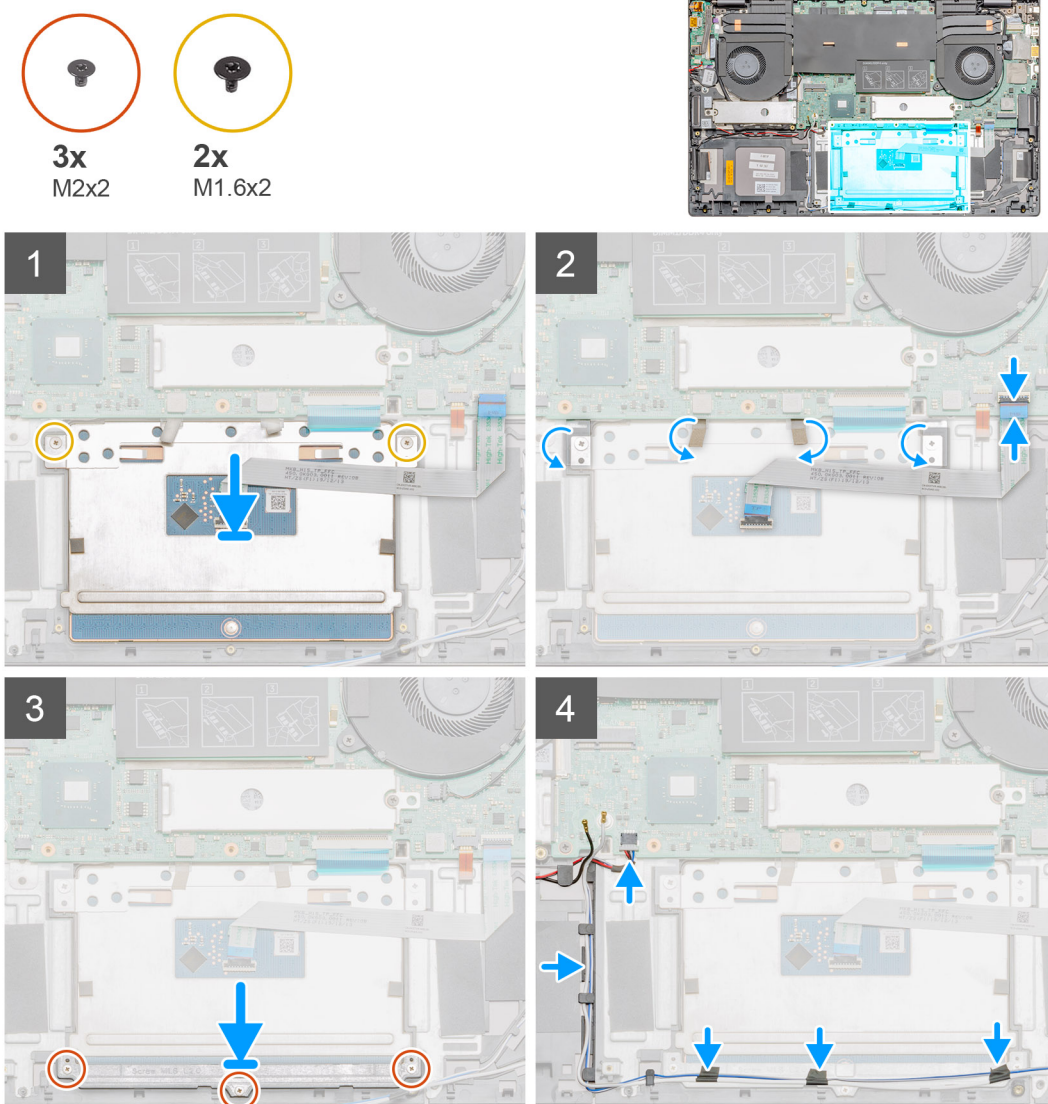

### Steps

1. Align and place the touchpad into the slot on the palm-rest and keyboard assembly.
2. Replace the two (M1.6x2) screws that secure the touchpad to the palm-rest and keyboard assembly.
3. Adhere the adhesive tape back to the touchpad.
4. Align and place the touchpad bracket into the slot on the palm-rest and keyboard assembly.

5. Replace the three (M2x2) screws that secure the touchpad bracket to the palm-rest and keyboard assembly.
6. Slide the touchpad cable onto its connector on the system board and close the latch to secure the cable.
7. Adhere the adhesive tape, and route the speaker cable on the palm-rest and keyboard assembly.
8. Route the speaker cable, and replace the adhesive tape.
9. Plug the speaker cable to its connector.

#### Next steps

1. Install the [WLAN](#).
2. Install the [battery \(3 cell\)](#) or [battery \(6 cell\)](#).
3. Install the [base cover](#).
4. Follow the procedure in [after working inside your computer](#).

## Display assembly

### Removing the display assembly

#### Prerequisites

1. Follow the procedure in [before working inside your computer](#).
2. Remove the [base cover](#).
3. Remove the [system fan](#).

#### About this task

The figure indicates the location of the display assembly and provides a visual representation of the removal procedure.



4x  
M2.5x5



1x  
M2.5x4

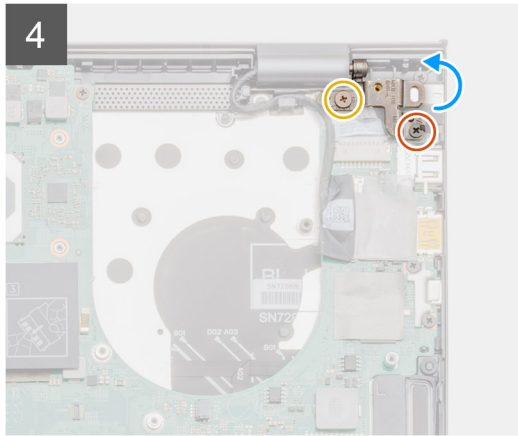
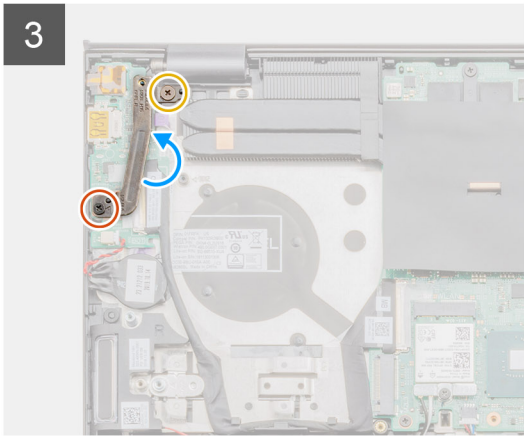
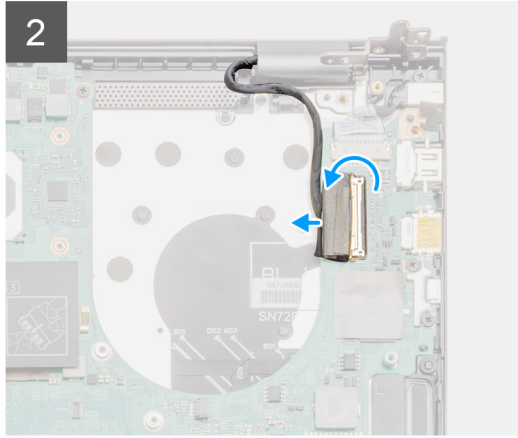
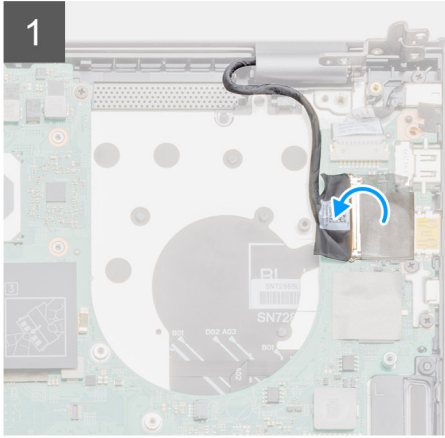
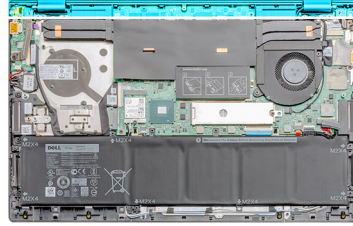

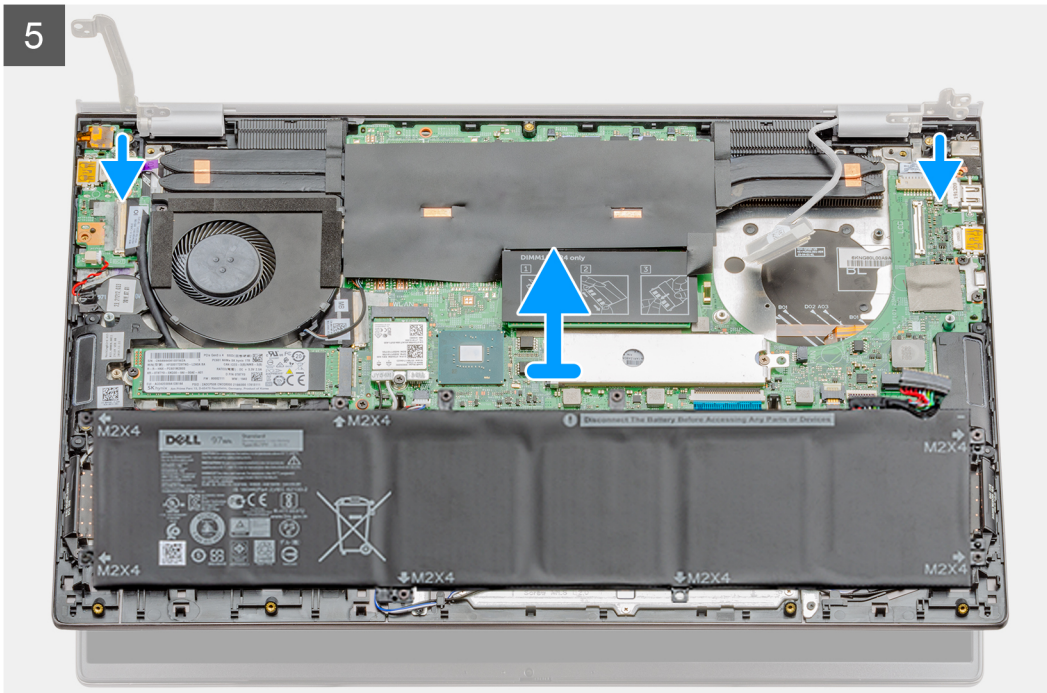

**Steps**

1. Locate the display cable and display hinges on your computer.
2. Peel the tape that secures the display cable to the system board.
3. Open the latch, and disconnect the display cable from the system board.
4. Remove the two screws (M2.5x5) and (M2.5x4) that secure the left-display hinge to the system board.
5. Remove the two screws (M2.5x5) and (M2.5x4) that secure the right-display hinge to the system board.
6. Open the display hinges at an angle of 90 degrees.
7. Gently slide and remove the palm-rest and keyboard assembly off the display assembly.



# Installing the display assembly

## Prerequisites

If you are replacing a component, remove the existing component before performing the installation procedure.

## About this task

The figure indicates the location of the component and provides a visual representation of the installation procedure.

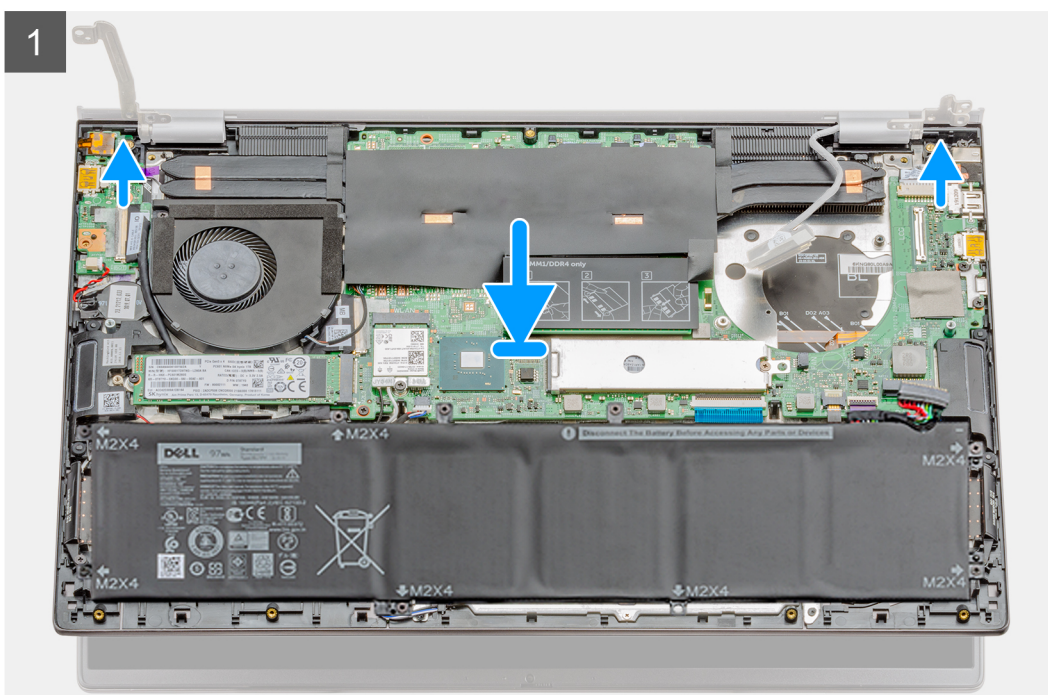
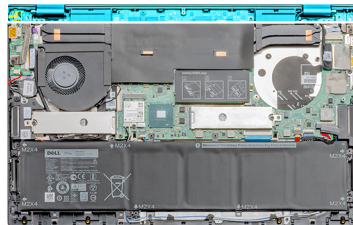





4x  
M2.5x5



1x  
M2.5x4

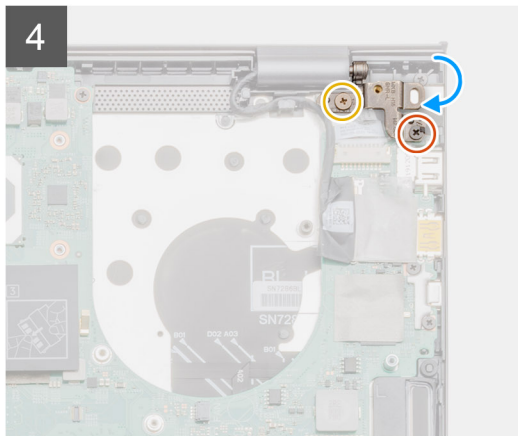
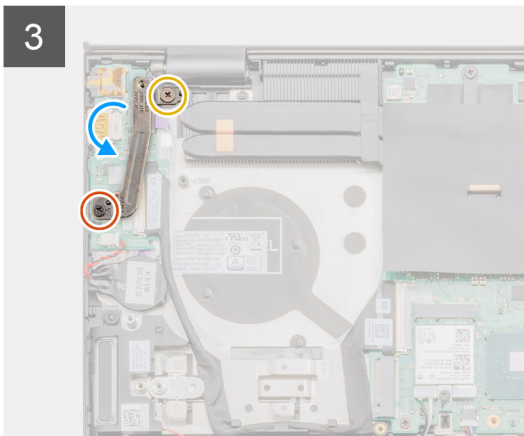
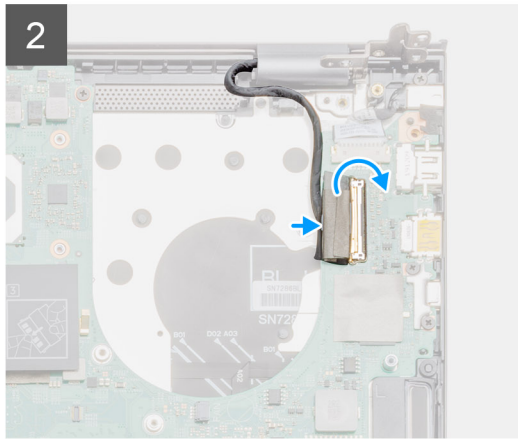
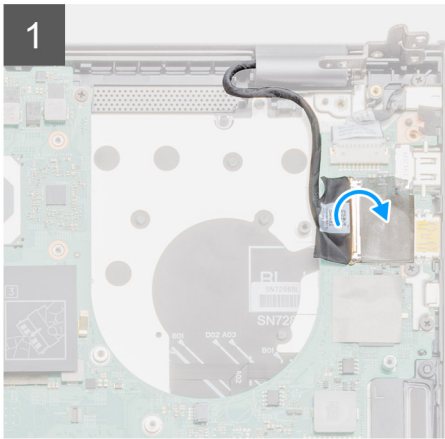

### Steps

1. Place the display assembly on a clean and flat surface.
2. Align and place the palm-rest and keyboard assembly on the display assembly.
3. Using the alignment posts, close the display hinges.
4. Replace the two screws (M2.5x5) and (M2.5x4) that secure the left-display hinge to the system board.
5. Replace the two screws (M2.5x5) and (M2.5x4) that secure the right-display hinge to the system board.
6. Connect the display cable on to the connector on the system board and adhere the tape to the system board.

### Next steps

1. Install the [system fan](#).
2. Install the [base cover](#).
3. Follow the procedure in [after working inside your computer](#).

# System board

## Removing the system board

### Prerequisites

1. Follow the procedure in [before working inside your computer](#).
2. Remove the [base cover](#).
3. Remove the [battery \(3 cell\)](#) or [battery \(6 cell\)](#).
4. Remove the [WLAN](#).
5. Remove the [memory module](#).
6. Remove the [SSD-1 \(M.2 2280\)](#) or [SSD-1 \(M.2 2230\)](#).
7. Remove the [SSD-2](#).
8. Remove the [GPU fan](#).
9. Remove the [system fan](#).
10. Remove the [I/O board](#).
11. Remove the heat sink - [discrete](#) or [UMA](#) based on the configuration selected.

### About this task

The figure indicates the location of the system board and provides a visual representation of the removal procedure.

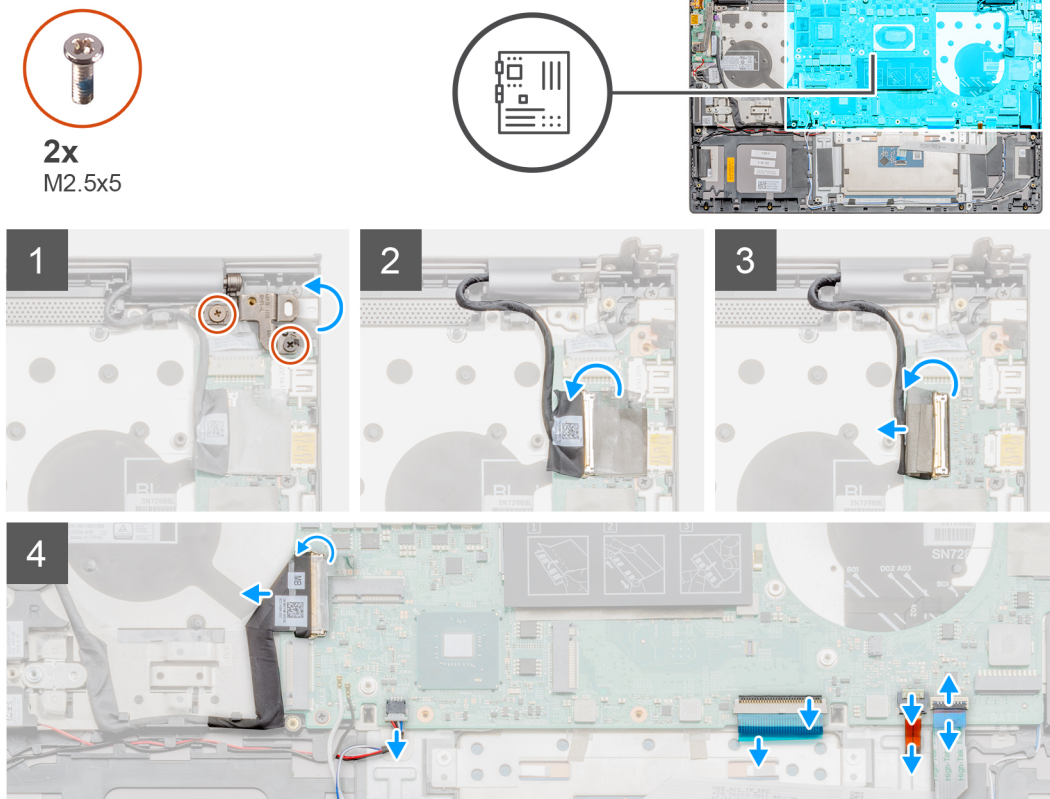



2x  
M2x3



2x  
M2x2

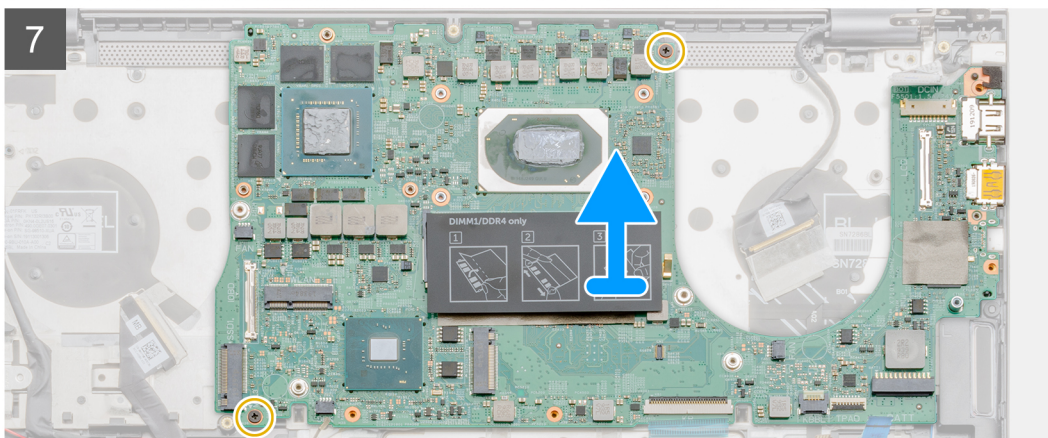
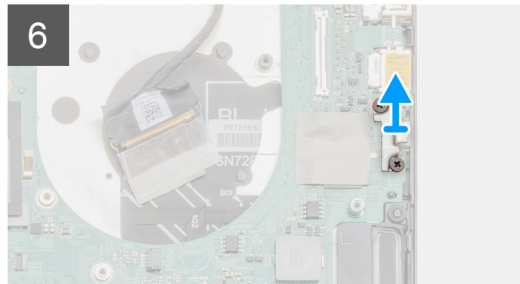
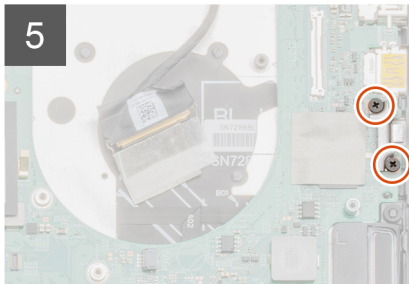

### Steps

1. Remove two screws (M2.5x5) and (M2.5x4), and lift the right display hinge.
2. Peel the tape that secures the display cable to the system board.
3. Open the latch, and disconnect the display cable from the system board.
4. Remove and lift the USB Type-C port off the system board.
5. Open the latch, and disconnect the I/O cable from the system board.
6. Disconnect the speaker cable from the system board.
7. Open the latch, and disconnect the touchpad cable from the system board.
8. Open the latch, and disconnect the keyboard-backlight cable from the system board.
9. Remove the two screws (M2x3) that secure the USB Type-C port bracket to the system board.
10. Lift the USB Type-C port bracket.
11. Remove the two screws (M2x3) that secure the system board to the palm-rest and keyboard assembly.
12. Gently release the ports on the system board from the slots on the palm-rest and keyboard assembly and lift the system board off the palm-rest and keyboard assembly.

## Installing the system board

### Prerequisites

If you are replacing a component, remove the existing component before performing the installation procedure.



**About this task**

The figure indicates the location of the system board and provides a visual representation of the installation procedure.

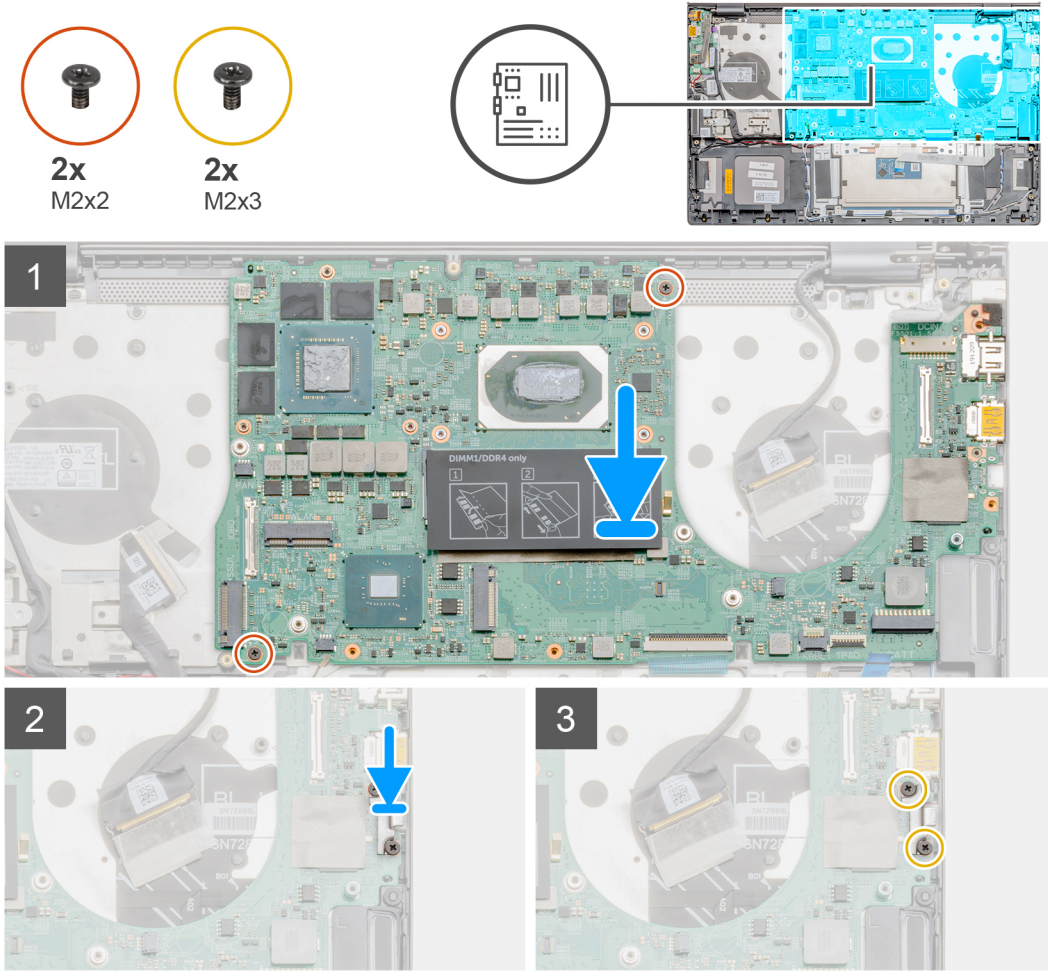



**2x**  
M2.5x5

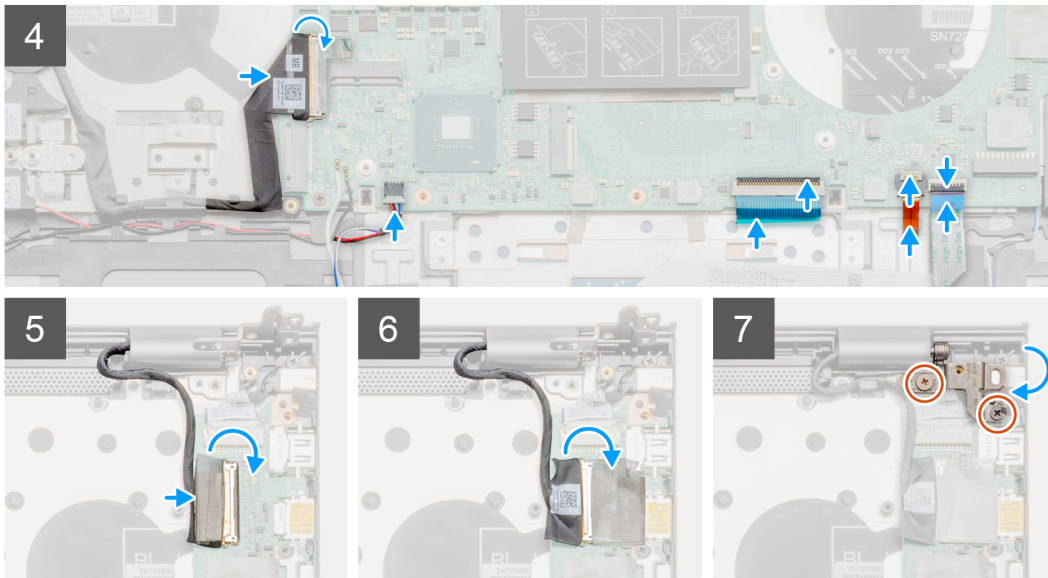

### Steps

1. Slide the ports on the system board into the slots on the palm-rest and keyboard assembly and align the screw holes on the system board with the screw holes on the palm-rest and keyboard assembly.
2. Replace the two screws (M2x3) that secure the system board to the palm-rest and keyboard assembly.
3. Align and place the USB Type-C port bracket.
4. Replace the two screws (M2x3) that secure the USB Type-C port bracket to the system board.
5. Connect the I/O-board cable to the system board and close the latch to secure the cable.
6. Connect the speaker cable to the system board.
7. Connect the touchpad cable to the system board and close the latch to secure the cable.
8. Connect the keyboard-backlight cable to the system board and close the latch to secure the cable.
9. Connect the display cable on to the connector on the system board.
10. Adhere the tape that secures the display cable to the system board.
11. Lower the right display hinge, and replace two screws (M2.5x5) and (M2.5x4).

### Next steps

1. Install the heat sink - [discrete](#) or [UMA](#) based on the configuration selected.
2. Install the [system fan](#).
3. Install the [GPU fan](#).
4. Install the [SSD-1 \(M.2 2280\)](#) or [SSD-1 \(M.2 2230\)](#).
5. Install the [SSD-2](#).
6. Install the [memory module](#).
7. Install the [WLAN](#).
8. Install the [battery \(3 cell\)](#) or [battery \(6 cell\)](#).
9. Install the [base cover](#).
10. Follow the procedure in [after working inside your computer](#).



# Palm-rest and keyboard assembly

## Removing the palm-rest and keyboard assembly

### Prerequisites

1. Follow the procedure in [before working inside your computer](#).
2. Remove the [base cover](#).
3. Remove the [battery \(3 cell\)](#) or [battery \(6 cell\)](#).
4. Remove the [WLAN](#).
5. Remove the [memory module](#).
6. Remove the [SSD-1 \(M.2 2280\)](#) or [SSD-1 \(M.2 2230\)](#).
7. Remove the [SSD-2](#).
8. Remove the [speakers](#).
9. Remove the [GPU fan](#).
10. Remove the [system fan](#).
11. Remove the [I/O board](#).
12. Remove the [heat sink \(discrete\)](#) or [heat sink \(UMA\)](#).
13. Remove the [coin-cell battery](#).
14. Remove the [power button with fingerprint reader](#).
15. Remove the [DC-in port](#).
16. Remove the [touchpad](#).
17. Remove the [display assembly](#).
18. Remove the [system board](#).

**i** **NOTE:** The system board can be removed along with the heat sink.

### About this task

The figure indicates the location of the palm-rest and keyboard assembly and provides a visual representation of the removal procedure.

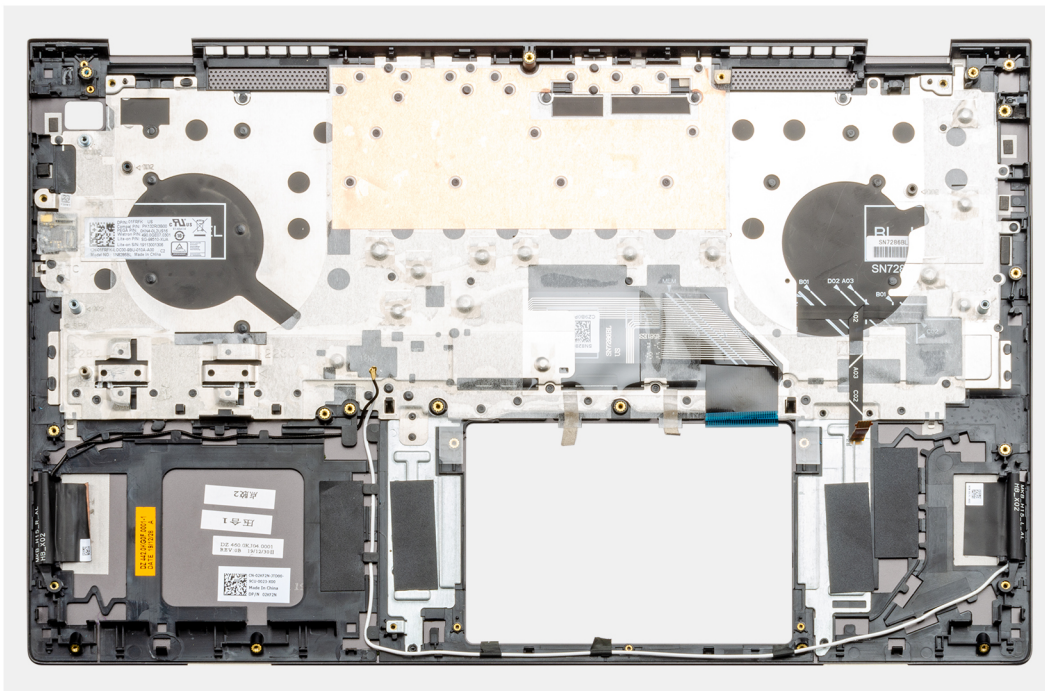

### Steps

After performing the steps in the pre-requisites, you are left with the palm-rest and keyboard assembly.

# Installing the palm-rest and keyboard assembly

## Prerequisites

If you are replacing a component, remove the existing component before performing the installation procedure.

## About this task

The figure indicates the location of the palm-rest and keyboard assembly and provides a visual representation of the installation procedure.

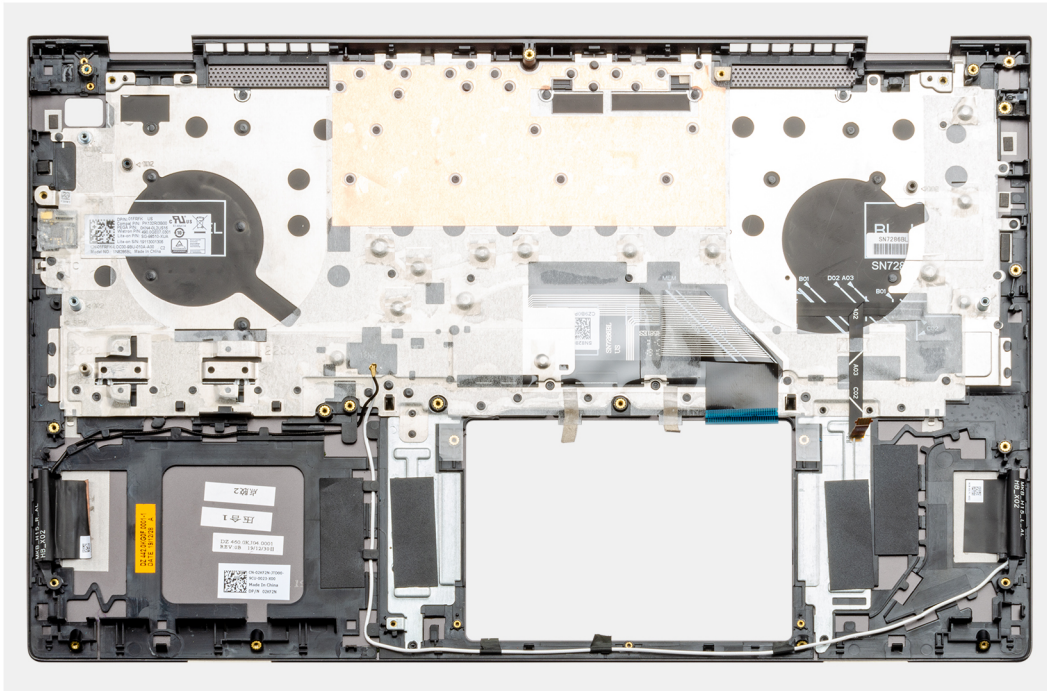

## Steps

Place the palm-rest and keyboard assembly on a flat surface.

## Next steps

1. Install the [system board](#).
2. Install the [display assembly](#).
3. Install the [touchpad](#).
4. Install the [DC-in port](#).
5. Install the [power button with fingerprint reader](#).
6. Install the [I/O board](#).
7. Install the [coin-cell battery](#).
8. Install the [heat sink \(discrete\)](#) or [heat sink \(UMA\)](#).
9. Install the [system fan](#).
10. Install the [GPU fan](#).
11. Install the [speakers](#).
12. Install the [SSD-1 \(M.2 2280\)](#) or [SSD-1 \(M.2 2230\)](#).
13. Install the [SSD-2](#).
14. Install the [memory module](#).
15. Install the [WLAN](#).
16. Install the [battery \(3 cell\)](#) or [battery \(6 cell\)](#).
17. Install the [base cover](#).
18. Follow the procedure in [after working inside your computer](#).

## Drivers and downloads

When troubleshooting, downloading or installing drivers it is recommended that you read the Dell Knowledge Based article, Drivers and Downloads FAQ [SLN128938](#).

# System setup

**CAUTION:** Unless you are an expert computer user, do not change the settings in the BIOS Setup program. Certain changes can make your computer work incorrectly.

**NOTE:** Depending on the computer and its installed devices, the items listed in this section may or may not be displayed.

**NOTE:** Before you change BIOS Setup program, it is recommended that you write down the BIOS Setup program screen information for future reference.

Use the BIOS Setup program for the following purposes:

- Get information about the hardware installed in your computer, such as the amount of RAM and the size of the hard drive.
- Change the system configuration information.
- Set or change a user-selectable option, such as the user password, type of hard drive installed, and enabling or disabling base devices.

## Entering BIOS setup program

### About this task

Turn on (or restart) your computer and press F2 immediately.

## Navigation keys

**NOTE:** For most of the System Setup options, changes that you make are recorded but do not take effect until you restart the system.

**Table 2. Navigation keys**

Keys	Navigation
Up arrow	Moves to the previous field.
Down arrow	Moves to the next field.
Enter	Selects a value in the selected field (if applicable) or follow the link in the field.
Spacebar	Expands or collapses a drop-down list, if applicable.
Tab	Moves to the next focus area. <b>NOTE:</b> For the standard graphics browser only.
Esc	Moves to the previous page until you view the main screen. Pressing Esc in the main screen displays a message that prompts you to save any unsaved changes and restarts the system.

## Boot Sequence

Boot sequence enables you to bypass the System Setup–defined boot device order and boot directly to a specific device (for example: optical drive or hard drive). During the Power-on Self-Test (POST), when the Dell logo appears, you can:

- Access System Setup by pressing F2 key
- Bring up the one-time boot menu by pressing F12 key.

The one-time boot menu displays the devices that you can boot from including the diagnostic option. The boot menu options are:

- Removable Drive (if available)

- STXXXX Drive
- **NOTE:** XXXX denotes the SATA drive number.
- Optical Drive (if available)
- SATA Hard Drive (if available)
- Diagnostics
- **NOTE:** Choosing Diagnostics, displays the SupportAssist screen.

The boot sequence screen also displays the option to access the System Setup screen.

## One time boot menu

To enter **one time boot menu**, turn on your computer, and then press F2 immediately.

- **NOTE:** It is recommended to shutdown the computer if it is on.

The one-time boot menu displays the devices that you can boot from including the diagnostic option. The boot menu options are:

- Removable Drive (if available)
- STXXXX Drive (if available)
- **NOTE:** XXX denotes the SATA drive number.
- Optical Drive (if available)
- SATA Hard Drive (if available)
- Diagnostics
- **NOTE:** Choosing Diagnostics, will display the SupportAssist diagnostics screen.

The boot sequence screen also displays the option to access the System Setup screen.

## BIOS setup

- **NOTE:** Depending on the tabletcomputerlaptop and its installed devices, the items listed in this section may or may not appear.

## Overview

Table 3. Overview

Option	Description
<b>System Information</b>	<p>This section lists the primary hardware features of your computer.</p> <p>The options are:</p> <ul style="list-style-type: none"> <li>• <b>System Information</b> <ul style="list-style-type: none"> <li>• BIOS version</li> <li>• Service Tag</li> <li>• Asset Tag</li> <li>• Manufacture Date</li> <li>• Ownership Date</li> <li>• Express Service Code</li> <li>• Ownership Tag</li> <li>• Signed Firmware Update</li> </ul> </li> <li>• <b>Battery</b> <ul style="list-style-type: none"> <li>• Primary</li> <li>• Battery Level</li> <li>• Battery State</li> <li>• Health</li> <li>• AC Adapter</li> </ul> </li> </ul>



Option	Description
	<ul style="list-style-type: none"> <li>• <b>Processor Information</b> <ul style="list-style-type: none"> <li>• Processor Type</li> <li>• Maximum Clock Speed</li> <li>• Minimum Clock Speed</li> <li>• Current Clock Speed</li> <li>• Core Count</li> <li>• Processor ID</li> <li>• Processor L2 Cache</li> <li>• Processor L3 Cache</li> <li>• Microcode Version</li> <li>• Intel Hyper-Threading Capable</li> <li>• 64-Bit Technology</li> </ul> </li> <li>• <b>Memory Configuration</b> <ul style="list-style-type: none"> <li>• Memory Installed</li> <li>• Memory Available</li> <li>• Memory Speed</li> <li>• Memory Channel Mode</li> <li>• Memory Technology</li> <li>• DIMM_Slot 1</li> <li>• DIMM_Slot 2</li> </ul> </li> <li>• <b>Device Information</b> <ul style="list-style-type: none"> <li>• Panel Type</li> <li>• Video Controller</li> <li>• Video Memory</li> <li>• Wi-Fi Device</li> <li>• Native Resolution</li> <li>• Video BIOS Version</li> <li>• Audio Controller</li> <li>• Bluetooth Device</li> </ul> </li> </ul>

## Boot configuration

Table 4. Boot configuration

Option	Description
<b>Boot Sequence</b>	<p>Allows you to change the order in which the computer attempts to find an operating system.</p> <p>The options are:</p> <ul style="list-style-type: none"> <li>• <b>Windows Boot Manager</b></li> <li>• <b>UEFI Hard Drive</b></li> </ul> <p><b>NOTE:</b> Legacy Boot mode is not supported on this platform.</p>
<b>Secure Boot</b>	<p>Secure Boot helps ensure your system boots using only validated boot software.</p> <p><b>Enable Secure Boot</b>—By default, this option is disabled.</p> <p><b>NOTE:</b> The system has to be in UEFI boot mode to enable Enable Secure Boot.</p>
<b>Secure Boot Mode</b>	<p>Changes to the Secure Boot operation mode modifies the behavior of Secure Boot to allow evaluation of UEFI driver signatures.</p>

Option	Description
	<p>The options are:</p> <ul style="list-style-type: none"> <li>• <b>Deployed Mode</b>—By default, this option is enabled.</li> <li>• <b>Audit Mode</b></li> </ul>
<b>Expert Key Management</b>	<p>Allows you to enable or disable Expert Key Management.</p> <p><b>Enable Custom Mode</b>—By default, this option is disabled.</p> <p>The Custom Mode Key Management options are:</p> <ul style="list-style-type: none"> <li>• <b>PK</b>—By default, this option is enabled.</li> <li>• <b>KEK</b></li> <li>• <b>db</b></li> <li>• <b>dbx</b></li> </ul>

## Integrated Devices

Table 5. Integrated device options

Option	Description
<b>Date/Time</b>	Allows you to set the date and time. The change to the system date and time takes effect immediately.
<b>Camera</b>	Allows you to enable or disable camera. <b>Enable Camera</b> - This option is enabled by default.
<b>Audio</b>	Allows you to turn off all integrated audio. By default, the <b>Enable Audio</b> option is selected. The options are: <ul style="list-style-type: none"> <li>• <b>Enable Microphone</b></li> <li>• <b>Enable Internal Speaker</b></li> </ul>
<b>USB Configuration</b>	Allows you to enable or disable the internal/integrated USB configuration. The options are: <ul style="list-style-type: none"> <li>• <b>Enable USB Boot Support</b></li> <li>• <b>Enable External USB Port</b></li> </ul> By default, all the options are enabled.
<b>Miscellaneous Devices</b>	Allows you to enable or disable the Fingerprint Reader Device. <b>Enable Fingerprint Reader Device</b> - This option is enabled by default.

## Storage

Table 6. Storage options

Option	Description
<b>SATA Operation</b>	Allows you to configure the operating mode of the integrated SATA hard drive controller. The options are: <ul style="list-style-type: none"> <li>• <b>Disabled</b></li> </ul>

Option	Description
	<ul style="list-style-type: none"> <li>· <b>AHCI</b></li> <li>· <b>RAID On</b>—By default, the RAID On option is enabled.</li> </ul> <p><b>i</b>   <b>NOTE: SATA is configured to support RAID mode.</b></p>
<b>Storage Interface</b>	<p>Allows you to enable or disable various drives on board.</p> <p>The options are:</p> <ul style="list-style-type: none"> <li>· <b>SATA-0</b></li> <li>· <b>M.2 PCIe SSD-0</b></li> <li>· <b>M.2 PCIe SSD-1</b></li> </ul> <p>By default, all the options are enabled.</p>
<b>SMART Reporting</b>	<p>This field controls whether hard drive errors for integrated drives are reported during system startup. This technology is part of the Self Monitoring Analysis and Reporting Technology (SMART) specification. By default, the <b>Enable SMART Reporting</b> option is disabled .</p>
<b>Drive Information</b>	<p>Provides information about drive type and device.</p>

## Display

Table 7. Display options

Option	Description
<b>Display Brightness</b>	<p>Allows you to set the screen brightness when running on battery and AC power.</p> <p>The options are:</p> <ul style="list-style-type: none"> <li>· <b>Brightness on battery power</b> - By default, set to 50.</li> <li>· <b>Brightness on AC power</b> - By default, set to 100.</li> </ul>
<b>Touchscreen</b>	<p>Allows you enable or disable the touchscreen for the operating system.</p> <p><b>Touchscreen</b> - By default, all the option is enabled.</p> <p><b>i</b>   <b>NOTE: Touchscreen always works in BIOS setup irrespective of its setting.</b></p>
<b>EcoPower</b>	<p>Allows you to turn on the EcoPower feature in the panel.</p> <p><b>Enable EcoPower</b> - By default, this option is enabled.</p> <p>EcoPower increases the battery life by reducing the display brightness when appropriate.</p>
<b>Full Screen Logo</b>	<p>Displays full screen logo when the image matches screen resolution.</p> <p>By default, all the option is disabled.</p>

## Connection options

Table 8. Connection

Option	Description
<b>Wireless Device Enable</b>	<p>Allows you to enable or disable the internal wireless devices.</p> <p>The options are:</p>

Option	Description
	<ul style="list-style-type: none"> <li>• <b>WLAN</b></li> <li>• <b>Bluetooth</b></li> </ul> <p>Both the options are enabled by default.</p>
<b>Enable UEFI Network Stack</b>	<p>This controls the on-board LAN controller. It allows pre-OS and early operating system networking features to use any enabled NICs when UEFI networking protocols are installed and available, and can be used without the PXE being turned on.</p> <p><b>Enable UEFI Network Stack</b> - This option is disabled by default.</p>

## Power management

Table 9. Power Management

Option	Description
<b>Battery Configuration</b>	<p>Allows the system to run on battery during peak power usage hours.</p> <p>The options are:</p> <ul style="list-style-type: none"> <li>• <b>Adaptive</b>—enabled by default</li> <li>• <b>Standard</b></li> <li>• <b>ExpressCharge</b></li> <li>• <b>Primarily AC Use</b></li> <li>• <b>Custom</b></li> </ul> <p><b>NOTE:</b> If Custom Charge is selected, you can also configure Custom Charge Start and Custom Charge Stop.</p>
<b>Advanced Configuration</b>	<p>This option enables you to maximize the battery health.</p> <p>By default, the <b>Enable Advanced Battery Charge Mode</b> option is disabled.</p> <p><b>NOTE:</b> The user can charge battery using feature Beginning of Day and Work Period.</p> <p>By default, <b>Work Period</b> is disabled.</p> <p>Use ExpressCharge for accelerated battery charging.</p>
<b>Peak Shift</b>	<p>Allows the system to run on battery during peak power usage hours.</p> <p><b>Peak Shift</b> - By default, this option is disabled.</p> <p><b>NOTE:</b> The user can:</p> <ul style="list-style-type: none"> <li>• <b>Set Battery Threshold Min = 15, Max = 100</b></li> <li>• <b>Prevent AC power between certain times of the day using Peak Shift Start, Peak Shift End, and Peak Shift Charge Start.</b></li> </ul>
<b>Thermal Management</b>	<p>Allows cooling of fans and the processor heat management to adjust system performance, noise, and temperature.</p> <p>The options are:</p> <ul style="list-style-type: none"> <li>• <b>Optimized</b>—enabled by default</li> <li>• <b>Cool</b></li> <li>• <b>Quiet</b></li> <li>• <b>Ultra Performance</b></li> </ul>
<b>USB Wake Support</b>	<p><b>Enable USB Wake Support</b> Allows you to enable USB devices to wake the system from standby mode.</p> <p>By default, the option <b>Enable USB Wake Support</b> is disabled.</p>

Option	Description
<b>Wake on Dell USB-C Dock</b>	<p>Allows you to connect a Dell USB-C Dock to wake the system from standby mode.</p> <p>By default, the option <b>Wake on Dell USB-C Dock</b> is enabled.</p> <p><b>NOTE:</b> These features are only functional when the AC power adapter is connected. If the AC power adapter is removed before Standby, the BIOS removes power from all USB ports to conserve battery power.</p>
<b>Block Sleep</b>	<p>This option enables you to block entering to sleep (S3) mode in operating system environment. By default, the <b>Block Sleep</b> option is disabled.</p> <p><b>NOTE:</b> When Block Sleep is enabled, the system does not go to sleep. Intel Rapid Start gets disabled automatically, and the operating system power option will be blank if it was set to Sleep.</p>
<b>Lid Switch</b>	<p>Allows the system to power on (from AC adapter or by system battery) from off state whenever the lid is opened.</p> <p><b>Power On Lid Open</b>—enabled by default.</p>
<b>Intel Speed Shift technology</b>	<p>Allows you to enable or disable the Intel Speed Shift Technology support. By default, <b>Intel Speed Shift technology</b> is enabled. Enabling this option allows the operating system to select appropriate processor performance.</p>

## Security

Table 10. Security



Option	Description
<b>Intel Software Guard Extensions</b>	<p>Provides a secure environment for running code/storing sensitive information in the context of the main operating system and sets enclave reserve memory size.</p> <p><b>Intel SGX</b></p> <p>The options are:</p> <ul style="list-style-type: none"> <li>• <b>Disabled</b></li> <li>• <b>Enabled</b></li> <li>• <b>Software Control</b>—This option is enabled by default.</li> </ul>
<b>Intel Platform Trust Technology</b>	<p>Allows you to control whether Intel Platform Trust Technology (PTT) feature is visible to the operating system.</p> <p><b>Intel Platform Trust Technology On</b> — This option is enabled by default.</p> <p><b>NOTE:</b> Disabling this feature does not change any settings or information stored in PTT.</p>
<b>PPI Bypass for Clear Command</b>	<p>Allows you to control the Trusted Platform Module (TPM).</p> <p><b>PPI Bypass for Clear Command</b> - This option is disabled by default.</p>
<b>Clear</b>	<p>Allows you to clear the PTT owner information and return PTT to the default state.</p> <p><b>Clear</b> - This option is disabled by default.</p>
<b>SMM Security Mitigation</b>	<p>Allows you to enable or disable additional UEFI SMM Security Mitigation protection.</p> <p><b>SMM Security Mitigation</b> - By default, this option is enabled.</p>
<b>Data Wipe on Next Boot</b>	<p>Allows BIOS to queue up data wipe cycle for storage device(s) connected to the motherboard on the next reboot.</p> <p><b>Start Data Wipe</b> - By default, this option is disabled.</p>



Option	Description
	 <b>NOTE: Secure Wipe operation deletes information in a way that it cannot be reconstructed.</b>
<b>Absolute</b>	<p>This field allows you to Enable, Disable, or Permanently Disable the BIOS module interface of the optional Absolute Persistence Module service from Absolute Software.</p> <p>The options are:</p> <ul style="list-style-type: none"> <li>• <b>Enable Absolute</b>—This option is enabled by default.</li> <li>• <b>Disable Absolute</b></li> <li>• <b>Permanently Disable Absolute</b></li> </ul>
<b>UEFI Boot Path Security</b>	<p>Controls whether the system prompts the user to enter the admin password (if set) when booting to a UEFI boot path device from the F12 boot menu.</p> <p>The options are:</p> <ul style="list-style-type: none"> <li>• <b>Never</b></li> <li>• <b>Always</b></li> <li>• <b>Always Except Internal HDD</b>—This option is enabled by default.</li> <li>• <b>Always Except Internal HDD&amp;PXE</b></li> </ul>

## Password

Table 11. Security

Option	Description
<b>Admin Password</b>	<p>Allows you to set, change, or delete the administrator (admin) password.</p> <p>The entries to set password are:</p> <ul style="list-style-type: none"> <li>• <b>Enter the old password:</b></li> <li>• <b>Enter the new password:</b></li> </ul> <p>Press <b>Enter</b> once you enter the new password and again press <b>Enter</b> to confirm the new password.</p> <p> <b>NOTE: Deleting the admin password deletes the system password (if set). The admin password can also be used to delete hard drive password. For this reason, you cannot set an admin password if a system password or hard drive password is set. Hence, an admin password has to be set first if the admin password has to be used with system password and/or hard drive password.</b></p>
<b>System Password</b>	<p>Allows you to set, change, or delete the system password.</p> <p>The entries to set password are:</p> <ul style="list-style-type: none"> <li>• <b>Enter the old password:</b></li> <li>• <b>Enter the new password:</b></li> </ul> <p>Press <b>Enter</b> once you enter the new password and again press <b>Enter</b> to confirm the new password.</p>
<b>Password Configuration</b>	<p>Allows you to configure a password.</p> <p><b>Upper Case Letter</b> When enabled, this field reinforces password must contain at least one upper capital letter.</p> <p><b>Lower Case Letter</b> When enabled, this field reinforces password must contain at least one lower capital letter.</p> <p><b>Digit</b> When enabled, this field reinforces password must contain at least one-digit number.</p> <p><b>Special Character</b> When enabled, this field reinforces password must contain at least one special character.</p> <p> <b>NOTE: These options by default are disabled.</b></p>

Option	Description
	<p><b>Minimum Characters</b> Defines the number of characters allowed for a password. Min = 4</p>
<b>Password Bypass</b>	<p>Allows you to bypass the System password and the Internal hard drive password, when it is set, during a system restart.</p> <p>The options are:</p> <ul style="list-style-type: none"> <li>• <b>Disabled</b>—This option is enabled by default.</li> <li>• <b>Reboot bypass</b></li> </ul>
<b>Password Changes</b>	<p>Allows you to change the system password and hard drive password without the need of administrator password.</p> <p><b>Enable Non-Admin Password Changes</b> - By default, this option is disabled.</p>
<b>Admin Setup Lockout</b>	<p>Allows the administrator to control how the user can access BIOS setup.</p> <p><b>Enable Admin Setup Lockout</b> - By default, this option is disabled.</p> <p><b>NOTE:</b></p> <ul style="list-style-type: none"> <li>• <b>If the admin password is set and Enable Admin Setup Lockout is enabled, you cannot view the BIOS setup (using F2 or F12) without the admin password.</b></li> <li>• <b>If the admin password is set and Enable Admin Setup Lockout is disabled, the BIOS setup can be entered and items that are viewed in Locked mode.</b></li> </ul>
<b>Master Password Lockout</b>	<p>Allows you to disable master password support.</p> <p><b>Enable Master Password Lockout</b> - By default, this option is disabled.</p> <p><b>NOTE:</b> The Hard Disk password has to be cleared before the settings can be changed.</p>

## Update and Recovery

Table 12. Update and recovery

Option	Description
<b>UEFI Capsule Firmware Updates</b>	<p>Allows you to update the system BIOS through UEFI capsule update packages.</p> <p><b>Enable UEFI Capsule Firmware Updates</b> - By default, this option is enabled.</p>
<b>BIOS Recovery from Hard Drive</b>	<p>Allows you to recover BIOS on the primary hard drive or USB drive in corrupted conditions.</p> <p><b>BIOS Recovery from Hard Drive</b> - By default, this option is enabled.</p> <p><b>NOTE:</b> BIOS Recovery from hard drives is not available for Self-Encrypting Drives (SED).</p>
<b>BIOS Downgrade</b>	<p>Allows you to control flashing of the system firmware to previous versions.</p> <p><b>Allow BIOS Downgrade</b> - By default, this option is enabled.</p>
<b>SupportAssist OS Recovery</b>	<p>Allows you to enable or disable the boot flow for SupportAssist OS Recovery if there are certain system errors.</p> <p><b>SupportAssist OS Recovery</b> - By default, this option is enabled.</p> <p><b>NOTE:</b> If SupportAssist OS Recovery setup option is disabled, then all the automatic boot flow for SupportAssist OS Recovery tool is disabled.</p>
<b>BIOSConnect</b>	<p>Allows you to recover cloud service operating system if the main operating system and/or local service operating system fails to boot with the number of failures equal to or greater than the value specified by the Auto operating system Recovery Threshold setup.</p> <p><b>BIOSConnect</b> - By default, this option is enabled.</p>

Option	Description
<b>Dell Auto OS Recovery Threshold</b>	<p>The Auto OS Recovery threshold setup options control the automatic flow for SupportAssist System Resolution Console and for Dell OS Recovery Tool.</p> <p>The options are:</p> <ul style="list-style-type: none"> <li>• <b>Off</b></li> <li>• <b>1</b></li> <li>• <b>2</b> - Default</li> <li>• <b>3</b></li> </ul>

## System management

Table 13. System management

Option	Description
<b>Service Tag</b>	Displays the service tag of your computer.
<b>Asset Tag</b>	An Asset Tag is a string of 64 characters that are used by IT administrator to uniquely identify a particular system. On an asset tag is set, it cannot be changed.
<b>AC Behavior</b>	<p>Allows you to enable or disable the computer from turning on automatically when an AC adapter is connected.</p> <p><b>Wake on AC</b></p> <p>By default, this option is disabled.</p>
<b>Auto On Time</b>	<p>This setting allows a system to automatically power on for defined days/time.</p> <p>The options are:</p> <ul style="list-style-type: none"> <li>• <b>Disabled</b> - This option is enabled by default.</li> <li>• <b>Every Day</b></li> <li>• <b>Weekdays</b></li> <li>• <b>Select Days</b></li> </ul>

## Keyboard

Table 14. Keyboard

Option	Description
<b>Numlock Enable</b>	<p>Allows you to enable or disable Numlock function when the system boots.</p> <p><b>Enable Numlock</b></p> <p>This option is enabled by default.</p>
<b>Fn Lock Options</b>	<p>Allows you to change the function key settings.</p> <p><b>Fn Lock Mode</b></p> <p>This option is enabled by default.</p> <p>The options are:</p> <ul style="list-style-type: none"> <li>• <b>Lock Mode Standard</b></li> <li>• <b>Lock Mode Secondary</b>- This option is enabled by default.</li> </ul>
<b>Keyboard Illumination</b>	<p>Allows you to set keyboard illumination settings using hotkeys &lt;Fn&gt;+&lt;F5&gt; during normal system operation.</p> <p>The options are:</p>

Option	Description
	<ul style="list-style-type: none"> <li>• <b>Disabled</b></li> <li>• <b>Dim</b></li> <li>• <b>Bright</b>- This option is enabled by default.</li> </ul> <p><b>NOTE:</b> The keyboard illumination brightness is set at 100%.</p>
<b>Keyboard Backlight Timeout on AC</b>	<p>This feature defines the timeout value for the keyboard backlight when an AC adapter is plugged in the system.</p> <p>The options are:</p> <ul style="list-style-type: none"> <li>• <b>5 seconds</b></li> <li>• <b>10 seconds</b> - This option is enabled by default.</li> <li>• <b>15 seconds</b></li> <li>• <b>30 seconds</b></li> <li>• <b>1 minute</b></li> <li>• <b>5 minutes</b></li> <li>• <b>15 minutes</b></li> <li>• <b>Never</b></li> </ul> <p><b>NOTE:</b> If <b>Never</b> is selected, the backlight stays on always when the system has AC adapter plugged in.</p>
<b>Keyboard Backlight Timeout on Battery</b>	<p>This feature defines the timeout value for the keyboard backlight when the system is running only on battery power.</p> <p>The options are:</p> <ul style="list-style-type: none"> <li>• <b>5 seconds</b></li> <li>• <b>10 seconds</b> - This option is enabled by default.</li> <li>• <b>15 seconds</b></li> <li>• <b>30 seconds</b></li> <li>• <b>1 minute</b></li> <li>• <b>5 minutes</b></li> <li>• <b>15 minutes</b></li> <li>• <b>Never</b></li> </ul> <p><b>NOTE:</b> If <b>Never</b> is selected, the backlight stays on always when the system is running on battery power.</p>

## Pre-boot behavior

Table 15. Pre-boot behavior

Option	Description
<b>Adapter Warnings</b>	<p>This option displays warning messages during boot when adapters with little power capacity are detected.</p> <ul style="list-style-type: none"> <li>• <b>Enable Adapter Warnings</b> — this option is enabled by default</li> </ul>
<b>Warnings and Errors</b>	<p>This option causes the boot process to only pause when warnings and errors are detected rather than stop, prompt, and wait for user input. This feature is particularly useful where the system is being remotely managed.</p> <p>Select one of the following options:</p> <ul style="list-style-type: none"> <li>• <b>Prompt on Warnings and Errors</b> — this option is enabled by default</li> <li>• <b>Continue on Warnings</b></li> <li>• <b>Continue on Warnings and Errors</b></li> </ul>



Option	Description
	 <b>NOTE: Errors deemed critical to the operation of the system hardware always halt the system.</b>
<b>USB-C Warnings</b>	<p>This option enables or disables dock warning messages.</p> <p><b>Enable Dock Warning Messages</b> — this option is enabled by default.</p>
<b>Fastboot</b>	<p>This option allows you to configure the speed of UEFI boot process.</p> <p>Select one of the following options:</p> <ul style="list-style-type: none"> <li>• <b>Minimal</b></li> <li>• <b>Thorough</b> — this option is enabled by default</li> <li>• <b>Auto</b></li> </ul>
<b>Extend BIOS POST Time</b>	<p>This option allows you to configure the BIOS POST load time.</p> <p>Select one of the following options:</p> <ul style="list-style-type: none"> <li>• <b>0 seconds</b> — this option is enabled by default.</li> <li>• <b>5 seconds</b></li> <li>• <b>10 seconds</b></li> </ul>

## Connection options

Table 16. Connection

Option	Description
<b>Integrated NIC</b>	<p>Integrated NIC controls the onboard LAN controller. It allows pre-OS and early operating system networking features to use any enabled NICs when UEFI networking protocols are installed and available.</p> <p>The options are:</p> <ul style="list-style-type: none"> <li>• <b>Disabled</b></li> <li>• <b>Enabled</b></li> <li>• <b>Enabled with PXE</b> - This option is enabled by default.</li> </ul>
<b>Wireless Device Enable</b>	<p>Allows you to enable or disable the internal wireless devices.</p> <p>The options are:</p> <ul style="list-style-type: none"> <li>• <b>WLAN</b></li> <li>• <b>Bluetooth</b></li> </ul> <p>Both the options are enabled by default.</p>
<b>Enable UEFI Network Stack</b>	<p>Allows you to control the onboard LAN controller. It allows pre-OS and early operating system networking features to use any enabled NICs when UEFI networking protocols are installed and available.</p> <p><b>Enable UEFI Network Stack</b> - This option is enabled by default.</p>

## Performance

Table 17. Performance

Option	Description
<b>Multi Core Support</b>	<p>This field specifies whether the process has one or all cores enabled. The default value is set to the maximum number of cores.</p>

Option	Description
	<ul style="list-style-type: none"> <li>• <b>All Cores</b> — This option is enabled by default.</li> <li>• <b>1</b></li> <li>• <b>2</b></li> <li>• <b>3</b></li> </ul>
<b>Intel SpeedStep</b>	<p>This feature allows the system to dynamically adjust processor voltage and core frequency, decreasing average power consumption and heat production.</p> <p><b>Enable Intel SpeedStep</b></p> <p>This option is enabled by default.</p>
<b>C-States Control</b>	<p>This feature allows you to enable or disable the ability of the CPU to enter and exit low-power states.</p> <p><b>Enable C-state control</b></p> <p>This option is enabled by default.</p> <p>This feature allows the system to dynamically detect high usage of discrete graphics and adjust system parameters for higher performance during that time period.</p> <p><b>Enable Adaptive C-states for Discrete Graphics</b></p> <p>This option is enabled by default.</p>
<b>Intel Turbo Boost Technology</b>	<p>This option allows you to enable or disable the Intel TurboBoost mode of the processor.</p> <p><b>Enable Intel Turbo Boost Technology</b></p> <p>This option is enabled by default.</p>
<b>Intel Hyper-Threading Technology</b>	<p>This option allows you to enable or disable the HyperThreading in the processor.</p> <p><b>Enable Intel Hyper-Threading Technology</b></p> <p>This option is enabled by default.</p>

## System logs

Table 18. System Logs

Option	Description
<b>BIOS Event Log</b>	<p>Allows you to either keep and clear the BIOS event log.</p> <p><b>Clear BIOS Event Log</b></p> <p>The options are:</p> <ul style="list-style-type: none"> <li>• <b>Keep</b> - This option is enabled by default.</li> <li>• <b>Clear</b></li> </ul>
<b>Thermal Event Log</b>	<p>Allows you to either keep and clear the Thermal event log.</p> <p><b>Clear Thermal Event Log</b></p> <p>The options are:</p> <ul style="list-style-type: none"> <li>• <b>Keep</b> - This option is enabled by default.</li> <li>• <b>Clear</b></li> </ul>
<b>Power Event Log</b>	<p>Allows you to either keep and clear the Power event log.</p> <p><b>Clear Power Event Log</b></p>

**Option****Description**

---

The options are:

- **Keep** - This option is enabled by default.
- **Clear**

# Troubleshooting

## Built-in self-test (BIST)

### About this task

There are three different types of BIST to check the performance of display, power rail, and system board. These tests are important to evaluate if an LCD or System board needs a replacement.

1. M-BIST: M-BIST is the system board built-in self-test diagnostics tool that improves the diagnostics accuracy of system board embedded controller (EC) failures. M-BIST must be manually initiated before POST and can also run on a dead system .
2. L-BIST: L-BIST is an enhancement to the single LED error code diagnostics and is automatically initiated during POST.
3. LCD-BIST: LCD BIST is an enhanced diagnostic test that is introduced through Preboot System Assessment (PSA) on legacy systems.

**Table 19. Functions**

	M-Bist	L-Bist
<b>Purpose</b>	Evaluates the health condition of the system board.	Checks if the system board is supplying power to the LCD by performing an LCD Power Rail test.
<b>Trigger</b>	Press the <M> key and power button.	Integrated into the single LED error code diagnostics. Automatically initiated during POST.
<b>Indicator of fault</b>	Battery LED light with <b>Solid Amber</b> .	Battery LED error code of [2,8] blinks Amber x2, then pause, then blinks White x8.
<b>Repair instruction</b>	Indicates a problem with the system board.	Indicates a problem with the system board.

## System board built-in self-test (M-BIST)

### About this task



### Steps

1. Press and hold both the M key and the power button to initiate M-BIST.
2. The battery-status light illuminates in amber when there is a system board failure.
3. Replace the system board to fix the issue.

**NOTE:** The battery status LED does not illuminate if the system board is functioning properly. If further troubleshooting is required, proceed with the applicable Guided Resolution for No Power/No POST, and so on.



# Display panel power rail built-in self-test (L-BIST)

## About this task

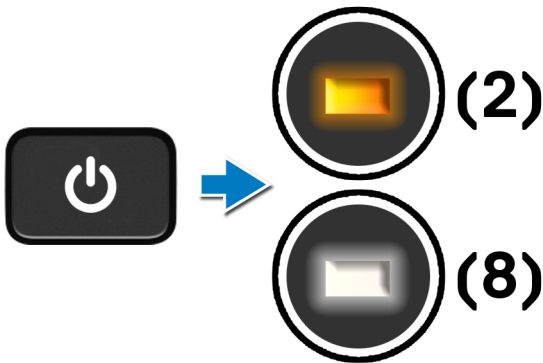

## Next steps

**L-BIST** (LCD Power Rail Test) is an enhancement to the single LED error code diagnostics and is **automatically initiated** during **POST**. L-BIST isolates if the LCD is receiving power from the system board. L-BIST checks if the system board is supplying power to the LCD by performing an LCD Power Rail test. If there is no power going to the LCD, the battery status LED flashes a **[2,8] LED error code**.

# Display panel built-in self-test (LCD-BIST)

## About this task

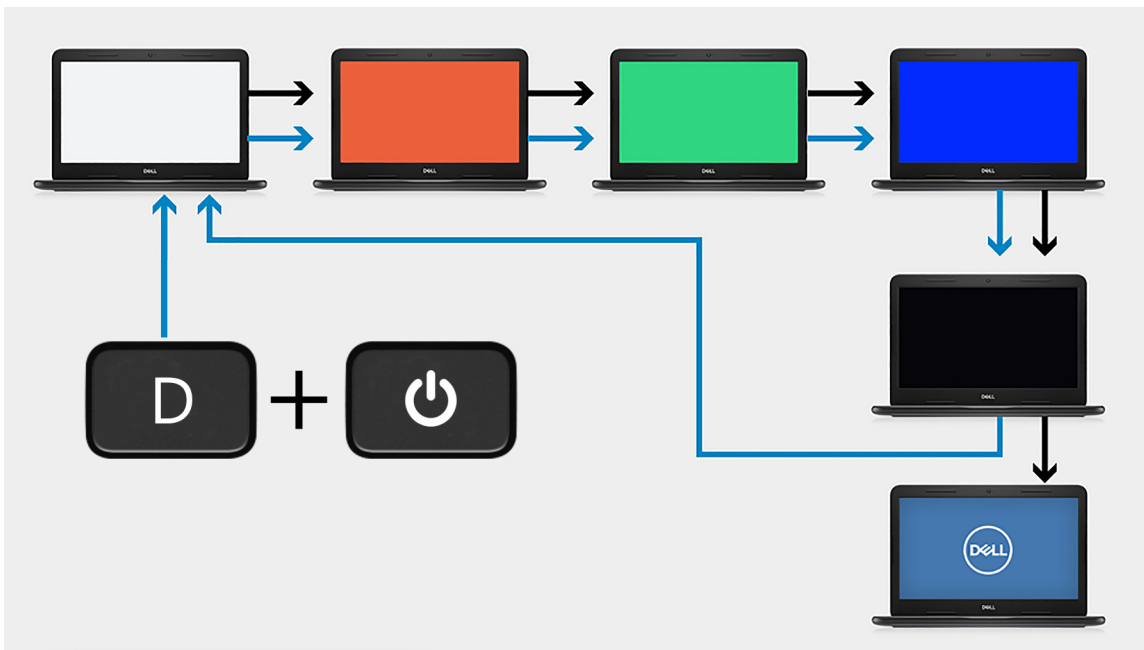

## Steps

1. Press and hold the **D** key, and then press the **power** button.
2. Release both the **D** key and the **power** button when the computer begins POST.
3. The display panel begins to display a solid color, or cycling through different colors.

**NOTE:** The sequence of colors may vary depending on the different display panel vendors. The user only must ensure that the colors are being displayed correctly without distortion or graphical anomalies.

4. The computer reboots at the end of the last solid color.

# Outcome

## About this task

The following table shows the outcome of running different types of BIST.

**Table 20. BIST outcome**

M-BIST	
Off	No fault detected with system board.
Solid amber	Indicates a problem with the system board.

# SupportAssist diagnostics

## About this task

The SupportAssist diagnostics (previously known as ePSA diagnostics) performs a complete check of your hardware. The SupportAssist diagnostics is embedded with the BIOS and is launched by the BIOS internally. The embedded SupportAssist diagnostics provides a set of options for particular devices or device groups allowing you to:

- Run tests automatically or in an interactive mode
- Repeat tests
- Display or save test results
- Run thorough tests to introduce additional test options to provide extra information about the failed device(s)
- View status messages that inform you if tests are completed successfully
- View error messages that inform you of problems encountered during testing

**NOTE:** Some tests for specific devices require user interaction. Always ensure that you are present at the computer terminal when the diagnostic tests are performed.

For more information, see [SupportAssist Pre-Boot System Performance Check](#).

# Running the SupportAssist diagnostics

## Steps

1. Turn on your computer.
2. As the computer boots, press the F12 key as the Dell logo appears.
3. On the boot menu screen, select the **Diagnostics** option.
4. Click the arrow in the lower-right corner to go to the page listing.  
The items that are detected are listed.
5. Select the device from the left cluster to run tests to run a diagnostic test on a specific device.
6. If there are any issues, error codes are displayed.  
Note the error code and validation number and contact Dell.

# System diagnostic lights

## Battery-status light

Indicates the power and battery-charge status.

**Solid white** — Power adapter is connected and the battery has more than 5 percent charge.

**Amber** — Computer is running on battery and the battery has less than 5 percent charge.

## Off

- Power adapter is connected, and the battery is fully charged.
- Computer is running on battery, and the battery has more than 5 percent charge.
- Computer is in sleep state, hibernation, or turned off.

The power and battery-status light blinks amber along with beep codes indicating failures.

For example, the power and battery-status light blinks amber two times followed by a pause, and then blinks white three times followed by a pause. This 2,3 pattern continues until the computer is turned off indicating no memory or RAM is detected.

The following table shows different power and battery-status light patterns and associated problems.

**Table 21. LED codes**

Diagnostic light codes	Problem description
1,1	TPM Detection Failure
1,2	Unrecoverable SPI Flash Failure
1,3	Short in hinge cable tripped OCP1
1,4	Short in hinge cable tripped OCP2
1, 5	EC unable to program i-Fuse
1, 6	Generic catch-all for ungraceful EC code flow errors
1, 7	-
1, 8	-
1, 9	-
2,1	CPU failure
2,2	Motherboard covers BIOS corruption or ROM error
2,3	No Memory/RAM detected
2,4	Memory/RAM Failure
2,5	Invalid memory installed
2,6	Motherboard/Chipset Error
2,7	LCD failure - SBIOS message
2,8	LCD failure - EC detection of power rail failure
2,9	-
3,1	CMOS battery failure
3,2	PCI of Video card/chip failure
3,4	Recovery Image found but invalid
3,5	EC ran into power sequencing failure
3,6	Flash corruption detected by SBIOS
3,7	Timeout waiting on ME to reply to HECI message
3,8	-
3,9	-

**Camera status indicator:** Indicates whether the camera is in use.

- Solid white — Camera is in use.
- Off — Camera is not in use.

**Caps Lock status indicator:** Indicates whether Caps Lock is enabled or disabled.

- Solid white — Caps Lock enabled.
- Off—Caps Lock disabled.

## Recovering the operating system

When your computer is unable to boot to the operating system even after repeated attempts, it automatically starts Dell SupportAssist OS Recovery.

Dell SupportAssist OS Recovery is a standalone tool that is preinstalled in all Dell computers installed with Windows 10 operating system. It consists of tools to diagnose and troubleshoot issues that may occur before your computer boots to the operating system. It enables you to diagnose hardware issues, repair your computer, back up your files, or restore your computer to its factory state.

You can also download it from the Dell Support website to troubleshoot and fix your computer when it fails to boot into their primary operating system due to software or hardware failures.

For more information about the Dell SupportAssist OS Recovery, see *Dell SupportAssist OS Recovery User's Guide* at [www.dell.com/support](http://www.dell.com/support).

## Flashing the BIOS

### About this task

It is recommended to flash the BIOS when an update is available or when you replace the system board. To flash the BIOS:

### Steps

1. Turn on your computer.
  2. Go to [www.dell.com/support](http://www.dell.com/support).
  3. Click **Product support**, enter the Service Tag of your computer, and then click **Submit**.
-  **NOTE: If you do not have the Service Tag, use the Autodefect feature or manually browse for your computer model.**
4. Click **Drivers & downloads > Find it myself**.
  5. Select the operating system installed on your computer.
  6. Scroll down the page, and expand **BIOS**.
  7. Click **Download** to download the latest version of the BIOS for your computer.
  8. After the download is complete, navigate to the folder where you saved the BIOS update file.
  9. Double-click the BIOS update file icon, and follow the instructions on the screen.

## Flashing BIOS (USB key)

### Steps

1. Follow the procedure from step 1 to step 7 in "Flashing the BIOS" to download the latest BIOS setup program file.
2. Create a bootable USB drive. For more information, see the knowledge base article [SLN143196](http://www.dell.com/support) at [www.dell.com/support](http://www.dell.com/support).
3. Copy the BIOS setup program file to the bootable USB drive.
4. Connect the bootable USB drive to the computer that needs the BIOS update.
5. Restart the computer and press **F12** when the Dell logo is displayed on the screen.
6. Boot to the USB drive from the **One Time Boot Menu**.
7. Type the BIOS setup program filename and press **Enter**.
8. The **BIOS Update Utility** appears. Follow the instructions on the screen to complete the BIOS update.

## Backup media and recovery options

It is recommended to create a recovery drive to troubleshoot and fix problems that may occur with Windows. Dell proposes multiple options for recovering Windows operating system on your Dell PC. For more information, see [Dell Windows Backup Media and Recovery Options](#).

## WiFi power cycle

### About this task

If your computer is unable to access the internet due to WiFi connectivity issues a WiFi power cycle procedure may be performed. The following procedure provides the instructions on how to conduct a WiFi power cycle:

 **NOTE: Some ISPs (Internet Service Providers) provide a modem/router combo device.**

**Steps**

1. Turn off your computer.
2. Turn off the modem.
3. Turn off the wireless router.
4. Wait for 30 seconds.
5. Turn on the wireless router.
6. Turn on the modem.
7. Turn on your computer.





# Getting help and contacting Dell

## Self-help resources

You can get information and help on Dell products and services using these self-help resources:

**Table 22. Self-help resources**

Self-help resources	Resource location
Information about Dell products and services	<a href="http://www.dell.com">www.dell.com</a>
My Dell	
Tips	
Contact Support	In Windows search, type <code>Contact Support</code> , and press Enter.
Online help for operating system	<a href="http://www.dell.com/support/windows">www.dell.com/support/windows</a> <a href="http://www.dell.com/support/linux">www.dell.com/support/linux</a>
Troubleshooting information, user manuals, set up instructions, product specifications, technical help blogs, drivers, software updates, and so on.	<a href="http://www.dell.com/support">www.dell.com/support</a>
Dell knowledge base articles for a variety of computer concerns	<ol style="list-style-type: none"> <li>1. Go to <a href="http://www.dell.com/support">www.dell.com/support</a>.</li> <li>2. On the menu bar at the top of the Support page, select <b>Support &gt; Knowledge Base</b>.</li> <li>3. In the Search field on the Knowledge Base page, type the keyword, topic, or model number, and then click or tap the search icon to view the related articles.</li> </ol>
Learn and know the following information about your product:	See <i>Me and My Dell</i> at <a href="http://www.dell.com/support/manuals">www.dell.com/support/manuals</a> .
<ul style="list-style-type: none"> <li>• Product specifications</li> <li>• Operating system</li> <li>• Setting up and using your product</li> <li>• Data backup</li> <li>• Troubleshooting and diagnostics</li> <li>• Factory and system restore</li> <li>• BIOS information</li> </ul>	<p>To locate the <i>Me and My Dell</i> relevant to your product, identify your product through one of the following:</p> <ul style="list-style-type: none"> <li>• Select <b>Detect Product</b>.</li> <li>• Locate your product through the drop-down menu under <b>View Products</b>.</li> <li>• Enter the <b>Service Tag number</b> or <b>Product ID</b> in the search bar.</li> </ul>

## Contacting Dell

To contact Dell for sales, technical support, or customer service issues, see [www.dell.com/contactdell](http://www.dell.com/contactdell).

 **NOTE: Availability varies by country/region and product, and some services may not be available in your country/region.**

 **NOTE: If you do not have an active Internet connection, you can find contact information about your purchase invoice, packing slip, bill, or Dell product catalog.**