

# OptiPlex 5480 All-In-One

## Setup and Specifications



## Notes, cautions, and warnings

 **NOTE:** A NOTE indicates important information that helps you make better use of your product.

 **CAUTION:** A CAUTION indicates either potential damage to hardware or loss of data and tells you how to avoid the problem.

 **WARNING:** A WARNING indicates a potential for property damage, personal injury, or death.

<b>1 Set up your computer.....</b>	<b>4</b>
<b>2 Views of OptiPlex 5480 All-in-One.....</b>	<b>15</b>
Front.....	15
Retractable camera.....	16
Left.....	17
Right.....	19
Back.....	21
Bottom.....	24
System board layout.....	26
<b>3 Specifications of OptiPlex 5480 All-in-One.....</b>	<b>28</b>
Dimensions and weight.....	28
Processors.....	28
Chipset.....	29
Operating system.....	30
Memory.....	30
Ports and connectors.....	31
Communications.....	32
Audio.....	32
Storage.....	33
Intel Optane memory.....	33
Media-card reader.....	34
Camera.....	34
Power supply unit.....	35
Display.....	35
Video.....	36
Computer environment.....	37
Security.....	37
Data security.....	38
Environmental.....	38
Regulatory.....	38
Accessories.....	39
Service and support.....	40
<b>4 Getting help and contacting Dell.....</b>	<b>41</b>

# Set up your computer

1. Set up the stand.

**Table 1. Installing the stands**

Stands	Installing the stands
Fixed Stand	 A diagram illustrating the installation of a fixed stand on a laptop. The stand is shown in two positions: one where it is being attached to the bottom of the laptop, and another where it is being attached to the top. Blue arrows indicate the direction of movement for the stand's top and bottom components.

**Table 1. Installing the stands(continued)**

Stands	Installing the stands
Articulating stand	 <p>The image illustrates the installation of an articulating stand on a Dell monitor. The top portion shows the monitor with the stand already attached. The bottom portion shows the stand being inserted into the monitor's base, with blue arrows indicating the insertion points.</p>
Height Adjustable Stand	<p><b>NOTE:</b> Follow the same procedure to install the Height Adjustable Stand with Optical Disk Drive.</p>

**Table 1. Installing the stands(continued)**

Stands	Installing the stands
	

2. Set up the keyboard and mouse.

 **NOTE:** For setup instructions, see the documentation shipped with the keyboard and mouse.





3. Route the power cable through the stand, then connect the power cable.



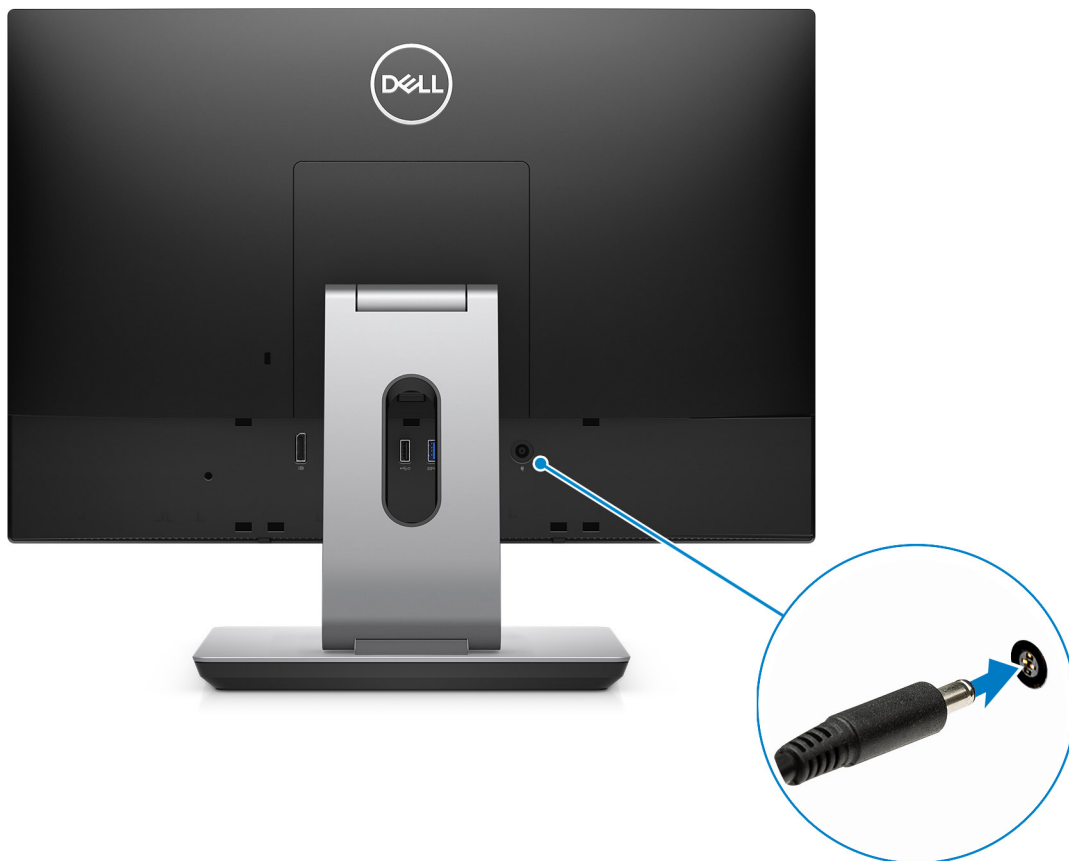



4. Press the power button.





5. Finish Windows setup.

Follow the on-screen instructions to complete the setup. When setting up, Dell recommends that you:

- Connect to a network for Windows updates.

**i** **NOTE:** If connecting to a secured wireless network, enter the password for the wireless network access when prompted.

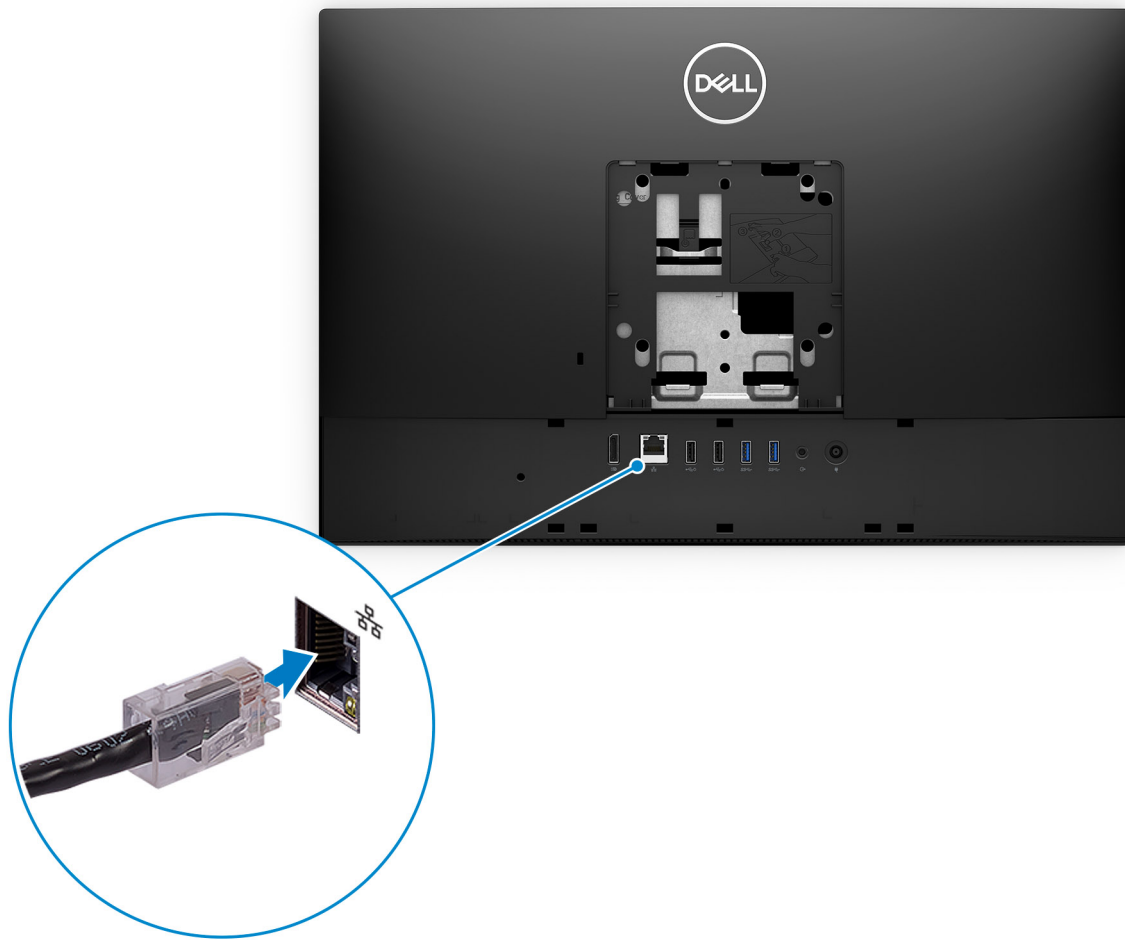

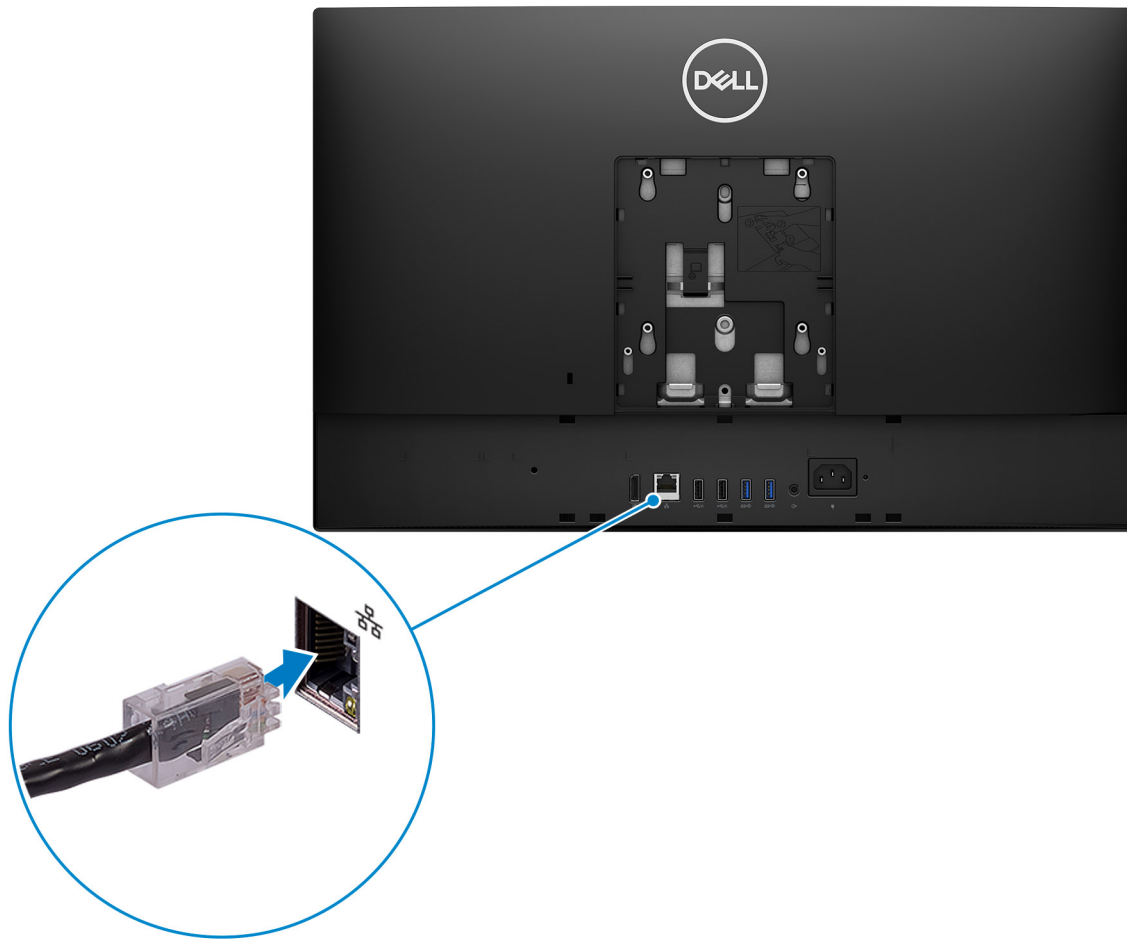



- If connected to the internet, sign-in with or create a Microsoft account. If not connected to the internet, create an offline account.
- On the **Support and Protection** screen, enter your contact details.

6. Locate and use Dell apps from the Windows Start menu—Recommended

**Table 2. Locate Dell apps**

Resources	Description
	<p><b>SupportAssist</b></p> <p>Pro-actively checks the health of your computer’s hardware and software. The SupportAssist OS Recovery tool troubleshoots issues with the operating system. For more information, see the SupportAssist documentation at <a href="http://www.dell.com/support">www.dell.com/support</a>.</p> <p><b>NOTE:</b> In SupportAssist, click the warranty expiry date to renew or upgrade your warranty.</p>
	<p><b>Dell Update</b></p> <p>Updates your computer with critical fixes and latest device drivers as they become available. For more information about using Dell Update, see the knowledge base article <a href="http://www.dell.com/support">SLN305843</a> at <a href="http://www.dell.com/support">www.dell.com/support</a>.</p>
	<p><b>Dell Digital Delivery</b></p> <p>Download software applications, which are purchased but not pre-installed on your computer. For more information about using Dell Digital Delivery, see the knowledge base article <a href="http://www.dell.com/support">153764</a> at <a href="http://www.dell.com/support">www.dell.com/support</a>.</p>

## Views of OptiPlex 5480 All-in-One

### Front

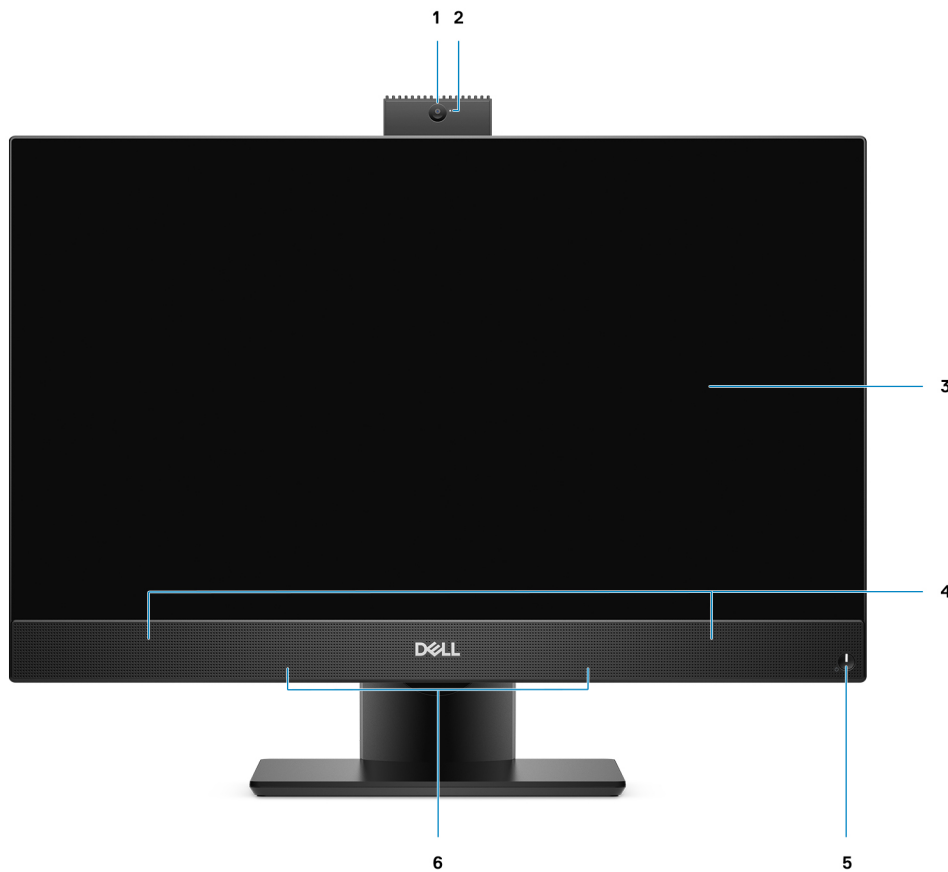

- |  |                        |
|--|------------------------|
| 1. Full HD webcam                      | 2. Camera-status light |
| 3. Display                             | 4. Speakers            |
| 5. Power button/power-status indicator | 6. Array microphones   |

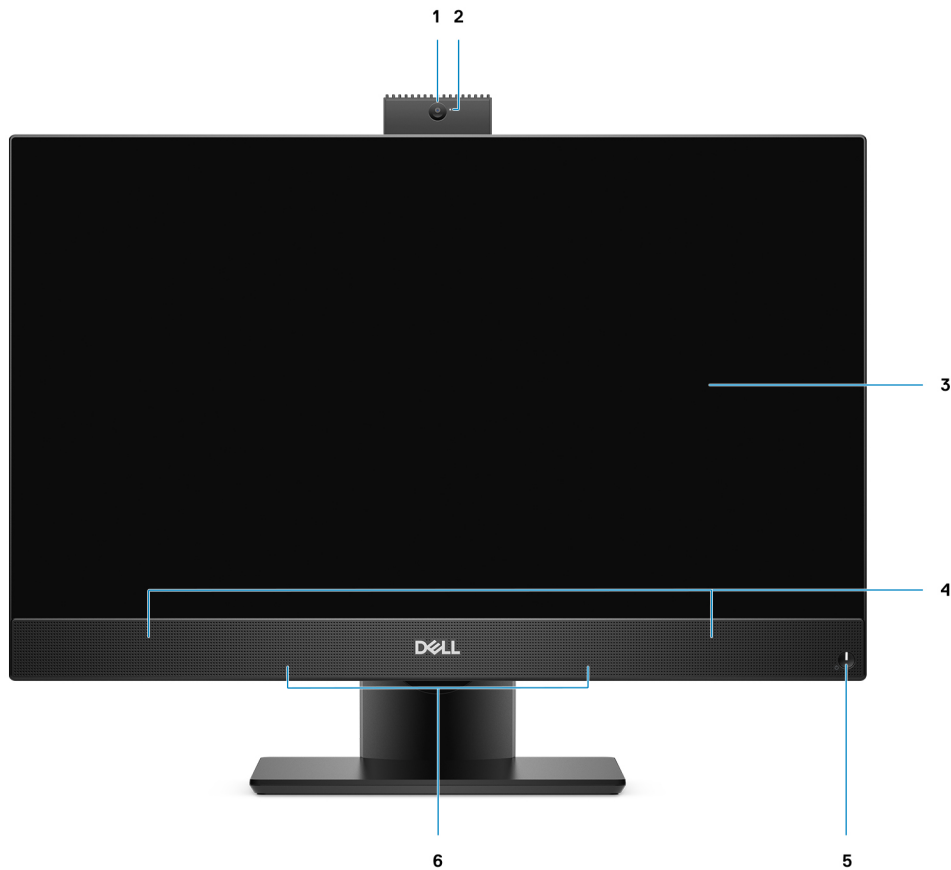

- |  |                        |
|--|------------------------|
| 1. Full HD webcam                      | 2. Camera-status light |
| 3. Display                             | 4. Speakers            |
| 5. Power button/power-status indicator | 6. Array microphones   |

## Retractable camera

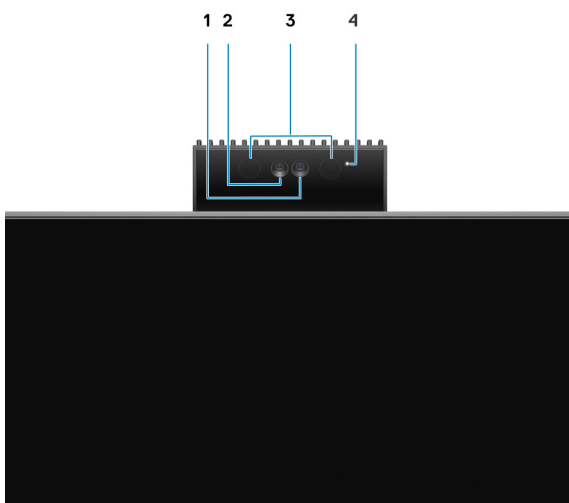

**i** **NOTE:** Depending on the configuration ordered, your computer will have only camera or both camera and Infrared camera.



1. Camera
2. Infrared camera
3. Infrared emitter
4. Camera-status light

## Left

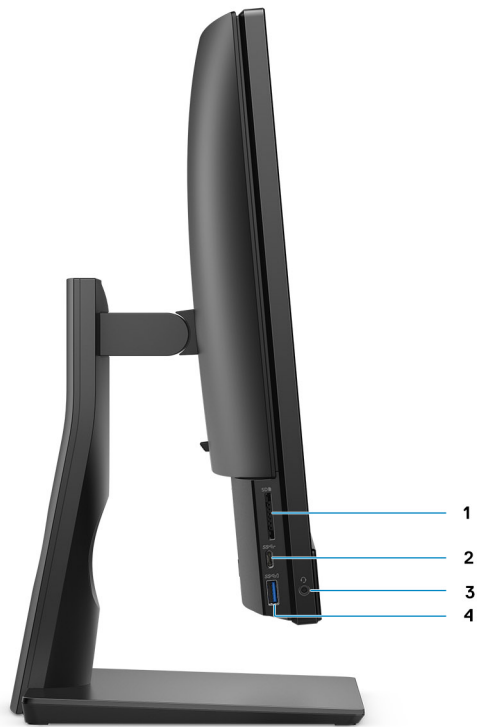

1. SD 3.0 card slot
3. Universal audio jack

2. USB 3.2 Gen 1 Type-C port
4. USB 3.2 Gen 1 Type-A port with PowerShare

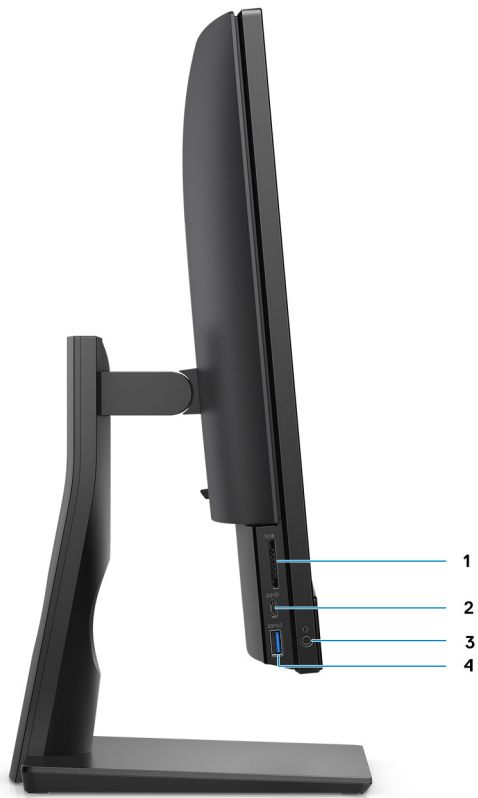

1. SD 4.0 card slot
3. Universal audio jack

2. USB 3.2 Gen 2 Type-C port
4. USB 3.2 Gen 1 Type-A port with PowerShare

# Right

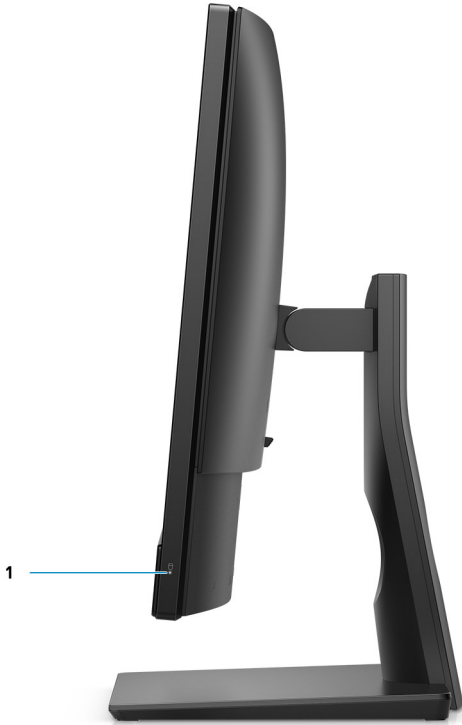

1. Hard-drive status indicator



1. Hard-drive status indicator

# Back



- 1. Back cover
- 2. Stand cover
- 3. Kensington security-cable slot
- 4. Back bottom cover
- 5. Stand

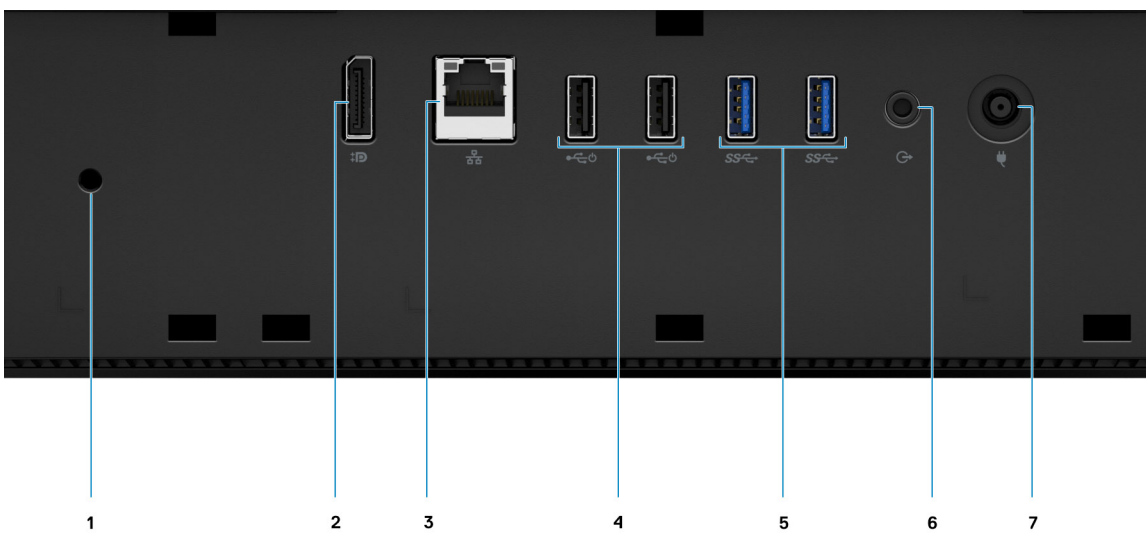

- 1. Cable cover screw hole
- 2. DP++ 1.4/HDCP 2.3 port

- 3. RJ-45 port 10/100/1000 Mbps
- 5. USB 3.2 Gen 1 Type-A ports
- 7. Power connector

- 4. USB 2.0 ports with Smart Power On
- 6. Line-out audio port



- 1. Back cover
- 3. Kensington security-cable slot
- 5. Stand

- 2. Stand cover
- 4. Back bottom cover

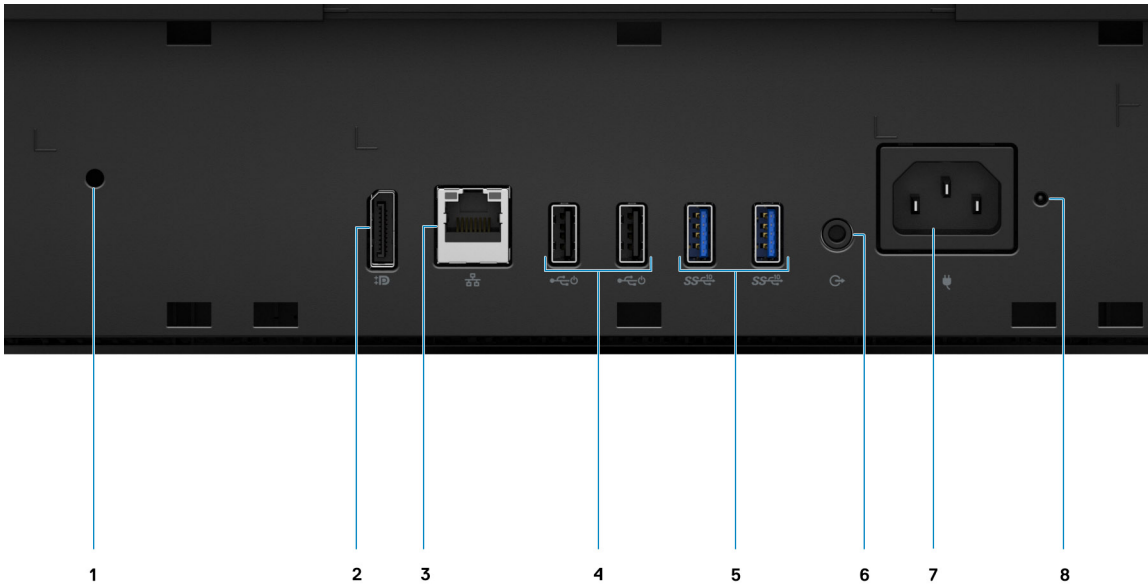

- |  |  |
|--|--|
| <ol style="list-style-type: none"> <li>1. Cable cover screw hole</li> <li>3. RJ-45 port 10/100/1000 Mbps</li> <li>5. USB 3.2 Gen 2 Type-A ports</li> <li>7. Power connector</li> </ol> | <ol style="list-style-type: none"> <li>2. DP++ 1.4/HDCP 2.3 port</li> <li>4. USB 2.0 ports with Smart Power On</li> <li>6. Line-out audio port</li> <li>8. PSU status indicator LED</li> </ol> |
|--|--|

# Bottom

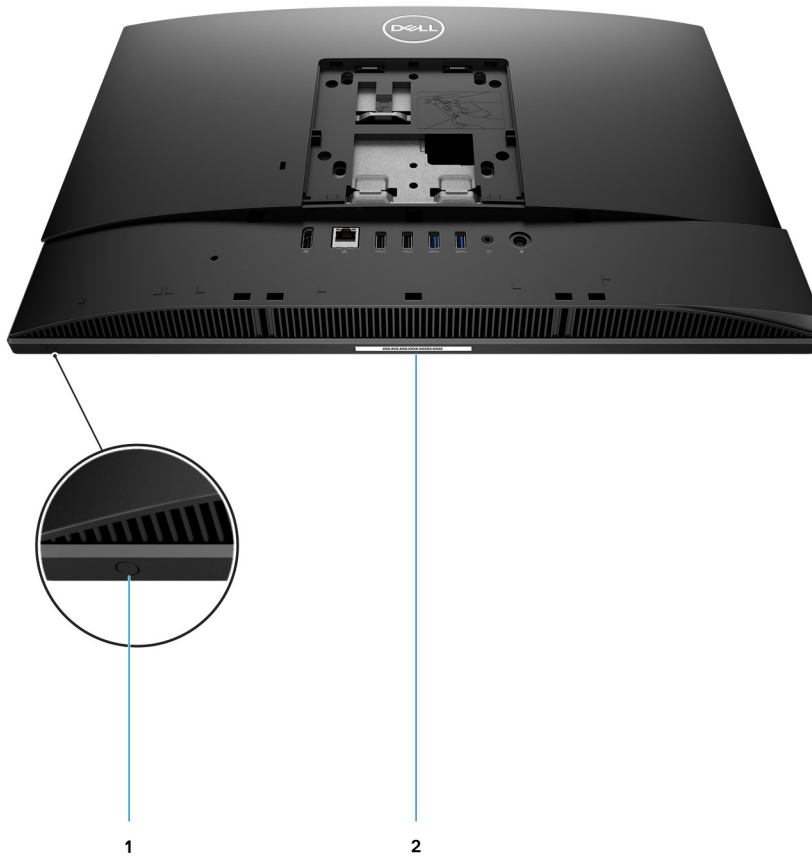

1. Display Built-in Self Test button
2. Service tag label



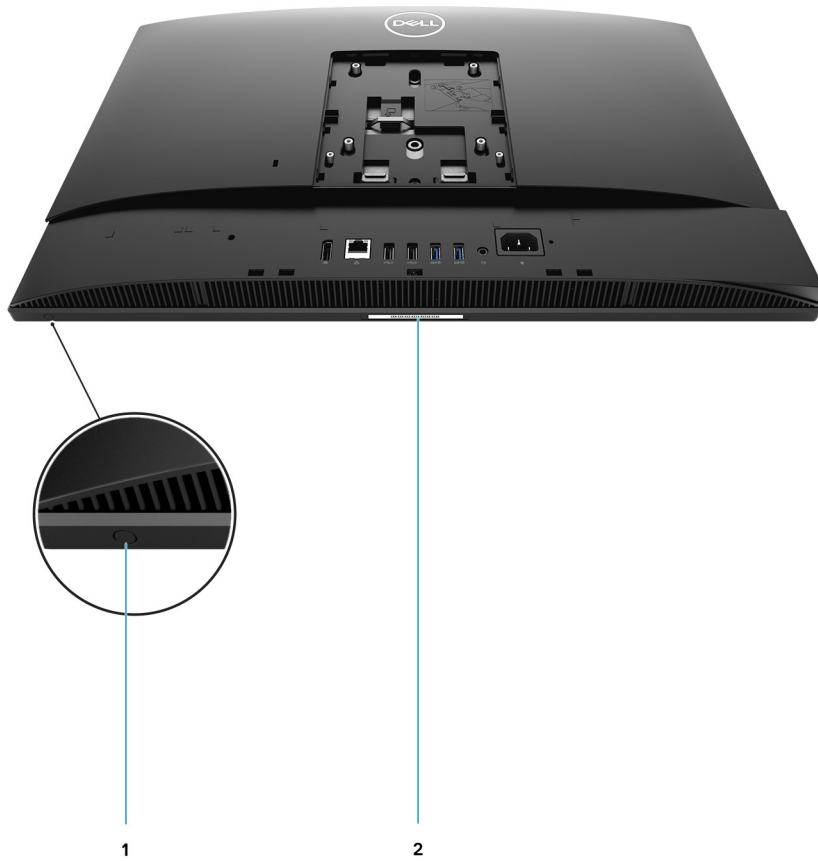

1. Display Built-in Self Test button
2. Service tag label

# System board layout

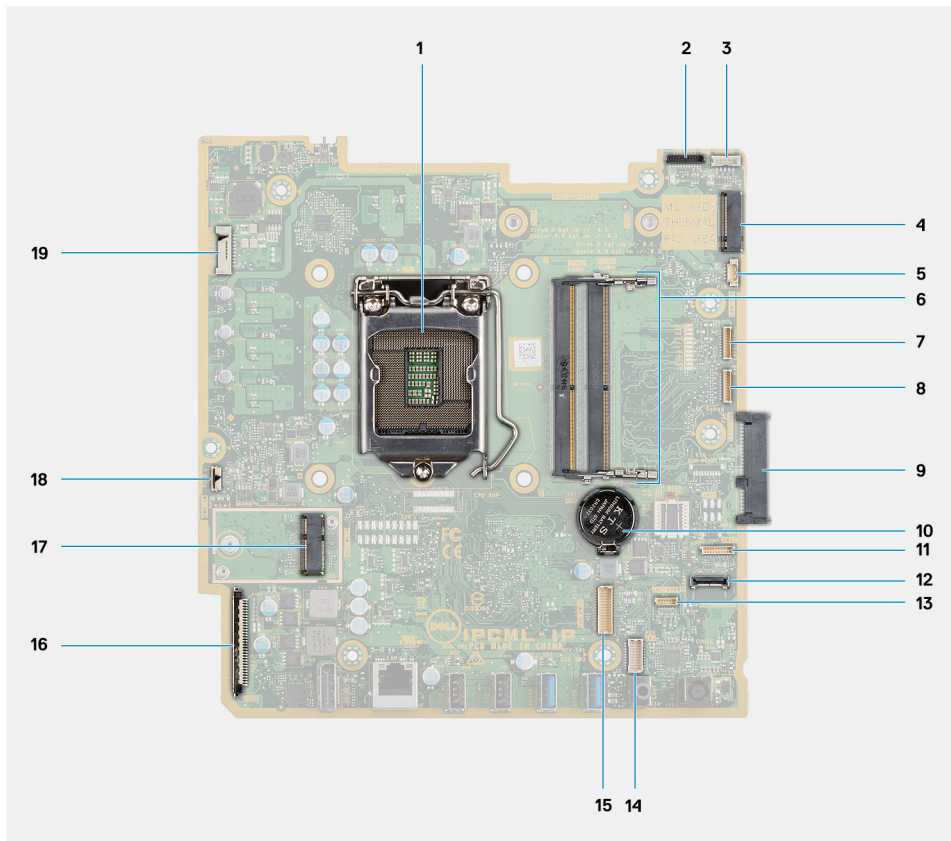

- |  |  |
|--|--|
| 1. Processor                           | 2. Camera cable connector                                      |
| 3. Touch-screen cable connector        | 4. M.2 2230/2280 solid-state drive/Intel Optane PCIe connector |
| 5. System-fan cable connector          | 6. Memory module   |
| 7. eSPI Debug Card cable connector     | 8. EC debug connector  |
| 9. Hard-drive connector                | 10. Coin-cell battery  |
| 11. Microphone-module cable connector  | 12. SIO-signal cable connector                                 |
| 13. Speaker cable connector            | 14. Audio-board cable connector                                |
| 15. SIO-power cable connector          | 16. Display cable connector                                    |
| 17. M.2 WLAN connector                 | 18. Power-button cable connector                               |
| 19. Display back-light cable connector |  |

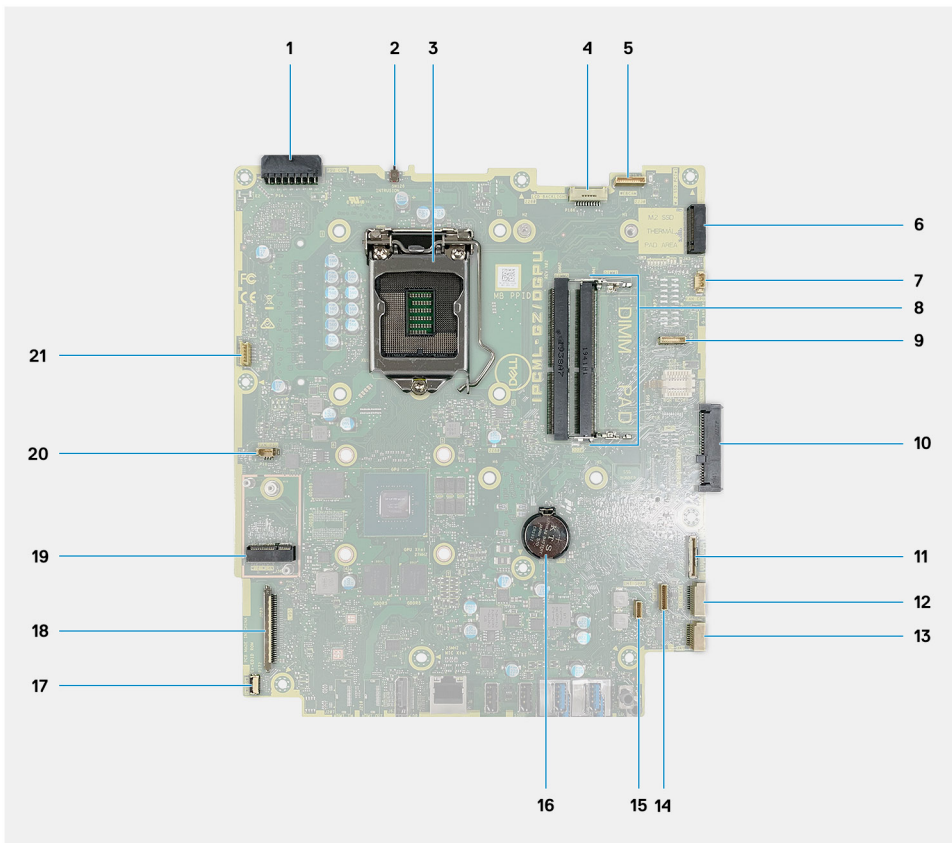

- |                                      |  |
|--------------------------------------|--|
| 1. Power-supply unit (PSU) connector | 2. Intrusion switch  |
| 3. Processor                         | 4. Display back-light cable connector                          |
| 5. Camera cable connector            | 6. M.2 2230/2280 solid-state drive/Intel Optane PCIe connector |
| 7. System-fan cable connector        | 8. Memory module   |
| 9. LPC debug card connector          | 10. Hard-drive connector                                       |
| 11. SIO-signal cable connector       | 12. SIO-power cable connector                                  |
| 13. Audio-board cable connector      | 14. Microphone-module cable connector                          |
| 15. Speaker cable connector          | 16. Coin-cell battery  |
| 17. Power-button cable connector     | 18. Display cable connector                                    |
| 19. M.2 WLAN connector               | 20. PSU-fan cable connector                                    |
| 21. Touch-screen cable connector     |  |

# Specifications of OptiPlex 5480 All-in-One

## Dimensions and weight

**Table 3. Dimensions and weight**

Description	Values for touch display	Values for non-touch display
Height	344 mm (13.54 in.)	344.00 mm (13.54 in.)
Width	540.20 mm (21.26 in.)	540.20 mm (21.26 in.)
Depth	52.80 mm (2.07 in.)	52.80 mm (2.07 in.)
Weight (maximum)	6.30 kg (13.88 lb)	6.59 kg (14.52 lb)
Weight (Minimum)	5.85 kg (12.89 lb)	5.84 kg (12.89 lb)

**NOTE:** The weight of your system depends on the configuration that is ordered and the manufacturing variability.

## Processors

**NOTE:** Global Standard Products (GSP) are a subset of Dell's relationship products that are managed for availability and synchronized transitions on a worldwide basis. They ensure the same platform is available for purchase globally. This allows customers to reduce the number of configurations managed on a worldwide basis, thereby reducing their costs. They also enable companies to implement global IT standards by locking in specific product configurations worldwide.

Device Guard (DG) and Credential Guard (CG) are the new security features that only available on Windows 10 Enterprise today. Device Guard is a combination of enterprise-related hardware and software security features. When you configure together, it locks a device down so that it can only run trusted applications. If it is not a trusted application, it cannot run. Credential Guard uses virtualization-based security to isolate secrets (credentials) so that only privileged system software can access them. Unauthorized access to these secrets can lead to credential theft attacks. Credential Guard prevents these attacks by protecting NTLM password hashes and Kerberos Ticket Granting Tickets.

**NOTE:** Processor numbers are not a measure of performance. Processor availability subject to change and may vary by region/country.

**Table 4. Processors for Discrete graphics configuration**

Processors	Wattage	Core count	Thread count	Speed	Cache	Integrated graphics
10 <sup>th</sup> Generation Intel Core i3-10100	65 W	4	8	3.6 GHz to 4.3 GHz	6 MB	Intel UHD Graphics 630
10 <sup>th</sup> Generation Intel Core i3-10300	65 W	4	8	3.7 GHz to 4.4 GHz	8 MB	Intel UHD Graphics 630
10 <sup>th</sup> Generation Intel Core i5-10400	65 W	6	12	2.9 GHz to 4.3 GHz	12 MB	Intel UHD Graphics 630
10 <sup>th</sup> Generation Intel Core i5-10500	65 W	6	12	3.1 GHz to 4.5 GHz	12 MB	Intel UHD Graphics 630

**Table 4. Processors for Discrete graphics configuration(continued)**

Processors	Wattage	Core count	Thread count	Speed	Cache	Integrated graphics
10 <sup>th</sup> Generation Intel Core i5-10600	65 W	6	12	3.3 GHz to 4.8 GHz	12 MB	Intel UHD Graphics 630
10 <sup>th</sup> Generation Intel Core i7-10700	65 W	8	16	2.9 GHz 4.8 GHz	16 MB	Intel UHD Graphics 630

**Table 5. Processors for Integrated graphics configuration**

Processors	Wattage	Core count	Thread count	Speed	Cache	Integrated graphics
10 <sup>th</sup> Generation Intel Pentium Gold G6400T	35 W	2	4	3.4 GHz	4 MB	Intel UHD Graphics 610
10 <sup>th</sup> Generation Intel Pentium Gold G6500T	35 W	2	4	3.5 GHz	4 MB	Intel UHD Graphics 630
10 <sup>th</sup> Generation Intel Core i3-10100T	35 W	4	8	3.0 GHz to 3.8 GHz	6 MB	Intel UHD Graphics 630
10 <sup>th</sup> Generation Intel Core i3-10300T	35 W	4	8	3.0 GHz to 3.9 GHz	8 MB	Intel UHD Graphics 630
10 <sup>th</sup> Generation Intel Core i5-10400T	35 W	6	12	2.0 GHz to 3.6 GHz	12 MB	Intel UHD Graphics 630
10 <sup>th</sup> Generation Intel Core i5-10500T	35 W	6	12	2.3 GHz to 3.8 GHz	12 MB	Intel UHD Graphics 630
10 <sup>th</sup> Generation Intel Core i5-10600T	35 W	6	12	2.4 GHz to 4.0 GHz	12 MB	Intel UHD Graphics 630
10 <sup>th</sup> Generation Intel Core i7-10700T	35 W	8	16	2.0 GHz to 4.5 GHz	16 MB	Intel UHD Graphics 630

## Chipset

**Table 6. Chipset**

Description	Values
Chipset	Intel Q470
Processor	10 <sup>th</sup> Generation Intel Core i3/i5/i7 and Intel Pentium Gold
DRAM bus width	<ul style="list-style-type: none"> <li>· 64-bit (for single channel)</li> <li>· 128-bit (for dual channel)</li> </ul>
Flash EPROM	32 MB
PCIe bus	Up to Gen 3
Non-volatile memory	Yes
BIOS configuration Serial Peripheral Interface (SPI)	256 Mbit (32 MB) located at SPI_FLASH

**Table 6. Chipset(continued)**

Description	Values
Trusted Platform Module (TPM) 2.0 (Discrete TPM Enabled)	24 KB located at TPM 2.0 on chipset
Firmware-TPM (Discrete TPM disabled)	By default the Platform Trust Technology feature is visible to the operating system.
NIC EEPROM	LOM configuration contained within SPI flash ROM instead of LOM e-fuse

## Operating system

- Windows 10 Home (64-bit)
- Windows 10 IoT Enterprise 2019 LTSC (OEM Only)
- Windows 10 Professional (64-bit)
- Windows 10 Pro Education (64-bit)
- Ubuntu 18.04 (64-bit)

For more information about Dell OS Recovery image, see How to Download and Use the Dell OS Recovery Image in Microsoft Windows, at [Dell support site](#).

### Commercial platform Windows 10 N-2 and 5-year operating system supportability:

All newly introduced 2019 and later commercial platforms (Latitude, OptiPlex, and Dell Precision) will qualify and ship with the most current factory installed Semi-Annual Channel Windows 10 version (N) and qualify (but not ship) the previous two versions (N-1, N-2). The OptiPlex 5480 All-in-One will RTS with Windows 10 version v19H2 at time of launch, and this version will determine the N-2 versions that are initially qualified for this platform.

For future versions of Windows 10, Dell continues to test the commercial platform with coming Windows 10 releases during device production and for five years post-production, including both fall and spring releases from Microsoft.

For additional information about N-2 and 5-year Windows operating system supportability, see the Dell Windows as a Service (WaaS), at [Dell support site](#).

### EOML 411

The OptiPlex 5480 All-in-One continues to test the coming Semi-Annual Channel Windows 10 version releases for five years post-production, including both fall and spring releases from Microsoft.

## Memory

**Table 7. Memory specifications**

Description	Values
Slots	Two SO-DIMM slots
Type	DDR4, Non-ECC
Speed	2666 MHz/2933 MHz
Maximum memory	64 GB
Minimum memory	4 GB
Memory size per slot	4 GB, 8 GB, 16 GB, 32 GB
Configurations supported	<ul style="list-style-type: none"> <li>• 4 GB, 1 x 4 GB, 2666 MHz for Intel Core i3/i5, Pentium processors, 2933 MHz for Intel Core i7 processors</li> <li>• 8 GB, 1 x 8 GB, 2666 MHz for Intel Core i3/i5, Pentium processors, 2933 MHz for Intel Core i7 processors</li> </ul>

**Table 7. Memory specifications(continued)**

Description	Values
	<ul style="list-style-type: none"> <li>8 GB, 2 x 4 GB, 2666 MHz for Intel Core i3/i5, Pentium processors, 2933 MHz for Intel Core i7 processors</li> <li>16 GB, 1 x 16 GB, 2666 MHz for Intel Core i3/i5, Pentium processors, 2933 MHz for Intel Core i7 processors</li> <li>16 GB, 2 x 8 GB, 2666 MHz for Intel Core i3/i5, Pentium processors, 2933 MHz for Intel Core i7 processors</li> <li>32 GB, 1 x 32 GB, 2666 MHz for Intel Core i3/i5, Pentium processors, 2933 MHz for Intel Core i7 processors</li> <li>32 GB, 2 x 16 GB, 2666 MHz for Intel Core i3/i5, Pentium processors, 2933 MHz for Intel Core i7 processors</li> <li>64 GB, 2 x 32 GB, 2666 MHz for Intel Core i3/i5, Pentium processors, 2933 MHz for Intel Core i7 processors</li> </ul>

## Ports and connectors

**Table 8. External ports and connectors**

Description	Values
<b>External:</b>	
Network	One RJ-45 port 10/100/1000 Mbps (rear)
USB	<ul style="list-style-type: none"> <li>One USB 3.2 Gen 2 Type-C port (side)</li> <li>One USB 3.2 Gen 1 Type-A port with PowerShare (side)</li> <li>Two USB 2.0 ports with Smart Power On (rear)</li> <li>Two USB 3.2 Gen 2 Type-A ports (rear)</li> </ul>
Audio	<ul style="list-style-type: none"> <li>One Universal audio jack (side)</li> <li>One Line-out audio port (rear)</li> </ul>
Video	One DP++ 1.4/HDCP 2.3 port (rear)
Media card reader	One SD 4.0 card slot (side)
Docking port	Not supported
Power adapter port	Not supported
Security	One Kensington security-cable slot

**Table 9. Internal ports and connectors**

Description	Values
<b>Internal:</b>	
M.2	<ul style="list-style-type: none"> <li>One M.2 2230 slot for Wi-Fi and Bluetooth card</li> <li>One M.2 2230/2280 slot for solid-state drive/Intel Optane</li> </ul> <p><b>NOTE:</b> To learn more about the features of different types of M.2 cards, see the knowledge base article <a href="#">SLN301626</a>.</p>

# Communications

## Ethernet

Table 10. Ethernet specifications

Description	Values
Model number	Intel i219LM
Transfer rate	10/100/1000 Mbps

## Wireless module

Table 11. Wireless module specifications

Description	Values	
Model number	Intel Wi-Fi 6 AX201	Qualcomm QCA61x4A
Transfer rate	Up to 2400 Mbps	Up to 867 Mbps
Frequency bands supported	2.4 GHz/5 GHz	2.4 GHz/5 GHz
Wireless standards	<ul style="list-style-type: none"><li>• Wi-Fi 802.11 a/b/g</li><li>• Wi-Fi 4 (WiFi 802.11n)</li><li>• Wi-Fi 5 (WiFi 802.11ac)</li><li>• Wi-Fi 6 (WiFi 802.11ax)</li></ul>	<ul style="list-style-type: none"><li>• Wi-Fi 802.11 a/b/g</li><li>• Wi-Fi 4 (WiFi 802.11n)</li><li>• Wi-Fi 5 (WiFi 802.11ac)</li></ul>
Encryption	<ul style="list-style-type: none"><li>• 64-bit/128-bit WEP</li><li>• AES-CCMP</li><li>• TKIP</li></ul>	<ul style="list-style-type: none"><li>• 64-bit/128-bit WEP</li><li>• AES-CCMP</li><li>• TKIP</li></ul>
Bluetooth	Bluetooth 5.1	Bluetooth 5.0

## Audio

Table 12. Audio specifications

Description	Values
Controller	Realtek codec ALC3289
Stereo conversion	Supported
Internal interface	High definition audio interface
External interface	Universal audio jack
Speakers	2
Internal speaker amplifier	Realtek Amplifier ALC1302
External volume controls	Not supported
Speaker output:	



**Table 12. Audio specifications(continued)**

Description		Values
	Average	2 W
	Peak	3 W
Subwoofer output		Not supported
Microphone		2

## Storage

Your computer supports one of the following configurations:

- One 2.5-inch hard-disk drive
- One M.2 2230/2280 solid-state drive (class 35, 40)
- One M.2 2230/2280 solid-state drive (class 35, 40) and one 2.5-inch hard-disk drive
- One 2.5-inch hard-disk drive and one M.2 16 GB/32 GB Intel Optane Memory

The primary drive of your computer varies with the storage configuration. For computers:

- with a M.2 drive, the M.2 drive is the primary drive
- without a M.2 drive, the 2.5-inch hard-disk drive is the primary drive
- With a M.2 16 GB/32 GB Intel Optane memory, the 2.5-inch hard-disk drive is the primary drive

**Table 13. Storage specifications**

Storage type	Interface type	Capacity
2.5-inch, 7200 RPM, hard-disk drive	SATA	Up to 1 TB
2.5-inch, 7200 RPM, Opal Self-Encrypting hard-disk drive	FIPS SATA	Up to 500 GB
2.5-inch, 5400 RPM, hard-disk drive	SATA	Up to 2 TB
M.2 2230, Class 35 solid-state drive	Gen 3 PCIe x4 NVMe	Up to 512 TB
M.2 2230, Opal Self-Encrypting Class 35 solid-state drive	Gen 3 PCIe x4 NVMe	Up to 256 GB
M.2 2280, Class 40 solid-state drive	Gen 3 PCIe x4 NVMe	Up to 2 TB
M.2 2280, Opal Self-Encrypting Class 40 solid-state drive	Gen 3 PCIe x4 NVMe	Up to 1 TB

## Intel Optane memory

Intel Optane memory functions only as a storage accelerator. It neither replaces nor adds to the memory (RAM) installed on your computer.

**NOTE:** Intel Optane memory is supported on computers that meet the following requirements:

- **7<sup>th</sup> Generation or higher Intel Core i3/i5/i7 processor**
- **Windows 10 64-bit version or higher (Anniversary Update)**
- **Latest version of Intel Rapid Storage Technology driver**

**Table 14. Intel Optane memory**

Description	Values
Type	Memory

**Table 14. Intel Optane memory(continued)**

Description	Values
Interface	Gen 3 PCIe x4 NVMe
Connector	M.2 2280
Configurations supported	16 GB, 32 GB
Capacity	Up to 32 GB

## Media-card reader

**Table 15. Media-card reader specifications**

Description	Values
Type	One Secure Digital (SD) 4.0 card
Cards supported	<ul style="list-style-type: none"> <li>· Secure Digital High Capacity (SDHC)</li> <li>· Secure Digital Extended Capacity (SDXC)</li> <li>· Secure Digital (SD) 4.0</li> <li>· SD UHS-I (UHS104)</li> <li>· SD UHS-II</li> </ul>

## Camera

**Table 16. Full HD Infrared Webcam (with Windows Hello support)**

Description	Values
Number of cameras	Two
Type	FHD RGB camera/VGA Infrared camera
Location	Front camera
Sensor type	CMOS sensor technology
Resolution	
Camera	
Still image	2.07 megapixel
Video	1920 x 1080 (FHD) at 30 fps
Infrared camera	
Still image	0.30 megapixel
Video	640 x 480 (VGA) at 30 fps
Diagonal viewing angle	
Camera	77.5 degrees
Infrared camera	82.8 degrees

**Table 17. Full HD Webcam**

Description	Values
Number of cameras	One
Type	FHD RGB camera
Location	Front camera
Sensor type	CMOS sensor technology
Resolution	
Camera	
Still image	2.07 megapixels
Video	1920 x 1080 (FHD) at 30 fps
Diagonal viewing angle	77.4 degrees

## Power supply unit

**Table 18. Power supply unit specifications**

Description	Values	
Type	220 W Platinum—for discrete graphics configurations	155 W Bronze—for integrated graphics configurations
Diameter (connector)	Not supported	Not supported
Input voltage	90 VAC to 264 VAC	90 VAC to 264 VAC
Input frequency	47 Hz to 63 Hz	47 Hz to 63 Hz
Input current (maximum)	3.6 A	3.6 A
Output current (continuous)	<ul style="list-style-type: none"> <li>• +19.5 VA/8.5 A</li> <li>• +19.5 VB/9.2 A</li> </ul> Standby mode: <ul style="list-style-type: none"> <li>• +19.5 VA/0.5 A</li> <li>• +19.5 VB/1.75 A</li> </ul>	<ul style="list-style-type: none"> <li>• +19.5 VA/7.5 A</li> <li>• +19.5 VB/7.0 A</li> </ul> Standby mode: <ul style="list-style-type: none"> <li>• +19.5 VA/0.5 A</li> <li>• +19.5 VB/1.75 A</li> </ul>
Rated output voltage	<ul style="list-style-type: none"> <li>• +19.5 VA</li> <li>• +19.5 VB</li> </ul>	<ul style="list-style-type: none"> <li>• +19.5 VA</li> <li>• +19.5 VB</li> </ul>
Temperature range:		
Operating	5°C to 45°C (41°F to 113°F)	5°C to 45°C (41°F to 113°F)
Storage	-40°C to 70°C (-40°F to 158°F)	-40°C to 70°C (-40°F to 158°F)

## Display

**Table 19. Display specifications**

Description	Values for touch display	Values for non-touch display
Type	Full High Definition (FHD)	Full High Definition (FHD)
Panel technology	Wide Viewing Angle (WVA)	Wide Viewing Angle (WVA)

**Table 19. Display specifications(continued)**

Description		Values for touch display	Values for non-touch display
Luminance		<ul style="list-style-type: none"> <li>250 Nits (typical)</li> <li>200 Nits (minimum)</li> </ul>	<ul style="list-style-type: none"> <li>250 Nits (typical)</li> <li>200 Nits (minimum)</li> </ul>
Dimensions (Active area):			
	Height	296.46 mm (11.67 in.)	296.46 mm (11.67 in.)
	Width	527.04 mm (20.75 in.)	527.04 mm (20.75 in.)
	Diagonal	604.70 mm (23.81 in.)	604.70 mm (23.81 in.)
Native resolution		1920 x 1080	1920 x 1080
Megapixels		16.7 million colors	16.7 million colors
Color gamut		72% NTSC typical	72% NTSC typical
Pixels per inch (PPI)		92	92
Contrast ratio (min)		700:01:00	700:01:00
Response time (max)		25 ms	25 ms
Refresh rate		60 Hz	60 Hz
Horizontal view angle		<ul style="list-style-type: none"> <li>85 +/-degrees (minimum)</li> <li>89 +/-degrees (typical)</li> </ul>	<ul style="list-style-type: none"> <li>85 +/-degrees (minimum)</li> <li>89 +/-degrees (typical)</li> </ul>
Vertical view angle		<ul style="list-style-type: none"> <li>85 +/-degrees (minimum)</li> <li>89 +/-degrees (typical)</li> </ul>	<ul style="list-style-type: none"> <li>85 +/-degrees (minimum)</li> <li>89 +/-degrees (typical)</li> </ul>
Pixel pitch		0.2745 x 0.2745 mm	0.2745 x 0.2745 mm
Power consumption (maximum)		13.48 W	13.48 W
Anti-glare vs glossy finish		Anti-glare	Anti-glare

## Video

**Table 20. Video specifications**

Discrete graphics			
Controller	External display support	Memory size	Memory Type
NVIDIA GeForce GTX 1050 K1	Not applicable	3 GB	GDDR5

**Table 21. Video specifications**

Integrated graphics			
Controller	External display support	Memory size	Processor
Intel UHD 610 Graphics	DP++ 1.4/HDCP 2.3 port	Shared system memory	Intel Pentium Gold G6400T

**Table 21. Video specifications(continued)**

Integrated graphics			
Controller	External display support	Memory size	Processor
Intel UHD 630 Graphics	DP++ 1.4/HDCP 2.3 port	Shared system memory	10 <sup>th</sup> Generation Intel Core i3/i5/i7 and Intel Pentium Gold G6500T

## Computer environment

**Airborne contaminant level:** G1 as defined by ISA-S71.04-1985

**Table 22. Computer environment**

Description	Operating	Storage
Temperature range	10°C to 35°C (50°F to 95°F)	-40°C to 65°C (-40°F to 149°F)
Relative humidity (maximum)	20% to 80% (non-condensing)	5% to 95% (non-condensing)
Vibration (maximum)*	0.26 GRMS	1.37 GRMS
Shock (maximum)	40 G†	105 G†
Altitude (maximum)	0 m to 3048 m (0 ft to 10000 ft)	0 m to 10668 m (0 ft to 35000 ft)

\* Measured using a random vibration spectrum that simulates user environment.

† Measured using a 2 ms half-sine pulse when the hard drive is in use.

## Security

**Table 23. Security**

Security options
Kensington lock
Dell Lockable port cover (optional)
Chassis lock slot support
Noble Custom AIO Plate Lock (optional)
Supply chain tamper alerts
Chassis intrusion switch
Trusted Platform Module (Discrete TPM Enabled)
SafeBIOS including Dell Off-host BIOS Verification
BIOS Resilience
BIOS Recovery, and additional BIOS Controls
SafelD including Trusted Platform Module (TPM) 2.0
Self-Encrypting Drives (SED)
Smart card keyboard (FIPS)
D-Pedigree (Secure Supply Chain Functionality)

**Table 23. Security (continued)**

Security options
Dell wired mouse with fingerprint reader

## Data security

**Table 24. Data security**

Data security options
McAfee® Small Business Security 30 Day Free Trial
McAfee® Small Business Security 12-month subscription
McAfee® Small Business Security 36-month Subscription
SafeGuard and Response, which is powered by VMware Carbon Black and Secureworks
Next Generation Anti-virus (NGAV)
Endpoint Detection and Response (EDR)
Threat Detection and Response (TDR)
Managed Endpoint Detection and Response
Incident Management Retainer
Emergency Incident Response
SafeData

## Environmental

**Table 25. Environmental specifications**

Feature	Values
Recyclable packaging	Yes
BFR/PVC—free chassis	No
Vertical orientation packaging support	Yes
Multi-Pack packaging	No
Energy-Efficient Power Supply	Standard
ENV0424 compliant	Yes

**NOTE:** Wood-based fiber packaging contains a minimum of 35% recycled content by total weight of wood-based fiber. Packaging that contains without wood-based fiber can be claimed as Not Applicable. The anticipated required criteria for EPEAT 2018.

## Regulatory

**Table 26. Regulatory**

Regulatory compliance
EPEAT registered configurations available
ENERGY STAR compliant configurations available

**Table 26. Regulatory(continued)**

<b>Regulatory compliance</b>
TCO 8.0 certified configurations available
CEL
WEEE
Japan Energy Law
South Korea E-standby
South Korea Eco-label
EU RoHS
China RoHS

## Accessories

**Table 27. Accessories**

<b>Accessories</b>
<b>Audio</b> Optional external speakers, Dell Pro Stereo Headset UC350
<b>Keyboard</b> Dell wired keyboard, Dell wireless keyboard, Dell Smart Card keyboard
<b>Mouse</b> Dell wired mouse, Dell wireless mouse, Dell USB Laser mouse, Dell Fingerprint Reader mouse
<b>Stylus</b> Targus Stylus for Capacitive Touch Devices
<b>Additional Monitor</b> Qualified with select Dell UltraSharp, Professional, and E-series monitors
<b>Locks</b> Noble custom AIO Plate Lock, Dell Combination Lock LC300, Dell Premium Lock LP500, KensingtonTwin Head Lock, Dell Lockable Port Cover
<b>Stands</b> <ul style="list-style-type: none"> <li>· Fixed Stand</li> <li>· Articulating Stand</li> <li>· Height Adjustable Stand</li> <li>· Height Adjustable Stand with Optical Disk Drive</li> </ul>

**Table 28. Accessories**

<b>Accessories</b>
<b>Audio</b> Optional external speakers, Dell Pro Stereo Headset UC350
<b>Keyboard</b> Dell wired keyboard, Dell wireless keyboard, Dell Smart Card keyboard
<b>Mouse</b>

**Table 28. Accessories(continued)**

<b>Accessories</b>
Dell wired mouse, Dell wireless mouse, Dell USB Laser mouse, Dell Fingerprint Reader mouse
<b>Stylus</b>
Targus Stylus for Capacitive Touch Devices
<b>Additional Monitor</b>
Qualified with select Dell UltraSharp, Professional, and E-series monitors
<b>Locks</b>
Noble custom AIO Plate Lock, Dell Combination Lock LC300, Dell Premium Lock LP500, KensingtonTwin Head Lock, Dell Lockable Port Cover
<b>Stands</b>
<ul style="list-style-type: none"> <li>· Articulating Stand</li> <li>· Height Adjustable Stand</li> </ul>

## Service and support

**Table 29. Service and support**

<b>Warranty</b>	<b>Accidental Damage Service</b>
3 Years Hardware Service with Onsite/In-Home Service after Remote Diagnosis, warranty extensions up to 5 years	Accidental Damage Service is available to complement certain warranty options Optional.
ProSupport with Next Business Day Onsite Service is available to complement certain warranty options.	
ProSupport Plus for Client is available to complement certain warranty options.	



# Getting help and contacting Dell

## Self-help resources

You can get information and help on Dell products and services using these self-help resources:

**Table 30. Self-help resources**

Self-help resources	Resource location
Information about Dell products and services	<a href="http://www.dell.com">www.dell.com</a>
Tips	
Contact Support	In Windows search, type <code>Contact Support</code> , and press Enter.
Online help for operating system	<a href="http://www.dell.com/support/windows">www.dell.com/support/windows</a> <a href="http://www.dell.com/support/linux">www.dell.com/support/linux</a>
Troubleshooting information, user manuals, setup instructions, product specifications, technical help blogs, drivers, software updates, and so on.	<a href="http://www.dell.com/support">www.dell.com/support</a>
Dell knowledge base articles for a variety of computer concerns.	<ol style="list-style-type: none"> <li>1. Go to <a href="https://www.dell.com/support/home/?app=knowledgebase">https://www.dell.com/support/home/?app=knowledgebase</a>.</li> <li>2. Type the subject or keyword in the <b>Search</b> box.</li> <li>3. Click <b>Search</b> to retrieve the related articles.</li> </ol>

## Contacting Dell

To contact Dell for sales, technical support, or customer service issues, see [www.dell.com/contactdell](http://www.dell.com/contactdell).

**NOTE:** Availability varies by country and product, and some services may not be available in your country.

**NOTE:** If you do not have an active internet connection, you can find contact information on your purchase invoice, packing slip, bill, or Dell product catalog.