



## 6 x 6 Dante Audio Interface with HDMI VE66DTH User Manual



[www.aten.com](http://www.aten.com)

## EMC Information

---

### FEDERAL COMMUNICATIONS COMMISSION INTERFERENCE

**STATEMENT:** This equipment has been tested and found to comply with the limits for a Class A digital device, pursuant to Part 15 of the FCC Rules. These limits are designed to provide reasonable protection against harmful interference when the equipment is operated in a commercial environment. This equipment generates, uses, and can radiate radio frequency energy and, if not installed and used in accordance with the instruction manual, may cause harmful interference to radio communications. Operation of this equipment in a residential area is likely to cause harmful interference in which case the user will be required to correct the interference at his own expense.

**FCC Caution:** Any changes or modifications not expressly approved by the party responsible for compliance could void the user's authority to operate this equipment.

**Warning:** Operation of this equipment in a residential environment could cause radio interference.

This device complies with Part 15 of the FCC Rules. Operation is subject to the following two conditions:

- (1) this device may not cause harmful interference, and
- (2) this device must accept any interference received, including interference that may cause undesired operation.

**Achtung:** Der Gebrauch dieses Geräts in Wohnumgebung kann Funkstörungen verursachen.

### KCC Statement

유선 제품용 / A 급 기기 (업무용 방송 통신 기기)

이 기기는 업무용 (A 급) 전자파적합기기로서 판매자 또는 사용자는 이 점을 주의하시기 바라며, 가정 외의 지역에서 사용하는 것을 목적으로 합니다.

## RoHS

---

This product is RoHS compliant.



© Copyright 2021 ATEN® International Co., Ltd.  
Released: 2021-01-29

ATEN and the ATEN logo are registered trademarks of ATEN International Co., Ltd. All rights reserved. All other brand names and trademarks are the registered property of their respective owners. The terms HDMI, HDMI High-Definition Multimedia Interface, and the HDMI Logo are trademarks or registered trademarks of HDMI Licensing Administrator, Inc.

## User Information

---

### Online Registration

Be sure to register your product at our online support center:

International	<a href="http://eservice.aten.com">http://eservice.aten.com</a>
---------------	---

### Telephone Support

For telephone support, call this number:

International	886-2-8692-6959
China	86-400-810-0-810
Japan	81-3-5615-5811
Korea	82-2-467-6789
North America	1-888-999-ATEN ext 4988 1-949-428-1111

### User Notice

All information, documentation, and specifications contained in this manual are subject to change without prior notification by the manufacturer. The manufacturer makes no representations or warranties, either expressed or implied, with respect to the contents hereof and specifically disclaims any warranties as to merchantability or fitness for any particular purpose. Any of the manufacturer's software described in this manual is sold or licensed as *is*. Should the programs prove defective following their purchase, the buyer (and not the manufacturer, its distributor, or its dealer), assumes the entire cost of all necessary servicing, repair and any incidental or consequential damages resulting from any defect in the software.

The manufacturer of this system is not responsible for any radio and/or TV interference caused by unauthorized modifications to this device. It is the responsibility of the user to correct such interference.

The manufacturer is not responsible for any damage incurred in the operation of this system if the correct operational voltage setting was not selected prior to operation. PLEASE VERIFY THAT THE VOLTAGE SETTING IS CORRECT BEFORE USE.

## Package Contents

---

- ◆ 1 VE66DTH 6 x 6 Dante Audio Interface with HDMI
- ◆ 6 5-Pole Terminal Blocks
- ◆ 4 Foot Pads
- ◆ 1 Mounting Kit
- ◆ 1 Power Adapter
- ◆ 1 User Instructions

- 
- Note:**
1. Check to make sure that all the components are present and that nothing got damaged in shipping. If you encounter a problem, contact your dealer.
  2. Read this manual thoroughly and follow the installation and operation procedures carefully to prevent any damage to the unit, and/or any of the devices connected to it.
-

# Table of Contents

---

EMC Information . . . . .	ii
RoHS . . . . .	ii
User Information . . . . .	iii
Online Registration . . . . .	iii
Telephone Support . . . . .	iii
User Notice . . . . .	iii
Package Contents . . . . .	iv
About this Manual . . . . .	vii
Conventions . . . . .	viii
Product Information . . . . .	ix

## 1. Introduction

Overview . . . . .	1
Features . . . . .	2
Planning the Installation . . . . .	3
Requirements . . . . .	3
Considerations . . . . .	3
Components . . . . .	4
VE66DTH Front View . . . . .	4
System Status LEDs . . . . .	4
VE66DTH Rear View . . . . .	5

## 2. Hardware Setup

Rack Mounting the VE66DTH Unit . . . . .	7
Rack Mounting . . . . .	7
Connecting the VE66DTH Unit . . . . .	9
Connecting Balanced Inputs Source and Output Device . . . . .	10
Connecting Unbalanced Input Source and Output Device . . . . .	10

## 3. Operation

Operating the VE66DTH over an IP LAN . . . . .	11
Firmware Upgrades . . . . .	11
Downloading the Firmware Upgrade Package . . . . .	11
Starting the Upgrade . . . . .	12
Dante Firmware Update Manager . . . . .	12
Firmware Upgrade Tool . . . . .	13
Web GUI . . . . .	14
Looking Up the Login IP Address . . . . .	14
Logging In . . . . .	15
Upgrading the Firmware . . . . .	17
Uploading SSL Certificate . . . . .	21
Access Control . . . . .	22
Converting Analog Signal into Dante™ Signal . . . . .	23

Dante Interface Transceiver . . . . . 24

**Appendix**

Safety Instructions. . . . . 25  
    General . . . . . 25  
    Rack Mounting . . . . . 27  
Technical Support . . . . . 28  
    International . . . . . 28  
    North America . . . . . 28  
Specifications . . . . . 29  
Limited Warranty . . . . . 31

## About this Manual

---

This user manual is provided to help you get the most from the VE66DTH unit. It covers all aspects of installation, configuration, and operation. An overview of the information found in the manual is provided below.

**Chapter 1, *Introduction*** introduces you to the 6 x 6 Dante Audio Interface with HDMI. Its purpose, features, installation considerations, and panel components are presented and described.

**Chapter 2, *Hardware Setup*** describes the steps that are necessary to quickly and safely set up your installation.

**Chapter 3, *Operation*** explains the firmware upgrade utility, web GUI, and additional applications.

**An *Appendix*** provides a list of safety instructions and precautions, contact information for ATEN technical support, product specifications, and other technical information.

---

### Note:

- ◆ Read this manual thoroughly and follow the installation and operation procedures carefully to prevent any damage to the unit or any connected devices.
  - ◆ ATEN regularly updates its product documentation for new features and fixes. For an up-to-date VE66DTH documentation, visit <http://www.aten.com/global/en/>
-

## Conventions

---

This manual uses the following conventions:

- |   |  |
|---|--|
| Monospaced  | Indicates text that you should key in.   |
| [ ]   | Indicates keys you should press. For example, [Enter] means to press the <b>Enter</b> key. If keys need to be chorded, they appear together in the same bracket with a plus sign between them: [Ctrl+Alt]. |
| 1.  | Numbered lists represent procedures with sequential steps.   |
| ◆   | Bullet lists provide information, but do not involve sequential steps.   |
| →   | Indicates selecting the option (on a menu or dialog box, for example), that comes next. For example, Start → Run means to open the <i>Start</i> menu, and then select <i>Run</i> .                         |
|  | Indicates critical information.  |



## Product Information

---

For information about all ATEN products and how they can help you connect without limits, visit ATEN on the Web or contact an ATEN Authorized Reseller. Visit ATEN on the Web for a list of locations and telephone numbers:

International	<a href="http://www.aten.com">http://www.aten.com</a>
North America	<a href="http://www.aten-usa.com">http://www.aten-usa.com</a>

This Page Intentionally Left Blank

# Chapter 1

## Introduction

### Overview

---

ATEN VE66DTH is a Dante-enabled six-input/six-output Audio Interface with HDMI. Using Dante™ – the most popular audio networking solution created by Audinate, the VE66DTH is capable of delivering uncompressed, close-to-zero latency digital audio signals across your standard IP network. The VE66DTH transmits and receives up to 6-channel of audio inputs and outputs via a Dante network— the audio inputs can support not only the line input but also the dynamic and condenser microphones at the same time. Additionally, the device can also provide condenser microphones with 48V Phantom power supply. With its built-in PoE (Power over Ethernet), the VE66DTH can be powered by a compatible PSE device through Ethernet cable. Moreover, the VE66DTH provides flexible audio capability with audio de-embedding and embedding. It can de-embed HDMI stereo audio signals to the Dante networking system and embed Dante audio signals into the HDMI output.

The VE66DTH is tailor-made to a wide range of environments, such as conference centers, concert halls, entertainment facilities or wherever that requires implantation of Dante-based professional audio devices for extended and flexible networked AV applications. Users of the VE66DTH can benefit from improved system performance, reduction in cabling and more to installations of all sizes.

## Features

---

- ◆ Features Dante™ networked audio interface – a complete audio networking solution that distributes uncompressed, multi-channel audio transmission via standard Ethernet networks, with near-zero latency and perfect synchronization
- ◆ Integrates up to 6-channel balanced mono audio Line/Mic input signals onto a Dante-enabled audio system and supports both dynamic and condenser microphones
- ◆ Provides 48V Phantom power supply to condenser microphones
- ◆ AES67 support
- ◆ Easy to use and set up – User can use “Dante Controller” for the simple setup
- ◆ Delivers up to 6-channel balanced mono audio Line outputs from the Dante network to the audio system
- ◆ Supports HDMI input with HDCP 2.2 compliant— the HDMI input can de-embed HDMI stereo audio to the Dante network
- ◆ Supports HDMI local output—the VE66DTH can embed the Dante audio into HDMI output
- ◆ Supports PoE – power can be supplied by a compatible PSE device through Ethernet cable

## Planning the Installation

### Requirements

Prepare the following before installing the VE66DTH unit:

- ◆ 1 HDMI source device
- ◆ 1 HDMI display
- ◆ 1 to 6 Audio source
- ◆ 1 Audio mixer amplifier & speaker
- ◆ 1 Cat 5e/6/6a, ATEN 2L-2801 Cat 5e, or ATEN 2L-2910 Cat 6 cable

### Considerations

- ◆ The maximum transmission distance varies at different parts of the transmission:

Connection	Interface	Distance
HDMI source to the VE66DTH	HDMI	3 m
VE66DTH to the HDMI display	HDMI	3 m

- ◆ Audio
  - ◆ Phantom power is used with condenser microphones. Dynamic microphones and line input do not require power.
  - ◆ To avoid damaging your unbalanced dynamic microphones and line input, do not turn on the phantom power on your VE66DTH. Verify whether your condenser microphones will safely operate at +48V DC.
  - ◆ Make sure the +48V phantom power is off when you connect a line level source.
  - ◆ Make sure the condenser microphones are connected before turning on the phantom power on your VE66DTH.



## Components

### VE66DTH Front View

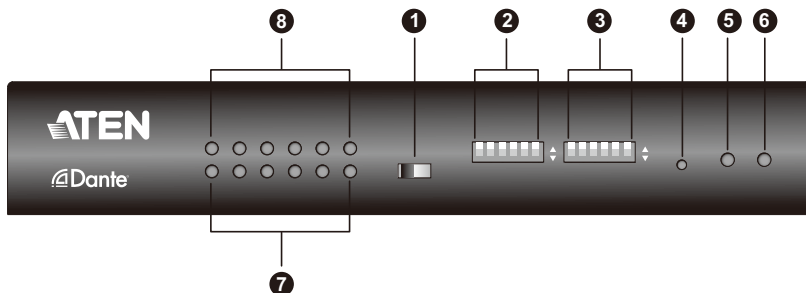

No.	Component	Description
1	HDMI Out Audio Selection Switch	Press the switch to send out the HDMI audio source.
2	Mic Input Pre-Amp Switch	Switch to enable and send out the Pre-Amp audio inputs.
3	Mic Input PHANTOM Power Switch	Switch to enable and send out the PHANTOM Power audio inputs.
4	Reset Button	Press and hold this button for more than 8 seconds to reset the VE66DTH to its factory default settings.

### System Status LEDs

You can find the unit's LEDs on the top and front panel as illustrated below. See the table below for details on LED indication.

No.	LED	Indication	Description
5	Dante Link LED	Lights orange	The connection to the Dante or AES67 link is stable.
		Off	There is no connection to the Dante or AES67 link.
6	Power LED	Lights green	The unit is receiving power.
		Off	There is no power supply to the unit.

No.	LED	Indication	Description
7	Audio Line Output Status LEDs	Lights orange	The audio signal is transmitting.
		Off	The audio signal is not transmitting.
8	Audio Mic/Line Input Status LEDs	Lights orange	The audio signal is transmitting.
		Off	The audio signal is not transmitting.

**Note:**

- ◆ The Audio Mic/Line Input Status LED blinks to indicate that the firmware upgrade is in progress.

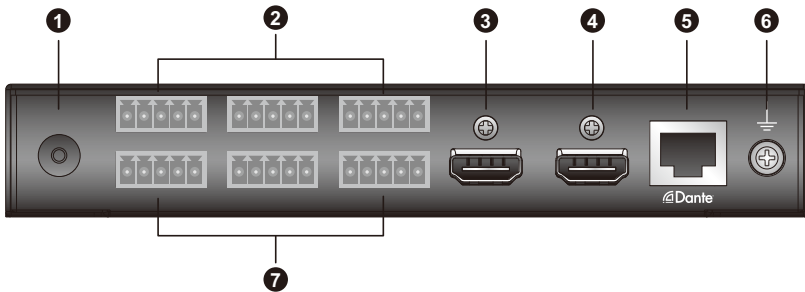
**VE66DTH Rear View**

No.	Component	Description
1	Power Jack	Connects to the Power Adapter.
2	Audio Mic/Line Input Ports	Connect the cables from your audio source device to these ports.
3	HDMI Output Port	Connects to an HDMI-enabled display device.
4	HDMI Input Port	Connects to an HDMI source device via an HDMI cable.
5	Dante Link Port (Ethernet)	Connects to an Ethernet cable for Dante or AES67 link. <b>Note:</b> The Dante or AES67 Link supports PoE.
6	Grounding Terminal	Grounds the VE66DTH to prevent damages from power surge or static electricity.
7	Audio Line Output Port	Connect to audio output devices via audio cables.

This Page Intentionally Left Blank



# Chapter 2

## Hardware Setup



1. Please review the safety information regarding the placement of this device in *Safety Instructions*, page 25.
2. Do not power on the VE66DTH until all the necessary hardware is connected.

### Rack Mounting the VE66DTH Unit

---

#### Rack Mounting

Use the VE-RMK 1U Rack Mount Kit to rack-mount the VE66DTH. For more information about this accessory, go to [www.aten.com/products](http://www.aten.com/products)

For convenience and flexibility, the VE66DTH can be mounted on system racks. To rack mount a unit, follow the steps below.

1. Screw the mounting bracket into the bottom of the unit as shown in the diagram below.

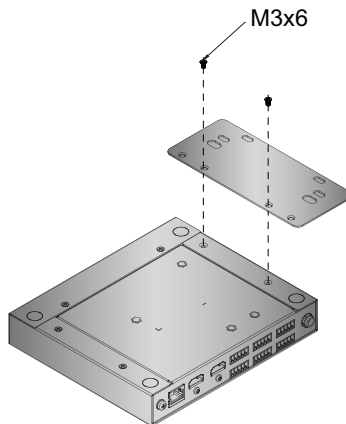

2. Screw the bracket into any convenient location on the rack.

---

**Note:** The screws are not provided. We recommend that you use M5 x 12 Philips Type I cross, recessed type screws.

---

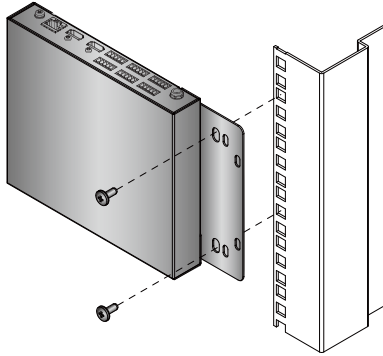

## Connecting the VE66DTH Unit

Follow the steps below to connect the VE66DTH to audio and HDMI sources, an HDMI display, and other controls as required.

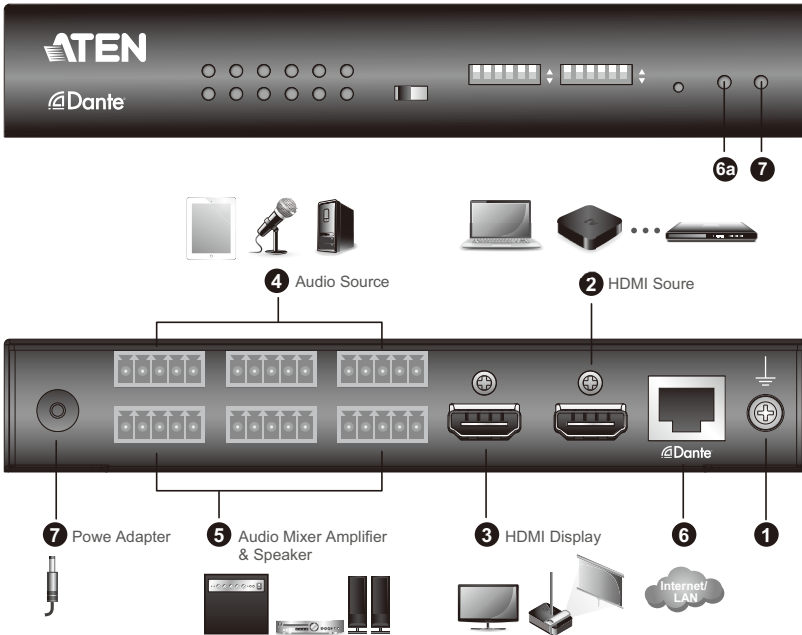

1. Ground the VE66DTH by connecting one end of a grounding wire to the ground terminal and the other end to a suitable grounded object.

**Note:** Do not omit this step. Proper grounding helps to prevent damage to the unit from power surges or static electricity.

2. Use an HDMI cable to connect an HDMI source to the HDMI Input Port.
3. Use an HDMI cable to connect an HDMI-enabled display.
  - ◆ The HDMI output audio could be selected from Local HDMI input, Dante Audio input, or mute.

**Note:** The HDMI output will be terminated, if the Local HDMI input is unplugged or without any input signal.

4. Connect up to six audio in sources to the Mic / Line Input Ports. See *Connecting Balanced Inputs Source and Output Device* and *Connecting Unbalanced Input Source and Output Device*, page 10 for more information.

**Note:** Please turn on the Pre-Amp or Phantom Power if necessary.

5. Connect to the speakers, audio mixer or amplifier up to six channels to the Line Output Ports. See *Connecting Balanced Inputs Source and Output Device* and *Connecting Unbalanced Input Source and Output Device*, page 10 for more information.
6. To allow Dante audio over IP matrix and extension application. Use an Ethernet cable to connect the Dante Link Port to a network switch.
  - a) The Dante Link LED lights solid orange when the connection is stable.
7. (Optional) Plug the Power Adapter cable into the Power Jack on the VE66DTH. The VE66DTH can be powered on via an Ethernet cable if the Dante Link Port (Ethernet) is connected to a PoE network switch. The Power LED lights solid green when the power supply is stable.

---

**Note:** The VE66DTH prioritizes the power supply from the power adapter when the Power Adapter is plugged in. If you wish to power the unit through an Ethernet cable, unplug the Power Adapter cable from the Power Jack on the VE66DTH.

---

8. Power on all the connected devices.

### **Connecting Balanced Inputs Source and Output Device**

When connecting a balanced input source or output device, make sure to connect + Positive pin to the +, - Negative pin to the -, and Ground pin to the GND as illustrated below.

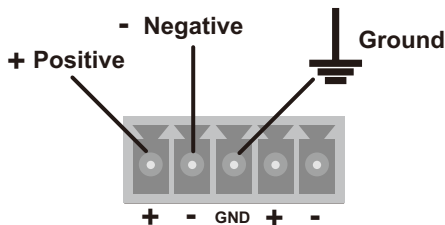

### **Connecting Unbalanced Input Source and Output Device**

When connecting an unbalanced input source or output device, make sure to connect + Positive pin to the +, and Ground pin to the GND as illustrated below.

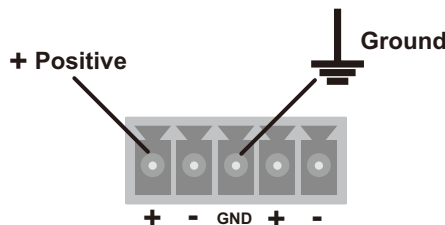

# Chapter 3

## Operation

### Operating the VE66DTH over an IP LAN

---

The VE66DTH is operated over an IP LAN. Setting up the units on a network allows point to- point, point-to-multipoint, and multipoint-to-multipoint computer to console operation by connecting multiple VE66DTH or Dante built-in devices on the same IP LAN. User can download the Dante Controller to the setup from the ATEN VE66DTH product page or the Audinate official website below.

<http://www.audinate.com/products/software/dante-controller?lang=en>

### Firmware Upgrades

---

The purpose of the Windows-based Firmware Upgrade Utility is to provide an easy process for upgrading the VE66DTH. The program comes as part of a Firmware Upgrade Package that is specific for each device.

As new firmware versions become available, new firmware upgrade packages are posted on our website. Check the website regularly to find the latest information and packages.

### Downloading the Firmware Upgrade Package

To download the firmware upgrade package, follow the steps below.

1. Go to the download link below:  
<https://www.aten.com/global/en/supportcenter/downloads/>
2. Type in VE66DTH in the field below “Download materials for other products” and press **OK**.
3. Choose the firmware upgrade package that you wish to install (usually the most recent) and download it to your computer.

## **Starting the Upgrade**

There are two subsystems that needed to be upgraded for the VE66DTH. To upgrade the firmware of your VE66DTH, follow the steps below.

1. For the first subsystem, upgrade the VE66DTH with firmware *VE66DTH\_upgrade\_V1.0.0XX.img* using Web GUI or Firmware Upgrade Tool.
  - ◆ Web GUI: The VE66DTH's firmware can be upgraded through the VE66DTH's Web GUI. To upgrade the firmware of your VE66DTH through the Web GUI, see *Upgrading the Firmware*, page 17.
  - ◆ Firmware Upgrade Tool: The VE66DTH's firmware can be upgraded through the Firmware Upgrade Tool. To upgrade the firmware of your VE66DTH through the Firmware Upgrade Tool, download the Firmware Upgrade Tool from our website. For detailed steps, see *Firmware Upgrade Tool*, page 13.
2. For the second subsystem, upgrade the Dante Module with firmware *dante\_V1.0.0XX.dnt* using the Dante Firmware Update Manager. For more details, see *Dante Firmware Update Manager*, page 12.

## **Dante Firmware Update Manager**

The Dante Module is controlled by the Dante Controller. For more details and to download the Dante Controller, refer to the Audinate official website below.

<http://www.my.audinate.com/products/software/dante-controller>

To upgrade the firmware of your VE66DTH through the Dante Firmware Update Manager, download the Dante Firmware Update Manager from the Audinate official website below.

<http://www.my.audinate.com/latest-firmware-update-manager>

For more details on how to use the Audinate Dante Firmware Update Manger, refer to the user guide below.

[http://www.my.audinate.com/system/files/release/AUD-MAN-Firmware\\_Update\\_Manager-v2.7.pdf](http://www.my.audinate.com/system/files/release/AUD-MAN-Firmware_Update_Manager-v2.7.pdf)

## Firmware Upgrade Tool

1. Go to the download link below:  
<https://www.aten.com/global/en/supportcenter/downloads/>
2. Type in VE66DTH in the field below “Download materials for other products” and press **OK**.
3. Scroll down the page to find Firmware upgrade tool zip file under “Software & Drivers”. Click the file to download.
4. Unzip and execute the downloaded Firmware Upgrade Tool.
5. Follow the on-screen instructions to install the Firmware Upgrade Tool.
6. Execute the Firmware Upgrade Tool and wait for the scanning to finish.
7. Select your VE66DTH from the device list and follow the on-screen instructions to upgrade the firmware.

## Web GUI

---

The ATEN VE66DTH can be remotely configured via web GUI, accessed through a web browser and allows you to perform firmware upgrade, upload SSL certificate, and setup access control for IP Installer.

### Looking Up the Login IP Address

Follow the steps below to download IP Installer utility, and use the utility to look up the IP address of your VE66DTH.

1. Go to the download link below:  
<https://www.aten.com/global/en/supportcenter/downloads/>
2. Type in VE66DTH in the field below “Download materials for other products” and press **OK**.
3. Scroll down the page to find IP Installer zip file under “Software & Drivers”. Click the file to download.
4. Unzip and execute the downloaded IP Installer. The Network Device IP Installer screen appears.
5. Click **Enumerate** to search for ATEN devices in the network. The detected devices are shown in Device List.
6. Use the IP address of VE66DTH to log into the web GUI for firmware upgrade.

---

**Note:** The VE66DTH will not be discovered by the IP Installer if the Access Control is set to Disable. See *Access Control*, page 22.

---



## Logging In

On a computer with web access, open a web browser and type the IP address you obtained using IP Installer Utility. This screen appears.

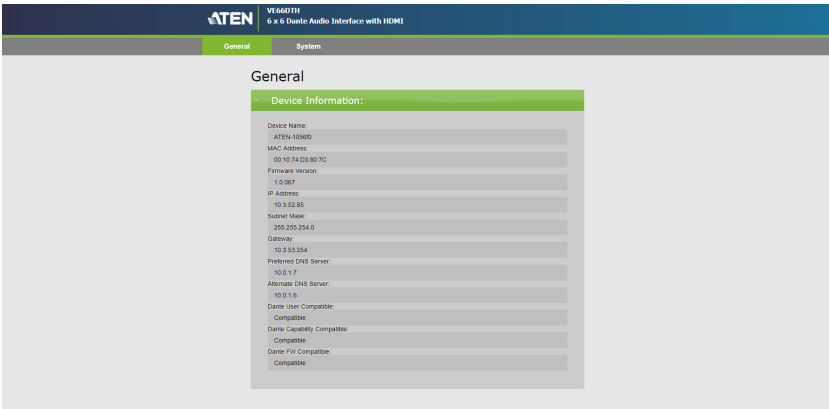

System Settings		Description
General	Device Name	Indicates the device name of the VE66DTH.
	MAC Address	Indicate the MAC address of the VE66DTH.
	Firmware Version	Indicates the device firmware version of the VE66DTH.
	IP Address	Indicates the IP address of theVE66DTH.
	Subnet Mask	Indicates the subnet mask of theVE66DTH.
	Gateway	Indicates the gateway of theVE66DTH.
	Preferred DNS Server	Indicates the preferred DNS server of theVE66DTH.
	Alternate DNS Server	Indicates the alternate DNS server of theVE66DTH.
	Dante User Compatible	Shows the compatibility between the Dante User and the VE66DTH. <ul style="list-style-type: none"> <li>◆ Compatible: The Dante User and the VE66DTH is compatible.</li> <li>◆ Non Compatible: The Dante User and the VE66DTHis not compatible. Please download and upgrade the firmware to <i>dante_V1.0.0XX.dnt</i> through the Dante Firmware Update Manager. See <i>Dante Firmware Update Manager</i>, page 12.</li> </ul>
	Dante Capability Compatible	Shows the compatibility between the Dante Capability and the VE66DTH. <ul style="list-style-type: none"> <li>◆ Compatible: The Dante Capatibility and the VE66DTH is compatible.</li> <li>◆ Non Compatible: The Dante Capability and the VE66DTHis not compatible. Please download and upgrade the firmware to <i>dante_V1.0.0XX.dnt</i> through the Dante Firmware Update Manager. See <i>Dante Firmware Update Manager</i>, page 12.</li> </ul>
Dante FW Compatible	Shows the compatibility between the Dante Firmware and the VE66DTH. <ul style="list-style-type: none"> <li>◆ Compatible: The Dante Firmware and the VE66DTH is compatible.</li> <li>◆ Non Compatible: The Dante Firmware and the VE66DTHis not compatible. Please download and upgrade the firmware to <i>dante_V1.0.0XX.dnt</i> through the Dante Firmware Update Manager. See <i>Dante Firmware Update Manager</i>, page 12.</li> </ul>	

## Upgrading the Firmware

To upgrade the firmware of your VE66DTH, follow the steps below.

1. From the VE66DTH's web GUI, select **System**.

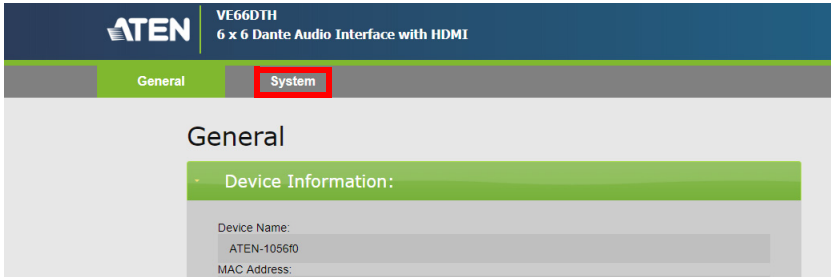

2. The System page appears.

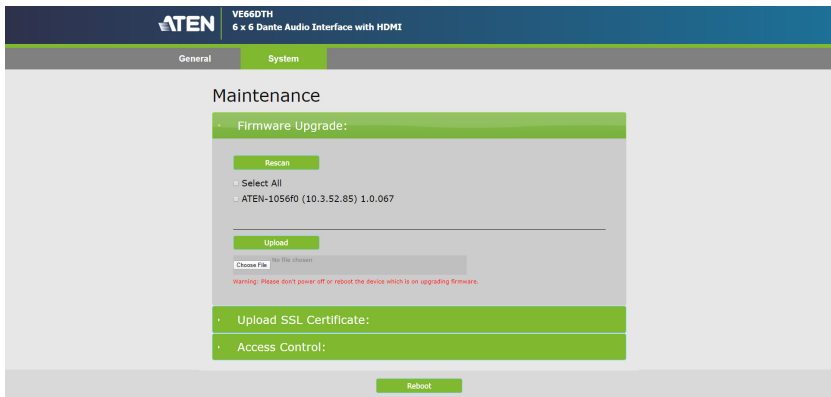

3. Check the VE66DTH you wish to upgrade, or check the *Select All* to upgrade all the VE66DTHs in the network, then click **Choose File**.

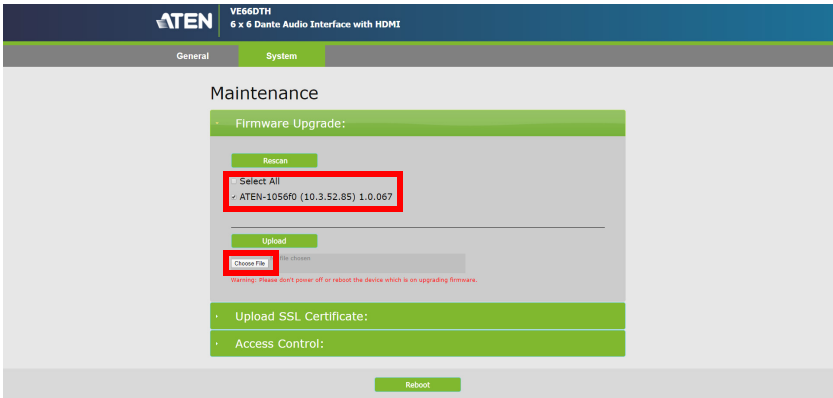

4. Select the downloaded firmware file and click **Open**.

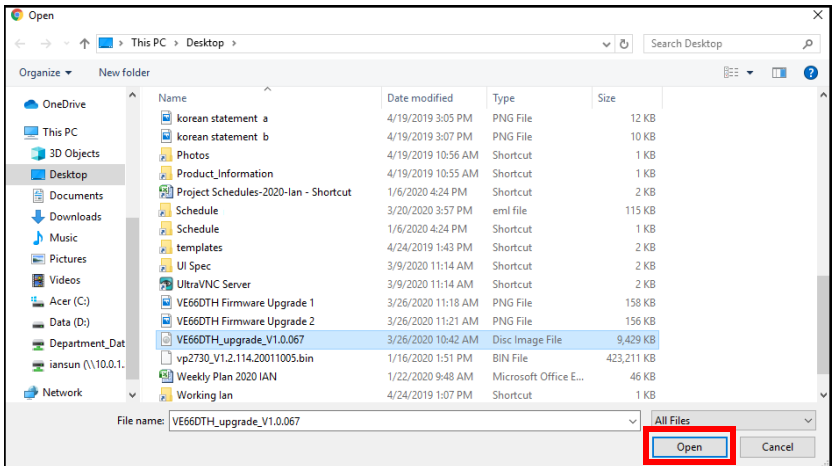

- Click **Upload** to begin to firmware upgrade.

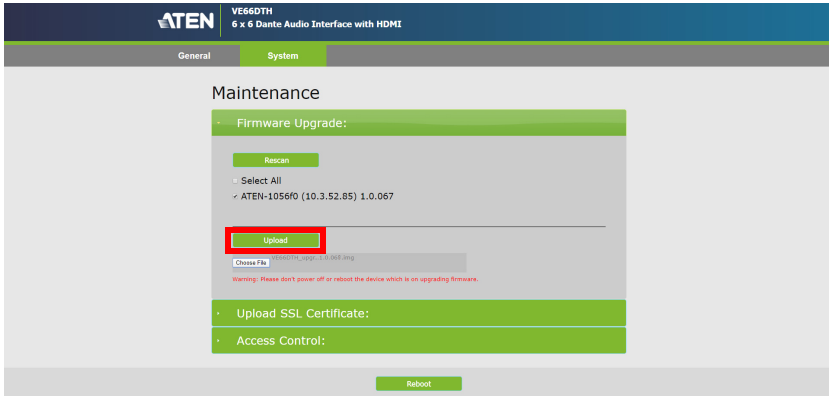

- Wait for the firmware upgrade process to finish.

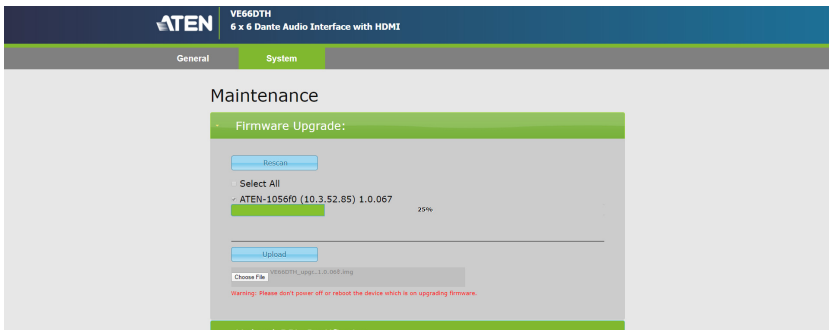

- The VE66DTH will reboot itself after the firmware upgrade has completed.

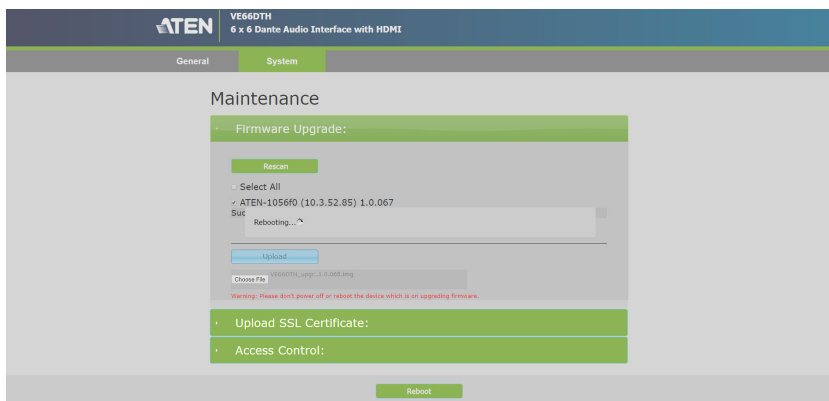

8. Now the VE66DTH has rebooted, and the firmware upgrade was successful.

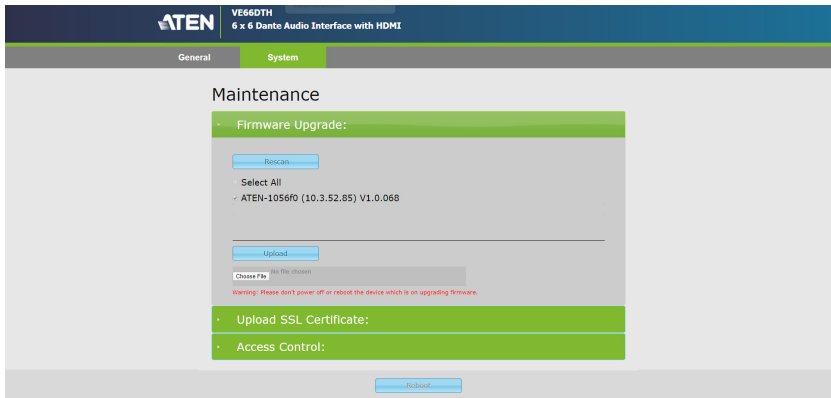

## Uploading SSL Certificate

To secure the audio output and sessions for the VE66DTH, you can apply SSL encryption.

**Note:** Before you begin to encrypt SSL, you are required to purchase an SSL certificate from a trusted certificate authority and save the files to a computer with access to the VE66DTH's web interface.

To upload an SSL certificate, follow the steps below.

1. From the System page, select **Upload SSL Certificate**. This screen appears.

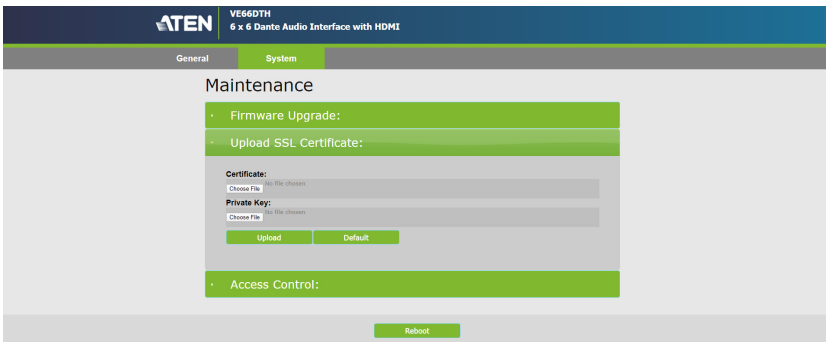

2. Select **Choose File** under Certificate to upload the SSL certificate.
  3. Select **Choose File** under Private Key to upload the SSL private key.
  4. Click **Upload**.
- ◆ If the SSL certificate have not been configured, a warning message appears every time you enter the VE66DTH's web GUI. Click **Advanced** and select **Proceed to with IP address**.

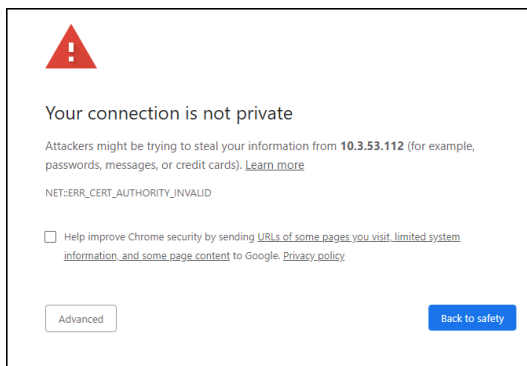

## Access Control

Access control allows you to set the accessibility for the IP Installer to discover the VE66DTH in your local network. To allow the installed VE66DTH to be discovered by the IP Installer, follow the steps below.

1. From the System page, select **Access Control**. This screen appears.

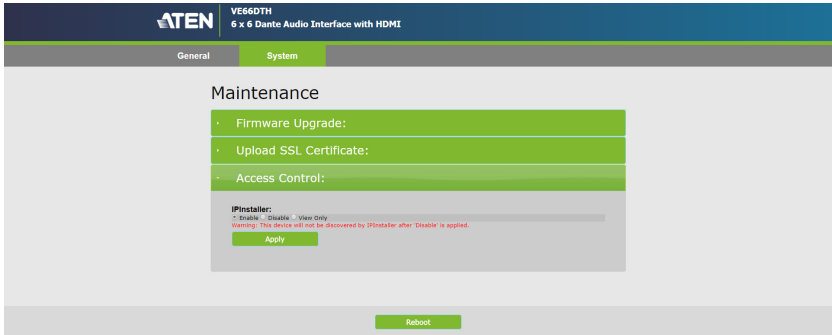

2. Select **Enable** and click **Apply**.
  - ◆ Enable: Allows the VE66DTH to be configured, and discovered by the IP Installer.
  - ◆ Disable: Disallows the VE66DTH to be discovered by the IP Installer.
  - ◆ View Only: Only allows the VE66DTH to be discovered by the IP Installer.



## Converting Analog Signal into Dante™ Signal

Please refer the diagram below to convert an analog signal into a Dante™ signal.

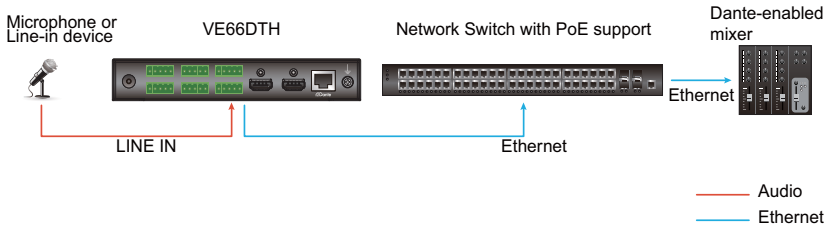

**Note:** The VE66DTH is used to integrate up to 6 analog LINE signals into a Dante™ networking system.

Please refer the diagram below to convert a Dante™ signal into an analog signal.

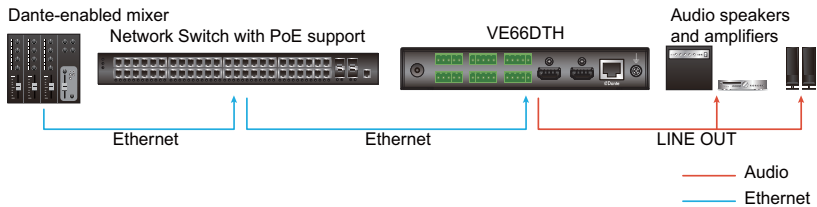

**Note:** Via the VE66DTH, audio speakers and amplifiers that do not support Dante™ networked audio interface can be integrated into a Dante™ networking system.

## Dante Interface Transceiver

The VE66DTH can be used as a Dante Interface as a transmitter and a receiver. If it is used as a transmitter, it could connect audio inputs devices to Dante Cloud. If it is used as a receiver, it could extend the audio output with non-Dante implemented audio mixer and amplifier.

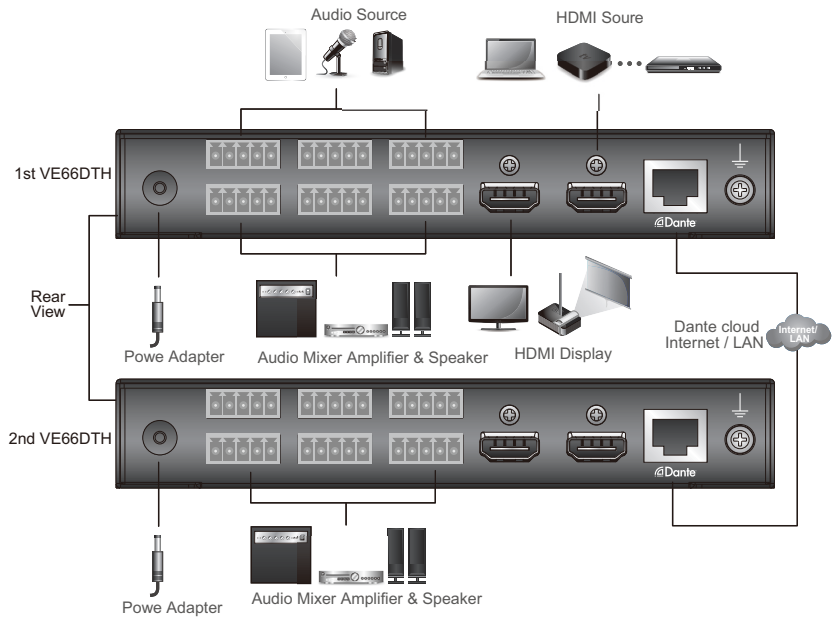

## Safety Instructions

---

### General

- ◆ This product is for indoor use only.
- ◆ Read all of these instructions. Save them for future reference.
- ◆ Follow all warnings and instructions marked on the device.
- ◆ Do not place the device on any unstable surface (cart, stand, table, etc.). If the device falls, serious damage will result.
- ◆ Do not use the device near water.
- ◆ Do not place the device near, or over, radiators or heat registers.
- ◆ The device cabinet is provided with slots and openings to allow for adequate ventilation. To ensure reliable operation, and to protect against overheating, these openings must never be blocked or covered.
- ◆ The device should never be placed on a soft surface (bed, sofa, rug, etc.) as this will block its ventilation openings. Likewise, the device should not be placed in a built in enclosure unless adequate ventilation has been provided.
- ◆ Never spill liquid of any kind on the device.
- ◆ Unplug the device from the wall outlet before cleaning. Do not use liquid or aerosol cleaners. Use a damp cloth for cleaning.
- ◆ The device should be operated from the type of power source indicated on the marking label. If you are not sure of the type of power available, consult your dealer or local power company.
- ◆ To prevent damage to your installation it is important that all devices are properly grounded.
- ◆ Do not allow anything to rest on the power cord or cables. Route the power cord and cables so that they cannot be stepped on or tripped over.
- ◆ Position system cables and power cables carefully; Be sure that nothing rests on any cables.
- ◆ Never push objects of any kind into or through cabinet slots. They may touch dangerous voltage points or short out parts resulting in a risk of fire or electrical shock.
- ◆ Do not attempt to service the device yourself. Refer all servicing to qualified service personnel.
- ◆ If the following conditions occur, unplug the device from the wall outlet and bring it to qualified service personnel for repair.

- ◆ The power cord or plug has become damaged or frayed.
- ◆ Liquid has been spilled into the device.
- ◆ The device has been exposed to rain or water.
- ◆ The device has been dropped, or the cabinet has been damaged.
- ◆ The device exhibits a distinct change in performance, indicating a need for service.
- ◆ The device does not operate normally when the operating instructions are followed.
- ◆ Only adjust those controls that are covered in the operating instructions. Improper adjustment of other controls may result in damage that will require extensive work by a qualified technician to repair.

## **Rack Mounting**

- ◆ Before working on the rack, make sure that the stabilizers are secured to the rack, extended to the floor, and that the full weight of the rack rests on the floor. Install front and side stabilizers on a single rack or front stabilizers for joined multiple racks before working on the rack.
- ◆ Always load the rack from the bottom up, and load the heaviest item in the rack first.
- ◆ Make sure that the rack is level and stable before extending a device from the rack.
- ◆ Use caution when pressing the device rail release latches and sliding a device into or out of a rack; the slide rails can pinch your fingers.
- ◆ After a device is inserted into the rack, carefully extend the rail into a locking position, and then slide the device into the rack.
- ◆ Do not overload the AC supply branch circuit that provides power to the rack. The total rack load should not exceed 80 percent of the branch circuit rating.
- ◆ Make sure that all equipment used on the rack – including power strips and other electrical connectors – is properly grounded.
- ◆ Ensure that proper airflow is provided to devices in the rack.
- ◆ Ensure that the operating ambient temperature of the rack environment does not exceed the maximum ambient temperature specified for the equipment by the manufacturer.
- ◆ Do not step on or stand on any device when servicing other devices in a rack.

## Technical Support

---

### International

- ◆ For online technical support – including troubleshooting, documentation, and software updates: <http://support.aten.com>
- ◆ For telephone support, see *Telephone Support*, page iii:

### North America

Email Support		support@aten-usa.com
Online Technical Support	Troubleshooting Documentation Software Updates	<a href="http://www.aten-usa.com/support">http://www.aten-usa.com/support</a>
Telephone Support		1-888-999-ATEN ext 4988

When you contact us, please have the following information ready beforehand:

- ◆ Product model number, serial number, and date of purchase
- ◆ Your computer configuration, including operating system, revision level, expansion cards, and software
- ◆ Any error messages displayed at the time the error occurred
- ◆ The sequence of operations that led up to the error
- ◆ Any other information you feel may be of help

## Specifications

Function	VE66DTH
<b>Audio Inputs</b>	
Interfaces	Line/Mic Input: 3 x 3.5 mm Captive Screw Connector, 5-Pole; Analog Mono, Balanced
	Impedance: >6.8k ohms unbalanced; >13.6k ohms Balanced
	Max. Level: 0 dBV (1Vrms)
	Mic Pre-Amp: +40 dB, Balanced
	Phantom Power: +48V, 10mA
	HDMI Input: HDMI Stereo Audio
<b>Audio Outputs</b>	
Interfaces	Line Output: 3 x 3.5 mm captive Screw Connector, Analog Mono, Balanced
	Impedance: 50 ohms Unbalanced, 100 ohms Balanced
	Max. Level: 0 dBV (1Vrms)
	HDMI Output: HDMI Stereo Audio
<b>Audio</b>	
Format	Uncompressed, 24-bit, selectable at 44.1, 48, 88.2, or 96kHz
	Latency: Deterministic, based on user selection: 1.0 ms (default)
	Frequency Response: 20Hz ~ 20kHz, +/- 0.3dB
	THD + Noise: < -65dB (0.1%) (1kHz, 1Vrms @ 0dBV)
	S/N: > 80dB (1kHz, 1Vrms @ 0dBV)
	Cross Talk: < -50dB (15kHz, 1Vrms @ 0dBV)
Input	8 Audio Channels (6 x Analog Input & 1 x HDMI Stereo Audio)
Output	8 Audio Channels (6 x Analog Output & 1 x HDMI Stereo Audio Embedded from HDMI/Dante)
<b>Video Input</b>	
Interfaces	1 x HDMI Type A Female (Black) 1 x HDB-15 (VGA) Male (Blue)
Impedance	HDMI: 100 $\Omega$
Max. Distance	1.8 m
<b>Video Output</b>	
Interfaces	1 x HDMI Type A Female (Black)

<b>Function</b>	<b>VE66DTH</b>
Impedance	HDMI: 100 $\Omega$
<b>Video</b>	
Max. Resolutions	HDMI: ♦Up to 4096 x 2160 / 3840 x 2160 @60Hz (4:4:4)
Compliance	HDMI (3D, Deep Color, 4K); 4K HDR
	HDCP 2.2 Compatible
<b>Control</b>	
Ethernet	1 x RJ-45 Female (Silver) through Dante
<b>Switches</b>	
Video Output Port Selection	1 x Slide Switch – HDMI Output Audio Selection (From HDMI In / Dante / Off)
Selection	6 x Slide Switch – Mic Input Pre-Amp ON/OFF
Phantom Power	6 x Slide Switch – Mic Input Phantom Power ON/OFF
Reset	1 x Pushbutton
<b>Connectors</b>	
Power	1 x DC Jack (Black) or, 1 x RJ-45 Female (Silver) PoE
Unit To Unit	1 x RJ-45 Female through Dante
<b>Power</b>	
Consumption	DC 5V; 8.9W; 41BTU DC48V; 11.1W; 52BTU
<b>Environmental</b>	
Operating Temperature	0 - 40°C
Storage Temperature	-20 - 60°C
Humidity	0 x 80% RH, Non-Condensing
<b>Physical Properties</b>	
Housing	Metal
Weight	0.85 Kg (1.87 lb)
Dimensions (L x W x H)	17.42 x 15.49 x 2.88 cm (6.86 x 6.10 x 1.13 in.)



## Limited Warranty

---

ATEN warrants its hardware in the country of purchase against flaws in materials and workmanship for a Warranty Period of two [2] years (warranty period may vary in certain regions/countries) commencing on the date of original purchase. This warranty period includes the [LCD panel of ATEN LCD KVM switches](#). Select products are warranted for an additional year (see [A+ Warranty](#) for further details). Cables and accessories are not covered by the Standard Warranty.

### **What is covered by the Limited Hardware Warranty**

ATEN will provide a repair service, without charge, during the Warranty Period. If a product is defective, ATEN will, at its discretion, have the option to (1) repair said product with new or repaired components, or (2) replace the entire product with an identical product or with a similar product which fulfills the same function as the defective product. Replaced products assume the warranty of the original product for the remaining period or a period of 90 days, whichever is longer. When the products or components are replaced, the replacing articles shall become customer property and the replaced articles shall become the property of ATEN.

To learn more about our warranty policies, please visit our website:  
<http://www.aten.com/global/en/legal/policies/warranty-policy/>