

Canon

RF

100-500mm F4.5-7.1 L IS USM

Instructions

ENG

Thank you for purchasing a Canon product.

Canon RF100-500mm F4.5-7.1 L IS USM is a telephoto zoom lens for use with EOS R series cameras.

- “IS” stands for Image Stabilizer.
- “USM” stands for Ultrasonic Motor.

Camera Firmware

Please use the latest version of firmware with the camera in use. For details on whether the firmware is the latest version or not, and for details on updating the firmware, please check the Canon website.

Conventions used in these instructions



Warning to prevent lens or camera malfunction or damage.



Supplementary notes on using the lens and taking pictures.

Safety Precautions

Precautions to ensure that the camera is used safely. Read these precautions thoroughly. Make sure all details are observed in order to prevent risks and injury to the user and other people.



Warning

Details pertaining to risks that may result in death or serious injury.

- **Do not look directly at the sun or other strong light sources through a lens.** This may result in loss of sight.
- **Do not leave a lens in the sun without the lens cap attached.** The lens may concentrate entering sunlight and cause a malfunction or fire.



Caution

Details pertaining to risks that may result in injury or damage to other objects.

- **Do not leave the product in places exposed to extremely high or low temperatures.** The product may cause burns or injury when touched.
- **Do not insert your hand or fingers into the product.** This may result in injury.
- **When using a tripod, please use one that has sufficient strength.**
- **Make sure that the lock knob on the tripod mount is firmly tightened.**

General Precautions

Handling Precautions

- Do not leave the product in excessive heat such as in a car in direct sunlight. High temperatures can cause the product to malfunction.
- If the lens is taken from a cold environment into a warm one, condensation may develop on the lens surface and internal parts. To prevent condensation in this case, first put the lens into an airtight plastic bag before taking it from a cold to warm environment. Then take out the lens after it has warmed gradually. Do the same when taking the lens from a warm environment into a cold one.
- The lens interior may appear to waver, but this does not indicate a defect or failure, and will not cause any problems in use.
- In order to optimize aperture control, there are occasions in which the diaphragm blades will move during zooming and focusing, even when the aperture value is set for aperture priority AE or manual exposure, etc.
- Please also read any lens related handling precautions listed in your camera's instruction manual.

This device complies with Part 15 of the FCC Rules.

Operation is subject to the following two conditions: (1) This device may not cause harmful interference, and (2) this device must accept any interference received, including interference that may cause undesired operation.

Do not make any changes or modifications to the equipment unless otherwise specified in the instructions. If such changes or modifications should be made, you could be required to stop operation of the equipment.

This equipment has been tested and found to comply with the limits for a class B digital device, pursuant to part 15 of the FCC Rules. These limits are designed to provide reasonable protection against harmful interference in a residential installation. This equipment generates, uses and can radiate radio frequency energy and, if not installed and used in accordance with the instructions, may cause harmful interference to radio communications.

However, there is no guarantee that interference will not occur in a particular installation. If this equipment does cause harmful interference to radio or television reception, which can be determined by turning the equipment off and on, the user is encouraged to try to correct the interference by one or more of the following measures:

- Reorient or relocate the receiving antenna.
- Increase the separation between the equipment and receiver.
- Connect the equipment into an outlet on a circuit different from that to which the receiver is connected.
- Consult the dealer or an experienced radio/TV technician for help.

Nomenclature

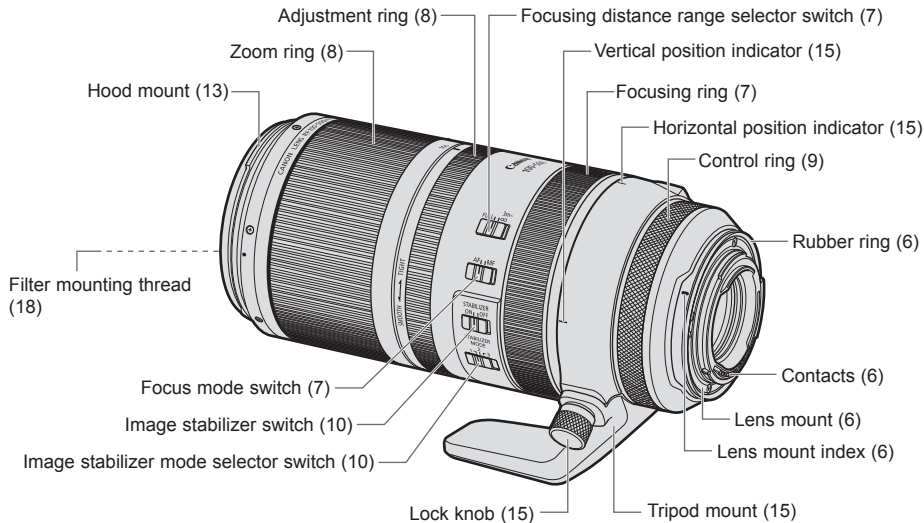

- For detailed information, reference page numbers are provided in parentheses (→ **).

1. Attaching and Detaching the Lens

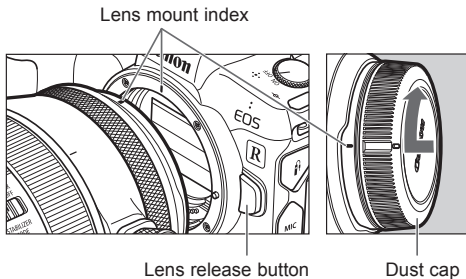

Attaching the Lens

Align the lens mount indexes of the lens and camera, and turn the lens clockwise until you hear a click.

Detaching the Lens

Turn the lens counterclockwise while pressing the camera's lens release button. Detach the lens once it has stopped turning.

Please refer to the camera's instructions for details.



- Set the camera's power switch to OFF when attaching or detaching the lens.
- Attach the lens cap before detaching the lens from the camera.
- After detaching the lens, place the lens with the rear end up and attach the dust cap to prevent the lens surface and contacts from getting scratched. Make sure the lens and dust cap mount indexes are aligned when attaching the dust cap.
- Contacts that are scratched, soiled, or have fingerprints on them may result in faulty connections or corrosion, which may lead to malfunctions. If the contacts get soiled, clean them with a soft cloth.
- The lens mount has a rubber ring to improve dust-resistance and water-resistance performance. This rubber ring may cause friction marks to appear around the camera's lens mount, although this will have no effect on usage.



- Rubber rings can be replaced at Canon Service Center. (chargeable)

2. Setting the Focus Mode

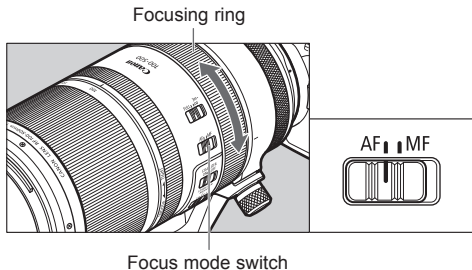

To shoot in autofocus (AF) mode, set the focus mode switch to AF.

To use only manual focusing (MF), set the focus mode switch to MF, and focus by turning the focusing ring.

- ⚠ Quickly turning the focusing ring may result in delayed focus.

- 📖 The lens' focusing ring is electronic.
- When AF operation is set to [ONE SHOT], manual focus is possible after autofocus has been completed by continuing to press the shutter button halfway. (Full-time manual focus) However, the camera settings need to be changed. Please refer to the camera's instructions for details.

3. Setting the Focusing Distance Range

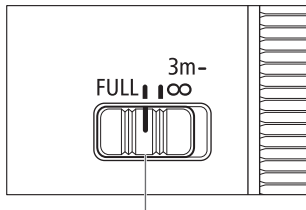

You can set the focusing distance range with a switch. Setting the focusing distance prevents the lens from focusing on unintentional subjects at different distances.

Focusing distance range

1. FULL

The minimum focusing distance differs depending on the distance set for lens focusing.

Set at 100 mm: 0.9 m/2.95 ft. - ∞

Set at 300 mm: 1 m/3.28 ft. - ∞

Set at 500 mm: 1.2 m/3.94 ft. - ∞

2. 3 m/9.84 ft. - ∞

4. Adjusting the Zoom and Zoom Ring Operational Feeling

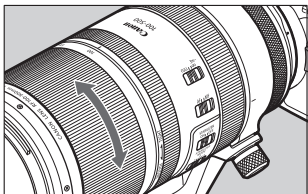

To zoom, turn the zoom ring.

- Be sure to finish zooming before focusing. Zooming after focusing can affect the focus.
- Blurring may temporarily occur if the zoom ring is quickly turned.
- Please be careful not to let your fingers get caught in between the lens' front and the zoom ring when zooming.

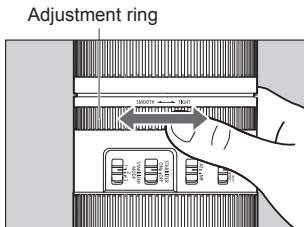

You can adjust the operational feeling (weight of movement) of the zoom ring to a preferred level. Turn the adjustment ring toward SMOOTH to lighten the feeling, and toward TIGHT to strengthen it.

- It is recommended that the adjustment ring is turned fully to the TIGHT setting when not in use to prevent the front of the lens from being unintentionally extended.
- If the lens is aimed upward or downward in the TELE setting with the adjustment ring set at SMOOTH, there are cases in which the lens will contract to the WIDE setting. Please be careful not to let your fingers get caught in between the lens' front and the zoom ring.

5. Control Ring

The control ring can be assigned the functions that are commonly used with cameras, such as shutter speed and aperture settings.

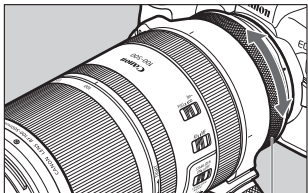

Control ring

The click action of the control ring allows you to have a sense of how much it is being turned. Please refer to the camera's instructions for details on how to use the control ring.



- There are cases in which the sound of control ring operations may be recorded when shooting movies.



- The clicking sensation of the control ring can be removed by the Canon Service Center. (chargeable)

6. Image Stabilizer

Image stabilization corrects vibrations that occurs with hand-held shots.

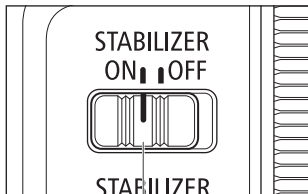

Image stabilizer switch

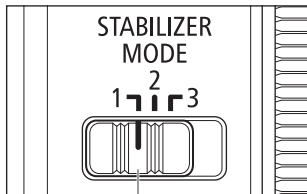

Image stabilizer mode selector switch

1 Set the STABILIZER switch to ON.

- If you are not going to use image stabilization, set the image stabilizer switch to OFF.

2 Select an Image Stabilizer mode according to the application and shooting conditions.

Image Stabilizer modes

- **MODE 1:** Corrects vibrations in all directions. It is suited to shooting still subjects.
- **MODE 2:** When you take a panning shot either horizontally or vertically, corrects vibrations at right angles to the direction of panning. It is suited to shooting moving subjects.
- **MODE 3:** During exposure, corrects vibrations in the same way as MODE 2. Since vibration is corrected only during exposure, It is suited to shooting irregularly moving subjects.

Image Stabilizer

The Image Stabilizer for this lens is suited to hand-held shots in the following conditions.

MODE 1

Shooting still subjects



- In semi-darkened areas such as indoors or outdoors at night.
- In locations where the flash cannot be used, such as art museums and theater stages.
- In situations where your footing is uncertain.
- In situations where fast shutter speed settings cannot be used.

MODE 2

Shooting moving subjects



- Panning shots of vehicles, trains, etc.

MODE 3

Shooting irregularly moving subjects



- Sports photography of soccer, basketball, etc.
- Photography of animals

Image Stabilizer

- The Image Stabilizer cannot compensate for a blurred shot caused by a subject that moved.
- The Image Stabilizer might not be fully effective in the following conditions:
 - Large shake or fast vibration
 - Panning in MODE 1
- When using a tripod, the Image Stabilizer might not be fully effective or it might be better to set the image stabilizer switch to OFF, depending on the type of tripod and where the tripod is located, as well as on the camera's settings such as shutter speed.
- Even with a monopod, the Image Stabilizer will be as effective as during hand-held shooting. However, depending on the shooting conditions, there are cases in which the Image Stabilizer effect may be less effective.

7. Hood

The custom lens hood cuts out unwanted light and protects the front of the lens from rain, snow, and dust.

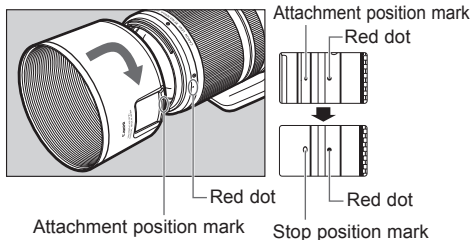

Attaching the Hood

Align the red attachment position mark on the hood with the red dot on the front of the lens, and then turn the hood in the direction of the arrow until you hear a click.

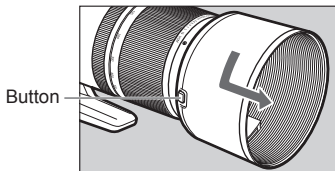

Detaching the Hood

Keep your finger pressed down on the button located on the side of the hood, and then turn the hood in the direction of the arrow until the attachment position mark on the hood is aligned with the red dot on the front of the lens to detach it.

The hood can be reverse-mounted on the lens for storage.

- If the hood is not attached properly, vignetting (darkening of the perimeter of the picture) may occur.
- Grasp and turn the base of the hood when attaching and detaching it. There are cases in which it may become deformed if the hood is turned with it grasped near to the rim.

Hood

The hood features a filter adjustment window which, when opened, allows the user to adjust the circular polarizing filter while the hood is attached to the lens.

Filter Adjustment Window

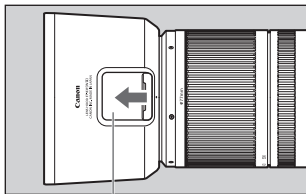

Filter adjustment window

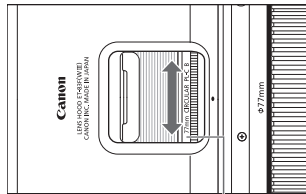

Circular polarizing filter

1 Open the filter adjustment window which is installed in the hood by sliding it forward.

2 Adjust the circular polarizing filter via the open filter adjustment window.

- Detach the hood when attaching or detaching the circular polarizing filter.
- Please close the filter adjustment window during shooting.

8. Tripod Mount

You can use the ring-type tripod mount F (WIII) supplied with the lens.
A tripod or monopod attaches to the tripod mount.

Attaching the Tripod Mount

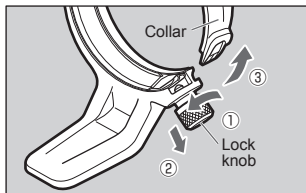

1 Open the collar of the tripod mount

- Turn the lock knob counterclockwise until it becomes loose (about 3 turns) (1).
- Pull the knob in the direction of the arrow (2) to release the collar (3).

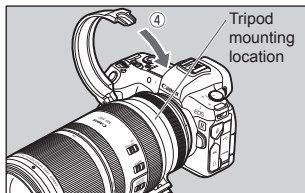

2 Attach tripod mount to lens

- With the collar open, insert it into the tripod mounting location on the lens and close the collar (4).

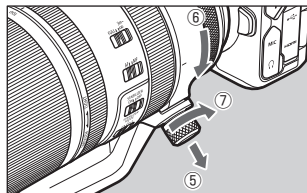

3 Fix tripod mount to lens

- While pulling the lock knob (5), insert the end of the open collar until it reaches its original position (6).
- Turn and tighten the lock knob, fixing it securely to the lens (7).

When removing the tripod mount, hold the camera and lens and remove the mount following the above procedure in reverse.

Switching the Orientation of the Image

By loosening the lock knob on the tripod mount you can rotate the camera and the lens to switch the image in any orientation (vertical, horizontal, etc.). Make sure that the lock knob is tightened after setting the camera in place.

9. Extenders (Sold separately)

It is possible to increase the size of the subject when shooting with the use of the RF1.4x and RF2x extenders.

Attaching



- First of all, use the zoom ring to set the focusing distance at between 300 mm and the TELE setting (500 mm).
 - Then attach the extender to the lens. The lens can be attached to the camera after this.
-  ● Attaching the extender forcibly with the focusing distance set between 300 mm and the WIDE setting may result in malfunctions or other damage.
- The range of zoom operations with the extender attached is within a focusing distance of 300 mm to 500 mm.
 - More than one extender cannot be used.
 - The range-finding area for this lens will differ depending on the combination of camera and extender in use. Please check the Canon website for further details.

Lens specifications when using extenders are as follows.

| RF1.4x | | MIDDLE (300 mm) | TELE |
|---------------------------|------------|--------------------|-------------|
| Focal Length (mm) | | 420 | 700 |
| Aperture | | f/8 - f/57 | f/10 - f/72 |
| Angle of view | Horizontal | 4°55' | 3° |
| | Vertical | 3°15' | 2° |
| | Diagonal | 5°55' | 3°30' |
| Maximum magnification (x) | | 0.37 | 0.46 |

| RF2x | | MIDDLE (300 mm) | TELE |
|---------------------------|------------|--------------------|-------------|
| Focal Length (mm) | | 600 | 1000 |
| Aperture | | f/11 - f/72 | f/14 - f/91 |
| Angle of view | Horizontal | 3°30' | 2° |
| | Vertical | 2°20' | 1°20' |
| | Diagonal | 4°10' | 2°30' |
| Maximum magnification (x) | | 0.54 | 0.66 |

Extenders (Sold separately)

-  ● If the focusing distance is set at 300mm when the extender is detached, there are cases in which it will not be possible to turn the zoom ring toward the WIDE setting from the 300mm point after it has been removed.
 - In either of these events, turn the zoom ring slightly toward the TELE setting to release the zoom ring so that it can be turned to the WIDE setting. You may hear a noise during this, but it will have no effect on operations.
-
-  ● The speed of the AF will be slower when an extender is in use on account of controllability.

10. Filters (Sold separately)

You can attach filters to the filter mounting thread on the front of the lens.



- Only one filter may be attached.
- If you need a polarizing filter, use the Canon Circular Polarizing Filter PL-C B.
- Please refer to p.14 for details on how to use the circular polarizing filter.

11. Close-up Lenses (Sold separately)

Attaching a 500D (77 mm) Close-up Lens enables close-up photography. It provides a magnification of 0.2x to 0.98x.



- Close-up Lens 250D cannot be attached because there is no size that fits the lens.
- MF mode is recommended for accurate focusing.

Specifications

| | |
|---------------------------------|--|
| Focal Length/Aperture | 100-500mm f/4.5-7.1 |
| Lens Construction | 14 groups, 20 elements |
| Maximum Aperture | f/4.5 - 7.1 (1/3 stops), f/4.5 - 6.7 (1/2 stops) |
| Minimum Aperture | f/32 - 51 (1/3 stops), f/32 - 54 (1/2 stops) |
| Angle of View | Horizontal: 20° - 4°, Vertical: 14° - 2° 45', Diagonal: 24° - 5° |
| Min. Focusing Distance | 0.9 m/2.95 ft. (at 100 mm), 1.2 m/3.94 ft. (at 500 mm) |
| Max. Magnification | 0.33x (at 500 mm) |
| Field of View | Approx. 282 x 188 mm/11.10 x 7.40 in. (at 100 mm, 0.9 m/2.95 ft.) Approx. 107 x 71 mm/4.21 x 2.80 in. (at 500 mm, 1.2 m/3.94 ft.) |
| Filter Diameter | 77 mm |
| Max. Diameter and Length | Approx. 93.8 x 207.6 mm/3.69 x 8.17 in. |
| Weight | Approx. 1370 g/48.32 oz. (excluding a tripod) |
| Hood | ET-83F (WIII) |
| Lens Cap | E-77 II |
| Case | LZ1328 |

- The lens length is measured from the mount surface to the front end of the lens.
Add 24.2 mm/0.95 in. when including the lens cap and dust cap.
- The size and weight listed are for the lens only.
- All data listed is measured according to Canon standards.
- Product specifications and appearance are subject to change without notice.

Canon