



OWNER'S MANUAL

Safety and Reference

(LED TV*)

* LG LED TV applies LCD screen with LED backlights.

Please read this manual carefully before operating your TV and retain it for future reference.

28TN515S 24TN510S

28TN525S 24TN520S

TABLE OF CONTENTS

LICENSES -----	3
OPEN SOURCE SOFTWARE NOTICE INFORMATION -----	3
PREPARING-----	3
SEPARATE PURCHASE-----	4
LIFTING AND MOVING THE TV-----	4
SETTING UP THE TV-----	5
USING THE BUTTON -----	5
MOUNTING ON A TABLE-----	6
MOUNTING ON A WALL-----	7
CONNECTIONS (NOTIFICATIONS)-----	8
REMOTE CONTROL-----	9
USER GUIDE-----	10
MAINTENANCE-----	11
TROUBLESHOOTING-----	11
SPECIFICATIONS-----	12

LICENSES

Supported licenses may differ by model. For more information about licenses, visit www.lg.com.



OPEN SOURCE SOFTWARE NOTICE INFORMATION

To obtain the source code under GPL, LGPL, MPL, and other open source licenses, that is contained in this product, please visit <http://opensource.lge.com>.

In addition to the source code, all referred license terms, warranty disclaimers and copyright notices are available for download.

LG Electronics will also provide open source code to you on CD-ROM for a charge covering the cost of performing such distribution (such as the cost of media, shipping, and handling) upon email request to opensource@lge.com.

This offer is valid for a period of three years after our last shipment of this product. This offer is valid to anyone in receipt of this information.

PREPARING

NOTE

- Image shown may differ from your TV.
- Your TV's OSD (On Screen Display) may differ slightly from that shown in this manual.
- The available menus and options may differ from the input source or product model that you are using.
- New features may be added to this TV in the future.
- The TV can be placed in standby mode in order to reduce the power consumption. And the TV should be turned off if it will not be watched for some time, as this will reduce energy consumption.
- The energy consumed during use can be significantly reduced if the level of brightness of the picture is reduced, and this will reduce the overall running cost.
- The items supplied with your product may vary depending on the model.
- Product specifications or contents of this manual may be changed without prior notice due to upgrade of product functions.
- For an optimal connection, HDMI cables and USB devices should have bezels less than 10 mm thick and 18 mm width. Use an extension cable that supports USB 2.0 if the USB cable or USB memory stick does not fit into your TV's USB port.

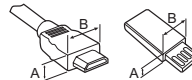

*A ≦ 10 mm

*B ≦ 18 mm

- Use a certified cable with the HDMI logo attached. If you do not use a certified HDMI cable, the screen may not display or a connection error may occur.
- Recommended HDMI cable types
 - Ultra High Speed HDMI[®]/™ cable (3 m or less)

⚠ CAUTION

- Do not use any unapproved items to ensure the safety and product life span.
- Any damage or injuries caused by using unapproved items are not covered by the warranty.

SEPARATE PURCHASE

Separate purchase items can be changed or modified for quality improvement without any notification. Contact your dealer to buy these items. These devices only work with certain models.

The model name or design may be changed depending on the upgrade of product functions, manufacturer's circumstances or policies.

Magic Remote Control

(Depending on model)

AN-MR19BA

Check whether your TV model supports Bluetooth in the Wireless Module Specification to verify whether it can be used with the Magic Remote.

LIFTING AND MOVING THE TV

Please note the following advice to prevent the TV from being scratched or damaged and for safe transportation regardless of its type and size.

- It is recommended to move the TV in the box or packing material that the TV originally came in.
- Before moving or lifting the TV, disconnect the power cord and all cables.
- When holding the TV, the screen should face away from you to avoid damage.
- Hold the top and bottom of the TV frame firmly. Make sure not to hold the transparent part, speaker, or speaker grill area.

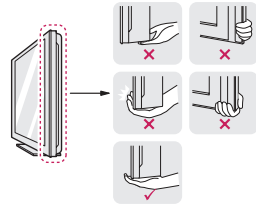

- When transporting the TV, do not expose the TV to jolts or excessive vibration.
- When transporting the TV, keep the TV upright, never turn the TV on its side or tilt towards the left or right.

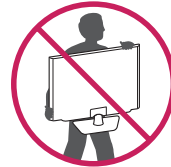

- Do not apply excessive pressure to cause flexing/bending of frame chassis as it may damage screen.

⚠ CAUTION

- Avoid touching the screen at all times, as this may result in damage to the screen.
- Do not carry the TV upside-down by holding the stand body (or stand base) as this may cause it to fall off, resulting in damage or injury.
- When handling the TV, be careful not to damage the protruding joystick button. (Depending on model)

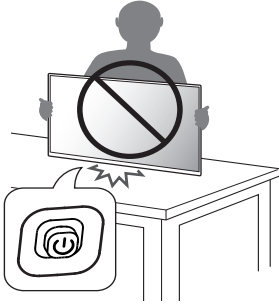
**USING THE BUTTON**

- You can operate your TV by pressing the button.
- Image shown may differ from your TV.

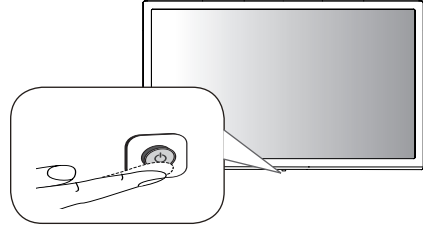



**Basic functions**

	Power On (Press)
	Power Off ¹ (Press and Hold)
	Menu Control (Press ²)
	Menu Selection (Press and Hold ³)

- 1 All running apps will close.
- 2 You can access and adjust the menu by pressing the button when TV is on.
- 3 You can use the function when you access menu control.

Adjusting the menu

When the TV is turned on, press the button one time. You can adjust the Menu items using the button.

	Turns the power off.
	Changes the input source.
	Adjusts the volume level.
	Scrolls through the saved programmes.

SETTING UP THE TV**⚠ CAUTION**

- When attaching the stand to the TV set, place the screen facing down on a cushioned table or flat surface to protect the screen from scratches.
- Do not apply foreign substances (oils, lubricants, etc.) to the screw parts when assembling the product. (Doing so may damage the product.)

! NOTE

- Remove the stand before installing the TV on a wall mount by performing the stand attachment in reverse. (Only TN52*S)
- Lift up the latch at the bottom of the stand base and detach the stand base from the TV. (Only TN51*S)

MOUNTING ON A TABLE

- Image shown may differ from your TV.
- 1 Lift and tilt the TV into its upright position on a table.
 - Leave a 100 mm (minimum) space from the wall for proper ventilation.

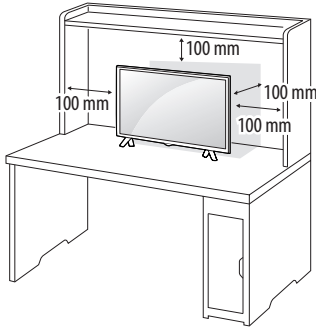

- 2 Connect the AC-DC Adapter and power cord to a wall outlet.

⚠ CAUTION

- Do not place the TV near or on sources of heat, as this may result in fire or other damage.
- Please be sure to connect the TV to the AC/DC power adapter before connecting the TV's power plug to a wall power outlet.

Using the Kensington security system (optional)

(This is not available for all models.)

- Image shown may differ from your TV.
- The Kensington security system connector is located at the rear of the TV. For more information of installation and using, refer to the manual provided with the Kensington security system or visit <http://www.kensington.com>. Connect the Kensington security system cable between the TV and a table.

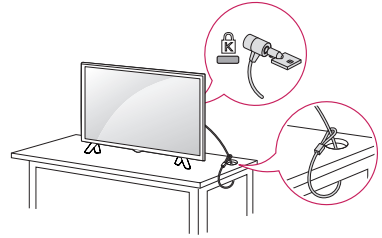

ⓘ NOTE

- The Kensington security system is optional. You can obtain additional accessories from most electronics stores.

MOUNTING ON A WALL

For proper ventilation, allow a clearance of 100 mm on each side and from the wall. Detailed installation instructions are available from your dealer, see the optional Tilt Wall Mounting Bracket Installation and Setup Guide.

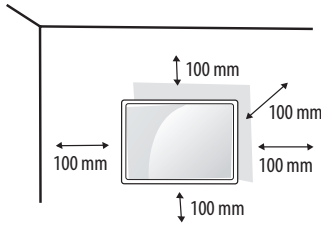

If you intend to mount the TV to a wall, attach Wall mounting interface (optional parts) to the back of the TV.

When you install the TV using the wall mounting interface (optional parts), attach it carefully so it will not drop.

- 1 If you use screw longer than standard, the TV might be damaged internally.
- 2 If you use improper screw, the product might be damaged and drop from mounted position. In this case, LG Electronics is not responsible for it.

Separate purchase (Wall mounting bracket)

Model	24TN520S 24TN510S	28TN525S 28TN515S
Wall mount (A x B) (mm)	75 x 75	100 x 100
		
Standard screw	M4 x L10	
Number of screws	4	
Wall mount bracket (optional)	LSW149	

CAUTION

- Must use the enclosed screw in the box. (Depending on model)
- Disconnect the power first, and then move or install the TV. Otherwise electric shock may occur.
- If you install the TV on a ceiling or slanted wall, it may fall and result in severe injury.
- Use an authorized LG wall mount and contact the local dealer or qualified personnel.
- Do not over tighten the screws as this may cause damage to the TV and void your warranty.
- Use the screws and wall mounts that meet the VESA standard. Any damages or injuries by misuse or using an improper accessory are not covered by the warranty.
- Screw length from outer surface of back cover should be under 8 mm.

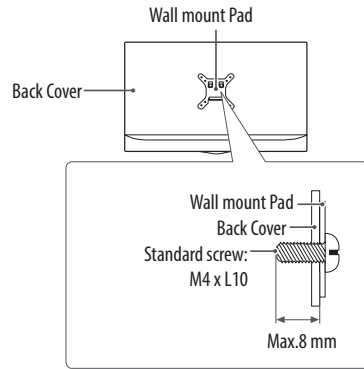

NOTE

- Use the screws that are listed on the VESA standard screw specifications.
- The wall mount kit includes an installation manual and necessary parts.
- The wall mount bracket is optional. You can obtain additional accessories from your local dealer.
- The length of screws may differ depending on the wall mount. Be sure to use the proper length.
- For more information, refer to the instructions supplied with the wall mount.

CONNECTIONS (NOTIFICATIONS)

Connect various external devices to the TV and switch input modes to select an external device. For more information about an external device's connection, refer to the manual supplied with each device. Available external devices are: Blu-ray player, HD receivers, DVD players, VCRs, audio systems, USB storage devices, PC, gaming devices, and other external devices.

! NOTE

- The external device connection may differ from the model.
- Connect external devices to the TV regardless of the order of the TV port.
- If you record a TV program on a Blu-ray/DVD recorder or VCR, make sure to connect the TV signal input cable to the TV through a DVD recorder or VCR. For more information of recording, refer to the manual provided with the connected device.
- Refer to the external equipment's manual for operating instructions.
- If you connect a gaming device to the TV, use the cable supplied with the gaming device.
- In PC mode, there may be noise associated with the resolution, vertical pattern, contrast or brightness. If noise is present, change the PC output to another resolution, change the refresh rate to another rate or adjust the brightness and contrast on the [Picture] menu until the picture is clear.
- In PC mode, some resolution settings may not work properly depending on the graphics card.
- When connecting via a wired LAN, it is recommended to use a CAT 7 cable. (Only when LAN port is provided.)
- Ethernet only supports 100 Base-T.
- HDR (High Dynamic Range) pictures can be viewed over the Internet or via USB and HDMI 1.4 compatible devices.

Antenna connection

Connect the TV to a wall antenna socket with an RF cable (75 Ω) (Not Provided).

- Use a signal splitter to use more than 2 TVs.
- If the image quality is poor, install a signal amplifier properly to improve the image quality.
- If the image quality is poor with an antenna connected, try to realign the antenna in the correct direction.
- An antenna cable and converter are not supplied.

Satellite dish connection

(Only satellite models)

Connect the TV to a satellite dish to a satellite socket with a satellite RF cable (75 Ω).

CI module connection

(Depending on model)

View the encrypted (pay) services in digital TV mode.

- Check if the CI module is inserted into the PCMCIA card slot in the right direction. If the module is not inserted properly, this can cause damage to the TV and the PCMCIA card slot.
- If the TV does not display any video and audio when CI+ CAM is connected, please contact to the Terrestrial/Cable/Satellite Service Operator.

PC connection

Switch the input mode to connect with the PC using the HDMI input.

 (INPUT) (Remote control) ⇒ [Home Dashboard] ⇒ [EDIT] ⇒ Select ICON ⇒ [SAVE]

Other connections

Connect your TV to external devices. For the best picture and audio quality, connect the external device and the TV with the HDMI cable. Some separate cable is not provided.

- USB port supports 0.5 A electric current. If you need more electric current in case of HDD, use the separate power adaptor.

! NOTE

- Supported HDMI Audio format:
(Depending on model)
DTS (44.1 kHz / 48 kHz / 88.2 kHz / 96 kHz), DTS HD (44.1 kHz / 48 kHz / 88.2 kHz / 96 kHz / 176.4 kHz / 192 kHz), Dolby Digital / Dolby Digital Plus (32 kHz / 44.1 kHz / 48 kHz), PCM (32 kHz / 44.1 kHz / 48 kHz / 96 kHz / 192 kHz)

REMOTE CONTROL

The descriptions in this manual are based on the buttons on the remote control. Please read this manual carefully and use the TV correctly.

To replace batteries, open the battery cover, replace batteries (1.5 V AAA) matching the ⊕ and ⊖ ends to the label inside the compartment, and close the battery cover. To remove the batteries, perform the installation actions in reverse.

⚠ CAUTION

- Do not mix old and new batteries, as this may damage the remote control.
- The remote control will not be included for all sales market. Make sure to point the remote control toward the remote control sensor on the TV.

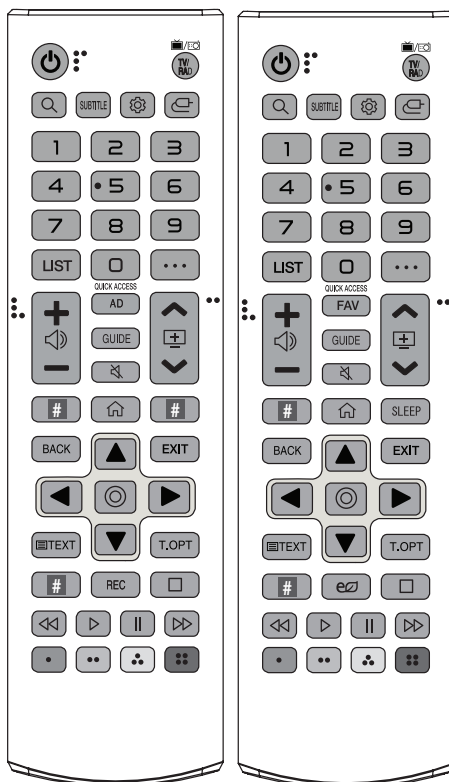

(Some buttons and services may not be provided depending on models or regions.)

1 To use the button, press and hold for more than 3 seconds.

 **(POWER)** Turns the TV on or off.

TV/RAD,  Selects Radio, TV and DTV programme.

 **(SEARCH)** Search for content such as TV programmes, movies and other videos, or perform a web search by entering text in the search bar.

SUBTITLE Recalls your preferred subtitle in digital mode.

 **(Q. Settings)** Accesses the Quick Settings.

 **(INPUT)** Changes the input source.

Number buttons Enters numbers.

9¹ Accesses the [QUICK HELP].

LIST Accesses the saved programmes list.

... **(MORE ACTIONS)** Displays more remote control functions.

QUICK ACCESS¹ Edits QUICK ACCESS.

- QUICK ACCESS is a feature that allows you to enter a specified app or Live TV directly by pressing and holding the number buttons.

 Adjusts the volume level.

AD Audio descriptions function will be enabled.

FAV Accesses your favorite channel list.

GUIDE Shows programme guide.

 **(MUTE)** Mutes all sounds.

 **(MUTE)**¹ Accesses the [Accessibility] menu.

 Scrolls through the saved programmes.

 **Streaming Service buttons** Connects to the Video Streaming Service.

 **(HOME)** Accesses Home menu.

 **(HOME)**¹ Shows the previous history.

SLEEP Set the sleep timer.

BACK Returns to the previous level.

EXIT Clears on-screen displays and returns to TV viewing.

Navigation buttons (up/down/left/right) Scrolls through menus or options.

 **(OK)** Selects menus or options and confirms your input.

 **TEXT, T.OPT (Teletext buttons)** These buttons are used for teletext.

REC Starts to record and displays record menu. This TV does not support recording function.



 **(Energy Saving)** Adjusts the brightness of the screen to reduce energy.

 **<<, >>, II, >>>** **(Control buttons)** Control buttons for media contents.

 These access special functions in some menus.

USER GUIDE

For more information about this TV, read the USER GUIDE embedded in the product.

- To open the USER GUIDE  →   → [General] → [About This TV] → [User Guide]

MAINTENANCE

Cleaning your TV

Clean your TV regularly to keep the best performance and to extend the product lifespan.

- Make sure to turn the power off and disconnect the power cord and all other cables first.
- When the TV is left unattended and unused for a long time, disconnect the power cord from the wall outlet to prevent possible damage from lightning or power surges.

Screen, frame, cabinet and stand

To remove dust or light dirt, wipe the surface with a dry, clean, and soft cloth.

To remove major dirt, wipe the surface with a soft cloth dampened in clean water or a diluted mild detergent. Then wipe immediately with a dry cloth.

- Avoid touching the screen at all times, as this may result in damage to the screen.
- Do not push, rub, or hit the screen surface with your fingernail or a sharp object, as this may result in scratches and image distortions.
- Do not use any chemicals as this may damage the product.
- Do not spray liquid onto the surface. If water enters the TV, it may result in fire, electric shock, or malfunction.

Power cord

Remove the accumulated dust or dirt on the power cord regularly.

Preventing “Image burn” or “Burn-in” on your TV screen

- If a fixed image displays on the TV screen for a long period of time, it will be imprinted and become a permanent disfigurement on the screen. This is “image burn” or “burn-in” and not covered by the warranty.
- If the aspect ratio of the TV is set to 4:3 for a long period of time, image burn may occur on the letterboxed area of the screen.
- Avoid displaying a fixed image on the TV screen for a long period of time (2 or more hours for LCD) to prevent image burn.

TROUBLESHOOTING

Cannot control the TV with the remote control.

- Check the remote control sensor on the product and try again.
- Check if there is any obstacle between the product and the remote control.
- Check if the batteries are still working and properly installed (⊕ to ⊕, ⊖ to ⊖).

No image display and no sound is produced.

- Check if the product is turned on.
- Check if the power cord is connected to a wall outlet.
- Check if there is a problem in the wall outlet by connecting other products.

The TV turns off suddenly.

- Check the power control settings. The power supply may be interrupted.
- Check if the auto-off function is activated on the settings related time.
- If there is no signal while the TV is on, the TV will turn off automatically after 15 minutes of inactivity.

When connecting to the PC (HDMI), no signal is detected.

- Turn the TV off/on using the remote control.
- Reconnect the HDMI cable.
- Restart the PC with the TV on.

SPECIFICATIONS

Product specifications may be changed without prior notice due to upgrade of product functions.

Models	Dimensions (W x D x H) (mm)		Weight (kg)		Power consumption (Outgoing condition)	Power requirement
	With stand	Without stand	With stand	Without stand		
28TN525S	649.5 x 150.0 x 420.9	649.5 x 78.4 x 394.3	3.57	3.53	28 W	19 V --- 2.0 A
28TN515S	649.5 x 187.5 x 448.3	649.5 x 78.4 x 394.3	3.88	3.53	28 W	19 V --- 2.0 A
24TN520S	563.1 x 150.1 x 367	563.1 x 58 x 340.9	3.3	3.25	25 W	19 V --- 2.0 A
24TN510S	563.1 x 148.6 x 393.8	563.1 x 58 x 340.9	3.6	3.25	25 W	19 V --- 2.0 A

Wireless module specification

Wireless module (LGSBWAC92) specifications	
Wireless LAN (IEEE 802.11a/b/g/n/ac)	
Frequency Range	Output Power(Max.)
2,400 to 2,483.5 MHz	18 dBm
5,150 to 5,725 MHz	18 dBm
5,725 to 5,850 MHz (Not for EU)	12 dBm
Bluetooth	
Frequency Range	Output Power(Max.)
2,400 to 2,483.5 MHz	8 dBm

As band channels can vary per country, the user cannot change or adjust the operating frequency. This product is configured for the regional frequency table.

For consideration of the user, this device should be installed and operated with a minimum distance of 20 cm between the device and the body.

* "IEEE 802.11ac" is not available in all countries.

AC/DC Adapter	28TN525S, 28TN515S 24TN520S, 24TN510S
	Manufacturer: Lien Chang Model: LCAP16B-E, LCAP21C Manufacturer: Honor Model: ADS-45FSN-19 19040GPG
	In: AC 100 – 240 V ~ 50/60 Hz Out: DC 19 V --- 2.1 A

CI module Size (W x H x D)	100.0 mm x 55.0 mm x 5.0 mm
-----------------------------------	-----------------------------

Environment condition	Operating Temperature	0 °C to 40 °C
	Operating Humidity	Less than 80 %
	Storage Temperature	-20 °C to 60 °C
	Storage Humidity	Less than 85 %

(Depending on country)

	Digital TV			Analogue TV
	Satellite	Terrestrial	Cable	Terrestrial / Cable
Television system	DVB-S/S2*	DVB-T DVB-T2*	DVB-C	PAL/SECAM B/G, D/K, I,SECAM L
Programme coverage	950 ~ 2,150 Mhz	VHF III: 174 ~ 230 Mhz UHF IV: 470 ~ 606 Mhz UHFV: 606 ~ 862 Mhz S Band II: 230 ~ 300 Mhz S Band III: 300 ~ 470 Mhz	46 ~ 890 Mhz	46 ~ 862 Mhz
Maximum number of storable programmes	6,000	3,000		
External antenna impedance	75 Ω			

* Only DVB-T2/C/S2 support models.







WARNING!

Never place a television set in an unstable location. A television set may fall, causing serious personal injury or death. Many injuries, particularly to children, can be avoided by taking simple precautions such as:

- Using cabinets or stands recommended by the manufacturer of the television set.
- Only using furniture that can safely support the television set.
- Ensuring the television set is not overhanging the edge of the supporting furniture.
- Not placing the television set on tall furniture (for example, cupboards or bookcases) without anchoring both the furniture and the television set to a suitable support.
- Not placing the television set on cloth or other materials that may be located between the television set and supporting furniture.
- Educating children about the dangers of climbing on furniture to reach the television set or its controls.

If your existing television set is being retained and relocated, the same considerations as above should be applied.

Symbols

	Refers to alternating current (AC).
	Refers to direct current (DC).
	Refers to class II equipment.
	Refers to stand-by.
	Refers to "ON" (power).
	Refers to dangerous voltage.



The model and serial number of the product are located on the back and on one side of the product. Record them below in case you ever need service.

Model

Serial No.