

# Lenovo IdeaPad S145 Series

## Hardware Maintenance Manual



**Note:**

- Before using this information and the product it supports, be sure to read the general information under “Notices” on page 68.

**First Edition (August 2019)**

**© Copyright Lenovo 2019. All rights reserved.**

LIMITED AND RESTRICTED RIGHTS NOTICE: If data or software is delivered pursuant a General Services Administration “GSA” contract, use, reproduction, or disclosure is subject to restrictions set forth in Contract No. GS-35F-05925.

© 2019 Lenovo

---

# Contents

---

<b>About this manual</b> .....	iv	Hotkeys	32
<b>Safety information</b> .....	1	Service tools	33
General safety .....	2	Parts list	34
Electrical safety .....	3	Overall .....	35
<b>Safety information</b> .....	3	LCD FRU .....	37
Safety inspection guide .....	5	FRU replacement notices .....	39
Handling devices that are sensitive to electrostatic discharge .....	6	Screw notices .....	39
Grounding requirements .....	6	Removing and replacing FRU .....	40
Safety notices: multilingual translations .....	7	1010 Base cover .....	41
<b>Important service information</b> .....	14	1020 Battery pack .....	43
Strategy for replacing FRU .....	15	1030 SSD .....	45
Strategy for replacing a hard disk drive .....	16	1040 DIMM .....	46
Important notice for replacing a system board .....	16	1050 Hard disk drive .....	47
Important information about replacing RoHS compliant FRU .....	17	1060 PCI Express Mini Card for wireless LAN .....	49
1070 Fan assembly and Heat Sink assembly .....	51	1080 I/O board .....	54
<b>General checkout</b> .....	18	1090 Backup battery .....	55
What to do first .....	19	1100 System board .....	57
Power system checkout .....	20	1110 Upper case .....	59
Checking the AC adapter .....	20	1120 LCD unit .....	62
Checking operational charging .....	21	1130 Integrated camera and antenna assembly .....	65
Checking the battery pack .....	21	1140 Wifi antenna .....	67
<b>Related service information</b> .....	22	<b>Notices</b> .....	68
Passwords .....	23	Trademarks .....	69
Power-on password .....	23		
Hard-disk password .....	23		
Administrator password .....	23		
Power management .....	24		
Screen blank state .....	24		
Putting the computer to sleep or shutting it down. 24 .....	24		
Putting your computer to sleep .....	24		
Shutting down the computer .....	25		
<b>Lenovo BS145-15IGM/BS145-15IWL/IdeaPad S145-14API/IdeaPad S145-14AST/IdeaPad S145-14IGM/IdeaPad S145-14IKB/IdeaPad S145-14IML/IdeaPad S145-14IWL/Lenovo IdeaPad S145-14IIL/IdeaPad S145-15API/ IdeaPad S145-15AST/IdeaPad S145-15IGM/ IdeaPad S145-15IKB/IdeaPad S145-15IML/ IdeaPad S145-15IWL/Lenovo IdeaPad S145- 15IIL</b> .....	<b>26</b>		
Locations .....	27		
Front view and right-side view .....	27		
Bottom and left-side view .....	28		
Specifications .....	29		
Status indicators .....	31		

---

## About this manual

---

This manual contains service and reference information for the following Lenovo products:

- Lenovo BS145-15IGM
- Lenovo BS145-15IWL
- Lenovo IdeaPad S145-14API
- Lenovo IdeaPad S145-14AST
- Lenovo IdeaPad S145-14IGM
- Lenovo IdeaPad S145-14IKB
- Lenovo IdeaPad S145-14IML
- Lenovo IdeaPad S145-14IWL
- Lenovo IdeaPad S145-14IIL
- Lenovo IdeaPad S145-15API
- Lenovo IdeaPad S145-15AST
- Lenovo IdeaPad S145-15IGM
- Lenovo IdeaPad S145-15IKB
- Lenovo IdeaPad S145-15IML
- Lenovo IdeaPad S145-15IWL
- Lenovo IdeaPad S145-15IIL

Use this manual to troubleshoot problems.

The manual is divided into the following sections:

- The common sections provide general information, guidelines, and safety information required for servicing computers.
- The product-specific section includes service, reference, and product-specific parts information.

**Important:**

This manual is intended only for trained servicers who are familiar with Lenovo products. Use this manual to troubleshoot problems effectively.

Before servicing a Lenovo product, make sure to read all the information under “Safety information” on page 1 and “Important service information” on page 16.

---

## Safety information

---

This chapter presents the following safety information that you need to get familiar with before you service a Lenovo BS145-15IGM/BS145-15IWL/IdeaPad S145-14API/IdeaPad S145-14AST/IdeaPad S145-14IGM/IdeaPad S145-14IKB/IdeaPad S145-14IML/IdeaPad S145-14IWL/IdeaPad S145-14IIL/IdeaPad S145-15API/IdeaPad S145-15AST/IdeaPad S145-15IGM/IdeaPad S145-15IKB/IdeaPad S145-15IML/IdeaPad S145-15IWL/IdeaPad S145-15IIL computer:

- “General safety” on page 2
- “Electrical safety” on page 3
- “Safety inspection guide” on page 5
- “Handling devices that are sensitive to electrostatic discharge” on page 6
- “Grounding requirements” on page 6
- “Safety notices: multilingual translations” on page 7



## General safety

Follow these rules below to ensure general safety:

- Observe a good housekeeping in the area where the machines are put during and after the maintenance.
- When lifting any heavy object:
  1. Make sure that you can stand safely without slipping.
  2. Distribute the weight of the object equally between your feet.
  3. Use a slow lifting force. Never move suddenly or twist when you attempt to lift it.
  4. Lift it by standing or pushing up with your leg muscles; this action could avoid the strain from the muscles in your back. Do not attempt to lift any object that weighs more than 16 kg (35 lb) or that you think is too heavy for you.
- Do not perform any action that causes hazards to the customer, or that makes the machine unsafe.
- Before you start the machine, make sure that other service representatives and the customer are not in a hazardous position.
- Please remove covers and other parts in a safe place, away from all personnel, while you are servicing the machine.
- Keep your toolcase away from walk areas so that other people will not trip over it.
- Do not wear loose clothing that can be trapped in the moving parts of the machine. Make sure that your sleeves are fastened or rolled up above your elbows. If your hair is long, fasten it.
- Insert the ends of your necktie or scarf inside clothing or fasten it with the nonconductive clip, about 8 centimeters (3 inches) from the end.
- Do not wear jewelry, chains, metal-frame eyeglasses, or metal fasteners for your clothing.

**Attention:** Metal objects are good electrical conductors.
- Wear safety glasses when you are hammering, drilling, soldering, cutting wire, attaching springs, using solvents, or working in any other conditions that may be hazardous to your eyes.
- After service, reinstall all safety shields, guards, labels, and ground wires. Replace any safety device that is worn or defective.
- Reinstall all covers correctly before returning the machine to the customer.
- Fan louvers on the machine help to prevent the overheating of internal components. Do not obstruct fan louvers or cover them with labels or stickers.

## Electrical safety

Observe the following rules when working on electrical equipments.

### Important:

Use only approved tools and test equipments. Some hand tools have handles covered with a soft material that does not insulate you when working with live electrical currents.

Many customers have rubber floor mats near their machines that contain small conductive fibers to decrease electrostatic discharges. Do not use such kind of mat to protect yourself from electrical shock.

- Find the room emergency power-off (EPO) switch, disconnecting switch or electrical outlet. If an electrical accident occurs, you can then operate the switch or unplug the power cord quickly.
- Do not work alone under hazardous conditions or near the equipment that has hazardous voltages.
- Disconnect all power before:
  - Performing a mechanical inspection
  - Working near power supplies
  - Removing or installing main units
- Before you start to work on the machine, unplug the power cord. If you cannot unplug it, ask the customer to power-off the wall box that supplies power to the machine, and to lock the wall box in the off position.
- If you need to work on a machine that has exposed electrical circuits, observe the following precautions:
  - Ensure that another person, familiar with the power-off controls, is near you.
 

**Attention:** Another person must be there to switch off the power, if necessary.
  - Use only one hand when working with powered-on electrical equipment; keep the other hand in your pocket or behind your back.
 

**Attention:** An electrical shock can occur only when there is a complete circuit. By observing the above rule, you may prevent a current from passing through your body.
  - When using testers, set the controls correctly and use the approved probe leads and accessories for that tester.
  - Stand on suitable rubber mats (obtained locally, if necessary) to insulate you from grounds such as metal floor strips and machine frames.

Observe the special safety precautions when you work with very high voltages; instructions for these precautions are in the safety sections of maintenance information. Be extremely careful when you measure the high voltages.

- Regularly inspect and maintain your electrical hand tools for safe operational condition.
- Do not use worn or broken tools and testers.
- Never assume that power has been disconnected from a circuit. First, check it to make sure that it has been powered off.



- Always look carefully for possible hazards in your work area. Examples of these hazards are moist floors, nongrounded power extension cables, power surges, and missing safety grounds.
- Do not touch live electrical circuits with the reflective surface of a plastic dental mirror. The surface is conductive; such touching can cause personal injury and machine damage.
- Do not service the following parts with the power on when they are removed from their normal operating places in a machine:
  - Power supply units
  - Pumps
  - Blowers and fans
  - Motor generatorsand similar units. (This practice ensures correct grounding of the units.)
- If an electrical accident occurs:
  - Caution: do not become a victim yourself.
  - Switch off the power.
  - Send the victim to get medical aid.



## Safety inspection guide

The purpose of this inspection guide is to assist you in identifying potential unsafe conditions. As each machine was designed and built, required safety items were installed to protect users and service personnel from injury. This guide addresses only those items. You should use good judgment to identify potential safety hazards according to the attachment of non-Lenovo features or options not covered by this inspection guide.

If any unsafe conditions are present, you must determine how serious the apparent hazard could be and whether you can continue without first correcting the problem.

Consider these conditions and the safety hazards they present:

- Electrical hazards, especially primary power (primary voltage on the frame can cause serious or fatal electrical shock)
- Explosive hazards, such as a damaged CRT face or a bulging capacitor
- Mechanical hazards, such as loose or missing hardware

To determine whether there are any potential unsafe conditions, use the following checklist at the beginning of every service task. Begin the checks with the power off, and the power cord disconnected.

Checklist:

1. Check exterior covers for damage (loose, broken, or sharp edges).
2. Turn off the computer. Disconnect the power cord.
3. Check the power cord for:
  - a. A third-wire ground connector in good condition. Use a meter to measure third-wire ground continuity for 0.1 ohm or less between the external ground pin and the frame ground.
  - b. The power cord should be the type specified in the parts list.
  - c. Insulation must not be frayed or worn.
4. Check for cracked or bulging batteries.
5. Remove the cover.
6. Check for any obvious non-Lenovo alterations. Use good judgment as to the safety of any non-Lenovo alterations.
7. Check inside the unit for any obvious unsafe conditions, such as metal filings, contamination, water or other liquids, or signs of fire or smoke damage.
8. Check for worn, frayed, or pinched cables.
9. Check that the power-supply cover fasteners (screws or rivets) have not been removed or tampered with.



## Handling devices that are sensitive to electrostatic discharge

Any computer part containing transistors or integrated circuits (ICs) should be considered sensitive to electrostatic discharge (ESD). ESD damage can occur when there is a difference in charge between objects. Protect against ESD damage by equalizing the charge so that the machine, the part, the work mat, and the person handling the part are all at the same charge.

### Notes:

1. Use product-specific ESD procedures when they exceed the requirements noted here.
2. Make sure that the ESD protective devices you use have been certified (ISO 9000) as fully effective.

When handling ESD-sensitive parts:

- Keep the parts in protective packages until they are inserted into the product.
- Avoid contact with other people.
- Wear a grounded wrist strap against your skin to eliminate static on your body.
- Prevent the part from touching your clothing. Most clothing is insulative and retains a charge even when you are wearing a wrist strap.
- Use the black side of a grounded work mat to provide a static-free work surface. The mat is especially useful when handling ESD-sensitive devices.
- Select a grounding system, such as those listed below, to provide protection that meets the specific service requirement.

### Note:

The use of a grounding system to guard against ESD damage is desirable but not necessary.

- Attach the ESD ground clip to any frame ground, ground braid, or green-wire ground.
- When working on a double-insulated or battery-operated system, use an ESD common ground or reference point. You can use coax or connector-outside shells on these systems.
- Use the round ground prong of the ac plug on ac-operated computers.

## Grounding requirements

Electrical grounding of the computer is required for operator safety and correct system function. Proper grounding of the electrical outlet can be verified by a certified electrician.

## Safety notices: multilingual translations

The safety notices in this section are provided in English, French, German, Hebrew, Italian, Japanese, and Spanish.

### Safety notice 1

Before the computer is powered on after FRU replacement, make sure all screws, springs, and other small parts are in place and are not left loose inside the computer. Verify this by shaking the computer and listening for rattling sounds. Metallic parts or metal flakes can cause electrical shorts.

Avant de remettre l'ordinateur sous tension après remplacement d'une unité en clientèle, vérifiez que tous les ressorts, vis et autres pièces sont bien en place et bien fixées. Pour ce faire, secouez l'unité et assurez-vous qu'aucun bruit suspect ne se produit. Des pièces métalliques ou des copeaux de métal pourraient causer un court-circuit.

Bevor nach einem FRU-Austausch der Computer wieder angeschlossen wird, muß sichergestellt werden, daß keine Schrauben, Federn oder andere Kleinteile fehlen oder im Gehäuse vergessen wurden. Der Computer muß geschüttelt und auf Klappergeräusche geprüft werden. Metallteile oder-splitter können Kurzschlüsse erzeugen.

לפני הפעלת המחשב לאחר החלפת FRU יש לוודא שכל הברגים, הקפיצים, וחלקים קטנים אחרים נמצאים במקומם ואינם חופשיים לזוז בתוך המחשב. כדי לוודא זאת, יש לטלטל את המחשב ולהקשיב לגילוי קולות שקשוק. חלקי או שבבי מתכת עלולים לגרום לקצרים חשמליים.

Prima di accendere l'elaboratore dopo che é stata effettuata la sostituzione di una FRU, accertarsi che tutte le viti, le molle e tutte le altri parti di piccole dimensioni siano nella corretta posizione e non siano sparse all'interno dell'elaboratore. Verificare ciò scuotendo l'elaboratore e prestando attenzione ad eventuali rumori; eventuali parti o pezzetti metallici possono provocare cortocircuiti pericolosi.

FRUの交換後、コンピュータの電源を入れる前に、ねじ、バネ、その他の小さな部品がすべて正しい位置にあり、またコンピュータの内部で緩んでいないことを確認してください。これを確認するには、コンピュータを振って、カチャカチャと音がしないか確かめます。金属部品や金属破片はショートの原因になることがあります。

Antes de encender el sistema despues de sustituir una FRU, compruebe que todos los tornillos, muelles y demás piezas pequeñas se encuentran en su sitio y no se encuentran sueltas dentro del sistema. Compruébelo agitando el sistema y escuchando los posibles ruidos que provocarían. Las piezas metálicas pueden causar cortocircuitos eléctricos.



## Safety notice 2

### DANGER

Some standby batteries contain a small amount of nickel and cadmium. Do not disassemble a standby battery, recharge it, throw it into fire or water, or short-circuit it. Dispose of the battery as required by local ordinances or regulations. Use only the battery in the appropriate parts listing. Use of an incorrect battery can result in ignition or explosion of the battery.

Certaines batteries de secours contiennent du nickel et du cadmium. Ne les démontez pas, ne les rechargez pas, ne les exposez ni au feu ni à l'eau. Ne les mettez pas en court-circuit. Pour les mettre au rebut, conformez-vous à la réglementation en vigueur. Lorsque vous remplacez la pile de sauvegarde ou celle de l'horloge temps réel, veillez à n'utiliser que les modèles cités dans la liste de pièces détachées adéquate. Une batterie ou une pile inappropriée risque de prendre feu ou d'exploser.

Die Bereitschaftsbatterie, die sich unter dem Diskettenlaufwerk befindet, kann geringe Mengen Nickel und Cadmium enthalten. Sie darf nicht zerlegt, wiederaufgeladen, kurzgeschlossen, oder Feuer oder Wasser ausgesetzt werden. Bei der Entsorgung die örtlichen Bestimmungen für Sondermüll beachten. Beim Ersetzen der Bereitschafts- oder Systembatterie nur Batterien des Typs verwenden, der in der Ersatzteilliste aufgeführt ist. Der Einsatz falscher Batterien kann zu Entzündung oder Explosion führen.

סוללות המתנה מסוימות מכילות כמות קטנה של ניקל וקדמיום. אין לפרק סוללות המתנה, לטעון אותה מחדש, להשליך אותה לאש או למים או לקצר אותה. יש לשלוק את הסוללה בנדרש על ידי התקנות והחוקים המקומיים. יש להשתמש רק בסוללה המומיפה ברשימת החלקים המתאימה. שימוש בסוללה לא מתאימה עלול לגרום להצתה או התפוצצות של הסוללה.

Alcune batterie di riserva contengono una piccola quantità di nichel e cadmio. Non smontarle, ricaricarle, gettarle nel fuoco o nell'acqua né cortocircuitarle. Smaltirle secondo la normativa in vigore (DPR 915/82, successive disposizioni e disposizioni locali). Quando si sostituisce la batteria dell'RTC (real time clock) o la batteria di supporto, utilizzare soltanto i tipi inseriti nell'appropriato Catalogo parti. L'impiego di una batteria non adatta potrebbe determinare l'incendio o l'esplosione della batteria stessa.

予備バッテリーの中には少量のニッケルとカドミウムが含まれているものがあります。したがって、予備バッテリーの分解、再充電、火または水の中への投棄、またはショートさせることは決して行わないでください。バッテリーを廃棄する場合は地方自治体の条例に従ってください。適切なパーツ・リストにあるバッテリーだけをを使用してください。誤ったバッテリーを使用すると、バッテリーが発火したり、爆発したりすることがあります。

Algunas baterías de reserva contienen una pequeña cantidad de níquel y cadmio. No las desmonte, ni recargue, ni las eche al fuego o al agua ni las cortocircuite. Deséchelas tal como dispone la normativa local. Utilice sólo baterías que se encuentren en la lista de piezas. La utilización de una batería no apropiada puede provocar la ignición o explosión de la misma.

**Safety notice 3**

**⚠ DANGER**

The battery pack contains small amounts of nickel. Do not disassemble it, throw it into fire or water, or short-circuit it. Dispose of the battery pack as required by local ordinances or regulations. Use only the battery in the appropriate parts listing when replacing the battery pack. Use of an incorrect battery can result in ignition or explosion of the battery.

La batterie contient du nickel. Ne la démontez pas, ne l'exposez ni au feu ni à l'eau. Ne la mettez pas en court-circuit. Pour la mettre au rebut, conformez-vous à la réglementation en vigueur. Lorsque vous remplacez la batterie, veuillez à n'utiliser que les modèles cités dans la liste de pièces détachées adéquate. En effet, une batterie inappropriée risque de prendre feu ou d'exploser.

Akkus enthalten geringe Mengen von Nickel. Sie dürfen nicht zerlegt, wiederaufgeladen, kurzgeschlossen, oder Feuer oder Wasser ausgesetzt werden. Bei der Entsorgung die örtlichen Bestimmungen für Sondermüll beachten. Beim Ersetzen der Batterie nur Batterien des Typs verwenden, der in der Ersatzteilliste aufgeführt ist. Der Einsatz falscher Batterien kann zu Entzündung oder Explosion führen.

מאזו הסוללה מכיל כמות קטנה של ניקל וקדמיום. אין לפרק את מאזו הסוללה, להשליך אותו לאש או למים או לקצר אותו. יש לסלק את מאזו הסוללה הסוללה כנדרש על ידי התקנות החוקיים המקומיים. יש להשתמש רק בסוללה המוביעה ברשימת החלקים המתאימה בזמן החלפת מאזו הסוללה. שימוש בסוללה לא מתאימה עלול לגרום להצתה או התפוצצות של הסוללה.

La batteria contiene piccole quantità di nichel. Non smontarla, gettarla nel fuoco o nell'acqua né cortocircuitarla. Smaltirla secondo la normativa in vigore (DPR 915/82, successive disposizioni e disposizioni locali). Quando si sostituisce la batteria, utilizzare soltanto i tipi inseriti nell'appropriato Catalogo parti. L'impiego di una batteria non adatta potrebbe determinare l'incendio o l'esplosione della batteria stessa.

バッテリー・パックには少量のニッケルが含まれています。バッテリー・パックを分解したり、火または水の中に投げ込んだり、ショートさせないでください。バッテリー・パックの廃棄にあたっては、地方自治体の条例または規則に従ってください。バッテリー・パックを交換するときは、適切なパーツ・リストにあるバッテリーだけを使用してください。誤ったバッテリーを使用すると、バッテリーが発火したり、爆発したりすることがあります。

Las baterías contienen pequeñas cantidades de níquel. No las desmonte, ni recargue, ni las eche al fuego o al agua ni las cortocircuite. Deséchelas tal como dispone la normativa local. Utilice sólo baterías que se encuentren en la lista de piezas al sustituir la batería. La utilización de una batería no apropiada puede provocar la ignición o explosión de la misma.



#### Safety notice 4

##### DANGER

The lithium battery can cause a fire, an explosion, or a severe burn. Do not recharge it, remove its polarized connector, disassemble it, heat it above 100°C (212°F), incinerate it, or expose its cell contents to water. Dispose of the battery as required by local ordinances or regulations. Use only the battery in the appropriate parts listing. Use of an incorrect battery can result in ignition or explosion of the battery.

La pile de sauvegarde contient du lithium. Elle présente des risques d'incendie, d'explosion ou de brûlures graves. Ne la rechargez pas, ne retirez pas son connecteur polarisé et ne la démontez pas. Ne l'exposez pas à une température supérieure à 100°C, ne la faites pas brûler et n'en exposez pas le contenu à l'eau. Mettez la pile au rebut conformément à la réglementation en vigueur. Une pile inappropriée risque de prendre feu ou d'exploser.

Die Systematterie ist eine Lithiumatterie. Sie kann sich entzünden, explodieren oder schwere Verbrennungen hervorrufen. Batterien dieses Typs dürfen nicht aufgeladen, zerlegt, über 100 C erhitzt oder verbrannt werden. Auch darf ihr Inhalt nicht mit Wasser in Verbindung gebracht oder der zur richtigen Polung angebrachte Verbindungsstecker entfernt werden. Bei der Entsorgung die örtlichen Bestimmungen für Sondermüll beachten. Beim Ersetzen der Batterie nur Batterien des Typs verwenden, der in der Ersatzteilliste aufgeführt ist. Der Einsatz falscher Batterien kann zu Entzündung oder Explosion führen.

סוללת הליתיום עלולה לגרום לשריפה, להתפוצצות או לפגיעות קשות. אין לטעון אותה מחדש, לנטות את המחובר המקוטב שלה, למרק אותה או לחמם אותה לטמפרטורה העולה על 100 מעלות צלזיוס. אין לשרוף את הסוללה ואין לחשוף את תוכן התא למים. יש לנטות את הסוללה כנדרש במקנות ובחוקים המקומיים. יש להשתמש רק בסוללה המומייעה ברשימת החלקים המתאימים. שימוש בסוללה אחרת עלול לגרום לטכנת שריפה או התפוצצות.

La batteria di supporto e una batteria al litio e puo incendiarsi, esplodere o procurare gravi ustioni. Evitare di ricaricarla, smontarne il connettore polarizzato, smontarla, riscaldarla ad una temperatura superiore ai 100 gradi centigradi, incendiarla o gettarla in acqua. Smaltirla secondo la normativa in vigore (DPR 915/82, successive disposizioni e disposizioni locali). L'impiego di una batteria non adatta potrebbe determinare l'incendio o l'esplosione della batteria stessa.

リチウム・バッテリーは、火災、爆発、または重症のやけどを引き起こすことがあります。バックアップ・バッテリーの充電、その極性コネクターの取り外し、バッテリー本体の分解、100°C (212°F) 以上への加熱、焼却、電池の中身を水に浸すことはしないでください。バッテリーを廃棄する場合は地方自治体の条例に従ってください。適切なパーツ・リストにあるバッテリーだけを使用してください。誤ったバッテリーを使用すると、バッテリーが発火したり、爆発したりすることがあります。

La batería de repuesto es una batería de litio y puede provocar incendios, explosiones o quemaduras graves. No la recargue, ni quite el conector polarizado, ni la desmonte, ni caliente por encima de los 100°C (212°F), ni la incinerar ni exponga el contenido de sus celdas al agua. Deséchela tal como dispone la normativa local.

**Safety notice 5**

If the LCD breaks and the fluid from inside the LCD gets into your eyes or on your hands, immediately wash the affected areas with water at least for 15 minutes. Seek medical care if any symptoms caused by the fluid are present after washing.

Si le panneau d'affichage à cristaux liquides se brise et que vous recevez dans les yeux ou sur les mains une partie du fluide, rincez-les abondamment pendant au moins quinze minutes. Consultez un médecin si des symptômes persistent après le lavage.

Die Leuchtstoffröhre im LCD-Bildschirm enthält Quecksilber. Bei der Entsorgung die örtlichen Bestimmungen für Sondermüll beachten. Der LCD-Bildschirm besteht aus Glas und kann zerbrechen, wenn er unsachgemäß behandelt wird oder der Computer auf den Boden fällt. Wenn der Bildschirm beschädigt ist und die darin befindliche Flüssigkeit in Kontakt mit Haut und Augen gerät, sollten die betroffenen Stellen mindestens 15 Minuten mit Wasser abgespült und bei Beschwerden anschließend ein Arzt aufgesucht werden.

אם מסך הנביש הנוזלי (LCD) נשבר והנוזל מתוך המסך בא במגע עם עיניכם או ידיכם, שטפו את האזורים הנגועים מיד במים במשך 15 דקות לפחות. פנו לקבלת עזרה רפואית אם תסמינים הנובעים מהמגע עם הנוזל נמשכים לאחר השטיפה.

Nel caso che caso l'LCD si dovesse rompere ed il liquido in esso contenuto entrasse in contatto con gli occhi o le mani, lavare immediatamente le parti interessate con acqua corrente per almeno 15 minuti; poi consultare un medico se i sintomi dovessero permanere.

LCD が破損し、LCD の中の液体が目に入ったり、手に触れたりした場合は、液体が触れた部分を少なくとも 15 分間洗い流してください。洗い流した後に、液体によって何らかの症状が現れた場合は、医師の治療を受けてください。

Si la LCD se rompe y el fluido de su interior entra en contacto con sus ojos o sus manos, lave inmediatamente las áreas afectadas con agua durante 15 minutos como mínimo. Obtenga atención medica si se presenta algún síntoma del fluido despues de lavarse.



### Safety notice 6

#### DANGER

To avoid shock, do not remove the plastic cover that protects the lower part of the inverter card.

Afin d'éviter tout risque de choc électrique, ne retirez pas le cache en plastique protégeant la partie inférieure de la carte d'alimentation.

Aus Sicherheitsgründen die Kunststoffabdeckung, die den unteren Teil der Spannungswandlerplatine umgibt, nicht entfernen.

כדי למנוע התחשמלות, אין להסיר את מכסה הפלסטיק המגן על חלקו התחתון של הכרטיס ההפוך.

Per evitare scosse elettriche, non rimuovere la copertura in plastica che avvolge la parte inferiore della scheda invertitore.

感電を防ぐため、インバーター・カードの下部を保護しているプラスチック・カバーを外さないでください。

Para evitar descargas, no quite la cubierta de plástico que rodea la parte baja de la tarjeta invertida.

### Safety notice 7

#### DANGER

Though the main batteries have low voltage, a shorted or grounded battery can produce enough current to burn personnel or combustible materials.

Bien que le voltage des batteries principales soit peu élevé, le court-circuit ou la mise à la masse d'une batterie peut produire suffisamment de courant pour brûler des matériaux combustibles ou causer des brûlures corporelles graves.

Obwohl Hauptbatterien eine niedrige Spannung haben, können sie doch bei Kurzschluß oder Erdung genug Strom abgeben, um brennbare Materialien zu entzünden oder Verletzungen bei Personen hervorzurufen.

אף שהסוללות הראשיות הן בעלות מתח נמוך, סוללה מקוצרת או מוארקות עלולה להפיק זרם מספיק לגרימת כוויות או להצתת חומרים דליקים.

Sebbene le batterie di alimentazione siano a basso voltaggio, una batteria in corto circuito o a massa può fornire corrente sufficiente da bruciare materiali combustibili o provocare ustioni ai tecnici di manutenzione.

メイン・バッテリーの電圧は低くても、ショートしたり、接地したバッテリーが、作業者にやけどを負わせたり、可燃物を燃やすだけの電流を発生させる場合があります。

Aunque las baterías principales tienen un voltaje bajo, una batería cortocircuitada o con contacto a tierra puede producir la corriente suficiente como para quemar material combustible o provocar quemaduras en el personal.



**Safety notice 8**** DANGER**

Before removing any FRU, turn off the computer, unplug all power cords from electrical outlets, remove the battery pack, and then disconnect any interconnecting cables.

Avant de retirer une unité remplaçable en clientèle, mettez le système hors tension, débranchez tous les cordons d'alimentation des socles de prise de courant, retirez la batterie et déconnectez tous les cordons d'interface.

Die Stromzufuhr muß abgeschaltet, alle Stromkabel aus der Steckdose gezogen, der Akku entfernt und alle Verbindungskabel abgenommen sein, bevor eine FRU entfernt wird.

לפני סילוק FRU כלשהו, יש לכבות את המחשב, לנתק את כל כבלי החשמל משקעי החשמל, להוציא את מארזי הסוללה, וזו לנתק כבלי חיבור אחרים אם יש כאלה.

Prima di rimuovere qualsiasi FRU, spegnere il sistema, scollegare dalle prese elettriche tutti i cavi di alimentazione, rimuovere la batteria e poi scollegare i cavi di interconnessione.

**FRU** を取り外す前に、**ThinkPad** の電源を切って、すべての電源コードをコンセントから外してください。次に、バッテリー・パックを外し、相互接続ケーブルを外してください。

Antes de quitar una FRU, apague el sistema, desenchufe todos los cables de las tomas de corriente eléctrica, quite la batería y, a continuación, desconecte cualquier cable de conexión entre dispositivos.



---

## Important service information

---

This chapter presents the following important service information:

- “Strategy for replacing FRU” on page 14
  - “Strategy for replacing a hard disk drive” on page 15
  - “Important notice for replacing a system board” on page 15
- “Important information about replacing RoHS compliant FRU” on page 16

**Important:**

BIOS and device driver fixes are customer-installable. The BIOS and device drivers are posted on the customer support site:

<https://support.lenovo.com>.

## **Strategy for replacing FRU**

### **Before replacing parts:**

Make sure that all software fixes, drivers, and BIOS downloads are installed before replacing any FRU listed in this manual.

After a system board is replaced, ensure that the latest BIOS is loaded to the system board before completing the service action.

To download software fixes, drivers, and BIOS, follow the steps below:

1. Go to <https://support.lenovo.com>.
2. Enter the serial number or select a product or use Lenovo smart downloading.
3. Select the BIOS/Driver/Applications and download.
4. Follow the directions on the screen and install the necessary software.



Use the following strategy to prevent unnecessary expense for replacing and servicing FRU:

- If you are instructed to replace an FRU, but the replacement does not solve the problem, reinstall the original FRU before you continue.
- Some computers have both a processor board and a system board. If you are instructed to replace either of them, and replacing one of them does not solve the problem, reinstall that board, and then replace the other one.
- If an adapter or a device consists of more than one FRU, any of the FRU may be the cause of the error. Before replacing the adapter or device, remove the FRU one by one to see if the symptoms change. Replace only the FRU that changed the symptoms.

**Attention:** The setup configuration on the computer you are servicing may have been customized. Running Automatic Configuration may alter the settings. Note the current configuration settings (using the View Configuration option); then, when service has been completed, verify that those settings remain in effect.

## Strategy for replacing a hard disk drive

Always try to run a low-level format before replacing a hard disk drive. This will cause all customer data on the hard disk to be lost. Make sure that the customer has a current backup of the data before performing this action.

**Attention:** The drive startup sequence in the computer you are servicing may have been changed. Be extremely careful during write operations such as copying, saving, or formatting. If you select an incorrect drive, data or programs can be overwritten.

## Important notice for replacing a system board

Some components mounted on a system board are very sensitive. Improper handling can cause damage to those components, and may cause a system malfunction.

**Attention:** When handling a system board:

- Do not drop the system board or apply any excessive force to it.
- Avoid rough handling of any kind.
- Avoid bending the system board and hard pushing to prevent cracking at each BGA (Ball Grid Array) chipset.

## Important information about replacing RoHS compliant FRU

RoHS, The Restriction of Hazardous Substances in Electrical and Electronic Equipment Directive (2002/95/EC) is a European Union legal requirement affecting the global electronics industry. RoHS requirements must be implemented on Lenovo products placed on the market after June 2006. Products on the market before June 2006 are not required to have RoHS compliant parts. If the original FRU parts are non-compliant, replacement parts can also be non-compliant. In all cases if the original FRU parts are RoHS compliant, the replacement part must also be RoHS compliant.

**Note:** RoHS and non-RoHS FRU part numbers with the same fit and function are identified with unique FRU part numbers.

Lenovo plans to transit to RoHS compliance well before the implementation date and expects its suppliers to be ready to support Lenovo's requirements and schedule in the EU. Products sold in 2005 and 2006 will contain some RoHS compliant FRU. The following statement pertains to these products and any product Lenovo produces containing RoHS compliant FRU.

RoHS compliant FRU have unique FRU part numbers. Before or after the RoHS implementation date, failed RoHS compliant parts must always be replaced with RoHS compliant ones, so only the FRU identified as compliant in the system HMM or direct substitutions for those FRU may be used.

Products marketed before June 2006		Products marketed after June 2006	
Current or original part	Replacement FRU	Current or original part	Replacement FRU
Non-RoHS	Can be Non-RoHS	Must be RoHS	Must be RoHS
Non-RoHS	Can be RoHS		
Non-RoHS	Can sub to RoHS		
RoHS	Must be RoHS		

**Note:** A direct substitution is a part with a different FRU part number that is automatically shipped by the distribution center at the time of the order.



---

## General checkout

---

This chapter presents the following information:

- “What to do first” on page 18
- “Power system checkout” on page 19

Before you go to the checkout, make sure to read the following important notes:

**Important notes:**

- **Only certified trained personnel can service the computer.**
- **Before replacing any FRU, read the entire page on removing and replacing FRU.**
- **Carefully remove screws for reuse when replacing FRU.**
- **Be extremely careful during such write operations as copying, saving, or formatting.** Drives in the computer that you are servicing sequence might have been altered. If you select an incorrect drive, data or programs might be overwritten.
- **Replace an FRU only with another FRU of the correct model.** When you replace an FRU, make sure that the machine model and the FRU part number are correct by referring to the FRU parts list.
- **An FRU should not be replaced just because of a single, unreproducible failure.** Single failures can occur for a variety of reasons that have nothing to do with a hardware defect, such as cosmic radiation, electrostatic discharge, or software errors. Consider replacing an FRU only when a problem recurs. If you suspect that an FRU is defective, clear the error logs and run the test again. If the error does not recur, do not replace the FRU.
- **Be careful not to replace a nondefective FRU.**

## What to do first

When you do return an FRU, you must include the following information in the parts exchange form or parts return form that you attach to it:

1. Name and phone number of servicer
2. Date of service
3. Date on which the machine failed
4. Date of purchase
5. Procedure index and page number in which the failing FRU was detected
6. Failing FRU name and part number
7. Machine type, model number, and serial number
8. Customer's name and address

**Note for warranty:** During the warranty period, the customer may be responsible for repair costs if the computer damage was caused by misuse, accident, modification, unsuitable physical or operating environment, or improper maintenance by the customer.

The following is a list of some common items that are not covered under warranty and some symptoms that might indicate that the system was subjected to stress beyond normal use.

Before checking problems with the computer, determine whether the damage is covered under the warranty by referring to the following list:

**The following are not covered under warranty:**

- LCD panel cracked from the application of excessive force or from being dropped
- Scratched (cosmetic) parts
- Distortion, deformation, or discoloration of the cosmetic parts
- Plastic parts, latches, pins, or connectors that have been cracked or broken by excessive force
- Damage caused by liquid spilled into the system
- Damage caused by the improper insertion of a PC Card or the installation of an incompatible card
- Improper disk insertion or use of an optical drive
- Diskette drive damage caused by pressure on the diskette drive cover, foreign material in the drive, or the insertion of a diskette with multiple labels
- Damaged or bent diskette eject button
- Fuses blown by attachment of a nonsupported device
- Forgotten computer password (making the computer unusable)
- Sticky keys caused by spilling a liquid onto the keyboard
- Use of an incorrect AC adapter on laptop products

**The following symptoms might indicate damage caused by nonwarranted activities:**

- Missing parts might be a symptom of unauthorized service or modification.
- If the spindle of a hard disk drive becomes noisy, it may have been subjected to excessive force, or dropped.



## Power system checkout

To verify a symptom, follow the steps below:

1. Turn off the computer.
2. Remove the battery pack.
3. Connect the AC adapter.
4. Make sure that power is supplied when you turn on the computer.
5. Turn off the computer.
6. Disconnect the AC adapter and install the charged battery pack.
7. Make sure that the battery pack supplies power when you turn on the computer.

If you suspect a power problem, see the appropriate one of the following power supply checkouts:

- “Checking the AC adapter” on page 21
- “Checking operational charging” on page 21
- “Checking the battery pack” on page 22

### Checking the AC adapter

You are here because the computer fails only when the AC adapter is used.

- If the power-on indicator does not turn on, check the power cord of the AC adapter for correct continuity and installation.
- If the computer does not charge during operation, go to “Checking operational charging”.

To check the AC adapter, follow the steps below:

1. Unplug the AC adapter cable from the computer.
2. Measure the output voltage at the plug of the AC adapter cable. See the following figure:

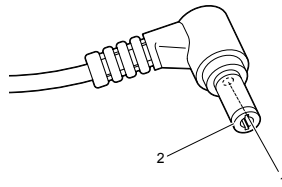

Pin	Voltage (V DC)
1	+20
2	0

**Note:** Output voltage for the AC adapter pin No. 2 may differ from the one you are servicing.

3. If the voltage is not correct, replace the AC adapter.
4. If the voltage is acceptable, do the following:
  - Replace the system board.
  - If the problem persists, go to “Lenovo BS145-15IGM/BS145-15IWL/IdeaPad S145-14API/IdeaPad S145-14AST/IdeaPad S145-14IGM/IdeaPad S145-14IKB/IdeaPad S145-14IML/IdeaPad S145-14IWL/Lenovo IdeaPad S145-14IIL/IdeaPad S145-15API/IdeaPad S145-15AST/IdeaPad S145-15IGM/IdeaPad S145-15IKB/IdeaPad S145-15IML/IdeaPad S145-15IWL/Lenovo IdeaPad S145-15IIL” on page 26
  - **Note:** Noise from the AC adapter does not always indicate a defect.



## Checking operational charging

To check whether the battery charges properly during operation, use a discharged battery pack or a battery pack that has less than 50% of the total power remaining when installed in the computer.

Perform operational charging. If the battery status indicator or icon does not light on, remove the battery pack and let it return to room temperature. Reinstall the battery pack. If the charge indicator or icon is still off, replace the battery pack.

If the charge indicator still does not light on, replace the system board. Then reinstall the battery pack. If it is still not charged, go to the next section.

## Checking the battery pack

Battery charging does not start until the Power Meter shows that less than 95% of the total power remains; under this condition the battery pack can charge to 100% of its capacity. This protects the battery pack from being overcharged or from having a shortened life.

To check your battery, move your cursor to the Power Meter icon in the icon tray of the Windows<sup>®</sup> taskbar and wait for a moment (but do not click it), and the percentage of battery power remaining is displayed. To get detailed information about the battery, double-click the Power Meter icon.

**Note:** If the battery pack becomes hot, it may not be able to be charged. Remove it from the computer and leave it at room temperature for a while. After it cools down, reinstall and recharge it.



---

## **Related service information**

---

This chapter presents the following information:

- “Passwords” on page 22
- “Power management” on page 23

## Passwords

As many as three passwords may be needed for any Lenovo computer: the power-on password (POP), the hard disk password (HDP), and the administrator password.

If any of these passwords has been set, a prompt for it appears on the screen whenever the computer is turned on. The computer does not start until the password is entered.

### Power-on password

A power-on password (POP) protects the system from being powered on by an unauthorized person. The password must be entered before an operating system can be booted.

### Hard-disk password

There are two hard-disk passwords (HDPs):

+ User HDP - for the user

+ Master HDP - for the system administrator, who can use it to get access to the hard disk drive even if the user has changed the user HDP

Attention: If the user HDP has been forgotten, check whether a master HDP has been set. If it has, it can be used for access to the hard disk drive. If no master HDP is available, neither Lenovo nor Lenovo authorized service technicians provide any services to reset either the user or the master HDP, or to recover data from the hard disk drive. The hard disk drive can be replaced for a scheduled fee.

### Administrator password

Administrator password controls the access of the whole setup utility. Only after the Administrator password has been set can the User password be set. If Administrator password was cleared, the User password was cleared too.



## Power management

**Note:** Power management modes are not supported for APM operating system.

To reduce power consumption, the computer has three power management modes: screen blank, sleep (standby), and hibernation.

### Screen blank state

If the time set on the “Turn off monitor” timer in the operating system expires, the LCD backlight turns off. You can also turn off the LCD backlight by pressing .

To end screen blank state and resume normal operation, press any key on the keyboard.

### Putting the computer to sleep or shutting it down

When you have finished working with your computer, you can put it to sleep or shut it down.

### Putting your computer to sleep

If you will be away from your computer for only a short time, put the computer to sleep.

When the computer is in sleep mode, you can quickly wake it to resume use, bypassing the startup process.

To put the computer to sleep, do one of the following:

- Close the display lid.
- Press and hold the Power key for about 1 to 5 seconds.
- **Move the cursor to the lower-left corner, and then select the Start button. Select Power  → Sleep.**

**Note:** Put your computer to sleep before you move it. Moving your computer while the hard disk drive is spinning can damage the hard disk, causing loss of data.

To wake up the computer, perform the following:

- Press any key on the keyboard.

## Shutting down the computer

If you are not going to use your computer for a long time, shut it down.  
To shut down your computer, do one of the following:

- Move the cursor to the lower-left corner, and then select the Start button. Select **Power**  → **Shut down**.

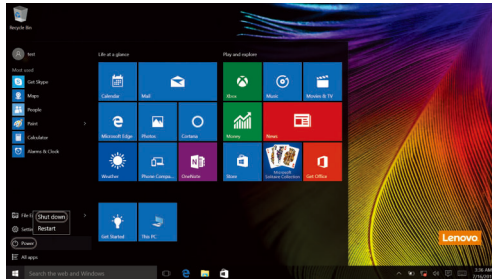

- Right-click the Start button in the lower-left corner and select **Shut down or sign out** → **Shut down**.

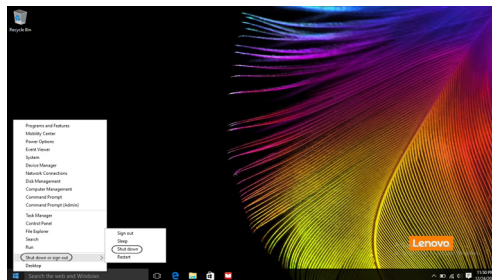



---

## **Lenovo BS145-15IGM/BS145-15IWL/IdeaPad S145-14API/IdeaPad S145-14AST/IdeaPad S145-14IGM/IdeaPad S145-14IKB/IdeaPad S145-14IML/IdeaPad S145-14IWL/Lenovo IdeaPad S145-14IIL/IdeaPad S145-15API/IdeaPad S145-15AST/IdeaPad S145-15IGM/IdeaPad S145-15IKB/IdeaPad S145-15IML/IdeaPad S145-15IWL/Lenovo IdeaPad S145-15IIL**

---

This chapter presents the following product-specific service references and product-specific parts information:

- “Locations” on page 26
- “Specifications” on page 25
- “Status indicators” on page 27
- “Hotkeys” on page 28
- “FRU replacement notices” on page 29
- “Removing and replacing an FRU” on page 30
- “Locations” on page 27
- “Parts list” on page 34

## Locations

### Front view and right-side view

- 1 Microphone
- 2 Camera
- 3 Camera light
- 4 Wireless LAN/Bluetooth antennas
- 5 Screen
- 6 Power Key
- 7 SD card slot
- 8 Audio connector
- 9 Novo button
- 10 Touchpad

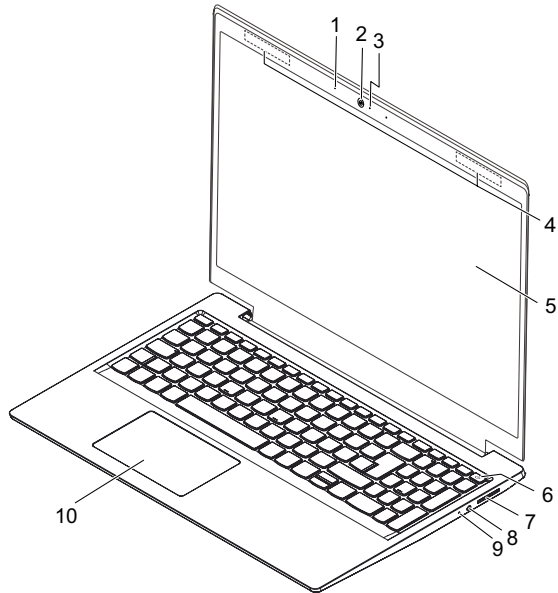

Figure 1. Front view and right-side view



## Bottom and left-side view

- 1 Ventilation slots
- 2 ac power adapter jack
- 3 Charging light
- 4 HDMI™ connector
- 5 USB 2.0 connector
- 6 USB 3.1 connector Gen 1
- 7 Power light
- 8 Speakers

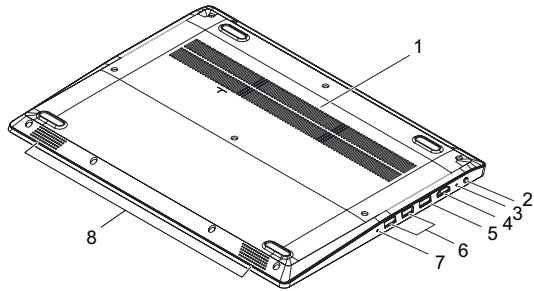

Figure 2. Bottom and left-side view



## Specifications

The following table lists the specifications of the Lenovo BS145-15IGM/BS145-15IWL/IdeaPad S145-14API/IdeaPad S145-14AST/IdeaPad S145-14IGM/IdeaPad S145-14IKB/IdeaPad S145-14IML/IdeaPad S145-14IWL/Lenovo IdeaPad S145-14IIL/IdeaPad S145-15API/IdeaPad S145-15AST/IdeaPad S145-15IGM/IdeaPad S145-15IKB/IdeaPad S145-15IML/IdeaPad S145-15IWL/Lenovo IdeaPad S145-15IIL:

Table 1. Specifications

<b>Form Factor</b>	
Dimensions	14-inch models: Approximately 327.1 mm (12.87 inches) x 241 mm (9.48 inches) x 19.9 mm (0.78 inches) 15-inch models: Approximately 362.2 mm (14.25 inches) x 251.5 (9.90 inches) x 19.9 mm (0.78 inches)
Weight	Approximately 2.0 kg with battery
LCD size	14-inch models: 355.6 mm (14.0 inches) 15-inch models: 396.2 mm (15.6 inches)
<b>Processor</b>	
See the system properties of your computer, you can do this as follows: Click <b>Control Panel</b> , then click <b>Hardware and Sound</b> , click <b>Device Manager</b> under <b>Devices and Printers</b> and double click <b>Processors</b> .	
<b>Memory</b>	
Type and speed	On board (on BS145-15IWL, S145-14API, S145-14IKB, S145-14IML, S145-14IWL, S145-14IIL, S145-15API, S145-15IKB, S145-15IML, S145-15IWL, and S145-15IIL only), DDR4-2133 MHz / DDR4 2400 MHz
Maximum supported capacity	8 GB + 4 GB on board (on BS145-15IWL, S145-14API, S145-14IKB, S145-14IML, S145-14IWL, S145-14IIL, S145-15API, S145-15IKB, S145-15IML, S145-15IWL, and S145-15IIL only)
<b>SSD</b>	
Interface	2.5-inch SATA SSD, M.2 PCIe SDD
<b>Hard disk drive</b>	
Form factor	2.5-inch, 7 mm
Capacity	500 GB, 1 TB, 2 TB
Interface	SATA



Table 1. Specifications (continued)

<b>Display</b>	
Display resolution	1366 × 768 pixels HD/1920 × 1080 pixels FHD
LCD backlight	LED
<b>I/O Ports</b>	
USB	USB 3.1 connector Gen 1 × 2, USB 2.0 × 1
Audio	Combo audio jack × 1
Video/Audio	HDMI slot × 1
Memory card slot	SD card × 1
<b>Battery pack</b>	
Type	Polymer
Cells/Capacity	2 cells, 30 Wh/35 Wh
<b>Note:</b> The capacity given here is the typical or average capacity as measured in a specific test environment. Capacities measured in other environments may differ but are no lower than the rated capacity (see product label).	
<b>ac power adapter</b>	
Input	100-240 V, 50-60 Hz
Output voltage	20 V DC
Power	<ul style="list-style-type: none"><li>• BS145-15IGM, S145-14IGM, S145-15IGM: 45W</li><li>• S145-14API, S145-15API: 65W</li><li>• BS145-15IWL, S145-14AST, S145-14IKB, S145-14IML, S145-14IWL, S145-14IIL, S145-15AST, S145-15IKB, S145-15IML, S145-15IWL, S145-15IIL: 45/65W</li></ul>
<b>Miscellaneous</b>	
Camera	640 × 480 pixels
Security	Password

## Status indicators

The system status indicators below show the computer status:

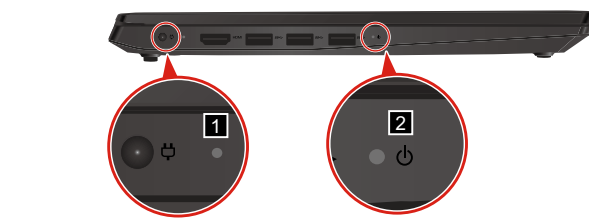

Table 2. Status indicators

ac power adapter status	Indicator status	Meaning
Disconnected	Off	The computer is not connected to ac power.
	Amber	The battery has between 1% and 90% charge and is still charging.
Connected	White	The battery has between 91% and 100% charge.













Indicator	Indicator status	Meaning
Power status indicator	White (solid on)	The computer is on (battery power 21%-100%).
	White (fast blinking)	The computer is on (battery power 1%-20%).
	White (slow blinking)	The computer is in sleep mode.
	Off	The computer is off or in hibernation mode.



## Hotkeys

You can access certain system settings quickly by pressing the appropriate hotkeys.

Table 3. Hotkeys

	: Mute/unmute sound.		: Turn on/off airplane mode.
	: Decrease system volume.		: Enable/Disable the integrated camera.
	: Increase system volume.		: Lock/Unlock the LCD screen.
	: Enable/Disable the integrated microphone.		: Enable the external projector or dangle the external display.
	: Refresh page.		: Decrease display brightness.
	: Enable/Disable the touchpad.		: Increase display brightness.

## Service tools

The following table lists tools for servicing Lenovo computers. Tools with a cross mark are needed for servicing the product model as described by this publication. Prepare them before you service the product.

Table 4. Service tools

Service tool and consumable	Model applicability
Screw driver (Phillips head)	X
Screw driver (Torx head) (T5)	
Screw driver (Torx head) (T30)	
Pry tool 1	X
Tweezers (conductive)	X
Tweezers (isolated)	
Suction cup	
Hexagonal socket	
Silicone grease	
Polyamide tape	
Mylar tape	
Electrical tape	
Double-sided tape	
Conductive tape	
Eraser	
Heat gun	
Brown brush	

**Note:**

- T30 screw drivers are used to service the new Intel Xeon CPUs
- Hexagonal sockets are used to remove antenna connectors
- Silicone grease is applied to the CPU and heatsink surfaces to eliminate air gaps.



---

## Parts list

This section presents the following service parts:

- “Overall” on page 35
- “LCD FRU” on page 37

**Note:**

Each FRU is available for all types or models, unless specific types or models are specified.

**Attention:**

Do not attempt to replace an FRU on your own. If an FRU is damaged, contact a Lenovo authorized servicer or a marketing representative for replacement or repair. Only qualified technicians can inspect or repair this product.

## Overall

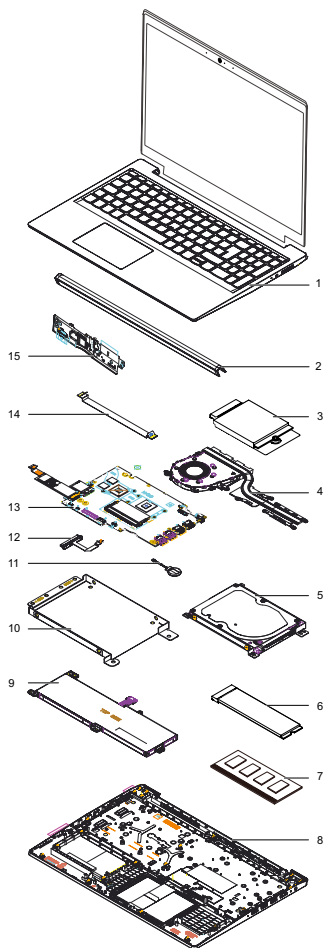

Figure 3. Lenovo IdeaPad S145 Series exploded view



Table 5. FRU (CRU) category

No.	FRU (CRU) category	Self-service CRU	Optional-service CRU
1	Upper case (with keyboard)	No	No
2.	Hinge cap	No	No
3.	WLAN card	No	No
4.	Thermal module and Fan	No	No
5.	Hard disk drive (HDD)	No	No
6.	Solid-state drive (SSD)	No	No
7.	Memory	No	No
8.	Lower case	No	No
9.	Battery	No	No
10.	Hard disk drive (HDD) bracket	No	No
11	CMOS battery	No	No
12	Hard disk drive (HDD) board connector	No	No
13	System board	No	No
14	I/O board FCC	No	No
15	I/O board	No	No



## LCD FRU

In Lenovo IdeaPad S145 Series, there is following type of LCD:

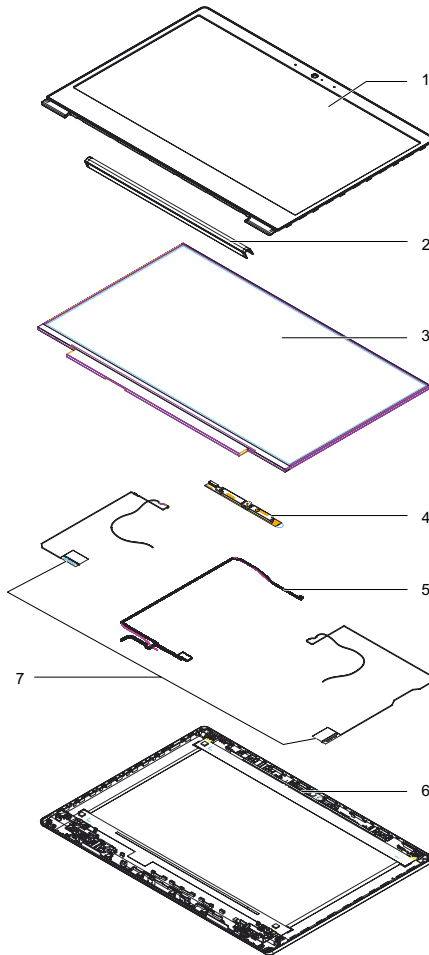

Figure 4 . Lenovo IdeaPad S145 Series exploded view



Table 6. FRU categories for the LCD module

No.	FRU (CRU) category	Self-service CRU	Optional-service CRU
1.	LCD bezel	No	No
2.	Hinge cap	No	No
3.	LCD panel	No	No
4.	Integrated camera	No	No
5.	LCD cable	No	No
6.	LCD cover	No	No
7.	Wifi antenna	No	No
8.	Hinge bracket*	No	No
9.	Removable tapes*	No	No

\*Not shown in the illustration.

## FRU replacement notices

This section presents notices related to removing and replacing parts. Read this section carefully before replacing any FRU.

### Screw notices

Loose screws can cause a reliability problem. In the Lenovo computer, this problem is addressed with special nylon-coated screws that have the following characteristics:

- They maintain tight connections.
- They do not easily come loose, even with shock or vibration.
- They are harder to tighten.
- Each one should be used only once.

Do the following when you service this machine:

- Keep the screw kit in your tool bag.
- Carefully remove screws for reuse when replacing FRU.
- Use a torque screwdriver if you have one.

Tighten screws as follows:

- **Plastic to plastic**

Turn an additional 90° after the screw head touches the surface of the plastic part:

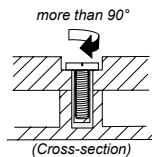

- **Logic card to plastic**

Turn an additional 180° after the screw head touches the surface of the logic card:

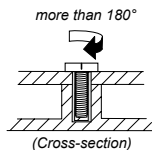

- **Torque driver**

If you have a torque screwdriver, refer to the "Torque" column for each step.

- Make sure that you use the correct screws. If you have a torque screwdriver, tighten all screws firmly to the torque shown in the table. **Carefully remove screws for reuse when replacing FRU. Make sure that all screws are tightened firmly.**
- Ensure torque screwdrivers are calibrated correctly following country specifications.



## Removing and replacing FRU

This section presents exploded figures with the instructions to indicate how to remove and replace the FRU. Make sure to observe the following general rules:

1. Do not attempt to service any computer unless you have been trained and certified. An untrained person runs the risk of damaging parts.
2. Before replacing any FRU, review "FRU replacement notices" on page 31.
3. Begin by removing FRU that has to be removed before the failing FRU. Any of such FRU are listed at the top of the page. Remove them in the order in which they are listed.
4. Follow the correct sequence in the steps to remove the FRU, as given in the figures by the numbers in square callouts.
5. When turning a screw to replace an FRU, turn it in the direction as given by the arrow in the figure.
6. When removing the FRU, move it in the direction as given by the arrow in the figure.
7. To put the new FRU in place, reverse the removal procedures and follow any of the notes that pertain to replacement. For information about connecting and arranging internal cables, see "Locations" on page 27.
8. When replacing an FRU, use the correct screw as shown in the procedures.

### DANGER

Before removing any FRU, turn off the computer, unplug all power cords from electrical outlets, remove the battery pack, and then disconnect any of the interconnecting cables.

**Attention:** After replacing an FRU, do not turn on the computer until you have made sure that all screws, springs, and other small parts are in place and none are loose inside the computer. Verify this by shaking the computer gently and listening for rattling sounds. Metallic parts or metal flakes can cause electrical short circuits.

**Attention:** The system board is sensitive to, and can be damaged by, electrostatic discharge. Before touching it, establish personal grounding by touching a ground point with one hand or using an electrostatic discharge (ESD) strap (P/N 6405959) to remove potential shock reasons.

## 1010 Base cover

Step 1: Remove the screws 1 and 2.

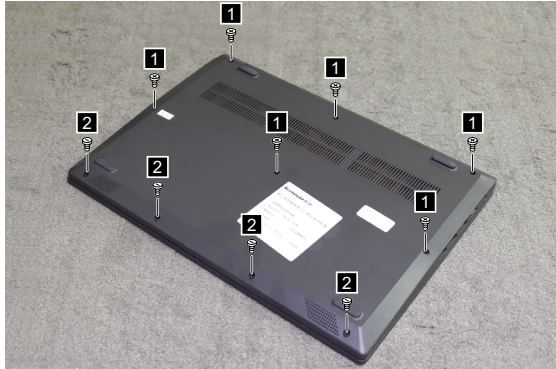

Figure 5. Remove the screws

Step	Screw (quantity)	Color	Torque
1	M2.5 × 7 mm, Phillips-head, nylok-coated (6)	Black/ Silver	3.0+/-0.3 kgf/cm
1	M2.5 × 4 mm, Flat-head, nylok-coated (4)	Black	3.0+/-0.3 kgf/cm



Step 2: Remove the base cover in the directions shown by arrows 2 and 3.

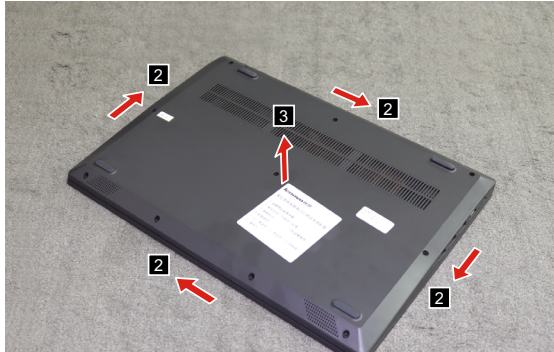

Figure 6. Remove the base cover

## 1020 Battery pack

**⚠ DANGER**

Only use the battery specified in the parts list for your computer. Any other battery could ignite or explode.

For access, remove the FRU in following order:

- “1010 Base cover” on page 41

Step 1: Detach cables from the battery pack connector in the direction shown by arrow 1.

Step 2: Remove the screws 2.

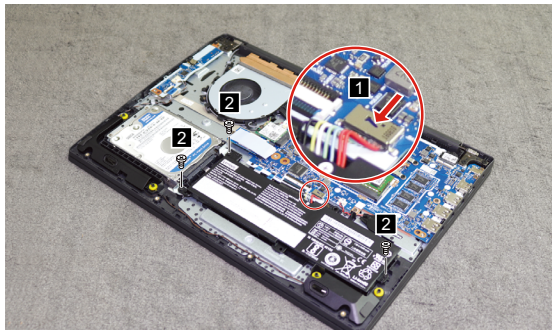

Figure 7. Detach cables and remove the screws

Step	Screw (quantity)	Color	Torque
2	M2 × 6 mm, Phillips-head, nylok-coated (3)	Black	1.85+/-0.15 kgf/cm



Step 3: Remove the battery pack in the direction shown by arrow 3.



Figure 8. Remove the battery pack



## 1030 SSD

For access, remove the FRU in following order:

- “1010 Base cover” on page 41
- “1020 Battery pack” on page 43

Step 1: Remove the screw 1.



Figure 9. Remove the screws

Step	Screw (quantity)	Color	Torque
1	M2 × 6 mm, Phillips-head, nylok-coated (1)	Black	1.85+/-0.15 kgf/cm

Step 2: Remove the SSD in the direction shown by arrow 2.



Figure 10. Remove the SSD



## 1040 DIMM

For access, remove the FRU in following order:

- “1010 Base cover” on page 41
- “1020 Battery pack” on page 43

Step 1: Release the two latches on both edges of the socket at the same time in the directions shown by arrows 1.

Step 2: Unplug the DIMM in the direction shown by arrow 2.

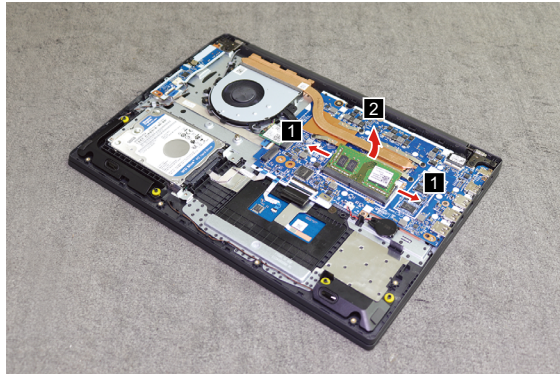

Figure 11. Release the latch and remove the DIMM

## 1050 Hard disk drive

For access, remove the FRU in following order:

- “1010 Base cover” on page 41
- “1020 Battery pack” on page 43

**Attention:**

- **Do not drop the hard disk drive or apply any physical shock to it.** The hard disk drive is sensitive to physical shock. Improper handling can cause damage and permanent loss of data.
- Before removing the drive, suggest the customer to backup all the information on it if possible.
- Never remove the drive while the system is operating or in suspend mode.

Step 1: Remove the screws 1.

Step 2: Pull the hard disk drive in the direction shown by arrow 2.

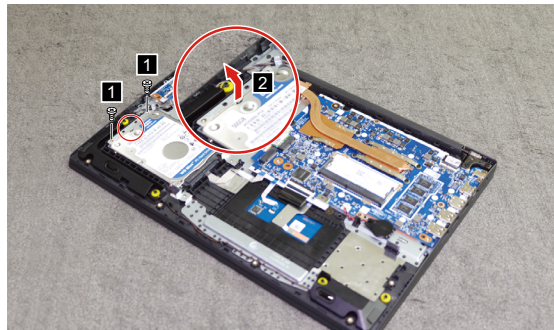

Figure 12. Remove the screws and the hard disk

Step	Screw (quantity)	Color	Torque
1	M2 × 6 mm, Phillips-head, nylok-coated (2)	Black	1.85+/-0.15 kgf/cm



- Step 3: Release the latch on the connector as shown by arrow 3.
- Step 4: Disconnect the cable from the connector as shown by arrow 4.
- Step 5: Remove the HDD board in the direction shown by arrow 5.

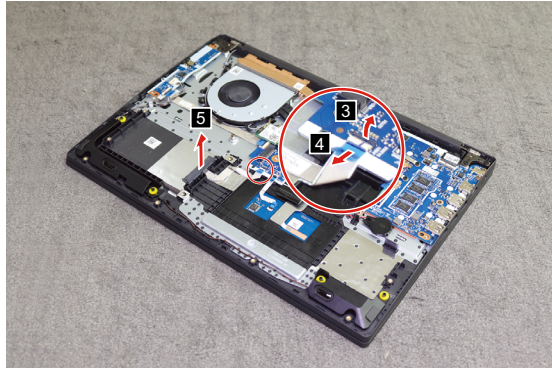

Figure 13. Disconnect the cable and remove the HDD board

**When installing:** Make sure that the HDD cable is firmly connected to the connector.

- Step 6: Detach the bracket from the hard disk drive.

## 1060 PCI Express Mini Card for wireless LAN

For access, remove the FRU in following order:

- “1010 Base cover” on page 41
- “1020 Battery pack” on page 43

### Important:

The preinstalled WLAN module may only be replaced with a Lenovo approved module in order to comply with FCC and IC regulations. Refer to Table 4 “Parts list—Overall” on page 35 for Lenovo part numbers for the approved modules.

Step 1: Remove the screw 1.

Step 2: Disconnect the two wireless LAN cables (black, gray) 2.

Unplug the jacks by using the removal tool antenna RF connector (P/N: 08K7159), or pick up the connectors with your fingers and gently unplug them in the direction shown by the arrows.

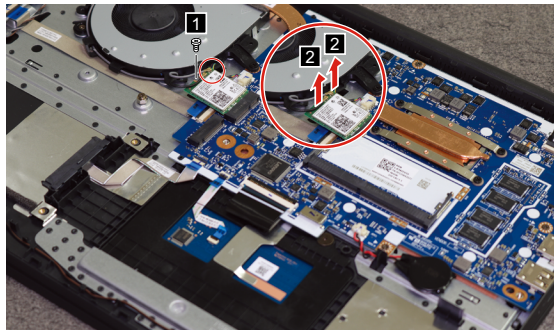

Figure 14. Remove the screw and disconnect the wireless LAN cables

**Notes:** The wireless LAN card has 2 cables in step 2.

The wireless LAN card in some models might have 3 cables in step 2.

Step	Screw (quantity)	Color	Torque
1	M2 × 3 mm, Phillips-head, nylok-coated (1)	Silver	1.85+/-0.15 kgf/cm



Step 3: Remove the PCI express mini card in the direction shown by arrow 3.

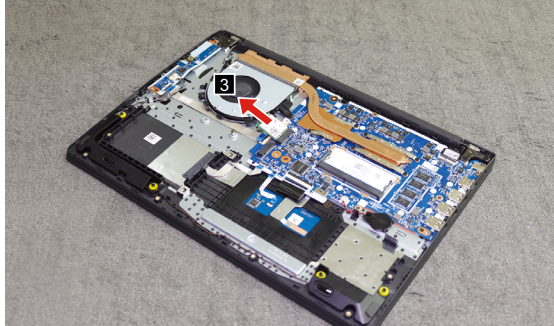

Figure 15. Disconnect the cable and remove the HDD board

**When installing:**

- Wireless LAN card with two antenna connectors: Plug the black cable (1st) (MAIN) into the jack labeled **MAIN**, and the grey cable (2nd) (AUX) into the jack labeled **AUX** on the card.
- Wireless LAN card with three antenna connectors: Plug the black cable (1st) (MAIN) into the jack labeled **1**, the grey cable (3rd) into the jack labeled **3**, and the white cable (2nd) (AUX) into the jack labeled **2** on the card.

## 1070 Fan assembly and Heat Sink assembly

For access, remove the FRU in following order:

- "1010 Base cover" on page 41
- "1020 Battery pack" on page 43

Step 1: Release the cables from the cable guides in the direction shown by arrows 1.

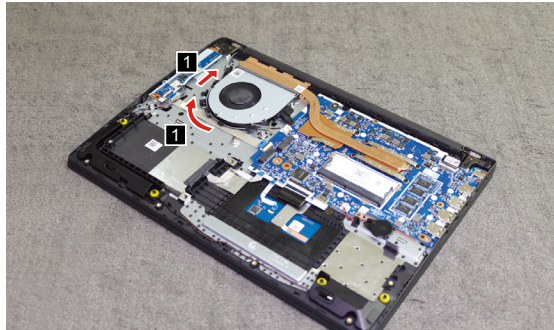

Figure 16. Release the cables

**When installing:** Route the antenna cables along the cable guides. As you route the cables, make sure that they are not subjected to any tension. Tension could cause the cables to be damaged by the cable guides, or a wire to be broken.



Step 2: Unplug the fan connector in the direction shown by arrow 2.

Step 3: Remove the screws 3.

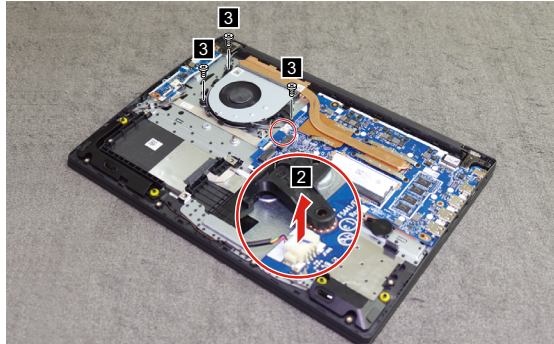

Figure 17. Unplug the fan connector and remove the screws

Step	Screw (quantity)	Color	Torque
3	M2 × 6 mm, Phillips head, nylok-coated (3)	Black	1.85+/-0.15 kgf/cm

**When installing:** Make sure that the connector is attached firmly.

Step 4: Remove the fan in the direction shown by arrow 4.

Be careful not to damage the connector.

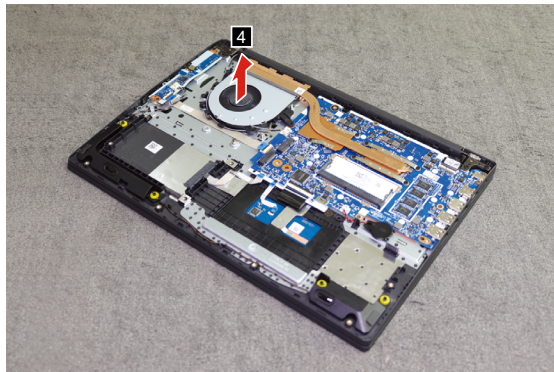

Figure 18. Remove the fan



Step 5: Remove the screws 5.

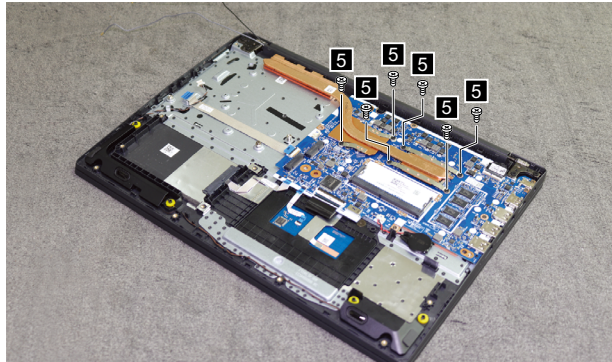

Figure 19. Remove the screws

Step	Screw (quantity)	Color	Torque
5	M2 × 6 mm, Phillips head, nylok-coated (6)	Black	1.85+/-0.15 kgf/cm

Step 6: Lift the heat sink in the direction shown by arrow 6.

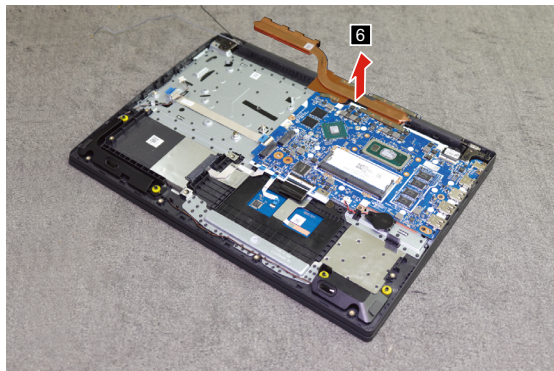

Figure 20. Remove the heat sink



## 1080 I/O board

For access, remove the FRU in following order:

- “1010 Base cover” on page 41
- “1020 Battery pack” on page 43

Step 1: Disconnect the speaker cable from the connector as shown by arrow 1.

Step 2: Disconnect the mainboard cable from the connector as shown by arrow 2.

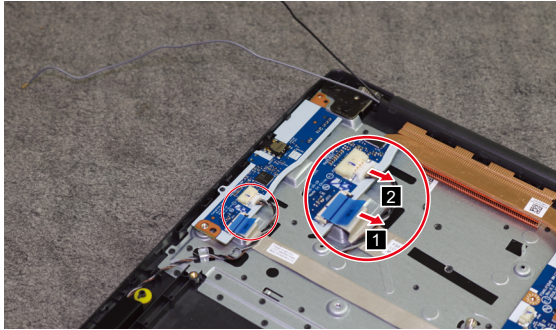

Figure 21. Disconnect the speaker cable and mainboard cable

Step 3: Remove the screws 3.

Step 4: Remove the I/O board in the direction shown by arrow 4.

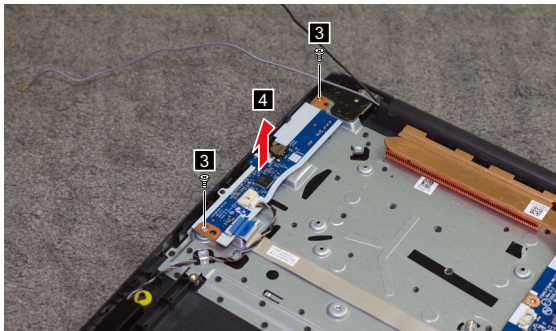

Figure 22. Remove the screws and the I/O board

Step	Screw (quantity)	Color	Torque
3	M2 × 3 mm, Phillips-head, nylok-coated (2)	Silver	1.85+/-0.15 kgf/cm

## 1090 Backup battery

For access, remove the FRU in following order:

- "1010 Base cover" on page 41
- "1020 Battery pack" on page 43

Step 1: Disconnect the backup battery cable in the direction shown by arrow 1.

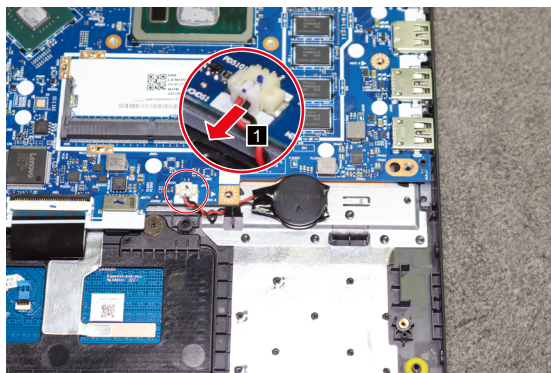

Figure 23. Disconnect the backup battery cable



Step 2: Remove the backup battery in the direction shown by arrow 2.

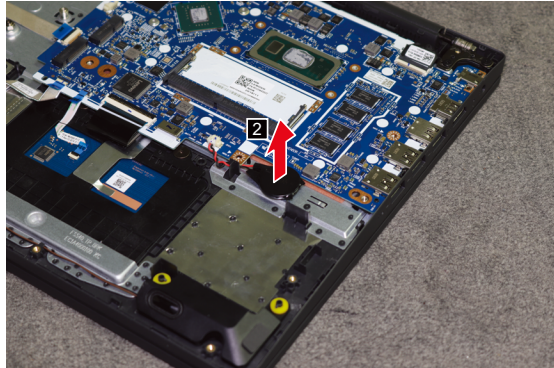

Figure 24. Remove the backup battery

**When installing:** Make sure that the backup battery cable is attached firmly to the connector.

## 1100 System board

### Important notices for handling the system board:

When handling the system board, bear the following in mind.

- Be careful not to drop the system board on a bench top that has a hard surface, such as metal, wood, or composite.
- Avoid rough handling of any kind.
- During the whole process, make sure not to drop or stack the system board.
- If you put a system board down, make sure to put it only on a padded surface such as an ESD mat or conductive corrugated material.

For access, remove the FRU in following order:

- "1010 Base cover" on page 41
- "1020 Battery pack" on page 43
- "1030 SSD" on page 45
- "1040 DIMM" on page 46
- "1060 PCI Express Mini Card for wireless LAN" on page 49
- "1070 Fan assembly and Heat Sink assembly" on page 51

Step 1: Release the latch on the connector as shown by arrows 1.

Step 2: Disconnect the cables as shown by arrows 2.

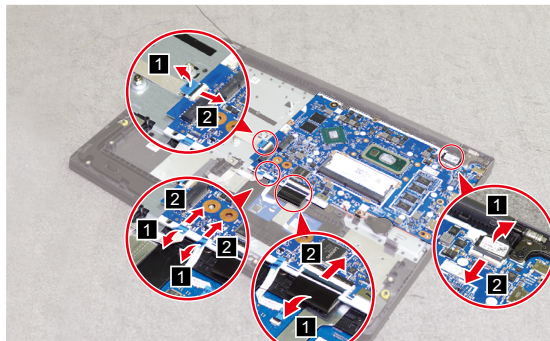

Figure 25. Disconnect the cables



Step 2: Remove the screws 3.

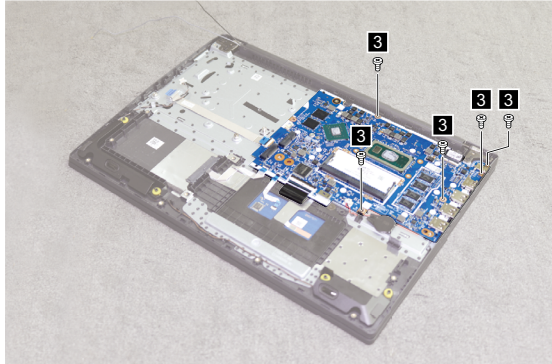

Figure 26. Remove the screws

Step	Screw (quantity)	Color	Torque
2	M2 × 3 mm, Phillips-head, nylok-coated (5)	Silver	1.85+/-0.15 kgf/cm

Step 3: Remove the system board in the direction shown by arrow 4.

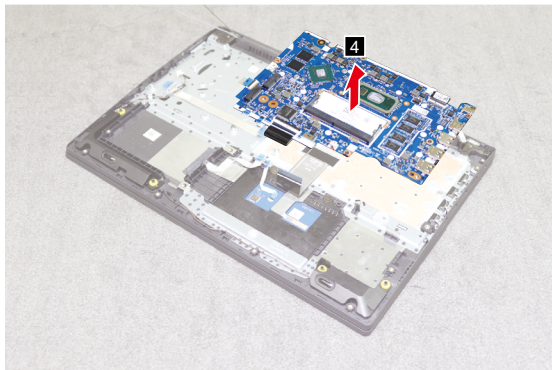

Figure 27. Remove the system board

## 1110 Upper case

For access, remove the FRU in following order:

- “1010 Base cover” on page 41
- “1020 Battery pack” on page 43

Step 1: Remove the screws 1.

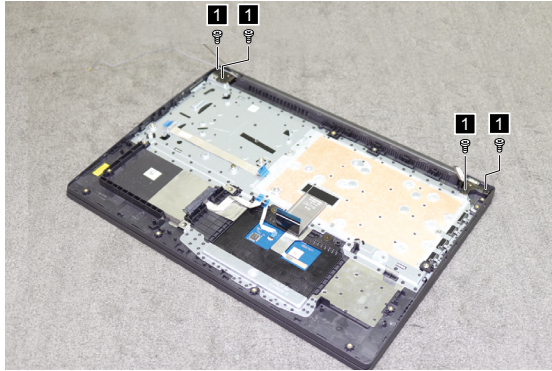

Figure 28. Remove the screws

Step	Screw (quantity)	Color	Torque
1	M2.5 × 5 mm, Phillips-head, nylok-coated (4)	Black	3+/-0.3 kgf/cm



Step 2: Release the latch on the connector as shown by arrow 2.

Step 3: Disconnect the LCD cable from the connector as shown by arrow 3.

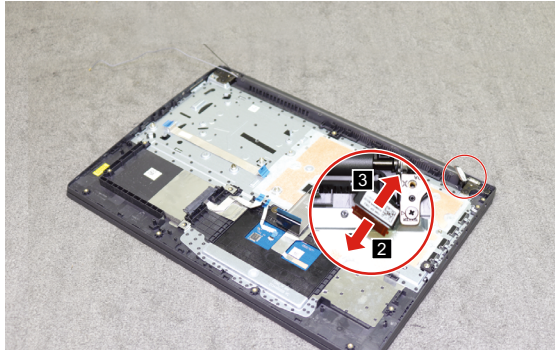

Figure 29. Open the hinge

Step 4: Open the hinge in the direction shown by arrows 4.

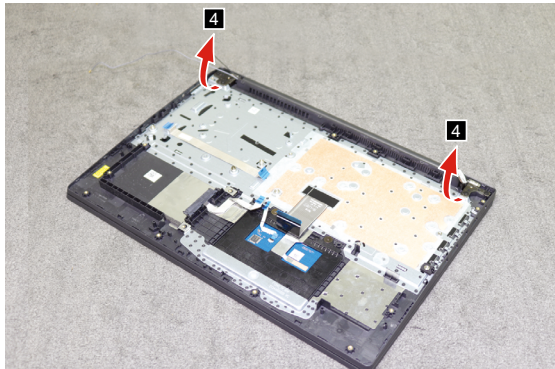

Figure 30. Open the hinge



Step 5: Remove the upper case from the LCD module in the direction shown by arrow 5.

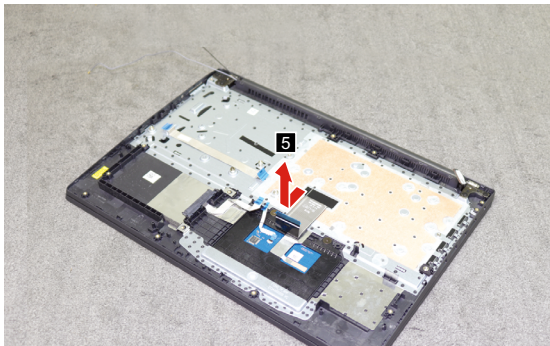

Figure 31. Remove the upper case



## 1120 LCD unit

For access, remove the FRU in following order:

- “1010 Base cover” on page 41
- “1020 Battery pack” on page 43
- “1110 Upper case” on page 59

Step 1: Remove the hinge cover in the direction shown by arrow 1.

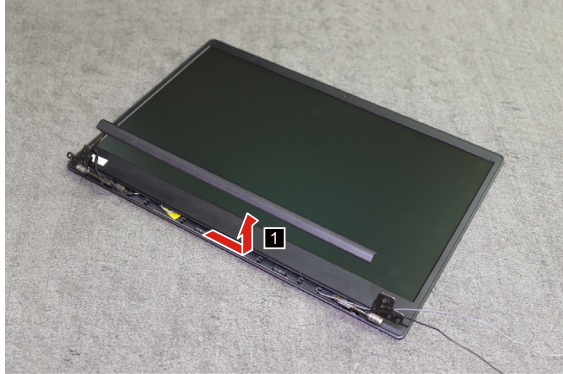

Figure 32. Remove the hinge cover

Step 2: Remove the LCD bezel in the direction shown by arrows 2.

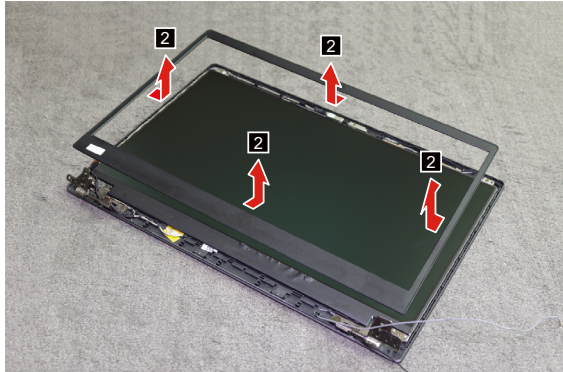

Figure 33. Remove the LCD bezel

Step 3: Remove the screws 3.

Step 4: Lift the LCD module and hinge together as shown by arrow 4.

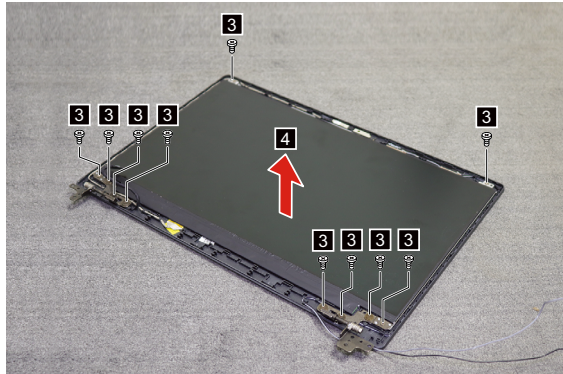

Figure 34. Remove the screws

Step	Screw (quantity)	Color	Torque
3	M2 × 3 mm, Phillips-head, nylok-coated (10)	Silver	1.85+/-0.15 kgf/cm

Step 5: Disconnect the cable in the direction shown by arrow 5.

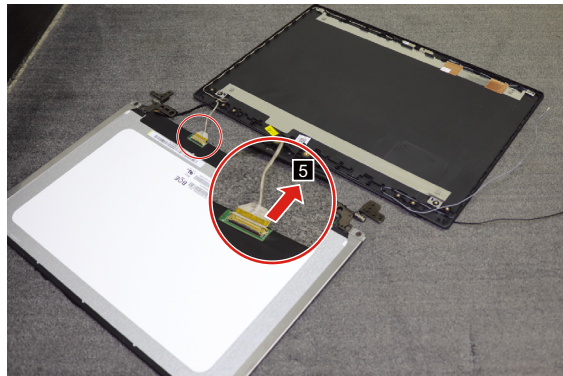

Figure 35. Disconnect the cable



Step 6: Pull out the stretch adhesive tape on the hinge from the rear. Refer to the illustration below for location of the stretch adhesive tape. Remove the LCD hinges in the direction shown by arrows 6.

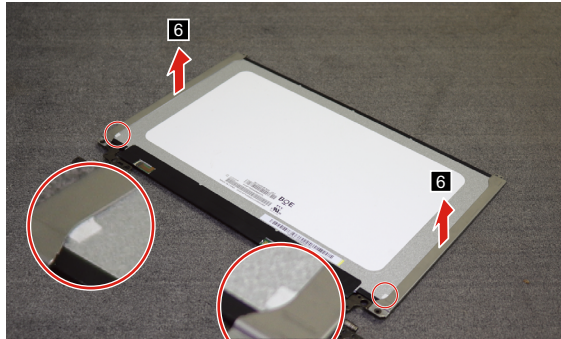

Figure 36. Pull out the stretch adhesive

**When installing:** Make sure that the connector is attached firmly and that you do not pinch the antenna cables when you attach the LCD assembly. Route the LCD cable along the cable guides.

## 1130 Integrated camera and antenna assembly

For access, remove the FRU in following order:

- "1010 Base cover" on page 41
- "1020 Battery pack" on page 43
- "1110 Upper case" on page 59
- "1120 LCD unit" on page 62

**Note:** The integrated camera is stuck on the top center of the LCD cover.

Step 1: Remove the integrated camera in the direction shown by arrow 1.

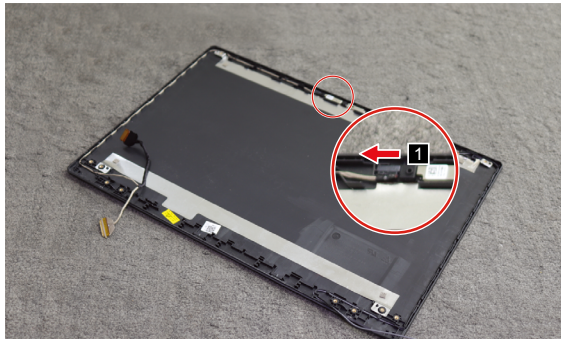

Figure 37. Remove the integrated camera

**When installing:** Stick the integrated camera to the top center of the LCD cover and adjust its placement to make sure the connector is attached firmly.



- Step 2: Peel off the adhesive tape securing the antenna boards.
- Step 2: Release the cables from the cable guide.
- Step 3: Remove the antenna assembly in the direction shown by arrow 2.

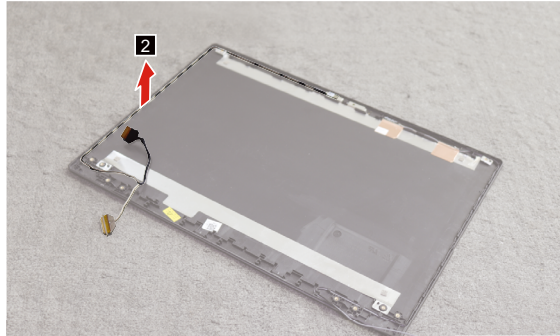

Figure 38. Remove the antenna assembly

## 1140 Wifi antenna

For access, remove the FRU in following order:

- "1010 Base cover" on page 41
- "1020 Battery pack" on page 43
- "1110 Upper case" on page 59
- "1120 LCD unit" on page 62

Step 1: Remove the wifi antenna in the direction shown by arrow 1.



Figure 39. Remove the wifi antenna

**When installing:** Stick the integrated camera to the top center of the LCD cover and adjust its placement to make sure the connector is attached firmly.



---

## Notices

---

Lenovo may not offer the products, services, or features discussed in this document in all countries. Consult your local Lenovo representative for information on the products and services currently available in your area. Any reference to a Lenovo product, program, or service is not intended to state or imply that only that Lenovo product, program, or service may be used. Any functionally equivalent product, program, or service that does not infringe any Lenovo intellectual property right may be used instead. However, it is the user's responsibility to evaluate and verify the operation of any other product, program, or service.

Lenovo may have patents or pending patent applications covering subject matter described in this document. The furnishing of this document does not give you any license to these patents.

LENOVO GROUP LTD. PROVIDES THIS PUBLICATION "AS IS" WITHOUT WARRANTY OF ANY KIND, EITHER EXPRESS OR IMPLIED, INCLUDING, BUT NOT LIMITED TO, THE IMPLIED WARRANTIES OF NON-INFRINGEMENT, MERCHANTABILITY OR FITNESS FOR A PARTICULAR PURPOSE. Some jurisdictions do not allow disclaimer of express or implied warranties in certain transactions, therefore, this statement may not apply to you.

This information could include technical inaccuracies or typographical errors. Changes are periodically made to the information herein; these changes will be incorporated in new editions of the publication. Lenovo may make improvements and/or changes in the product(s) and/or the program(s) described in this publication at any time without notice.

The products described in this document are not intended for use in implantation or other life support applications where malfunction may result in injury or death to persons. The information contained in this document does not affect or change Lenovo product specifications or warranties. Nothing in this document shall operate as an express or implied license or indemnity under the intellectual property rights of Lenovo or third parties. All information contained in this document was obtained in specific environments and is presented as an illustration. The result obtained in other operating environments may vary.

Lenovo may use or distribute any of the information you supply in any way it believes appropriate without incurring any obligation to you.

Any references in this publication to non-Lenovo Web sites are provided for convenience only and do not in any manner serve as an endorsement of those Web sites. The materials at those Web sites are not part of the materials for this Lenovo product, and use of those Web sites is at your own risk.



Any performance data contained herein was determined in a controlled environment. Therefore, the result obtained in other operating environments may vary significantly. Some measurements may have been made on development-level systems and there is no guarantee that these measurements will be the same on generally available systems. Furthermore, some measurements may have been estimated through extrapolation. Actual results may vary. Users of this document should verify the applicable data for their specific environment.

---

## **Trademarks**

The following terms are trademarks or registered trademarks of Lenovo in the United States, other countries, or both.

Lenovo

Microsoft and Windows are trademarks of Microsoft Corporation in the United States, other countries, or both.

Other company, products, or service names may be trademarks or service marks of others.