

Precision 7750

Service Manual



Notes, cautions, and warnings

 **NOTE:** A NOTE indicates important information that helps you make better use of your product.

 **CAUTION:** A CAUTION indicates either potential damage to hardware or loss of data and tells you how to avoid the problem.

 **WARNING:** A WARNING indicates a potential for property damage, personal injury, or death.

1 Working on your computer	6
Safety instructions	6
Before working inside your computer	6
Safety precautions	7
Electrostatic discharge—ESD protection	7
ESD field service kit	8
After working inside your computer	8
2 Technology and components	10
USB features	10
USB Type-C	11
HDMI 2.0	13
NVIDIA Quadro T1000	13
NVIDIA Quadro RTX3000	14
NVIDIA Quadro RTX4000	14
NVIDIA Quadro RTX5000	15
3 Disassembly and reassembly	16
SD card	16
Removing SD card	16
Installing SD card	16
SSD door	16
Removing SSD door	16
Installing SSD door	17
Secondary M.2 solid-state drive	18
Removing the secondary M.2 Solid-state drive	18
Installing the secondary M.2 SSD module	19
Base cover	20
Removing the base cover	20
Installing the base cover	23
Battery	25
Lithium-ion battery precautions	25
Removing the battery	25
Installing the battery	26
Solid State Drive	27
Removing the primary M.2 Solid-state drive	27
Installing the primary M.2 SSD module	29
Secondary memory module	30
Removing the secondary memory module	30
Installing the secondary memory module	31
SIM card	31
Removing the SIM card	31
Installing the SIM card	32
WLAN card	33

Removing the WLAN card.....	33
Installing the WLAN card.....	34
WWAN card.....	35
Removing the WWAN card.....	35
Installing the WWAN card.....	35
Keyboard lattice.....	36
Removing the keyboard lattice.....	36
Installing the keyboard lattice.....	37
Keyboard.....	37
Removing the keyboard.....	37
Installing the keyboard.....	38
Primary memory module.....	40
Removing the primary memory module.....	40
Installing the primary memory module.....	41
Heat sink	42
Removing the heat-sink assembly.....	42
Installing the heat sink assembly.....	43
Power-adapter port.....	44
Removing the power-adapter port.....	44
Installing the power-adapter port.....	44
Power button board.....	45
Removing the power button board.....	45
Installing the power button board.....	46
Power button board with fingerprint reader.....	46
Removing the power button assembly with fingerprint reader.....	46
Installing the power button assembly with fingerprint reader.....	47
Inner frame.....	48
Removing the inner frame.....	48
Installing the inner frame.....	49
Smart card cage.....	50
Removing the smart-card reader.....	50
Installing the smart-card reader.....	51
Touchpad button.....	52
Removing the Touchpad buttons.....	52
Installing the Touchpad buttons.....	53
SD card reader.....	54
Removing SD card reader.....	54
Installing SD card reader.....	55
Power button.....	56
Removing the power button.....	56
Installing the power button.....	57
Power button assembly with fingerprint reader.....	58
Removing the power button assembly with fingerprint reader.....	58
Installing the power button assembly with fingerprint reader.....	59
GPU power cable.....	59
Removing the GPU power cable.....	59
Installing the GPU power cable.....	60
System board.....	61
Removing the system board.....	61
Installing the system board.....	64

GPU card.....	67
Removing the GPU card.....	67
Installing the GPU card.....	68
Speaker.....	68
Removing the speaker.....	68
Installing the speaker.....	69
Middle cap.....	71
Removing the middle cap.....	71
Installing the middle cap.....	72
Display assembly.....	73
Removing the display assembly.....	73
Installing the display assembly.....	75
Palm rest.....	78
Removing the palmrest.....	78
Installing the palmrest.....	79
Display bezel.....	80
Removing the display bezel (non-touch).....	80
Installing the display bezel (non-touch).....	81
Display panel.....	83
Removing the display panel (non-touch).....	83
Installing the display panel (non-touch).....	85
Display hinges.....	86
Removing the display hinge.....	86
Installing the display hinge (non-touch).....	87
Camera.....	89
Removing the camera (non-touch).....	89
Installing the camera.....	90
P-sensor board.....	91
Removing the P-sensor board.....	91
Installing the P-sensor board.....	92
Display cable.....	92
Removing the display cable.....	92
Installing the display cable.....	94
Display back cover.....	95
Replacing the display cable.....	95
4 Troubleshooting.....	97
Dell SupportAssist Pre-boot System Performance Check diagnostics.....	97
Running the SupportAssist Pre-Boot System Performance Check.....	97
System board built-in self-test (M-BIST).....	98
Display panel power rail built-in self-test (L-BIST).....	98
Display panel built-in self-test (LCD-BIST).....	99
System diagnostic lights.....	99
WiFi power cycle.....	100
5 Getting help.....	102
Contacting Dell.....	102

Working on your computer

Safety instructions

Prerequisites

Use the following safety guidelines to protect your computer from potential damage and to ensure your personal safety. Unless otherwise noted, each procedure included in this document assumes that the following conditions exist:

- You have read the safety information that shipped with your computer.
- A component can be replaced or, if purchased separately, installed by performing the removal procedure in reverse order.

About this task

 **NOTE:** Disconnect all power sources before opening the computer cover or panels. After you finish working inside the computer, replace all covers, panels, and screws before connecting to the power source.

 **WARNING:** Before working inside your computer, read the safety information that shipped with your computer. For additional safety best practices information, see the [Regulatory Compliance Homepage](#)

 **CAUTION:** Many repairs may only be done by a certified service technician. You should only perform troubleshooting and simple repairs as authorized in your product documentation, or as directed by the online or telephone service and support team. Damage due to servicing that is not authorized by Dell is not covered by your warranty. Read and follow the safety instructions that came with the product.

 **CAUTION:** To avoid electrostatic discharge, ground yourself by using a wrist grounding strap or by periodically touching an unpainted metal surface at the same time as touching a connector on the back of the computer.

 **CAUTION:** Handle components and cards with care. Do not touch the components or contacts on a card. Hold a card by its edges or by its metal mounting bracket. Hold a component such as a processor by its edges, not by its pins.

 **CAUTION:** When you disconnect a cable, pull on its connector or on its pull-tab, not on the cable itself. Some cables have connectors with locking tabs; if you are disconnecting this type of cable, press in on the locking tabs before you disconnect the cable. As you pull connectors apart, keep them evenly aligned to avoid bending any connector pins. Also, before you connect a cable, ensure that both connectors are correctly oriented and aligned.

 **NOTE:** The color of your computer and certain components may appear differently than shown in this document.

Before working inside your computer

About this task

To avoid damaging your computer, perform the following steps before you begin working inside the computer.

Steps

1. Ensure that you follow the [Safety Instruction](#).
2. Ensure that your work surface is flat and clean to prevent the computer cover from being scratched.
3. Turn off your computer.
4. Disconnect all network cables from the computer.

 **CAUTION:** To disconnect a network cable, first unplug the cable from your computer and then unplug the cable from the network device.

5. Disconnect your computer and all attached devices from their electrical outlets.

6. Press and hold the power button while the computer is unplugged to ground the system board.

NOTE: To avoid electrostatic discharge, ground yourself by using a wrist grounding strap or by periodically touching an unpainted metal surface at the same time as touching a connector on the back of the computer.

Safety precautions

The safety precautions chapter details the primary steps to be taken before performing any disassembly instructions.

Observe the following safety precautions before you perform any installation or break/fix procedures involving disassembly or reassembly:

- Turn off the system and all attached peripherals.
- Disconnect the system and all attached peripherals from AC power.
- Disconnect all network cables, telephone, and telecommunications lines from the system.
- Use an ESD field service kit when working inside any tablet/notebook to avoid electrostatic discharge (ESD) damage.
- After removing any system component, carefully place the removed component on an anti-static mat.
- Wear shoes with non-conductive rubber soles to reduce the chance of getting electrocuted.

Standby power

Dell products with standby power must be unplugged before you open the case. Systems that incorporate standby power are essentially powered while turned off. The internal power enables the system to be remotely turned on (wake on LAN) and suspended into a sleep mode and has other advanced power management features.

Unplugging, pressing and holding the power button for 15 seconds should discharge residual power in the system board. Remove the battery from tablets/notebooks.

Bonding

Bonding is a method for connecting two or more grounding conductors to the same electrical potential. This is done through the use of a field service electrostatic discharge (ESD) kit. When connecting a bonding wire, ensure that it is connected to bare metal and never to a painted or non-metal surface. The wrist strap should be secure and in full contact with your skin, and ensure that you remove all jewelry such as watches, bracelets, or rings prior to bonding yourself and the equipment.

Electrostatic discharge—ESD protection

ESD is a major concern when you handle electronic components, especially sensitive components such as expansion cards, processors, memory DIMMs, and system boards. Very slight charges can damage circuits in ways that may not be obvious, such as intermittent problems or a shortened product life span. As the industry pushes for lower power requirements and increased density, ESD protection is an increasing concern.

Due to the increased density of semiconductors used in recent Dell products, the sensitivity to static damage is now higher than in previous Dell products. For this reason, some previously approved methods of handling parts are no longer applicable.

Two recognized types of ESD damage are catastrophic and intermittent failures.

- **Catastrophic** – Catastrophic failures represent approximately 20 percent of ESD-related failures. The damage causes an immediate and complete loss of device functionality. An example of catastrophic failure is a memory DIMM that has received a static shock and immediately generates a "No POST/No Video" symptom with a beep code emitted for missing or nonfunctional memory.
- **Intermittent** – Intermittent failures represent approximately 80 percent of ESD-related failures. The high rate of intermittent failures means that most of the time when damage occurs, it is not immediately recognizable. The DIMM receives a static shock, but the tracing is merely weakened and does not immediately produce outward symptoms related to the damage. The weakened trace may take weeks or months to melt, and in the meantime may cause degradation of memory integrity, intermittent memory errors, etc.

The more difficult type of damage to recognize and troubleshoot is the intermittent (also called latent or "walking wounded") failure.

Perform the following steps to prevent ESD damage:

- Use a wired ESD wrist strap that is properly grounded. The use of wireless anti-static straps is no longer allowed; they do not provide adequate protection. Touching the chassis before handling parts does not ensure adequate ESD protection on parts with increased sensitivity to ESD damage.
- Handle all static-sensitive components in a static-safe area. If possible, use anti-static floor pads and workbench pads.
- When unpacking a static-sensitive component from its shipping carton, do not remove the component from the anti-static packing material until you are ready to install the component. Before unwrapping the anti-static packaging, ensure that you discharge static electricity from your body.

- Before transporting a static-sensitive component, place it in an anti-static container or packaging.

ESD field service kit

The unmonitored Field Service kit is the most commonly used service kit. Each Field Service kit includes three main components: anti-static mat, wrist strap, and bonding wire.

Components of an ESD field service kit

The components of an ESD field service kit are:

- **Anti-Static Mat** – The anti-static mat is dissipative and parts can be placed on it during service procedures. When using an anti-static mat, your wrist strap should be snug and the bonding wire should be connected to the mat and to any bare metal on the system being worked on. Once deployed properly, service parts can be removed from the ESD bag and placed directly on the mat. ESD-sensitive items are safe in your hand, on the ESD mat, in the system, or inside a bag.
- **Wrist Strap and Bonding Wire** – The wrist strap and bonding wire can be either directly connected between your wrist and bare metal on the hardware if the ESD mat is not required, or connected to the anti-static mat to protect hardware that is temporarily placed on the mat. The physical connection of the wrist strap and bonding wire between your skin, the ESD mat, and the hardware is known as bonding. Use only Field Service kits with a wrist strap, mat, and bonding wire. Never use wireless wrist straps. Always be aware that the internal wires of a wrist strap are prone to damage from normal wear and tear, and must be checked regularly with a wrist strap tester in order to avoid accidental ESD hardware damage. It is recommended to test the wrist strap and bonding wire at least once per week.
- **ESD Wrist Strap Tester** – The wires inside of an ESD strap are prone to damage over time. When using an unmonitored kit, it is a best practice to regularly test the strap prior to each service call, and at a minimum, test once per week. A wrist strap tester is the best method for doing this test. If you do not have your own wrist strap tester, check with your regional office to find out if they have one. To perform the test, plug the wrist-strap's bonding-wire into the tester while it is strapped to your wrist and push the button to test. A green LED is lit if the test is successful; a red LED is lit and an alarm sounds if the test fails.
- **Insulator Elements** – It is critical to keep ESD sensitive devices, such as plastic heat sink casings, away from internal parts that are insulators and often highly charged.
- **Working Environment** – Before deploying the ESD Field Service kit, assess the situation at the customer location. For example, deploying the kit for a server environment is different than for a desktop or portable environment. Servers are typically installed in a rack within a data center; desktops or portables are typically placed on office desks or cubicles. Always look for a large open flat work area that is free of clutter and large enough to deploy the ESD kit with additional space to accommodate the type of system that is being repaired. The workspace should also be free of insulators that can cause an ESD event. On the work area, insulators such as Styrofoam and other plastics should always be moved at least 12 inches or 30 centimeters away from sensitive parts before physically handling any hardware components
- **ESD Packaging** – All ESD-sensitive devices must be shipped and received in static-safe packaging. Metal, static-shielded bags are preferred. However, you should always return the damaged part using the same ESD bag and packaging that the new part arrived in. The ESD bag should be folded over and taped shut and all the same foam packing material should be used in the original box that the new part arrived in. ESD-sensitive devices should be removed from packaging only at an ESD-protected work surface, and parts should never be placed on top of the ESD bag because only the inside of the bag is shielded. Always place parts in your hand, on the ESD mat, in the system, or inside an anti-static bag.
- **Transporting Sensitive Components** – When transporting ESD sensitive components such as replacement parts or parts to be returned to Dell, it is critical to place these parts in anti-static bags for safe transport.

ESD protection summary

It is recommended that all field service technicians use the traditional wired ESD grounding wrist strap and protective anti-static mat at all times when servicing Dell products. In addition, it is critical that technicians keep sensitive parts separate from all insulator parts while performing service and that they use anti-static bags for transporting sensitive components.

After working inside your computer

About this task

After you complete any replacement procedure, ensure that you connect any external devices, cards, and cables before turning on your computer.

Steps

1. Connect any telephone or network cables to your computer.

 **CAUTION:** To connect a network cable, first plug the cable into the network device and then plug it into the computer.

2. Connect your computer and all attached devices to their electrical outlets.
3. Turn on your computer.
4. If required, verify that the computer works correctly by running **SupportAssist diagnostics**.

Technology and components

This chapter details the technology and components available in the system.

Topics:

- USB features
- USB Type-C
- HDMI 2.0
- NVIDIA Quadro T1000
- NVIDIA Quadro RTX3000
- NVIDIA Quadro RTX4000
- NVIDIA Quadro RTX5000

USB features

Universal Serial Bus, or USB, was introduced in 1996. It dramatically simplified the connection between host computers and peripheral devices like mice, keyboards, external drives, and printers.

Table 1. USB evolution

Type	Data Transfer Rate	Category	Introduction Year
USB 2.0	480 Mbps	High Speed	2000
USB 3.2 Gen 1 (previously USB 3.0/USB 3.1 Gen 1)	5 Gbps	SuperSpeed	2010
USB 3.1 Gen 2	10 Gbps	SuperSpeed Plus	2013

USB 3.2 Gen 1 (SuperSpeed USB)

For years, the USB 2.0 has been firmly entrenched as the de facto interface standard in the personal computer world with about 6 billion devices sold, and yet the need for more speed grows by ever faster computing hardware and ever greater bandwidth demands. The USB 3.0/USB 3.1 Gen 1 finally has the answer to the consumers' demands with a theoretically 10 times faster than its predecessor. In a nutshell, USB 3.2 Gen 1 features are as follows:

- Higher transfer rates (up to 20 Gbps).
- Increased multilane operation of 10 Gbps each.
- Increased maximum bus power and increased device current draw to better accommodate power-hungry devices.
- New power management features.
- Full-duplex data transfers and support for new transfer types.
- Backward compatibility with USB 3.1/3.0 and USB 2.0.
- New connectors and cable.

The topics below cover some of the most commonly asked questions regarding USB 3.0/USB 3.2 Gen 1.



Speed

Currently, there are five speed modes that are defined by the latest USB 3.0/USB 3.1 Gen 1 specification. Based on USB data transfer, they are categorized as Low Speed, Full Speed, High Speed (from version 2.0 of the specification), SuperSpeed (from version 3.0), and

SuperSpeed+ (from version 3.1). The new SuperSpeed+ mode has a transfer rate of 20 Gbps. The USB 3.2 standard is backward compatible with USB 3.1/3.0 and USB 2.0.

USB 3.2 Gen 1 achieves the much higher performance by the technical changes below:

- An additional physical bus that is added in parallel with the existing USB 2.0 bus (see the figure below).
- USB 2.0 previously had four wires (power, ground, and a pair for differential data); USB 3.1 Gen 1 adds four more for two pairs of differential signals (receive and transmit) for a combined total of eight connections in the connectors and cabling.
- USB 3.2 Gen 1 uses the bi-directional data interface, rather than USB 2.0's half-duplex arrangement. This gives a 10-fold increase in theoretical bandwidth.

Applications

USB 3.1 Gen 1 opens up the laneways and provides more headroom for devices to deliver a better overall experience. Where USB video was barely tolerable previously (both from a maximum resolution, latency, and video compression perspective), it is easy to imagine that with 5 to 10 times the bandwidth available, USB video solutions should work that much better. Single-link DVI requires almost 2 Gbps throughput. Where 480 Mbps was limiting, 5 Gbps is more than promising. With its promised 4.8 Gbps speed, the standard finds its way into some products that previously were not USB territory, like external RAID storage systems.

Listed below are some of the available SuperSpeed USB 3.0/USB 3.1 Gen 1 products:

- External Desktop USB 3.0/USB 3.2 Gen 1 Hard Drives
- Portable USB 3.2 Gen 1 Hard Drives
- USB 3.2 Gen 1 Drive Docks and Adapters
- USB 3.2 Gen 1 Flash Drives and Readers
- USB 3.2 Gen 1 Solid-state Drives
- USB 3.2 Gen 1 RAIDs
- Optical Media Drives
- Multimedia Devices
- Networking
- USB 3.2 Gen 1 Adapter Cards and Hubs

Compatibility

The good news is that USB 3.2 Gen 1 has been carefully planned from the start to peacefully co-exist with USB 2.0. First of all, while USB 3.2 Gen 1 specifies new physical connections and thus new cables to take advantage of the higher speed capability of the new protocol, the connector itself remains the same rectangular shape with the four USB 2.0 contacts in the exact same location as before. Five new connections to receive and transmit data independently are present on USB 3.0/USB 3.2 Gen 1 cables and only come into contact when connected to a proper SuperSpeed USB connection.

USB Type-C

USB Type-C is a new, tiny physical connector. The connector itself can support various exciting new USB standards like USB 3.1 and USB power delivery (USB PD).

Alternate Mode

USB Type-C is a new connector standard that is small. It is about a third the size of an old USB Type-A plug. This is a single connector standard that every device could use. USB Type-C ports can support various different protocols using "alternate modes," which allows you to have adapters that can output HDMI, VGA, DisplayPort, or other types of connections from that single USB port.

USB Power Delivery

The USB PD specification is also closely intertwined with USB Type-C. Currently, smartphones, tablets, and other mobile devices often use a USB connection to charge. A USB 2.0 connection provides up to 2.5 watts of power — that'll charge your phone, but that's about it. A laptop might require up to 60 watts, for example. The USB Power Delivery specification ups this power delivery to 100 watts. It's bi-directional, so a device can either send or receive power. And this power can be transferred at the same time the device is transmitting data across the connection.

This could spell the end of all those proprietary laptop charging cables, with everything charging over a standard USB connection. You could charge your laptop from one of those portable battery packs you charge your smartphones and other portable devices from today. You could plug your laptop into an external display connected to a power cable, and that external display would charge your laptop as you used it as an external display — all using the one little USB Type-C connection. To use this, the device and the cable have to support USB Power Delivery. Just having a USB Type-C connection does not necessarily mean they do.

USB Type-C and USB 3.2

USB 3.2 is a new USB standard. USB 3's theoretical bandwidth is 5 Gbps, while USB 3.2's is 20 Gbps, that is, double the bandwidth as fast as a first-generation Thunderbolt connector. USB Type-C is not the same thing as USB 3.2. USB Type-C is just a connector shape, and the underlying technology could just be USB 2 or USB 3.0. In fact, Nokia's N1 Android tablet uses a USB Type-C connector, but underneath it is all USB 2.0—not even USB 3.0. However, these technologies are closely related.

Thunderbolt over USB Type-C

Thunderbolt is a hardware interface that combines data, video, audio, and power in a single connection. Thunderbolt combines PCI Express (PCIe) and DisplayPort (DP) into one serial signal, and additionally provides DC power, all in one cable. Thunderbolt 1 and Thunderbolt 2 use the same connector as mini-DP (DisplayPort) to connect to peripherals, while Thunderbolt 3 uses a USB Type-C connector.

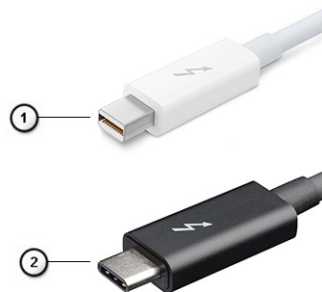

Figure 1. Thunderbolt 1 and Thunderbolt 3

1. Thunderbolt 1 and Thunderbolt 2 (using a miniDP connector)
2. Thunderbolt 3 (using a USB Type-C connector)

Thunderbolt 3 over USB Type-C

Thunderbolt 3 brings Thunderbolt to USB Type-C at speeds up to 40 Gbps, creating one compact port that does it all - delivering the fastest, most versatile connection to any dock, display, or data device like an external hard drive. Thunderbolt 3 uses a USB Type-C connector/port to connect to supported peripherals.

1. Thunderbolt 3 uses USB Type-C connector and cables - It is compact and reversible.
2. Thunderbolt 3 supports speed up to 40 Gbps.
3. DisplayPort 1.4 – compatible with existing DisplayPort monitors, devices, and cables.
4. USB Power Delivery - Up to 130 W on supported computers.

Key Features of Thunderbolt 3 over USB Type-C

1. Thunderbolt, USB, DisplayPort, and power-on USB Type-C on a single cable (features vary between different products).
2. USB Type-C connector and cables which are compact and reversible.
3. Supports Thunderbolt Networking (*varies between different products).
4. Supports up to 4 K displays.
5. Up to 40 Gbps

NOTE: Data transfer speed may vary between different devices.

Thunderbolt Icons



Protocol	USB Type-A	USB Type-C	Notes
Thunderbolt	Not Applicable		Will use industry standard icon regardless of port style (i.e., mDP or USB Type-C)
Thunderbolt w/ Power Delivery	Not Applicable		Up to 130 Watts via USB Type-C

Figure 2. Thunderbolt Iconography Variations

HDMI 2.0

This topic explains the High-Definition Multimedia Interface (HDMI) 2.0 and its features along with the advantages.

HDMI is an industry-supported, uncompressed, all-digital audio/video interface. HDMI provides an interface between any compatible digital audio/video source, such as a DVD player, or A/V receiver and a compatible digital audio and/or video monitor, such as a digital TV (DTV). The intended applications for HDMI TVs, and DVD players. The primary advantage is cable reduction and content protection provisions. HDMI supports standard, enhanced, or high-definition video, plus multichannel digital audio on a single cable.

HDMI 2.0 features

- **HDMI Ethernet Channel** - Adds high-speed networking to an HDMI link, enabling users to take full advantage of their IP-enabled devices without a separate Ethernet cable
- **Audio Return Channel** - Allows an HDMI-connected TV with a integrated tuner to send audio data "upstream" to a surround audio system, eliminating the need for a separate audio cable
- **3D** - Defines input/output protocols for major 3D video formats, paving the way for true 3D gaming and 3D home theater applications
- **Content Type** - Real-time signaling of content types between display and source devices, enabling a TV to optimize illustration settings based on content type
- **Additional Color Spaces** - Adds support for additional color models that are used in digital photography and computer graphics
- **4K Support** - Enables video resolutions far beyond 1080p, supporting next-generation displays that rival the Digital Cinema systems that are used in many commercial movie theaters
- **HDMI Micro Connector** - A new, smaller connector for phones and other portable devices, supporting video resolutions up to 1080p
- **Automotive Connection System** - New cables and connectors for automotive video systems, which are designed to meet the unique demands of the motoring environment while delivering true HD quality

Advantages of HDMI

- Quality HDMI transfers uncompressed digital audio and video for the highest, crispest image quality.
- Low -cost HDMI provides the quality and functionality of a digital interface while also supporting uncompressed video formats in a simple, cost-effective manner
- Audio HDMI supports multiple audio formats from standard stereo to multichannel surround sound
- HDMI combines video and multichannel audio into a single cable, eliminating the cost, complexity, and confusion of multiple cables that are currently used in A/V systems
- HDMI supports communication between the video source (such as a DVD player) and the DTV, enabling new functionality

NVIDIA Quadro T1000

Table 2. NVIDIA Quadro T1000

Feature	Values
Graphics memory	4 GB
Cores	768
Memory bandwidth	128 Gbps
Memory type	GDDR6

Table 2. NVIDIA Quadro T1000(continued)

Feature	Values
Memory Interface	128-bit
Clock Speeds	1395 - 1455 (Boost) MHz
GPU base clock	8000 MHz (min. at P0)
Estimated Maximum Power	50 W
Display Support	eDP/mDP/HDMI/Type-C
Maximum Color Depth	Up to 10 bit/color
Operating Systems Graphics/ Video API Support	DirectX 12.0, OpenGL 4.6, DisplayPort 1.4, DirectX 12.1
Supported Resolutions and Max Refresh Rates (Hz)	<ul style="list-style-type: none"> · Max Digital : Single DisplayPort 1.4 - 7680 x 4320 (8k) @ 30 Hz (mDP/type-c to DP) · Max Digital : Dual DisplayPort 1.4 - 7680 x 4320 (8k) @ 60 Hz (mDP/type-c to DP)
Numbers of Display Support	Up to 4 displays

NVIDIA Quadro RTX3000

Table 3. NVIDIA Quadro RTX3000

Feature	Values
Graphics memory	6 GB
Cores	2304
Memory bandwidth	336 Gbps
Memory type	GDDR6
Memory Interface	192-bit
Clock Speeds	945 - 1380 (Boost) MHz
GPU base clock	3504 MHz (min. at P0)
Estimated Maximum Power	80 W
Display Support	eDP/mDP/HDMI/Type-C
Maximum Color Depth	Up to 10 bit/color
Operating Systems Graphics/ Video API Support	DirectX 12.0, OpenGL 4.6, DisplayPort 1.4, DirectX 12.1
Supported Resolutions and Max Refresh Rates (Hz)	<ul style="list-style-type: none"> · Max Digital : Single DisplayPort 1.4 - 7680 x 4320 (8k) @ 30 Hz (mDP/type-c to DP) · Max Digital : Dual DisplayPort 1.4 - 7680 x 4320 (8k) @ 60 Hz (mDP/type-c to DP)
Numbers of Display Support	Up to 4 displays

NVIDIA Quadro RTX4000

Table 4. NVIDIA Quadro RTX4000

Feature	Values
Graphics memory	8 GB

Table 4. NVIDIA Quadro RTX4000(continued)

Feature	Values
Cores	2560
Memory bandwidth	448 Gbps
Memory type	GDDR6
Memory Interface	256-bit
Clock Speeds	1110 - 1560 (Boost) MHz
GPU base clock	14000 MHz
Estimated Maximum Power	100 W
Display Support	eDP/mDP/HDMI/Type-C
Maximum Color Depth	Up to 10 bit/color
Operating Systems Graphics/ Video API Support	DirectX 12.0, OpenGL 4.6, DisplayPort 1.4, DirectX 12.1
Supported Resolutions and Max Refresh Rates (Hz)	<ul style="list-style-type: none"> · Max Digital : Single DisplayPort 1.4 - 7680 x 4320 (8k) @ 30 Hz (mDP/Type-c to DP) · Max Digital : Dual DisplayPort 1.4 - 7680 x 4320 (8k) @ 60 Hz (mDP/Type-c to DP)
Numbers of Display Support	Up to 4 displays

NVIDIA Quadro RTX5000

Table 5. NVIDIA Quadro RTX5000

Feature	Values
Graphics memory	16 GB
Cores	3072
Memory bandwidth	448 Gbps
Memory type	GDDR6
Memory Interface	256-bit
Clock Speeds	1035 / 1350 - 1545 / 1770 (Boost) MHz
GPU base clock	14000 MHz
Estimated Maximum Power	110 W
Display Support	eDP/mDP/HDMI/Type-C
Maximum Color Depth	Up to 10 bit/color
Operating Systems Graphics/ Video API Support	DirectX 12.0, OpenGL 4.6, DisplayPort 1.4, DirectX 12.1
Supported Resolutions and Max Refresh Rates (Hz)	<ul style="list-style-type: none"> · Max Digital : Single DisplayPort 1.4 - 7680 x 4320 (8k) @ 30 Hz (mDP/Type-C to DP) · Max Digital : Dual DisplayPort 1.4 - 7680 x 4320 (8k) @ 60 Hz (mDP/Type-C to DP)
Numbers of Display Support	Up to 4 displays

Disassembly and reassembly

SD card

Removing SD card

Prerequisites

1. Follow the procedure in [before working inside your computer](#).

About this task

The figure indicates the location of the SD card and provides a visual representation of the removal procedure. Images to be uploaded in the next review cycle.

Steps

1. Press the SD card to release it from the computer.
2. Slide the SD card out of the computer.

Installing SD card

Prerequisites

If you are replacing a component, remove the existing component before performing the installation procedure.

About this task

The figure indicates the location of the base cover and provides a visual representation of the installation procedure.

Images to be uploaded in the next review cycle

Steps

Slide the SD card into the slot on the computer until it clicks into place.

Next steps

1. Follow the procedure in [after working inside your computer](#).

SSD door

Removing SSD door

Prerequisites

1. Follow the procedure in [before working inside your computer](#).
2. Remove the [SD card](#).

About this task

The figure indicates the location of the SSD door reader and provides a visual representation of the removal procedure.

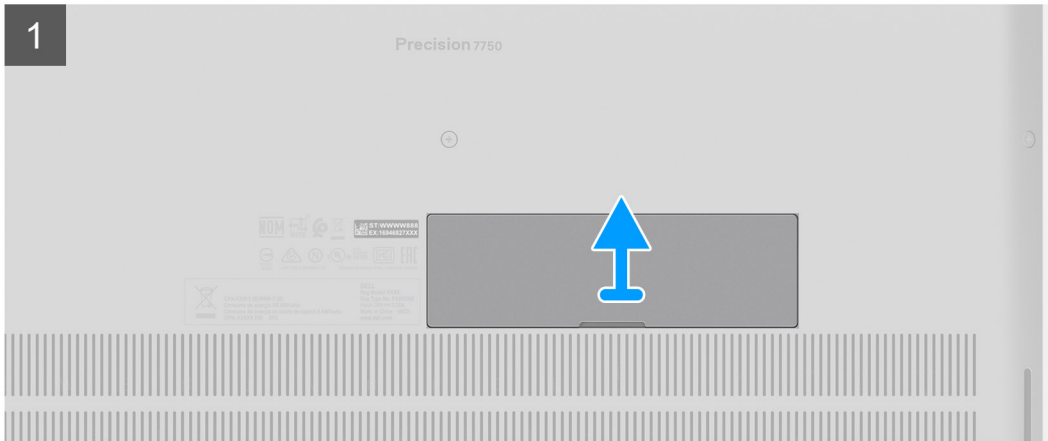
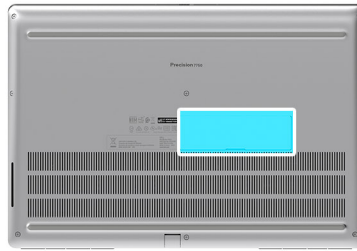

Steps

1. Push the SSD door towards left side to release the SSD door from the base cover.
2. Remove the SSD door from the base cover.

Installing SSD door

Prerequisites

If you are replacing a component, remove the existing component before performing the installation procedure.

About this task

The figure indicates the location of the SSD door and provides a visual representation of the installation procedure.

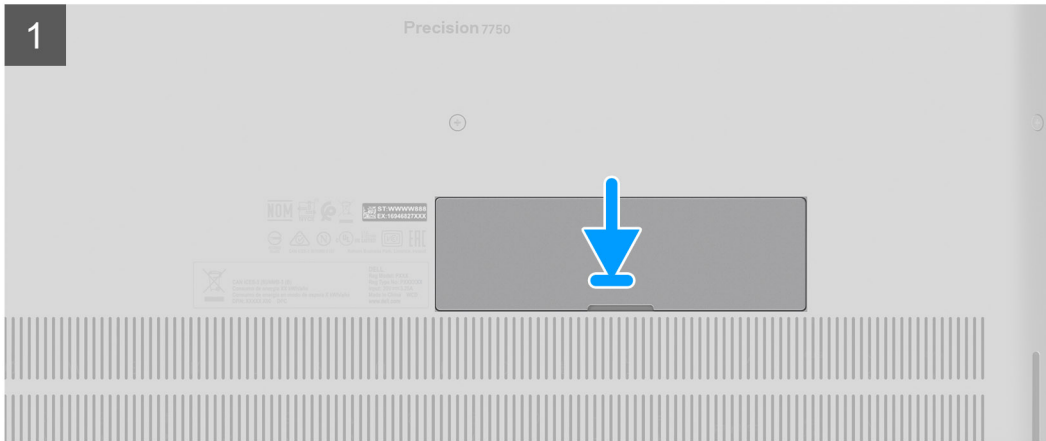
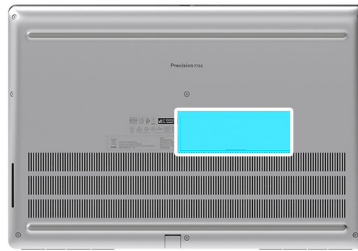

Steps

1. Place the SSD door into its slot on the base cover.
2. Push the SSD door towards right side to lock the SSD door.

Next steps

1. Install the [SD card](#).
2. Follow the procedure in [after working inside your computer](#).

Secondary M.2 solid-state drive

Removing the secondary M.2 Solid-state drive

Prerequisites

NOTE: For computers shipped with M.2 2280 or 2230 SSD installed in slot 6.

1. Follow the procedure in [before working inside your computer](#).
2. Remove the [SD card](#).
3. Remove the [SSD door](#).

About this task

The figure indicates the location of the secondary M.2 SSD and provides a visual representation of the removal procedure.



2x
M2x3

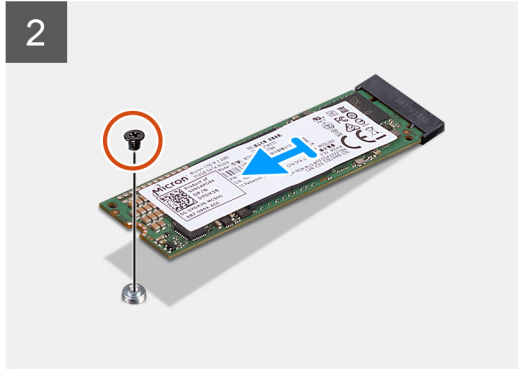
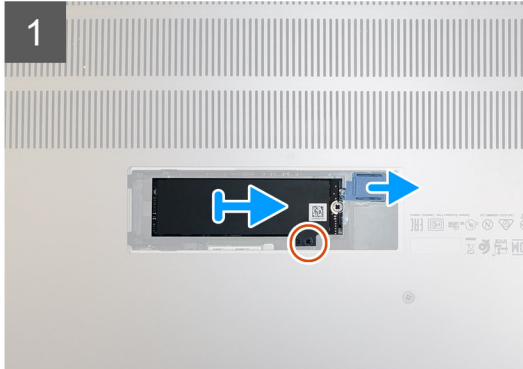
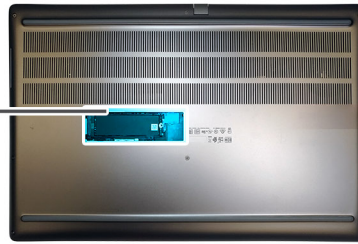

Steps

1. Slide the SSD release latch to unlock the SSD module.
2. Remove the (M2x3) screw that secures the SSD module into its slot on the computer.
3. Remove the SSD module from the computer.
4. Remove the (M2x3) screw that secures the SSD thermal pad to the SSD carrier.
5. Remove the SSD thermal pad from the SSD module.
6. For M.2 2280 SSD:
 - a. Remove the M.2 2280 SSD from the SSD carrier.
7. For M.2 2230 SSD:
 - a. Remove the M.2 2230 SSD with its holder from the SSD carrier.
 - b. Remove the (M2x2) screw to secure the M.2 2230 SSD to its holder.
 - c. Remove the SSD from the holder.

Installing the secondary M.2 SSD module

Prerequisites

NOTE: For computers shipped with M.2 2280 or 2230 SSD installed in slot 6.

If you are replacing a component, remove the existing component before performing the installation procedure.

About this task

The figure indicates the location of the secondary M.2 SSD and provides a visual representation of the installation procedure.



2x
M2x3

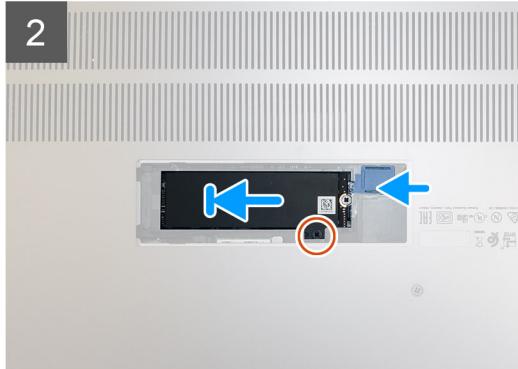
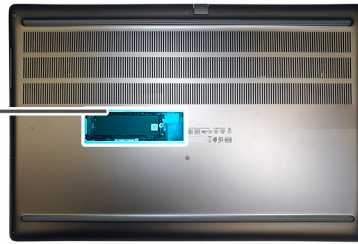

Steps

1. For M.2 2280 SSD:
 - a. Place the M.2 SSD onto its slot on SSD carrier.
2. For M.2 2230 SSD:
 - a. Place the M.2 SSD into the SSD holder.
 - b. Replace the (M2x2) screw to secure the M.2 SSD to the holder.
 - c. Place the M.2 SSD with its holder on the SSD carrier.
3. Place the thermal plate above the M.2 SSD module.
4. Replace the (M2x3) screw to secure the SSD thermal plate to the M.2 SSD.
5. Replace the SSD module in its slot on the computer.
6. Replace the (M2x3) screw to secure the SSD module in place.

Next steps

1. Install the [SSD door](#).
2. Install the [SD card](#).
3. Follow the procedure in [after working inside your computer](#).

Base cover

Removing the base cover

Prerequisites

1. Follow the procedure in [before working inside your computer](#).
2. Remove the [SD card](#).

About this task

The figure indicates the location of the base cover and provides a visual representation of the removal procedure

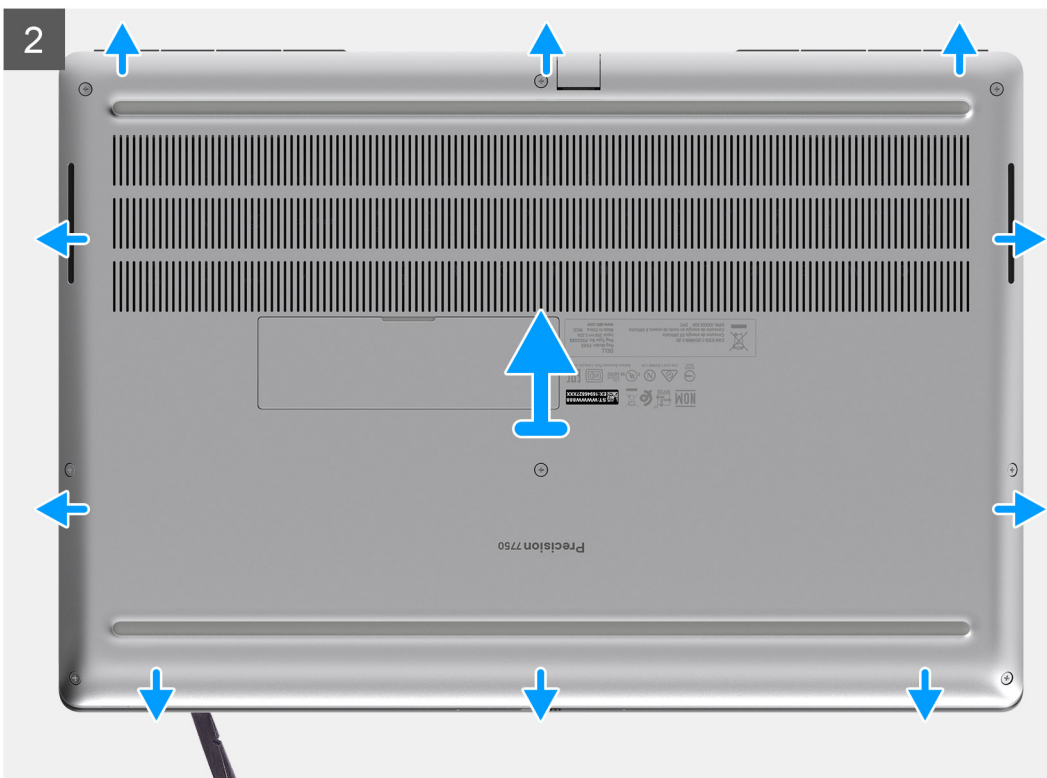
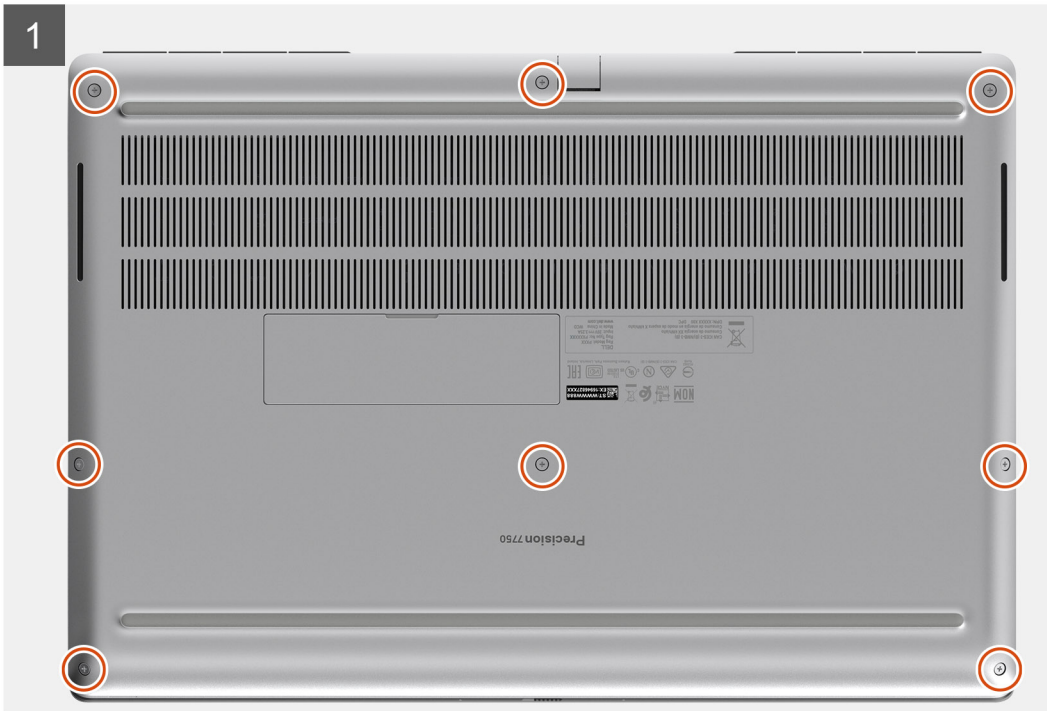

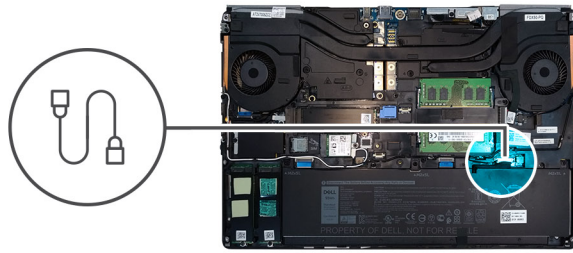

Steps

1. Loosen the eight captive screws that secure the base cover to the computer.
2. Using a plastic scribe, pry open the base cover starting from bottom edge of the cover.

i NOTE: For models shipped without SmartCard reader, pry open the base cover from the smart card reader slot. Use your fingers to pry open the base cover as the use of plastic scribe or any other sharp objects may damage the base cover.





3. Lift the base cover starting from the bottom edge and remove it from the computer.
4. Disconnect the battery cable from the connector on the system board.

Installing the base cover

Prerequisites

If you are replacing a component, remove the existing component before performing the installation procedure.

About this task

The figure indicates the location of the base cover and provides a visual representation of the installation procedure.

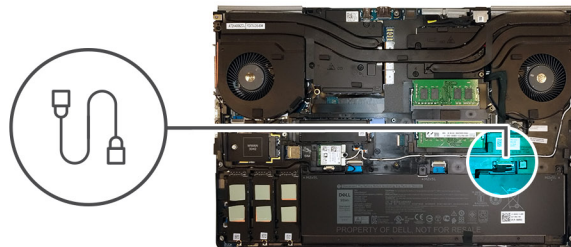

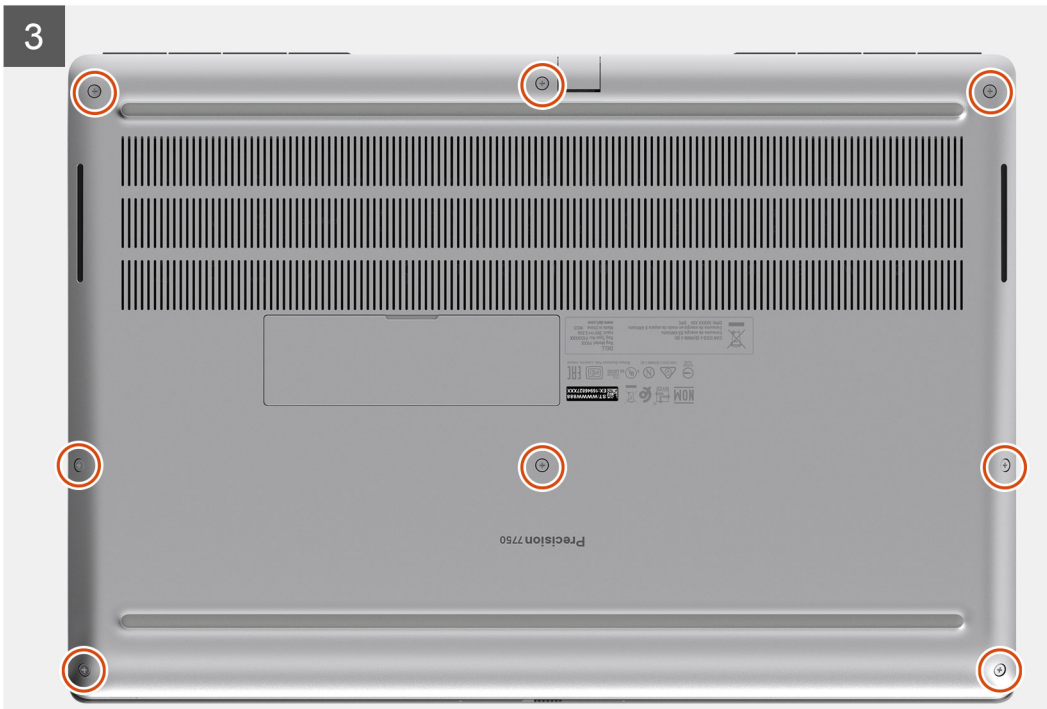
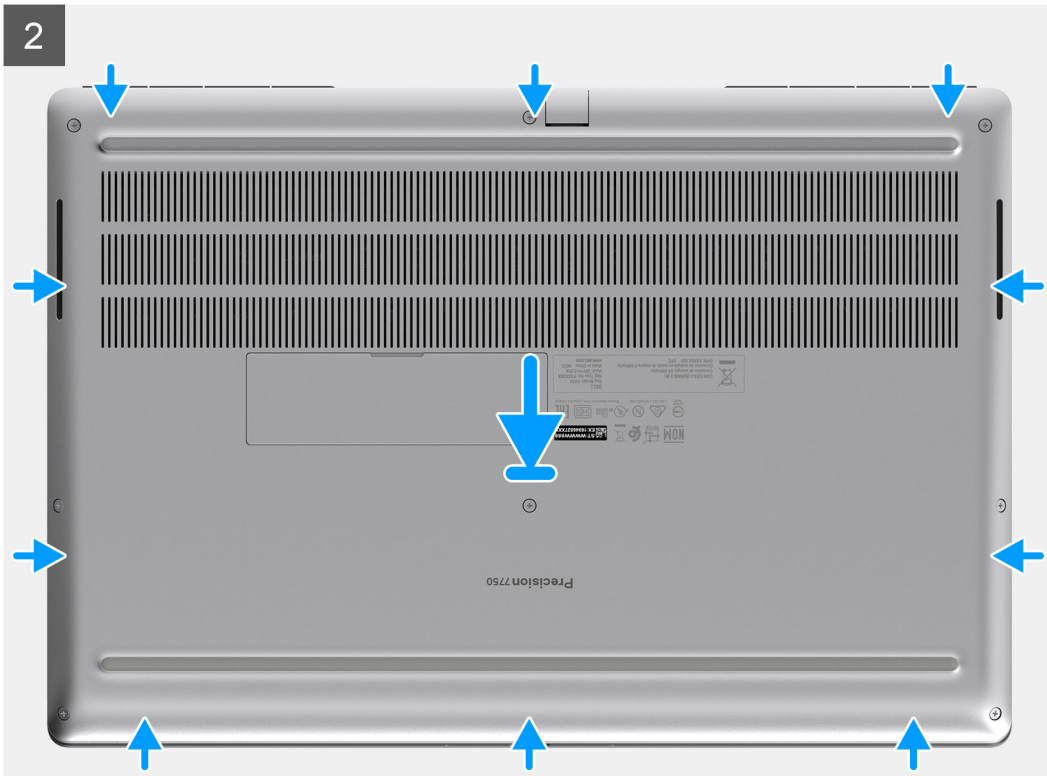

Steps

1. Connect the battery cable to the connector on the system board.
2. Slide the base cover into its slot until it clicks into place.
3. Tighten the eight captive screws to secure the base cover to the computer.

Next steps

1. Install the [SD card](#).
2. Follow the procedure in [after working inside your computer](#).

Battery

Lithium-ion battery precautions

CAUTION:

- Exercise caution when handling Lithium-ion batteries.
- Discharge the battery as much as possible before removing it from the system. This can be done by disconnecting the AC adapter from the system to allow the battery to drain.
- Do not crush, drop, mutilate, or penetrate the battery with foreign objects.
- Do not expose the battery to high temperatures, or disassemble battery packs and cells.
- Do not apply pressure to the surface of the battery.
- Do not bend the battery.
- Do not use tools of any kind to pry on or against the battery.
- Ensure any screws during the servicing of this product are not lost or misplaced, to prevent accidental puncture or damage to the battery and other system components.
- If the battery gets stuck inside your computer as a result of swelling, do not try to release it as puncturing, bending, or crushing a lithium-ion battery can be dangerous. In such an instance, contact Dell technical support for assistance. See www.dell.com/contactdell.
- Always purchase genuine batteries from www.dell.com or authorized Dell partners and resellers.

Removing the battery

Prerequisites

1. Follow the procedure in [before working inside your computer](#).
2. Remove the [SD card](#).
3. Remove the [base cover](#).

About this task

The figure indicates the location of the battery and provides a visual representation of the removal procedure.



3x
M2x5

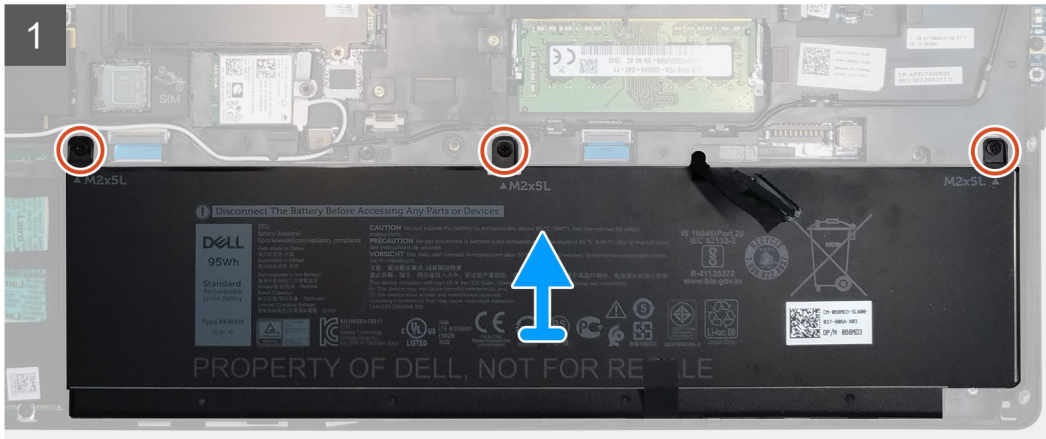
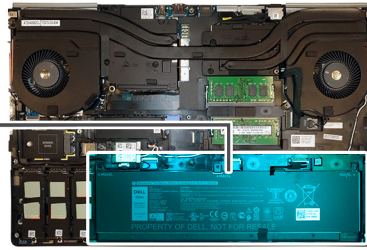
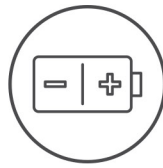

Steps

1. Remove the three (M2x5) screws that secure the battery to the computer.
2. Slightly lift the battery and disconnect the battery cable from the connector on the battery.
3. Remove the battery away from the computer.

Installing the battery

Prerequisites

If you are replacing a component, remove the existing component before performing the installation procedure.

About this task

The figure indicates the location of the battery and provides a visual representation of the installation procedure.



3x
M2x5

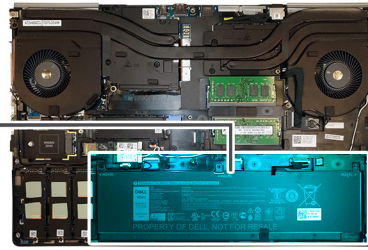
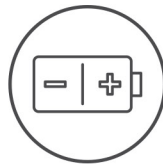

Steps

1. Connect the battery cable to the connector in the battery.
2. Place the battery onto its slot in the computer.
3. Replace the three (M2x5) screws to secure the battery to the computer.

Next steps

1. Install the [base cover](#).
2. Install the [SD card](#).
3. Follow the procedure in [after working inside your computer](#).

Solid State Drive

Removing the primary M.2 Solid-state drive

Prerequisites

 **NOTE:** For computers shipped with M.2 2280 or 2230 SSD installed in slot 3, slot 4, and/or slot 5.

1. Follow the procedure in [before working inside your computer](#).
2. Remove the [SD card](#).
3. Remove the [base cover](#).

About this task

The figure indicates the location of the primary M.2 SSD and provides a visual representation of the removal procedure.



2x
M2x3

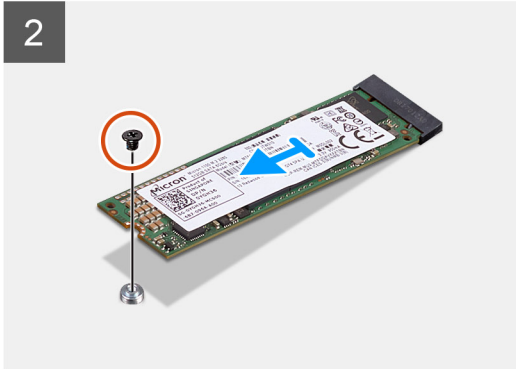
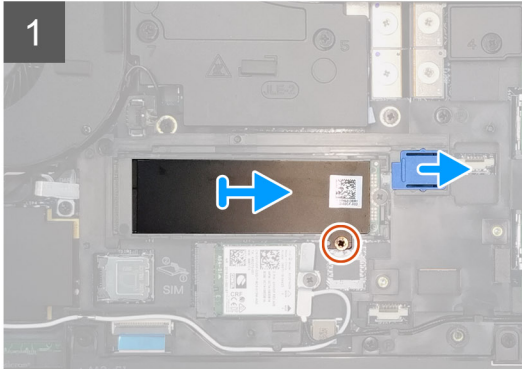
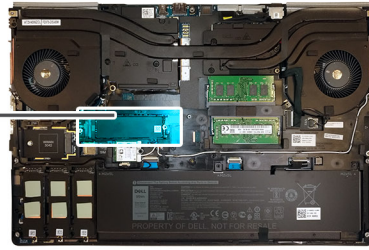

2x
M2x3

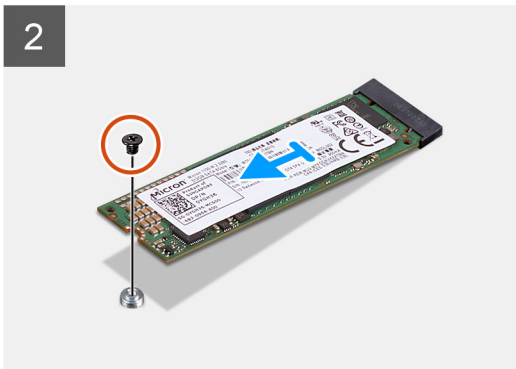
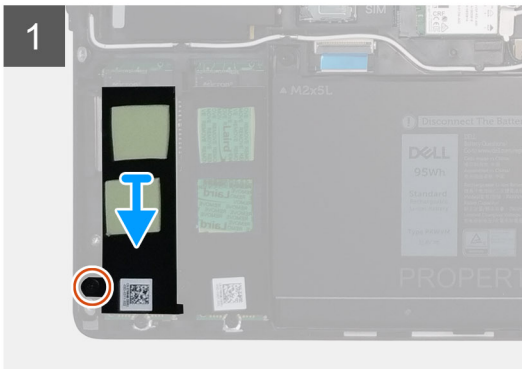
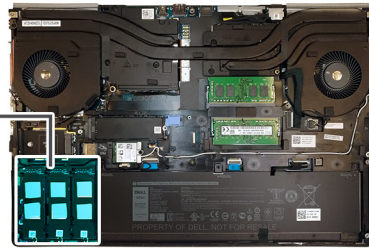

Steps

1. Remove the (M2x3) screw that secures the SSD thermal plate to the M.2 SSD module.
2. Remove the SSD thermal plate.
3. For M.2 2280 SSD:
 - a. Remove the (M2x3) screw that secures the M.2 SSD to the computer.
 - b. Remove the M.2 SSD.
4. For M.2 2230 SSD:
 - a. Remove the (M2x3) screw that secures the SSD module.
 - b. Remove the SSD module from the computer.
 - c. Remove the (M2x2) screw that secures the SSD to SSD holder.
 - d. Remove the SSD from the holder.
5. Repeat the above steps to remove the other SSD modules in the computer.

Installing the primary M.2 SSD module

Prerequisites

NOTE: For computers shipped with M.2 2280 or 2230 SSD installed in slot 3, slot 4, and/or slot 5.

If you are replacing a component, remove the existing component before performing the installation procedure.

About this task

The figure indicates the location of the primary M.2 SSD and provides a visual representation of the installation procedure.

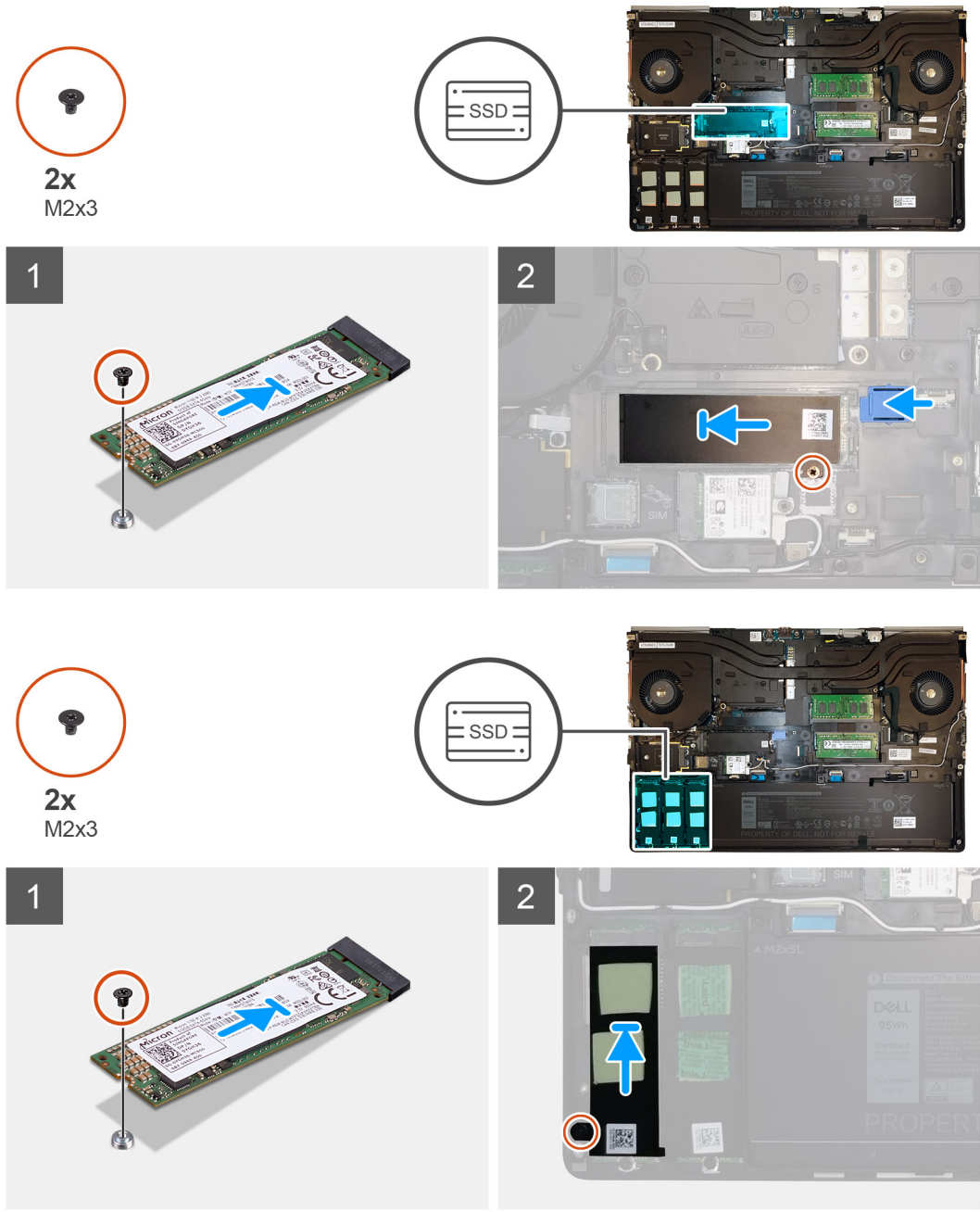

Steps

1. For M.2 2280 SSD:
 - a. Place the M.2 SSD onto its slot on the computer.
 - b. Replace the (M2x3) screw to secure the M.2 SSD to the computer.

2. For M.2 2230 SSD:
 - a. Place the M.2 SSD into the SSD holder.
 - b. Replace the (M2x2) screw to secure the M.2 SSD to the holder.
 - c. Place the M.2 SSD module onto its slot on the computer.
 - d. Replace the (M2x3) screw to secure the M.2 SSD module to the computer.
3. Place the thermal plate above the M.2 SSD module.
4. Replace the (M2x3) screw to secure the SSD thermal plate to the M.2 SSD.
5. Repeat the above steps to install the other SSD modules in the computer.

Next steps

1. Install the [base cover](#).
2. Install the [SD card](#).
3. Follow the procedure in [after working inside your computer](#).

Secondary memory module

Removing the secondary memory module

Prerequisites

1. Follow the procedure in [before working inside your computer](#).
2. Remove the [SD card](#).
3. Remove the [base cover](#).

About this task

The figure indicates the location of the secondary memory module and provides a visual representation of the removal procedure.

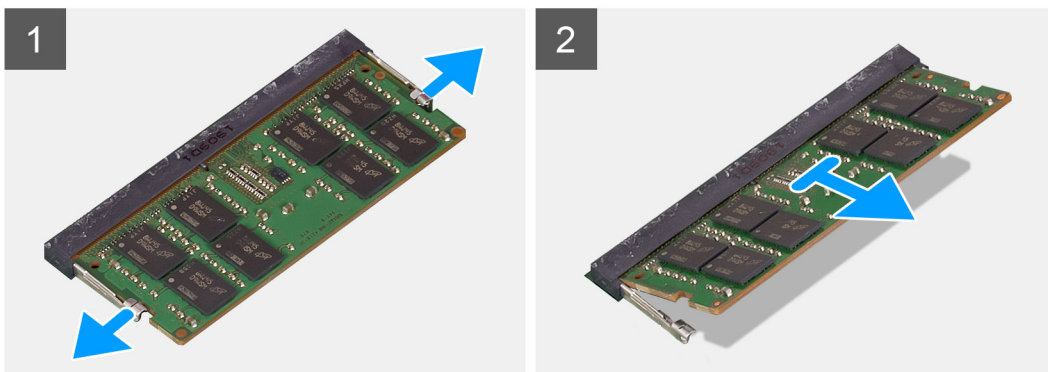
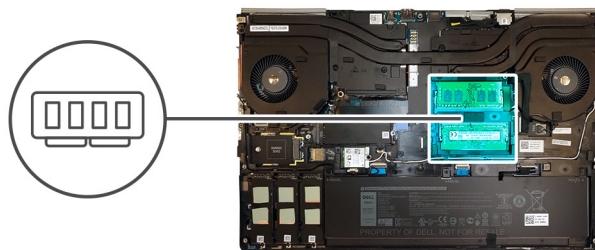

Steps

1. Pry the securing clips from both side of the memory module until the memory module pops up.
2. Remove the memory module from the memory-module slot.

Installing the secondary memory module

Prerequisites

If you are replacing a component, remove the existing component before performing the installation procedure.

About this task

The figure indicates the location of the secondary and provides a visual representation of the installation procedure.

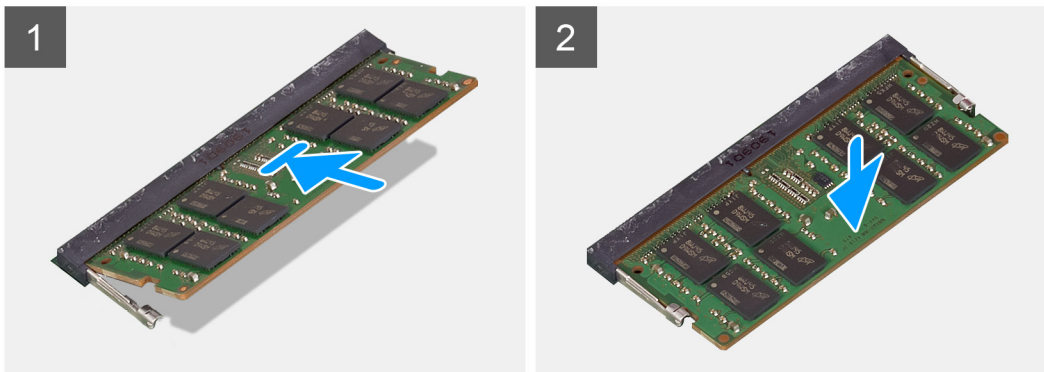
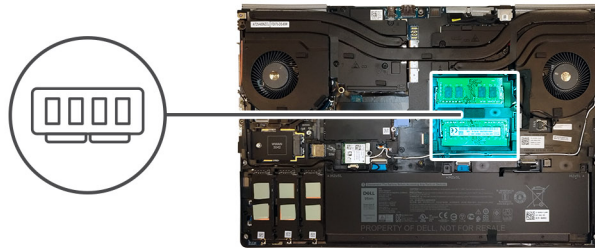

Steps

1. Align the notch on the memory module with the tab on the memory-module slot.
2. Slide the memory module firmly into the slot and press the memory module until it clicks into place.

NOTE: If you do not hear the click, remove the memory module and reinstall it.

Next steps

1. Install the [base cover](#).
2. Install the [SD card](#).
3. Follow the procedure in [after working inside your computer](#).

SIM card

Removing the SIM card

Prerequisites

1. Follow the procedure in [before working inside your computer](#).
2. Remove the [SD card](#).
3. Remove the [base cover](#).

About this task

The figure indicates the location of the SIM card and provides a visual representation of the removal procedure.

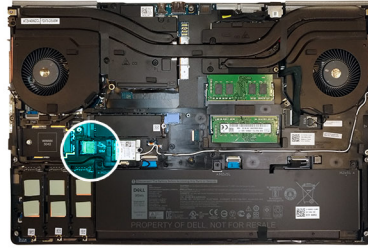

Steps

1. Gently slide the SIM card cover towards the left side of the system to unlock the SIM card cover.

 **CAUTION: The SIM card cover is very fragile and can be easily damaged if it is not properly unlocked before opening.**

2. Flip the right edge of the SIM card cover to open it.
3. Remove the SIM card from the SIM card slot.

Installing the SIM card

Prerequisites

If you are replacing a component, remove the existing component before performing the installation procedure.

About this task

The figure indicates the location of the SIM card and provides a visual representation of the installation procedure.

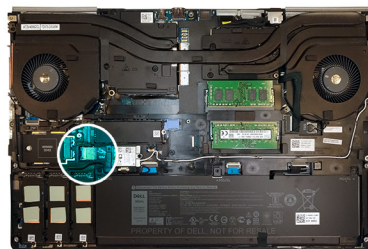

Steps

1. Slide the SIM card into the SIM card slot.
2. Snap the SIM card cover down.
3. Slide the SIM card cover towards the right of the system to lock the cover.

Next steps

1. Install the [base cover](#).
2. Install the [SD card](#).
3. Follow the procedure in [after working inside your computer](#).

WLAN card

Removing the WLAN card

Prerequisites

1. Follow the procedure in [before working inside your computer](#).
2. Remove the [SD card](#).
3. Remove the [base cover](#).

About this task

The figure indicates the location of the WLAN card and provides a visual representation of the removal procedure.

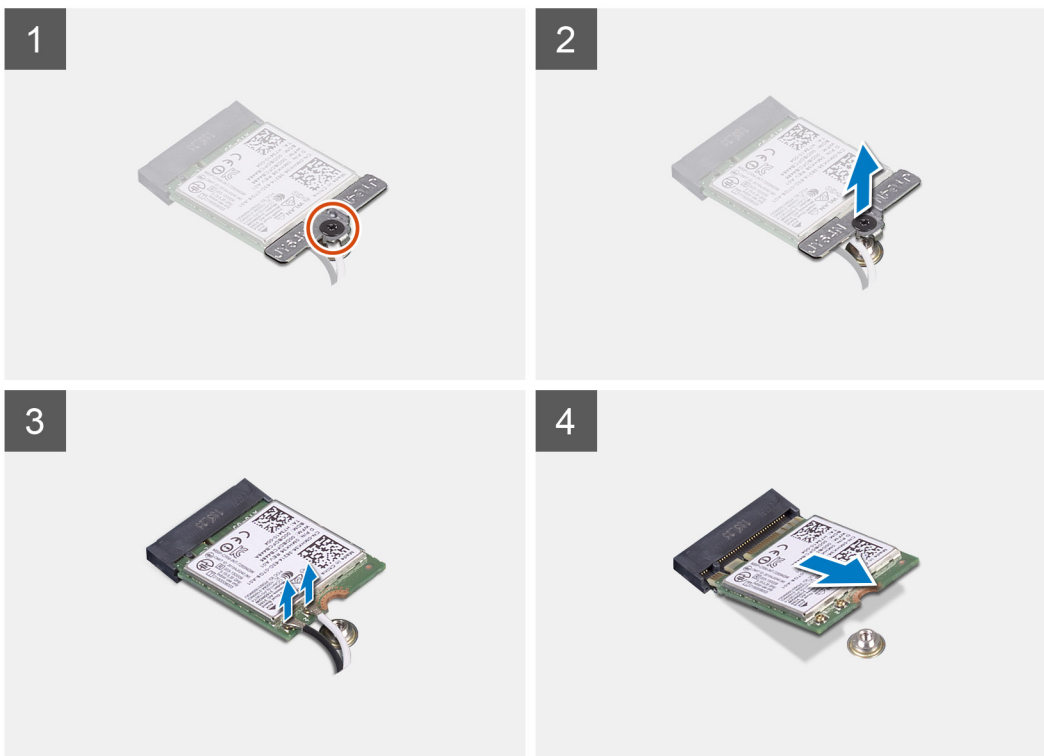
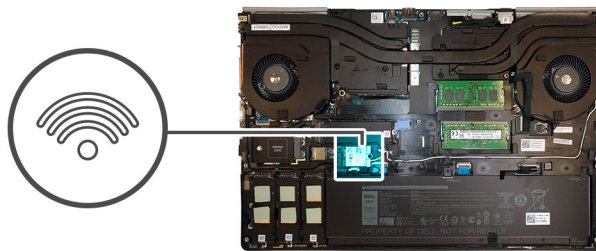

Steps

1. Loosen the captive screw that secures the WLAN card bracket to the system board.
2. Remove the WLAN card bracket away from the WLAN card.
3. Disconnect the antenna cables from the WLAN card.
4. Slide at an angle and remove the WLAN card from the connector on the system board.

Installing the WLAN card

Prerequisites

If you are replacing a component, remove the existing component before performing the installation procedure.

About this task

The figure indicates the location of the WLAN card and provides a visual representation of the installation procedure.

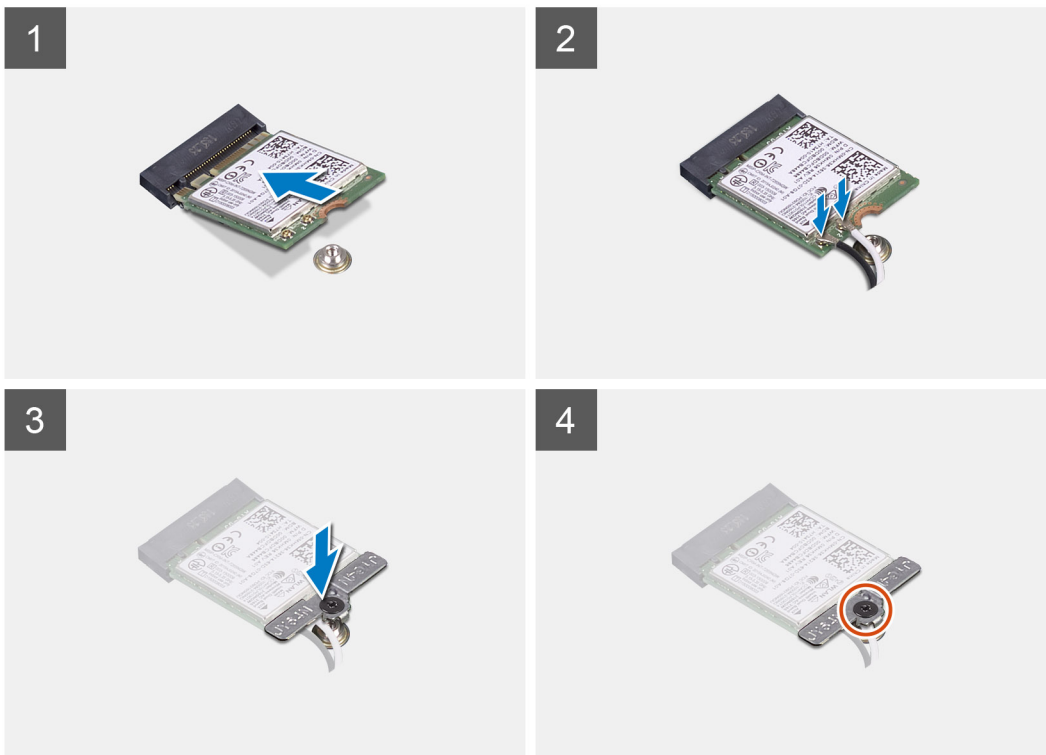
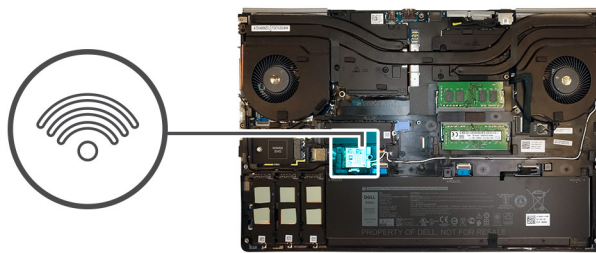

Steps

1. Insert the WLAN card to the connector on the system board.
2. Connect the antenna cables to the WLAN card.
3. Align and place the WLAN card bracket above the WLAN card to secure the antenna cables.
4. Tighten the captive screw to secure the WLAN card bracket to the system board.

Next steps

1. Install the [base cover](#).

2. Install the [SD card](#).
3. Follow the procedure in [after working inside your computer](#).

WWAN card

Removing the WWAN card

Prerequisites

1. Follow the procedure in [before working inside your computer](#).
2. Remove the [SD card](#).
3. Remove the [base cover](#).

About this task

The figure indicates the location of the WWAN card and provides a visual representation of the removal procedure.

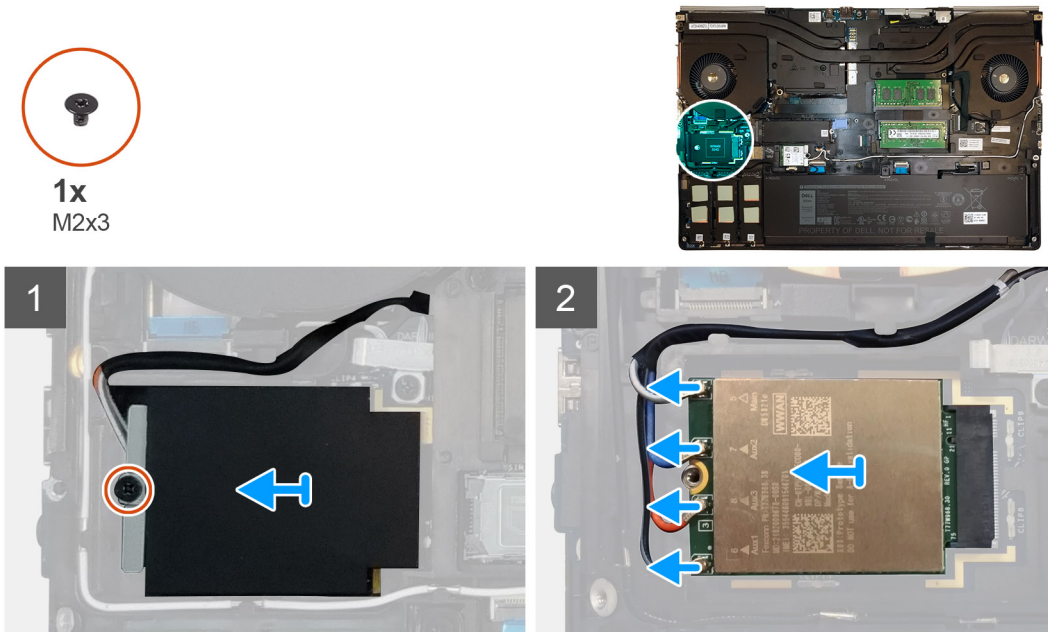

Steps

1. Loosen the (M2x3) screw that secures the WWAN card bracket to the system board.
2. Lift the WWAN card bracket from the WWAN card.
3. Disconnect the antenna cables from the connector on the WWAN card.
4. Slide and remove the WWAN card from its slot on the system board.

Installing the WWAN card

Prerequisites

If you are replacing a component, remove the existing component before performing the installation procedure.

About this task

The figure indicates the location of the WWAN card and provides a visual representation of the installation procedure.

Steps

1. Align and slide the WWAN card to its slot on the system board.

2. Connect the antenna cables to the connectors on the WWAN card.
3. Place the WWAN card bracket above the WWAN card to secure the antenna cables.
4. Tighten the (M2x3) screw to secure the WWAN card bracket to the system board.

Next steps

1. Install the [base cover](#).
2. Install the [SD card](#).
3. Follow the procedure in [after working inside your computer](#).

Keyboard lattice

Removing the keyboard lattice

Prerequisites

1. Follow the procedure in [before working inside your computer](#).
2. Remove the [SD card](#).
3. Remove the [base cover](#).

About this task

The figure indicates the location of the keyboard lattice and provides a visual representation of the removal procedure.



Steps

1. Using a plastic scribe, pry the top edge of the keyboard lattice starting from the recess points and working your way around the sides and bottom edge.
2. Remove the keyboard lattice from the keyboard.

Installing the keyboard lattice

Prerequisites

If you are replacing a component, remove the existing component before performing the installation procedure.

About this task

The figure indicates the location of the M.2 SSD and provides a visual representation of the installation procedure.



Steps

1. Align the keyboard lattice to its position on the keyboard.
2. Press the edges on the keyboard lattice until it clicks into place.

Next steps

1. Install the [base cover](#).
2. Install the [SD card](#).
3. Follow the procedure in [after working inside your computer](#).

Keyboard

Removing the keyboard

Prerequisites

1. Follow the procedure in [before working inside your computer](#).
2. Remove the [SD card](#).
3. Remove the [base cover](#).
4. Remove the [battery](#).
5. Remove the [keyboard lattice](#).

About this task

The figure indicates the location of the keyboard and provides a visual representation of the removal procedure.



Steps

1. Lift the latch and disconnect the keyboard cable and the keyboard backlight cable from the connectors on the touchpad module.
2. Turn-over and open the system at 90° angle.
3. Remove the six (M2x2.5) screws that secure the keyboard to the palmrest.
4. Pry the bottom edge of the keyboard and then work along the left and the right sides of the keyboard.
5. Carefully unrout the keyboard backlight cable and the keyboard cable through the palmrest.
6. Remove the keyboard from the system.

Installing the keyboard

Prerequisites

If you are replacing a component, remove the existing component before performing the installation procedure.

About this task

The figure indicates the location of the keyboard and provides a visual representation of the installation procedure.



6x
M2x2.5

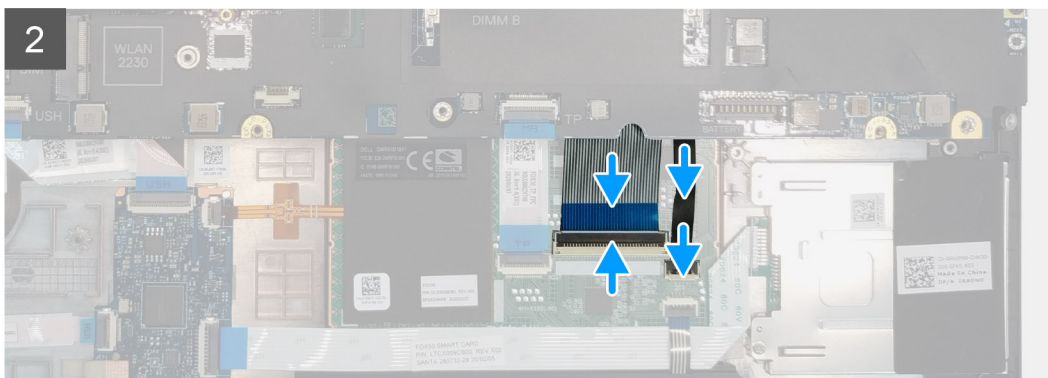

Steps

1. Align the keyboard to its slot on the palmrest
2. Route the keyboard cable and the keyboard backlight cable through the bottom of the palmrest.
3. Replace the six (M2x2.5) screws to secure the keyboard to the palmrest.
4. Turn-over the system at 90° angle to access the keyboard and the keyboard backlight cables.
5. Connect the keyboard backlight cable and the keyboard cable to the connectors on the system board.

i **NOTE:** Ensure that you fold the keyboard data cable in perfect alignment.

Next steps

1. Install the [keyboard lattice](#).
2. Install the [battery](#).
3. Install the [base cover](#).
4. Install the [SD card](#).
5. Follow the procedure in [after working inside your computer](#).

Primary memory module

Removing the primary memory module

Prerequisites

1. Follow the procedure in [before working inside your computer](#).
2. Remove the [SD card](#).
3. Remove the [base cover](#).
4. Remove the [battery](#).
5. Remove the [keyboard lattice](#).
6. Remove the [keyboard](#).

About this task

The figure indicates the location of the primary memory module and provides a visual representation of the removal procedure.

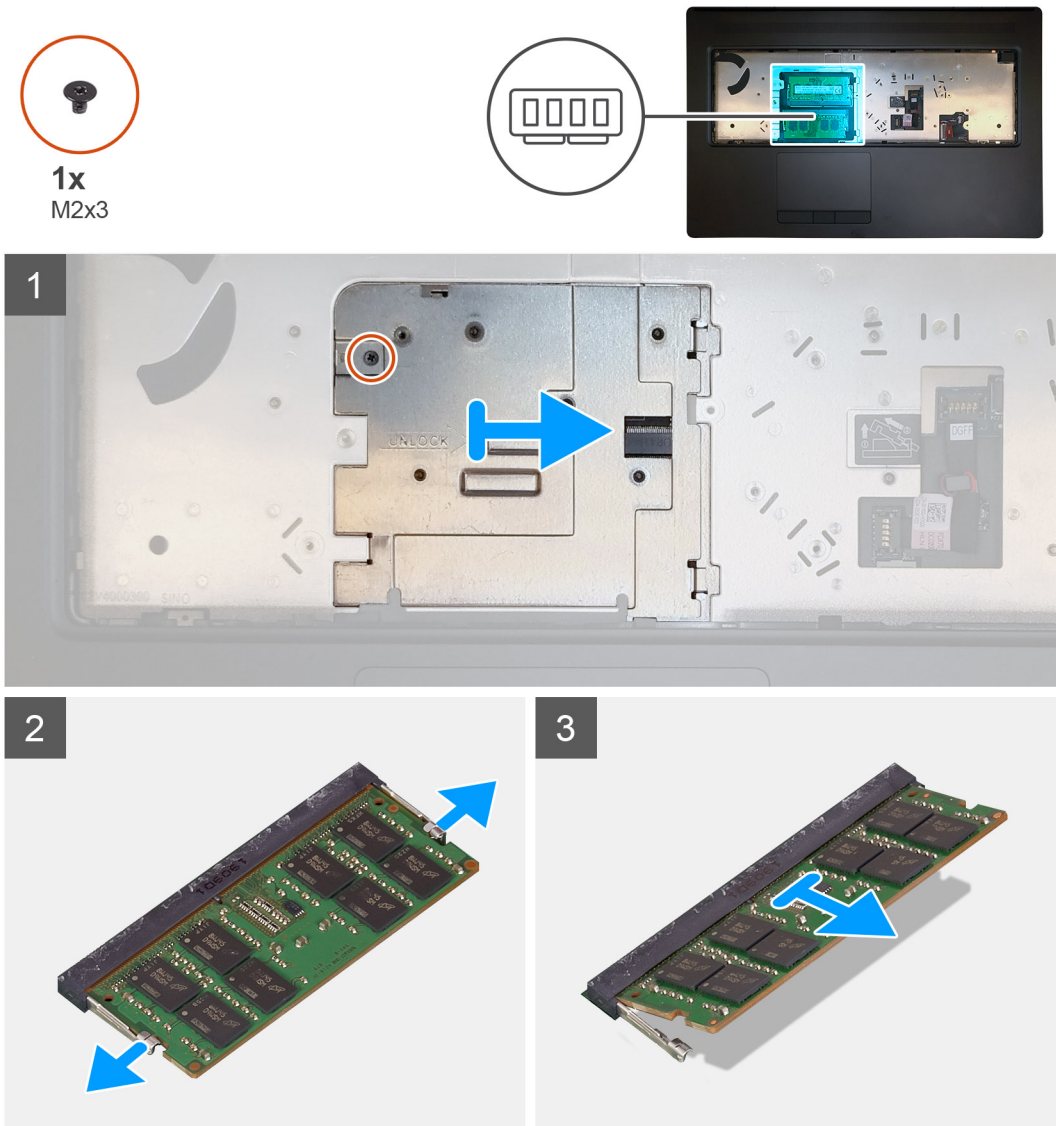

Steps

1. Remove the (M2x3) screw that secures the memory shield in place.

2. Slide the memory shield towards the right side of the computer and lift the shield from the memory module.
3. Pry the securing clips from both side of the memory module until the memory module pops up.
4. Remove the memory module from the memory-module slot.

i **NOTE:** Repeat the above steps if there are other memory installed.

Installing the primary memory module

Prerequisites

If you are replacing a component, remove the existing component before performing the installation procedure.

About this task

The figure indicates the location of the primary memory module and provides a visual representation of the installation procedure.

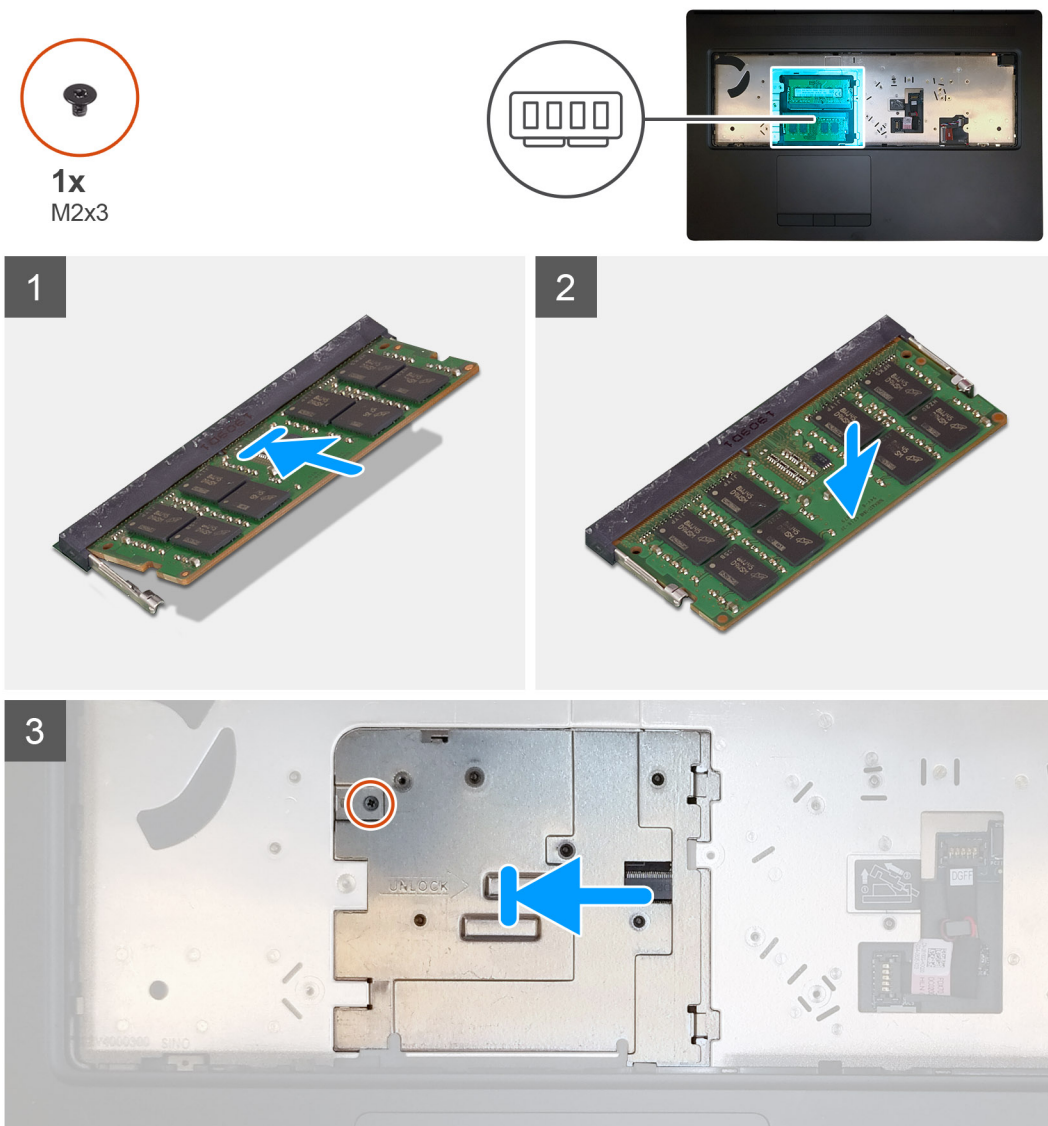

Steps

1. Align the notch on the memory module with the tab on the memory-module slot.
2. Slide the memory module firmly into the slot at an angle and press the memory module down until it clicks into place.
3. Carefully align the two clips on the memory shield with the slots on the computer chassis and insert the clips under the chassis.

- Place the memory shield and slide it towards the left side of the computer to cover the memory module.
- Replace the (M2x3) screw to secure the memory shield to the memory module.

Next steps

- Install the [keyboard](#).
- Install the [keyboard lattice](#).
- Install the [battery](#).
- Install the [base cover](#).
- Install the [SD card](#).
- Follow the procedure in [after working inside your computer](#).

Heat sink

Removing the heat-sink assembly

Prerequisites

- Follow the procedure in [before working inside your computer](#).
- Remove the [SD card](#).
- Remove the [base cover](#).
- Remove the [battery](#).

About this task

The figure indicates the location of the heat-sink assembly and provides a visual representation of the removal procedure.

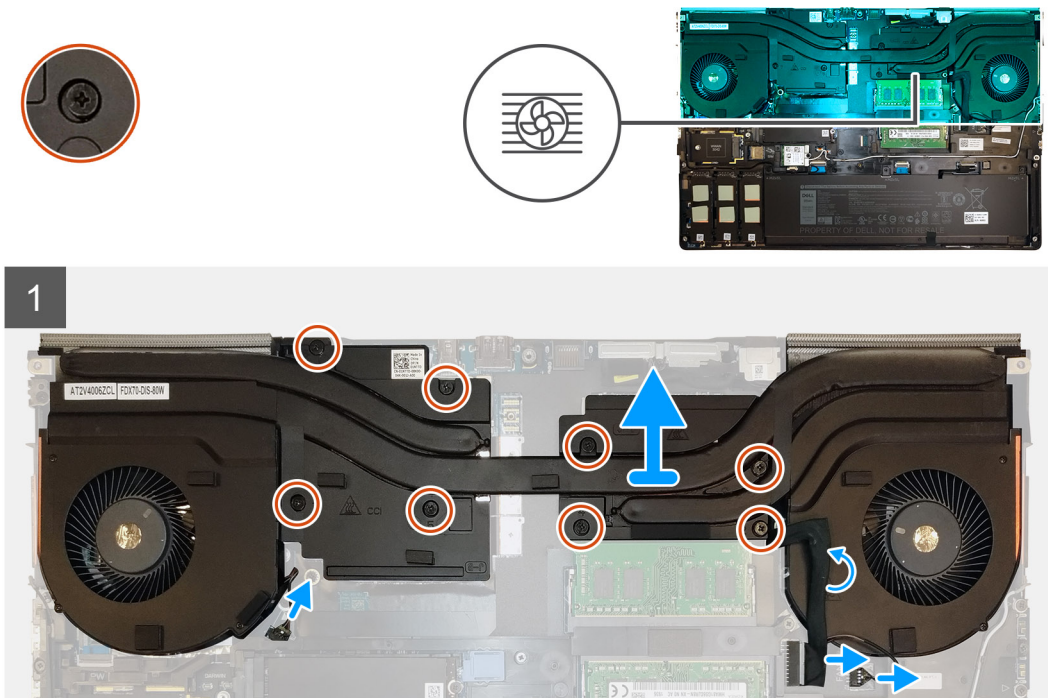

Steps

- Peel the power-adapter cable from the heat-sink assembly.
- Disconnect the two fan cables from the connectors on the system board.
- Loosen the eight captive screws that secure the heat-sink assembly to the system board.

NOTE: Loosen the captive screws in the order stamped onto the heat-sink assembly next to the screws [1 > 2 > 3 > 4 > 5 > 6 > 7 > 8].

4. Lift the heat-sink assembly to remove it from the computer.

Installing the heat sink assembly

Prerequisites

If you are replacing a component, remove the existing component before performing the installation procedure.

About this task

The figure indicates the location of the keyboard and provides a visual representation of the installation procedure.

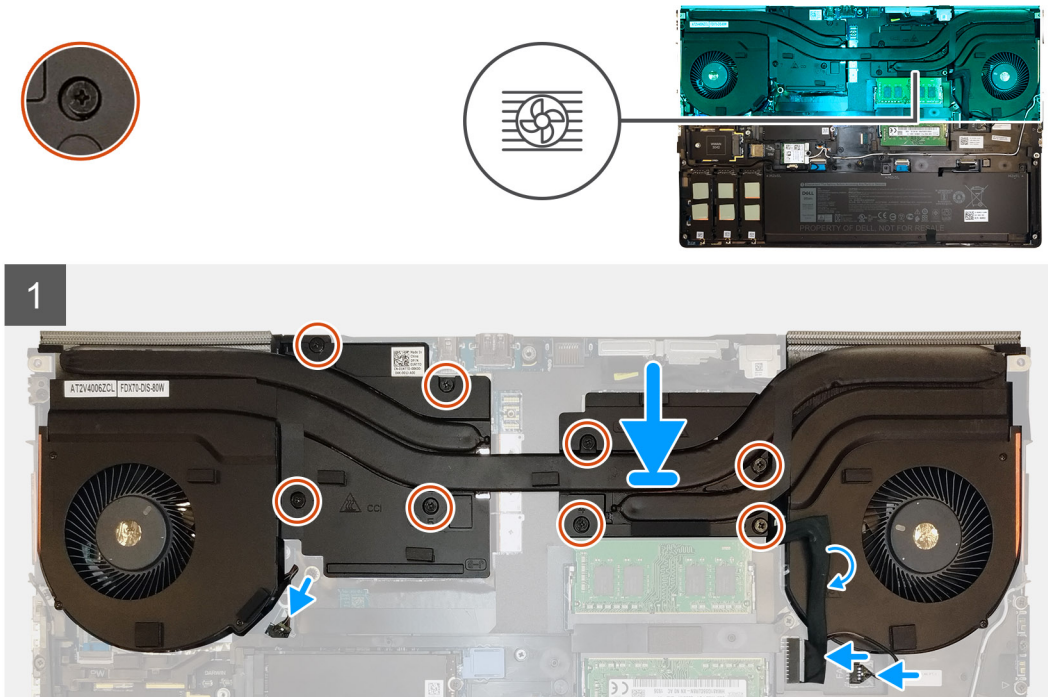

Steps

1. Align and insert the heat-sink assembly into its slot on the computer.
2. Tighten the eight captive screws to secure the heat-sink assembly to the system board.

NOTE: Tighten the captive screws in the order stamped onto the heat sink next to the screws [1 > 2 > 3 > 4 > 5 > 6 > 7 > 8].

3. Connect the two fan cables to the connector on the system board.
4. Adhere the power-adapter cable on the heat-sink assembly.

Next steps

1. Install the [battery](#).
2. Install the [base cover](#).
3. Install the [SD card](#).
4. Follow the procedure in [after working inside your computer](#).

Power-adapter port

Removing the power-adapter port

Prerequisites

1. Follow the procedure in [before working inside your computer](#).
2. Remove the [SD card](#).
3. Remove the [base cover](#).
4. Remove the [battery](#).
5. Remove the [heat-sink assembly](#).

About this task

The figure indicates the location of the power-adapter port and provides a visual representation of the removal procedure.

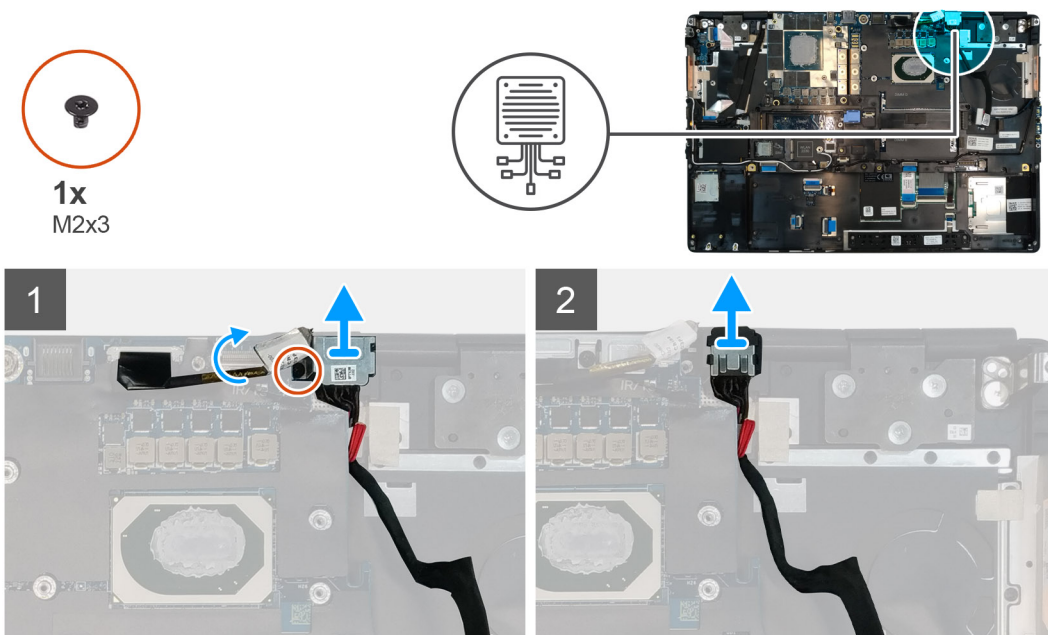

Steps

1. Remove the (M2x3) screw that secures power-adapter cable bracket.
2. Remove the power-adapter cable bracket from the computer.
3. Lift the power-adapter port from its slot on the palmrest.
4. Unroute and remove the power-adapter cable from the computer.

Installing the power-adapter port

Prerequisites

If you are replacing a component, remove the existing component before performing the installation procedure.

About this task

The figure indicates the location of the power-adapter port and provides a visual representation of the installation procedure.



1x
M2x3

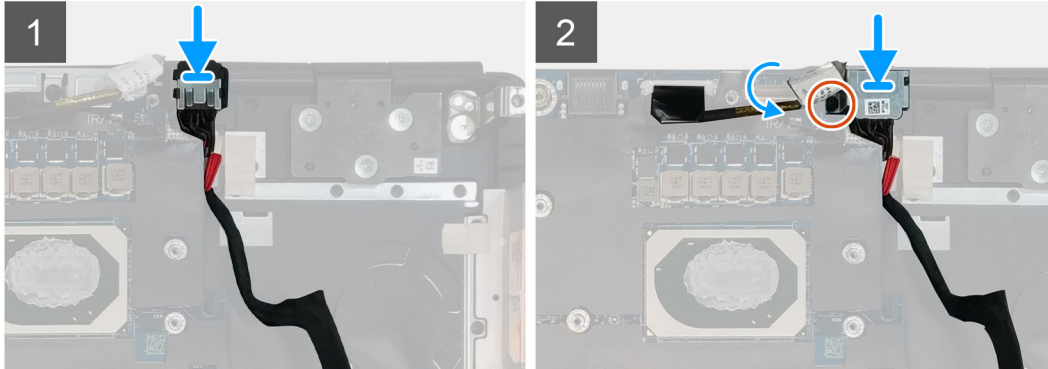
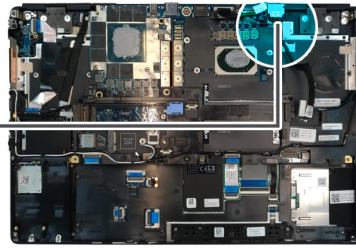
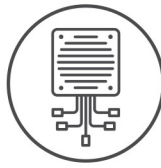

Steps

1. Align and place the power-adapter cable on the computer.
2. Place the power-adapter port into its slot on the palmrest.
3. Replace the power-adapter cable bracket on the power-adapter port.
4. Replace the (M2x3) screw to secure the power-adapter cable bracket to the computer.
5. Connect the power-adapter cable to the connector on the system board.

Next steps

1. Install the [heat-sink assembly](#).
2. Install the [battery](#).
3. Install the [base cover](#).
4. Install the [SD card](#).
5. Follow the procedure in [after working inside your computer](#).

Power button board

Removing the power button board

Prerequisites

1. Follow the procedure in [before working inside your computer](#).
2. Remove the [SD card](#).
3. Remove the [base cover](#).
4. Remove the [battery](#).
5. Remove the [heat-sink assembly](#).

About this task

The figure indicates the location of the power button board and provides a visual representation of the removal procedure.

Steps

1. Disconnect the power button board cable from the connector on the system board.
2. Peel the power button board cable from the palmrest.

3. Remove the two (M2x3) screws that secure the power button board to the computer.
4. Remove the power button board with the power button board cable from the computer.
5. Disconnect the power button board cable from the power button board.

Installing the power button board

Prerequisites

If you are replacing a component, remove the existing component before performing the installation procedure.

About this task

The figure indicates the location of the power button board and provides a visual representation of the installation procedure.

Steps

1. Connect the power button board cable to the power button board.
2. Align and place the power button board with power button cable into its slot on the computer.
3. Replace the two (M2x3) screws to secure the power button board.
4. Adhere the power button board cable to the palmrest.
5. Connect the power button board cable to the connector on the system board.

Next steps

1. Install the [heat-sink assembly](#).
2. Install the [battery](#).
3. Install the [base cover](#).
4. Install the [SD card](#).
5. Follow the procedure in [after working inside your computer](#).

Power button board with fingerprint reader

Removing the power button assembly with fingerprint reader

Prerequisites

1. Follow the procedure in [before working inside your computer](#).
2. Remove the [SD card](#).
3. Remove the [base cover](#).
4. Remove the [battery](#).
5. Remove the [heat-sink assembly](#).

About this task

The figure indicates the location of the power button assembly with fingerprint reader and provides a visual representation of the removal procedure.

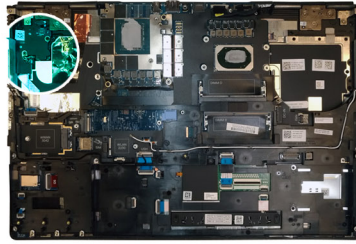
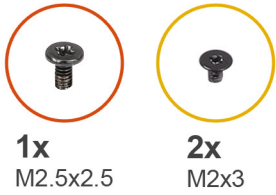

Steps

1. Remove the (M2.5x2.5) screw that secures the power button assembly with fingerprint reader cable bracket to the power button board.
2. Remove the power button assembly with fingerprint reader cable bracket from the power button board.
3. Disconnect the power button assembly with fingerprint reader cable from the power button board.
4. Disconnect the power button board cable from the connector on the system board.
5. Peel the power button board cable from the palmrest.
6. Remove the two (M2x3) screws that secure the power button board to the computer.
7. Remove the power button board with the power button board cable from the computer.
8. Disconnect the power button board cable from the power button board.

Installing the power button assembly with fingerprint reader

Prerequisites

If you are replacing a component, remove the existing component before performing the installation procedure.

About this task

The figure indicates the location of the power button assembly with fingerprint reader and provides a visual representation of the installation procedure.

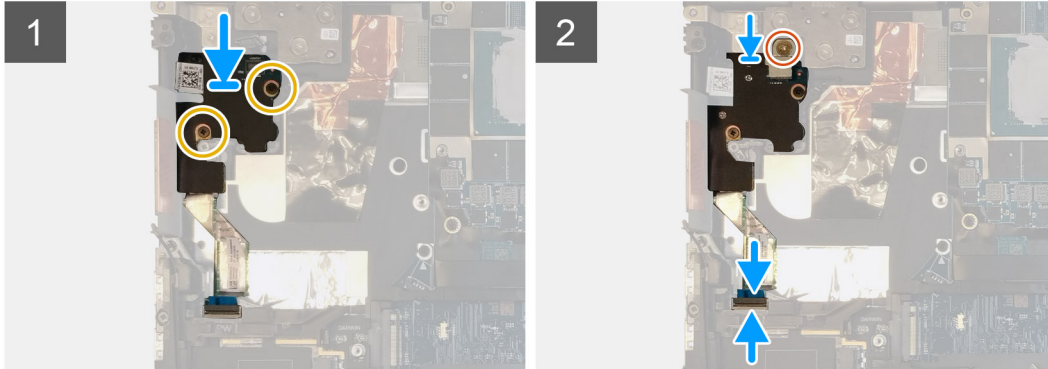
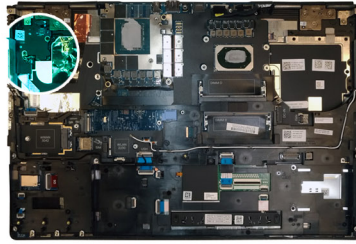
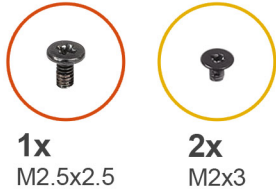

Steps

1. Connect the power button board cable to the power button board.
2. Align and place the power button board with power button cable into its slot on the computer.
3. Replace the two (M2x3) screws to secure the power button board.
4. Adhere the power button board cable to the palmrest.
5. Connect the power button board cable to the connector on the system board.
6. Connect the power button assembly with fingerprint reader cable to the power button board,
7. Replace the power button assembly with fingerprint reader cable bracket above the power button daughter board.
8. Replace the (M2.5x2.5) screw to secure the power button assembly with fingerprint reader cable bracket in place.

Next steps

1. Install the [heat-sink assembly](#).
2. Install the [battery](#).
3. Install the [base cover](#).
4. Install the [SD card](#).
5. Follow the procedure in [after working inside your computer](#).

Inner frame

Removing the inner frame

Prerequisites

1. Follow the procedure in [before working inside your computer](#).
2. Remove the [SD card](#).
3. Remove the [base cover](#).
4. Remove the [battery](#).
5. Remove the [WLAN card](#).
6. Remove the [WWAN card](#).
7. Remove the [primary M.2 SSD](#).

About this task

The figure indicates the location of the inner frame and provides a visual representation of the removal procedure.



6x
M2x5

9x
M2x3

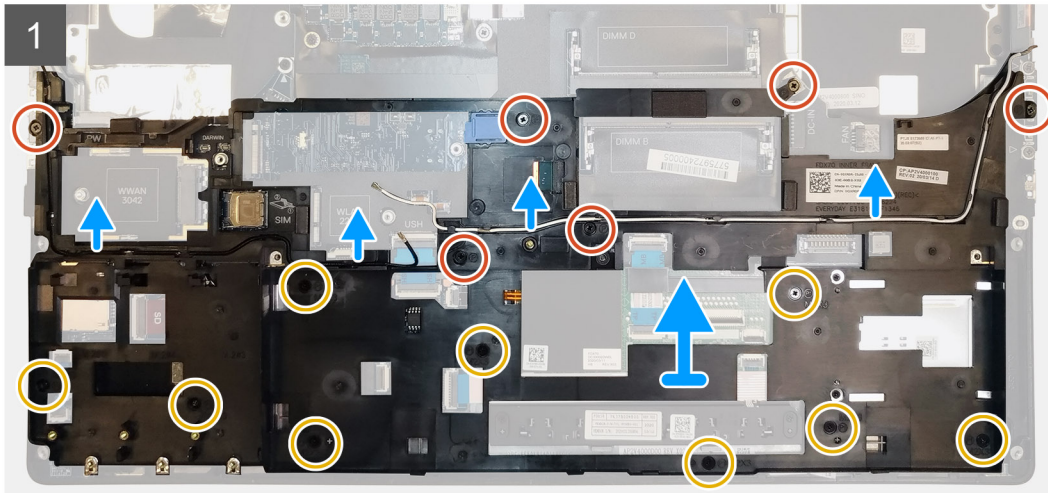
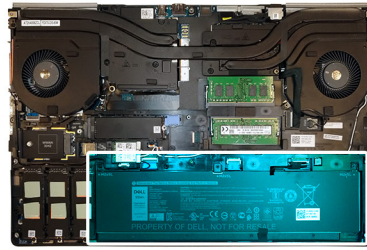

Steps

1. Unroute the WLAN and WWAN antenna cables from the routing guide.
2. Disconnect the keyboard cable and the keyboard backlight cable from the connector on the touchpad module.
3. Remove the six (M2x5) and the nine (M2x3) screws that secure the inner frame to the computer chassis.
4. Remove the inner frame from the computer while carefully unthreading the keyboard cable and keyboard backlight cable through the opening on the inner frame.

Installing the inner frame

Prerequisites

If you are replacing a component, remove the existing component before performing the installation procedure.

About this task

The figure indicates the location of the inner frame and provides a visual representation of the installation procedure.

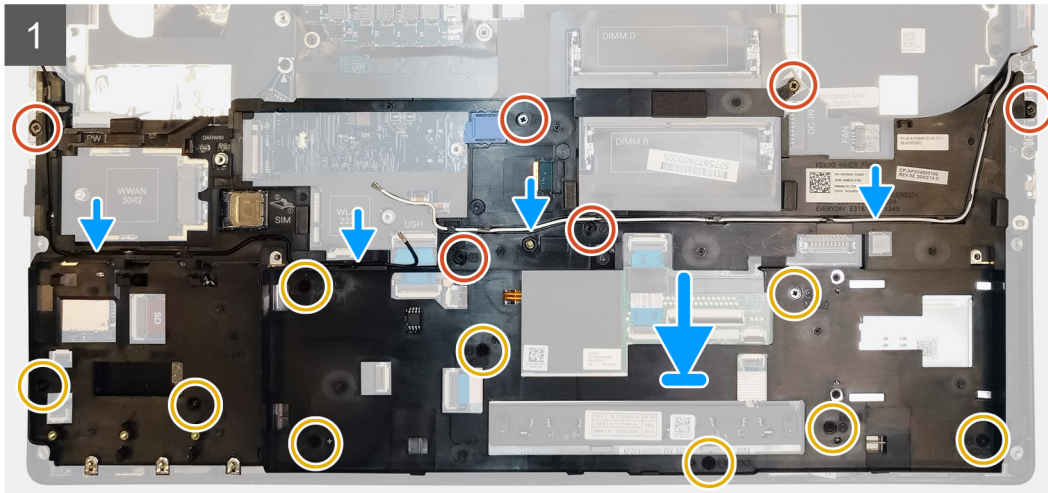
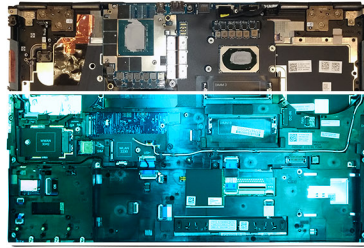

Steps

1. Carefully route the keyboard and keyboard backlight cable through the inner frame and place the inner frame on the computer chassis.
2. Replace the six (M2x5) and the nine (M2x3) screws to secure the inner frame in place.
3. Route the WLAN and WWAN antenna cables through the routing guide.

Next steps

1. Install the [WLAN card](#).
2. Install the [WWAN card](#).
3. Install the [primary M.2 SSD](#).
4. Install the [battery](#).
5. Install the [base cover](#).
6. Install the [SD card](#).
7. Follow the procedure in [after working inside your computer](#).

Smart card cage

Removing the smart-card reader

Prerequisites

1. Follow the procedure in [before working inside your computer](#).
2. Remove the [SD card](#).
3. Remove the [base cover](#).
4. Remove the [battery](#).
5. Remove the [primary M.2 SSD](#).
6. Remove the [WLAN card](#).
7. Remove the [WWAN card](#).
8. Remove the [inner frame](#).

About this task

The figure indicates the location of the smart-card reader and provides a visual representation of the removal procedure.



2x
M2x2.5

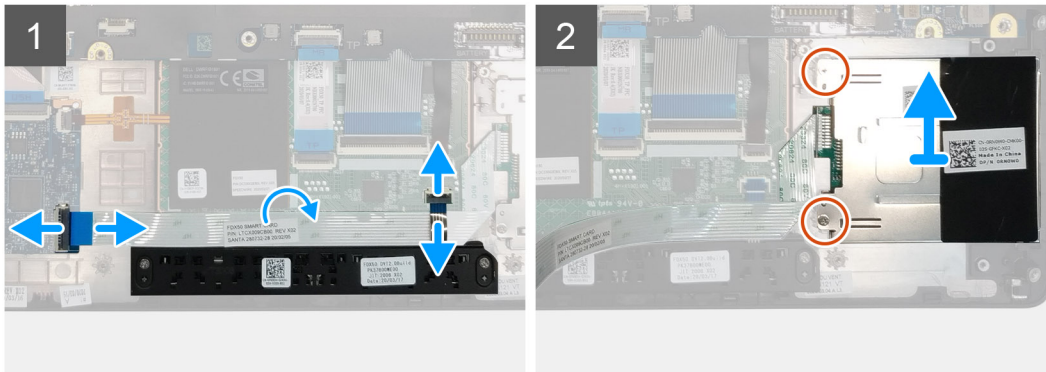
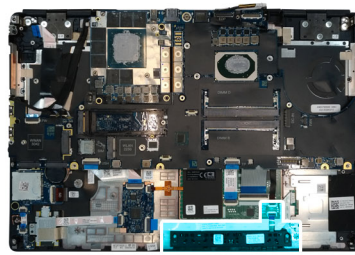

Steps

1. Disconnect the touchpad buttons cable from the touchpad.
2. Disconnect the smart-card reader cable from the connector on the USH daughter board.
3. Peel the smart-card reader cable from the touchpad.
4. Remove the two (M2x2.5) screws that secure the smart-card reader to the computer.
5. Remove the smart-card reader from the computer.

Installing the smart-card reader

Prerequisites

If you are replacing a component, remove the existing component before performing the installation procedure.

About this task

The figure indicates the location of the smart-card reader and provides a visual representation of the installation procedure.



2x
M2x2.5

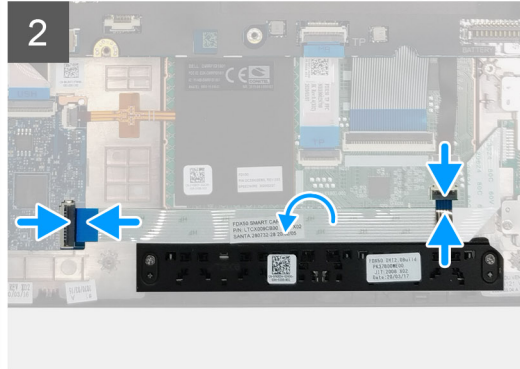
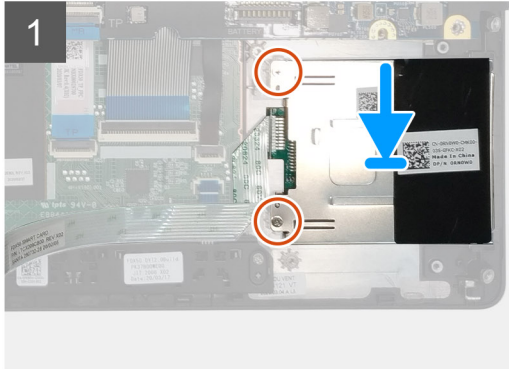
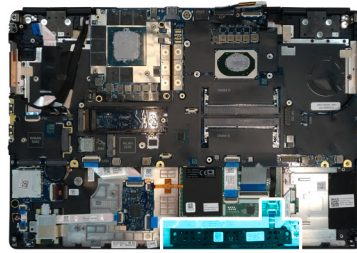

Steps

1. Align and place the smart-card reader into its slot on the computer.
2. Replace the two (M2x2.5) screws to secure the smart-card reader in place.
3. Adhere the smart-card reader cable to the touchpad.
4. Connect the smart-card reader cable to the connector on the USH daughter board.
5. Connect the touchpad button cable to the connector on the touchpad.

Next steps

1. Install the [WLAN card](#).
2. Install the [WWAN card](#).
3. Install the [primary M.2 SSD](#).
4. Install the [inner frame](#).
5. Install the [battery](#).
6. Install the [base cover](#).
7. Install the [SD card](#).
8. Follow the procedure in [after working inside your computer](#).

Touchpad button

Removing the Touchpad buttons

Prerequisites

1. Follow the procedure in [before working inside your computer](#).
2. Remove the [SD card](#).
3. Remove the [base cover](#).
4. Remove the [battery](#).
5. Remove the [primary M.2 SSD](#).
6. Remove the [WLAN card](#).
7. Remove the [WWAN card](#).
8. Remove the [inner frame](#).

About this task

The figure indicates the location of the touchpad buttons and provides a visual representation of the removal procedure.



2x
M2x2.5

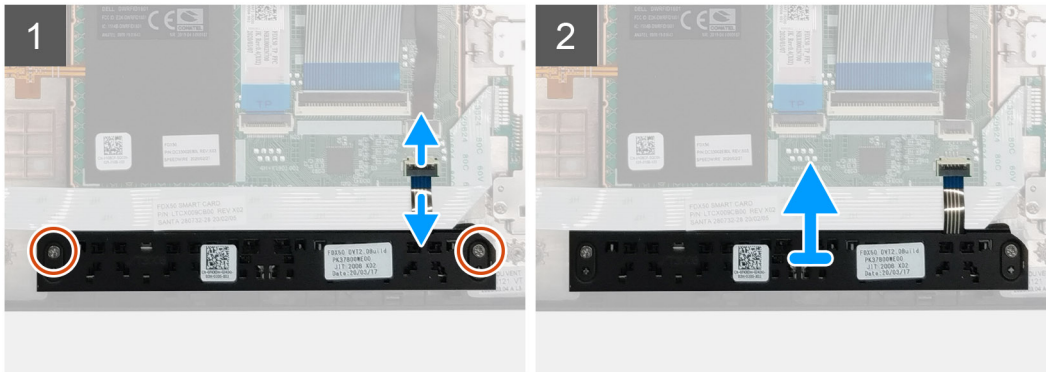
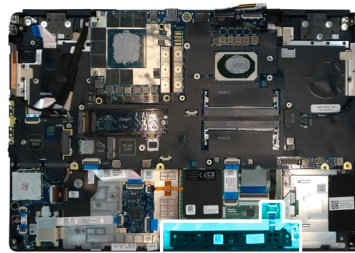

Steps

1. For models shipped with smart card reader, disconnect the smart card reader cable from the USH daughter board and peel the smart card reader cable from the touchpad.
2. Disconnect the touchpad buttons cable from the connector on the touchpad.
3. Remove the two (M2x2.5) screws that secure the touchpad buttons to the palmrest.
4. Remove the touchpad buttons from the palmrest.

Installing the Touchpad buttons

Prerequisites

If you are replacing a component, remove the existing component before performing the installation procedure.

About this task

The figure indicates the location of the touchpad buttons and provides a visual representation of the installation procedure.



2x
M2x2.5

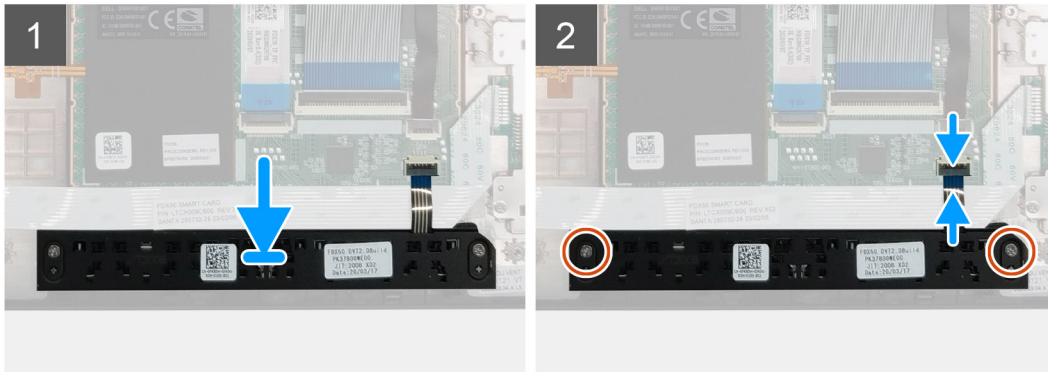
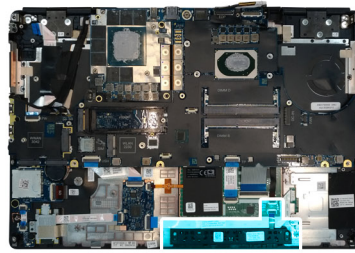

Steps

1. Place the touchpad buttons into its slot in the palmrest.
2. Replace the two (M2x2.5) screws to secure the touchpad buttons to the palmrest
3. Connect the touchpad buttons cable to the connector in the touchpad.
4. For models shipped with smart card reader, connect the smart card reader cable to the USH daughter board and adhere the smart card reader cable on the touchpad.

Next steps

1. Install the [inner frame](#).
2. Install the [WLAN card](#).
3. Install the [WWAN card](#).
4. Install the [primary M.2 SSD](#).
5. Install the [battery](#).
6. Install the [base cover](#).
7. Install the [SD card](#).
8. Follow the procedure in [after working inside your computer](#).

SD card reader

Removing SD card reader

Prerequisites

1. Follow the procedure in [before working inside your computer](#).
2. Remove the [SD card](#).
3. Remove the [base cover](#).
4. Remove the [battery](#).
5. Remove the [primary M.2 SSD](#).
6. Remove the [WWAN card](#).
7. Remove the [WLAN card](#).
8. Remove the [inner frame](#).

About this task

The figure indicates the location of the SD card reader and provides a visual representation of the removal procedure.



2x
M2.5x2.5

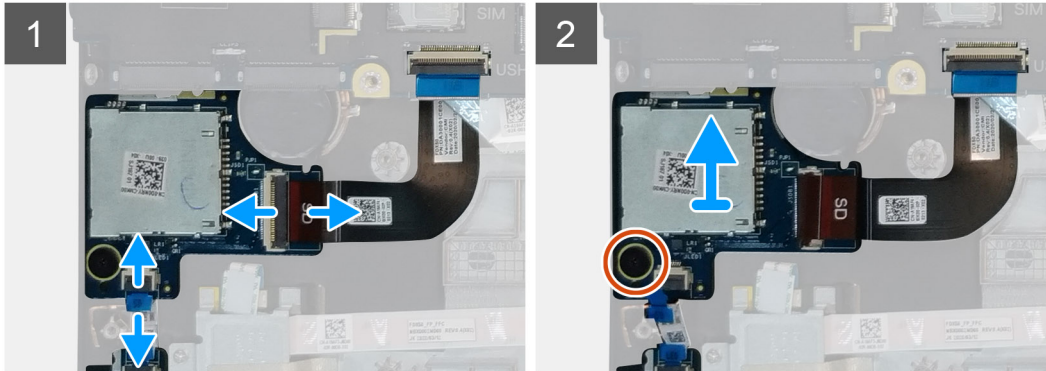
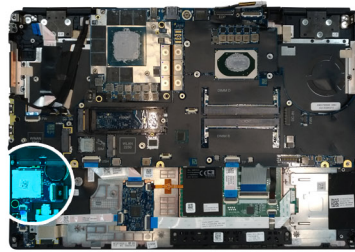

Steps

1. Disconnect the SD card reader cable from the connector on the system board.
2. Disconnect the LED board cable from the SD card reader on the bottom side of the computer.
3. Remove the (M2.5x2.5) screw that secures the SD card reader in place.
4. Slide and remove the SD card reader with its cable out of the computer.

Installing SD card reader

Prerequisites

If you are replacing a component, remove the existing component before performing the installation procedure.

About this task

The figure indicates the location of the SD card reader and provides a visual representation of the installation procedure.



2x
M2.5x2.5

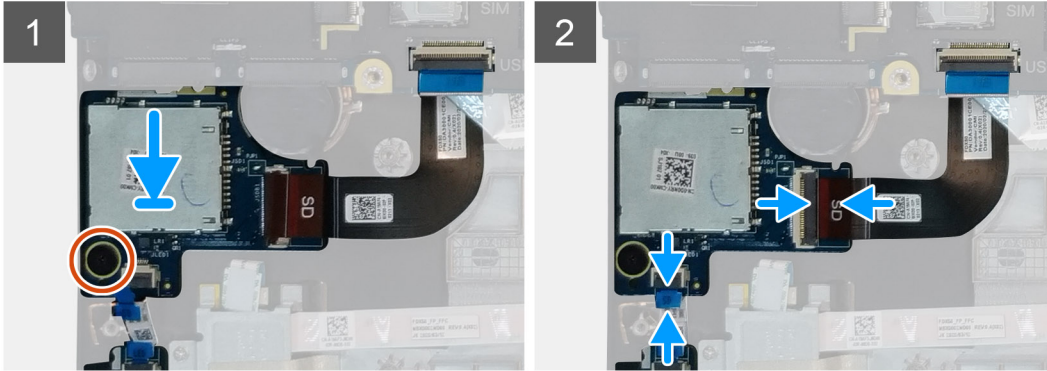
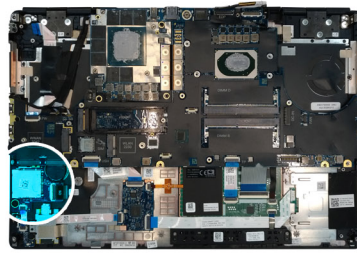

Steps

1. Align and place the SD card reader with its slot on the palmrest.
2. Replace the (M2.5x2.5) screw to secure the SD card reader to the palmrest.
3. Connect the LED board cable to the SD card reader on the bottom side of the computer.
4. Connect the SD card reader cable to the connector on the system board.

Next steps

1. Install the [inner frame](#).
2. Install the [WLAN card](#).
3. Install the [WWAN card](#).
4. Install the [primary M.2 SSD](#).
5. Install the [inner frame](#).
6. Install the [battery](#).
7. Install the [base cover](#).
8. Install the [SD card](#).
9. Follow the procedure in [after working inside your computer](#).

Power button

Removing the power button

Prerequisites

1. Follow the procedure in [before working inside your computer](#).
2. Remove the [SD card](#).
3. Remove the [base cover](#).
4. Remove the [battery](#).
5. Remove the [heat-sink assembly](#).
6. Remove the [power button board](#).

About this task

The figure indicates the location of the power button and provides a visual representation of the removal procedure.



2x
M2x3

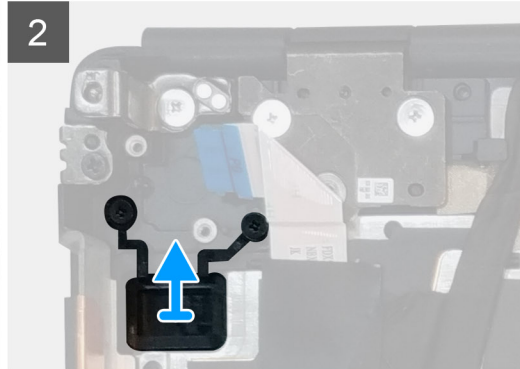
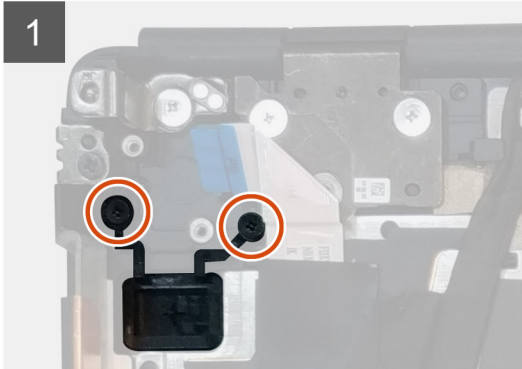
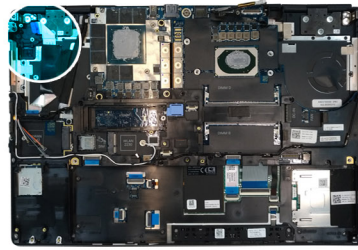

Steps

1. Remove the two (M2x3) screws that secure the power button in its slot on the computer.
2. Remove the power button from the computer.

Installing the power button

Prerequisites

If you are replacing a component, remove the existing component before performing the installation procedure.

About this task

The figure indicates the location of the power button and provides a visual representation of the installation procedure.



2x
M2x3

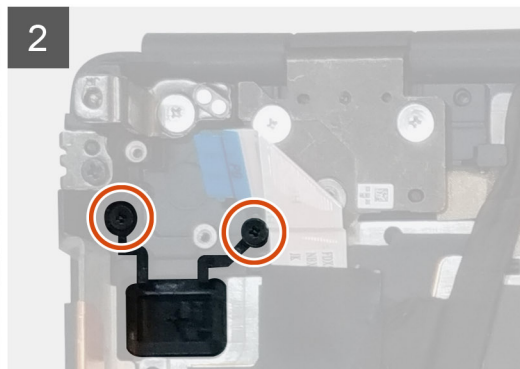
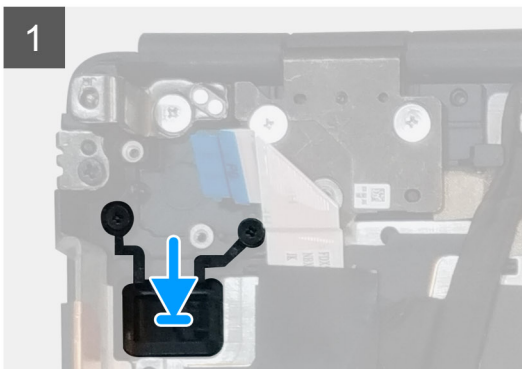
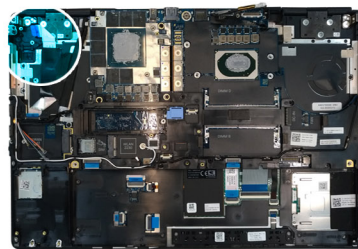

Steps

1. Place the power button into its slot on the computer.
2. Replace the two (M2x3) screws to secure the power button in place.

Next steps

1. Install the [power button board](#).
2. Install the [heat-sink assembly](#).
3. Install the [battery](#).
4. Install the [base cover](#).
5. Install the [SD card](#).
6. Follow the procedure in [after working inside your computer](#).

Power button assembly with fingerprint reader

Removing the power button assembly with fingerprint reader

Prerequisites

1. Follow the procedure in [before working inside your computer](#).
2. Remove the [SD card](#).
3. Remove the [base cover](#).
4. Remove the [battery](#).
5. Remove the [heat-sink assembly](#).
6. Remove the [power button board assembly with fingerprint reader](#).

About this task

The figure indicates the location of the power button and provides a visual representation of the removal procedure.



2x
M2x3

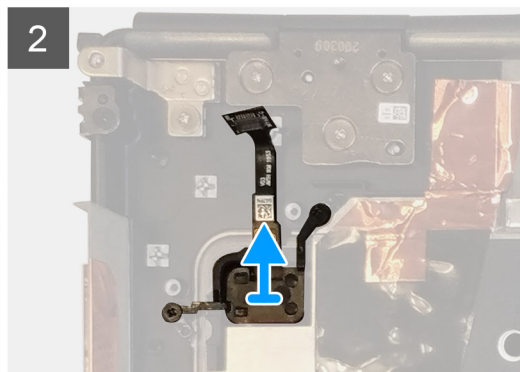
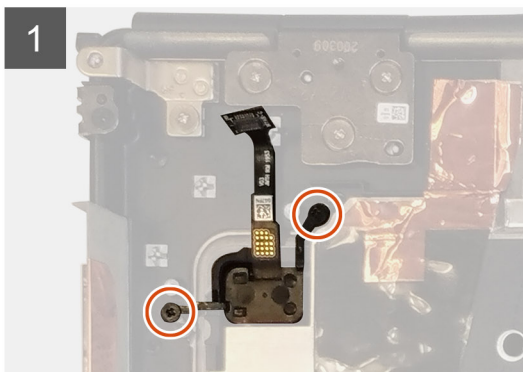
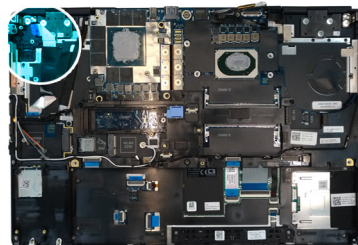

Steps

1. Remove the two (M2x3) screws that secure the power button assembly with fingerprint reader in its slot on the computer.
2. Remove the power button assembly with fingerprint reader from the computer.

Installing the power button assembly with fingerprint reader

Prerequisites

If you are replacing a component, remove the existing component before performing the installation procedure.

About this task

The figure indicates the location of the power button and provides a visual representation of the installation procedure.



2x
M2x3

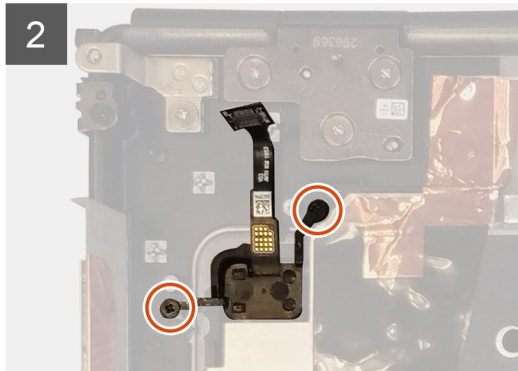
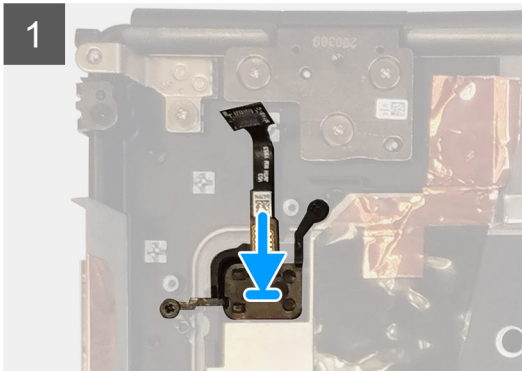
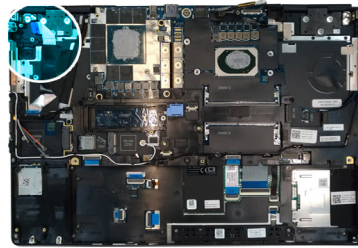

Steps

1. Place the power button assembly with fingerprint reader into its slot on the computer.
2. Replace the two (M2x3) screws to secure the power button assembly with fingerprint reader in place.

Next steps

1. Install the [power button board assembly with fingerprint reader](#).
2. Install the [heat-sink assembly](#).
3. Install the [battery](#).
4. Install the [base cover](#).
5. Install the [SD card](#).
6. Follow the procedure in [after working inside your computer](#).

GPU power cable

Removing the GPU power cable

Prerequisites

1. Follow the procedure in [before working inside your computer](#).
2. Remove the [SD card](#).
3. Remove the [base cover](#).
4. Remove the [battery](#).

5. Remove the [keyboard lattice](#).
6. Remove the [keyboard](#).

About this task

The figure indicates the location of the GPU power cable and provides a visual representation of the removal procedure.

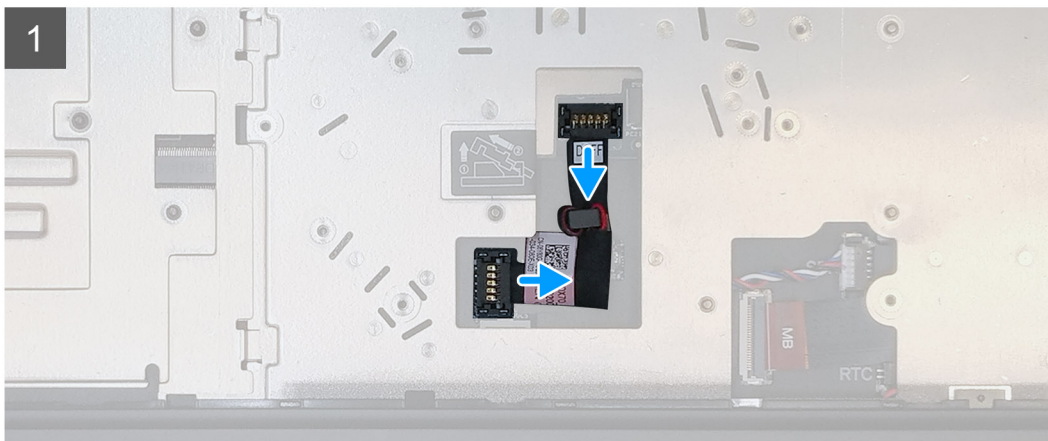
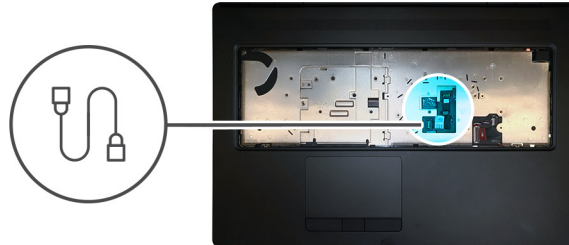

Steps

1. Carefully pry the GPU power cable connector outside the end of the connector head to unlock the GPU power cable connector from the GPU card.
2. Slightly slide the GPU power cable connector outwards to disconnect the GPU power cable from the GPU card.
3. Repeat the above steps to disconnect the GPU power cable from the system board.
4. Peel the GPU power cable from the computer.

Installing the GPU power cable

Prerequisites

If you are replacing a component, remove the existing component before performing the installation procedure.

About this task

The figure indicates the location of the GPU power cable and provides a visual representation of the installation procedure.

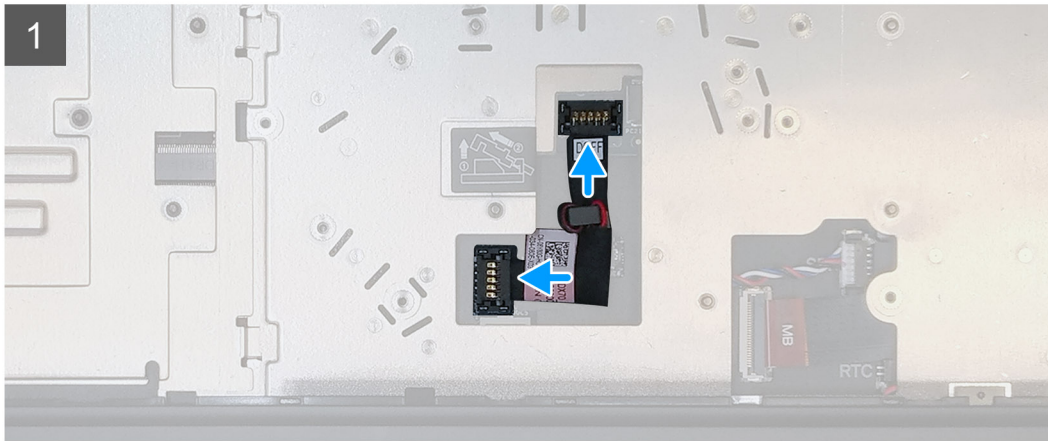
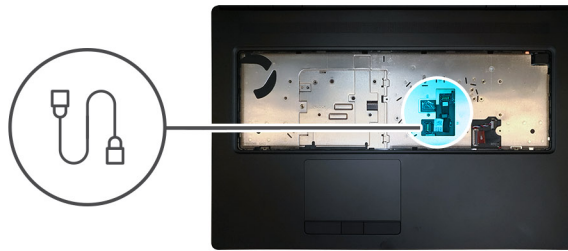

Steps

1. Adhere the GPU power cable into its slot on the computer.
2. Disconnect the GPU power cable from the connector on the system board.
3. Slide the GPU power cable connector into its slot to connect the GPU power cable to the GPU card.
4. Lock the GPU power cable connector to secure the GPU card.

Next steps

1. Install the [keyboard](#).
2. Install the [keyboard lattice](#).
3. Install the [battery](#).
4. Install the [base cover](#).
5. Install the [SD card](#).
6. Follow the procedure in [after working inside your computer](#).

System board

Removing the system board

Prerequisites

1. Follow the procedure in [before working inside your computer](#).
2. Remove the [SD card](#).
3. Remove the [SSD door](#).
4. Remove the [secondary M.2 SSD](#).
5. Remove the [base cover](#).
6. Remove the [battery](#).
7. Remove the [primary M.2 SSD](#).
8. Remove the [SIM card](#).
9. Remove the [secondary memory](#).
10. Remove the [WWAN card](#).
11. Remove the [WLAN card](#).

12. Remove the [keyboard lattice](#).
13. Remove the [keyboard](#).
14. Remove the [primary memory](#).
15. Remove the [heat-sink assembly](#).
16. Remove the [inner frame](#).

About this task

The figure indicates the location of the system board and provides a visual representation of the removal procedure. Images to be uploaded in the next review cycle.

NOTE: For discrete models shipped with GPU card:

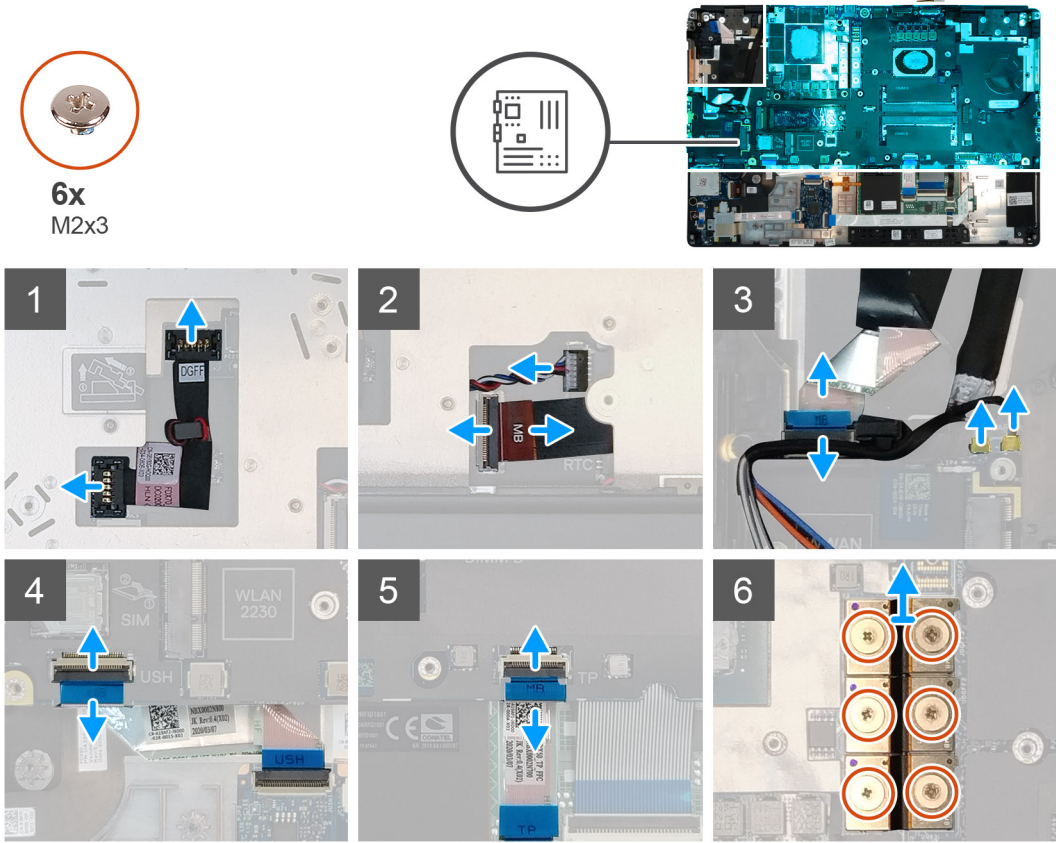



5x
M2x5



1x
M2x3

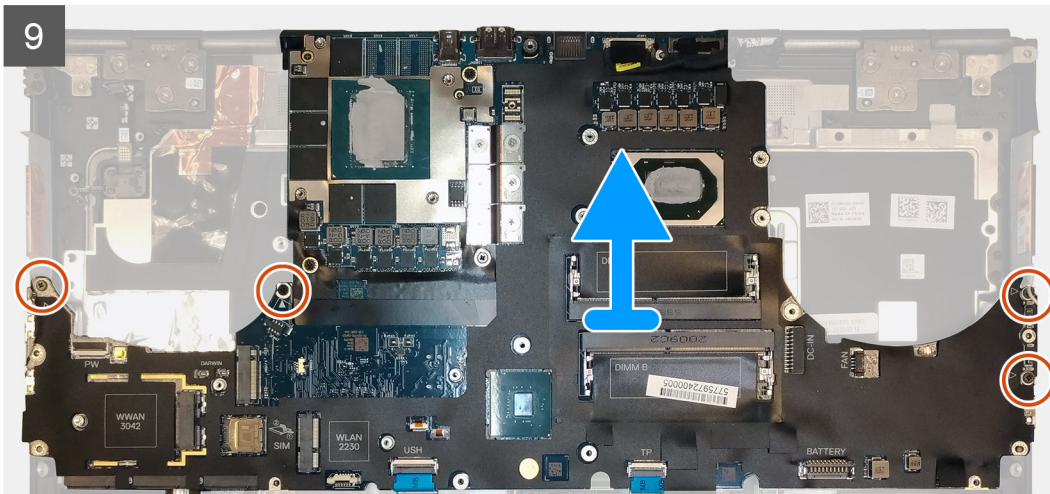
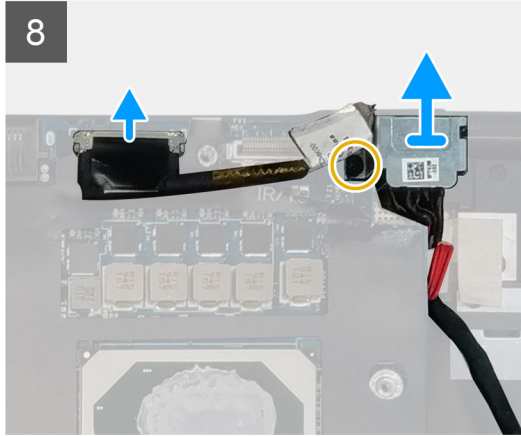
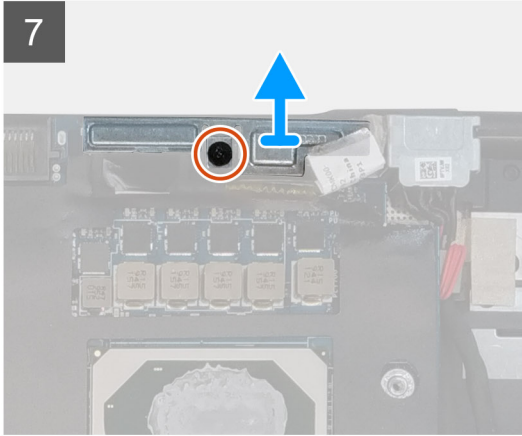

Steps

1. Carefully pry the GPU power cable connector outside the end of the connector head to unlock the GPU power cable connector from the system board on top side of the system.
2. Slightly slide the GPU power cable connector outwards to disconnect the GPU power cable from the connector on the system board.
3. Disconnect the speaker cable and the SD card reader cable from the connectors on the system board.
4. Disconnect the touch screen cable (for models shipped with a touch screen) or IR camera cable (for models shipped with an IR camera), power adapter cable, touchpad cable, USH daughter board cable (for models shipped with a USH daughter board), and power button board cable from the system board.
5. Remove the (M2x3) screw that secures the Darwin cable bracket in place.
6. Remove the Darwin cable bracket.
7. Disconnect the Darwin cables from the connectors on the system board.
8. Remove the six (M2x3) screws that secure the three beam connectors in place on the bottom of the system.

(i) NOTE: This step is applicable for discrete models shipped with 256 MB VRAM GPU card.

9. Remove the four (M2x3) screws that secure the two beam connectors in place on the bottom of the system.

(i) NOTE: This step is applicable for discrete models shipped with 128 MB VRAM GPU card.



NOTE: For UMA models, remove the two (M2x3) screws that secure the single beam connector in place on the bottom of the system.

10. Remove the beam connectors from the computer.
11. Remove the (M2x5) screw that secures the display cable bracket in place.
12. Remove the display cable bracket from the computer.
13. Disconnect the display cable from the connector on the system board.
14. Remove the four (M2x5) screws that secure the system board to the computer.
15. Pry the coin-cell battery, located under the system board, from the palmrest while lifting the system board.
16. Remove the system board from the computer.

Installing the system board

Prerequisites

If you are replacing a component, remove the existing component before performing the installation procedure.

About this task

The figure indicates the location of the system board and provides a visual representation of the installation procedure.



5x
M2x5



1x
M2x3

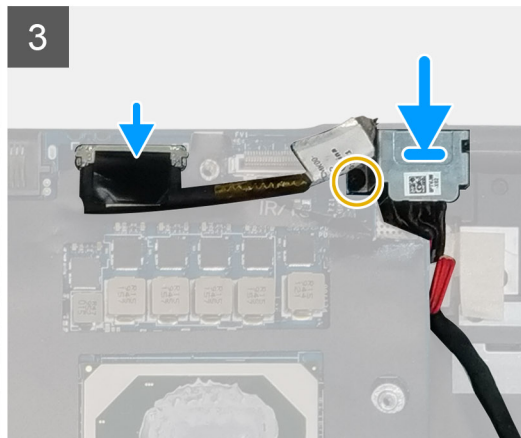
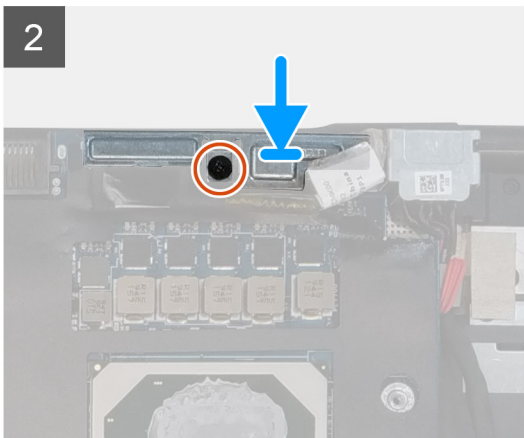
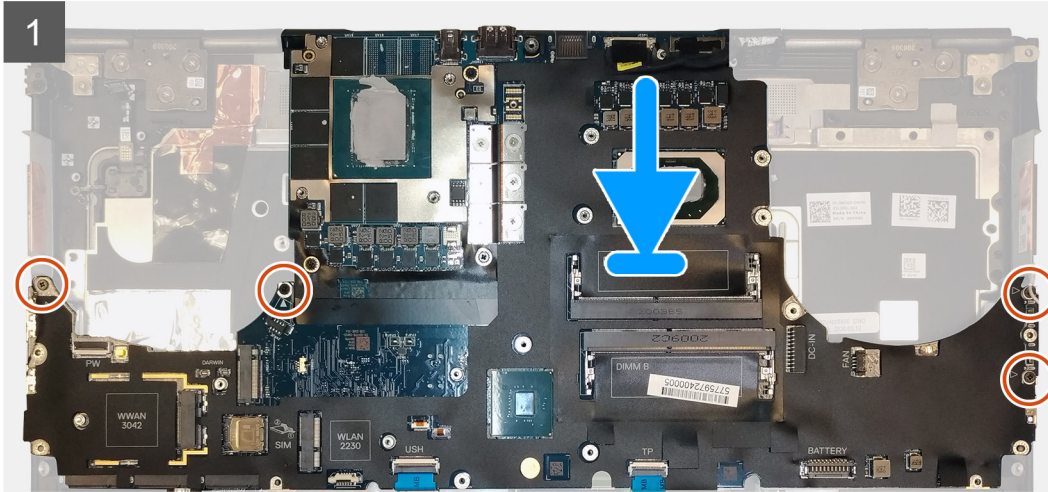
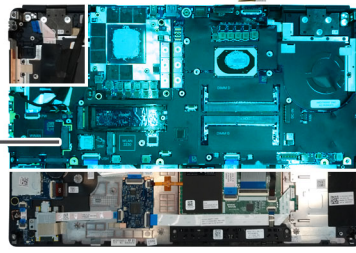



6x
M2x3

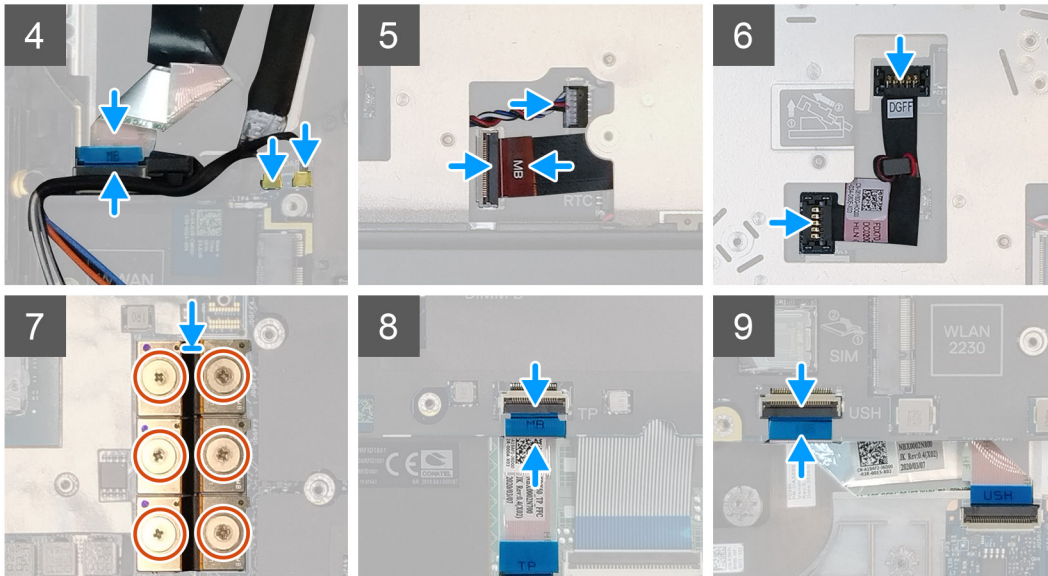

Steps

1. Adhere the coin-cell battery to the palmrest and then place the system board on its slot on the palmrest.
2. Replace the four (M2x5) screws to secure the system board to the palmrest.
3. Connect the display cable, touch screen cable (for models shipped with a touch screen) or IR camera cable (for models shipped with an IR camera), power adapter cable, touchpad cable, USH daughter board FFC (for models shipped with a USH daughter board), and power button board cable to the connectors on the system board.
4. Replace the display cable bracket on the display cable.
5. Replace the (M2x5) screw to secure the display cable bracket to the system board.
6. Connect the Darwin cables to the connectors on the system board.
7. Replace the Darwin cable bracket on the Darwin cable connector.
8. Replace the (M2x3) screw to secure the Darwin cable bracket to the system board.
9. Connect the beam connectors on the system board.

NOTE:

- For UMA models, replace the two (M2x3) screws to secure the single beam connector in place on the bottom side of the system.
- For discrete models shipped with a 128 MB vram GPU card, replace the four (M2x3) screws to secure the two beam connector in place on the bottom side of the system.
- For discrete models shipped with a 256 MB vram GPU card, replace the six (M2x3) screws to secure the three beam connector in place on the bottom side of the system.

10. Connect the speaker cable and SD card reader cable to the connectors on the system board.
11. Connect the GPU power cable to the connector on the system board on the top side of the
12. Lock the GPU power cable connector on the system board.

Next steps

1. Install the [inner frame](#).
2. Install the [heat-sink assembly](#).
3. Install the [primary memory](#).

4. Install the [keyboard](#).
5. Install the [keyboard lattice](#).
6. Install the [WLAN card](#).
7. Install the [WWAN card](#).
8. Install the [secondary memory](#).
9. Install the [SIM card](#).
10. Install the [primary M.2 SSD](#).
11. Install the [inner frame](#).
12. Install the [battery](#).
13. Install the [base cover](#).
14. Install the [secondary M.2 SSD](#).
15. Install the [SSD door](#).
16. Install the [SD card](#).
17. Follow the procedure in [after working inside your computer](#).

GPU card

Removing the GPU card

Prerequisites

1. Follow the procedure in [before working inside your computer](#).
2. Remove the [SD card](#).
3. Remove the [SSD door](#).
4. Remove the [secondary M.2 SSD](#).
5. Remove the [base cover](#).
6. Remove the [battery](#).
7. Remove the [primary M.2 SSD](#).
8. Remove the [SIM card](#).
9. Remove the [secondary memory](#).
10. Remove the [WWAN card](#).
11. Remove the [WLAN card](#).
12. Remove the [keyboard lattice](#).
13. Remove the [keyboard](#).
14. Remove the [GPU power cable](#).
15. Remove the [primary memory](#).
16. Remove the [heat-sink assembly](#).
17. Remove the [inner frame](#).
18. Remove the [system board](#).

About this task

The figure indicates the location of the system board and provides a visual representation of the removal procedure. Images to be uploaded in the next review cycle.

 **NOTE: For discrete models shipped with GPU card:**

Steps

1. Remove the three (M2x5) screws that secures the GPU card to the palmrest.
2. Remove the GPU card from the computer.

Installing the GPU card

Prerequisites

If you are replacing a component, remove the existing component before performing the installation procedure.

About this task

The figure indicates the location of the GPU card and provides a visual representation of the installation procedure.

Images to be uploaded in the next review cycle

Steps

1. Align and place the GPU card into its slot on the palmrest.
2. Replace the three (M2x5) screws to secure the GPU card to the palmrest.

Next steps

1. Install the [system board](#).
2. Install the [inner frame](#).
3. Install the [heat-sink assembly](#).
4. Install the [primary memory](#).
5. Install the [GPU power cable](#).
6. Install the [keyboard](#).
7. Install the [keyboard lattice](#).
8. Install the [WLAN card](#).
9. Install the [WWAN card](#).
10. Install the [secondary memory](#).
11. Install the [SIM card](#).
12. Install the [primary M.2 SSD](#).
13. Install the [battery](#).
14. Install the [base cover](#).
15. Install the [secondary M.2 SSD](#).
16. Install the [SSD door](#).
17. Install the [SD card](#).
18. Follow the procedure in [after working inside your computer](#).

Speaker

Removing the speaker

Prerequisites

1. Follow the procedure in [before working inside your computer](#).
2. Remove the [SD card](#).
3. Remove the [SSD door](#).
4. Remove the [secondary M.2 SSD](#).
5. Remove the [base cover](#).
6. Remove the [battery](#).
7. Remove the [primary M.2 SSD](#).
8. Remove the [SIM card](#).
9. Remove the [secondary memory](#).
10. Remove the [WWAN card](#).
11. Remove the [WLAN card](#).
12. Remove the [keyboard lattice](#).
13. Remove the [keyboard](#).

14. Remove the [primary memory](#).
15. Remove the [heat-sink assembly](#).
16. Remove the [inner frame](#).
17. Remove the [GPU power cable](#).
18. Remove the [GPU card](#).
19. Remove the [system board](#).

About this task

The figure indicates the location of the speaker and provides a visual representation of the removal procedure. Images to be uploaded in the next review cycle.

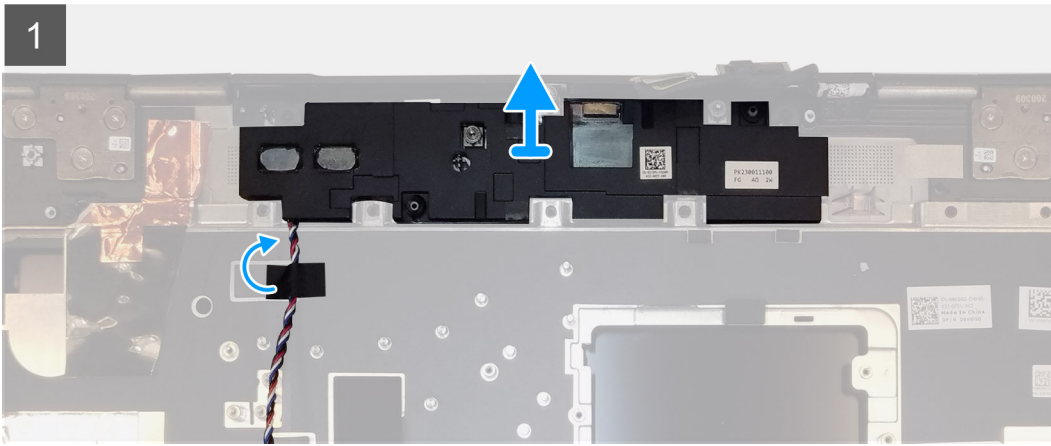
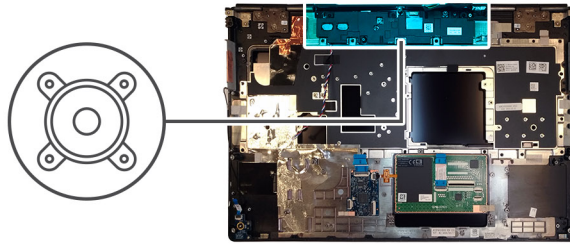

Steps

1. Peel the pieces of adhesive tape that secures the speaker cable to the palmrest.
2. Pry the speaker module from its slot on the top edge of the palmrest.
3. Remove the speaker module from the computer.

Installing the speaker

Prerequisites

If you are replacing a component, remove the existing component before performing the installation procedure.

About this task

The figure indicates the location of the speaker and provides a visual representation of the installation procedure.

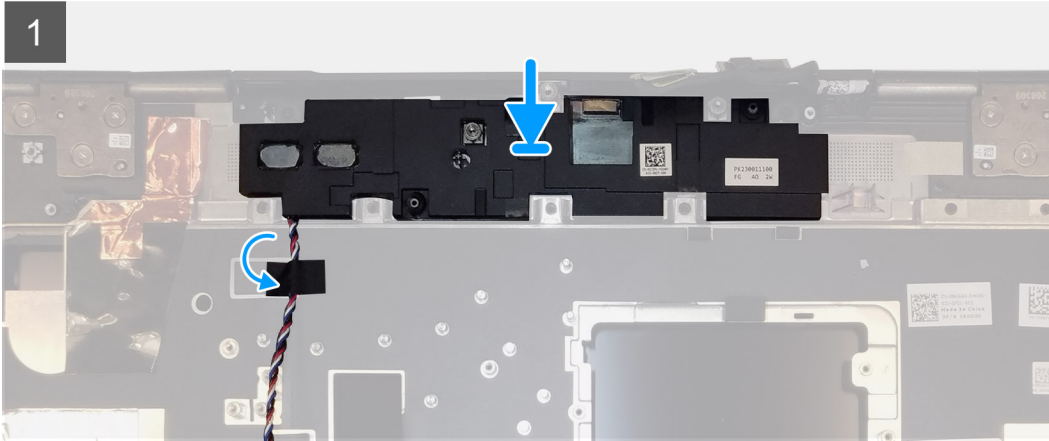
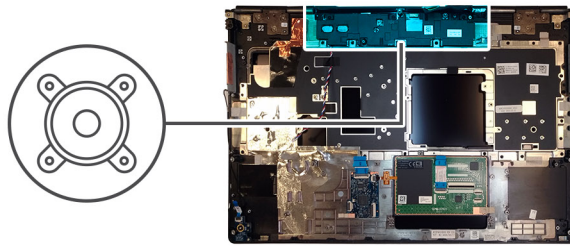

Steps

1. Align and place the speaker module into its slot on the top edge of the palmrest.
2. Adhere the three piece adhesive tape to secure the speaker cable in place on the palmrest.

Next steps

1. Install the [system board](#).
2. Install the [GPU card](#).
3. Install the [GPU power cable](#).
4. Install the [inner frame](#).
5. Install the [heat-sink assembly](#).
6. Install the [primary memory](#).
7. Install the [keyboard](#).
8. Install the [keyboard lattice](#).
9. Install the [WLAN card](#).
10. Install the [WWAN card](#).
11. Install the [secondary memory](#).
12. Install the [SIM card](#).
13. Install the [primary M.2 SSD](#).
14. Install the [battery](#).
15. Install the [base cover](#).
16. Install the [secondary M.2 SSD](#).
17. Install the [SSD door](#).
18. Install the [SD card](#).
19. Follow the procedure in [after working inside your computer](#).

Middle cap

Removing the middle cap

Prerequisites

1. Follow the procedure in [before working inside your computer](#).
2. Remove the [SD card](#).
3. Remove the [SSD door](#).
4. Remove the [secondary M.2 SSD](#).
5. Remove the [base cover](#).
6. Remove the [battery](#).
7. Remove the [primary M.2 SSD](#).
8. Remove the [SIM card](#).
9. Remove the [secondary memory](#).
10. Remove the [WWAN card](#).
11. Remove the [WLAN card](#).
12. Remove the [keyboard lattice](#).
13. Remove the [keyboard](#).
14. Remove the [primary memory](#).
15. Remove the [heat-sink assembly](#).
16. Remove the [inner frame](#).
17. Remove the [GPU power cable](#).
18. Remove the [GPU card](#).
19. Remove the [system board](#).

About this task

The figure indicates the location of the speaker and provides a visual representation of the removal procedure. Images to be uploaded in the next review cycle.



4x
M2x3

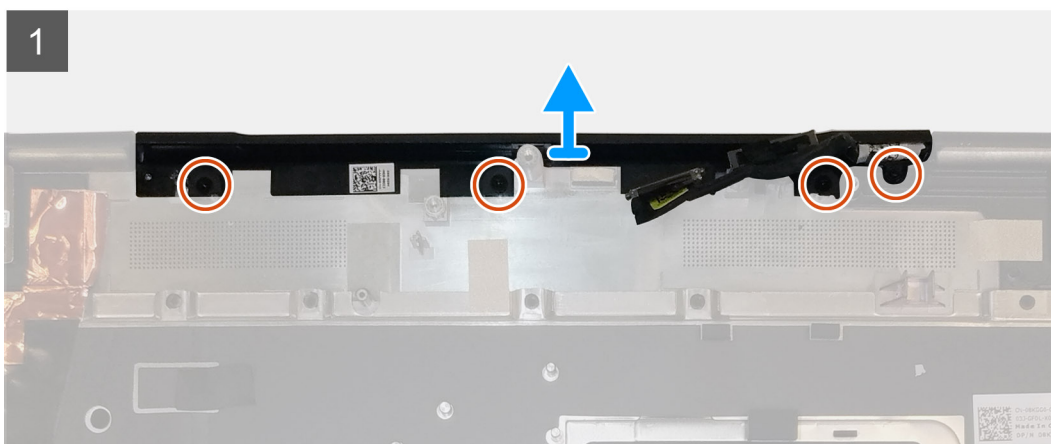
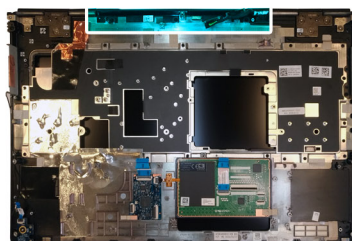

Steps

1. Remove the four (M2x3) screws that secures the middle cap in place.

2. Remove the middle cap from the computer.

Installing the middle cap

Prerequisites

If you are replacing a component, remove the existing component before performing the installation procedure.

About this task

The figure indicates the location of the middle cap and provides a visual representation of the installation procedure.



4x
M2x3

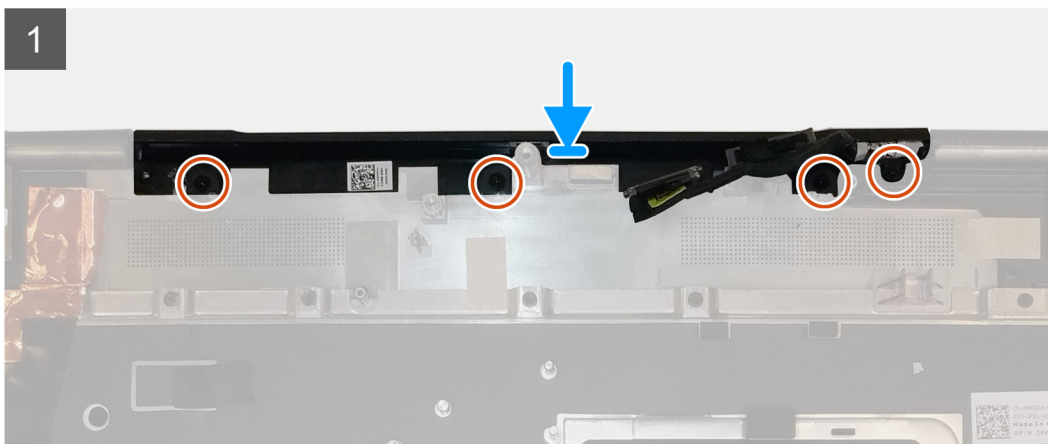
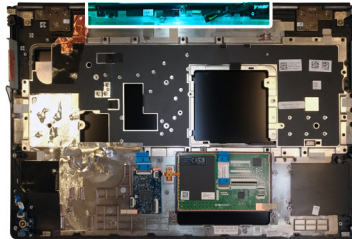

Steps

1. Align and insert the middle cap onto the palmrest.

NOTE: Ensure that the middle cap is secured in place by the two pegs on the palmrest.

2. Replace the four (M2x3) screws to secure the middle cap in place.

Next steps

1. Install the [system board](#).
2. Install the [GPU card](#).
3. Install the [GPU power cable](#).
4. Install the [inner frame](#).
5. Install the [heat-sink assembly](#).
6. Install the [primary memory](#).
7. Install the [keyboard](#).
8. Install the [keyboard lattice](#).
9. Install the [WLAN card](#).
10. Install the [WWAN card](#).
11. Install the [secondary memory](#).
12. Install the [SIM card](#).
13. Install the [primary M.2 SSD](#).
14. Install the [battery](#).

15. Install the [base cover](#).
16. Install the [secondary M.2 SSD](#).
17. Install the [SSD door](#).
18. Install the [SD card](#).
19. Follow the procedure in [after working inside your computer](#).

Display assembly

Removing the display assembly

Prerequisites

1. Follow the procedure in [before working inside your computer](#).
2. Remove the [SD card](#).
3. Remove the [SSD door](#).
4. Remove the [secondary M.2 SSD](#).
5. Remove the [base cover](#).
6. Remove the [battery](#).
7. Remove the [primary M.2 SSD](#).
8. Remove the [SIM card](#).
9. Remove the [secondary memory](#).
10. Remove the [WWAN card](#).
11. Remove the [WLAN card](#).
12. Remove the [keyboard lattice](#).
13. Remove the [keyboard](#).
14. Remove the [primary memory](#).
15. Remove the [heat-sink assembly](#).

About this task

The figure indicates the location of the display assembly and provides a visual representation of the removal procedure.

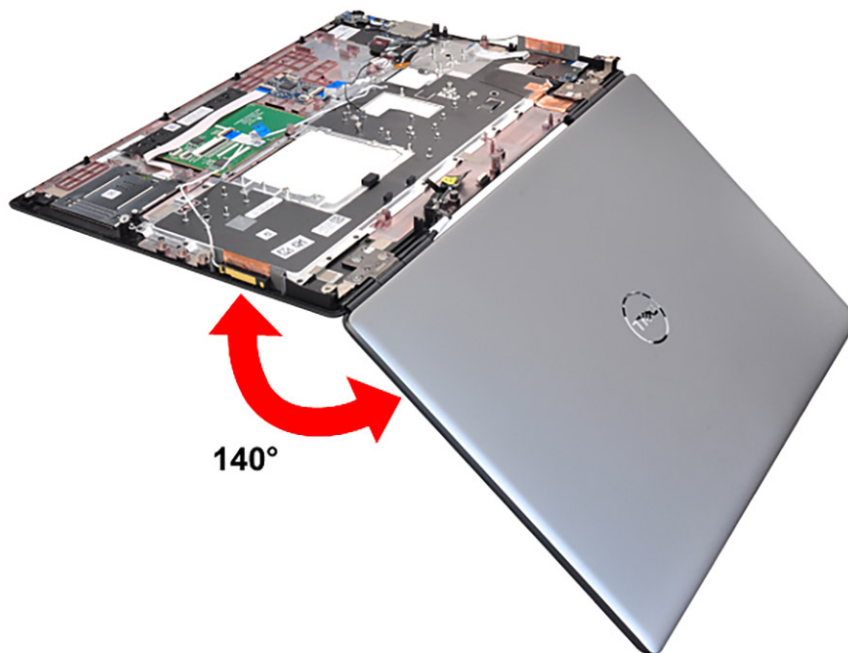



1x
M2x5



1x
M2x3

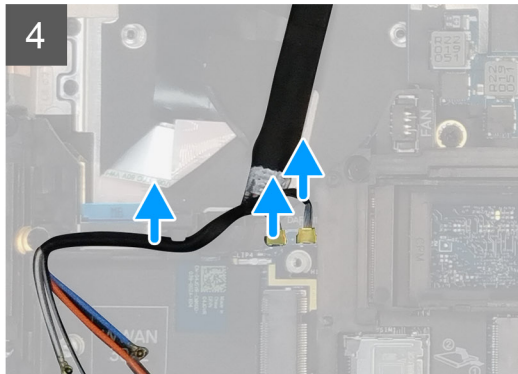
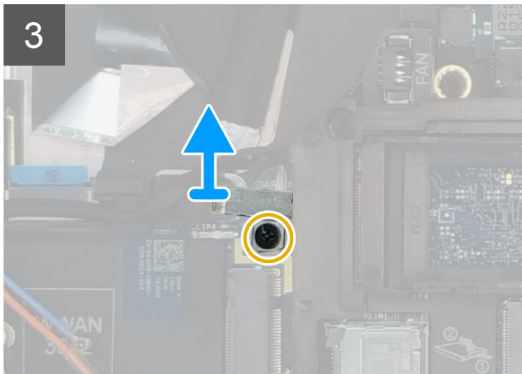
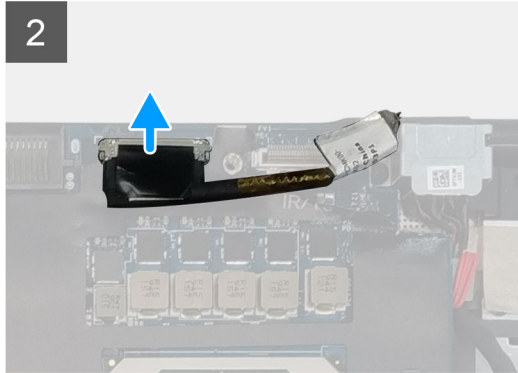
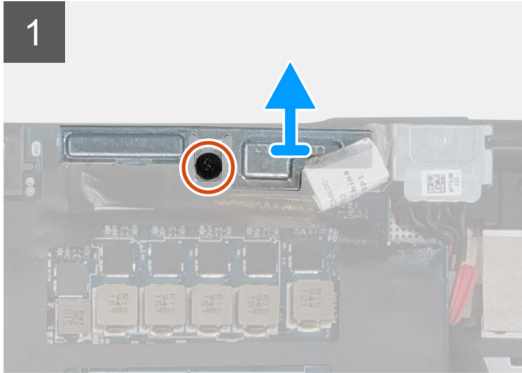
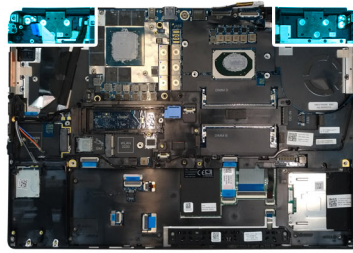



8x
M2.5x2.5

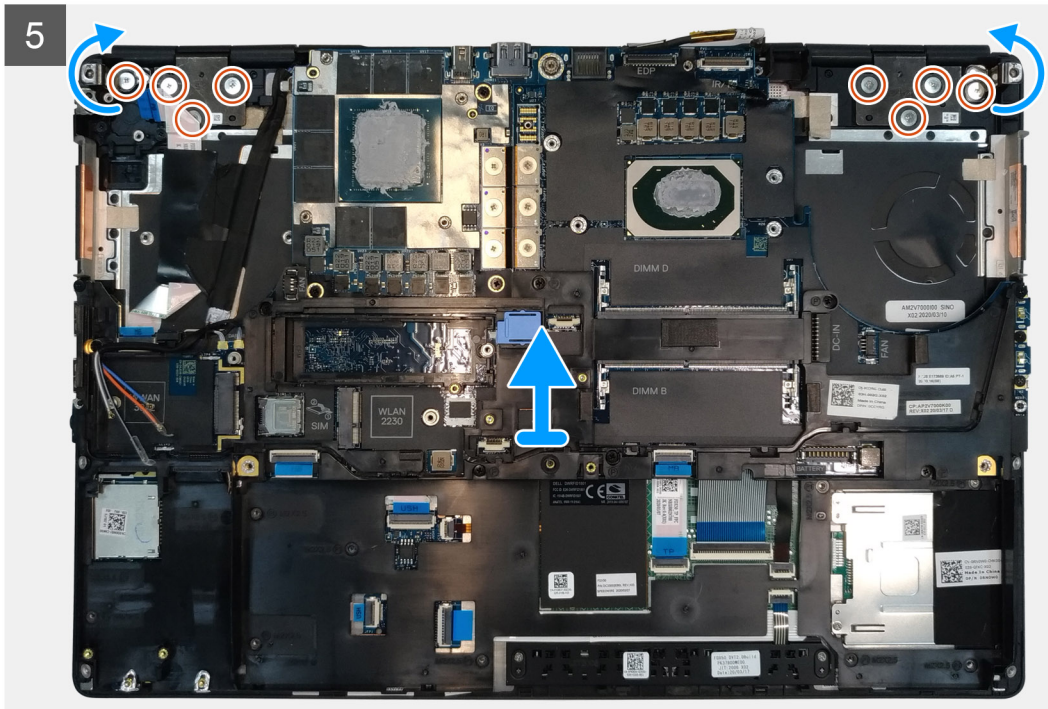

Steps

1. Open the display assembly to a 140-degree angle and place the computer at the edge of a flat table so that the display assembly can extend below the table.
2. Remove the (M2x5) screw that secures the display bracket to the palmrest.
3. Disconnect the display cable from the connector on the system board.
4. Remove the (M2x5) screw that secures the Darwin bracket.
5. Peel and remove the WWAN cables and Darwin cables from the palmrest.
6. Remove the eight (M2.5x2.5) screws that secures the hinges to the palmrest.
7. Remove the display assembly from the palmrest.

Installing the display assembly

Prerequisites

If you are replacing a component, remove the existing component before performing the installation procedure.

About this task

The figure indicates the location of the display assembly and provides a visual representation of the installation procedure.

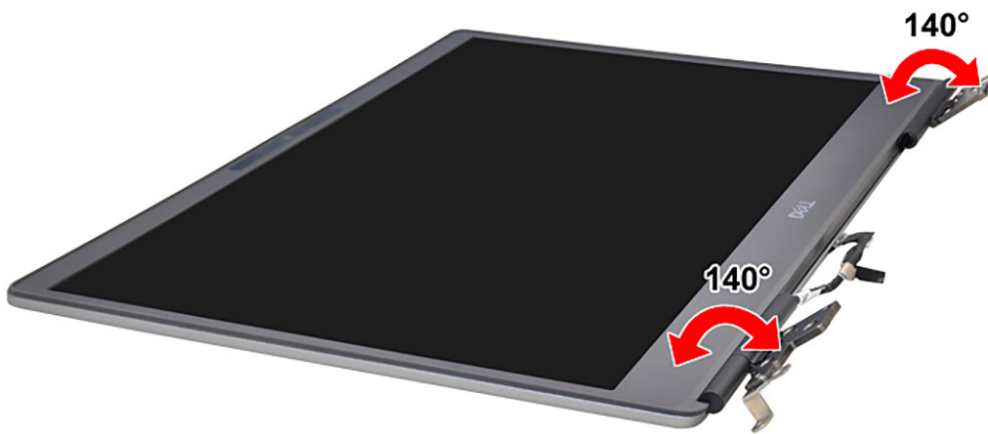

8x
M2.5x2.5

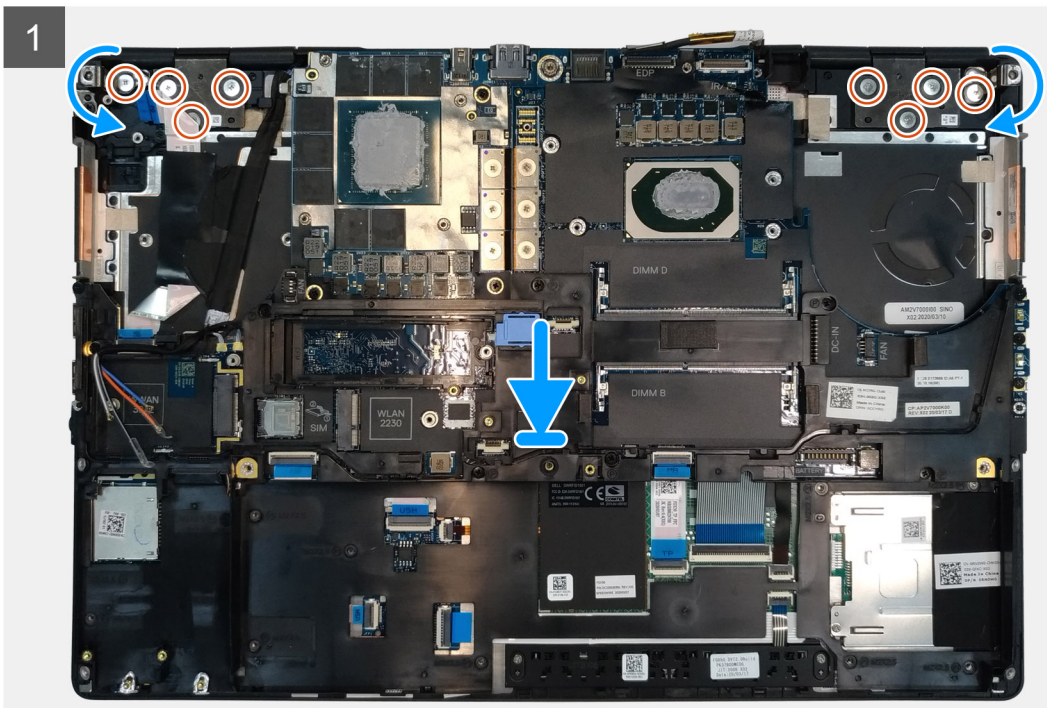
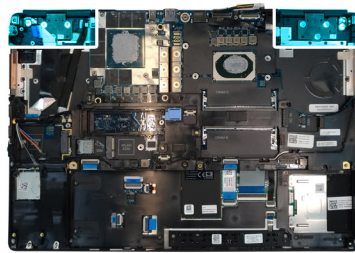





1x
M2x5

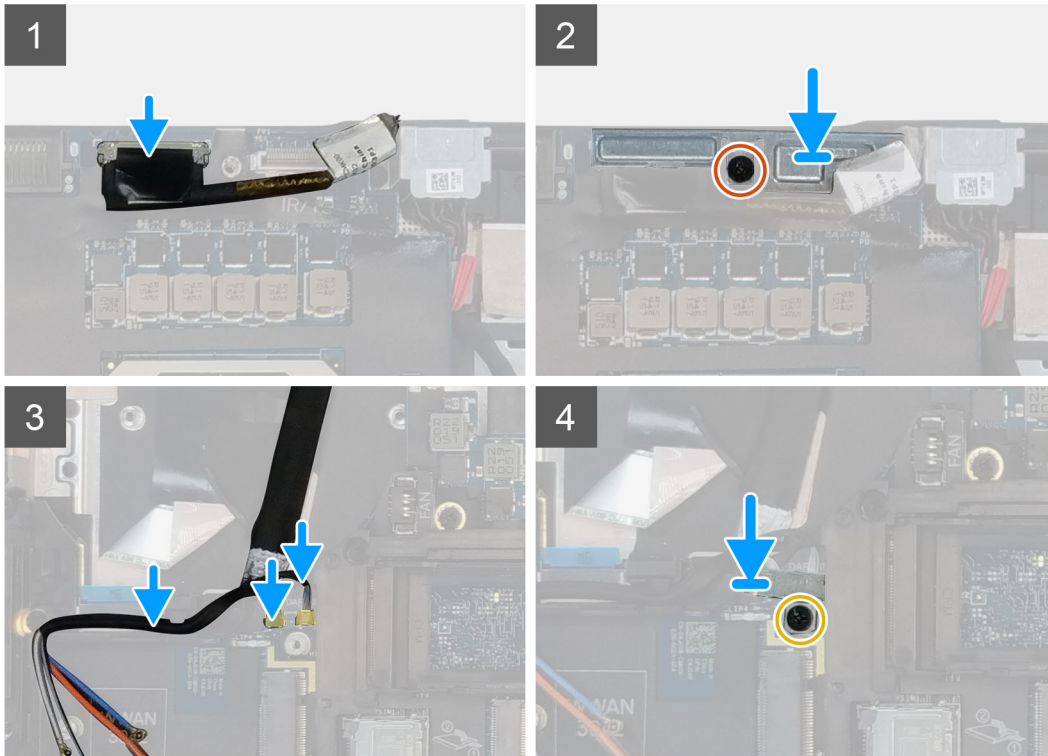

1x
M2x3



Steps

1.  **NOTE:** Before installing the display assembly, ensure that the display hinges are opened to a 140-degree angle against the display assembly, to fit the display assembly to the palmrest.

Align the screw holes on the hinges on the display assembly to the screw holes on the palmrest.

2. Replace the eight (M2.5x2.5) screws to secure the hinges to the palmrest.
3. Replace the (M2x5) screw to secure the display bracket to the palmrest.
4. Connect the display cable to the connector on the system board.
5. Replace the (M2x5) screw to secure the Darwin bracket.
6. Adhere the WWAN cables and Darwin cables to the palmrest.

Next steps

1. Install the [heat-sink assembly](#).
2. Install the [primary memory](#).
3. Install the [keyboard](#).
4. Install the [keyboard lattice](#).
5. Install the [WLAN card](#).
6. Install the [WWAN card](#).
7. Install the [secondary memory](#).
8. Install the [SIM card](#).
9. Install the [primary M.2 SSD](#).
10. Install the [battery](#).
11. Install the [base cover](#).
12. Install the [secondary M.2 SSD](#).

13. Install the [SSD door](#).
14. Install the [SD card](#).
15. Follow the procedure in [after working inside your computer](#).

Palm rest

Removing the palmrest

Prerequisites

1. Follow the procedure in [before working inside your computer](#).
2. Remove the [SD card](#).
3. Remove the [SSD door](#).
4. Remove the [secondary M.2 SSD](#).
5. Remove the [base cover](#).
6. Remove the [battery](#).
7. Remove the [primary M.2 SSD](#).
8. Remove the [SIM card](#).
9. Remove the [secondary memory](#).
10. Remove the [WWAN card](#).
11. Remove the [WLAN card](#).
12. Remove the [keyboard lattice](#).
13. Remove the [keyboard](#).
14. Remove the [primary memory](#).
15. Remove the [power adapter port](#).
16. Remove the [power button board](#).
17. Remove the [smart card reader](#).
18. Remove the [touchpad buttons](#).
19. Remove the [SD card reader](#).
20. Remove the [power button](#), or [power button assembly with fingerprint reader](#)
21. Remove the [heat-sink assembly](#).
22. Remove the [inner frame](#).
23. Remove the [GPU power cable](#).
24. Remove the [GPU card](#).
25. Remove the [system board](#).
26. Remove the [speaker](#).
27. Remove the [middle cap](#).
28. Remove the [display assembly](#).

About this task

The picture below shows the palmrest after performing the pre-removal parts procedures for any palm rest replacement

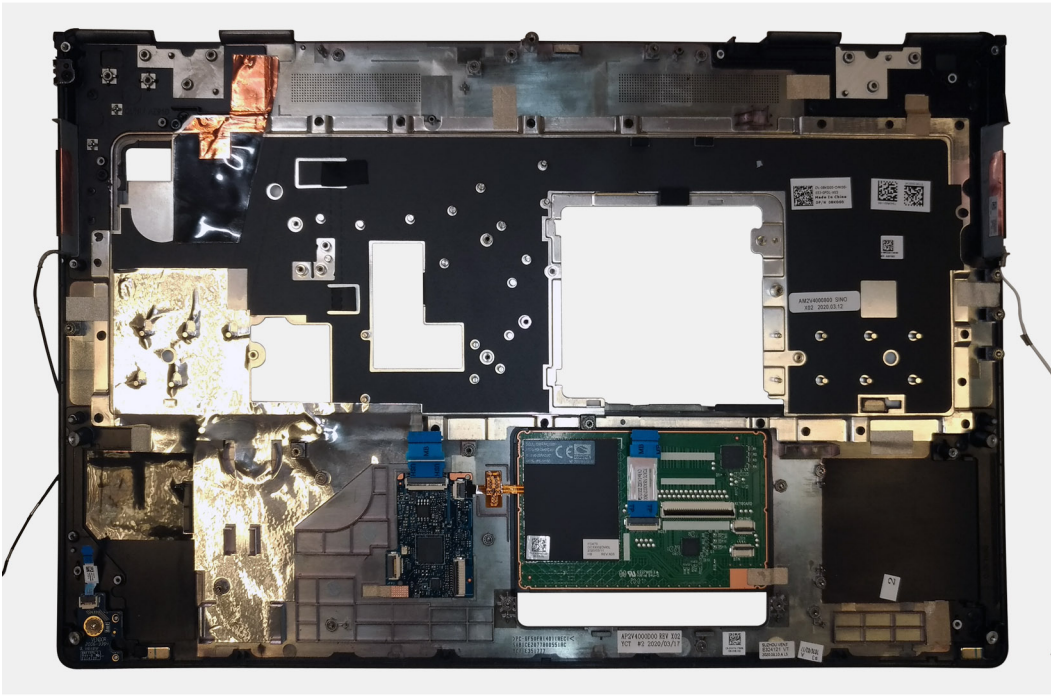

Installing the palmrest

Prerequisites

If you are replacing a component, remove the existing component before performing the installation procedure.

About this task

The figure indicates the palmrest and before performing the pre-installation parts procedures for any palmrest installation procedure.

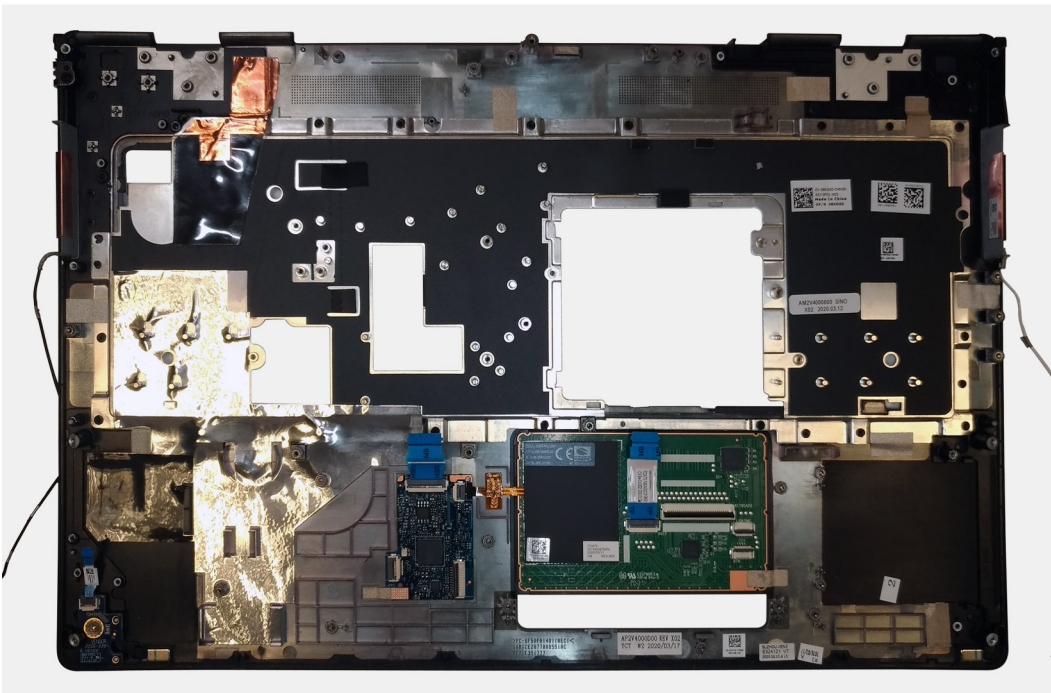

Next steps

1. Install the [display assembly](#).

2. Install the [middle cap](#).
3. Install the [speaker](#).
4. Install the [system board](#).
5. Install the [GPU card](#).
6. Install the [GPU power cable](#).
7. Install the [inner frame](#).
8. Install the [heat-sink assembly](#).
9. Install the [power button](#) or [power button assembly with fingerprint reader](#).
10. Install the [SD card reader](#).
11. Install the [smart card reader](#).
12. Install the [touchpad buttons](#).
13. Install the [power button board](#).
14. Install the [power adapter port](#).
15. Install the [primary memory](#).
16. Install the [keyboard](#).
17. Install the [keyboard lattice](#).
18. Install the [WLAN card](#).
19. Install the [WWAN card](#).
20. Install the [secondary memory](#).
21. Install the [SIM card](#).
22. Install the [primary M.2 SSD](#).
23. Install the [battery](#).
24. Install the [base cover](#).
25. Install the [secondary M.2 SSD](#).
26. Install the [SSD door](#).
27. Install the [SD card](#).
28. Follow the procedure in [after working inside your computer](#).

Display bezel

Removing the display bezel (non-touch)

Prerequisites

1. Follow the procedure in [before working inside your computer](#).
2. Remove the [SD card](#).
3. Remove the [SSD door](#).
4. Remove the [secondary M.2 SSD](#).
5. Remove the [base cover](#).
6. Remove the [battery](#).
7. Remove the [primary M.2 SSD](#).
8. Remove the [SIM card](#).
9. Remove the [secondary memory](#).
10. Remove the [WWAN card](#).
11. Remove the [WLAN card](#).
12. Remove the [keyboard lattice](#).
13. Remove the [keyboard](#).
14. Remove the [primary memory](#).
15. Remove the [heat-sink assembly](#).
16. Remove the [inner frame](#).
17. Remove the [GPU power cable](#).
18. Remove the [GPU card](#).
19. Remove the [system board](#).
20. Remove the [speaker](#).
21. Remove the [middle cap](#).

22. Remove the [display assembly](#).

About this task

The figure indicates the location of the display bezel and provides a visual representation of the removal procedure. Images to be uploaded in the next review cycle.

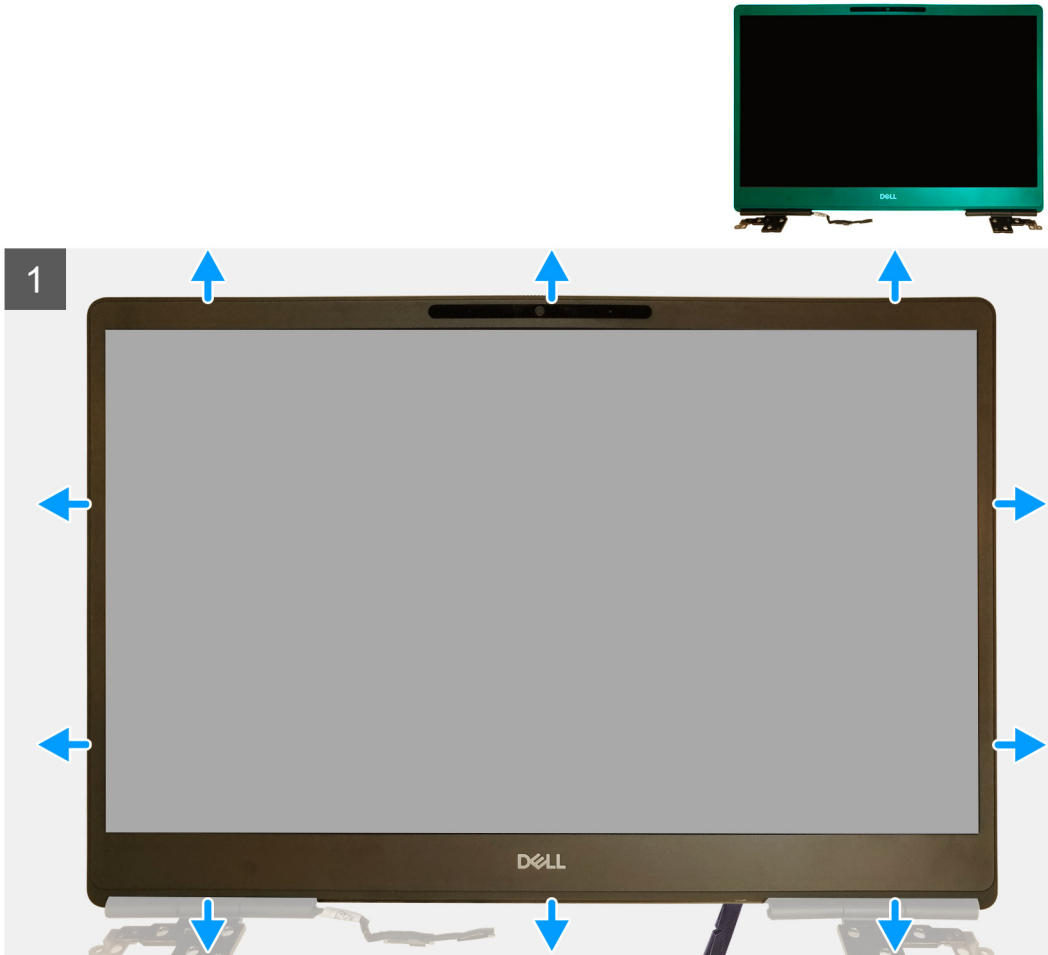

Steps

1. Using a flat head tool or a plastic scribe, pry open the display bezel from the two recess points on the bottom edge of the display bezel.
2. Working your way from the bottom edge, pry around the sides and top edge of the display bezel.
NOTE: While prying the display bezel, make sure to pry along the outside edge of the display bezel using your hands—using a screw driver or other sharp objects may damage the display cover.
3. Remove the display bezel from the display assembly.

Installing the display bezel (non-touch)

Prerequisites

If you are replacing a component, remove the existing component before performing the installation procedure.

About this task

The figure indicates the display bezel and provides a visual representation of the installation procedure.

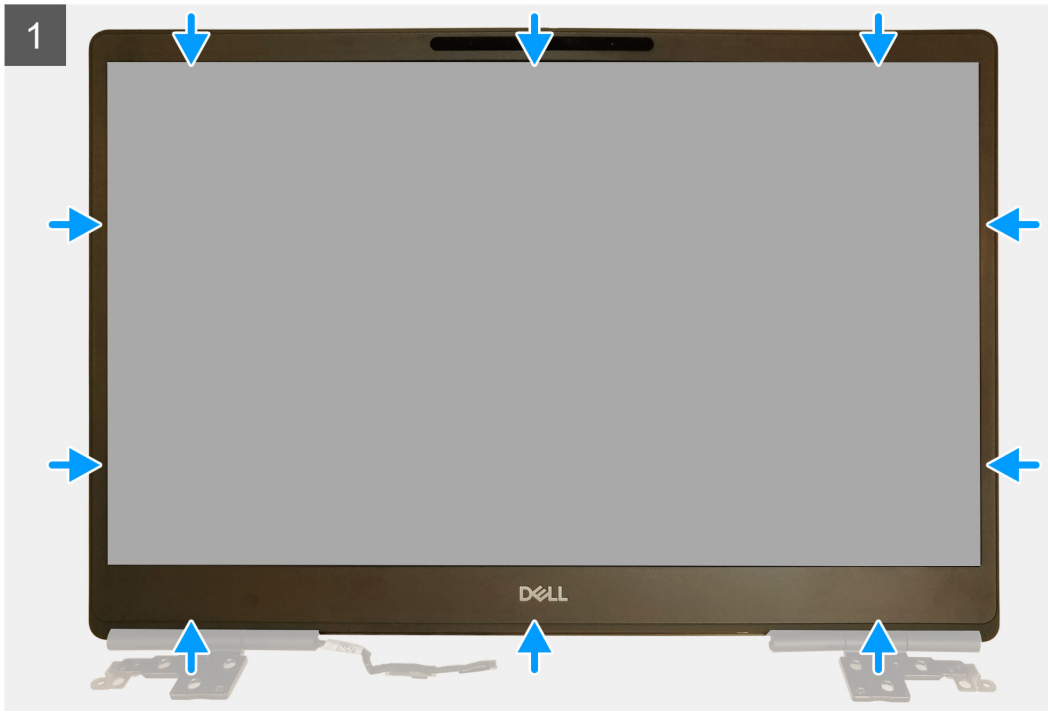

Steps

1. Place the display bezel on the display assembly.
2. Press the edges of the display bezel until it clicks onto the display assembly.

Next steps

1. Install the [display assembly](#).
2. Install the [middle cap](#).
3. Install the [speaker](#).
4. Install the [system board](#).
5. Install the [GPU card](#).
6. Install the [GPU power cable](#).
7. Install the [inner frame](#).
8. Install the [heat-sink assembly](#).
9. Install the [primary memory](#).
10. Install the [keyboard](#).
11. Install the [keyboard lattice](#).
12. Install the [WLAN card](#).
13. Install the [WWAN card](#).
14. Install the [secondary memory](#).
15. Install the [SIM card](#).
16. Install the [primary M.2 SSD](#).
17. Install the [battery](#).
18. Install the [base cover](#).
19. Install the [secondary M.2 SSD](#).
20. Install the [SSD door](#).

21. Install the [SD card](#).
22. Follow the procedure in [after working inside your computer](#).

Display panel

Removing the display panel (non-touch)

Prerequisites

1. Follow the procedure in [before working inside your computer](#).
2. Remove the [SD card](#).
3. Remove the [SSD door](#).
4. Remove the [secondary M.2 SSD](#).
5. Remove the [base cover](#).
6. Remove the [battery](#).
7. Remove the [primary M.2 SSD](#).
8. Remove the [SIM card](#).
9. Remove the [secondary memory](#).
10. Remove the [WWAN card](#).
11. Remove the [WLAN card](#).
12. Remove the [keyboard lattice](#).
13. Remove the [keyboard](#).
14. Remove the [primary memory](#).
15. Remove the [heat-sink assembly](#).
16. Remove the [inner frame](#).
17. Remove the [GPU power cable](#).
18. Remove the [GPU card](#).
19. Remove the [system board](#).
20. Remove the [display assembly](#).
21. Remove the [speaker](#).
22. Remove the [middle cap](#).
23. Remove the [display assembly](#).
24. Remove the [display bezel](#).

About this task

The figure indicates the location of the display panel and provides a visual representation of the removal procedure. Images to be uploaded in the next review cycle.

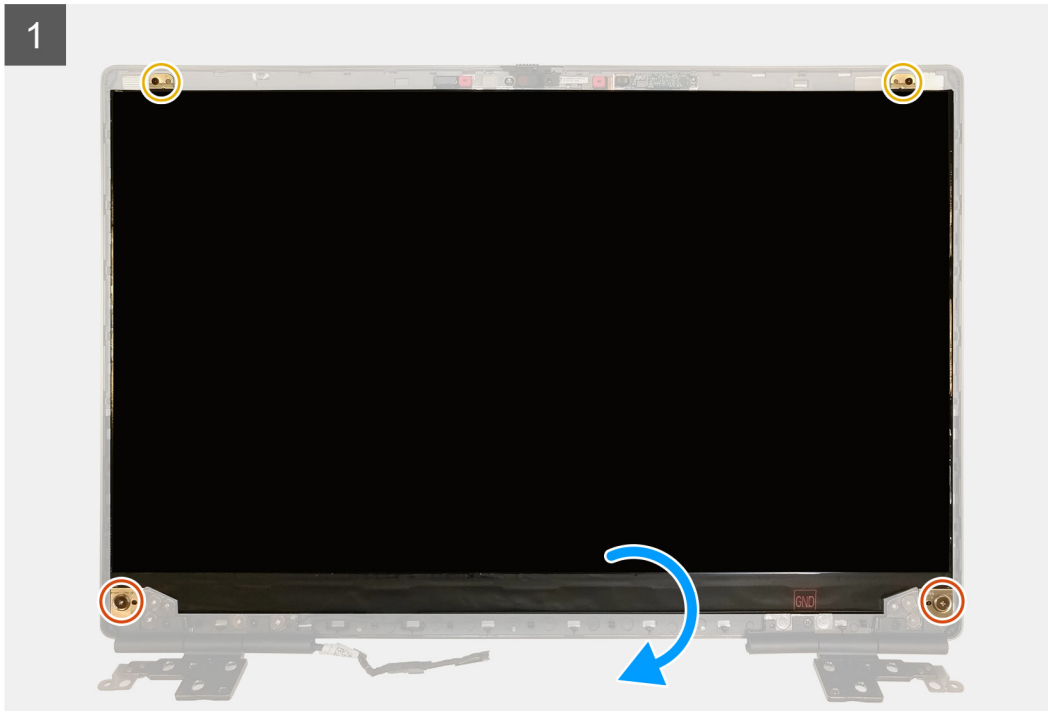
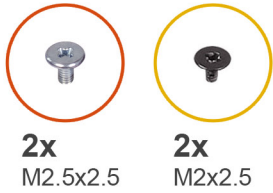

Steps

1. Remove the two (M2.5x2.5) screws and the two (M2x2.5) screws that secures the display panel to the display assembly.
2. Lift the display panel and turn the display panel over to access the display cable
3. Peel the conductive tape covering the display cable.
4. Peel the adhesive tapes that secures the display cable.
5. Peel the adhesive rubber strip covering the display cable.
6. Unlock the display cable connector and then disconnect the display cable from the back of the display panel.
7. Remove the display panel form the display assembly.
8. Remove the display panel.

i NOTE: The support brackets attached to the display panel are defined as a single service assembly part and cannot be further disassembled.

Installing the display panel (non-touch)

Prerequisites

If you are replacing a component, remove the existing component before performing the installation procedure.

About this task

The figure indicates the display panel and provides a visual representation of the installation procedure.

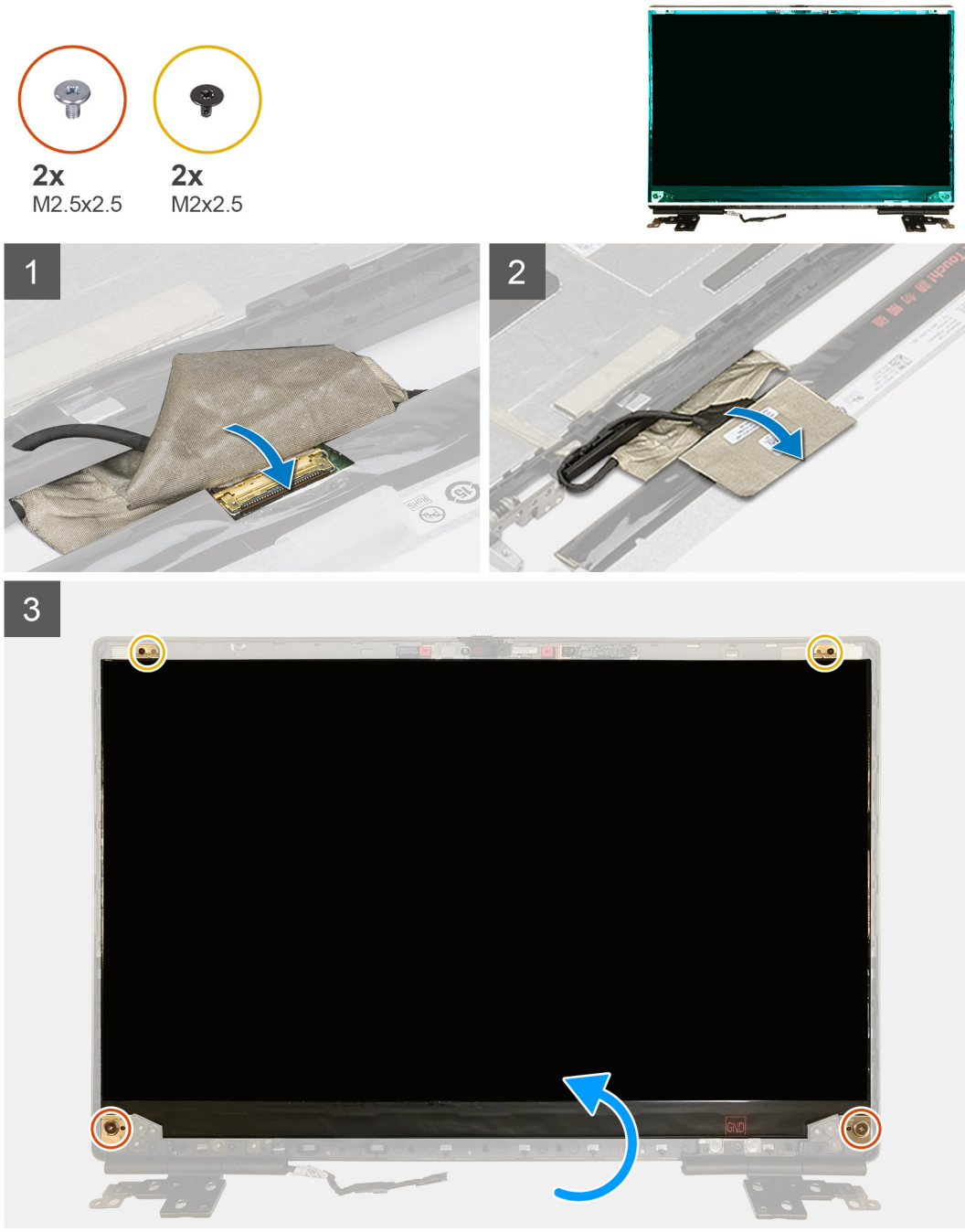

Steps

1. Connect the display cable to the connector on the back of the display panel and lock the display cable connector.
2. Adhere the adhesive rubber strip to cover the display cable.
3. Adhere the transparent tape and conductive tape above the rubber strip to cover the display cable.
4. Align the display panel with the tabs on the display assembly.

5. Replace the two (M2.5X2.5) and two (M2x2.5) screws to secure the display panel to the display assembly.

Next steps

1. Install the [display bezel](#).
2. Install the [display assembly](#).
3. Install the [middle cap](#).
4. Install the [speaker](#).
5. Install the [display assembly](#).
6. Install the [system board](#).
7. Install the [GPU card](#).
8. Install the [GPU power cable](#).
9. Install the [inner frame](#).
10. Install the [heat-sink assembly](#).
11. Install the [primary memory](#).
12. Install the [keyboard](#).
13. Install the [keyboard lattice](#).
14. Install the [WLAN card](#).
15. Install the [WWAN card](#).
16. Install the [secondary memory](#).
17. Install the [SIM card](#).
18. Install the [primary M.2 SSD](#).
19. Install the [battery](#).
20. Install the [base cover](#).
21. Install the [secondary M.2 SSD](#).
22. Install the [SSD door](#).
23. Install the [SD card](#).
24. Follow the procedure in [after working inside your computer](#).

Display hinges

Removing the display hinge

Prerequisites

1. Follow the procedure in [before working inside your computer](#).
2. Remove the [SD card](#).
3. Remove the [SSD door](#).
4. Remove the [secondary M.2 SSD](#).
5. Remove the [base cover](#).
6. Remove the [battery](#).
7. Remove the [primary M.2 SSD](#).
8. Remove the [SIM card](#).
9. Remove the [secondary memory](#).
10. Remove the [WWAN card](#).
11. Remove the [WLAN card](#).
12. Remove the [keyboard lattice](#).
13. Remove the [keyboard](#).
14. Remove the [primary memory](#).
15. Remove the [heat-sink assembly](#).
16. Remove the [inner frame](#).
17. Remove the [GPU power cable](#).
18. Remove the [GPU card](#).
19. Remove the [system board](#).
20. Remove the [display assembly](#).
21. Remove the [speaker](#).

- 22. Remove the [display bezel](#).
- 23. Remove the [display panel](#).

About this task

The figure indicates the location of the display hinge and provides a visual representation of the removal procedure. Images to be uploaded in the next review cycle.



8x
M2.5x2.5

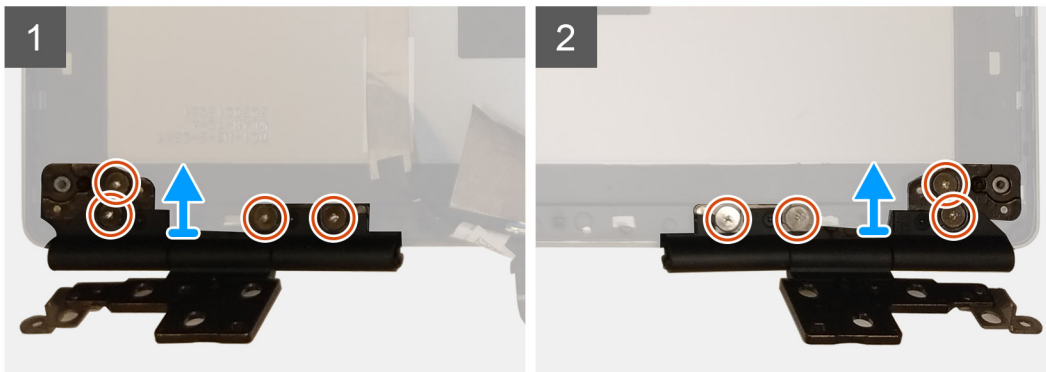

Steps

- 1. Remove the eight (M2.5x2.5) screws that secures the display hinges to the display assembly.
- 2. Remove the display hinges.

Installing the display hinge (non-touch)

Prerequisites

If you are replacing a component, remove the existing component before performing the installation procedure.

About this task

The figure indicates the display hinge and provides a visual representation of the installation procedure.



8x
M2.5x2.5

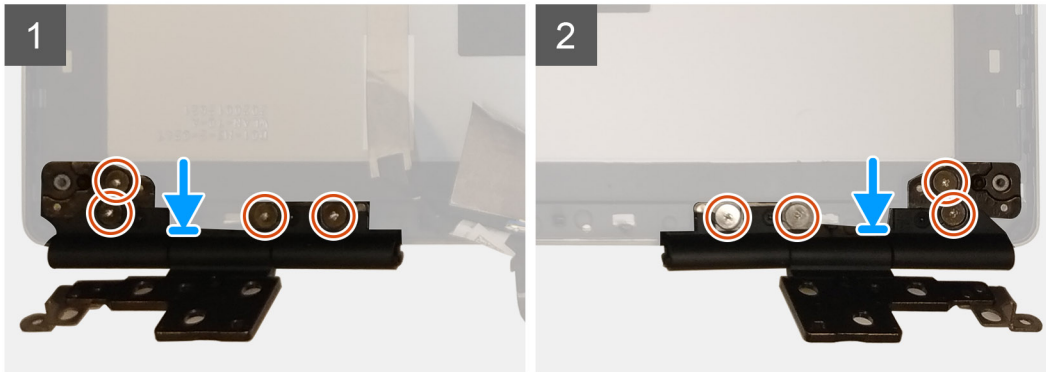

Steps

1. Place the display hinge in its slot on the display assembly.
2. Replace the eight (M2.5x2.5) screws to secure the display hinge to the display assembly.

Next steps

1. Install the [display panel](#).
2. Install the [display bezel](#).
3. Install the [speaker](#).
4. Install the [display assembly](#).
5. Install the [system board](#).
6. Install the [GPU card](#).
7. Install the [GPU power cable](#).
8. Install the [inner frame](#).
9. Install the [heat-sink assembly](#).
10. Install the [primary memory](#).
11. Install the [keyboard](#).
12. Install the [keyboard lattice](#).
13. Install the [WLAN card](#).
14. Install the [WWAN card](#).
15. Install the [secondary memory](#).
16. Install the [SIM card](#).
17. Install the [primary M.2 SSD](#).
18. Install the [battery](#).
19. Install the [base cover](#).
20. Install the [secondary M.2 SSD](#).
21. Install the [SSD door](#).
22. Install the [SD card](#).
23. Follow the procedure in [after working inside your computer](#).

Camera

Removing the camera (non-touch)

Prerequisites

1. Follow the procedure in [before working inside your computer](#).
2. Remove the [SD card](#).
3. Remove the [SSD door](#).
4. Remove the [secondary M.2 SSD](#).
5. Remove the [base cover](#).
6. Remove the [battery](#).
7. Remove the [primary M.2 SSD](#).
8. Remove the [SIM card](#).
9. Remove the [secondary memory](#).
10. Remove the [WWAN card](#).
11. Remove the [WLAN card](#).
12. Remove the [keyboard lattice](#).
13. Remove the [keyboard](#).
14. Remove the [primary memory](#).
15. Remove the [heat-sink assembly](#).
16. Remove the [inner frame](#).
17. Remove the [GPU power cable](#).
18. Remove the [GPU card](#).
19. Remove the [system board](#).
20. Remove the [display assembly](#).
21. Remove the [speaker](#).
22. Remove the [display bezel](#).
23. Remove the [display panel](#).

About this task

The figure indicates the location of the camera and provides a visual representation of the removal procedure. Images to be uploaded in the next review cycle.

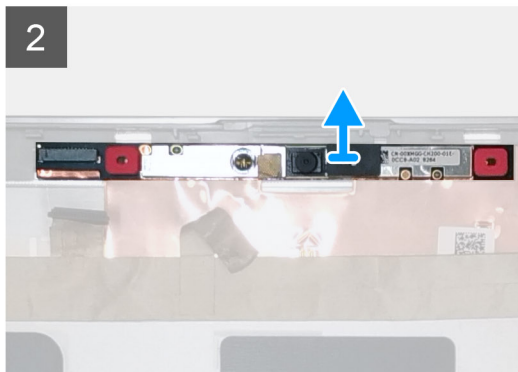
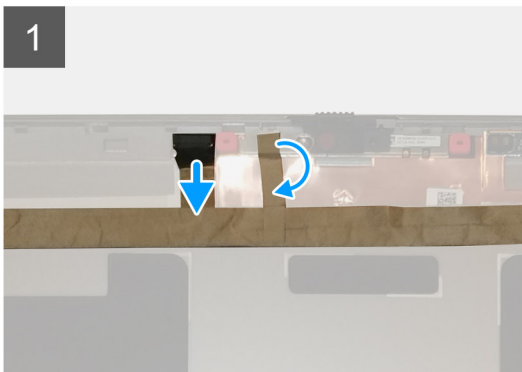

Steps

1. Peel the adhesive tape that covers the camera module.
2. Disconnect the display cable from the camera module.
3. Gently pry the camera shutter cap from the top edge of the camera shutter and remove it from the display back cover.
4. Gently pry the camera module from the display back cover.

Installing the camera

Prerequisites

If you are replacing a component, remove the existing component before performing the installation procedure.

About this task

The figure indicates the camera and provides a visual representation of the installation procedure.



Steps

1. Place the camera module in its slot on the display back cover.
2. Place the camera shutter cap on the top edge of the camera shutter.
3. Connect the display cable to the camera module.
4. Adhere the adhesive tape to cover the camera module.

Next steps

1. Install the [display panel](#).
2. Install the [display bezel](#).
3. Install the [speaker](#).
4. Install the [display assembly](#).
5. Install the [system board](#).
6. Install the [GPU card](#).
7. Install the [GPU power cable](#).
8. Install the [inner frame](#).
9. Install the [heat-sink assembly](#).
10. Install the [primary memory](#).
11. Install the [keyboard](#).
12. Install the [keyboard lattice](#).

13. Install the [WLAN card](#).
14. Install the [WWAN card](#).
15. Install the [secondary memory](#).
16. Install the [SIM card](#).
17. Install the [primary M.2 SSD](#).
18. Install the [battery](#).
19. Install the [base cover](#).
20. Install the [secondary M.2 SSD](#).
21. Install the [SSD door](#).
22. Install the [SD card](#).
23. Follow the procedure in [after working inside your computer](#).

P-sensor board

Removing the P-sensor board

Prerequisites

1. Follow the procedure in [before working inside your computer](#).
2. Remove the [SD card](#).
3. Remove the [SSD door](#).
4. Remove the [secondary M.2 SSD](#).
5. Remove the [base cover](#).
6. Remove the [battery](#).
7. Remove the [primary M.2 SSD](#).
8. Remove the [SIM card](#).
9. Remove the [secondary memory](#).
10. Remove the [WWAN card](#).
11. Remove the [WLAN card](#).
12. Remove the [keyboard lattice](#).
13. Remove the [keyboard](#).
14. Remove the [primary memory](#).
15. Remove the [heat-sink assembly](#).
16. Remove the [inner frame](#).
17. Remove the [GPU power cable](#).
18. Remove the [GPU card](#).
19. Remove the [system board](#).
20. Remove the [display assembly](#).
21. Remove the [speaker](#).
22. Remove the [display bezel](#).
23. Remove the [display panel](#).

About this task

The figure indicates the location of the P-sensor board and provides a visual representation of the removal procedure. Images to be uploaded in the next review cycle.

Images will be provide in the next review cycle

Steps

1. Gently pry the P-sensor board from its slot on the display back cover.
2. Flip over the P-sensor board.
3. Disconnect the display cable from the P-sensor board.
4. Remove the P-sensor board.

Installing the P-sensor board

Prerequisites

If you are replacing a component, remove the existing component before performing the installation procedure.

About this task

The figure indicates the P-sensor board and provides a visual representation of the installation procedure.

Images to be uploaded in the next review cycle

Steps

1. Connect the display cable to the P-sensor board.
2. Flip the P-sensor board and place it gently in its slot on the display back cover

Next steps

1. Install the [display panel](#).
2. Install the [display bezel](#).
3. Install the [speaker](#).
4. Install the [display assembly](#).
5. Install the [system board](#).
6. Install the [GPU card](#).
7. Install the [GPU power cable](#).
8. Install the [inner frame](#).
9. Install the [heat-sink assembly](#).
10. Install the [primary memory](#).
11. Install the [keyboard](#).
12. Install the [keyboard lattice](#).
13. Install the [WLAN card](#).
14. Install the [WWAN card](#).
15. Install the [secondary memory](#).
16. Install the [SIM card](#).
17. Install the [primary M.2 SSD](#).
18. Install the [battery](#).
19. Install the [base cover](#).
20. Install the [secondary M.2 SSD](#).
21. Install the [SSD door](#).
22. Install the [SD card](#).
23. Follow the procedure in [after working inside your computer](#).

Display cable

Removing the display cable

Prerequisites

1. Follow the procedure in [before working inside your computer](#).
2. Remove the [SD card](#).
3. Remove the [SSD door](#).
4. Remove the [secondary M.2 SSD](#).
5. Remove the [base cover](#).
6. Remove the [battery](#).
7. Remove the [primary M.2 SSD](#).
8. Remove the [SIM card](#).

9. Remove the secondary memory.
10. Remove the WWAN card.
11. Remove the WLAN card.
12. Remove the keyboard lattice.
13. Remove the keyboard.
14. Remove the primary memory.
15. Remove the heat-sink assembly.
16. Remove the inner frame.
17. Remove the GPU power cable.
18. Remove the GPU card.
19. Remove the system board.
20. Remove the display assembly.
21. Remove the speaker.
22. Remove the display bezel.
23. Remove the display panel.
24. Remove the P-sensor board.

About this task

The figure indicates the location of the display cable and provides a visual representation of the removal procedure. Images to be uploaded in the next review cycle.

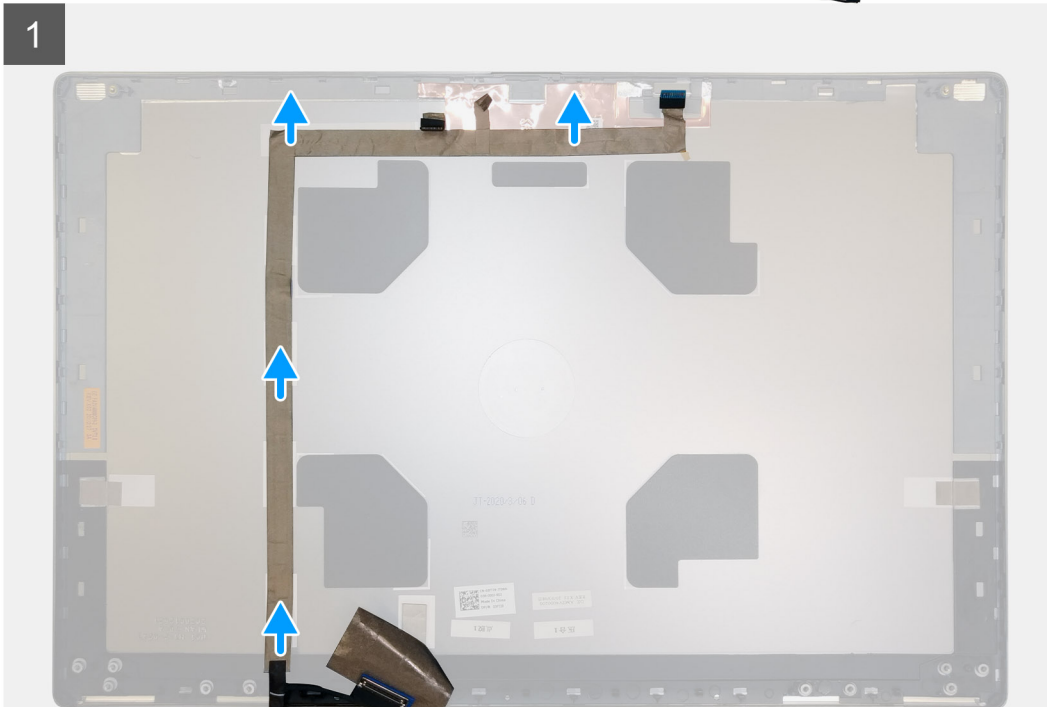

Steps

1. Peel the adhesive tape covering the camera module.
2. Disconnect the display cable from the camera module.
3. Peel the display cable from the display cover and unroute the cable from the routing channels

4. Remove the display cable from the display back cover.

Installing the display cable

Prerequisites

If you are replacing a component, remove the existing component before performing the installation procedure.

About this task

The figure indicates the display cable and provides a visual representation of the installation procedure.

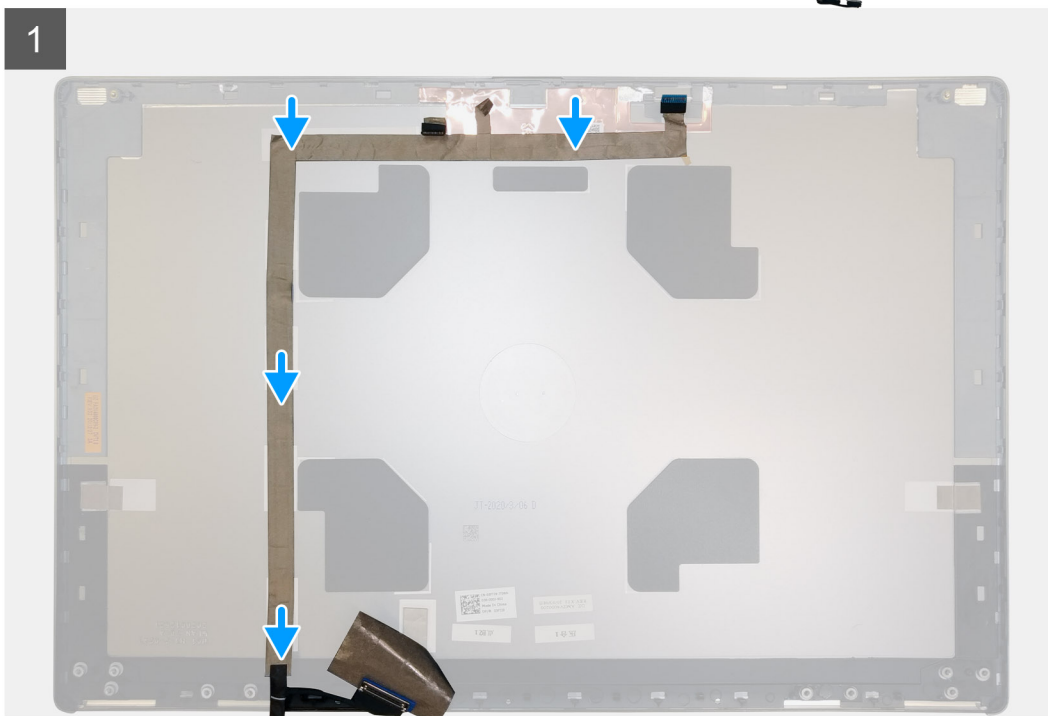
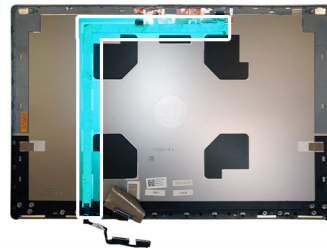

Steps

1. Route and adhere the display cable on the display back cover.
2. Connect the display cable to the connector on the camera module.
3. Adhere the adhesive tape to cover the camera module.

Next steps

1. Install the [P-sensor board](#).
2. Install the [display panel](#).
3. Install the [display bezel](#).
4. Install the [speaker](#).
5. Install the [display assembly](#).
6. Install the [system board](#).
7. Install the [GPU card](#).

8. Install the [GPU power cable](#).
9. Install the [inner frame](#).
10. Install the [heat-sink assembly](#).
11. Install the [primary memory](#).
12. Install the [keyboard](#).
13. Install the [keyboard lattice](#).
14. Install the [WLAN card](#).
15. Install the [WWAN card](#).
16. Install the [secondary memory](#).
17. Install the [SIM card](#).
18. Install the [primary M.2 SSD](#).
19. Install the [battery](#).
20. Install the [base cover](#).
21. Install the [secondary M.2 SSD](#).
22. Install the [SSD door](#).
23. Install the [SD card](#).
24. Follow the procedure in [after working inside your computer](#).

Display back cover

Replacing the display cable

Prerequisites

1. Follow the procedure in [before working inside your computer](#).
2. Remove the [SD card](#).
3. Remove the [SSD door](#).
4. Remove the [secondary M.2 SSD](#).
5. Remove the [base cover](#).
6. Remove the [battery](#).
7. Remove the [primary M.2 SSD](#).
8. Remove the [SIM card](#).
9. Remove the [secondary memory](#).
10. Remove the [WWAN card](#).
11. Remove the [WLAN card](#).
12. Remove the [keyboard lattice](#).
13. Remove the [keyboard](#).
14. Remove the [primary memory](#).
15. Remove the [heat-sink assembly](#).
16. Remove the [inner frame](#).
17. Remove the [GPU power cable](#).
18. Remove the [GPU card](#).
19. Remove the [system board](#).
20. Remove the [display assembly](#).
21. Remove the [speaker](#).
22. Remove the [display bezel](#).
23. Remove the [display panel](#).
24. Remove the [P-sensor board](#).
25. Remove the [display hinges](#).
26. Remove the [camera](#).
27. Remove the [display cable](#).

About this task

The picture below shows the display back cover after performing the pre-removal parts procedures for any display back cover replacement

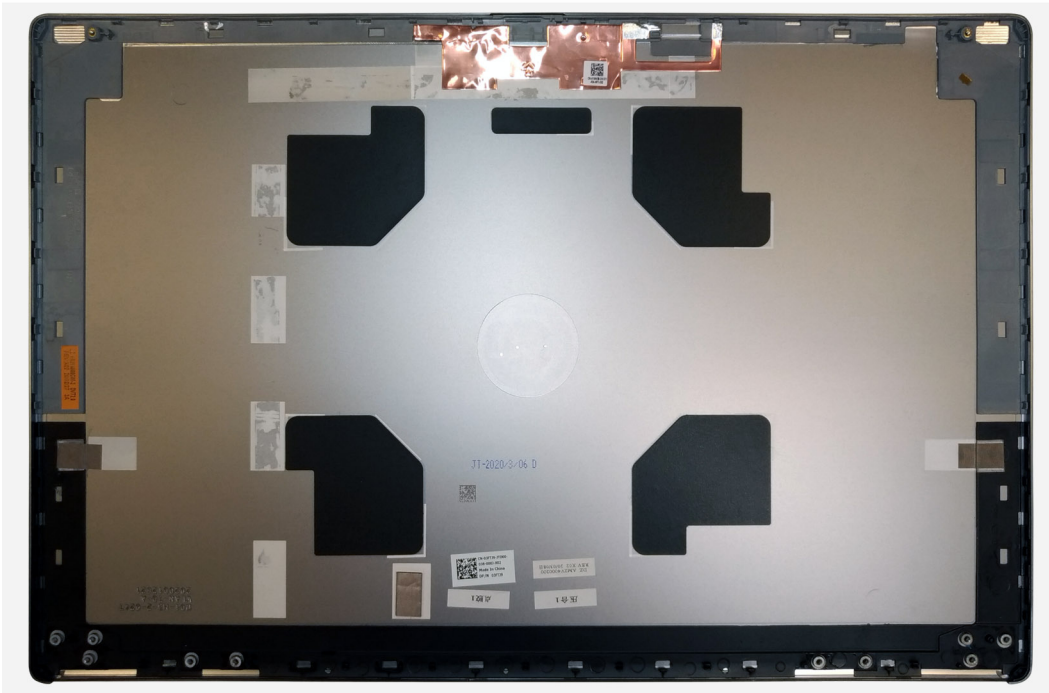

For installing the components, place the display back cover on a flat surface.

1. Install the [display cable](#).
2. Install the [camera](#).
3. Install the [display hinges](#).
4. Install the [P-sensor board](#).
5. Install the [display panel](#).
6. Install the [display bezel](#).
7. Install the [speaker](#).
8. Install the [display assembly](#).
9. Install the [system board](#).
10. Install the [GPU card](#).
11. Install the [GPU power cable](#).
12. Install the [inner frame](#).
13. Install the [heat-sink assembly](#).
14. Install the [primary memory](#).
15. Install the [keyboard](#).
16. Install the [keyboard lattice](#).
17. Install the [WLAN card](#).
18. Install the [WWAN card](#).
19. Install the [secondary memory](#).
20. Install the [SIM card](#).
21. Install the [primary M.2 SSD](#).
22. Install the [battery](#).
23. Install the [base cover](#).
24. Install the [secondary M.2 SSD](#).
25. Install the [SSD door](#).
26. Install the [SD card](#).
27. Follow the procedure in [after working inside your computer](#).

Troubleshooting

Dell SupportAssist Pre-boot System Performance Check diagnostics

About this task

The SupportAssist diagnostics (also known as system diagnostics) performs a complete check of your hardware. The Dell SupportAssist Pre-boot System Performance Check diagnostics is embedded with the BIOS and is launched by the BIOS internally. The embedded system diagnostics provides a set of options for particular devices or device groups allowing you to:

- Run tests automatically or in an interactive mode
- Repeat tests
- Display or save test results
- Run thorough tests to introduce additional test options to provide extra information about the failed device(s)
- View status messages that inform you if tests are completed successfully
- View error messages that inform you of problems encountered during testing

NOTE: Some tests for specific devices require user interaction. Always ensure that you are present at the computer terminal when the diagnostic tests are performed.

For more information, see [Resolve Hardware Issues With Built-in and Online Diagnostics \(SupportAssist ePSA, ePSA or PSA Error Codes\)](#).

Running the SupportAssist Pre-Boot System Performance Check

Steps

1. Turn on your computer.
2. As the computer boots, press the F12 key as the Dell logo appears.
3. On the boot menu screen, select the **Diagnostics** option.
4. Click the arrow at the bottom left corner.
Diagnostics front page is displayed.
5. Click the arrow in the lower-right corner to go to the page listing.
The items detected are listed.
6. To run a diagnostic test on a specific device, press Esc and click **Yes** to stop the diagnostic test.
7. Select the device from the left pane and click **Run Tests**.
8. If there are any issues, error codes are displayed.
Note the error code and validation number and contact Dell.

System board built-in self-test (M-BIST)

About this task



Steps

1. Press and hold both the **M** key and the **power** button to initiate M-BIST.
2. The battery-status light illuminates in amber when there is a system board failure.
3. Replace the system board to fix the issue.

NOTE: The battery status LED does not illuminate if the system board is functioning properly.

Display panel power rail built-in self-test (L-BIST)

About this task

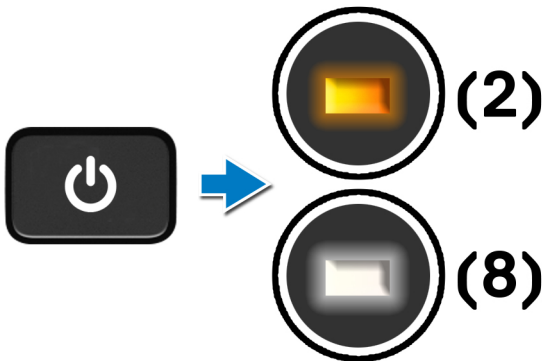

Next steps

L-BIST (LCD Power Rail Test) is an enhancement to the single LED error code diagnostics and is **automatically initiated** during **POST**. L-BIST isolates if the LCD is receiving power from the system board. L-BIST checks if the system board is supplying power to the LCD by performing an LCD Power Rail test. If there is no power going to the LCD, the battery status LED flashes a **[2,8] LED error code**.

Display panel built-in self-test (LCD-BIST)

About this task

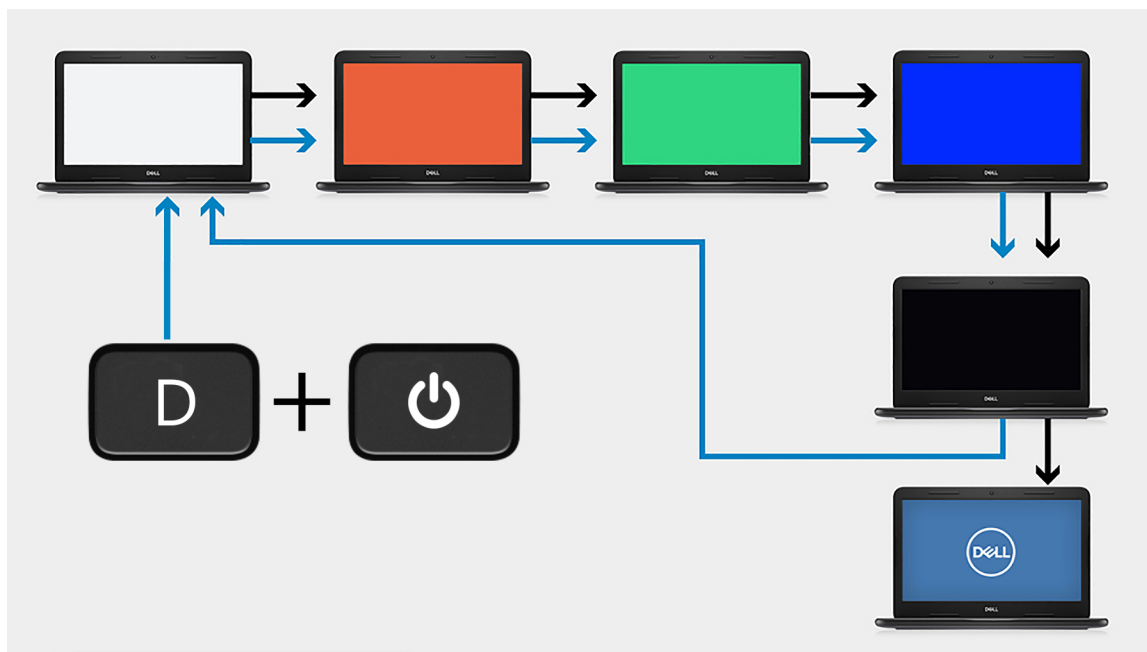

Steps

1. Press and hold the **D** key, and then press the **power** button.
2. Release both the **D** key and the **power** button when the computer begins POST.
3. The display panel begins to display a solid color, or cycling through different colors.

NOTE: The sequence of colors may vary depending on the different display panel vendors. The user only must ensure that the colors are being displayed correctly without distortion or graphical anomalies.

4. The computer reboots at the end of the last solid color.

System diagnostic lights

Battery-status light

Indicates the power and battery-charge status.

Solid white — Power adapter is connected and the battery has more than 5 percent charge.

Amber — Computer is running on battery and the battery has less than 5 percent charge.

Off

- Power adapter is connected, and the battery is fully charged.
- Computer is running on battery, and the battery has more than 5 percent charge.
- Computer is in sleep state, hibernation, or turned off.

The power and battery-status light blinks amber along with beep codes indicating failures.

For example, the power and battery-status light blinks amber two times followed by a pause, and then blinks white three times followed by a pause. This 2,3 pattern continues until the computer is turned off indicating no memory or RAM is detected.

The following table shows different power and battery-status light patterns and associated problems.

Table 6. LED codes

Diagnostic light codes	Problem description	Recommended Solution
1,1	TPM Detection Failure	Replace System Board

Table 6. LED codes(continued)

Diagnostic light codes	Problem description	Recommended Solution
1,2	Unrecoverable SPI Flash Failure	Replace System Board
1, 5	EC unable to program i-Fuse	Replace System Board
1, 6	Generic catch-all for ungraceful EC code flow errors	Disconnect all power source (AC, battery, coin cell) and drain flea power by pressing & holding down power button
2,1	CPU failure	Run the Intel CPU diagnostics tools. If problem persists, replace the system board
2,2	Motherboard covers BIOS corruption or ROM error	Flash latest BIOS version. If problem persists, replace the system board
2,3	No Memory/RAM detected	Confirm that the memory module is installed properly. If problem persists, replace the memory module
2,4	Memory/RAM Failure	Reset the memory module. If problem persists, replace the memory module
2,5	Invalid memory installed	Reset the memory module. If problem persists, replace the memory module
2,6	Motherboard/Chipset Error	Flash latest BIOS version. If problem persists, replace the system board
2,7	LCD failure - SBIOS message	Flash latest BIOS version. If problem persists, replace the LCD module
2,8	LCD failure - EC detection of power rail failure	Replace the system board
3,1	CMOS battery failure	Reset the CMOS battery connection. If problem persists, replace the RTC battery
3,2	PCI of Video card/chip failure	Replace the system board
3,3	BIOS Recovery Image not found	Flash latest BIOS version. If problem persists, replace the system board
3,4	Recovery Image found but invalid	Flash latest BIOS version. If problem persists, replace the system board
3,5	EC ran into power sequencing failure	Replace the system board
3,6	Flash corruption detected by SBIOS	Replace the system board
3,7	Timeout waiting on ME to reply to HECI message	Replace the system board

Camera status indicator: Indicates whether the camera is in use.

- Solid white — Camera is in use.
- Off — Camera is not in use.

Caps Lock status indicator: Indicates whether Caps Lock is enabled or disabled.

- Solid white — Caps Lock enabled.
- Off—Caps Lock disabled.

WiFi power cycle

About this task

If your computer is unable to access the internet due to WiFi connectivity issues a WiFi power cycle procedure may be performed. The following procedure provides the instructions on how to conduct a WiFi power cycle:

 **NOTE:** Some ISPs (Internet Service Providers) provide a modem/router combo device.

Steps

1. Turn off your computer.
2. Turn off the modem.
3. Turn off the wireless router.
4. Wait for 30 seconds.
5. Turn on the wireless router.
6. Turn on the modem.
7. Turn on your computer.

Getting help

Topics:

- [Contacting Dell](#)

Contacting Dell

Prerequisites

 **NOTE:** If you do not have an active Internet connection, you can find contact information on your purchase invoice, packing slip, bill, or Dell product catalog.

About this task

Dell provides several online and telephone-based support and service options. Availability varies by country and product, and some services may not be available in your area. To contact Dell for sales, technical support, or customer service issues:

Steps

1. Go to **Dell.com/support**.
2. Select your support category.
3. Verify your country or region in the **Choose a Country/Region** drop-down list at the bottom of the page.
4. Select the appropriate service or support link based on your need.