

B560M D3H

User's Manual

Rev. 1001



For more product details, please visit GIGABYTE's website.



To reduce the impacts on global warming, the packaging materials of this product are recyclable and reusable. GIGABYTE works with you to protect the environment.

Copyright

© 2021 GIGA-BYTE TECHNOLOGY CO., LTD. All rights reserved.

The trademarks mentioned in this manual are legally registered to their respective owners.

Disclaimer

Information in this manual is protected by copyright laws and is the property of GIGABYTE. Changes to the specifications and features in this manual may be made by GIGABYTE without prior notice. No part of this manual may be reproduced, copied, translated, transmitted, or published in any form or by any means without GIGABYTE's prior written permission.

- In order to assist in the use of this product, carefully read the User's Manual.
- For product-related information, check on our website at: <https://www.gigabyte.com>

Identifying Your Motherboard Revision

The revision number on your motherboard looks like this: "REV: X.X." For example, "REV: 1.0" means the revision of the motherboard is 1.0. Check your motherboard revision before updating motherboard BIOS, drivers, or when looking for technical information.

Example:

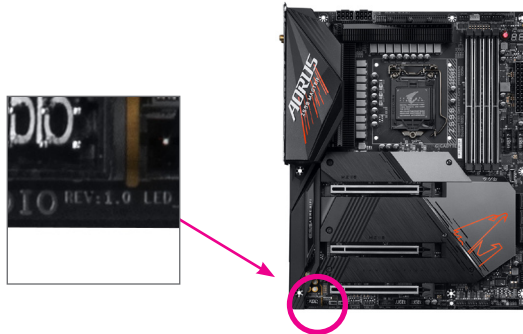
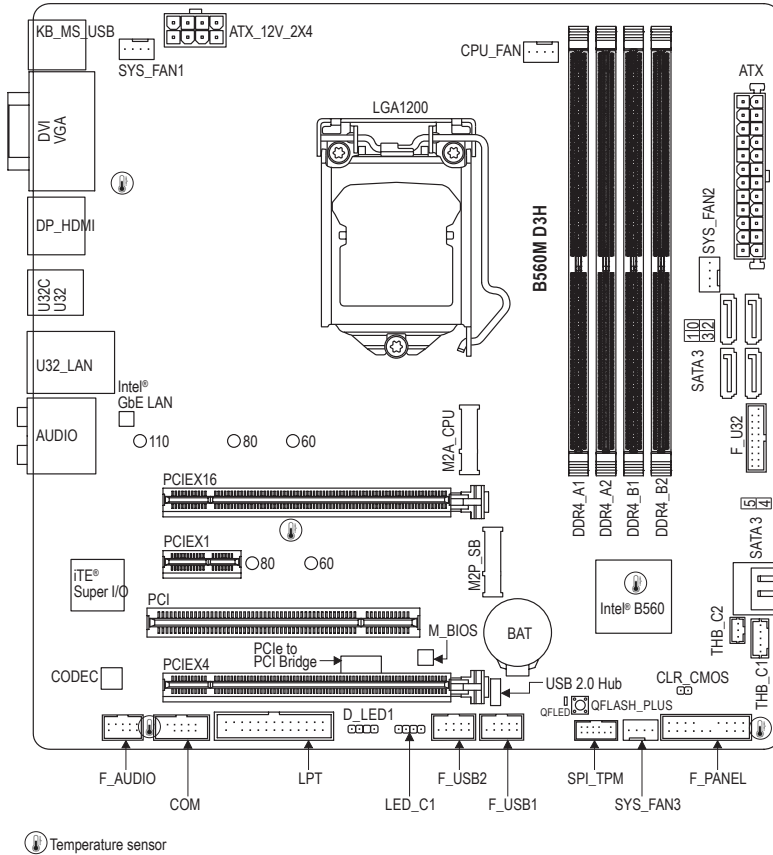

Table of Contents

B560M D3H Motherboard Layout.....	4
Chapter 1 Hardware Installation.....	5
1-1 Installation Precautions.....	5
1-2 Product Specifications	6
1-3 Installing the CPU	9
1-4 Installing the Memory.....	9
1-5 Installing an Expansion Card	10
1-6 Back Panel Connectors	10
1-7 Internal Connectors.....	13
Chapter 2 BIOS Setup.....	22
2-1 Startup Screen	22
2-2 The Main Menu	23
2-3 Smart Fan 6	24
2-4 Favorites (F11).....	26
2-5 Tweaker	27
2-6 Settings.....	32
2-7 System Info.....	37
2-8 Boot.....	38
2-9 Save & Exit	41
Chapter 3 Appendix.....	42
3-1 Installing Intel® Optane™ Memory and Storage Management.....	42
3-2 Drivers Installation	43
Regulatory Notices.....	44
Contact Us	45

B560M D3H Motherboard Layout



Box Contents

- | | |
|---|---|
| <input checked="" type="checkbox"/> B560M D3H motherboard | <input checked="" type="checkbox"/> Two SATA cables |
| <input checked="" type="checkbox"/> Motherboard driver disc | <input checked="" type="checkbox"/> M.2 screws |
| <input checked="" type="checkbox"/> User's Manual | <input checked="" type="checkbox"/> I/O Shield |

* The box contents above are for reference only and the actual items shall depend on the product package you obtain. The box contents are subject to change without notice.









Chapter 1 Hardware Installation

1-1 Installation Precautions





The motherboard contains numerous delicate electronic circuits and components which can become damaged as a result of electrostatic discharge (ESD). Prior to installation, carefully read the user's manual and follow these procedures:

- Prior to installation, make sure the chassis is suitable for the motherboard.
- Prior to installation, do not remove or break motherboard S/N (Serial Number) sticker or warranty sticker provided by your dealer. These stickers are required for warranty validation.
- Always remove the AC power by unplugging the power cord from the power outlet before installing or removing the motherboard or other hardware components.
- When connecting hardware components to the internal connectors on the motherboard, make sure they are connected tightly and securely.
- When handling the motherboard, avoid touching any metal leads or connectors.
- It is best to wear an electrostatic discharge (ESD) wrist strap when handling electronic components such as a motherboard, CPU or memory. If you do not have an ESD wrist strap, keep your hands dry and first touch a metal object to eliminate static electricity.
- Prior to installing the motherboard, please have it on top of an antistatic pad or within an electrostatic shielding container.
- Before connecting or unplugging the power supply cable from the motherboard, make sure the power supply has been turned off.
- Before turning on the power, make sure the power supply voltage has been set according to the local voltage standard.
- Before using the product, please verify that all cables and power connectors of your hardware components are connected.
- To prevent damage to the motherboard, do not allow screws to come in contact with the motherboard circuit or its components.
- Make sure there are no leftover screws or metal components placed on the motherboard or within the computer casing.
- Do not place the computer system on an uneven surface.
- Do not place the computer system in a high-temperature or wet environment.
- Turning on the computer power during the installation process can lead to damage to system components as well as physical harm to the user.
- If you are uncertain about any installation steps or have a problem related to the use of the product, please consult a certified computer technician.
- If you use an adapter, extension power cable, or power strip, ensure to consult with its installation and/or grounding instructions.









1-2 Product Specifications

	CPU	<ul style="list-style-type: none"> ◆ LGA1200 package: <ul style="list-style-type: none"> - 11th Generation Intel® Core™ i9 processors/Intel® Core™ i7 processors/Intel® Core™ i5 processors - 10th Generation Intel® Core™ i9 processors/Intel® Core™ i7 processors/Intel® Core™ i5 processors/Intel® Core™ i3 processors/Intel® Pentium® processors/Intel® Celeron® processors* * Limited to processors with 4 MB Intel® Smart Cache, Intel® Celeron® G5xx5 family. (Go to GIGABYTE's website for the latest CPU support list.) ◆ L3 cache varies with CPU
	Chipset	<ul style="list-style-type: none"> ◆ Intel® B560 Express Chipset
	Memory	<ul style="list-style-type: none"> ◆ 11th Generation Intel® Core™ i9/i7/i5 processors: <ul style="list-style-type: none"> - Support for DDR4 3200/3000/2933/2666/2400/2133 MHz memory modules ◆ 10th Generation Intel® Core™ i9/i7 processors: <ul style="list-style-type: none"> - Support for DDR4 2933/2666/2400/2133 MHz memory modules ◆ 10th Generation Intel® Core™ i5/i3/Pentium®/Celeron® processors: <ul style="list-style-type: none"> - Support for DDR4 2666/2400/2133 MHz memory modules ◆ 4 x DDR4 DIMM sockets supporting up to 128 GB (32 GB single DIMM capacity) of system memory ◆ Dual channel memory architecture ◆ Support for ECC Un-buffered DIMM 1Rx8/2Rx8 memory modules (operate in non-ECC mode) ◆ Support for non-ECC Un-buffered DIMM 1Rx8/2Rx8/1Rx16 memory modules ◆ Support for Extreme Memory Profile (XMP) memory modules (Go to GIGABYTE's website for the latest supported memory speeds and memory modules.)
	Onboard Graphics	<ul style="list-style-type: none"> ◆ Integrated Graphics Processor-Intel® HD Graphics support: <ul style="list-style-type: none"> - 1 x D-Sub port, supporting a maximum resolution of 1920x1200@60 Hz^(Note) - 1 x DVI-D port, supporting a maximum resolution of 1920x1200@60 Hz * The DVI-D port does not support D-Sub connection by adapter. - 1 x HDMI port, supporting a maximum resolution of 4096x2160@30 Hz * Support for HDMI 1.4 version and HDCP 2.3. - 1 x DisplayPort, supporting a maximum resolution of 4096x2304@60 Hz * Support for DisplayPort 1.2 version and HDCP 2.3 (Graphics specifications may vary depending on CPU support.) ◆ Support for up to 3 displays at the same time
	Audio	<ul style="list-style-type: none"> ◆ Realtek® Audio CODEC ◆ High Definition Audio ◆ 2/4/5.1/7.1-channel
	LAN	<ul style="list-style-type: none"> ◆ Intel® GbE LAN chip (1000 Mbit/100 Mbit)
	Multi-Graphics Technology	<ul style="list-style-type: none"> ◆ Support for AMD Quad-GPU CrossFire™ and 2-Way AMD CrossFire™ technologies
	Expansion Slots	<ul style="list-style-type: none"> ◆ 1 x PCI Express x16 slot, running at x16 (PCIEX16) * For optimum performance, if only one PCI Express graphics card is to be installed, be sure to install it in the PCIEX16 slot. (The PCIEX16 slot conforms to PCI Express 4.0 standard.)^(Note)

(Note) Supported by 11th Generation processors only.

	Expansion Slots <ul style="list-style-type: none"> ◆ 1 x PCI Express x16 slot, running at x4 (PCIEX4) ◆ 1 x PCI Express x1 slot (PCIEX1) (The PCIEX4 and PCIEX1 slots conform to PCI Express 3.0 standard.) ◆ 1 x PCI slot
	Storage Interface <ul style="list-style-type: none"> ◆ CPU: <ul style="list-style-type: none"> - 1 x M.2 connector (Socket 3, M key, type 2260/2280/22110 PCIe 4.0 x4/x2 SSD support) (M2A_CPU) ^(Note) ◆ Chipset: <ul style="list-style-type: none"> - 1 x M.2 connector (Socket 3, M key, type 2260/2280 SATA and PCIe 3.0 x4/x2 SSD support) (M2P_SB) ◆ 6 x SATA 6Gb/s connectors <ul style="list-style-type: none"> * Refer to "1-7 Internal Connectors," for the installation notices for the M.2 and SATA connectors. ◆ Intel® Optane™ Memory Ready <ul style="list-style-type: none"> * System Acceleration with Intel® Optane™ Memory enabled on the M2A_CPU connector only.
	USB <ul style="list-style-type: none"> ◆ Chipset: <ul style="list-style-type: none"> - 1 x USB Type-C® port on the back panel, with USB 3.2 Gen 1 support - 5 x USB 3.2 Gen 1 ports (3 ports on the back panel, 2 ports available through the internal USB header) - 4 x USB 2.0/1.1 ports available through the internal USB headers ◆ Chipset+2 USB 2.0 Hubs: <ul style="list-style-type: none"> - 2 x USB 2.0/1.1 ports on the back panel
	Internal Connectors <ul style="list-style-type: none"> ◆ 1 x 24-pin ATX main power connector ◆ 1 x 8-pin ATX 12V power connector ◆ 1 x CPU fan header ◆ 3 x system fan headers ◆ 1 x addressable LED strip header ◆ 1 x RGB LED strip header ◆ 6 x SATA 6Gb/s connectors ◆ 2 x M.2 Socket 3 connectors ◆ 1 x front panel header ◆ 1 x front panel audio header ◆ 1 x USB 3.2 Gen 1 header ◆ 2 x USB 2.0/1.1 headers ◆ 2 x Thunderbolt™ add-in card connectors ◆ 1 x Trusted Platform Module header (For the GC-TPM2.0 SPI/GC-TPM2.0 SPI 2.0 module only) ◆ 1 x serial port header ◆ 1 x parallel port header ◆ 1 x Clear CMOS jumper ◆ 1 x Q-Flash Plus button

(Note) Supported by 11th Generation processors only.

 Back Panel Connectors	<ul style="list-style-type: none"> ◆ 1 x PS/2 keyboard/mouse port ◆ 1 x D-Sub port ◆ 1 x DVI-D port ◆ 1 x DisplayPort ◆ 1 x HDMI port ◆ 1 x USB Type-C® port, with USB 3.2 Gen 1 support ◆ 3 x USB 3.2 Gen 1 ports ◆ 2 x USB 2.0/1.1 ports ◆ 1 x RJ-45 port ◆ 6 x audio jacks
 I/O Controller	<ul style="list-style-type: none"> ◆ iTE® I/O Controller Chip
 Hardware Monitor	<ul style="list-style-type: none"> ◆ Voltage detection ◆ Temperature detection ◆ Fan speed detection ◆ Fan fail warning ◆ Fan speed control <ul style="list-style-type: none"> * Whether the fan speed control function is supported will depend on the cooler you install.
 BIOS	<ul style="list-style-type: none"> ◆ 1 x 256 Mbit flash ◆ Use of licensed AMI UEFI BIOS ◆ PnP 1.0a, DMI 2.7, WfM 2.0, SM BIOS 2.7, ACPI 5.0
 Unique Features	<ul style="list-style-type: none"> ◆ Support for APP Center <ul style="list-style-type: none"> * Available applications in APP Center may vary by motherboard model. Supported functions of each application may also vary depending on motherboard specifications. - @BIOS - EasyTune - Fast Boot - Game Boost - ON/OFF Charge - RGB Fusion - Smart Backup - System Information Viewer ◆ Support for Q-Flash Plus ◆ Support for Q-Flash ◆ Support for Xpress Install
 Bundled Software	<ul style="list-style-type: none"> ◆ Norton® Internet Security (OEM version) ◆ cFosSpeed
 Operating System	<ul style="list-style-type: none"> ◆ Support for Windows 10 64-bit
 Form Factor	<ul style="list-style-type: none"> ◆ Micro ATX Form Factor; 24.4cm x 24.4cm

* GIGABYTE reserves the right to make any changes to the product specifications and product-related information without prior notice.



Please visit GIGABYTE's website for support lists of CPU, memory modules, SSDs, and M.2 devices.



Please visit the **Support Utility List** page on GIGABYTE's website to download the latest version of apps.

1-3 Installing the CPU



Read the following guidelines before you begin to install the CPU:

- Make sure that the motherboard supports the CPU. (Go to GIGABYTE's website for the latest CPU support list.)
- Always turn off the computer and unplug the power cord from the power outlet before installing the CPU to prevent hardware damage.
- Locate the pin one of the CPU. The CPU cannot be inserted if oriented incorrectly. (Or you may locate the notches on both sides of the CPU and alignment keys on the CPU socket.)
- Apply an even and thin layer of thermal grease on the surface of the CPU.
- Do not turn on the computer if the CPU cooler is not installed, otherwise overheating and damage of the CPU may occur.
- Set the CPU host frequency in accordance with the CPU specifications. It is not recommended that the system bus frequency be set beyond hardware specifications since it does not meet the standard requirements for the peripherals. If you wish to set the frequency beyond the standard specifications, please do so according to your hardware specifications including the CPU, graphics card, memory, hard drive, etc.

Installing the CPU

Locate the alignment keys on the motherboard CPU socket and the notches on the CPU.

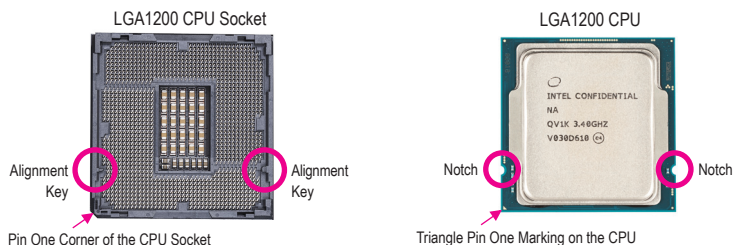

Do not remove the CPU socket cover before inserting the CPU. It may pop off from the load plate automatically during the process of re-engaging the lever after you insert the CPU.

1-4 Installing the Memory



Read the following guidelines before you begin to install the memory:

- Make sure that the motherboard supports the memory. It is recommended that memory of the same capacity, brand, speed, and chips be used. (Go to GIGABYTE's website for the latest supported memory speeds and memory modules.)
- Always turn off the computer and unplug the power cord from the power outlet before installing the memory to prevent hardware damage.
- Memory modules have a foolproof design. A memory module can be installed in only one direction. If you are unable to insert the memory, switch the direction.

Dual Channel Memory Configuration

This motherboard provides four memory sockets and supports Dual Channel Technology. After the memory is installed, the BIOS will automatically detect the specifications and capacity of the memory. Enabling Dual Channel memory mode will double the original memory bandwidth.



Please visit GIGABYTE's website for details on hardware installation.

The four memory sockets are divided into two channels and each channel has two memory sockets as following:

▶▶ Channel A: DDR4_A1, DDR4_A2

▶▶ Channel B: DDR4_B1, DDR4_B2

▶▶ Recommended Dual Channel Memory Configuration:

	DDR4_A1	DDR4_A2	DDR4_B1	DDR4_B2
2 Modules	--	DS/SS	--	DS/SS
4 Modules	DS/SS	DS/SS	DS/SS	DS/SS

(SS=Single-Sided, DS=Double-Sided, "--"=No Memory)

Due to CPU limitations, read the following guidelines before installing the memory in Dual Channel mode.

1. Dual Channel mode cannot be enabled if only one memory module is installed.
2. When enabling Dual Channel mode with two or four memory modules, it is recommended that memory of the same capacity, brand, speed, and chips be used.

1-5 Installing an Expansion Card



Read the following guidelines before you begin to install an expansion card:

- Make sure the motherboard supports the expansion card. Carefully read the manual that came with your expansion card.
- Always turn off the computer and unplug the power cord from the power outlet before installing an expansion card to prevent hardware damage.

1-6 Back Panel Connectors

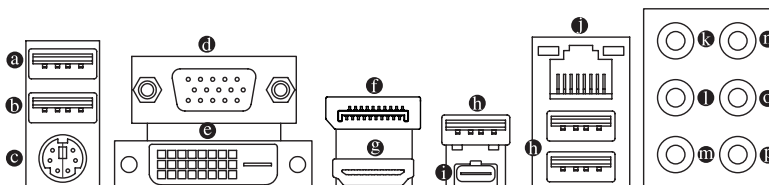

(a) USB 2.0/1.1 Port (Q-Flash Plus Port)

The USB port supports the USB 2.0/1.1 specification. Use this port for USB devices. Use this port for USB devices. Before using Q-Flash Plus ^(Note 1), make sure to insert the USB flash drive into this port first.

(b) USB 2.0/1.1 Port

The USB port supports the USB 2.0/1.1 specification. Use this port for USB devices.

(c) PS/2 Keyboard/Mouse Port

Use this port to connect a PS/2 mouse or keyboard.

(d) D-Sub Port ^(Note 2)

The D-Sub port supports a 15-pin D-Sub connector and supports a maximum resolution of 1920x1200@60 Hz (the actual resolutions supported depend on the monitor being used). Connect a monitor that supports D-Sub connection to this port.

(e) DVI-D Port ^(Note 3)

The DVI-D port conforms to the DVI-D specification and supports a maximum resolution of 1920x1200@60 Hz (the actual resolutions supported depend on the monitor being used). Connect a monitor that supports DVI-D connection to this port.

(Note 1) To enable the Q-Flash Plus function please visit the "Unique Features" webpage of GIGABYTE's website.

(Note 2) Supported by 11th Generation processors only.

(Note 3) The DVI-D port does not support D-Sub connection by adapter.

❶ DisplayPort

DisplayPort delivers high quality digital imaging and audio, supporting bi-directional audio transmission. DisplayPort can support HDCP 2.3 content protection mechanisms. You can use this port to connect your DisplayPort-supported monitor. Note: The DisplayPort Technology can support a maximum resolution of 4096x2304@60 Hz but the actual resolutions supported depend on the monitor being used.

❷ HDMI Port

HDMI™ HIGH-DEFINITION MULTIMEDIA INTERFACE The HDMI port supports HDCP 2.3 and Dolby TrueHD and DTS HD Master Audio formats. It also supports up to 192KHz/16bit 7.1-channel LPCM audio output. You can use this port to connect your HDMI-supported monitor. The maximum supported resolution is 4096x2160@30 Hz, but the actual resolutions supported are dependent on the monitor being used.



- To set up a triple-display configuration, you must install motherboard drivers in the operating system first.
- After installing the DisplayPort/HDMI device, make sure to set the default sound playback device to DisplayPort/HDMI. (The item name may differ depending on your operating system.)

❸ USB 3.2 Gen 1 Port

The USB 3.2 Gen 1 port supports the USB 3.2 Gen 1 specification and is compatible to the USB 2.0 specification. Use this port for USB devices.

❹ USB Type-C® Port

The reversible USB port supports the USB 3.2 Gen 1 specification and is compatible to the USB 2.0 specifications. Use this port for USB devices.

❺ RJ-45 LAN Port

The Gigabit Ethernet LAN port provides Internet connection at up to 1 Gbps data rate. The following describes the states of the LAN port LEDs.

Connection/
Speed LED Activity LED



LAN Port

Connection/Speed LED:

State	Description
Orange	1 Gbps data rate
Green	100 Mbps data rate
Off	10 Mbps data rate

Activity LED:

State	Description
Blinking	Data transmission or receiving is occurring
On	No data transmission or receiving is occurring

❻ Center/Subwoofer Speaker Out (Orange)

Use this audio jack to connect center/subwoofer speakers.

❼ Rear Speaker Out (Black)

Use this audio jack to connect rear speakers.

❽ Side Speaker Out (Gray)

Use this audio jack to connect side speakers.

❾ Line In (Blue)

The line in jack. Use this audio jack for line in devices such as an optical drive, walkman, etc.

❿ Line Out/Front Speaker Out (Green)

The line out jack.

⓫ Mic In (Pink)

The Mic in jack.

Audio Jack Configurations:

Jack	Headphone/ 2-channel	4-channel	5.1-channel	7.1-channel
Center/Subwoofer Speaker Out			✓	✓
Rear Speaker Out		✓	✓	✓
Side Speaker Out				✓
Line In				
Line Out/Front Speaker Out	✓	✓	✓	✓
Mic In				



You can change the functionality of an audio jack using the audio software.



- When removing the cable connected to a back panel connector, first remove the cable from your device and then remove it from the motherboard.
- When removing the cable, pull it straight out from the connector. Do not rock it side to side to prevent an electrical short inside the cable connector.



Please visit GIGABYTE's website for details on configuring the audio software.

1-7 Internal Connectors

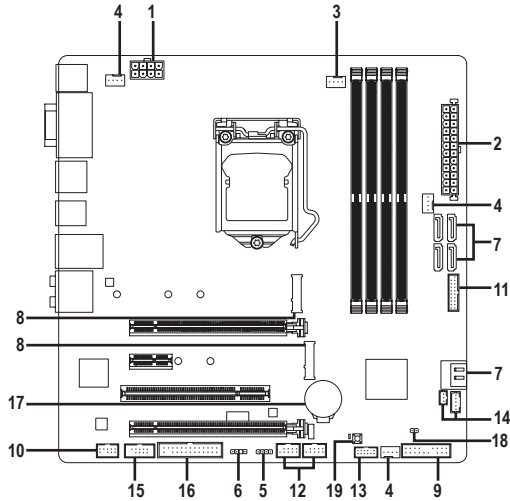

1)	ATX_12V_2X4	11)	F_U32
2)	ATX	12)	F_USB1/F_USB2
3)	CPU_FAN	13)	SPI_TPM
4)	SYS_FAN1/2/3	14)	THB_C1/THB_C2
5)	LED_C1	15)	COM
6)	D_LED1	16)	LPT
7)	SATA3 0/1/2/3/4/5	17)	BAT
8)	M2A_CPU/M2P_SB	18)	CLR_CMOS
9)	F_PANEL	19)	QFLASH_PLUS
10)	F_AUDIO		



Read the following guidelines before connecting external devices:

- First make sure your devices are compliant with the connectors you wish to connect.
- Before installing the devices, be sure to turn off the devices and your computer. Unplug the power cord from the power outlet to prevent damage to the devices.
- After installing the device and before turning on the computer, make sure the device cable has been securely attached to the connector on the motherboard.

1/2) ATX 12V 2X4/ATX (2x4 12V Power Connector and 2x12 Main Power Connector)

With the use of the power connector, the power supply can supply enough stable power to all the components on the motherboard. Before connecting the power connector, first make sure the power supply is turned off and all devices are properly installed. The power connector possesses a foolproof design. Connect the power supply cable to the power connector in the correct orientation.

The 12V power connector mainly supplies power to the CPU. If the 12V power connector is not connected, the computer will not start.



To meet expansion requirements, it is recommended that a power supply that can withstand high power consumption be used (500W or greater). If a power supply is used that does not provide the required power, the result can lead to an unstable or unbootable system.

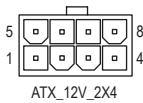

ATX_12V_2X4:

Pin No.	Definition	Pin No.	Definition
1	GND (Only for 2x4-pin 12V)	5	+12V (Only for 2x4-pin 12V)
2	GND (Only for 2x4-pin 12V)	6	+12V (Only for 2x4-pin 12V)
3	GND	7	+12V
4	GND	8	+12V

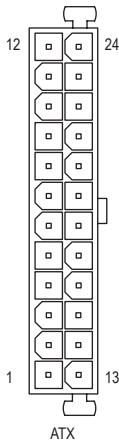

ATX:

Pin No.	Definition	Pin No.	Definition
1	3.3V	13	3.3V
2	3.3V	14	-12V
3	GND	15	GND
4	+5V	16	PS_ON (soft On/Off)
5	GND	17	GND
6	+5V	18	GND
7	GND	19	GND
8	Power Good	20	NC
9	5VSB (stand by +5V)	21	+5V
10	+12V	22	+5V
11	+12V (Only for 2x12-pin ATX)	23	+5V (Only for 2x12-pin ATX)
12	3.3V (Only for 2x12-pin ATX)	24	GND (Only for 2x12-pin ATX)

3/4) CPU_FAN/SYS_FAN1/2/3 (Fan Headers)

All fan headers on this motherboard are 4-pin. Most fan headers possess a foolproof insertion design. When connecting a fan cable, be sure to connect it in the correct orientation (the black connector wire is the ground wire). The speed control function requires the use of a fan with fan speed control design. For optimum heat dissipation, it is recommended that a system fan be installed inside the chassis.

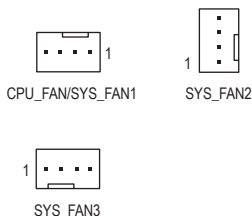

Pin No.	Definition
1	GND
2	Voltage Speed Control
3	Sense
4	PWM Speed Control

Connector	CPU_FAN	SYS_FAN1-3
Maximum Current	2A	2A
Maximum Power	24W	24W



- Be sure to connect fan cables to the fan headers to prevent your CPU and system from overheating. Overheating may result in damage to the CPU or the system may hang.
- These fan headers are not configuration jumper blocks. Do not place a jumper cap on the headers.

5) LED_C1 (RGB LED Strip Header)

The header can be used to connect a standard 5050 RGB LED strip (12V/G/R/B), with maximum power rating of 2A (12V) and maximum length of 2m.

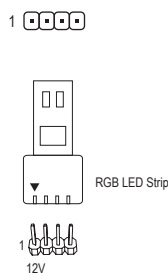

Pin No.	Definition
1	12V
2	G
3	R
4	B

Connect your RGB LED strip to the header. The power pin (marked with a triangle on the plug) of the LED strip must be connected to Pin 1 (12V) of this header. Incorrect connection may lead to the damage of the LED strip.



For how to turn on/off the lights of the LED strip please visit the "Unique Features" webpage of GIGABYTE's website.



Before installing the devices, be sure to turn off the devices and your computer. Unplug the power cord from the power outlet to prevent damage to the devices.

6) D_LED1 (Addressable LED Strip Header)

The headers can be used to connect a standard 5050 addressable LED strip, with maximum power rating of 5A (5V) and maximum number of 1000 LEDs.

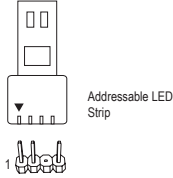

Pin No.	Definition
1	V (5V)
2	Data
3	No Pin
4	GND

Connect your addressable LED strip to the header. The power pin (marked with a triangle on the plug) of the LED strip must be connected to Pin 1 of the addressable LED strip header. Incorrect connection may lead to the damage of the LED strip.



For how to turn on/off the lights of the LED strip please visit the "Unique Features" webpage of GIGABYTE's website.



Before installing the devices, be sure to turn off the devices and your computer. Unplug the power cord from the power outlet to prevent damage to the devices.

7) SATA3 0/1/2/3/4/5 (SATA 6Gb/s Connectors)

The SATA connectors conform to SATA 6Gb/s standard and are compatible with SATA 3Gb/s and SATA 1.5Gb/s standard. Each SATA connector supports a single SATA device.

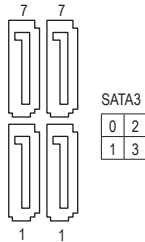

Pin No.	Definition
1	GND
2	TXP
3	TXN
4	GND
5	RXN
6	RXP
7	GND

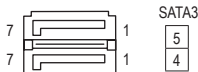

To enable hot-plugging for the SATA ports, refer to Chapter 2, "BIOS Setup," "Settings\IO Ports\ SATA And RST Configuration," for more information.

8) M2A_CPU^(Note)/M2P_SB (M.2 Socket 3 Connectors)

The M.2 connector supports M.2 SATA SSDs or M.2 PCIe SSDs.

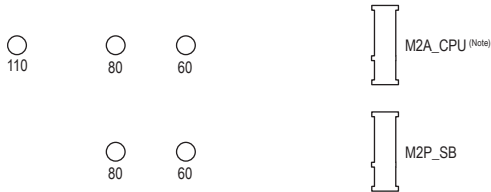

Follow the steps below to correctly install an M.2 SSD in the M.2 connector.

Step 1:

Use a screw driver to unfasten the screw and standoff from the motherboard. Locate the proper mounting hole for the M.2 SSD to be installed and then screw the standoff first.

Step 2:

Slide the M.2 SSD into the connector at an angle.

Step 3:

Press the M.2 SSD down and then use the included screw to secure it in the connector.

Installation Notices for the M.2 and SATA Connectors:

The availability of the SATA connectors may be affected by the type of device installed in the M.2 sockets. The M2P_SB connector shares bandwidth with the SATA3 1 connector. Refer to the following table for details.

• M2A_CPU^(Note):

Type of M.2 SSD \ Connector	SATA3 0	SATA3 1	SATA3 2	SATA3 3	SATA3 4	SATA3 5
M.2 PCIe SSD *	✓	✓	✓	✓	✓	✓
No M.2 SSD Installed	✓	✓	✓	✓	✓	✓

✓ : Available, ✗ : Not available

* The M2A_CPU connector supports only PCIe SSDs.

• M2P_SB:

Type of M.2 SSD \ Connector	SATA3 0	SATA3 1	SATA3 2	SATA3 3	SATA3 4	SATA3 5
M.2 SATA SSD	✓	✗	✓	✓	✓	✓
M.2 PCIe SSD	✓	✓	✓	✓	✓	✓
No M.2 SSD Installed	✓	✓	✓	✓	✓	✓

✓ : Available, ✗ : Not available

(Note) Supported by 11th Generation processors only.

9) F_PANEL (Front Panel Header)

Connect the power switch, reset switch, speaker, chassis intrusion switch/sensor and system status indicator on the chassis to this header according to the pin assignments below. Note the positive and negative pins before connecting the cables.

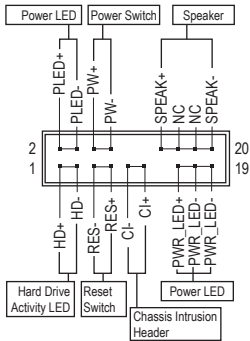

- **PLED/PWR_LED (Power LED, Yellow/Purple):**

System Status	LED
S0	On
S3/S4/S5	Off

Connects to the power status indicator on the chassis front panel. The LED is on when the system is operating. The LED is off when the system is in S3/S4 sleep state or powered off (S5).

- **PW (Power Switch, Red):**

Connects to the power switch on the chassis front panel. You may configure the way to turn off your system using the power switch (refer to Chapter 2, "BIOS Setup," "Settings\Platform Power," for more information).

- **SPEAK (Speaker, Orange):**

Connects to the speaker on the chassis front panel. The system reports system startup status by issuing a beep code. One single short beep will be heard if no problem is detected at system startup.

- **HD (Hard Drive Activity LED, Blue):**

Connects to the hard drive activity LED on the chassis front panel. The LED is on when the hard drive is reading or writing data.

- **RES (Reset Switch, Green):**

Connects to the reset switch on the chassis front panel. Press the reset switch to restart the computer if the computer freezes and fails to perform a normal restart.

- **CI (Chassis Intrusion Header, Gray):**

Connects to the chassis intrusion switch/sensor on the chassis that can detect if the chassis cover has been removed. This function requires a chassis with a chassis intrusion switch/sensor.

- **NC (Orange): No Connection.**



The front panel design may differ by chassis. A front panel module mainly consists of power switch, reset switch, power LED, hard drive activity LED, speaker and etc. When connecting your chassis front panel module to this header, make sure the wire assignments and the pin assignments are matched correctly.

10) F_AUDIO (Front Panel Audio Header)

The front panel audio header supports High Definition audio (HD). You may connect your chassis front panel audio module to this header. Make sure the wire assignments of the module connector match the pin assignments of the motherboard header. Incorrect connection between the module connector and the motherboard header will make the device unable to work or even damage it.



Pin No.	Definition	Pin No.	Definition
1	MIC2_L	6	Sense
2	GND	7	FAUDIO_JD
3	MIC2_R	8	No Pin
4	NC	9	LINE2_L
5	LINE2_R	10	Sense



Some chassis provide a front panel audio module that has separated connectors on each wire instead of a single plug. For information about connecting the front panel audio module that has different wire assignments, please contact the chassis manufacturer.

11) F_U32 (USB 3.2 Gen 1 Header)

The header conforms to USB 3.2 Gen 1 and USB 2.0 specification and can provide two USB ports. For purchasing the optional 3.5" front panel that provides two USB 3.2 Gen 1 ports, please contact the local dealer.

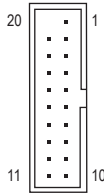

Pin No.	Definition	Pin No.	Definition	Pin No.	Definition
1	VBUS	8	D1-	15	SSTX2-
2	SSRX1-	9	D1+	16	GND
3	SSRX1+	10	NC	17	SSRX2+
4	GND	11	D2+	18	SSRX2-
5	SSTX1-	12	D2-	19	VBUS
6	SSTX1+	13	GND	20	No Pin
7	GND	14	SSTX2+		

12) F_USB1/F_USB2 (USB 2.0/1.1 Headers)

The headers conform to USB 2.0/1.1 specification. Each USB header can provide two USB ports via an optional USB bracket. For purchasing the optional USB bracket, please contact the local dealer.



Pin No.	Definition	Pin No.	Definition
1	Power (5V)	6	USB DY+
2	Power (5V)	7	GND
3	USB DX-	8	GND
4	USB DY-	9	No Pin
5	USB DX+	10	NC



- Do not plug the IEEE 1394 bracket (2x5-pin) cable into the USB 2.0/1.1 header.
- Prior to installing the USB bracket, be sure to turn off your computer and unplug the power cord from the power outlet to prevent damage to the USB bracket.

13) SPI_TPM (Trusted Platform Module Header)

You may connect an SPI TPM (Trusted Platform Module) to this header.

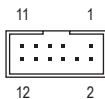

Pin No.	Definition	Pin No.	Definition
1	Data Output	7	Chip Select
2	Power (3.3V)	8	GND
3	No Pin	9	IRQ
4	NC	10	NC
5	Data Input	11	NC
6	CLK	12	RST

14) THB_C1/THB_C2 (Thunderbolt™ Add-in Card Connectors)

The connectors are used to connect to a GIGABYTE Thunderbolt™ add-in card.

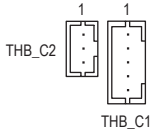

Supports a Thunderbolt™ add-in card.

15) COM (Serial Port Header)

The COM header can provide one serial port via an optional COM port cable. For purchasing the optional COM port cable, please contact the local dealer.

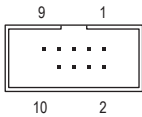

Pin No.	Definition	Pin No.	Definition
1	NDCC-	6	NDSR-
2	NSIN	7	NRTS-
3	NSOUT	8	NCTS-
4	NDTR-	9	NRI-
5	GND	10	No Pin

16) LPT (Parallel Port Header)

The LPT header can provide one parallel port via an optional LPT port cable. For purchasing the optional LPT port cable, please contact the local dealer.

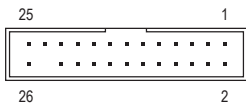

Pin No.	Definition	Pin No.	Definition	Pin No.	Definition
1	STB-	10	GND	19	ACK-
2	AFD-	11	PD4	20	GND
3	PD0	12	GND	21	BUSY
4	ERR-	13	PD5	22	GND
5	PD1	14	GND	23	PE
6	INIT-	15	PD6	24	No Pin
7	PD2	16	GND	25	SLCT
8	SLIN-	17	PD7	26	GND
9	PD3	18	GND		

17) BAT (Battery)

The battery provides power to keep the values (such as BIOS configurations, date, and time information) in the CMOS when the computer is turned off. Replace the battery when the battery voltage drops to a low level, or the CMOS values may not be accurate or may be lost.

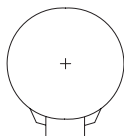

You may clear the CMOS values by removing the battery:

1. Turn off your computer and unplug the power cord.
2. Gently remove the battery from the battery holder and wait for one minute. (Or use a metal object like a screwdriver to touch the positive and negative terminals of the battery holder, making them short for 5 seconds.)
3. Replace the battery.
4. Plug in the power cord and restart your computer.



- Always turn off your computer and unplug the power cord before replacing the battery.
- Replace the battery with an equivalent one. Damage to your devices may occur if the battery is replaced with an incorrect model.
- Contact the place of purchase or local dealer if you are not able to replace the battery by yourself or uncertain about the battery model.
- When installing the battery, note the orientation of the positive side (+) and the negative side (-) of the battery (the positive side should face up).
- Used batteries must be handled in accordance with local environmental regulations.

18) CLR_CMOS (Clear CMOS Jumper)

Use this jumper to clear the BIOS configuration and reset the CMOS values to factory defaults. To clear the CMOS values, use a metal object like a screwdriver to touch the two pins for a few seconds.



Open: Normal



Short: Clear CMOS Values



- Always turn off your computer and unplug the power cord from the power outlet before clearing the CMOS values.
- After system restart, go to BIOS Setup to load factory defaults (select Load Optimized Defaults) or manually configure the BIOS settings (refer to Chapter 2, "BIOS Setup," for BIOS configurations).

19) QFLASH_PLUS (Q-Flash Plus Button)

Q-Flash Plus allows you to update the BIOS when your system is off (S5 shutdown state). Save the latest BIOS on a USB thumb drive and plug it into the dedicated port, and then you can now flash the BIOS automatically by simply pressing the Q-Flash Plus button. The QFLED will flash when the BIOS matching and flashing activities start and will stop flashing when the main BIOS flashing is complete.

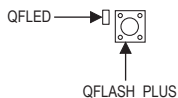

For how to use Q-Flash Plus please visit the "Unique Features" webpage of GIGABYTE's website.

Chapter 2 BIOS Setup

BIOS (Basic Input and Output System) records hardware parameters of the system in the CMOS on the motherboard. Its major functions include conducting the Power-On Self-Test (POST) during system startup, saving system parameters and loading operating system, etc. BIOS includes a BIOS Setup program that allows the user to modify basic system configuration settings or to activate certain system features.

When the power is turned off, the battery on the motherboard supplies the necessary power to the CMOS to keep the configuration values in the CMOS.

To access the BIOS Setup program, press the <Delete> key during the POST when the power is turned on. To upgrade the BIOS, use either the GIGABYTE Q-Flash or @BIOS utility.

- Q-Flash allows the user to quickly and easily upgrade or back up BIOS without entering the operating system.
- @BIOS is a Windows-based utility that searches and downloads the latest version of BIOS from the Internet and updates the BIOS.



- Because BIOS flashing is potentially risky, if you do not encounter problems using the current version of BIOS, it is recommended that you not flash the BIOS. To flash the BIOS, do it with caution. Inadequate BIOS flashing may result in system malfunction.
- It is recommended that you not alter the default settings (unless you need to) to prevent system instability or other unexpected results. Inadequately altering the settings may result in system's failure to boot. If this occurs, try to clear the CMOS values and reset the board to default values. (Refer to the "Load Optimized Defaults" section in this chapter or introductions of the battery/clear CMOS jumper in Chapter 1 for how to clear the CMOS values.)

2-1 Startup Screen

The following startup Logo screen will appear when the computer boots.



There are two different BIOS modes as follows and you can use the <F2> key to switch between the two modes. Easy Mode allows users to quickly view their current system information or to make adjustments for optimum performance. In Easy Mode, you can use your mouse to move through configuration items. The Advanced Mode provides detailed BIOS settings. You can press the arrow keys on your keyboard to move among the items and press <Enter> to accept or enter a sub-menu. Or you can use your mouse to select the item you want.



- When the system is not stable as usual, select the **Load Optimized Defaults** item to set your system to its defaults.
- The BIOS Setup menus described in this chapter are for reference only and may differ by BIOS version.

2-2 The Main Menu

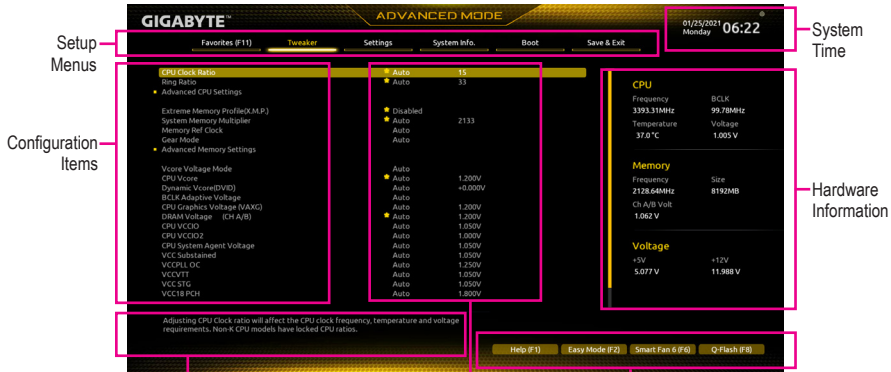

Option Description

Current Settings

Quick Access Bar allows you to quickly move to the General Help, Easy Mode, Smart Fan 6, or Q-Flash screen.

Advanced Mode Function Keys

<←><→>	Move the selection bar to select a setup menu
<↑><↓>	Move the selection bar to select an configuration item on a menu
<Enter>/Double Click	Execute command or enter a menu
<+>/<Page Up>	Increase the numeric value or make changes
<->/<Page Down>	Decrease the numeric value or make changes
<F1>	Show descriptions of the function keys
<F2>	Switch to Easy Mode
<F3>	Save the current BIOS settings to a profile
<F4>	Load the BIOS settings from a profile created before
<F5>	Restore the previous BIOS settings for the current submenus
<F6>	Display the Smart Fan 6 screen
<F7>	Load the Optimized BIOS default settings for the current submenus
<F8>	Access the Q-Flash utility
<F10>	Save all the changes and exit the BIOS Setup program
<F11>	Switch to the Favorites submenu
<F12>	Capture the current screen as an image and save it to your USB drive
<Insert>	Add or remove a favorite option
<Ctrl>+<S>	Display information on the installed memory
<Esc>	Main Menu: Exit the BIOS Setup program Submenus: Exit current submenu

2-3 Smart Fan 6

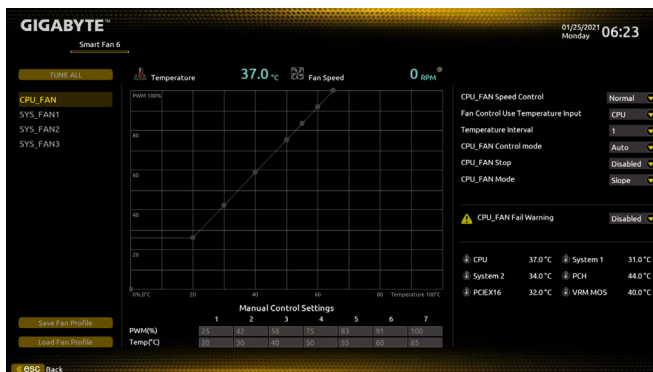

Use the <F6> function key to quickly switch to this screen. This screen allows you to configure fan speed related settings for each fan header or monitor your system/CPU temperature.

- ☞ **TUNE ALL**
Allows you to apply the current settings to all fan headers.
- ☞ **Temperature**
Displays the current temperature of the selected target area.
- ☞ **Fan Speed**
Displays current fan speeds.
- ☞ **Fan Speed Control**
Allows you to determine whether to enable the fan speed control function and adjust the fan speed.
 - ▶▶ Normal Allows the fan to run at different speeds according to the temperature. You can adjust the fan speed with System Information Viewer based on your system requirements. (Default)
 - ▶▶ Silent Allows the fan to run at slow speeds.
 - ▶▶ Manual Allows you to drag the curve nodes to adjust fan speed. Or you can use the **EZ Tuning** feature. After adjusting the node position, press **Apply** to automatically calculate the slope of the curve.
 - ▶▶ Full Speed Allows the fan to run at full speeds.
- ☞ **Fan Control Use Temperature Input**
Allows you to select the reference temperature for fan speed control.
- ☞ **Temperature Interval**
Allows you to select the temperature interval for fan speed change.
- ☞ **FAN Control Mode**
 - ▶▶ Auto Lets the BIOS automatically detect the type of fan installed and sets the optimal control mode. (Default)
 - ▶▶ Voltage Voltage mode is recommended for a 3-pin fan.
 - ▶▶ PWM PWM mode is recommended for a 4-pin fan.
- ☞ **FAN Stop**
Enables or disables the fan stop function. You can set the temperature limit using the temperature curve. The fan stops operation when the temperature is lower than the limit. (Default: Disabled)

☞ **FAN Mode**

Allows you to set the operating mode for the fan.

- ▶▶ Slope Adjusts the fan speed linearly based on the temperature. (Default)
- ▶▶ Stair Adjusts the fan speed stepwise based on the temperature.

☞ **FAN Fail Warning**

Allows the system to emit warning sound if the fan is not connected or fails. Check the fan condition or fan connection when this occurs. (Default: Disabled)

☞ **Save Fan Profile**

This function allows you to save the current settings to a profile. You can save the profile in the BIOS or select **Select File in HDD/FDD/USB** to save the profile to your storage device.

☞ **Load Fan Profile**

This function allows you to load a previously saved BIOS profile without the hassles of reconfiguring the BIOS settings. Or you can select **Select File in HDD/FDD/USB** to load a profile from your storage device.

2-4 Favorites (F11)

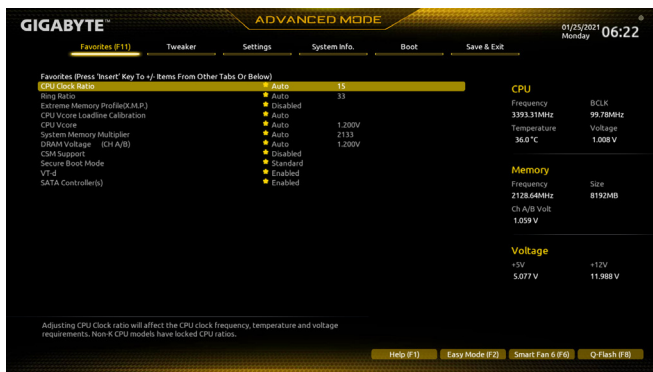

Set your frequently used options as your favorites and use the <F11> key to quickly switch to the page where all of your favorite options are located. To add or remove a favorite option, go to its original page and press <Insert> on the option. The option is marked with a star sign if set as a "favorite."

2-5 Tweaker

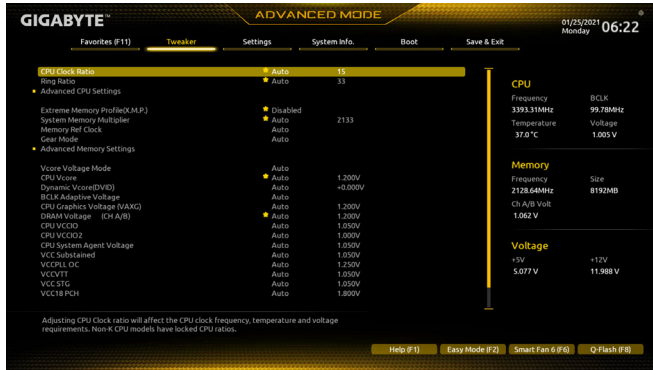

Whether the system will work stably with the overclock/overvoltage settings you made is dependent on your overall system configurations. Incorrectly doing overclock/overvoltage may result in damage to CPU, chipset, or memory and reduce the useful life of these components. This page is for advanced users only and we recommend you not to alter the default settings to prevent system instability or other unexpected results. (Inadequately altering the settings may result in system's failure to boot. If this occurs, clear the CMOS values and reset the board to default values.)

☞ CPU Clock Ratio

Allows you to alter the clock ratio for the installed CPU. The adjustable range is dependent on the CPU being installed.

☞ Ring Ratio

Allows you to set the CPU Uncore ratio. The adjustable range is dependent on the CPU being used. (Default: Auto)

☞ IGP Ratio ^(Note)

Allows you to set the Graphics Ratio. (Default: Auto)

■ Advanced CPU Settings

☞ Core Fused Max Core Ratio ^(Note)

Displays the highest frequency of each core.

☞ AVX Disable ^(Note)

Allows you to disable the AVX instruction sets on a CPU that supports AVX. (Default: Auto)

☞ AVX512 Disable ^(Note)

Allows you to disable the AVX-512 instruction sets on a CPU that supports AVX-512. (Default: Auto)

☞ CPU Over Temperature Protection ^(Note)

Allows you to fine-tune the TJ Max offset value. (Default: Auto)

☞ FCLK Frequency for Early Power On ^(Note)

Allows you to set the FCLK frequency. Options are: Normal(800MHz), 1GHz, 400MHz. (Default: 1GHz)

☞ Hyper-Threading Technology

Allows you to determine whether to enable multi-threading technology when using an Intel® CPU that supports this function. This feature only works for operating systems that support multi-processor mode. **Auto** lets the BIOS automatically configure this setting. (Default: Auto)

(Note) This item is present only when you install a CPU that supports this feature. For more information about Intel® CPUs' unique features, please visit Intel's website.

- ☞ **No. of CPU Cores Enabled**
 Allows you to select the number of CPU cores to enable in an Intel® multi-core CPU (the number of CPU cores may vary by CPU). **Auto** lets the BIOS automatically configure this setting. (Default: Auto)
- ☞ **Intel(R) Speed Shift Technology (Intel® Speed Shift Technology)** ^(Note)
 Enables or disables Intel® Speed Shift Technology. Enabling this feature allows the processor to ramp up its operating frequency more quickly and then improves the system responsiveness. (Default: Enabled)
- ☞ **CPU Thermal Monitor** ^(Note)
 Enables or disables Intel® Thermal Monitor function, a CPU overheating protection function. When enabled, the CPU core frequency and voltage will be reduced when the CPU is overheated. **Auto** lets the BIOS automatically configure this setting. (Default: Auto)
- ☞ **Ring to Core offset (Down Bin)**
 Allows you to determine whether to disable the CPU Ring ratio auto-down function. **Auto** lets the BIOS automatically configure this setting. (Default: Auto)
- ☞ **CPU EIST Function** ^(Note)
 Enables or disables Enhanced Intel® Speed Step Technology (EIST). Depending on CPU loading, Intel® EIST technology can dynamically and effectively lower the CPU voltage and core frequency to decrease average power consumption and heat production. **Auto** lets the BIOS automatically configure this setting. (Default: Auto)
- ☞ **Race To Halt (RTH)** ^(Note)/**Energy Efficient Turbo** ^(Note)
 Enables or disables the CPU power saving related settings. (Default: Auto)
- ☞ **Intel(R) Turbo Boost Technology** ^(Note)
 Allows you to determine whether to enable the Intel® CPU Turbo Boost technology. **Auto** lets the BIOS automatically configure this setting. (Default: Auto)
- ☞ **Intel(R) Turbo Boost Max Technology 3.0** ^(Note)
 Enables or disables Intel® Turbo Boost Max Technology 3.0. Intel® Turbo Boost Max Technology 3.0 allows the system to identify the processor's best performance core and lets you manually direct the most critical workloads to it. You can even adjust the frequency of each core individually for performance optimization. (Default: Enabled)
- ☞ **CPU Flex Ratio Override**
 Enables or disables the CPU Flex Ratio. The maximum CPU clock ratio will be based on the **CPU Flex Ratio Settings** value if **CPU Clock Ratio** is set to **Auto**. (Default: Disabled)
- ☞ **CPU Flex Ratio Settings**
 Allows you to set the CPU Flex Ratio. The adjustable range may vary by CPU.
- ☞ **Frequency Clipping TVB** ^(Note)
 Allows you to enable or disable automatic CPU frequency reduction initiated by Thermal Velocity Boost. **Auto** lets the BIOS automatically configure this setting. (Default: Auto)
- ☞ **Voltage reduction initiated TVB** ^(Note)
 Allows you to enable or disable automatic CPU voltage reduction initiated by Thermal Velocity Boost. **Auto** lets the BIOS automatically configure this setting. (Default: Auto)
- ▼ **Active Turbo Ratios**
- ☞ **Turbo Ratio (Core Active)**
 Allows you to set the CPU Turbo ratios for active cores. **Auto** sets the CPU Turbo ratios according to the CPU specifications. This item is configurable only when **Active Turbo Ratios** is set to **Manual**. (Default: Auto)

(Note) This item is present only when you install a CPU that supports this feature. For more information about Intel® CPUs' unique features, please visit Intel's website.

▼ C-States Control

☞ CPU Enhanced Halt (C1E)

Enables or disables Intel® CPU Enhanced Halt (C1E) function, a CPU power-saving function in system halt state. When enabled, the CPU core frequency and voltage will be reduced during system halt state to decrease power consumption. **Auto** lets the BIOS automatically configure this setting. This item is configurable only when **C-States** is enabled. (Default: Auto)

☞ C3 State Support ^(Note)

Allows you to determine whether to let the CPU enter C3 mode in system halt state. When enabled, the CPU core frequency and voltage will be reduced during system halt state to decrease power consumption. The C3 state is a more enhanced power-saving state than C1. **Auto** lets the BIOS automatically configure this setting. This item is configurable only when **C-States** is enabled. (Default: Auto)

☞ C6/C7 State Support

Allows you to determine whether to let the CPU enter C6/C7 mode in system halt state. When enabled, the CPU core frequency and voltage will be reduced during system halt state to decrease power consumption. The C6/C7 state is a more enhanced power-saving state than C3. **Auto** lets the BIOS automatically configure this setting. This item is configurable only when **C-States Control** is set to **Enabled**. (Default: Auto)

☞ C8 State Support ^(Note)

Allows you to determine whether to let the CPU enter C8 mode in system halt state. When enabled, the CPU core frequency and voltage will be reduced during system halt state to decrease power consumption. The C8 state is a more enhanced power-saving state than C6/C7. **Auto** lets the BIOS automatically configure this setting. This item is configurable only when **C-States Control** is set to **Enabled**. (Default: Auto)

☞ C10 State Support ^(Note)

Allows you to determine whether to let the CPU enter C10 mode in system halt state. When enabled, the CPU core frequency and voltage will be reduced during system halt state to decrease power consumption. The C10 state is a more enhanced power-saving state than C8. **Auto** lets the BIOS automatically configure this setting. This item is configurable only when **C-States Control** is set to **Enabled**. (Default: Auto)

☞ Package C State Limit ^(Note)

Allows you to specify the C-state limit for the processor. **Auto** lets the BIOS automatically configure this setting. This item is configurable only when **C-States Control** is set to **Enabled**. (Default: Auto)

☞ CPU Power Performance ^(Note)

Allows you to determine whether to increase CPU performance. (Default: Auto)

▼ Turbo Power Limits

Allows you to set a power limit for CPU Turbo mode. When the CPU power consumption exceeds the specified power limit, the CPU will automatically reduce the core frequency in order to reduce the power. **Auto** sets the power limit according to the CPU specifications. (Default: Auto)

☞ Power Limit TDP (Watts) / Power Limit Time

Allows you to set the power limit for CPU/platform/memory Turbo mode and how long it takes to operate at the specified power limit. **Auto** sets the power limit according to the CPU specifications. This item is configurable only when **Turbo Power Limits** is set to **Enabled**. (Default: Auto)

☞ Core Current Limit (Amps)

Allows you to set a current limit for CPU Turbo mode. When the CPU current exceeds the specified current limit, the CPU will automatically reduce the core frequency in order to reduce the current. **Auto** sets the power limit according to the CPU specifications. This item is configurable only when **Turbo Power Limits** is set to **Enabled**. (Default: Auto)

(Note) This item is present only when you install a CPU that supports this feature. For more information about Intel® CPUs' unique features, please visit Intel's website.

▼ **Turbo Per Core Limit Control** ^(Note 1)

Allows you to control each CPU core limit separately. (Default: Auto)

☞ **Extreme Memory Profile (X.M.P.)** ^(Note 2)

Allows the BIOS to read the SPD data on XMP memory module(s) to enhance memory performance when enabled.

- ▶▶ Disabled Disables this function. (Default)
- ▶▶ Profile1 Uses Profile 1 settings.
- ▶▶ Profile2 ^(Note 2) Uses Profile 2 settings.

☞ **System Memory Multiplier**

Allows you to set the system memory multiplier. **Auto** sets memory multiplier according to memory SPD data. (Default: Auto)

☞ **Memory Ref Clock**

Allows you to manually adjust the memory reference clock. (Default: Auto)

☞ **Memory Odd Ratio (100/133 or 200/266)** ^(Note 2)

Enabled allows Qclk to run in odd frequency. (Default: Auto)

☞ **Gear Mode** ^(Note 2)

Allows you to improve the maximum OC frequency potential. (Default: Auto)

■ **Advanced Memory Settings**

☞ **Memory Multiplier Tweaker**

Provides different levels of memory auto-tuning. (Default: Auto)

☞ **Channel Interleaving**

Enables or disables memory channel interleaving. **Enabled** allows the system to simultaneously access different channels of the memory to increase memory performance and stability. **Auto** lets the BIOS automatically configure this setting. (Default: Auto)

☞ **Rank Interleaving**

Enables or disables memory rank interleaving. **Enabled** allows the system to simultaneously access different ranks of the memory to increase memory performance and stability. **Auto** lets the BIOS automatically configure this setting. (Default: Auto)

☞ **Memory Boot Mode**

Provides memory detection and training methods.

- ▶▶ Auto Lets the BIOS automatically configure this setting. (Default)
- ▶▶ Normal The BIOS automatically performs memory training. Please note that if the system becomes unstable or unbootable, try to clear the CMOS values and reset the board to default values. (Refer to the introductions of the battery/clear CMOS jumper in Chapter 1 for how to clear the CMOS values.)
- ▶▶ Enable Fast Boot Skip memory detection and training in some specific criteria for faster memory boot.
- ▶▶ Disable Fast Boot Detect and train memory at every single boot.

☞ **Realtime Memory Timing**

Allows you to fine-tune memory timings after the BIOS stage. (Default: Auto)

☞ **Memory Enhancement Settings**

Provides several memory performance enhancement settings: Auto, Relax OC, Enhanced Stability, Normal, Enhanced Performance, High Frequency, High Density, and DDR-4500+. (Default: Auto)

☞ **Memory Channel Detection Message**

Allows you to determine whether to show an alert message when the memory is not installed in the optimal memory channel. (Default: Enabled)

(Note 1) This item is present only when you install a CPU that supports this feature. For more information about Intel® CPUs' unique features, please visit Intel's website.

(Note 2) This item is present only when you install a CPU and a memory module that support this feature.

- **SPD Info**

Displays information on the installed memory.

- **Memory Channels Timings**

- ▼ **Channels Standard Timing Control, Channels Advanced Timing Control, Channels Misc Timing Control**

These sections provide memory timing settings. Note: Your system may become unstable or fail to boot after you make changes on the memory timings. If this occurs, please reset the board to default values by loading optimized defaults or clearing the CMOS values.

- ↳ **Vcore Voltage Mode/CPU Vcore/Dynamic Vcore(DVID)/BCLK Adaptive Voltage/CPU Graphics Voltage (VAXG)/DRAM Voltage (CH A/B)/CPU VCCIO/CPU VCCIO2/CPU System Agent Voltage/VCCPLL OC/VCC18PCH/VCC1V8P**

These items allow you to adjust the CPU Vcore and memory voltages.

- **Advanced Voltage Settings**

This submenu allows you to configure Load-Line Calibration level, over-voltage protection level, and over-current protection level.

2-6 Settings

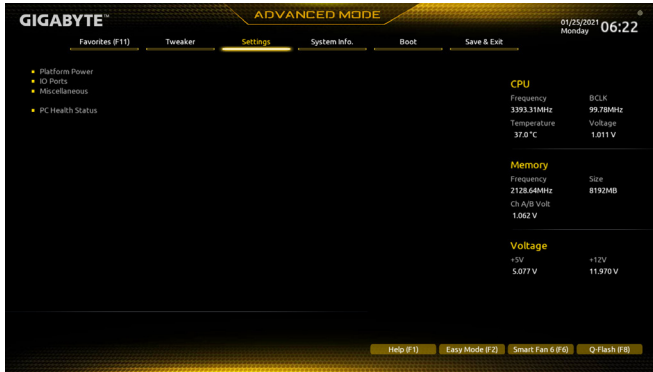

■ Platform Power

☞ Platform Power Management

Enables or disables the Active State Power Management function (ASPM). (Default: Disabled)

☞ PEG ASPM

Allows you to configure the ASPM mode for the device connected to the CPU PEG bus. This item is configurable only when **Platform Power Management** is set to **Enabled**. (Default: Disabled)

☞ PCH ASPM

Allows you to configure the ASPM mode for the device connected to Chipset's PCI Express bus. This item is configurable only when **Platform Power Management** is set to **Enabled**. (Default: Disabled)

☞ DMI ASPM

Allows you to configure the ASPM mode for both CPU side and Chipset side of the DMI link. This item is configurable only when **Platform Power Management** is set to **Enabled**. (Default: Disabled)

☞ Power On By Keyboard

Allows the system to be turned on by a PS/2 keyboard wake-up event.

Note: To use this function, you need an ATX power supply providing at least 1A on the +5VSB lead.

- ▶▶ Disabled Disables this function. (Default)
- ▶▶ Password Set a password with 1~5 characters to turn on the system.
- ▶▶ Keyboard 98 Press POWER button on the Windows 98 keyboard to turn on the system.
- ▶▶ Any Key Press any key to turn on the system.

☞ Power On Password

Set the password when **Power On By Keyboard** is set to **Password**.

Press <Enter> on this item and set a password with up to 5 characters and then press <Enter> to accept.

To turn on the system, enter the password and press <Enter>.

Note: To cancel the password, press <Enter> on this item. When prompted for the password, press <Enter> again without entering the password to clear the password settings.

☞ Power On By Mouse

Allows the system to be turned on by a PS/2 mouse wake-up event.

Note: To use this function, you need an ATX power supply providing at least 1A on the +5VSB lead.

- ▶▶ Disabled Disables this function. (Default)
- ▶▶ Move Move the mouse to turn on the system.
- ▶▶ Double Click Double click on left button on the mouse to turn on the system.

ErP

Determines whether to let the system consume least power in S5 (shutdown) state. (Default: Disabled)

Note: When this item is set to **Enabled**, the following functions will become unavailable: Resume by Alarm, power on by mouse, and power on by keyboard.

Soft-Off by PWR-BTTN

Configures the way to turn off the computer in MS-DOS mode using the power button.

▶▶ Instant-Off Press the power button and then the system will be turned off instantly. (Default)

▶▶ Delay 4 Sec. Press and hold the power button for 4 seconds to turn off the system. If the power button is pressed for less than 4 seconds, the system will enter suspend mode.

Resume by Alarm

Determines whether to power on the system at a desired time. (Default: Disabled)

If enabled, set the date and time as following:

▶▶ Wake up day: Turn on the system at a specific time on each day or on a specific day in a month.

▶▶ Wake up hour/minute/second: Set the time at which the system will be powered on automatically.

Note: When using this function, avoid inadequate shutdown from the operating system or removal of the AC power, or the settings may not be effective.

Power Loading

Enables or disables dummy load. When the power supply is at low load, a self-protection will activate causing it to shutdown or fail. If this occurs, please set to **Enabled**. **Auto** lets the BIOS automatically configure this setting. (Default: Auto)

RC6(Render Standby)

Allows you to determine whether to let the onboard graphics enter standby mode to decrease power consumption. (Default: Enabled)

AC BACK

Determines the state of the system after the return of power from an AC power loss.

▶▶ Memory The system returns to its last known awake state upon the return of the AC power.

▶▶ Always On The system is turned on upon the return of the AC power.

▶▶ Always Off The system stays off upon the return of the AC power. (Default)

IO Ports

Initial Display Output

Specifies the first initiation of the monitor display from the installed PCI Express graphics card or the onboard graphics.

▶▶ IGFX ^(Note) Sets the onboard graphics as the first display.

▶▶ PCIe 1 Slot Sets the graphics card on the PCIEX16 slot as the first display. (Default)

▶▶ PCIe 2 Slot Sets the graphics card on the PCIEX4 slot as the first display.

This item is configurable only when **CSM Support** is set to **Enabled**.

Internal Graphics

Enables or disables the onboard graphics function. (Default: Auto)

DVMT Pre-Allocated

Allows you to set the onboard graphics memory size. (Default: 64M)

DVMT Total Gfx Mem

Allows you to allocate the DVMT memory size of the onboard graphics. Options are: 128M, 256M, MAX. (Default: 256M)

Aperture Size

Allows you to set the maximum amount of system memory that can be allocated to the graphics card. Options are: 128MB, 256MB, 512MB, 1024MB, and 2048MB. (Default: 256MB)

(Note) This item is present only when you install a CPU that supports this feature.

- ⌄ **Audio Controller**
Enables or disables the onboard audio function. (Default: Enabled)
If you wish to install a 3rd party add-in audio card instead of using the onboard audio, set this item to **Disabled**.
- ⌄ **Above 4G Decoding**
Enables or disables 64-bit capable devices to be decoded in above 4 GB address space (only if your system supports 64-bit PCI decoding). Set to **Enabled** if more than one advanced graphics card are installed and their drivers are not able to be launched when entering the operating system (because of the limited 4 GB memory address space). (Default: Disabled)
- ⌄ **PCH LAN Controller**
Enables or disables the onboard LAN function. (Default: Enabled)
If you wish to install a 3rd party add-in network card instead of using the onboard LAN, set this item to **Disabled**.
- ⌄ **Wake on LAN Enable**
Enables or disables the wake on LAN function. (Default: Enabled)
- ⌄ **IOAPIC 24-119 Entries**
Enables or disables this function. (Default: Enabled)
- **Super IO Configuration**
 - ⌄ **Serial Port**
Enables or disables the onboard serial port. (Default: Enabled)
 - ⌄ **Parallel Port**
Enables or disables the onboard parallel port. (Default: Enabled)
- **USB Configuration**
 - ⌄ **Legacy USB Support**
Allows USB keyboard/mouse to be used in MS-DOS. (Default: Enabled)
 - ⌄ **XHCI Hand-off**
Determines whether to enable XHCI Hand-off feature for an operating system without XHCI Hand-off support. (Default: Enabled)
 - ⌄ **USB Mass Storage Driver Support**
Enables or disables support for USB storage devices. (Default: Enabled)
 - ⌄ **Mass Storage Devices**
Displays a list of connected USB mass storage devices. This item appears only when a USB storage device is installed.
- **Network Stack Configuration**
 - ⌄ **Network Stack**
Disables or enables booting from the network to install a GPT format OS, such as installing the OS from the Windows Deployment Services server. (Default: Disabled)
 - ⌄ **IPv4 PXE Support**
Enables or disables IPv4 PXE Support. This item is configurable only when **Network Stack** is enabled.
 - ⌄ **IPv4 HTTP Support**
Enables or disables HTTP boot support for IPv4. This item is configurable only when **Network Stack** is enabled.
 - ⌄ **IPv6 PXE Support**
Enables or disables IPv6 PXE Support. This item is configurable only when **Network Stack** is enabled.

- ⌘ **IPv6 HTTP Support**
 Enables or disables HTTP boot support for IPv6. This item is configurable only when **Network Stack** is enabled.
- ⌘ **PXE boot wait time**
 Allows you to configure how long to wait before you can press <Esc> to abort the PXE boot.
- ⌘ **Media detect count**
 Allows you to set the number of times to check the presence of media.
- **NVMe Configuration**
 Displays information on your M.2 NVME PCIe SSD if installed.
- **SATA And RST Configuration**
 - ⌘ **SATA Controller(s)**
 Enables or disables the integrated SATA controllers. (Default: Enabled)
 - ⌘ **SATA Mode Selection**
 Enables or disables Optane for the SATA controllers integrated in the Chipset or configures the SATA controllers to AHCI mode.
 - ▶ Intel RST Premium With Intel Optane System Acceleration Enables Optane for the SATA controller.
 - ▶ AHCI Configures the SATA controllers to AHCI mode. Advanced Host Controller Interface (AHCI) is an interface specification that allows the storage driver to enable advanced Serial ATA features such as Native Command Queuing and hot plug. (Default)
 - ⌘ **Aggressive LPM Support**
 Enables or disables the power saving feature, ALPM (Aggressive Link Power Management), for the Chipset SATA controllers. (Default: Disabled)
 - ⌘ **Port 0/1/2/3/4/5**
 Enables or disables each SATA port. (Default: Enabled)
 - ⌘ **SATA Port 0/1/2/3/4/5 DevSlp**
 Allows you to determine whether to let the connected SATA device go into sleep mode. (Default: Disabled)
 - ⌘ **Hot plug**
 Enables or disable the hot plug capability for each SATA port. (Default: Disabled)
 - ⌘ **Configured as eSATA**
 Enables or disables support for external SATA devices.
- **Intel(R) Ethernet Connection**
 This sub-menu provides information on LAN configuration and related configuration options.
- **Miscellaneous**
 - ⌘ **LEDs in System Power On State**
 Allows you to enable or disable motherboard LED lighting when the system is on.
 - ▶ Off Disables the selected lighting mode when the system is on.
 - ▶ On Enables the selected lighting mode when the system is on. (Default)
 - ⌘ **LEDs in Sleep, Hibernation, and Soft Off States**
 Allows you to set the lighting mode of the motherboard LEDs in system S3/S4/S5 state. This item is configurable when **LEDs in System Power On State** is set to **On**.
 - ▶ Off Disables the selected lighting mode when the system enters S3/S4/S5 state. (Default)
 - ▶ On Enables the selected lighting mode when the system enters S3/S4/S5 state.
 - ⌘ **Intel Platform Trust Technology (PTT)**
 Enables or disables Intel® PTT Technology. (Default: Disabled)
 - ⌘ **3DMark01 Enhancement**
 Allows you to determine whether to enhance some legacy benchmark performance. (Default: Disabled)

- ☞ **CPU PCIe Link Speed**
Allows you to set the operation mode of the CPU-controlled PCI Express slots to Gen 1, Gen 2, Gen 3, or Gen 4 ^(Note). Actual operation mode is subject to the hardware specification of each slot. **Auto** lets the BIOS automatically configure this setting. (Default: Auto)
- ☞ **PCH PCIe Link Speed**
Allows you to set the operation mode of the Chipset-controlled PCI Express slots to Gen 1, Gen 2, or Gen 3. Actual operation mode is subject to the hardware specification of each slot. **Auto** lets the BIOS automatically configure this setting. (Default: Auto)
- ☞ **VT-d**
Enables or disables Intel® Virtualization Technology for Directed I/O. (Default: Enabled)
- **Trusted Computing**
Enables or disables Trusted Platform Module (TPM).
- **PC Health Status**
- ☞ **Reset Case Open Status**
 - ▶▶ Disabled Keeps or clears the record of previous chassis intrusion status. (Default)
 - ▶▶ Enabled Clears the record of previous chassis intrusion status and the **Case Open** field will show "No" at next boot.
- ☞ **Case Open**
Displays the detection status of the chassis intrusion detection device attached to the motherboard CI header. If the system chassis cover is removed, this field will show "Yes", otherwise it will show "No". To clear the chassis intrusion status record, set **Reset Case Open Status** to **Enabled**, save the settings to the CMOS, and then restart your system.
- ☞ **CPU Vcore/CPU VCCSA/DRAM Channel A/B Voltage/+3.3V/+5V/+12V/CPU VAXG**
Displays the current system voltages.

(Note) This item is present only when you install a CPU that supports this feature.

2-7 System Info.

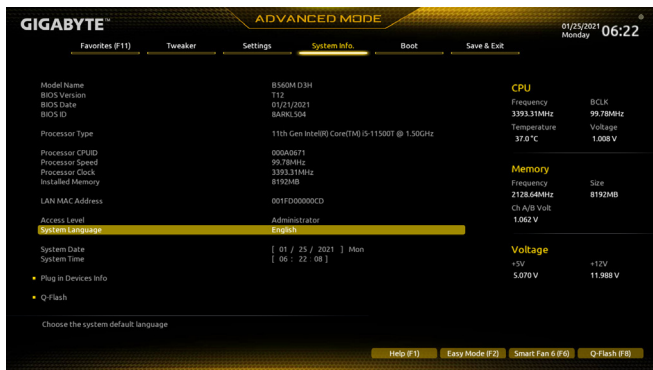

This section provides information on your motherboard model and BIOS version. You can also select the default language used by the BIOS and manually set the system time.

☞ Access Level

Displays the current access level depending on the type of password protection used. (If no password is set, the default will display as **Administrator**.) The Administrator level allows you to make changes to all BIOS settings; the User level only allows you to make changes to certain BIOS settings but not all.

☞ System Language

Selects the default language used by the BIOS.

☞ System Date

Sets the system date. The date format is week (read-only), month, date, and year. Use <Enter> to switch between the Month, Date, and Year fields and use the <Page Up> or <Page Down> key to set the desired value.

☞ System Time

Sets the system time. The time format is hour, minute, and second. For example, 1 p.m. is 13:00:00. Use <Enter> to switch between the Hour, Minute, and Second fields and use the <Page Up> or <Page Down> key to set the desired value.

■ Plug in Devices Info

Displays information on your PCI Express and M.2 devices if installed.

■ Q-Flash

Allows you to access the Q-Flash utility to update the BIOS or back up the current BIOS configuration.

2-8 Boot

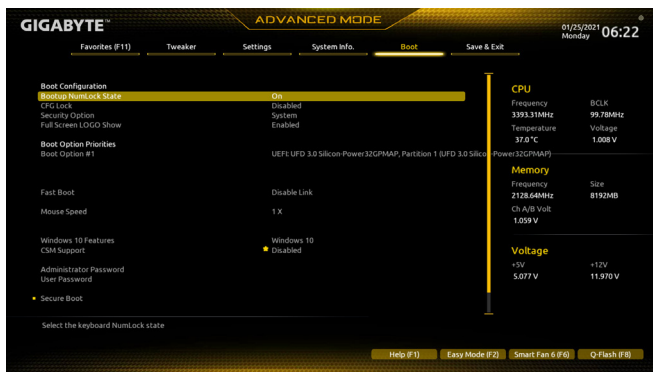

⊞ Bootup NumLock State

Enables or disables Numlock feature on the numeric keypad of the keyboard after the POST. (Default: On)

⊞ CFG Lock

Enables or disables the MSR 0xE2 function. (Default: Disabled)

⊞ Security Option

Specifies whether a password is required every time the system boots, or only when you enter BIOS Setup. After configuring this item, set the password(s) under the **Administrator Password/User Password** item.

- ▶▶ Setup A password is only required for entering the BIOS Setup program.
- ▶▶ System A password is required for booting the system and for entering the BIOS Setup program. (Default)

⊞ Full Screen LOGO Show

Allows you to determine whether to display the GIGABYTE Logo at system startup. **Disabled** skips the GIGABYTE Logo when the system starts up. (Default: Enabled)

⊞ Boot Option Priorities

Specifies the overall boot order from the available devices. Removable storage devices that support GPT format will be prefixed with "UEFI:" string on the boot device list. To boot from an operating system that supports GPT partitioning, select the device prefixed with "UEFI:" string.

Or if you want to install an operating system that supports GPT partitioning such as Windows 10 64-bit, select the optical drive that contains the Windows 10 64-bit installation disc and is prefixed with "UEFI:" string.

⊞ Fast Boot

Enables or disables Fast Boot to shorten the OS boot process. **Ultra Fast** provides the fastest bootup speed. (Default: Disable Link)

⊞ SATA Support

- ▶▶ Last Boot SATA Devices Only Except for the previous boot drive, all SATA devices are disabled before the OS boot process completes. (Default)
- ▶▶ All SATA Devices All SATA devices are functional in the operating system and during the POST. This item is configurable only when **Fast Boot** is set to **Enabled** or **Ultra Fast**.

⊟ **VGA Support**

Allows you to select which type of operating system to boot.

- ▶▶ Auto Enables legacy option ROM only.
- ▶▶ EFI Driver Enables EFI option ROM. (Default)

This item is configurable only when **Fast Boot** is set to **Enabled** or **Ultra Fast**.

⊟ **USB Support**

- ▶▶ Disable Link All USB devices are disabled before the OS boot process completes.
- ▶▶ Full Initial All USB devices are functional in the operating system and during the POST. (Default)

▶▶ Partial Initial Part of the USB devices are disabled before the OS boot process completes.

This item is configurable only when **Fast Boot** is set to **Enabled** or **Ultra Fast**. This function is disabled when **Fast Boot** is set to **Ultra Fast**.

⊟ **PS2 Devices Support**

- ▶▶ Disable Link All PS/2 devices are disabled before the OS boot process completes.
- ▶▶ Enabled All PS/2 devices are functional in the operating system and during the POST. (Default)

This item is configurable only when **Fast Boot** is set to **Enabled** or **Ultra Fast**.

⊟ **NetWork Stack Driver Support**

- ▶▶ Disable Link Disables booting from the network. (Default)
- ▶▶ Enabled Enables booting from the network.

This item is configurable only when **Fast Boot** is set to **Enabled** or **Ultra Fast**.

⊟ **Next Boot After AC Power Loss**

- ▶▶ Normal Boot Enables normal bootup upon the return of the AC power. (Default)
- ▶▶ Fast Boot Keeps the Fast Boot settings upon the return of the AC power.

This item is configurable only when **Fast Boot** is set to **Enabled** or **Ultra Fast**.

⊟ **Mouse Speed**

Allows you to set the mouse cursor movement speed. (Default: 1 X)

⊟ **Windows 10 Features**

Allows you to select the operating system to be installed. (Default: Windows 10)

⊟ **CSM Support**

Enables or disables UEFI CSM (Compatibility Support Module) to support a legacy PC boot process.

- ▶▶ Enabled Enables UEFI CSM.
- ▶▶ Disabled Disables UEFI CSM and supports UEFI BIOS boot process only. (Default)

⊟ **LAN PXE Boot Option ROM**

Allows you to select whether to enable the legacy option ROM for the LAN controller. (Default: Disabled)

This item is configurable only when **CSM Support** is set to **Enabled**.

⊟ **Storage Boot Option Control**

Allows you to select whether to enable the UEFI or legacy option ROM for the storage device controller.

- ▶▶ Do not launch Disables option ROM.
- ▶▶ UEFI Enables UEFI option ROM only.
- ▶▶ Legacy Enables legacy option ROM only. (Default)

This item is configurable only when **CSM Support** is set to **Enabled**.

⊟ **Other PCI devices**

Allows you to select whether to enable the UEFI or Legacy option ROM for the PCI device controller other than the LAN, storage device, and graphics controllers.

- ▶▶ Do not launch Disables option ROM.
- ▶▶ UEFI Enables UEFI option ROM only. (Default)
- ▶▶ Legacy Enables legacy option ROM only.

This item is configurable only when **CSM Support** is set to **Enabled**.

☞ **Administrator Password**

Allows you to configure an administrator password. Press <Enter> on this item, type the password, and then press <Enter>. You will be requested to confirm the password. Type the password again and press <Enter>. You must enter the administrator password (or user password) at system startup and when entering BIOS Setup. Differing from the user password, the administrator password allows you to make changes to all BIOS settings.

☞ **User Password**

Allows you to configure a user password. Press <Enter> on this item, type the password, and then press <Enter>. You will be requested to confirm the password. Type the password again and press <Enter>. You must enter the administrator password (or user password) at system startup and when entering BIOS Setup. However, the user password only allows you to make changes to certain BIOS settings but not all.

To cancel the password, press <Enter> on the password item and when requested for the password, enter the correct one first. When prompted for a new password, press <Enter> without entering any password. Press <Enter> again when prompted to confirm.

NOTE: Before setting the User Password, be sure to set the Administrator Password first.

■ **Secure Boot**

Allows you to enable or disable Secure Boot and configure related settings. This item is configurable only when **CSM Support** is set to **Disabled**.

☞ **Preferred Operating Mode**

Allows you to select whether to enter Easy mode or Advanced mode after entering BIOS Setup. **Auto** enters the BIOS mode where it was last time. (Default: Auto)

2-9 Save & Exit

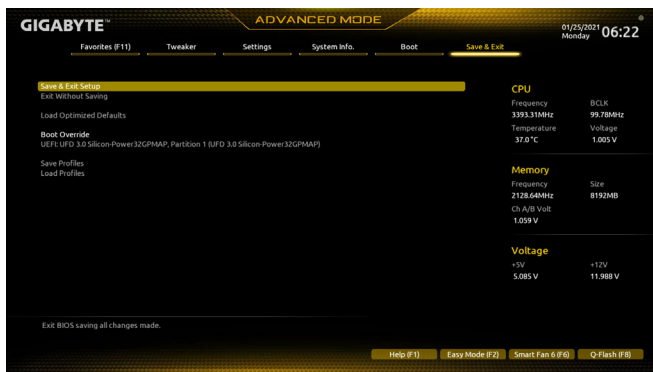

Save & Exit Setup

Press <Enter> on this item and select **Yes**. This saves the changes to the CMOS and exits the BIOS Setup program. Select **No** or press <Esc> to return to the BIOS Setup Main Menu.

Exit Without Saving

Press <Enter> on this item and select **Yes**. This exits the BIOS Setup without saving the changes made in BIOS Setup to the CMOS. Select **No** or press <Esc> to return to the BIOS Setup Main Menu.

Load Optimized Defaults

Press <Enter> on this item and select **Yes** to load the optimal BIOS default settings. The BIOS default settings help the system to operate in optimum state. Always load the Optimized defaults after updating the BIOS or after clearing the CMOS values.

Boot Override

Allows you to select a device to boot immediately. Press <Enter> on the device you select and select **Yes** to confirm. Your system will restart automatically and boot from that device.

Save Profiles

This function allows you to save the current BIOS settings to a profile. You can create up to 8 profiles and save as Setup Profile 1~ Setup Profile 8. Press <Enter> to complete. Or you can select **Select File in HDD/FDD/USB** to save the profile to your storage device.

Load Profiles

If your system becomes unstable and you have loaded the BIOS default settings, you can use this function to load the BIOS settings from a profile created before, without the hassles of reconfiguring the BIOS settings. First select the profile you wish to load and then press <Enter> to complete. You can select **Select File in HDD/FDD/USB** to input the profile previously created from your storage device or load the profile automatically created by the BIOS, such as reverting the BIOS settings to the last settings that worked properly (last known good record).

Chapter 3 Appendix

3-1 Installing Intel® Optane™ Memory and Storage Management

Steps:

1. After entering the operating system, insert the motherboard driver disc into your optical drive. On the **Xpress Install** screen, select **Intel® Rapid Storage Technology** to install and follow the on-screen instructions to complete the installation. When completed, restart the system.
2. After you install the included motherboard drivers, make sure your Internet connection works properly. The system will automatically install the software from Intel®. Restart the system after the driver is installed.

A. Enabling an Intel® Optane™ Memory

A-1. System Requirements

1. Intel® Optane™ memory.
2. The Optane™ memory must have at least 16 GB capacity, and it must have equal or smaller capacity than the hard drive/SSD to be accelerated.
3. The Optane™ memory cannot be used to accelerate an existing RAID array; the accelerated hard drive/SSD cannot be included in a RAID array.
4. The hard drive/SSD to be accelerated must be a SATA hard drive or M.2 SATA SSD.
5. The hard drive/SSD to be accelerated can be a system drive or data drive. The system drive must be GPT formatted and have Windows 10 64-bit (or later version) installed on it. The data drive must also be GPT formatted.
6. The motherboard driver disc.
7. The SATA controller must set in Intel RST Premium With Intel Optane System Acceleration mode.

A-2. Installation Guidelines

1. Go to **Settings\IO Ports\SATA And RST Configuration** and make sure **RST Control PCIe Storage Devices** is set to **Manual**. Then depending on which M.2 connector you install the Optane™ memory in, set the corresponding **PCIe Storage Dev on Port XX** item to **RST Controlled**.
2. After re-entering the operating system, launch the **Intel® Optane™ Memory and Storage Management** application from the Start menu. If you install more than one Optane™ memory, please select which one you are going to use. Then select which drive to be accelerated. Click **Enable Intel® Optane™ Memory**. All data on the Optane™ memory will be erased. Make sure you back up the data before continuing. Follow the on-screen instructions to proceed. When completed, restart the system.
3. Launch the **Intel® Optane™ Memory and Storage Management** application from the Start menu and make sure the Intel® Optane™ Memory has been enabled.
4. If you want to accelerate the system drive, you can select specific folders, files, or applications to accelerate using the **Intel® Optane™ Memory Pinning** function. (The Optane™ memory used must have at least 32 GB capacity.)



- An Optane™ memory cannot be used to accelerate an M.2 PCIe SSD.
- If more than one Optane™ memory is installed, you can select only one of them to accelerate your SATA-based boot drive. The other(s) can only be used as data drive(s).
- Do not abruptly remove the Optane™ memory. Doing so will cause the operating system to stop functioning correctly.
- If you want to change/remove the Optane™ memory, you must disable it using the **Intel® Optane™ Memory and Storage Management** application first.
- After enabling the Optane™ memory, the related BIOS settings will remain even after a BIOS update.



Please visit GIGABYTE's website for details on enabling an Intel® Optane™ memory.

3-2 Drivers Installation



- Before installing the drivers, first install the operating system.
- After installing the operating system, insert the motherboard driver disk into your optical drive. Click on the message "Tap to choose what happens with this disc" on the top-right corner of the screen and select "Run Run.exe." (Or go to My Computer, double-click the optical drive and execute the Run.exe program.)

"Xpress Install" will automatically scan your system and then list all of the drivers that are recommended to install. You can click the **Xpress Install** button and "Xpress Install" will install all of the selected drivers. Or click the arrow  icon to individually install the drivers you need.

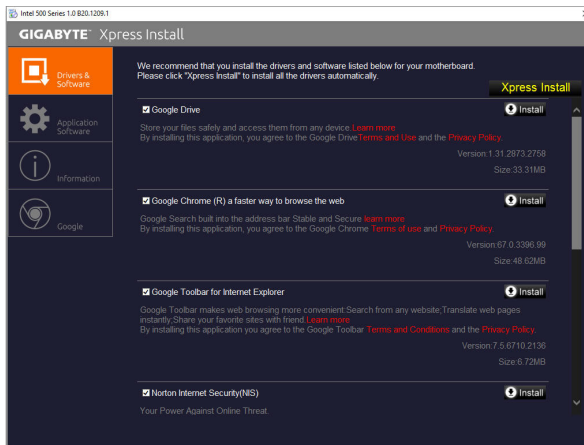

Please visit GIGABYTE's website for more software information.



Please visit GIGABYTE's website for more troubleshooting information.

Regulatory Notices

United States of America, Federal Communications Commission Statement

Supplier's Declaration of Conformity 47 CFR § 2.1077 Compliance Information

Product Name: **Motherboard**
Trade Name: **GIGABYTE**
Model Number: **B560M D3H**

Responsible Party – U.S. Contact Information: **G.B.T. Inc.**
Address: 17358 Railroad street, City Of Industry, CA91748
Tel.: 1-626-954-9338
Internet contact information: <https://www.gigabyte.com>

FCC Compliance Statement:

This device complies with Part 15 of the FCC Rules, Subpart B, Unintentional Radiators.
Operation is subject to the following two conditions: (1) This device may not cause harmful interference, and (2) this device must accept any interference received, including interference that may cause undesired operation.

This equipment has been tested and found to comply with the limits for a Class B digital device, pursuant to Part 15 of the FCC Rules. These limits are designed to provide reasonable protection against harmful interference in a residential installation. This equipment generates, uses and can radiate radio frequency energy and, if not installed and used in accordance with manufacturer's instructions, may cause harmful interference to radio communications. However, there is no guarantee that interference will not occur in a particular installation. If this equipment does cause harmful interference to radio or television reception, which can be determined by turning the equipment off and on, the user is encouraged to try to correct the interference by one or more of the following measures:

- Reorient or relocate the receiving antenna.
- Increase the separation between the equipment and receiver.
- Connect the equipment to an outlet on a circuit different from that to which the receiver is connected.
- Consult the dealer or an experienced radio/TV technician for help.

Canadian Department of Communications Statement

This digital apparatus does not exceed the Class B limits for radio noise emissions from digital apparatus set out in the Radio Interference Regulations of the Canadian Department of Communications. This class B digital apparatus complies with Canadian ICES-003.

Avis de conformité à la réglementation d'Industrie Canada

Cet appareil numérique de la classe B est conforme à la norme NMB-003 du Canada.

European Union (EU) CE Declaration of Conformity

This device complies with the following directives: Electromagnetic Compatibility Directive 2014/30/EU, Low-voltage Directive 2014/35/EU, RoHS directive (recast) 2011/65/EU & the 2015/863 Statement. This product has been tested and found to comply with all essential requirements of the Directives.

European Union (EU) RoHS (recast) Directive 2011/65/EU & the European Commission Delegated Directive (EU) 2015/863 Statement
GIGABYTE products have not intended to add and safe from hazardous substances (Cd, Pb, Hg, Cr+6, PBDE, PBB, DEHP, BBP, DBP and DIBP). The parts and components have been carefully selected to meet RoHS requirement. Moreover, we at GIGABYTE are continuing our efforts to develop products that do not use internationally banned toxic chemicals.

European Union (EU) Community Waste Electrical & Electronic Equipment (WEEE) Directive Statement

GIGABYTE will fulfill the national laws as interpreted from the 2012/19/EU WEEE (Waste Electrical and Electronic Equipment) (recast) directive. The WEEE Directive specifies the treatment, collection, recycling and disposal of electric and electronic devices and their components. Under the Directive, used equipment must be marked, collected separately, and disposed of properly.

WEEE Symbol Statement



The symbol shown below is on the product or on its packaging, which indicates that this product must not be disposed of with other waste. Instead, the device should be taken to the waste collection centers for activation of the treatment, collection, recycling and disposal procedure.

For more information about where you can drop off your waste equipment for recycling, please contact your local government office, your household waste disposal service or where you purchased the product for details of environmentally safe recycling.

End of Life Directives-Recycling



The symbol shown below is on the product or on its packaging, which indicates that this product must not be disposed of with other waste. Instead, the device should be taken to the waste collection centers for activation of the treatment, collection, recycling and disposal procedure.

Déclaration de Conformité aux Directives de l'Union européenne (UE)

Cet appareil portant la marque CE est conforme aux directives de l'UE suivantes: directive Compatibilité Electromagnétique 2014/30/UE, directive Basse Tension 2014/35/UE et directive RoHS II 2011/65/UE. La conformité à ces directives est évaluée sur la base des normes européennes harmonisées applicables.

European Union (EU) CE-Konformitätserklärung

Dieses Produkte mit CE-Kennzeichnung erfüllen folgenden EU-Richtlinien: EMV-Richtlinie 2014/30/EU, Niederspannungsrichtlinie 2014/30/EU und RoHS-Richtlinie 2011/65/EU erfüllt. Die Konformität mit diesen Richtlinien wird unter Verwendung der entsprechenden Standards zur Europäischen Normierung beurteilt.

CE declaração de conformidade

Este produto com a marcação CE estão em conformidade com das seguintes Diretivas UE: Diretiva Baixa Tensão 2014/35/EU; Diretiva CEM 2014/30/EU; Diretiva RSP 2011/65/UE. A conformidade com estas diretivas é verificada utilizando as normas europeias harmonizadas.

CE Declaración de conformidad

Este producto que llevan la marca CE cumplen con las siguientes Directivas de la Unión Europea: Directiva EMC (2014/30/EU), Directiva de bajo voltaje (2014/35/EU), Directiva RoHS (recast) (2011/65/EU). El cumplimiento de estas directivas se evalúa mediante las normas europeas armonizadas.

Dichiarazione di conformità CE

Questo prodotto è conforme alle seguenti direttive: Direttiva sulla compatibilità elettromagnetica 2014/30/UE, Direttiva sulla bassa tensione 2014/35/UE, Direttiva RoHS (rifusione) 2011/65/UE. Questo prodotto è stato testato e trovato conforme a tutti i requisiti essenziali delle Direttive.



Contact Us

GIGA-BYTE TECHNOLOGY CO., LTD.

Address: No.6, Baoqiang Rd., Xindian Dist., New Taipei City 231, Taiwan

TEL: +886-2-8912-4000, FAX: +886-2-8912-4005

Tech. and Non-Tech. Support (Sales/Marketing) : <https://esupport.gigabyte.com>

WEB address (English): <https://www.gigabyte.com>

WEB address (Chinese): <https://www.gigabyte.com/tw>

- **GIGABYTE eSupport**

To submit a technical or non-technical (Sales/Marketing) question, please link to:
<https://esupport.gigabyte.com>

The screenshot shows the GIGABYTE eSupport landing page. At the top left is the GIGABYTE logo. The main heading is "Welcome to eSupport" in blue. Below it is a sub-heading: "Submit your product/sponsorship/marketing questions or inquiries, and our representative will respond in a timely fashion." The page is divided into three main sections:

- NEWS:** A box with the text "Your submissions will be displayed in your personal page, log in to see the processing status."
- SIGN IN:** A login form with fields for "Account" and "Password". Below the fields are links for "Register", "Forgot Password", and "Sign In". To the right of the form are social media icons for Facebook, Google+, Twitter, and LinkedIn, with the text "sign in with" above them.
- QUICK LINK:** A box containing three icons: "Downloads", "FAQ", and "Warranty".