

ViewSonic®



> ViewBoard IFP52 Series

Commercial Touch Display

Quick Start Guide

Průvodce rychlým spuštěním

Startvejledning

Snelle gebruikshandleiding

Pikaopas

Guide de démarrage rapide Schnellstartanleitung

Panduan Ringkas

Guida rapida

Hurtigstartveiledning

Skrócona instrukcja obsługi

Краткое руководство

Guía de inicio rápido

Snabbstartsguide

Hızlı Başlangıç Kılavuzu

คู่มือเริ่มต้นฉบับย่อ

快速入門手冊

快速入门手册

クイックスタートガイド

دليل التشغيل السريع



> Package Contents

- HDMI cable (10ft/3m)
- Type-c cable (5ft/1.5m)
- USB cable for touch (10ft/3m)
- Clamp x 5
- Webcam plate
- AAA battery x 2
- Touch pen x 2
- Remote control
- Eraser
- Webcam screws x 4 (M4x7mm x2, M3x6mm x2)
- Quick start guide
- Compliance statement
- RS232 adapter
- Power cable (ship by region)
- Wall mount screws x 4 (M8x20mm x4)

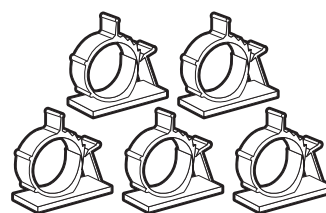
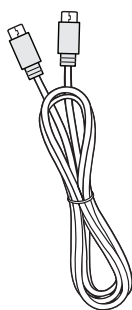
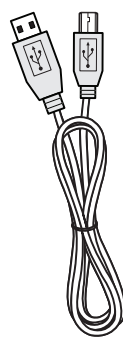
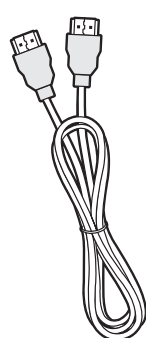
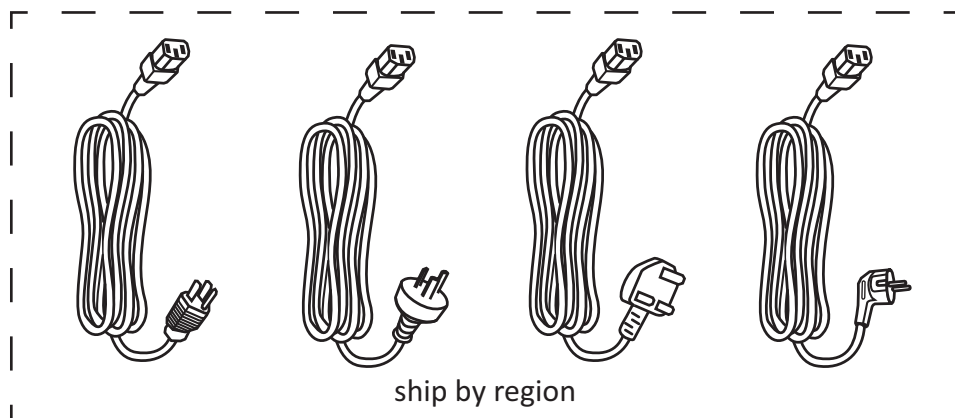

M8 X 4



M3 X 2



M4 X 2

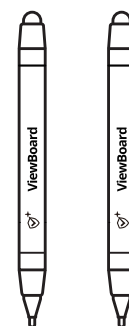
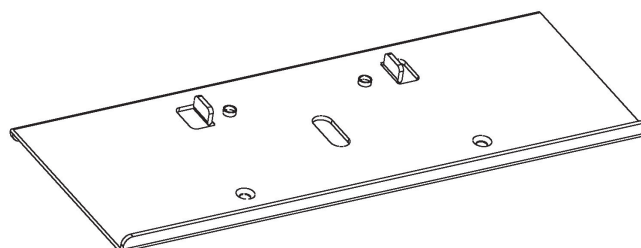
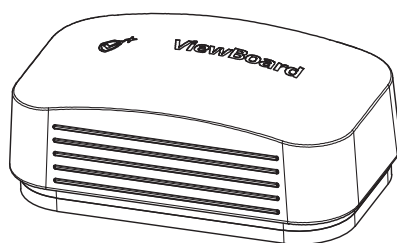

➤ Wall Mount Kit Specifications (sold separately)

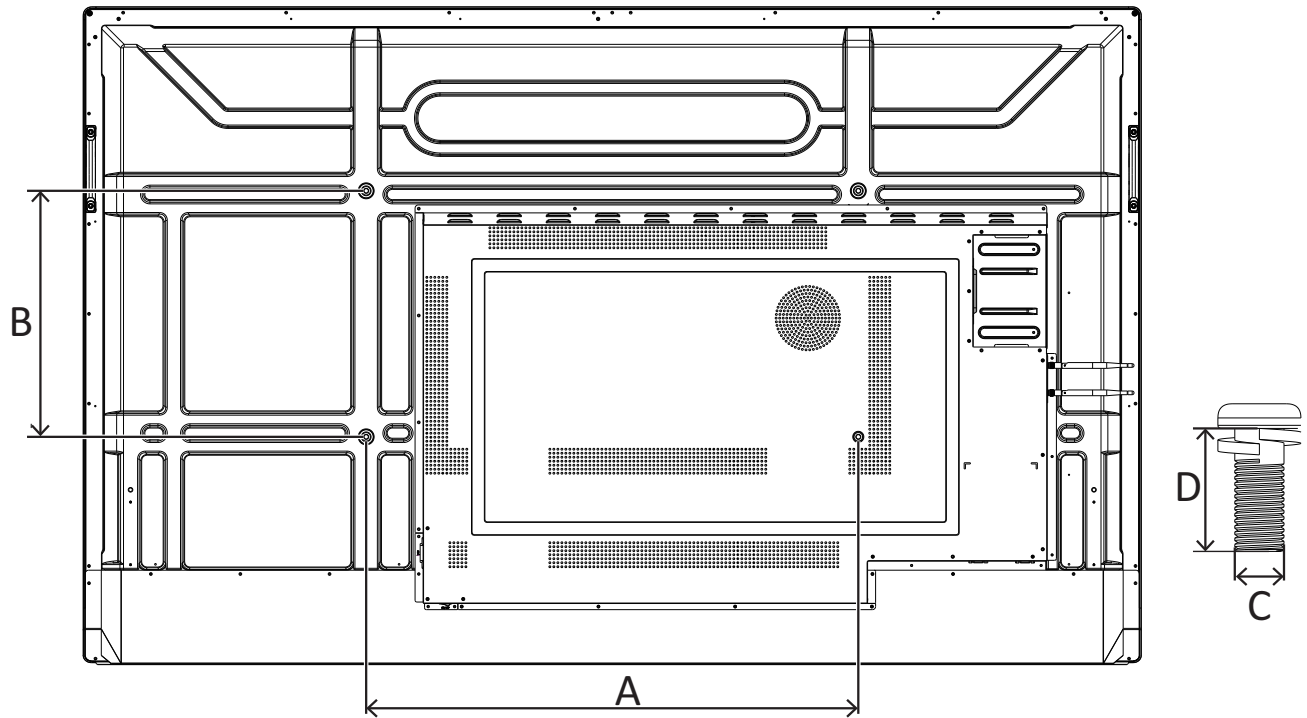

inch	VESA Spec. (A x B)	Standard Screw (C x D)	Quantity
	600 x 400 mm	M8 x 20 mm	4
	800 x 400 mm	M8 x 20 mm	4
	800 x 600 mm	M8 x 20 mm	4

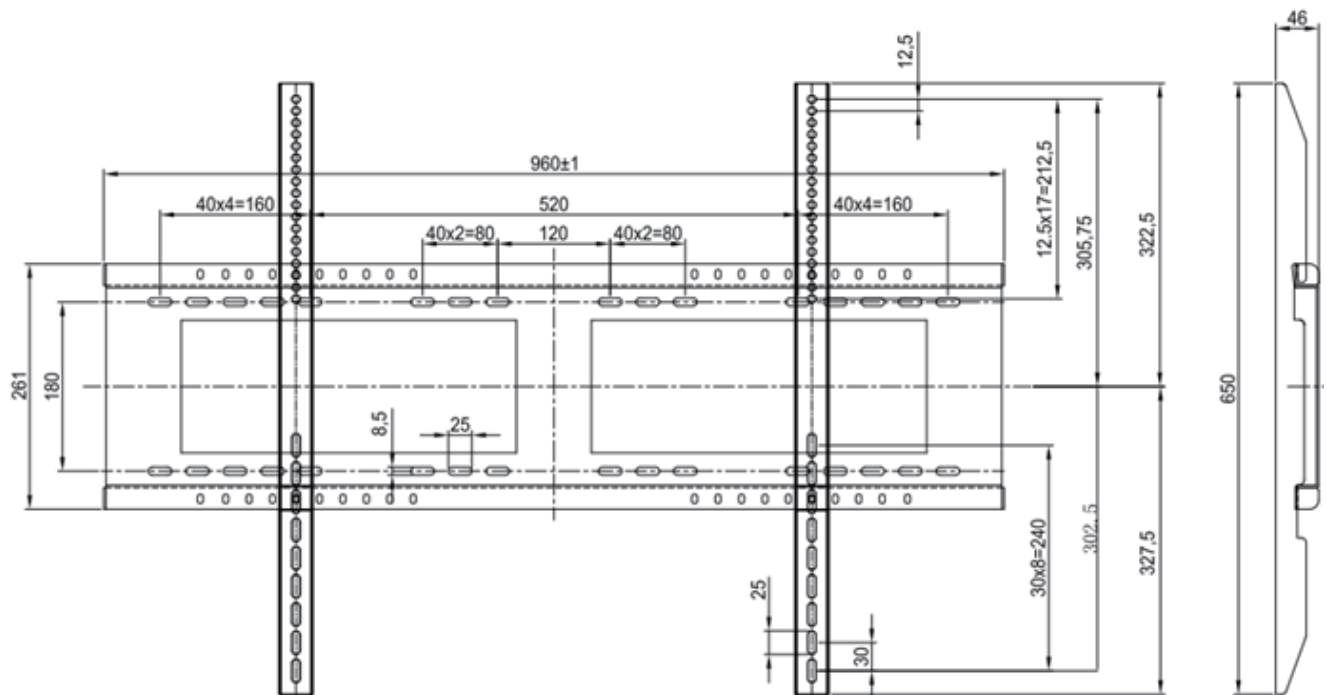

> Installation Environment Attention

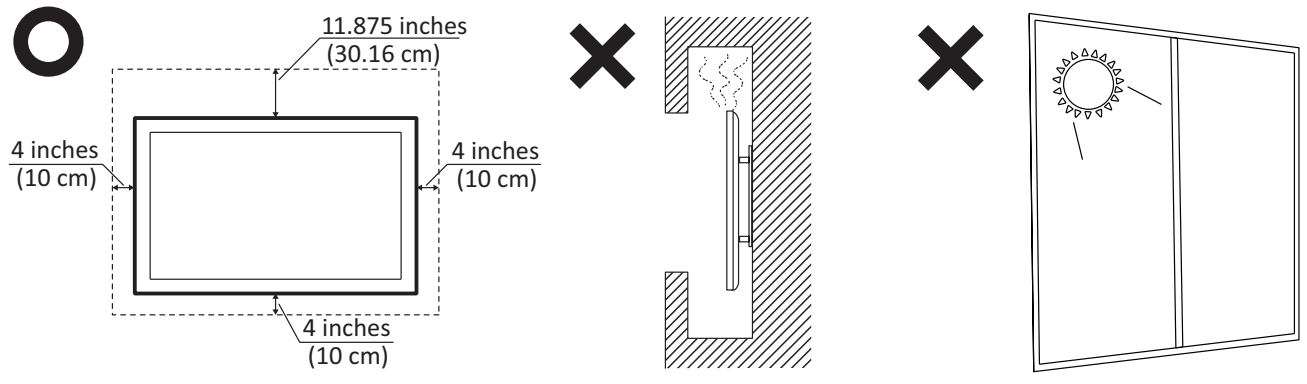

> Control Panel Overview

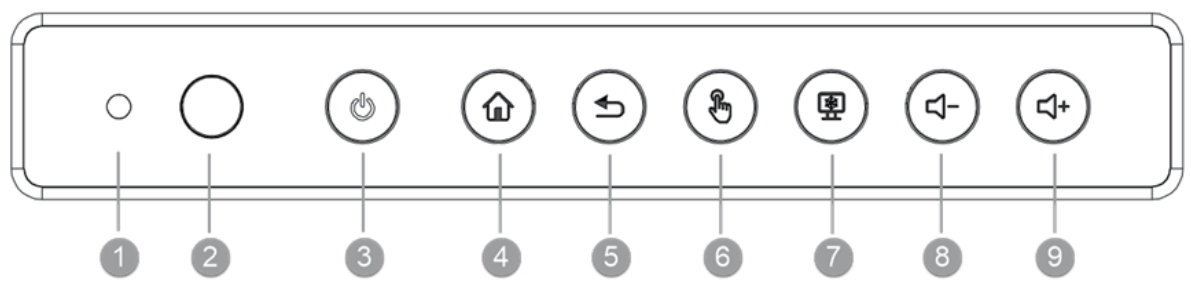

Item	Description
1	Ambient light Sensor to monitor the ambient light
2	Remote control receiver
3	Power indicator light Press the key to turn on the device Press the key to turn off/on the display backlight only Press and hold the key to turn off the device
4	Back to ViewBoard player main interface
5	Return to ViewBoard player previous level
6	Disable/enable the touch screen
7	Freeze current image on the screen
8	Decrease Volume
9	Increase Volume

> Remote Control Overview

- 1 Power on/off
- 2 Screen capture
- 3 *PC: "Windows" button
- 4 Startup Writing
- 5 Back to Embedded player Home Screen
- 6 Back / Return to previous page
- 7 Increase / Decrease volume
- 8 Numbers Keypad
- 9 Information
- 10 Input source selection
- 11 Media control button
Red: PLAY/PAUSE
Green: STOP
Yellow: FORWARD
Blue: BACKWARD
- 12 *PC: "Menu" button
- 13 *PC: Exit dialog box
- 14 Setting menu
- 15 Up/Down/Right/Left/OK Keys
- 16 Freeze Screen
- 17 Mute / Unmute
- 18 Increase / Decrease brightness
*PC: Page Up / Page Down
- 19 Blank Screen
- 20 Adjust aspect ratio

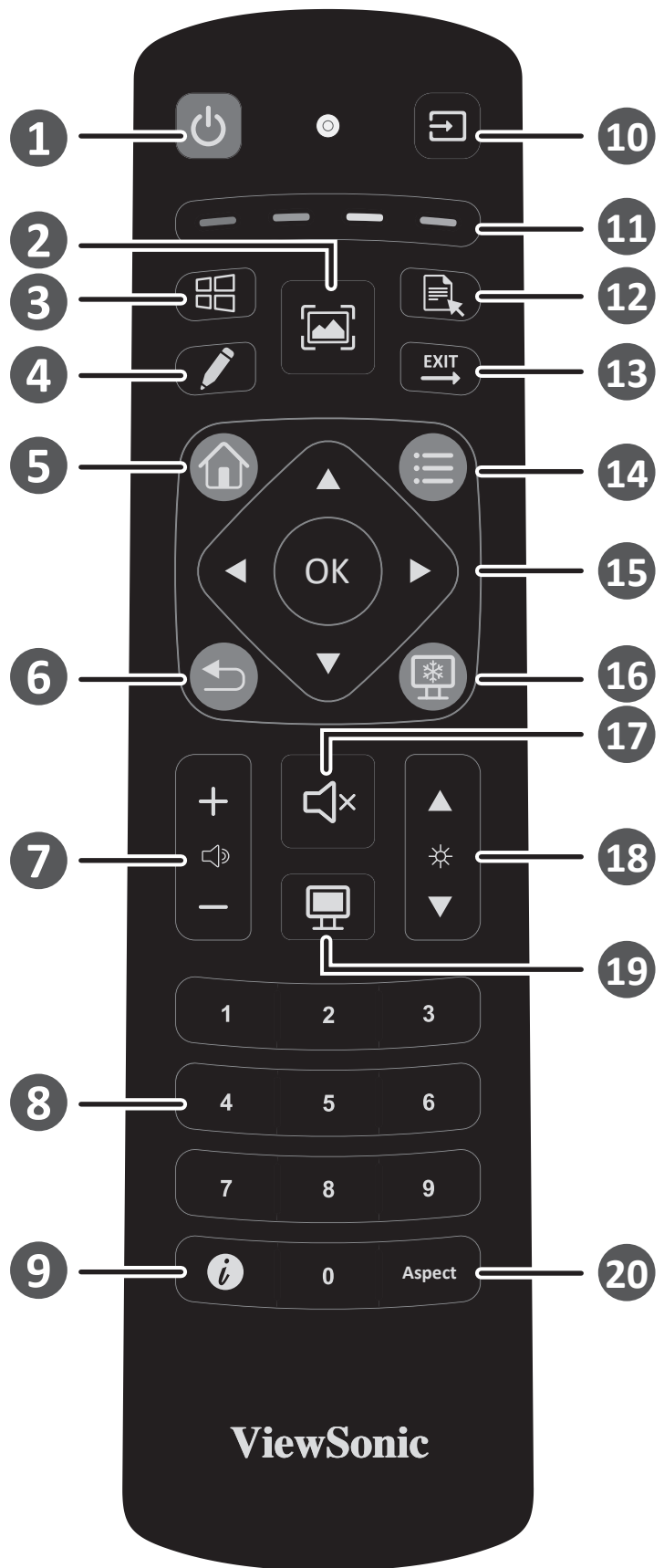

*PC button: Not all models support these functions

> I/O port

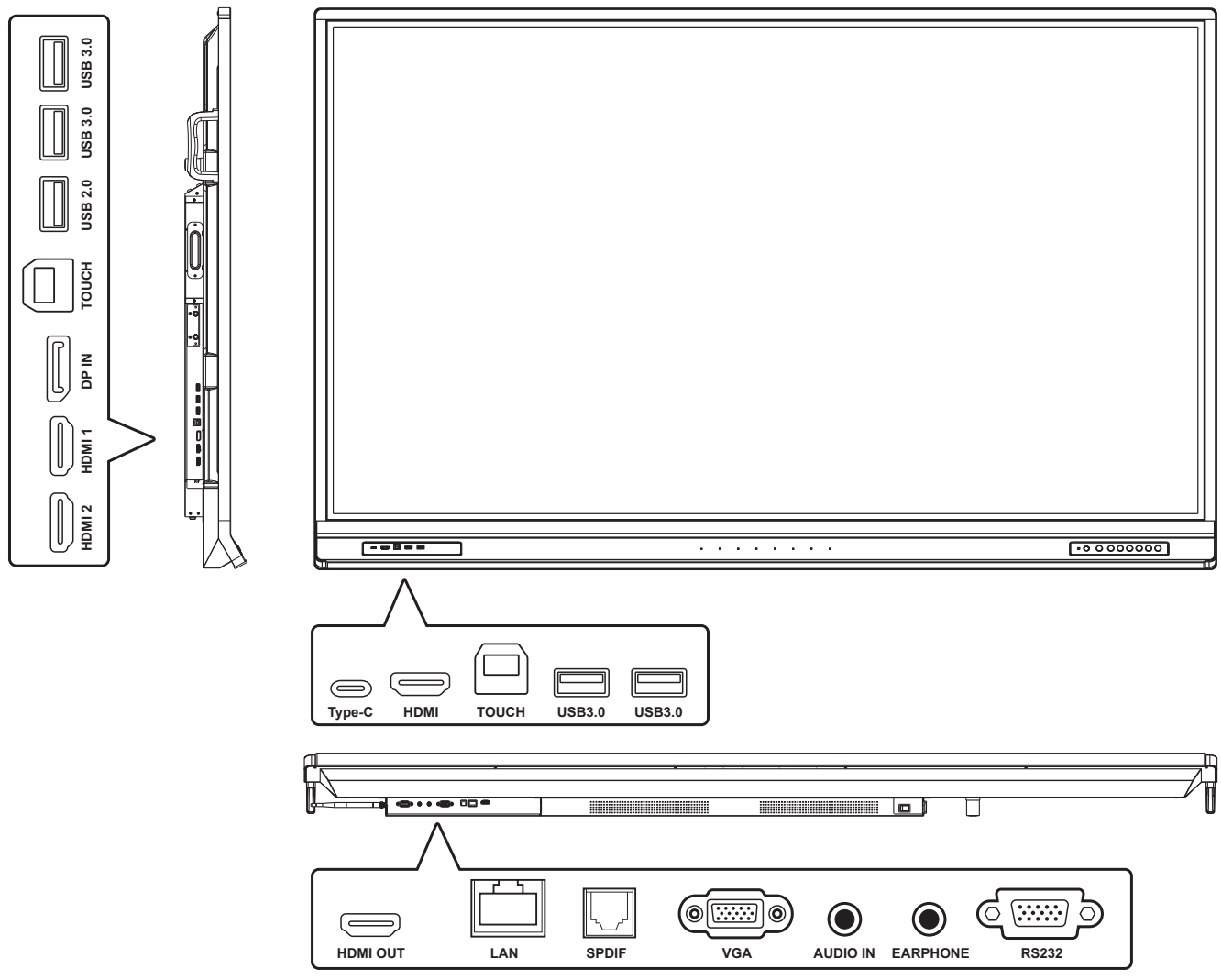

> USB and Networking Connections

Just like any PC, it is easy to connect various USB devices and other peripherals to your ViewBoard.

USB Peripherals

Plug the USB device cable into the USB port.

Networking and Modem cables

Plug the router cable into the LAN port.

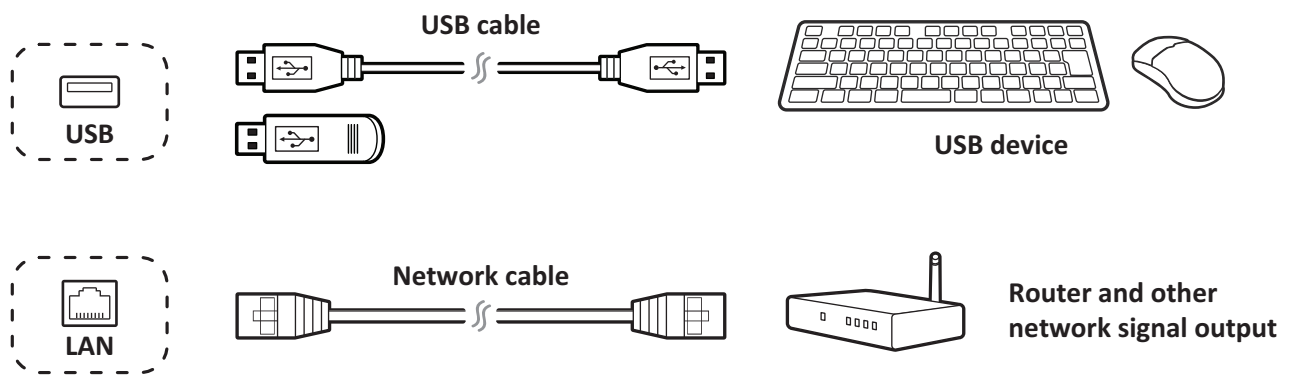

> Connecting External Devices and Touch Connection

Your external device(s) can be connected in any of the following configurations:

Type C Connection

Connect a Type C cable from your external device to the Type C port on the ViewBoard.

DisplayPort Connection

1. Connect a DisplayPort cable from your external device to the DisplayPort port on the ViewBoard.
2. Connect a USB cable to the external device from the TOUCH port of the ViewBoard.

HDMI Connection

1. Connect an HDMI cable from your external device to the HDMI IN port on the ViewBoard.
2. Connect a USB cable to the external device from the TOUCH port of the ViewBoard.

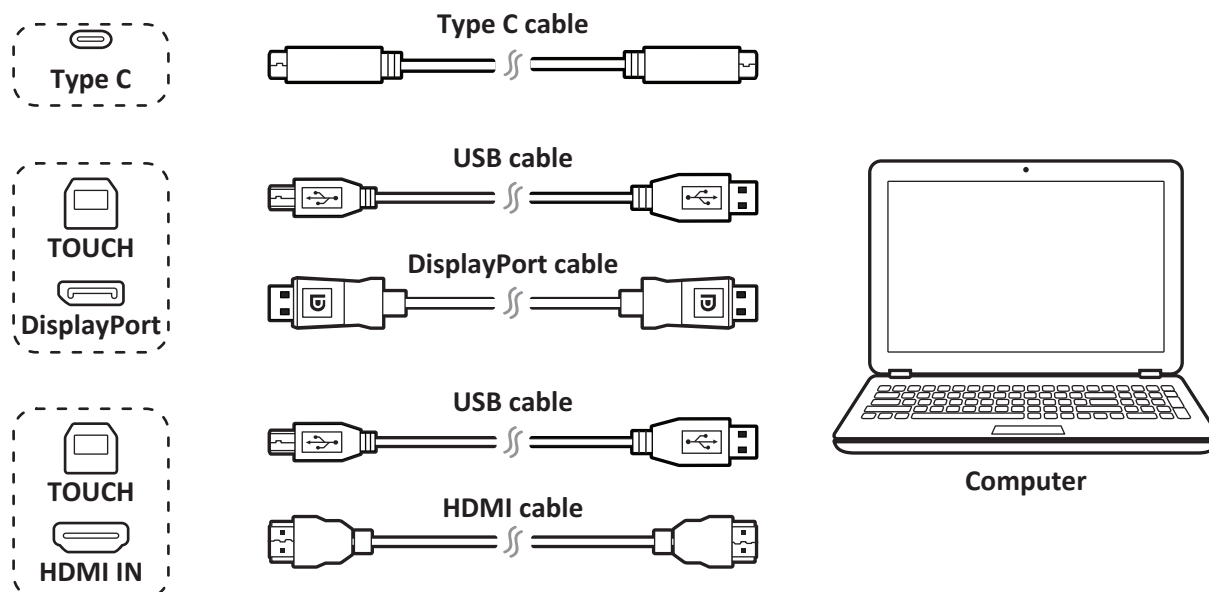

> RS232 Connections

When you use an RS232 serial port cable to connect your display to an external computer, certain functions can be controlled by the PC, including power on/off, volume adjustment and more.

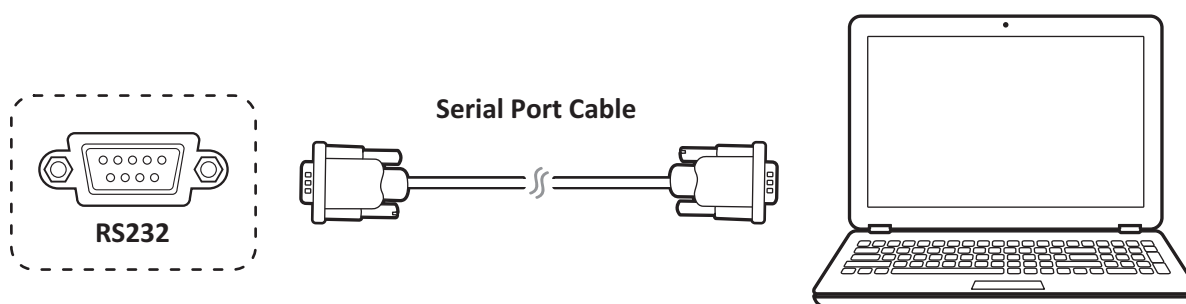

> Media Player (Audio and Video) Connection

To connect to a media player:

1. Connect the HDMI cable to the HDMI ports on your ViewBoard and peripheral device.
2. Plug in the power cord of your ViewBoard, and turn on the rear-panel power supply switch.
3. Press the Power button on the right-hand side of the ViewBoard to turn the screen on.
4. Press the INPUT button on the remote control and switch to the "HDMI" input source.

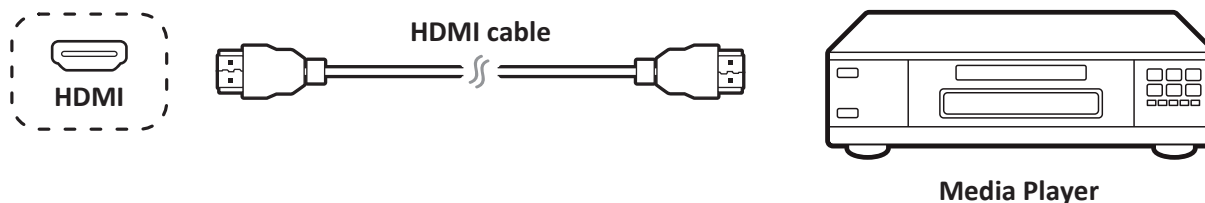

> SPDIF Connection

To connect to an external sound system:

1. Connect an optical cable from the SPDIF port to your sound system's optical connector.
2. Plug in the power cord of your ViewBoard, and turn on the rear-panel power supply switch.
3. Press the Power button on the right-hand side of the ViewBoard to turn the screen on.

Note: S/PDIF & Earphone audio output are working on ViewBoard Player, HDMI, and DP channel only.

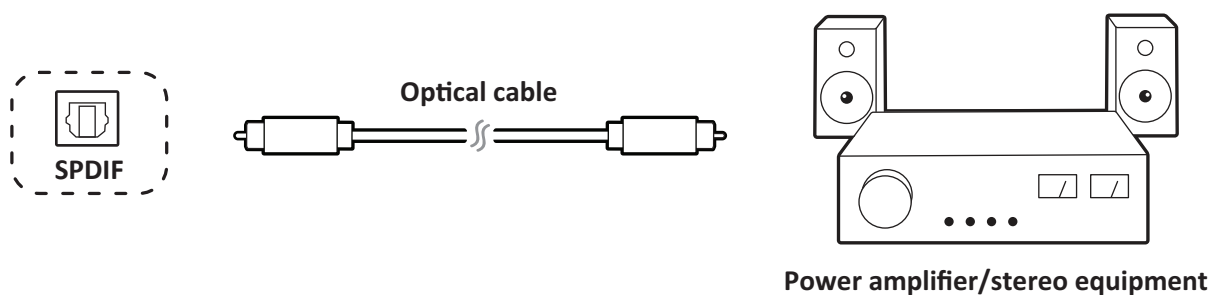

> Video Output Connection

To output video via a display device:

1. Connect an HDMI cable to the HDMI IN port of your display device, and the other end to the HDMI OUT port of your ViewBoard.
2. For audio, connect one end of an audio cable to your ViewBoard's EARPHONE port and the other end to your speakers.
3. Plug in the power cord of your ViewBoard, and turn on the rear-panel power supply switch.
4. Press the Power button on the right-hand side of the ViewBoard to turn the screen on.

Note: S/PDIF & Earphone audio output are working on ViewBoard Player, HDMI, and DP channel only.

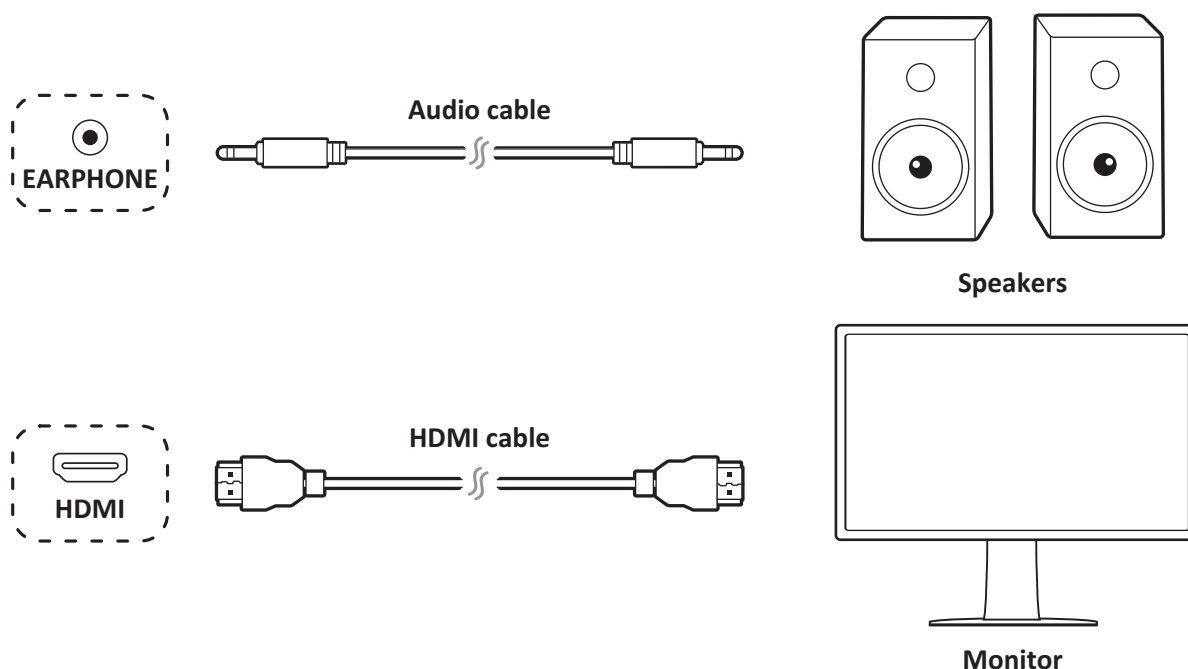

> Start to Use

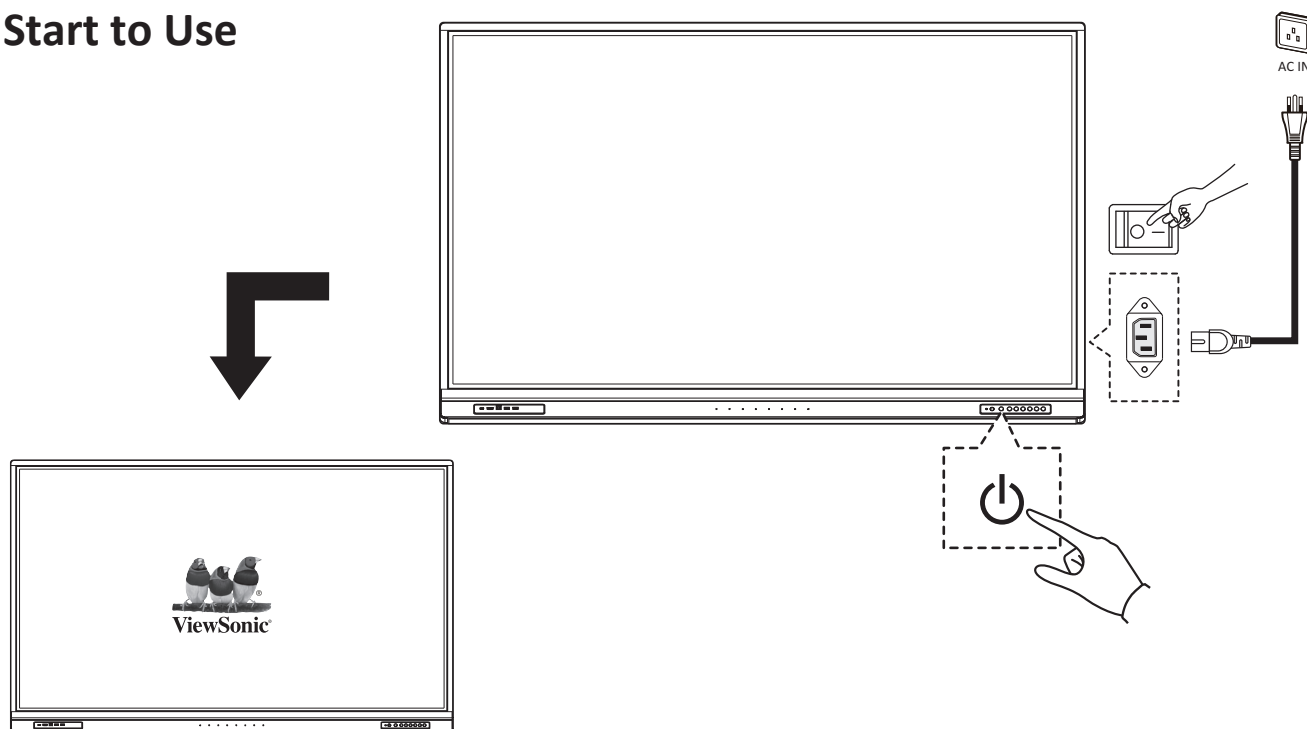



> Compliance Statement

FCC Compliance Statement: This device complies with part 15 of FCC Rules. Operation is subject to the following two conditions: (1) this device may not cause harmful interference, and (2) this device must accept any interference received, including interference that may cause undesired operation.

Industry Canada ICES-003 Compliance: CAN ICES-3 (B)/NMB-3(B)



ViewSonic Corporation (US/Canada/Latin America)

 : www.viewsonic.com/support/product-registration



United States

 1-800-688-6688

 customerservice@viewsonic.com

Canada

 1-866-463-4775

 customerservice@viewsonic.com

Puerto Rico & Virgin Islands

 <http://www.viewsonic.com/la/soporte/servicio-tecnico> (Español)

Latin America

 <http://www.viewsonic.com/la/soporte/servicio-tecnico-la/>



ViewSonic Europe Ltd.

 : www.viewsoniceurope.com

 +44 (0) 207 382 8251



Europe

 <http://www.viewsoniceurope.com/eu/support/call-desk/>



ViewSonic Support Center



Optional Accessory

➤ Obsah balení

- Kabel HDMI (10ft/3m)
- Kabel Type-c (5ft/1.5m)
- Kabel USB pro dotykové ovládání (10ft/3m)
- Svorka x 5
- Deska webové kamery
- Baterie AAA x 2
- Dotykové pero x 2
- Dálkové ovládání
- Guma
- Šrouby webové kamery x 4 (M4x7mm x2, M3x6mm x2)
- Průvodce rychlým spuštěním
- Prohlášení o shodě
- Adaptér RS232
- Napájecí kabel (dodáván podle oblasti)
- Šrouby pro nástěnnou montáž x 4 (M8x20mm x4)

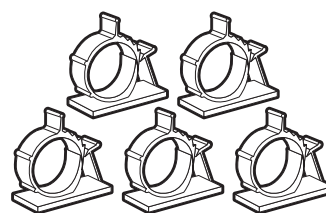
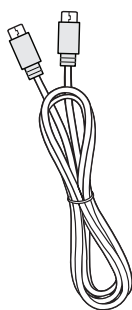
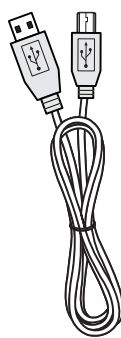
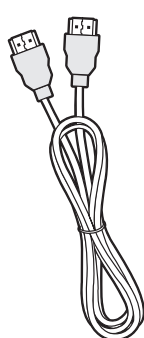
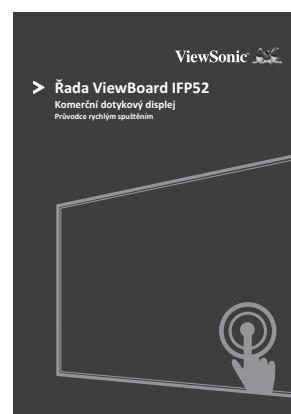
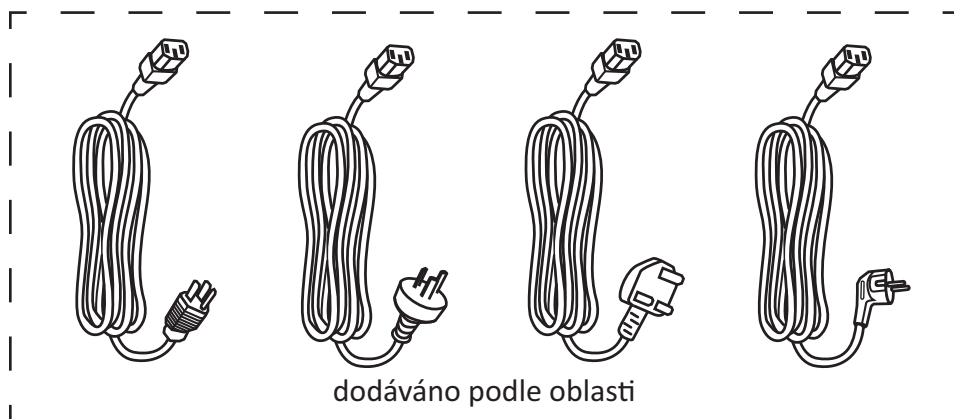

M8 X 4



M3 X 2



M4 X 2

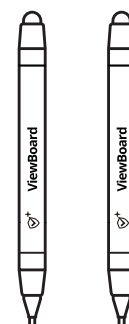
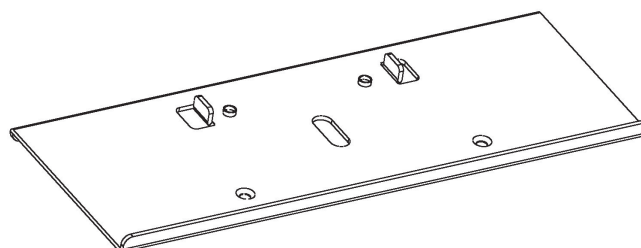
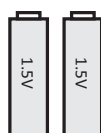
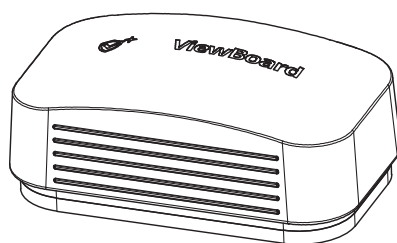

➤ Technické údaje nástěnného držáku (prodáno samostatně)

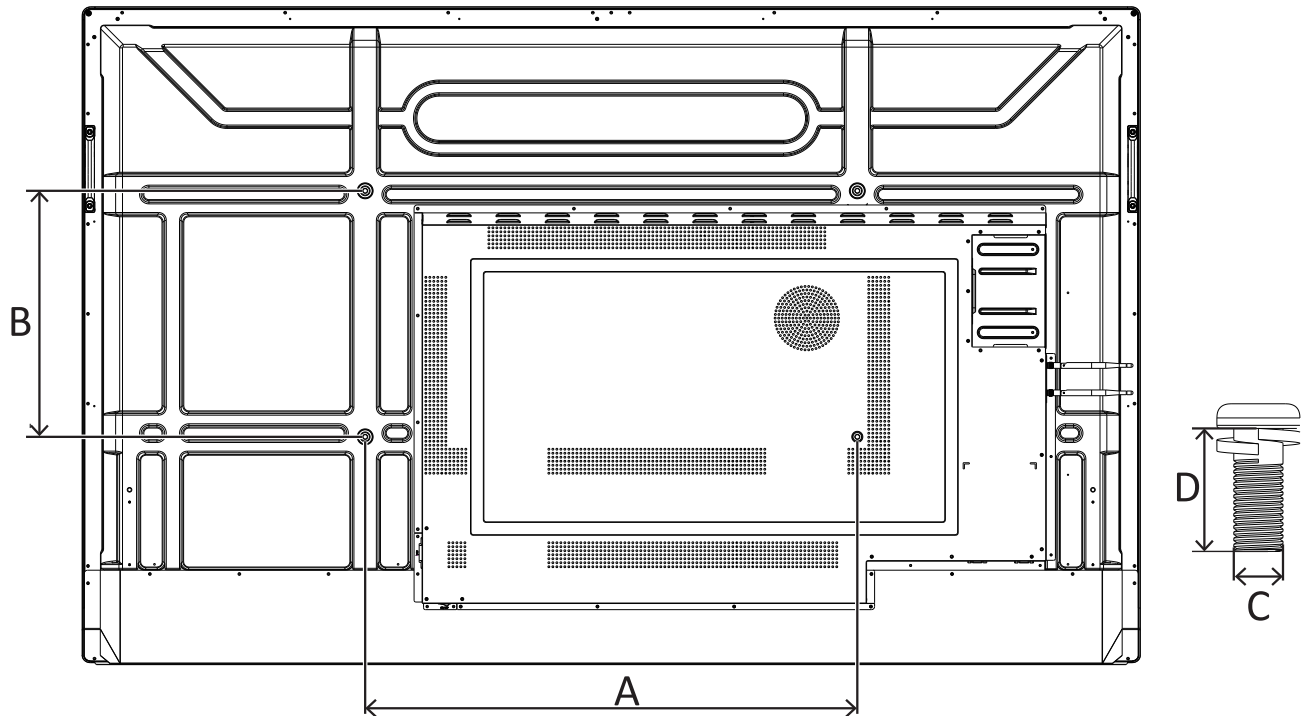

palce	Specifikace VESA (A x B)	Standardní šroub (C x D)	Množství
Řada IFP6552	600 x 400 mm	M8 x 20 mm	4
Řada IFP7552	800 x 400 mm	M8 x 20 mm	4
Řada IFP8652	800 x 600 mm	M8 x 20 mm	4

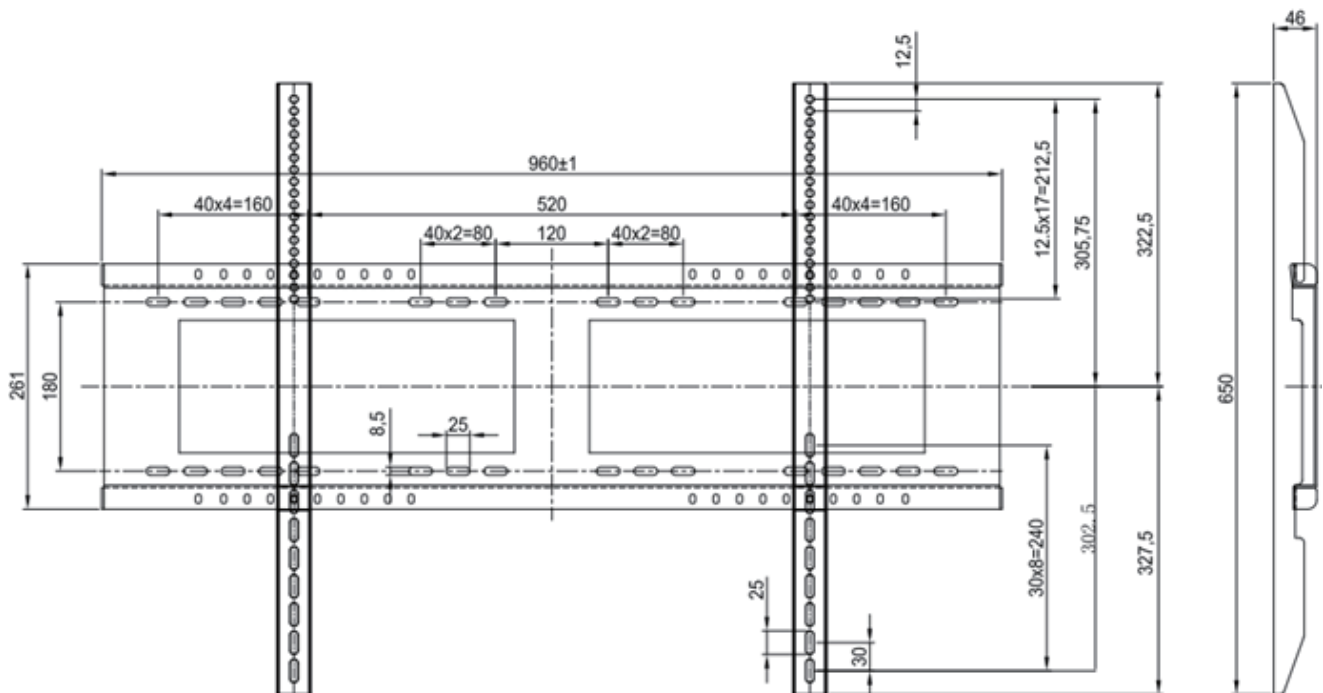

> Upozornění k instalačnímu prostředí

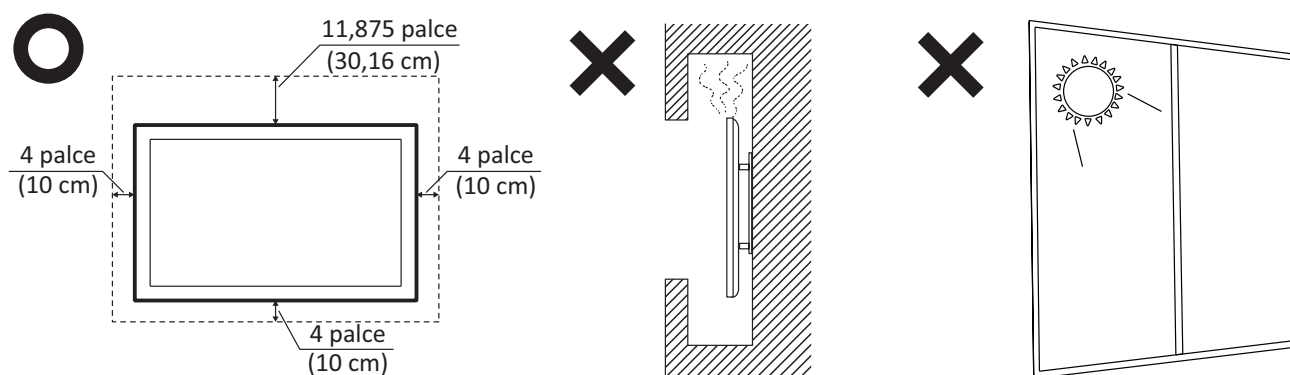

> Přehled ovládacího panelu

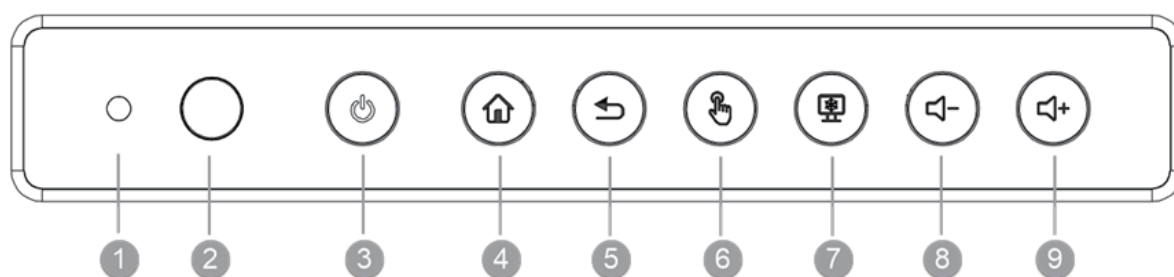

Položka	Popis
1	Senzor okolního osvětlení
2	Přijímač dálkového ovládání
3	Kontrolka napájení Stisknutím tohoto tlačítka zapnete zařízení Stisknutím tohoto tlačítka vypnete/zapnete pouze podsvícení displeje Stisknutím a podržením tohoto tlačítka vypnete zařízení
4	Slouží k návratu na hlavní rozhraní přehrávače ViewBoard
5	Slouží k návratu na předchozí úroveň přehrávače ViewBoard
6	Slouží k vypnutí/zapnutí dotykové obrazovky
7	Zmrazí aktuální obraz na obrazovce
8	Slouží ke snížení hlasitosti
9	Slouží ke zvýšení hlasitosti

> Přehled dálkového ovládání

- 1 Zapnutí/vypnutí napájení
- 2 Zachycení obrazu
- 3 *PC: Tlačítko „Windows“
- 4 Psaní po spuštění
- 5 Zpět na domovskou obrazovku vestavěného přehrávače
- 6 Zpět/návrat na předchozí stránku
- 7 Zvýšení/snížení hlasitosti
- 8 Číselná klávesnice
- 9 Informace
- 10 Výběr vstupního zdroje
- 11 Tlačítko ovládání médií
Červená: PŘEHRÁT/POZASTAVIT
Zelená: ZASTAVIT
Žlutá: DOPŘEDU
Modrá: DOZADU
- 12 *PC: Tlačítko „Nabídka“
- 13 *PC: Zavřít dialogové okno
- 14 Nabídka nastavení
- 15 Tlačítka nahoru/dolů/doprava/doleva/OK
- 16 Zmrazení obrazu
- 17 Vypnout/zapnout zvuk
- 18 Zvýšit/snížit jas
*PC: O stránku nahoru/dolů
- 19 Prázdná obrazovka
- 20 Úpravy poměru stran

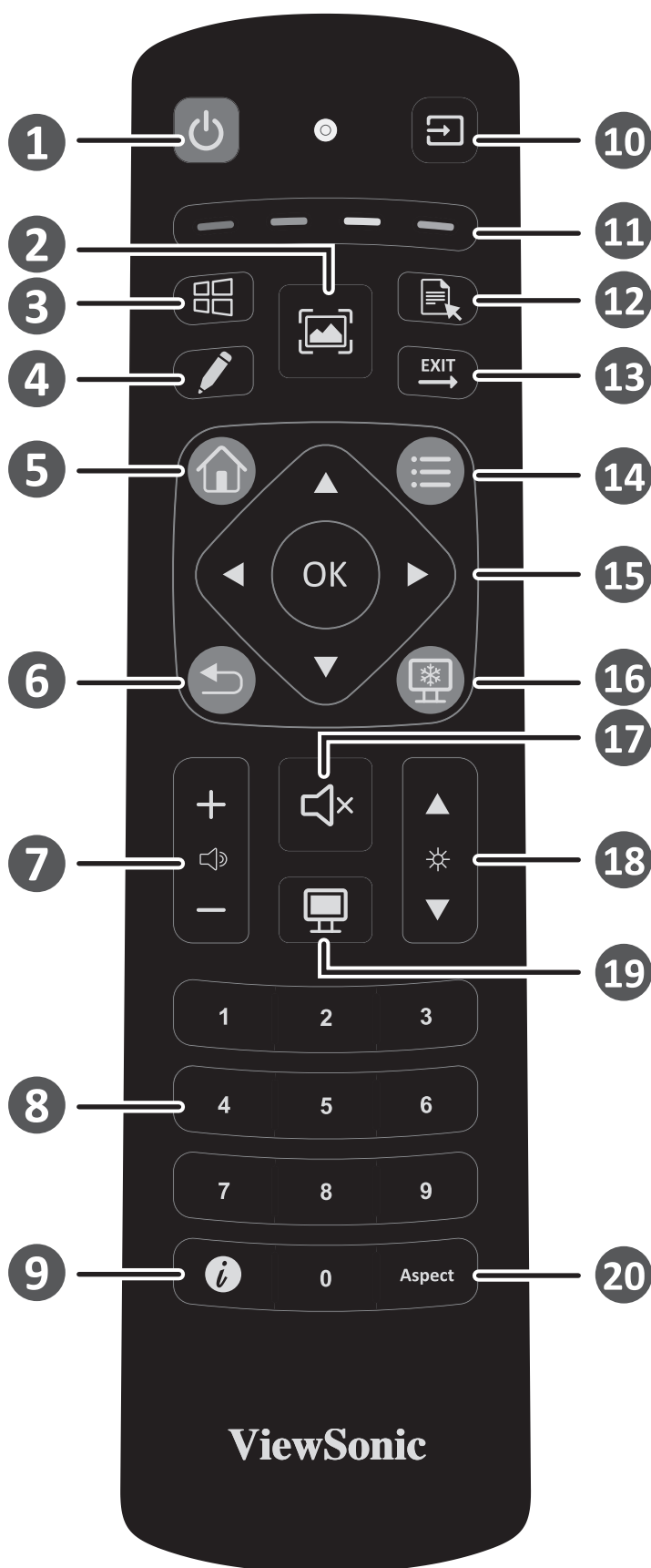

*Tlačítko PC: Některé modely tyto funkce nepodporují

➤ Vstupně/výstupní port

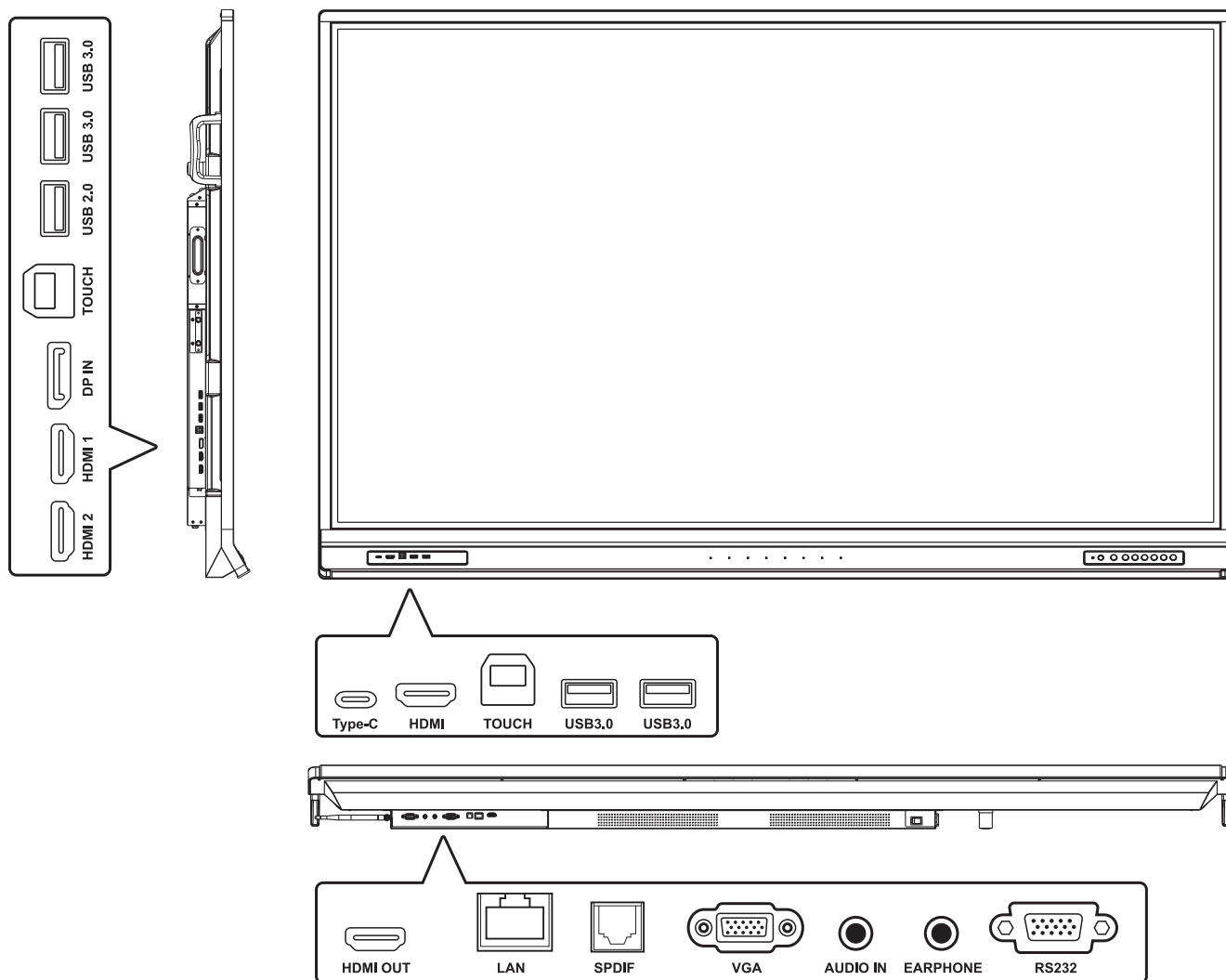

➤ USB a síťová připojení

K zařízení ViewBoard lze snadno připojovat různá zařízení USB a další periférie, podobně jako u každého počítače.

Periférie USB

Připojte kabel zařízení USB k portu USB.

Síťové a modemové kabely

Připojte kabel routeru k portu LAN.

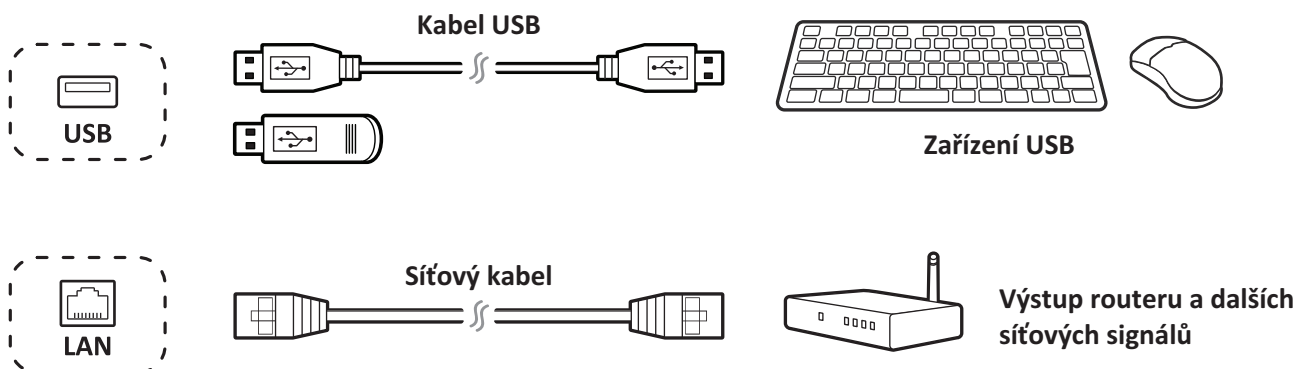

> Připojení externích zařízení a dotykové připojení

Vaše externí zařízení lze připojit následujícími způsoby:

Připojení Type C

Připojte kabel Type C z externího zařízení k portu Type C na zařízení ViewBoard.

Připojení DisplayPort

1. Připojte kabel DisplayPort z externího zařízení k portu DisplayPort na zařízení ViewBoard.
2. Připojte kabel USB k externímu zařízení z portu TOUCH na zařízení ViewBoard.

Připojení HDMI

1. Připojte kabel HDMI z externího zařízení k portu HDMI IN na zařízení ViewBoard.
2. Připojte kabel USB k externímu zařízení z portu TOUCH na zařízení ViewBoard.

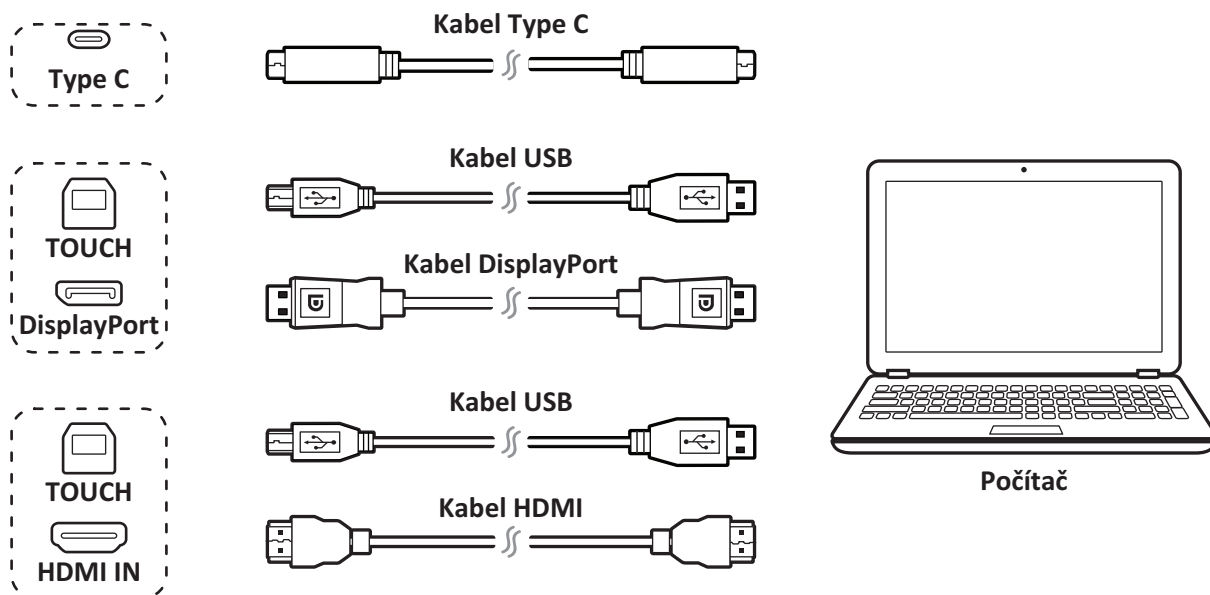

> Připojení RS232

Když propojíte monitor s externím počítačem pomocí kabelu sériového portu RS232, lze ovládat některé funkce dálkově z počítače, včetně zapnutí/vypnutí napájení, nastavení hlasitosti a dalších.

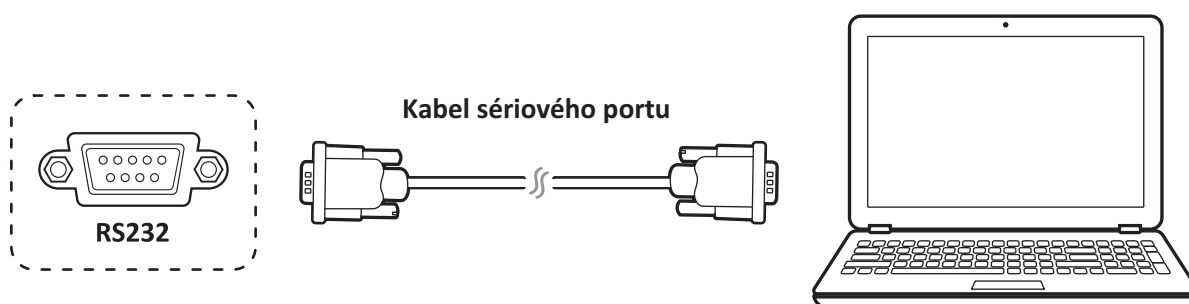

> Připojení přehrávače médií (zvuk a video)

Pokyny pro připojení k přehrávači médií:

1. Připojte kabel HDMI k portům HDMI na zařízení ViewBoard a periferním zařízení.
2. Připojte napájecí kabel zařízení ViewBoard k elektrické zásuvce a zapněte vypínač na zadním panelu.
3. Stisknutím tlačítka Napájení na pravé straně zařízení ViewBoard zapněte obrazovku.
4. Stiskněte tlačítko INPUT na dálkovém ovladači a přepněte na vstupní zdroj „HDMI“.

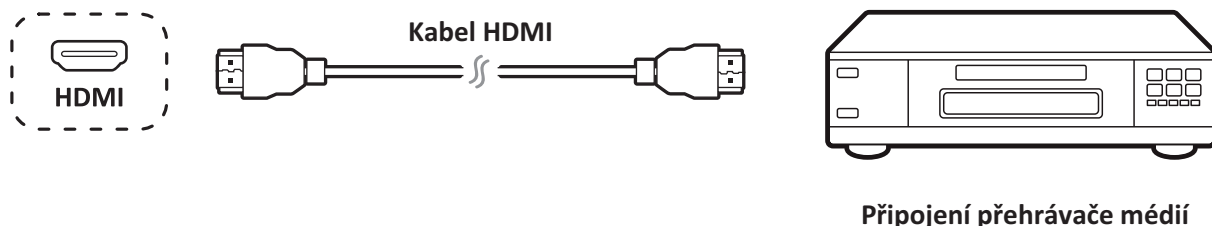

> Připojení SPDIF

Pokyny pro připojení k externímu zvukovému systému:

1. Připojte optický kabel z portu SPDIF k optickému konektoru zvukového systému.
2. Připojte napájecí kabel zařízení ViewBoard k elektrické zásuvce a zapněte vypínač na zadním panelu.
3. Stisknutím tlačítka Napájení na pravé straně zařízení ViewBoard zapněte obrazovku.

Poznámka: Zvukový výstup S/PDIF a výstup pro sluchátka fungují pouze na kanálu ViewBoard Player, HDMI a DP.

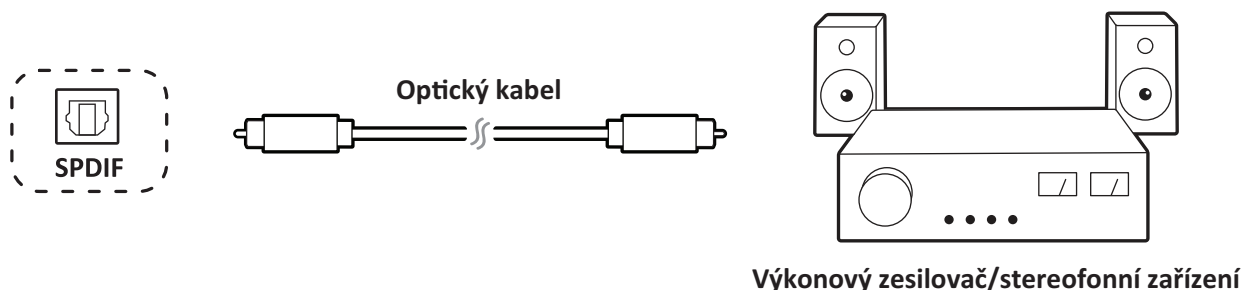

> Připojení výstupu videa

Pokyny pro zajištění výstupu videa prostřednictvím zobrazovacího zařízení:

1. Připojte kabel HDMI k portu HDMI IN vašeho zobrazovacího zařízení a druhý konec k portu HDMI OUT na zařízení ViewBoard.
2. Pro zajištění zvuku připojte jeden konec kabelu zvuku k portu EARPHONE na zařízení ViewBoard a druhý konec k reproduktorům.
3. Připojte napájecí kabel zařízení ViewBoard k elektrické zásuvce a zapněte vypínač na zadním panelu.
4. Stisknutím tlačítka Napájení na pravé straně zařízení ViewBoard zapněte obrazovku.

Poznámka: Zvukový výstup S/PDIF a výstup pro sluchátka fungují pouze na kanálu ViewBoard Player, HDMI a DP.

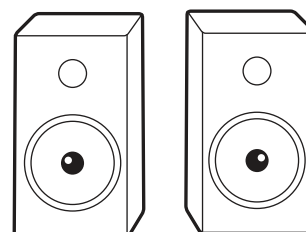
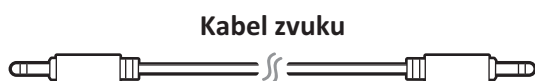

Reproduktory

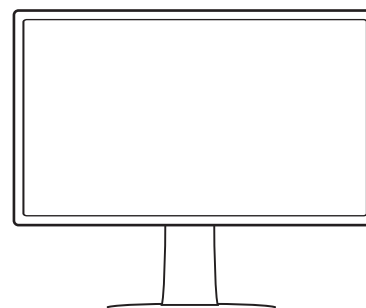

> Zahájení používání

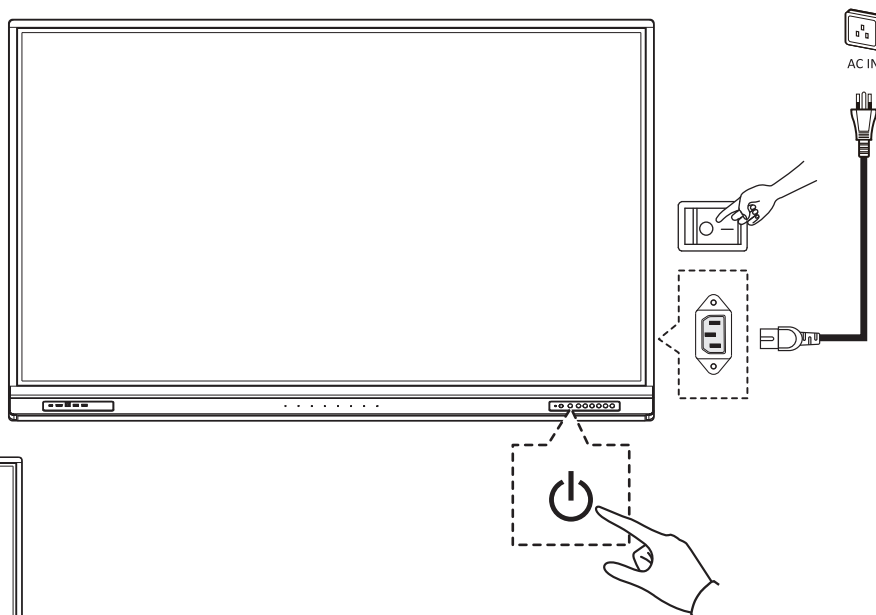
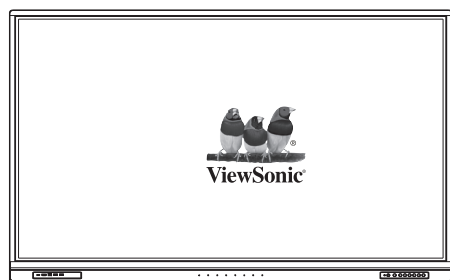



> Prohlášení o shodě

Prohlášení o shodě FCC: Toto zařízení splňuje podmínky části 15 směrnic FCC. Provoz vyžaduje splnění následujících dvou podmínek: (1) toto zařízení nesmí způsobit nežádoucí rušení signálu, (2) toto zařízení musí akceptovat jakékoli vnější rušení včetně rušení, které by způsobilo nežádoucí činnost.

Shoda se standardem Industry Canada ICES-003: CAN ICES-3 (B)/NMB-3(B)



ViewSonic Corporation (USA/Kanada/Latinská Amerika)

 : www.viewsonic.com/support/product-registration



Spojené státy

 1-800-688-6688

 customerservice@viewsonic.com

Kanada

 1-866-463-4775

 customerservice@viewsonic.com

Portoriko a Panenské ostrovy

 <http://www.viewsonic.com/la/soporte/servicio-tecnico> (Español)

Latinská Amerika

 <http://www.viewsonic.com/la/soporte/servicio-tecnico-la/>



ViewSonic Europe Ltd.

 : www.viewsoniceurope.com

 +44 (0) 207 382 8251



Europe

 <http://www.viewsoniceurope.com/eu/support/call-desk/>



► Pakkens indhold

- HDMI-kabel (10ft/3m)
- Type-C-kabel (5ft/1.5m)
- USB-kabel til touch (10ft/3m)
- Klemme x 5
- Plade til webkamera
- AAA-batteri x 2
- Touch-pen x 2
- Fjernbetjening
- Viskelæder
- Skruer til webkamera x 4 (M4x7mm x2, M3x6mm x2)
- Startvejledning
- Overensstemmelseserklæring
- RS232-adapter
- Strømkabel (sendes efter region)
- Skruer til vægophæng x 4 (M8x20mm x4)

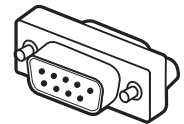
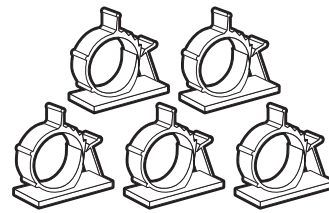
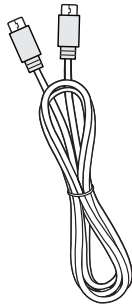
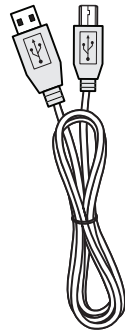
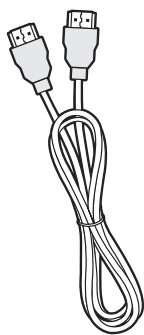
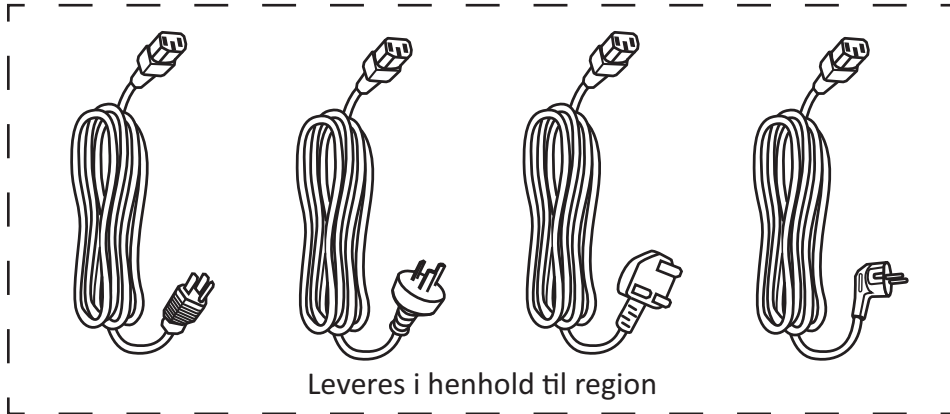

M8 X 4



M3 X 2



M4 X 2

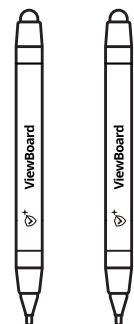
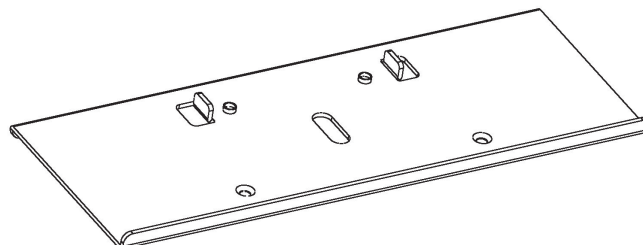
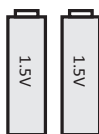
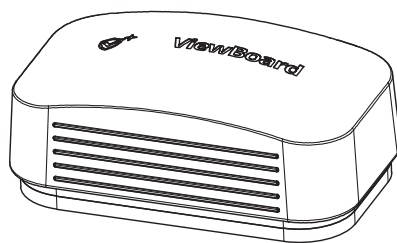

➤ Specifikationer til vægophænget (solgt separat)

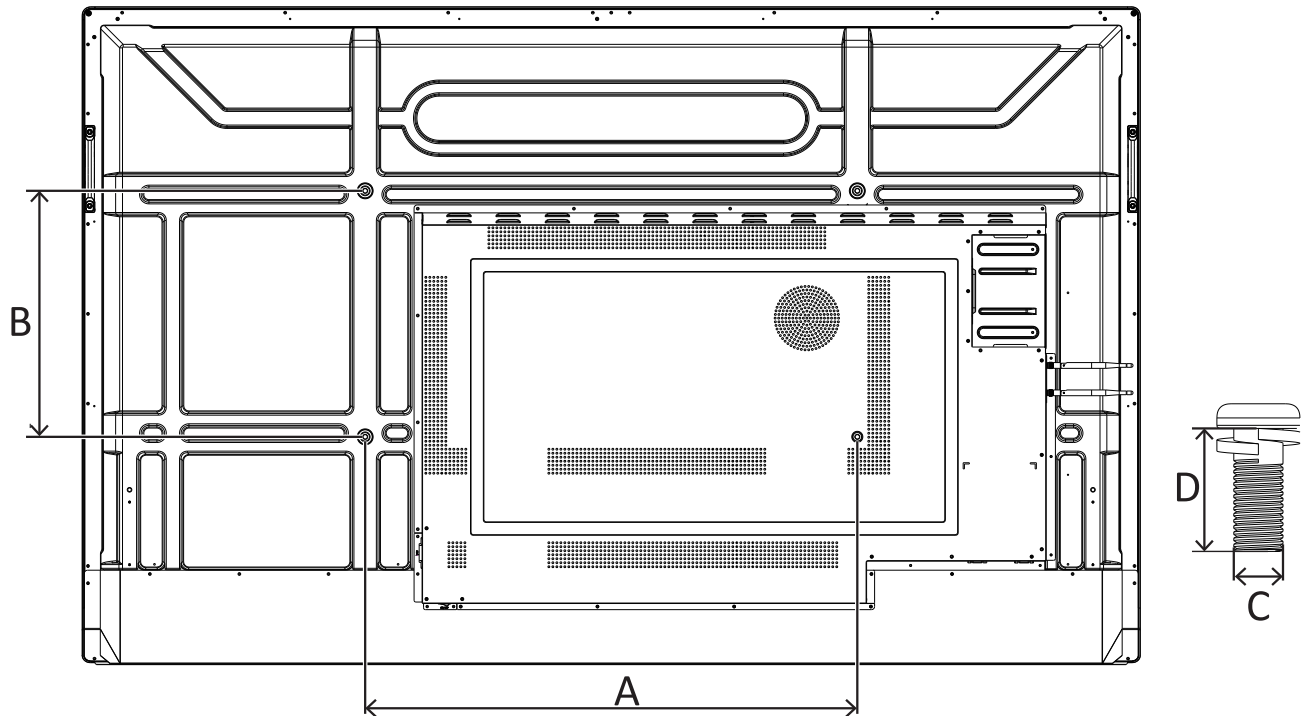

tommer	VESA-specifikation (A x B)	Standardskrue (C x D)	Antal
IFP6552-serien	600 x 400 mm	M8 x 20 mm	4
IFP7552-serien	800 x 400 mm	M8 x 20 mm	4
IFP8652-serien	800 x 600 mm	M8 x 20 mm	4

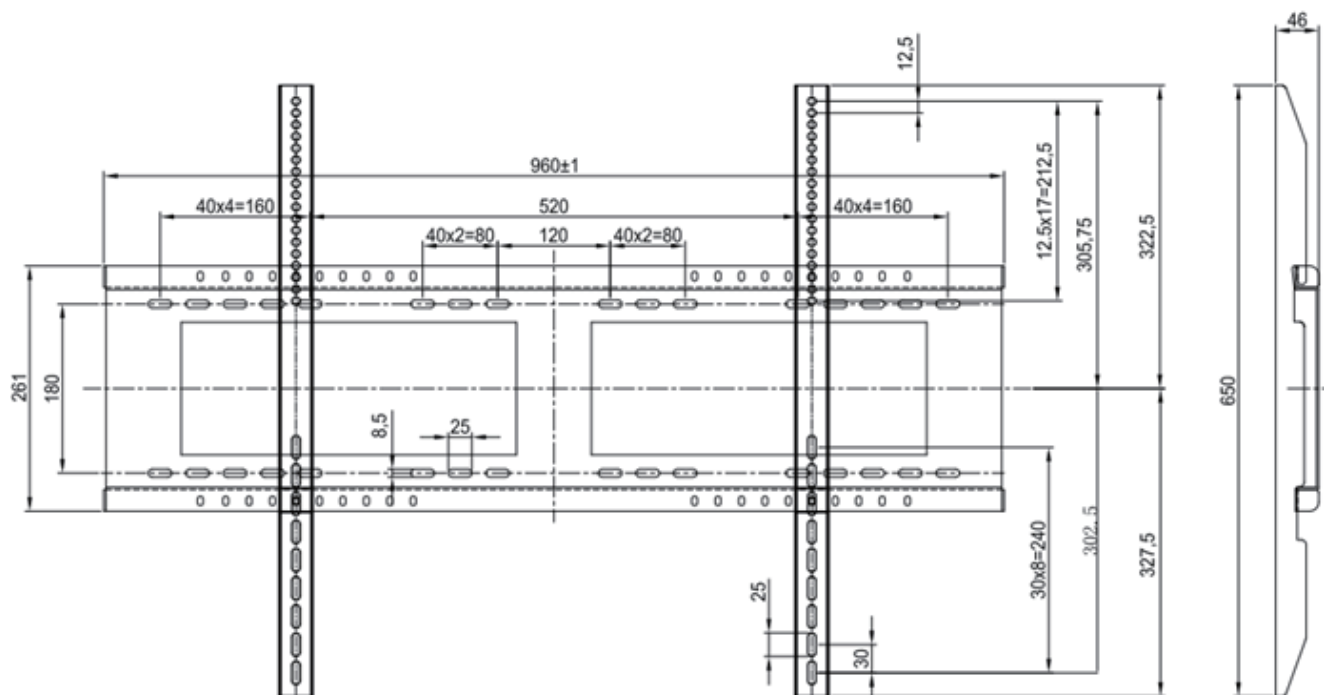

> Miljømæssige oplysninger vedrørende installeringen

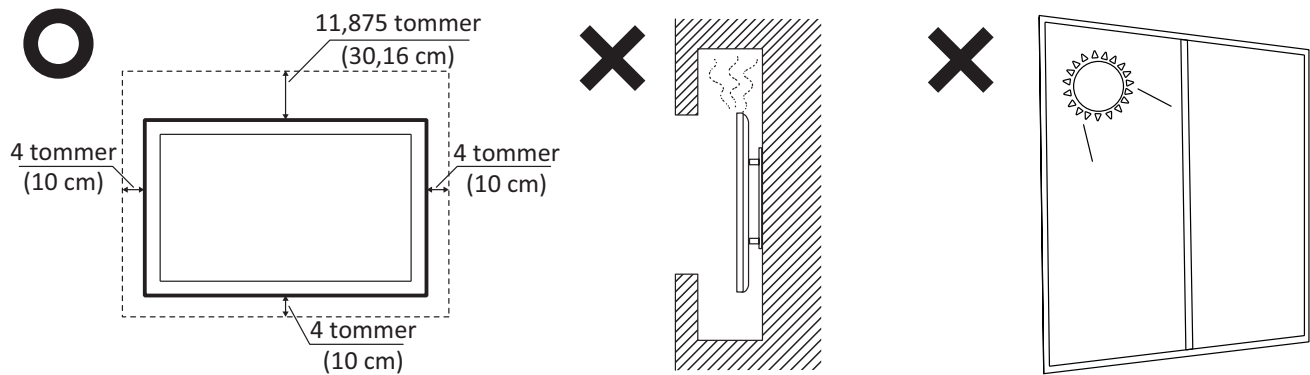

> Oversigt over betjeningspanelet

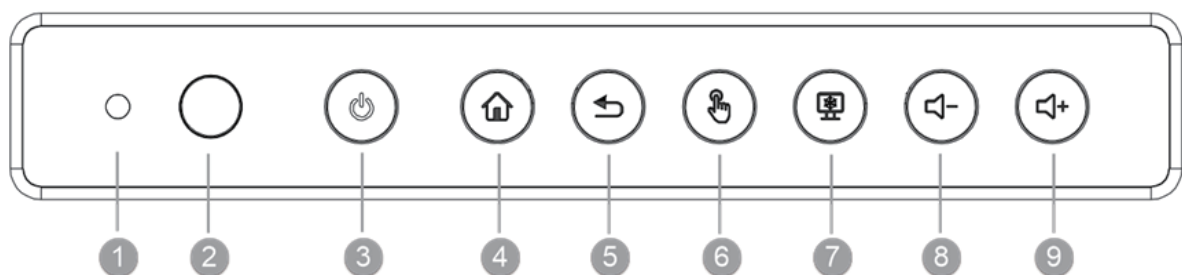

Punkt	Beskrivelse
1	Omgivende lyssensor til overvågning af det omgivende lys
2	Modtageren til fjernbetjening
3	Strømindikator Tryk på knappen for, at tænde enheden Tryk på knappen for kun at slukke/tænde skærmens baggrundslys Hold knappen nede, for at slukke enheden
4	Tilbage til hovedgrænsefladen i ViewBoard-afspilleren
5	Gå tilbage til forrige niveau i ViewBoard-afspilleren
6	Deaktiver/aktiver berøringsskærmen
7	Fastfrys aktuelle billedet på skærmen
8	Skru ned for lydstyrken
9	Skruer op for lydstyrken

> Oversigt over fjernbetjeningen

- 1 Tænd/sluk
- 2 Skærmoptagelse
- 3 *PC: "Windows" knap
- 4 Skrivning ved opstart
- 5 Tilbage til startskærmen på indlejret afspiller
- 6 Tilbage/Gå tilbage til forrige side
- 7 Skru op/ned for lydstyrken
- 8 Taltastatur
- 9 Information
- 10 Valg af indgangskilde
- 11 Mediestyringsknap
Rød: AFSPIL/PAUSE
Grøn: STOP
Gul: FREM
Blå: TILBAGE
- 12 *PC: "Menu" knap
- 13 *PC: Afslut dialogboksen
- 14 Indstillingsmenu
- 15 Tasterne Op/Ned/Højre/Venstre/OK
- 16 Frys skærm
- 17 Slå lyden til og fra
- 18 Skru op/ned for lysstyrken
*PC: Side op/Side ned
- 19 Blank skærm
- 20 Juster billedforhold

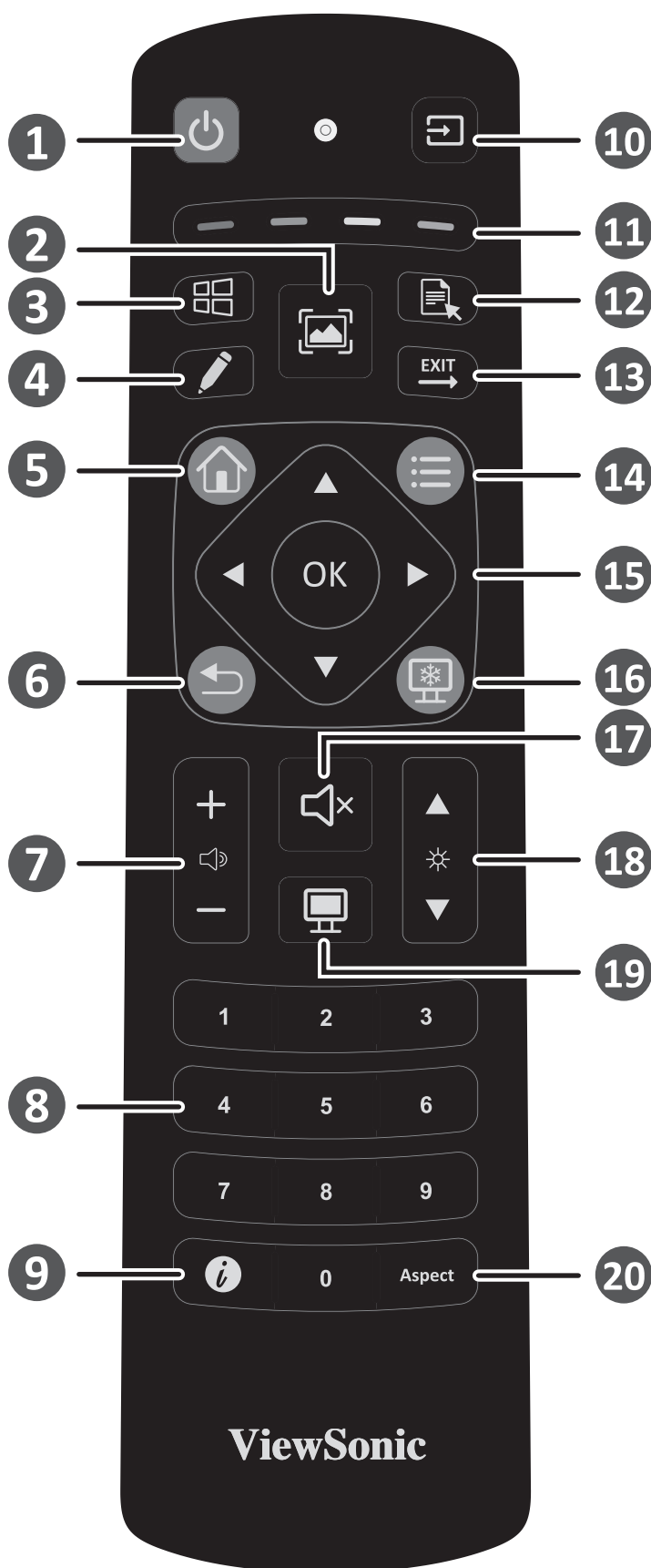

*PC-knap: Ikke alle modeller understøtter disse funktioner

> I/O-port

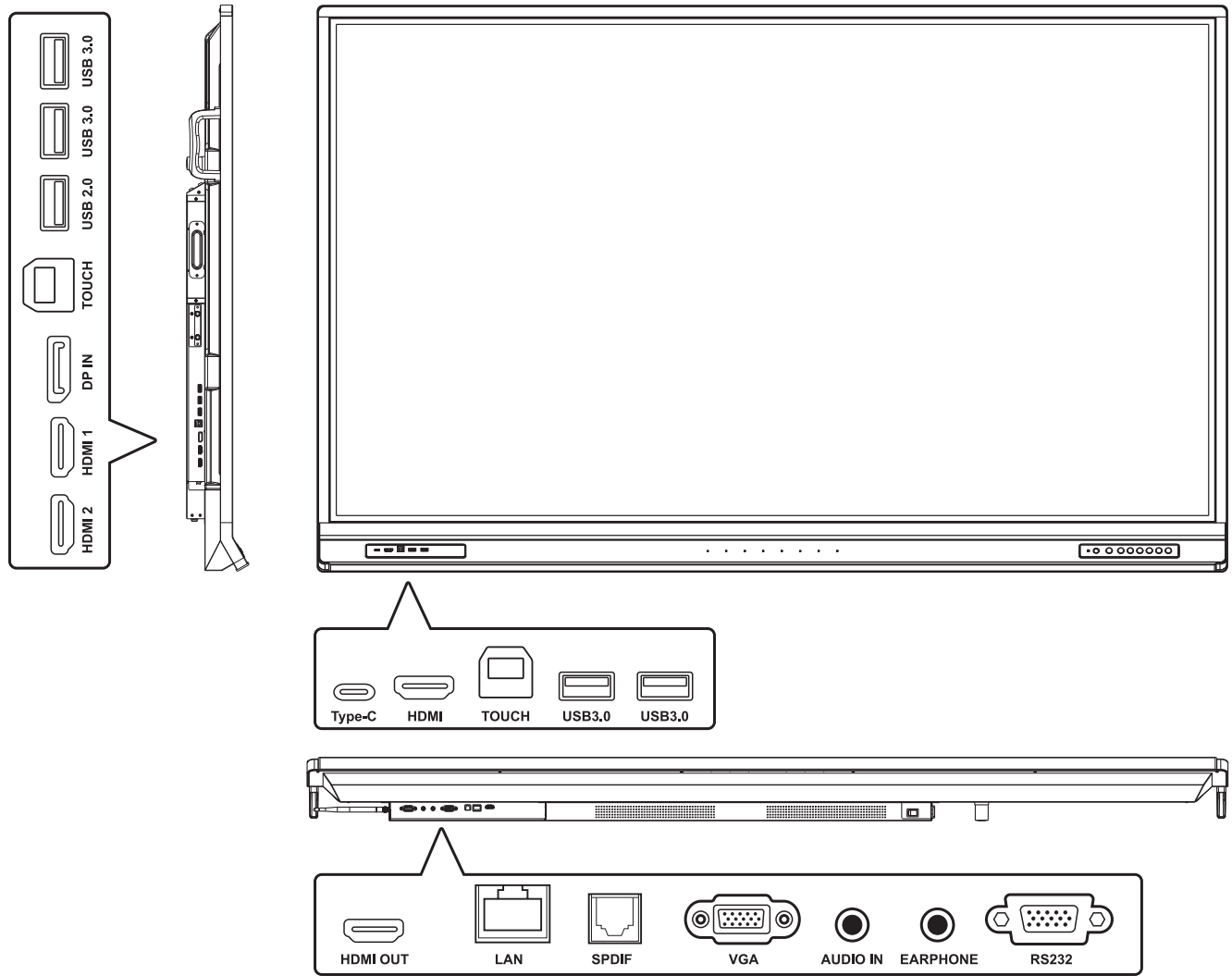

> USB- og netværksforbindelser

Ligesom på alle computere, er det let at forbinde forskellige USB-enheder og andet eksternt udstyr til dit ViewBoard.

Eksterne USB-enheder

Sæt USB-kablet i USB-porten.

Netværks- og modemkabler

Sæt routerkablet i LAN-porten.

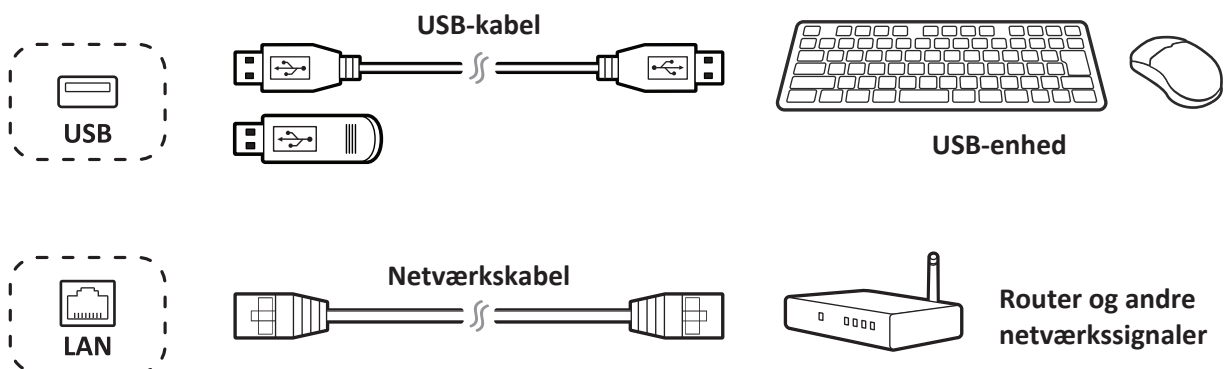

> Tilslutning af eksterne enheder og Touch-forbindelse

Dine eksterne enheder kan tilsluttes på en af følgende måder:

Med en Type C-forbindelse

Tilslut et Type C-kabel fra din eksterne enhed til Type C-porten på dit ViewBoard.

DisplayPort-tilslutning

1. Tilslut et DisplayPort-kabel fra din eksterne enhed til DisplayPort-porten på dit ViewBoard.
2. Tilslut et USB-kabel til den eksterne enhed fra TOUCH-porten på dit ViewBoard.

HDMI-tilslutning

1. Tilslut et HDMI-kabel fra din eksterne enhed til HDMI-indgangsstikket på dit ViewBoard.
2. Tilslut et USB-kabel til den eksterne enhed fra TOUCH-porten på dit ViewBoard.

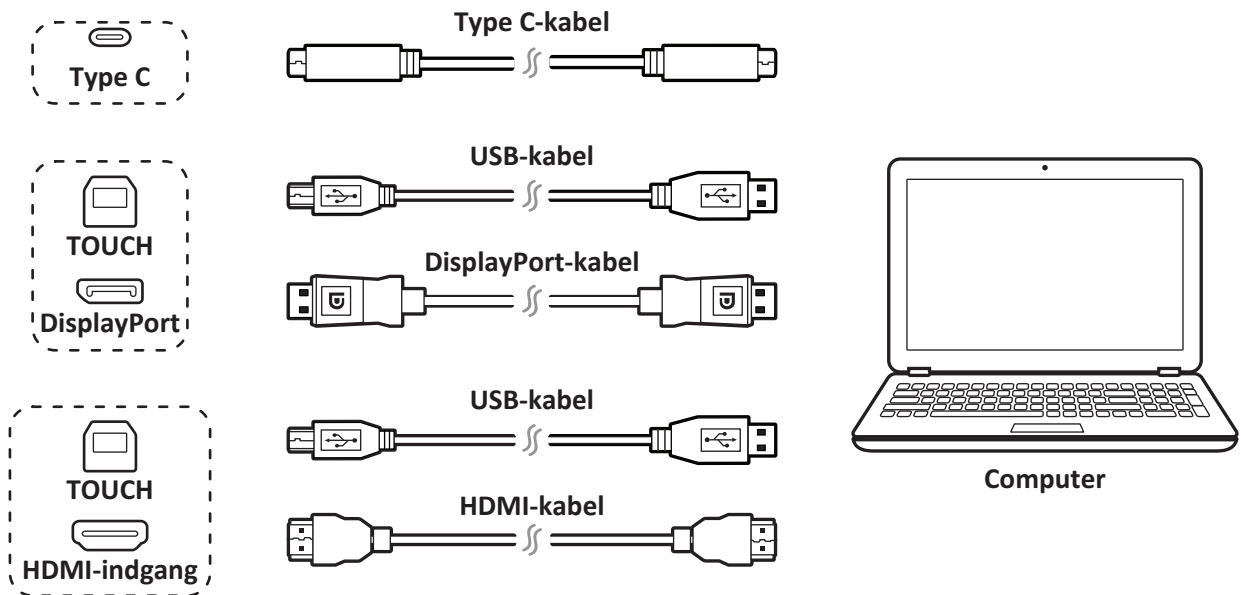

> RS232-tilslutninger

Når du bruger et RS232 serielt portkabel til at forbinde din skærm til en ekstern computer, kan nogle af funktionerne styres på pc'en. Det er funktioner som tænd/sluk, lydstyrkejustering og mere.

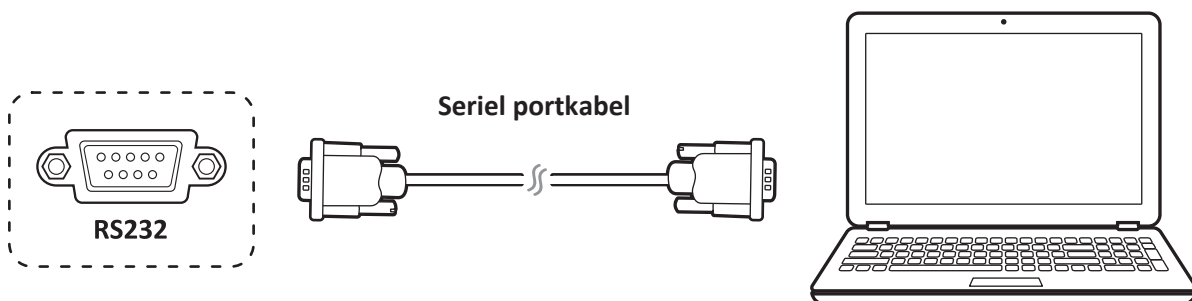

> Forbindelse til medieafspiller (lyd og video)

Sådan opretter du forbindelse til en medieafspiller:

1. Tilslut HDMI-kablet til HDMI-portene på dit ViewBoard og den eksterne enhed.
2. Tilslut strømkablet til dit ViewBoard, og tænd på tænd/sluk-knappen på bagsiden.
3. Tryk på tænd/sluk-knappen på højre side af dit ViewBoard for, at tænde skærmen.
4. Tryk på INDGANG-knappen på fjernbetjeningen, for at skifte til "HDMI" indgangskilden.

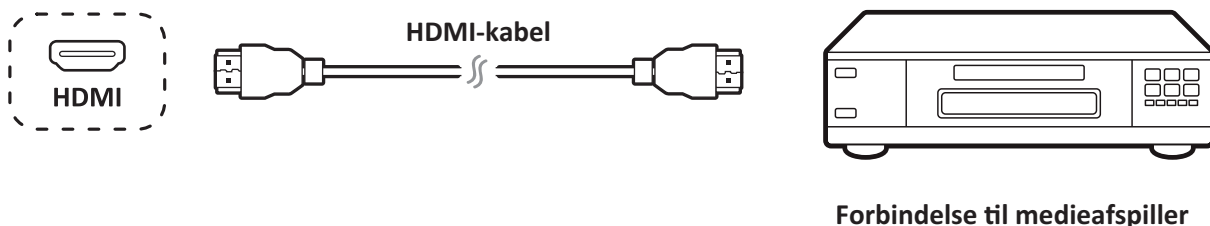

> SPDIF-tilslutning

Sådan opretter du forbindelse til et eksternt lydsystem:

1. Tilslut et optisk kabel fra SPDIF-porten til det optiske stik på dit lydsystem.
2. Tilslut strømkablet til dit ViewBoard, og tænd på tænd/sluk-knappen på bagsiden.
3. Tryk på tænd/sluk-knappen på højre side af dit ViewBoard for, at tænde skærmen.

Bemærk: S/PDIF- og høretelefonstikket virker kun på ViewBoard afspiller, HDMI og DP-kanal.

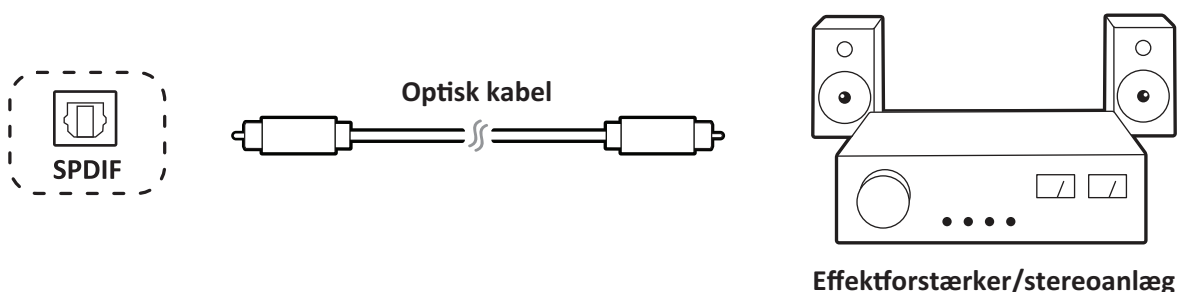

> Tilslutning af videoudgang

Sådan udsendes video via en skærmenhed:

1. Tilslut et HDMI-kabel til HDMI-indgangsporten på din skærmenhed og den anden ende til HDMI-udgangsporten på dit ViewBoard.
2. For lyd skal du slutte den ene ende af et lyd kabel til EARPHONE på dit ViewBoard og den anden ende til dine højttalere.
3. Tilslut strømkablet til dit ViewBoard, og tænd på tænd/sluk-knappen på bagsiden.
4. Tryk på tænd/sluk-knappen på højre side af dit ViewBoard for, at tænde skærmen.

Bemærk: S/PDIF- og høretelefonstikket virker kun på ViewBoard afspiller, HDMI og DP-kanal.



Lydkabel

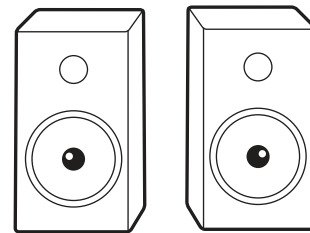

Højttalere



HDMI-kabel

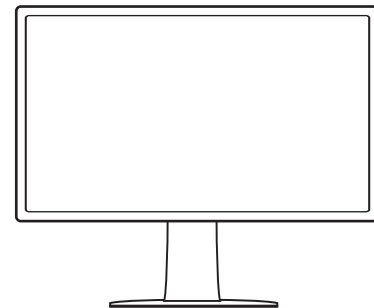
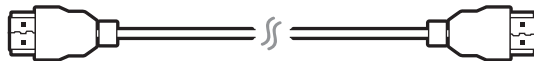

> Sådan kommer du i gang

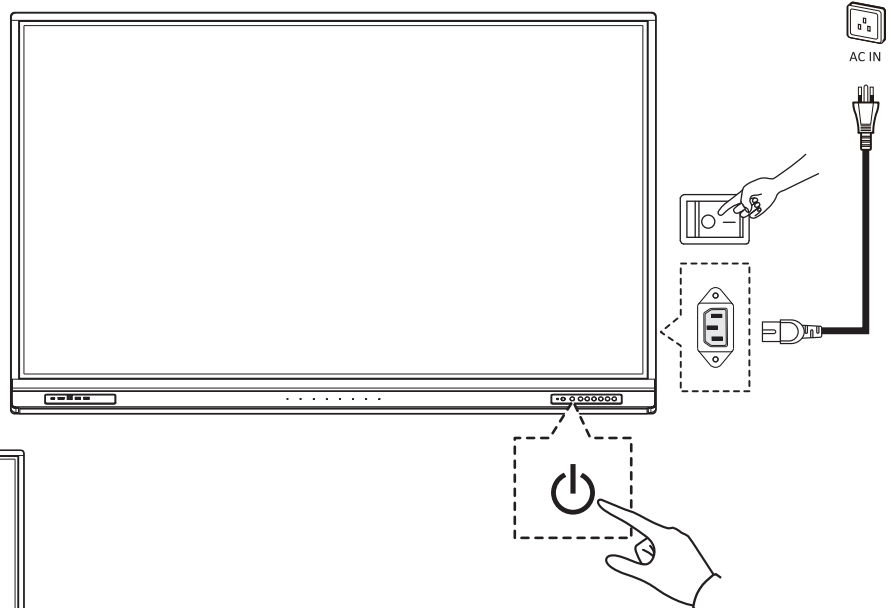
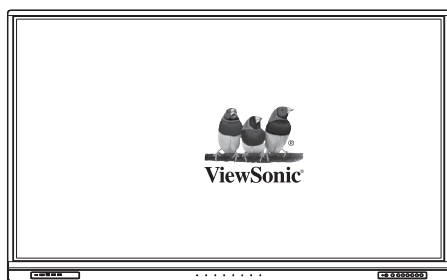



> Overensstemmelseserklæring

Overensstemmelseserklæring fra FCC: Denne enhed overholder stk. 15 i FCC-reglerne. Driften er underlagt følgende to betingelser: (1) Denne enhed må ikke forårsage skadelig interferens, og (2) denne enhed skal acceptere enhver modtaget interferens, herunder interferens, der kan forårsage uønsket drift.
Overholdelse af reglerne fra Industry Canada ICES-003: CAN ICES-3 (B)/NMB-3(B)



ViewSonic Corporation (US/Canada/Sydamerika)

 : www.viewsonic.com/support/product-registration



USA

 1-800-688-6688

 customerservice@viewsonic.com

Canada

 1-866-463-4775

 customerservice@viewsonic.com

Puerto Rico og Jomfruøerne

 <http://www.viewsonic.com/la/soporte/servicio-tecnico> (Español)

Sydamerika

 <http://www.viewsonic.com/la/soporte/servicio-tecnico-la/>



ViewSonic Europe Ltd.

 : www.viewsoniceurope.com

 +44 (0) 207 382 8251



Europe

 <http://www.viewsoniceurope.com/eu/support/call-desk/>



ViewSonic supportcenter



Ekstra tilbehør

> Inhoud van verpakking

- HDMI-kabel (10ft/3m)
- Type-C-kabel (5ft/1.5m)
- USB-kabel voor touch (10ft/3m)
- Klem x 5
- Webcam-plaat
- AAA-batterij x 2
- Touch-pen x 2
- Afstandsbediening
- Gum
- Webcam-schroeven x 4 (M4x7mm x2, M3x6mm x2)
- Snelstartgids
- Nalevingsverklaring
- RS232-adapter
- Stroomkabel (verzenden per regio)
- Wandmontageschroeven x 4 (M8x20mm x4)

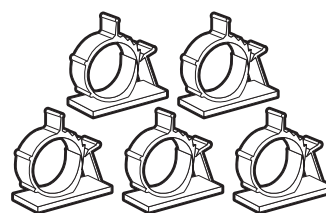
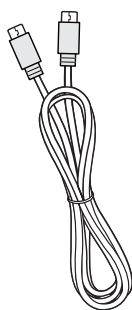
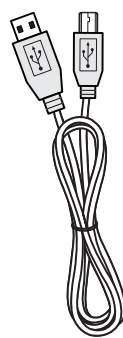
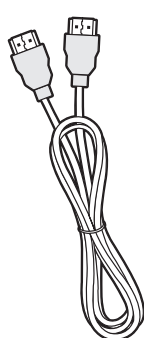
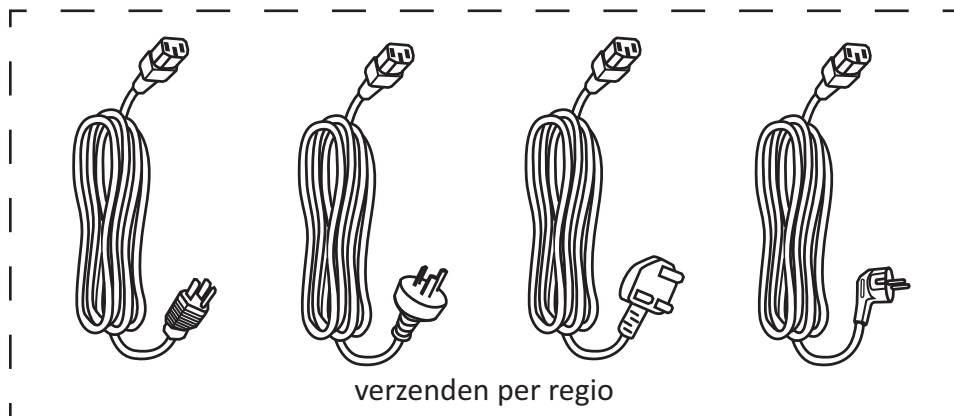

M8 X 4



M3 X 2



M4 X 2

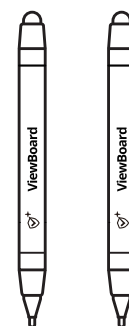
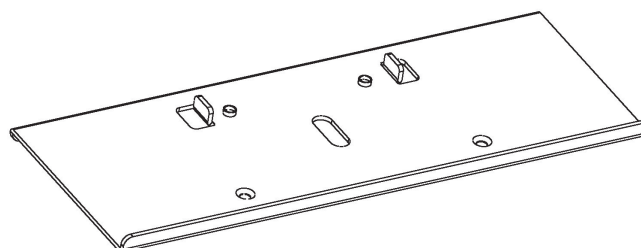
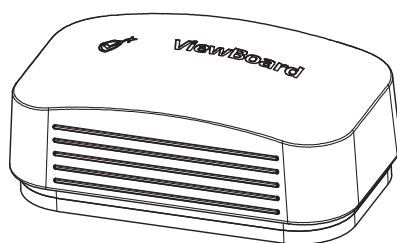

➤ Specificaties voor het monteren aan de muur (apart verkocht)

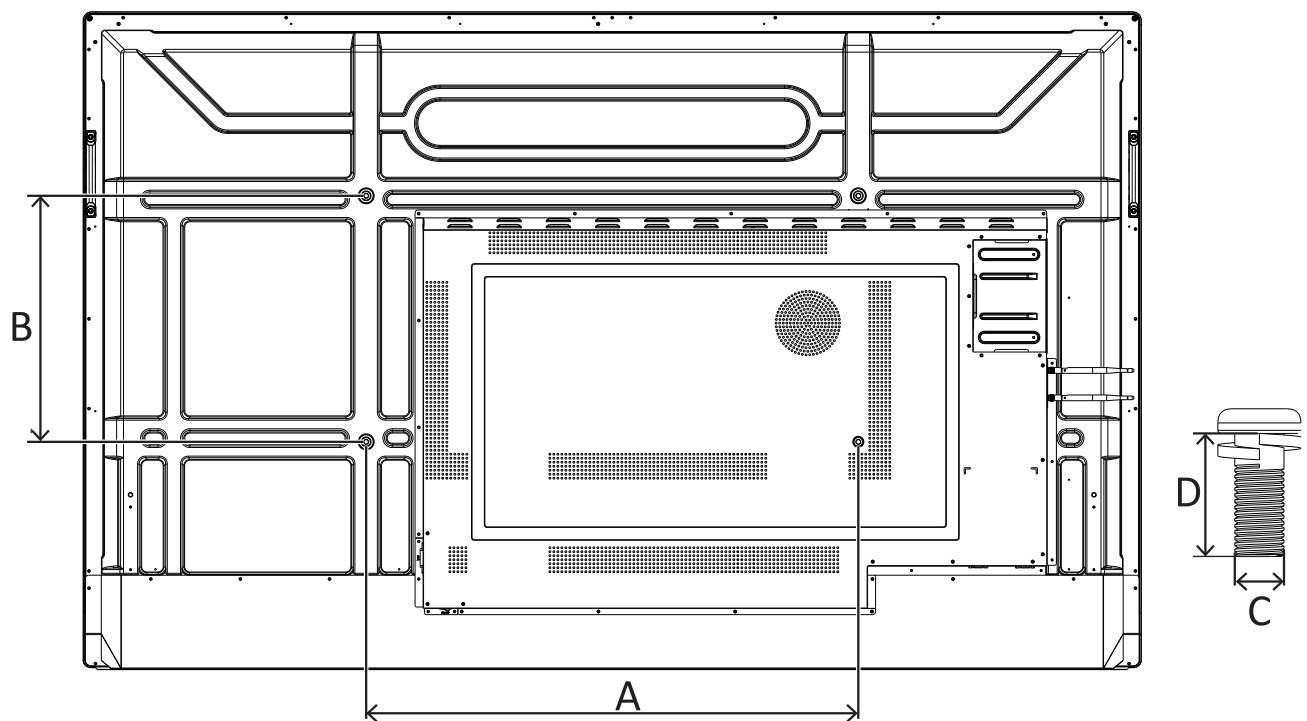

inch	VESA Spec. (A x B)	Standaard Schroef (C x D)	Hoeveelheid
IFP6552-serie	600 x 400 mm	M8 x 20 mm	4
IFP7552-serie	800 x 400 mm	M8 x 20 mm	4
IFP8652-serie	800 x 600 mm	M8 x 20 mm	4

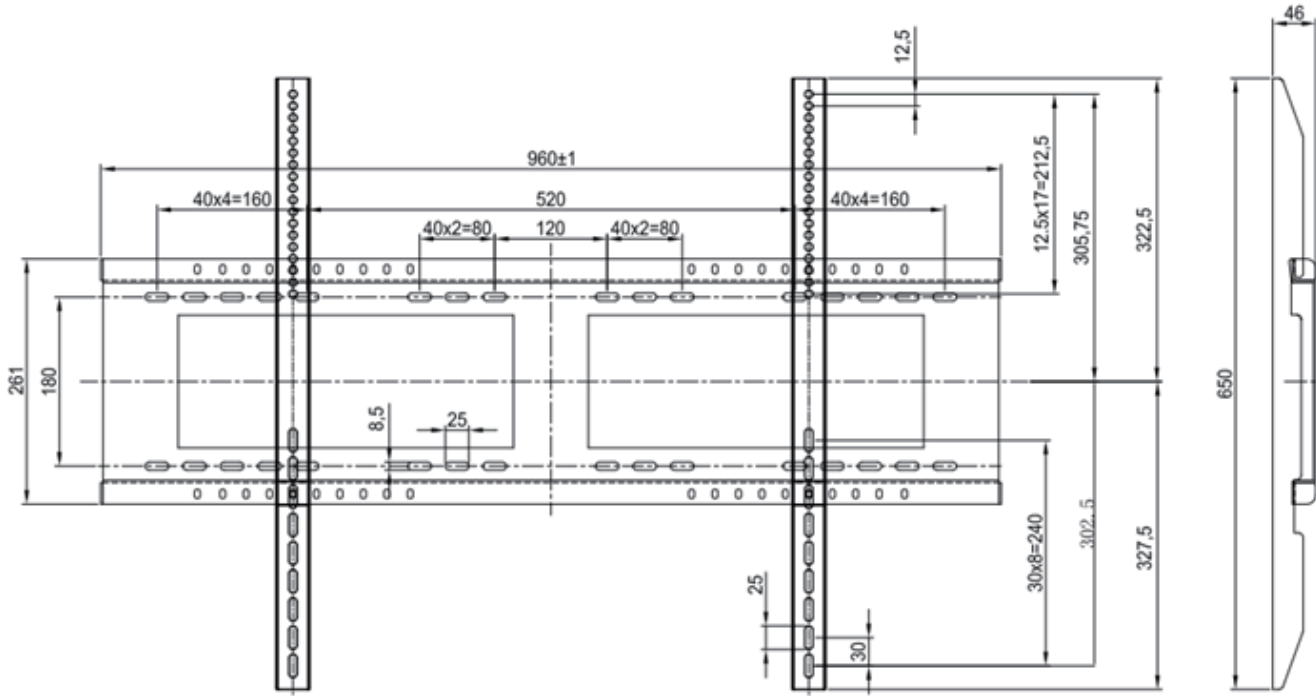

> Aandacht voor installatie-omgeving

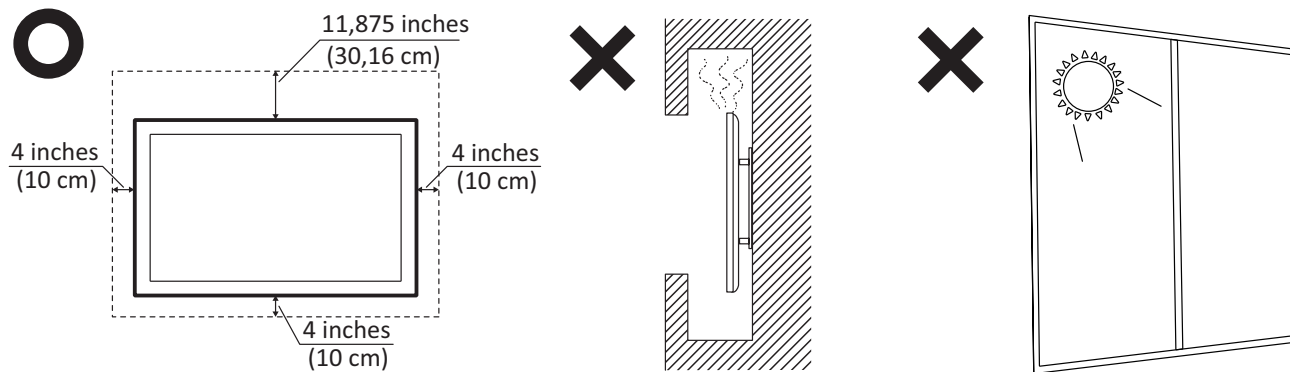

> Overzicht bedieningspaneel

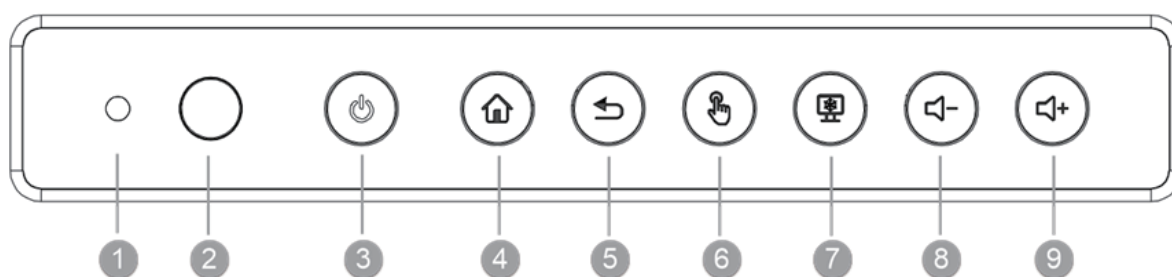

Item	Beschrijving
1	Omgevingslichtsensor voor monitoren van omgevingslicht
2	Ontvanger van de afstandsbediening
3	Voedingsindicatielampje Druk op de knop om het apparaat in te schakelen Druk op de knop om alleen de achtergrondverlichting van het display uit/in te schakelen Druk op de knop en blijf drukken om het apparaat uit te schakelen
4	Terug naar hoofdinterface van ViewBoard-speler
5	Terug naar vorige niveau van ViewBoard-speler
6	Het aanraakscherm uitschakelen/inschakelen
7	Huidige afbeelding op het scherm vastzetten
8	Volume zachter zetten
9	Volume harder zetten

> Overzicht afstandsbediening

- 1 Stroom aan/uit
- 2 Scherm vastleggen
- 3 *PC: "Windows"-knop
- 4 Schrijven opstarten
- 5 Terug naar startscherm van ingebedde speler
- 6 Terug / Terugkeren naar vorige pagina
- 7 Volume hoger/lager
- 8 Toetsenblok nummers
- 9 Informatie
- 10 Knop Ingangsbronselectie
- 11 Mediaregelknop
Rood: AFspeLEN/PAUZEREN
Groen: STOPPEN
Geel: VOORUIT
Blauw: ACHTERUIT
- 12 *PC: "Menu"-knop
- 13 *PC: Dialoogvenster afsluiten
- 14 Menu Instellingen
- 15 Toetsen Omhoog/Omlaag/Rechts/Links/OK
- 16 Scherm pauzeren
- 17 Dempen / Dempen ongedaan maken
- 18 Helderheid verhogen/verlagen
*PC: Pagina omhoog / pagina omlaag
- 19 Blanco scherm
- 20 Beeldverhouding aanpassen

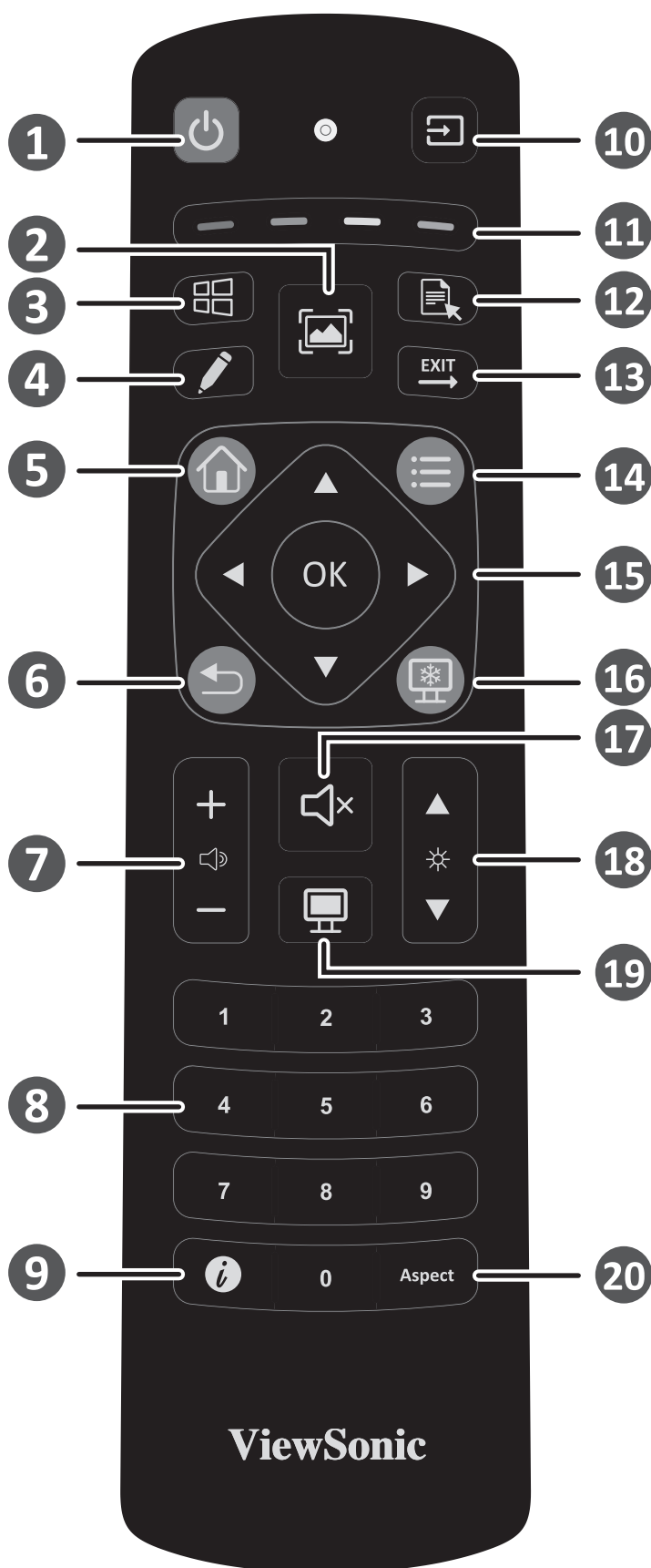

*PC-knop: Niet alle modellen ondersteunen deze functies

> I/O-poort

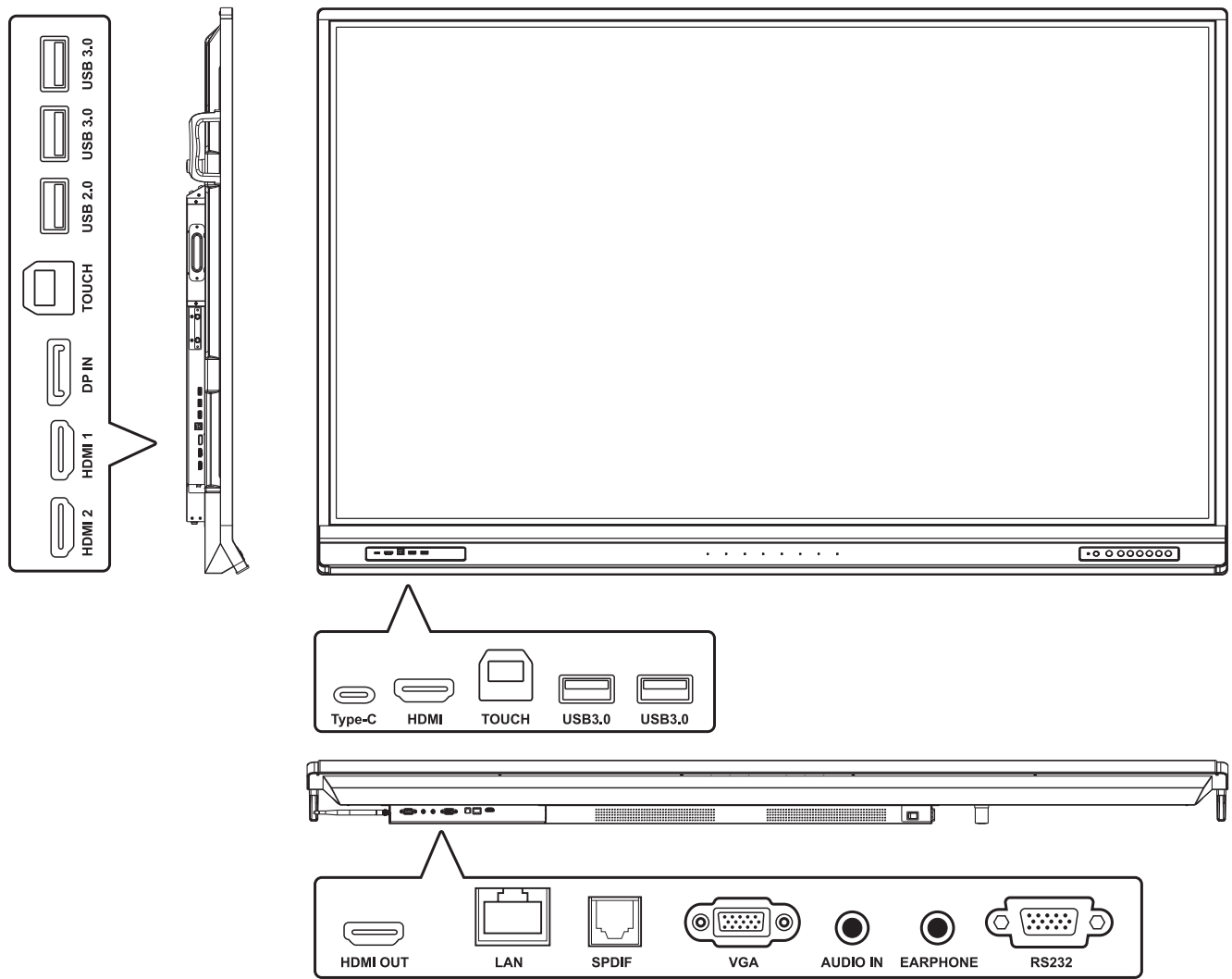

> USB en Netwerkverbindingen

Zoals bij elke PC is het eenvoudig om verschillende USB-apparaten en andere randapparatuur aan te sluiten op het ViewBoard.

USB-randapparatuur

Stop de kabel van het USB-apparaat in de USB-poort.

Netwerk- en modemkabels

Stop de kabel van de router in de LAN-poort.

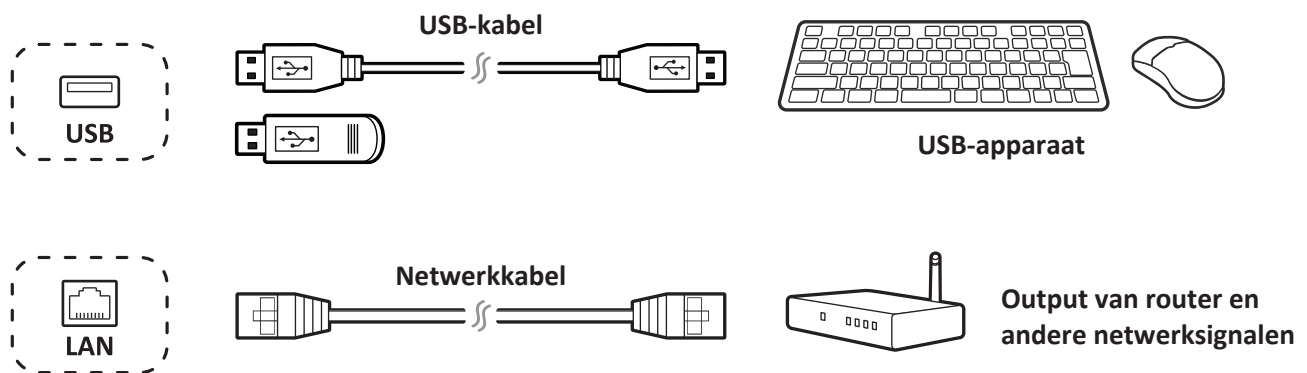

> Externe apparaten aansluiten en Touch-aansluiting

Uw externe apparaat/apparaten kan/kunnen worden verbonden in een van de volgende configuraties:

Type C-aansluiting

Verbind een Type C-kabel van uw extern apparaat naar de Type C-poort op het ViewBoard.

Schermbinding

1. Verbind een DisplayPort kabel van uw extern apparaat naar de DisplayPort-poort op het Viewboard.
2. Verbind een USB-kabel met het externe apparaat vanaf de TOUCH-poort van het ViewBoard.

HDMI-verbinding

1. Verbind een HDMI-kabel van uw extern apparaat naar de HDMI IN-poort op het ViewBoard.
2. Verbind een USB-kabel met het externe apparaat vanaf de TOUCH-poort van het ViewBoard.

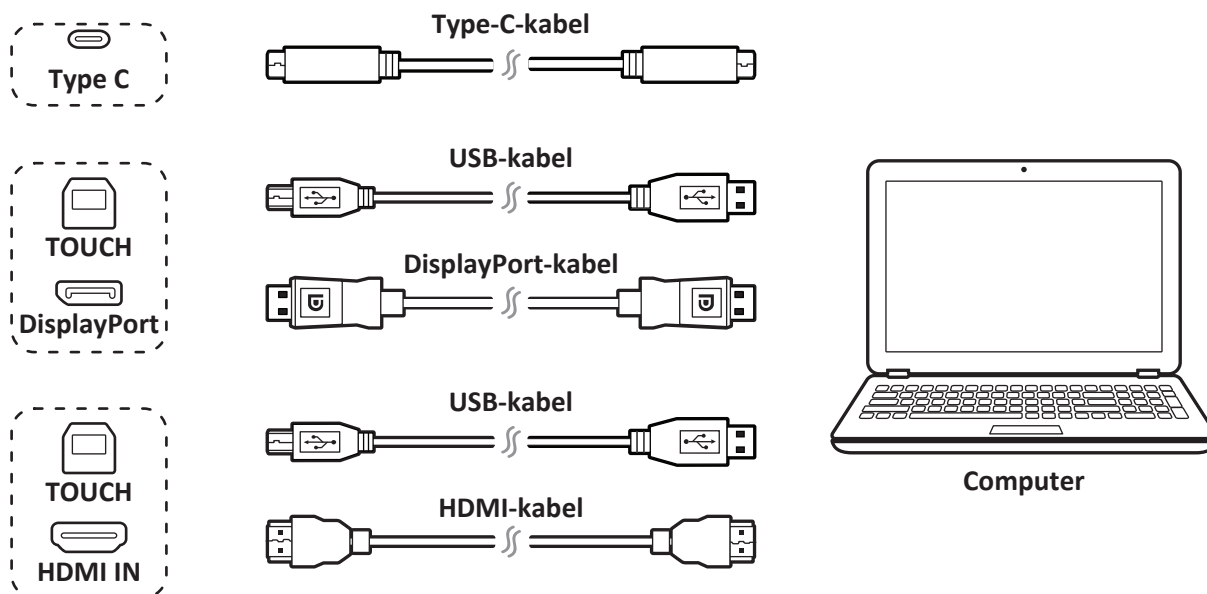

> RS232-verbindingen

Als u een seriële RS232-poortkabel gebruikt om uw display te verbinden met een externe computer kunnen bepaalde functies worden geregeld door de PC met inbegrip van aan/uitschakelen, volume regelen en meer.

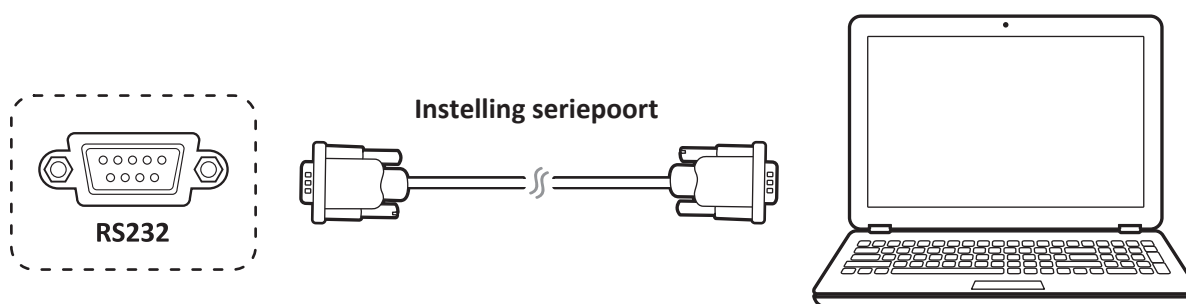

> Verbinding mediaspeler (audio en video)

Om een mediaspeler te verbinden:

1. Sluit de HDMI-kabel aan op de HDMI-poorten op uw ViewBoard en randapparatuur.
2. Stop de stroomkabel van uw ViewBoard in het stopcontact en schakel de stroomknop aan de achterkant van het paneel in.
3. Druk op de aan/uit-knop op de rechterkant van het ViewBoard om het scherm in te schakelen.
4. Druk op de knop INGANG op de afstandsbediening en schakel naar de "HDMI"-ingangsbron.

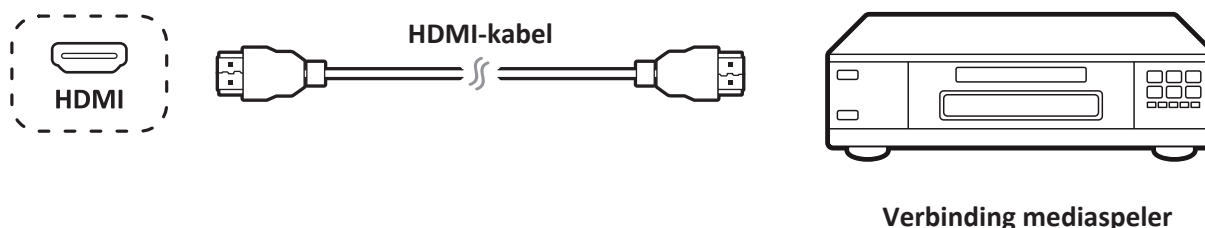

> SPDIF-verbindingen.

Om een externe geluidsinstallatie te verbinden:

1. Sluit een optische kabel aan van de SPDIF-poort op de optische connector van uw geluidssysteem.
2. Stop de stroomkabel van uw ViewBoard in het stopcontact en schakel de stroomknop aan de achterkant van het paneel in.
3. Druk op de aan/uit-knop op de rechterkant van het ViewBoard om het scherm in te schakelen.

Opmerking: S/PDIF- & koptelefoonaudio-uitgang werkt alleen op ViewBoard speler, HDMI en DP-kanaal.

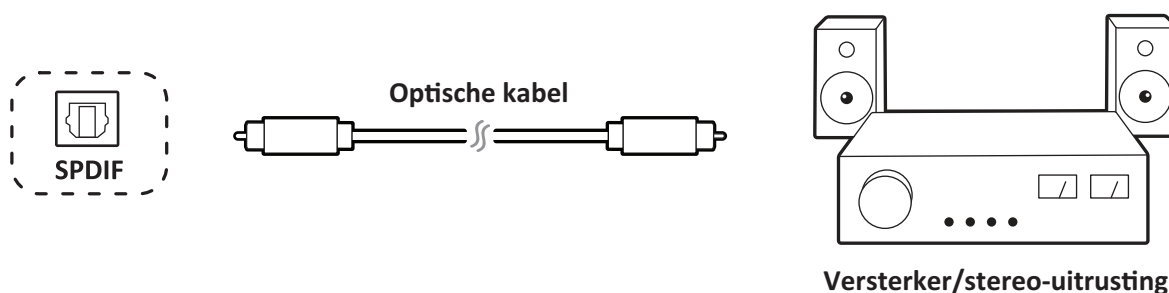

> Videouitgangsverbinding

Om een video via een displayapparaat te verbinden:

1. Verbind een HDMI-kabel met de HDMI IN-poort van uw displayapparatuur en de andere kant aan de HDMI OUT-poort van uw ViewBoard.
2. Verbind voor audio een eind van een audiokabel aan de EARPHONE-poort van uw ViewBoard aan de andere kant aan de luidsprekers.
3. Stop de stroomkabel van uw ViewBoard in het stopcontact en schakel de stroomknop aan de achterkant van het paneel in.
4. Druk op de aan/uit-knop op de rechterkant van het ViewBoard om het scherm in te schakelen.

Opmerking: S/PDIF- & koptelefoonaudio-uitgang werkt alleen op ViewBoard speler, HDMI en DP-kanaal.

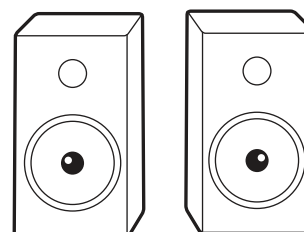

Luidsprekers

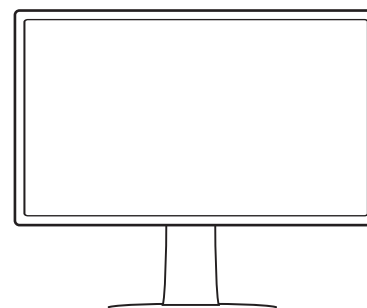

> Beginnen met gebruik

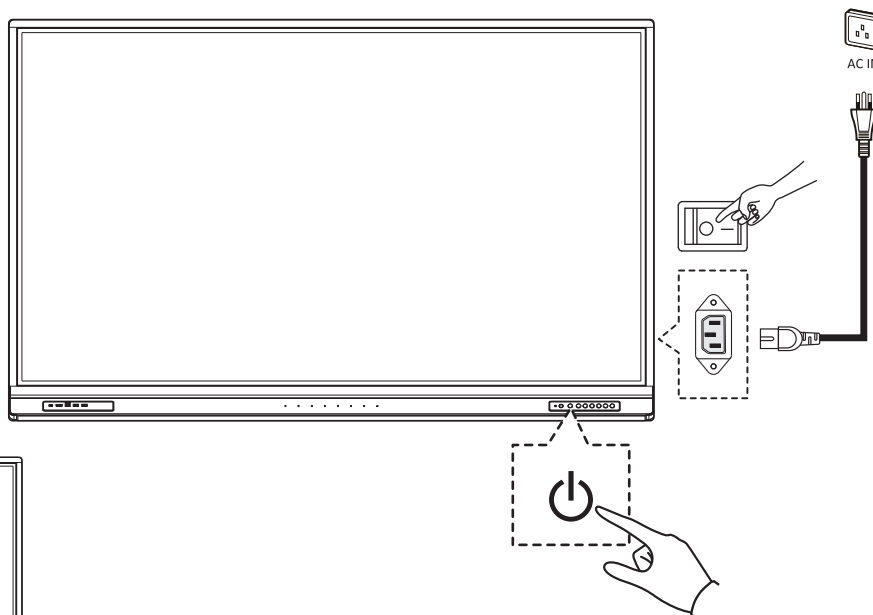
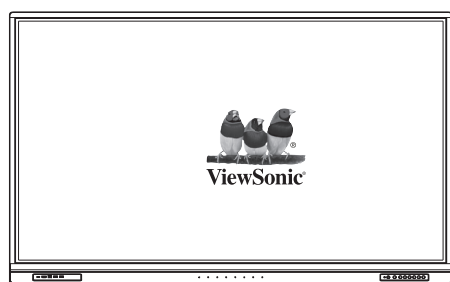



> Nalevingsverklaring

FCC-nalevingsverklaring: Dit apparaat voldoet aan Deel 15 van de FCC-voorschriften. Gebruik is onderworpen aan de volgende twee voorwaarden: (1) dit apparaat mag geen schadelijke ruis veroorzaken en (2) dit apparaat dient ontvangen ruis te accepteren, inclusief ruis die ongewenste werking kan veroorzaken.

Industry Canada ICES-003-naleving: CAN ICES-3 (B)/NMB-3(B)



ViewSonic Corporation (VS/Canada/Latijns-Amerika)

 : www.viewsonic.com/support/product-registration



Verenigde Staten

 1-800-688-6688

 customerservice@viewsonic.com

Canada

 1-866-463-4775

 customerservice@viewsonic.com

Puerto Rico & Maagdeneilanden

 <http://www.viewsonic.com/la/soporte/servicio-tecnico> (Español)

Latijns-Amerika

 <http://www.viewsonic.com/la/soporte/servicio-tecnico-la/>



ViewSonic Europe Ltd.

 : www.viewsoniceurope.com

 +44 (0) 207 382 8251



Europe

 <http://www.viewsoniceurope.com/eu/support/call-desk/>



> Pakkauksen sisältö

- HDMI-kaapeli (10ft/3m)
- Type-c-kaapeli (5ft/1.5m)
- USB-kaapeli kosketusta varten (10ft/3m)
- Kiristin x 5
- Verkkokameralevy
- AAA-paristo x 2
- Kosketuskynä x 2
- Kaukosäädin
- Pyyhekumi
- Verkkokameran ruuvit x 4 (M4x7mm x2, M3x6mm x2)
- Pikaopas
- Yhdenmukaisuusilmoitus
- RS232-sovitin
- Virtakaapeli (toimitus alueen mukaan)
- Seinäkiinnitysruuvit x 4 (M8x20mm x4)

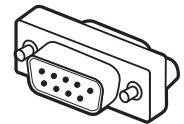
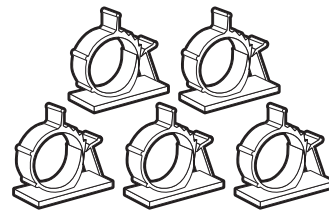
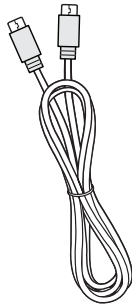
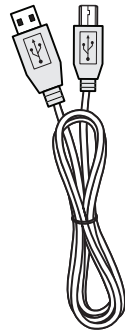
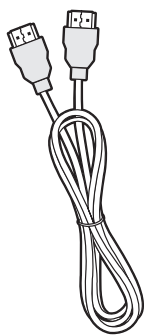
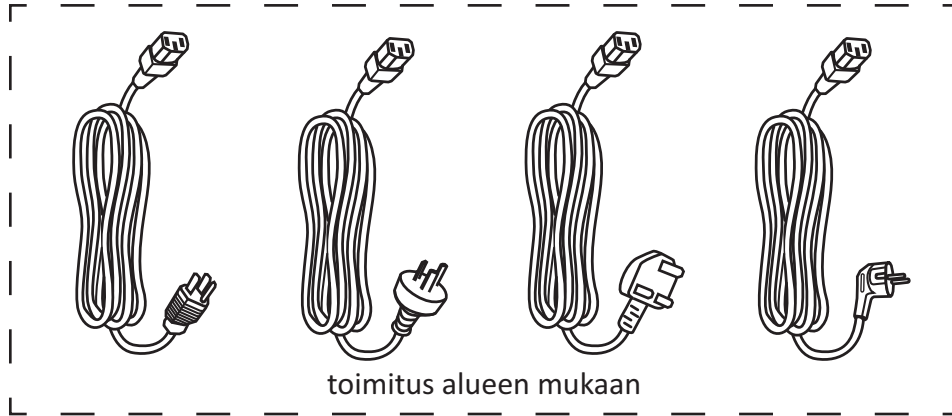

M8 X 4



M3 X 2



M4 X 2

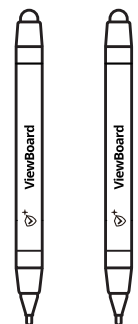
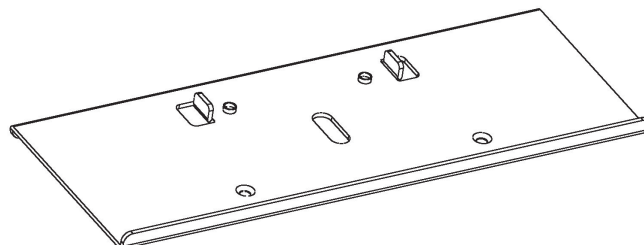
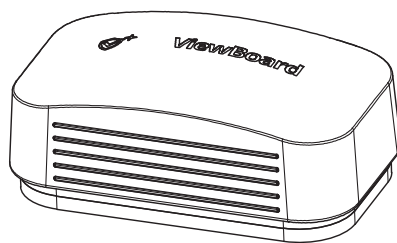

➤ Seinäkiinnityssarjan tekniset tiedot (myydään erikseen)

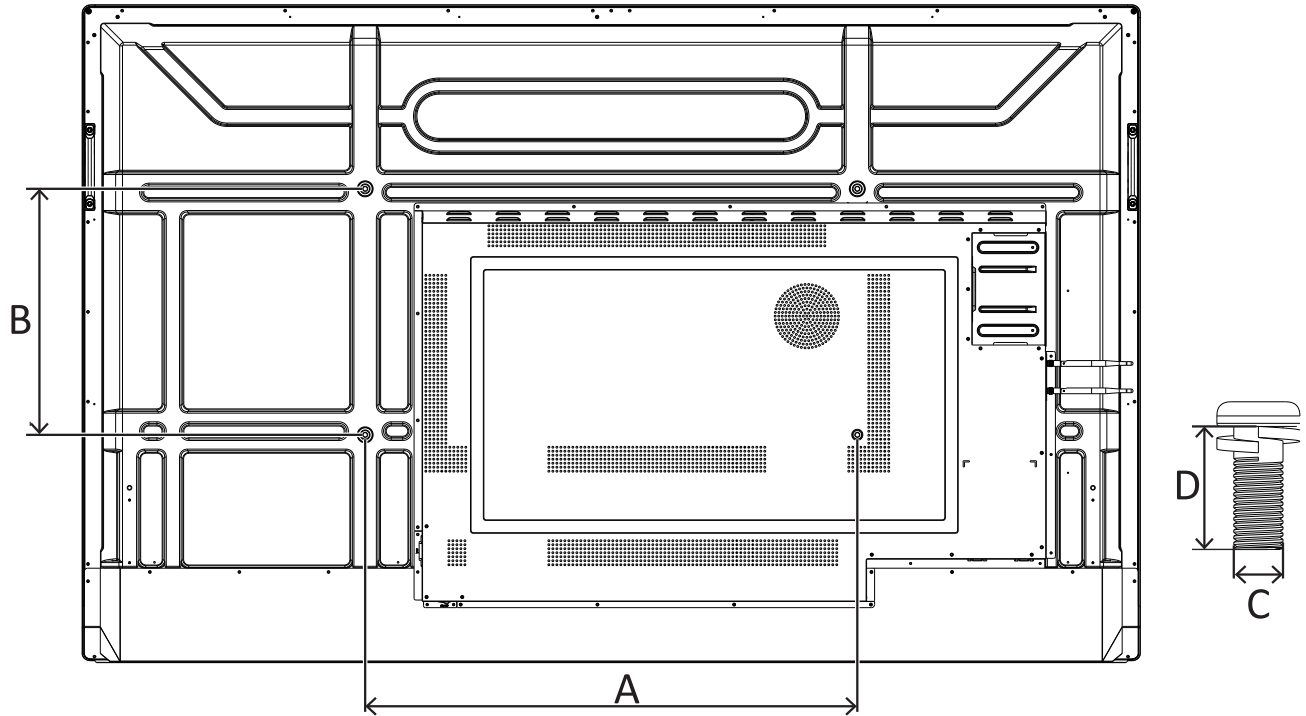

tuumaa	VESA-tekniset tiedot (A x B)	Vakioruuvi (C x D)	Määrä
IFP6552-sarja	600 x 400 mm	M8 x 20 mm	4
IFP7552-sarja	800 x 400 mm	M8 x 20 mm	4
IFP8652-sarja	800 x 600 mm	M8 x 20 mm	4

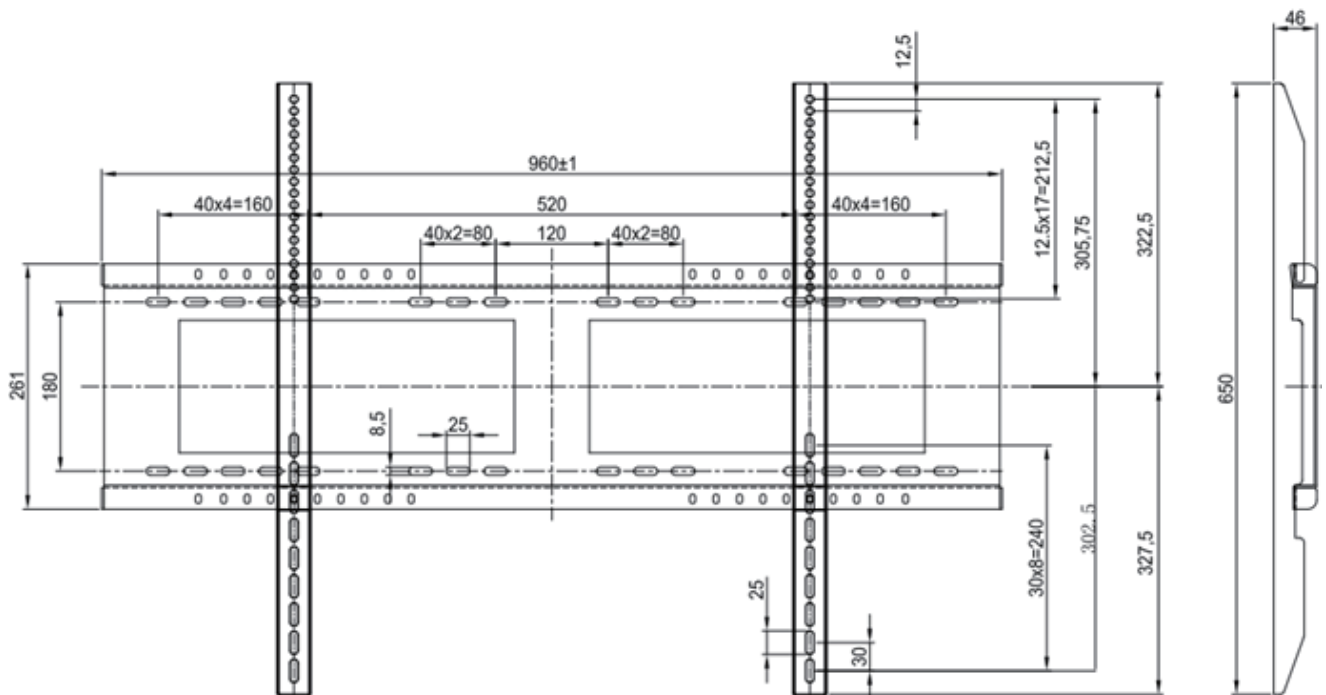

> Asennusympäristö Huomio

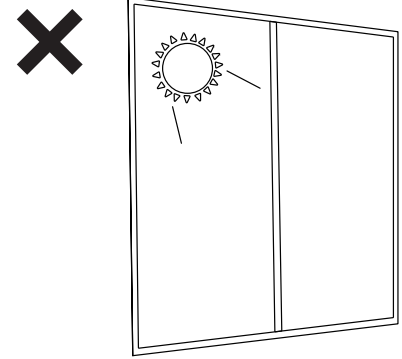
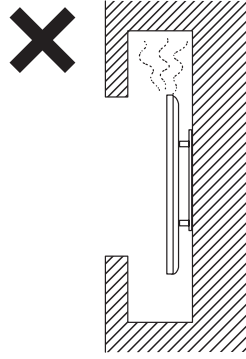
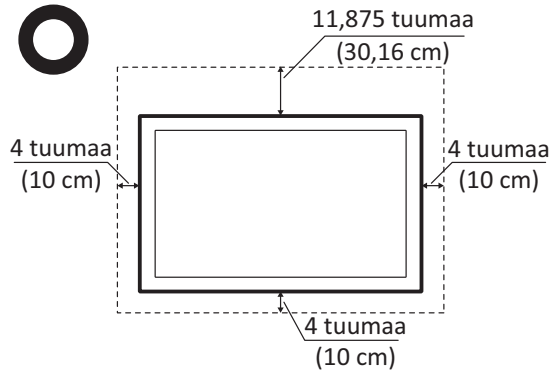

> Ohjauspaneelin yleiskatsaus

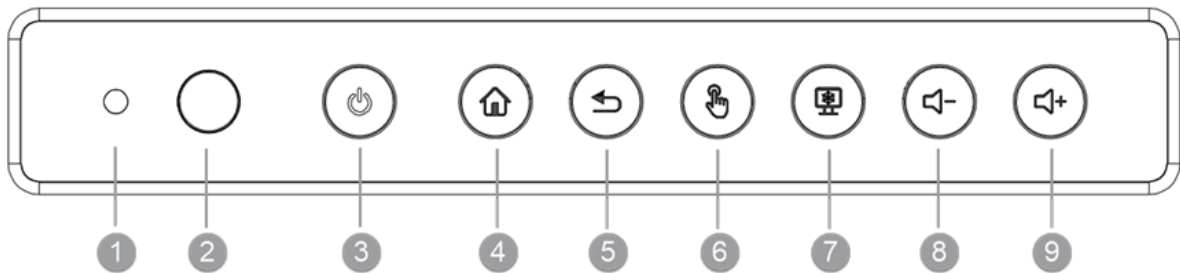

Nimike	Kuvaus
1	Ympäristön valaistusanturi ympäristön valaistuksen seurantaan
2	Kaukosäätimen vastaanotin
3	Virran merkkivalo Paina näppäintä kytkeäksesi laitteen päälle Paina näppäintä kytkeäksesi vain näytön taustavalon päälle/pois Paina näppäintä kytkeäksesi laitteen päälle
4	Takaisin ViewBoard-soittimen pääkäyttöliittymään
5	Palaa ViewBoard-soittimen edelliselle tasolle
6	Ota kosketusnäyttö käyttöön/pois käytöstä
7	Pysäytä nykyinen kuva näytöllä
8	Vähennä äänenvoimakkuutta
9	Lisää äänenvoimakkuutta

> Kaukosäätimen yleiskatsaus

- 1 Virta päälle/pois
- 2 Ruudunkaappaus
- 3 *PC: "Windows"-painike:
- 4 Käynnistyskirjoitus
- 5 Takaisin upotetun soittimen aloitusnäyttöön
- 6 Takaisin / Paluu edelliselle sivulle
- 7 Lisää/Vähennä äänenvoimakkuutta
- 8 Numeronäppäimistö
- 9 Tiedot
- 10 Tulolähteen valinta
- 11 Medianohjauspainike
Punainen: TOISTA/TAUKO
Vihreä: PYSÄYTÄ
Keltainen: ETEENPÄIN
Sininen: TAAKSEPÄIN
- 12 *PC: "Valikko"-painike
- 13 *PC: Poistu valintaikkunasta
- 14 Asetusvalikko
- 15 Ylös/Alas/Oikealle/Vasemmalle/OK-näppäimet
- 16 Pysäytä näyttö
- 17 Mykistä / Poista mykistys
- 18 Lisää/Vähennä kirkkautta
*PC: Sivu ylös / Sivu alas
- 19 Tyhjä näyttö
- 20 Säädä kuvasuhdetta

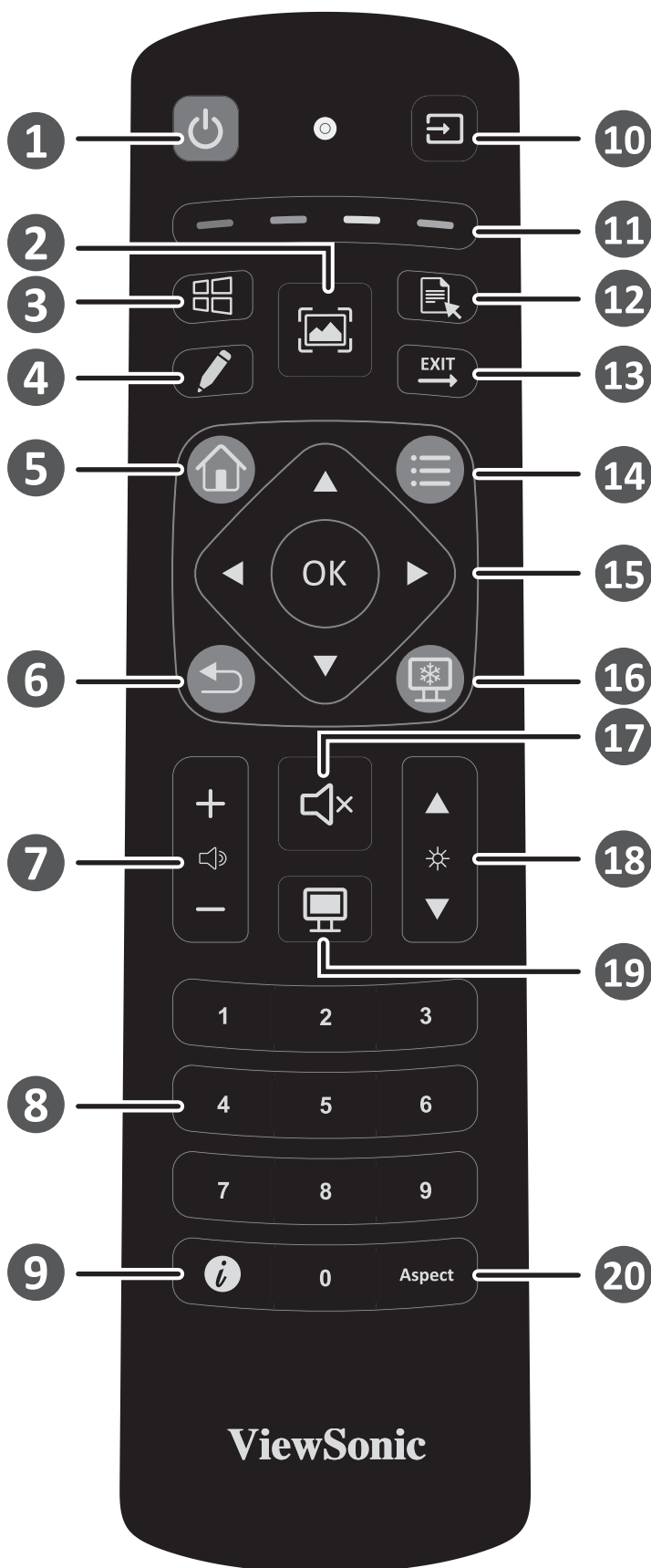

*PC-painike: Kaikki mallit eivät tue näitä toimintoja

> I/O-portti

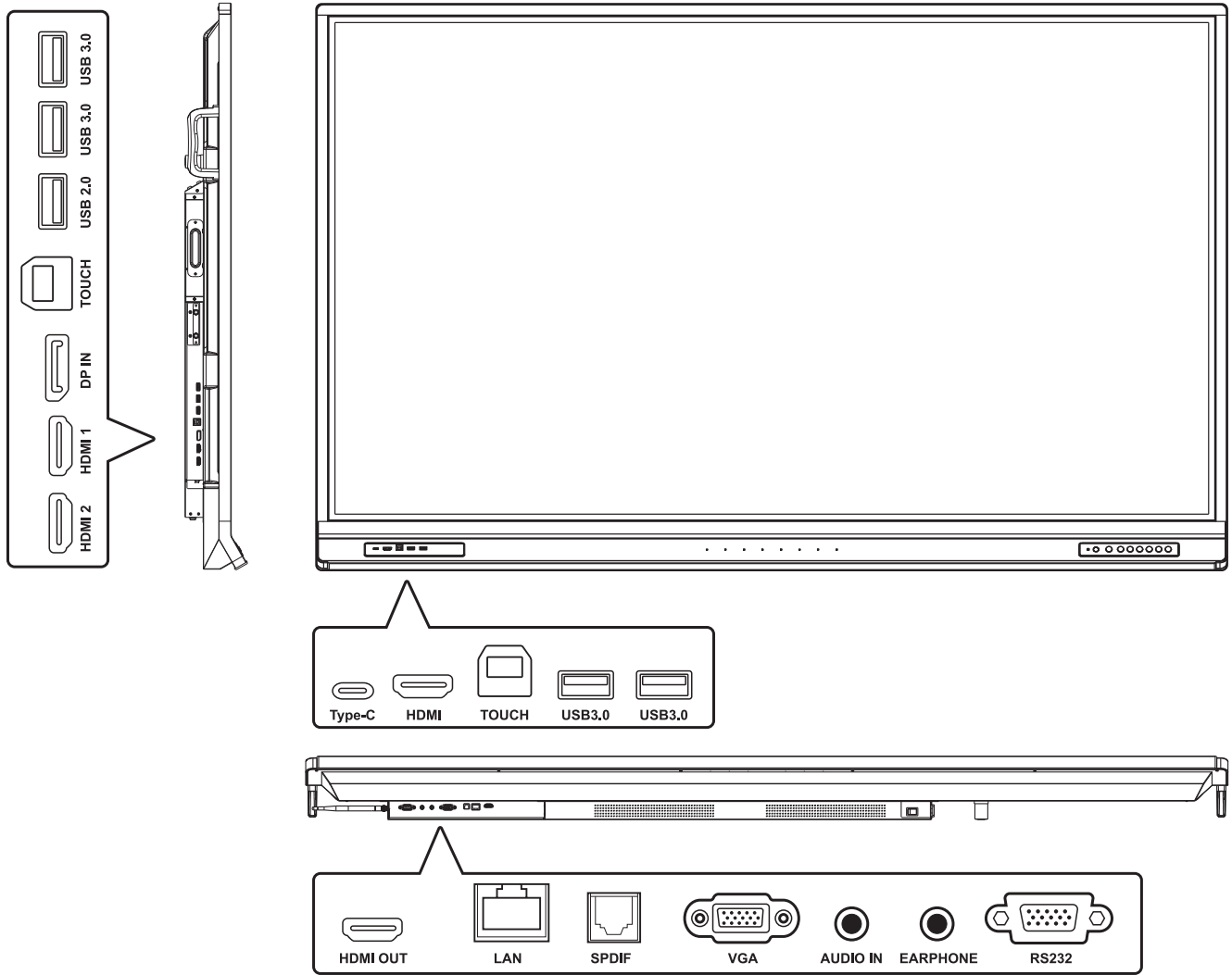

> USB- ja verkkoyhteys

Kuten minkä tahansa tietokoneen liittäminen, erilaisten USB-laitteiden ja muiden oheislaitteiden liittäminen ViewBoardiin on helppoa.

USB-oheislaitteet

Liitä USB-laitteen kaapeli USB-porttiin.

Verkko- ja modeemikaapelit

Liitä reititinkaapeli LAN-porttiin.

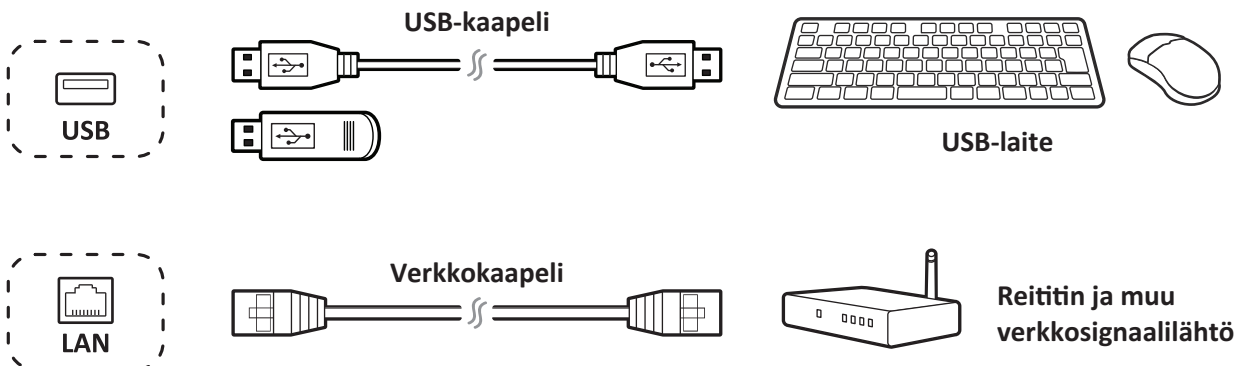

> Ulkoisten ja laitteiden ja kosketusyhteyden yhdistäminen

Voit yhdistää ulkoiset laitteesi millä tahansa seuraavista määrytyksistä:

Type-C-yhteys

Liitä Type C -kaapeli ulkoisesta laitteesta ViewBoardin Type C -porttiin.

DisplayPort-liitäntä

1. Liitä DisplayPort-kaapeli ulkoisesta laitteesta ViewBoardin DisplayPort-porttiin.
2. Liitä USB-kaapeli ulkoiseen laitteeseen ViewBoardin TOUCH-portista.

HDMI-liitäntä

1. Liitä HDMI-kaapeli ulkoisesta laitteesta ViewBoardin HDMI IN -porttiin.
2. Liitä USB-kaapeli ulkoiseen laitteeseen ViewBoardin TOUCH-portista.

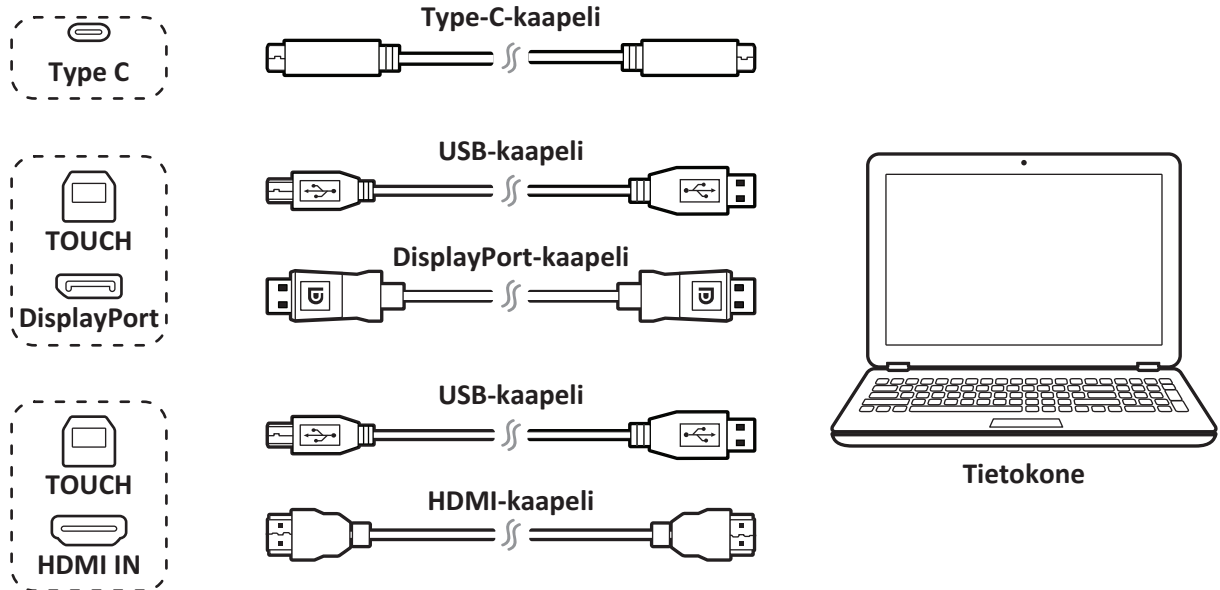

> RS232-liitännät

Kun käytät RS232-sarjaporttikaapelia näytön liittämiseen ulkoiseen tietokoneeseen, määrättyjä toimintoja voi ohjata PC:llä, mukaan lukien virta päälle/pois, äänenvoimakkuuden säätö jne.

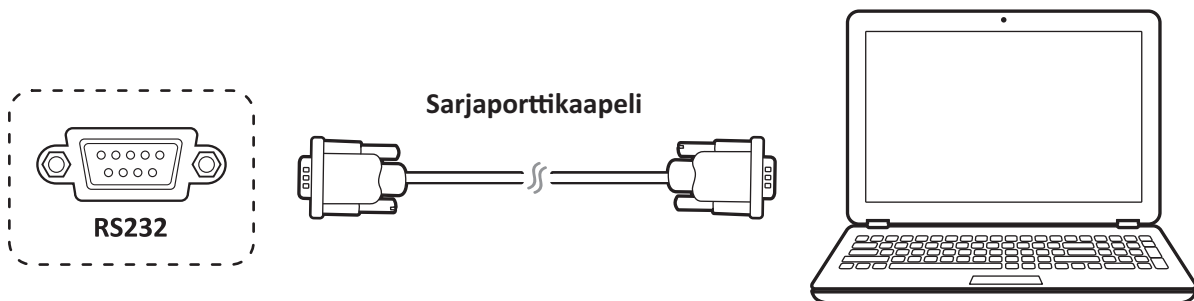

> Mediasoitin (audio ja video) -yhteys

Mediasoitimen liittäminen:

1. Liitä HDMI-kaapeli ViewBoardin ja oheislaitteen HDMI-portteihin.
2. Liitä ViewBoardin virtajohto ja kytke päälle takapaneelin virransyöttökytkin.
3. Paina ViewBoardin oikealla puolella olevaa virtapainiketta kytkeäksesi näytön päälle.
4. Paina kaukosäätimen TULO-painiketta ja vaihda "HDMI"-tulolähteeseen.

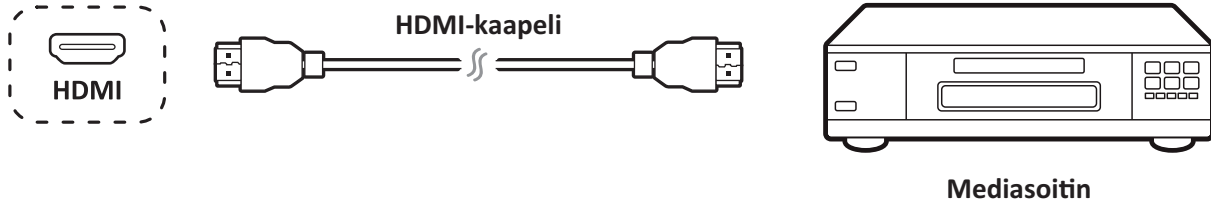

> SPDIF-yhteys

Ulkoiseen äänijärjestelmään yhdistäminen:

1. Liitä optinen kaapeli SPDIF-portista äänijärjestelmän optiseen liitäntään.
2. Liitä ViewBoardin virtajohto ja kytke päälle takapaneelin virransyöttökytkin.
3. Paina ViewBoardin oikealla puolella olevaa virtapainiketta kytkeäksesi näytön päälle.

Huomautus: S/PDIF ja kuulokeaudiolähtö toimivat vain ViewBoard Player -, HDMI- ja DP-kanavalla.

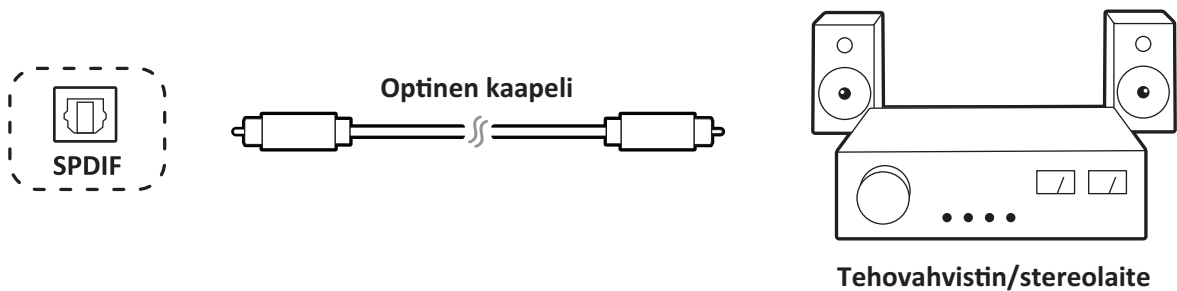

> Videolähtöyhteys

Lähetäaksesi videota näyttölaitteen kautta:

1. Liitä HDMI-kaapeli näyttölaitteen HDMI IN -porttiin ja toinen pää ViewBoardin HDMI OUT -porttiin.
2. Audiota varten, liitä audiokaapelin toinen pää ViewBoardin EARPHONE -porttiin ja toinen pää kaiuttimiin.
3. Liitä ViewBoardin virtajohto ja kytke päälle takapaneelin virransyöttökytkin.
4. Paina ViewBoardin oikealla puolella olevaa virtapainiketta kytkeäksesi näytön päälle.

Huomautus: S/PDIF ja kuulokeaudiolähtö toimivat vain ViewBoard Player -, HDMI- ja DP-kanavalla.

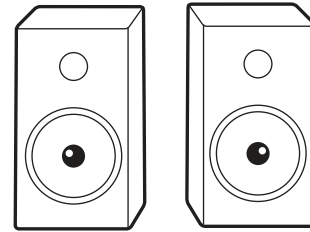

Kaiuttimet

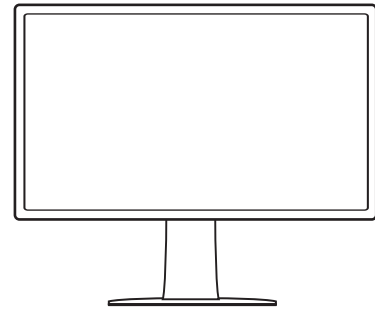
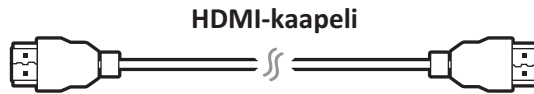
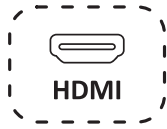

> Aloita käyttö

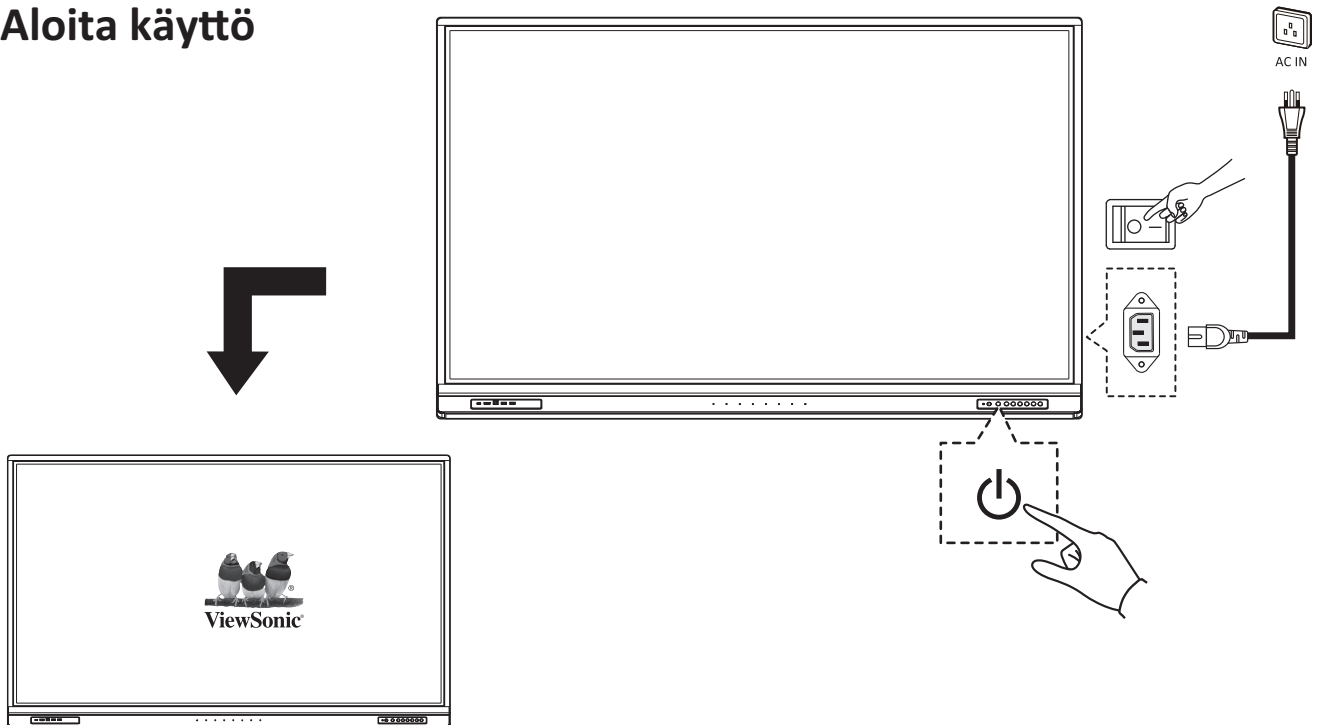



> Yhdenmukaisuusilmoitus

FCC-yhdenmukaisuusilmoitus: Laite on FCC-sääntöjen osan 15 mukainen. Laitteen käyttöä koskevat seuraavat kaksi ehtoa: (1) tämä laite saattaa aiheuttaa haitallista häiriötä, ja (2) tämän laitteen tulee vastaanottaa siihen tuleva häiriö, mukaan lukien häiriöt, joka voivat aiheuttaa ei-toivottuja toimintoja.
Industry Canada ICES-003 -yhteensopivuus: CAN ICES-3 (B)/NMB-3(B)



ViewSonic Corporation (Yhdysvallat/Kanada/Latinalainen Amerikka)

 : www.viewsonic.com/support/product-registration



Yhdysvallat

 1-800-688-6688

 customerservice@viewsonic.com

Kanada

 1-866-463-4775

 customerservice@viewsonic.com

Puerto Rico ja Neitsytsaaret

 <http://www.viewsonic.com/la/soporte/servicio-tecnico> (Español)

Latinalainen Amerikka

 <http://www.viewsonic.com/la/soporte/servicio-tecnico-la/>



ViewSonic Europe Ltd.

 : www.viewsoniceurope.com

 +44 (0) 207 382 8251



Europe

 <http://www.viewsoniceurope.com/eu/support/call-desk/>



ViewSonic-tukikeskus



Valinnainen lisävaruste

➤ Contenu de la boîte

- Câble HDMI (10ft/3m)
- Câble Type-C (5ft/1.5m)
- Câble USB pour fonction tactile (10ft/3m)
- Pince x 5
- Plaque de webcam
- 2 piles AAA
- 2 stylets tactiles
- Télécommande
- Gomme
- 4 vis pour webcam (M4x7mm x2, M3x6mm x2)
- Guide de démarrage rapide
- Déclaration de conformité
- Adaptateur RS232
- Câble d'alimentation (varie selon la région)
- 4 vis de montage mural (M8x20mm x4)

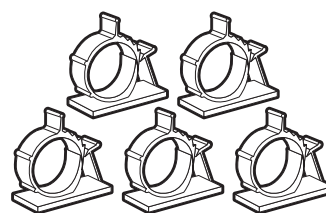
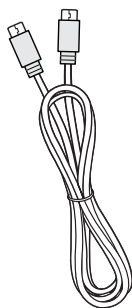
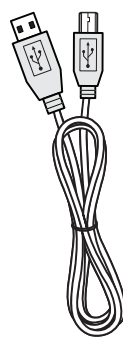
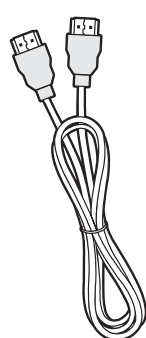
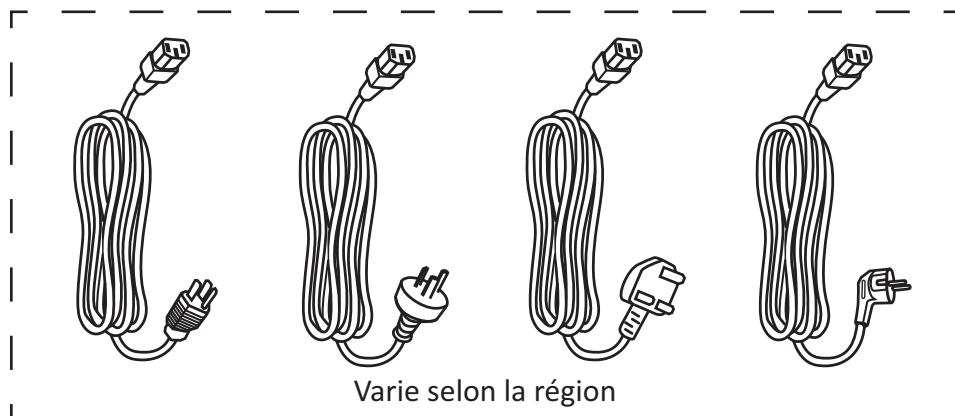

M8 X 4



M3 X 2



M4 X 2

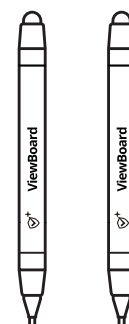
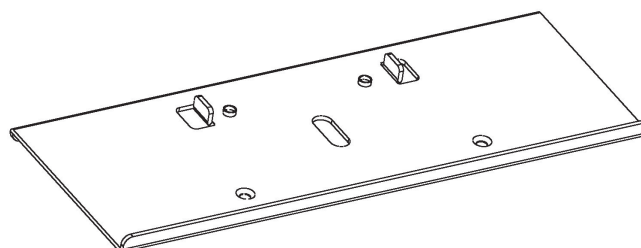
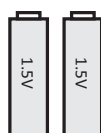
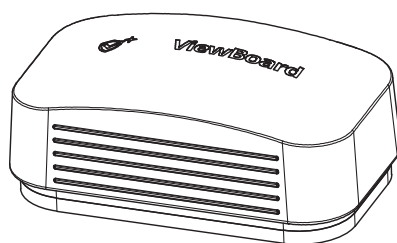

➤ Spécifications du kit de montage mural (vendu séparément)

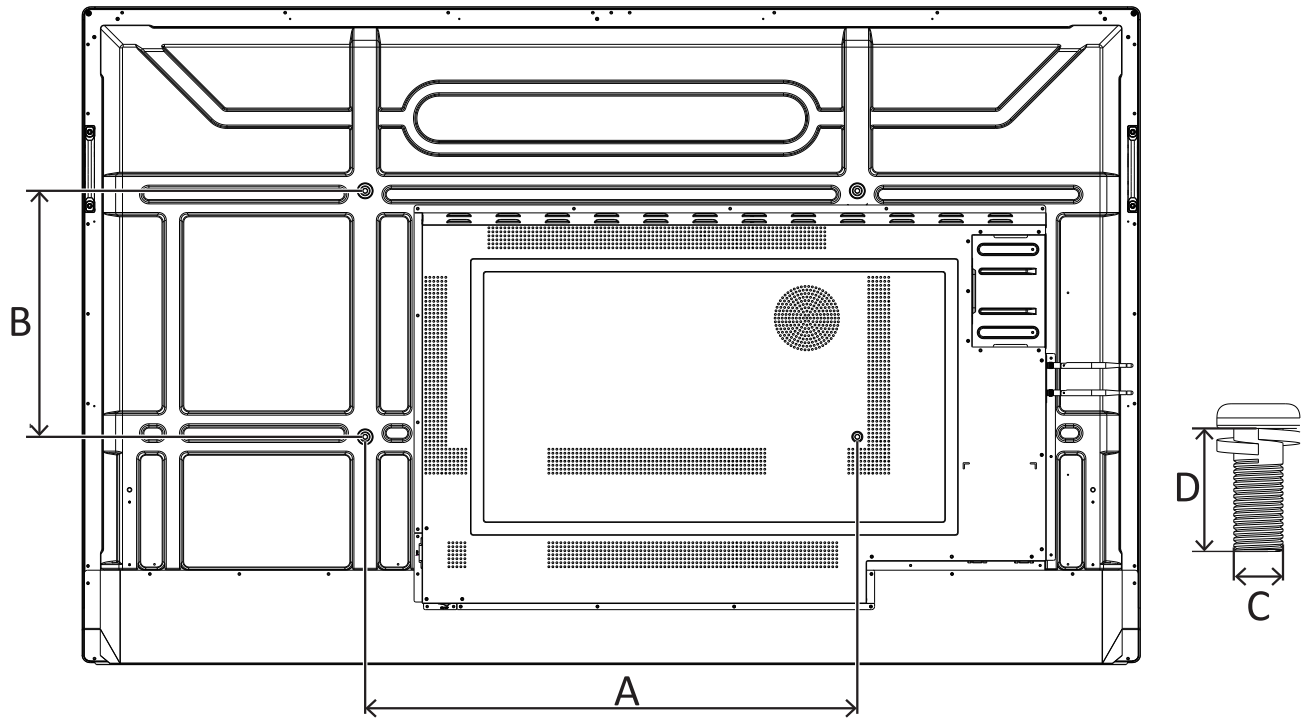

Pouces	Spéc. VESA (A x B)	Vis standard (C x D)	Quantité
Série IFP6552	600 x 400 mm	M8 x 20 mm	4
Série IFP7552	800 x 400 mm	M8 x 20 mm	4
Série IFP8652	800 x 600 mm	M8 x 20 mm	4

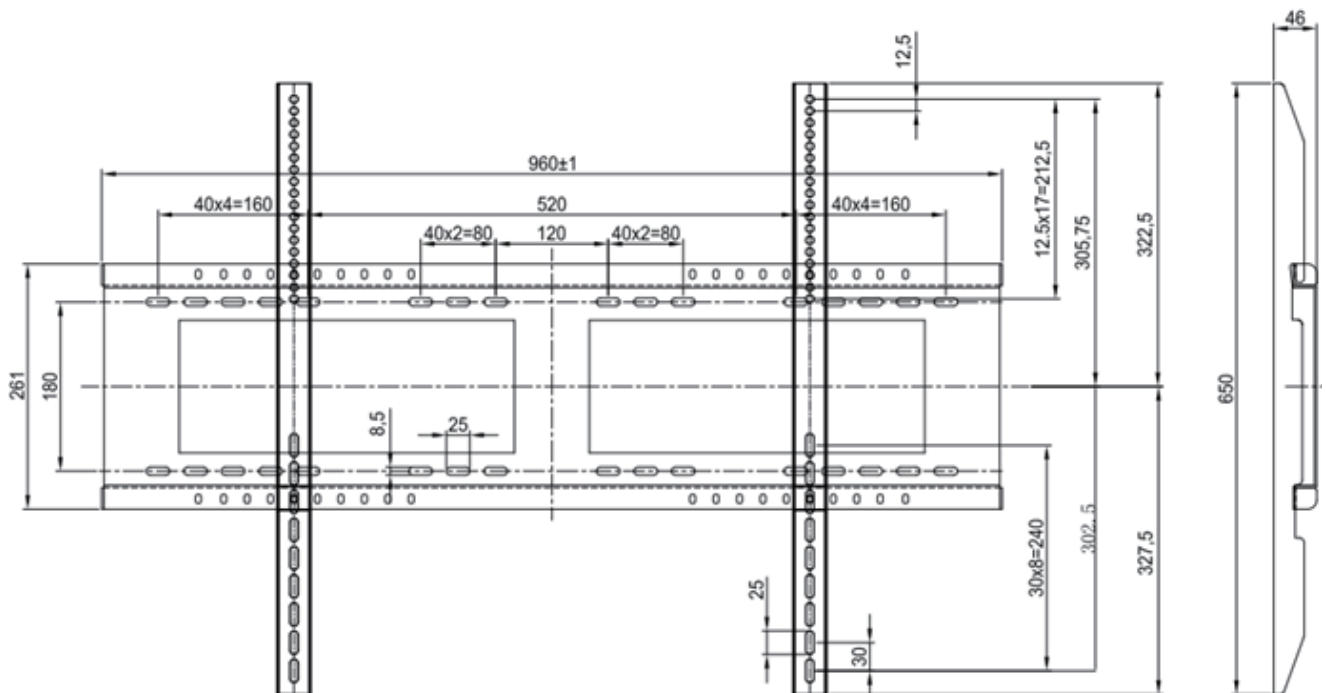

> Mise en garde relative à l'environnement d'installation

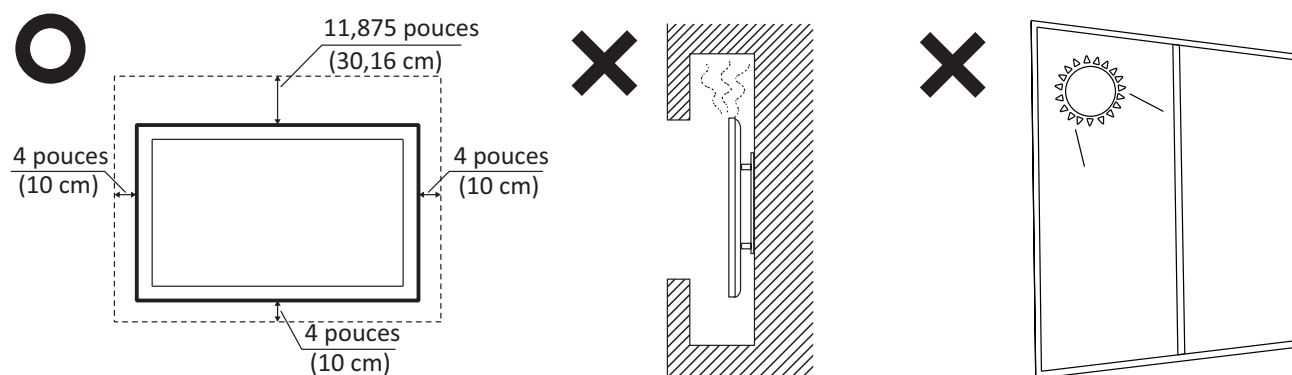

> Présentation du panneau de commandes

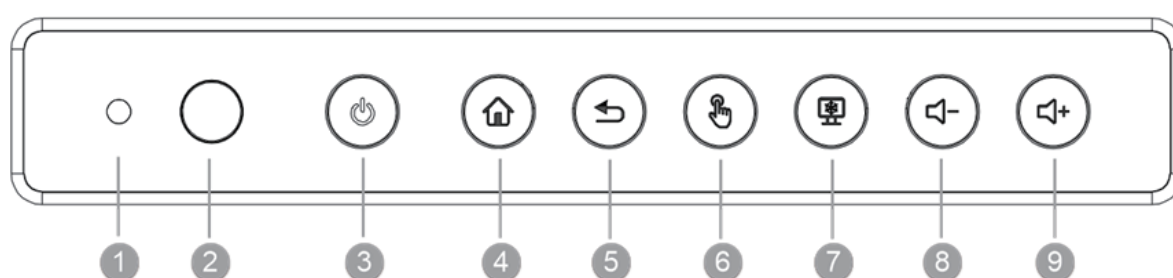

Élément	Description
1	Capteur de luminosité ambiante pour surveiller la luminosité ambiante
2	Récepteur de télécommande
3	Voyant indicateur d'alimentation Appuyez pour allumer l'appareil Appuyez sur la touche pour désactiver/activer uniquement le rétroéclairage de l'écran Appuyez en maintenant enfoncé pour éteindre l'appareil
4	Retour à l'interface principale du lecteur ViewBoard
5	Revenir au niveau précédent du lecteur ViewBoard
6	Désactiver/activer l'écran tactile
7	Figurer l'image actuelle à l'écran
8	Réduire le volume
9	Augmenter le volume

➤ Présentation de la télécommande

- 1 Marche/Arrêt
- 2 Capture d'écran
- 3 *PC : Bouton « Windows »
- 4 Démarrage Écriture
- 5 Retour à l'écran d'accueil du lecteur intégré
- 6 Retour / Revenir à la page précédente
- 7 Augmenter/diminuer le volume
- 8 Clavier numérique
- 9 Informations
- 10 Sélection de la source d'entrée
- 11 Bouton de commande multimédia
Rouge : LECTURE / PAUSE
Vert : STOP
Jaune : AVANT
Bleu : ARRIÈRE
- 12 *PC : Bouton « Menu »
- 13 *PC : Quitter la boîte de dialogue
- 14 Menu paramétrage
- 15 Touches Haut/Bas/Droite/Gauche/OK
- 16 Gel d'écran
- 17 Muet/Son
- 18 Augmenter/diminuer la luminosité
*PC : Page suivante / Page précédente
- 19 Écran vide
- 20 Pour changer le format d'affichage.

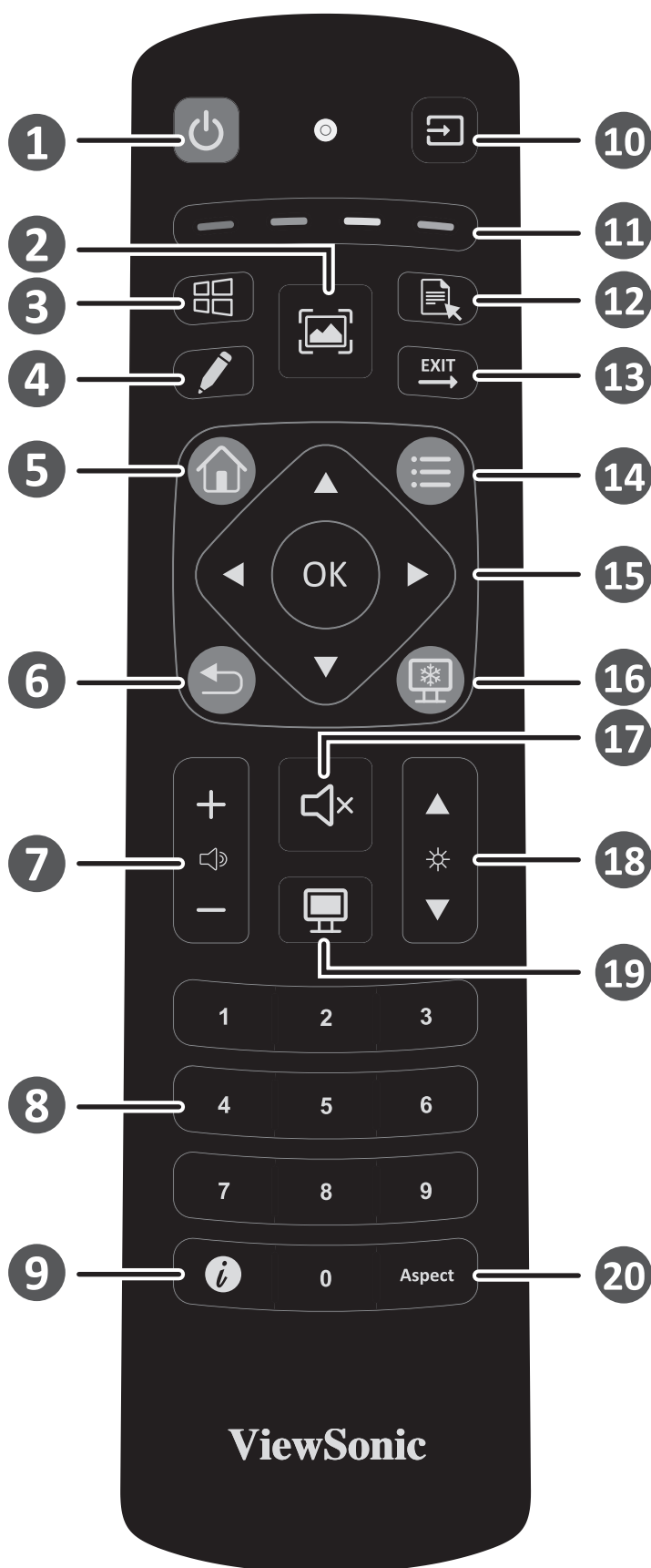

*Bouton PC : Tous les modèles ne prennent pas en charge ces fonctions

➤ Port E/S

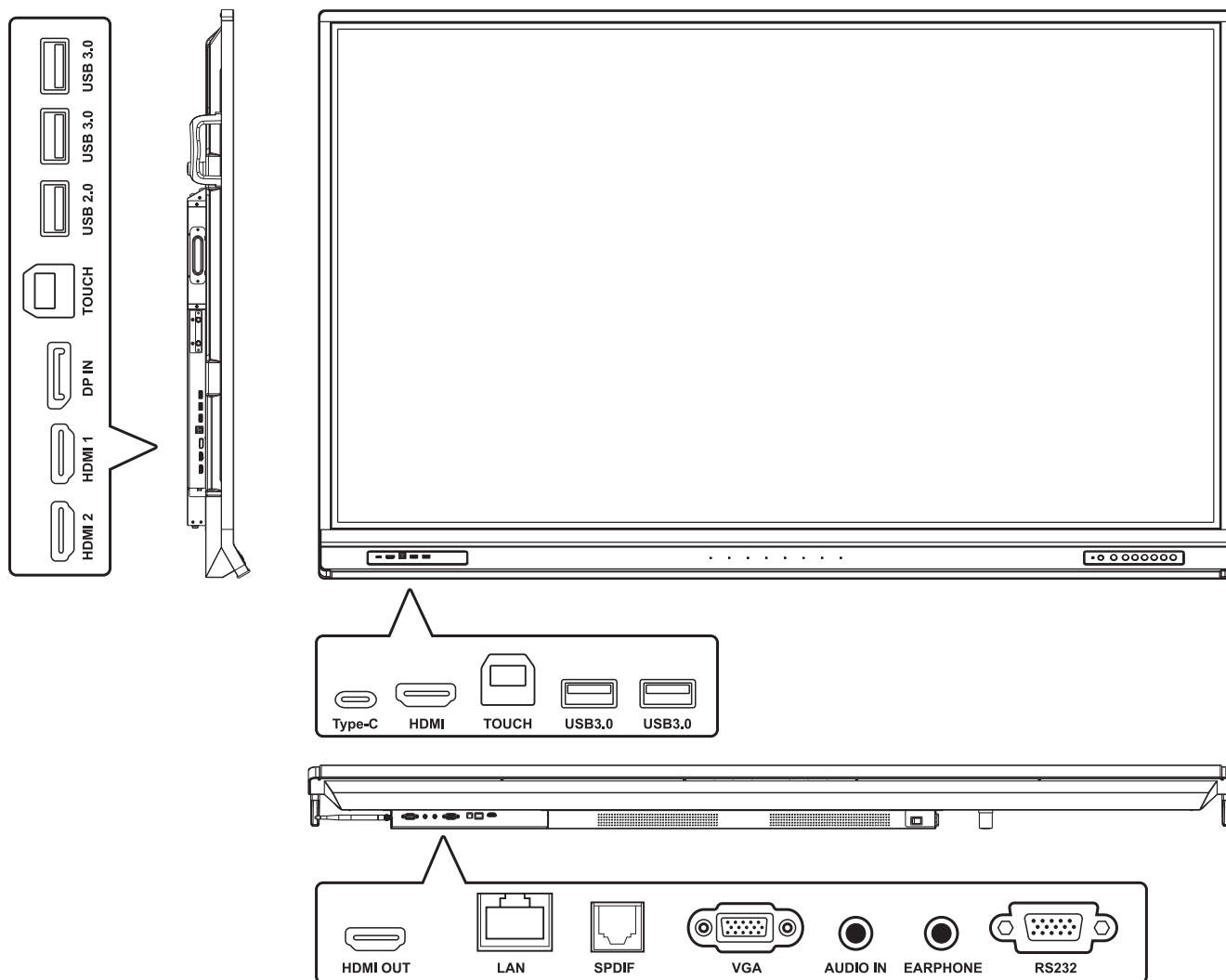

➤ Connexions USB et au réseau

Comme n'importe quel PC, il est facile de connecter divers périphériques USB ou d'autres périphériques à votre ViewBoard.

Périphériques USB

Branchez le câble du périphérique USB dans le port USB.

Câbles réseau et modem

Branchez le câble du routeur dans le port LAN.

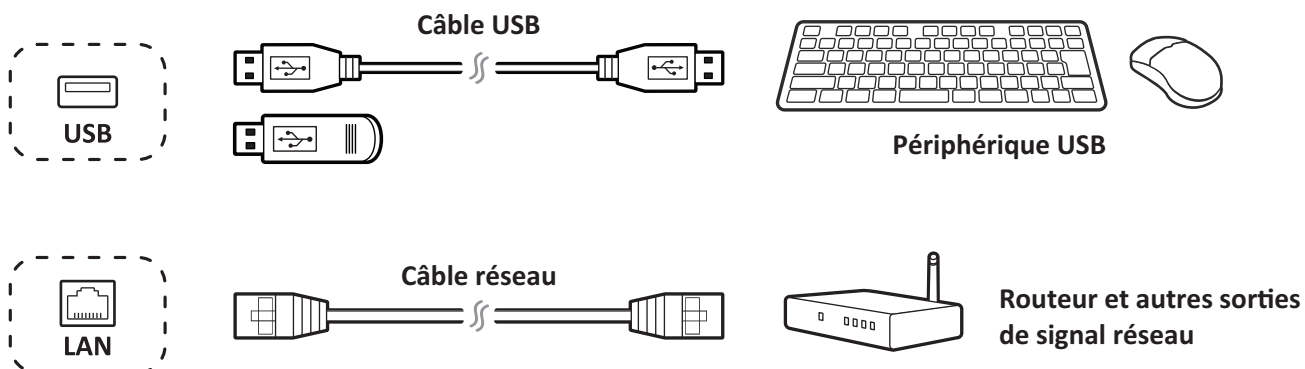

> Connexion des périphériques externes et connexion tactile

Votre périphérique(s) externe(s) peut être connecté avec les configurations suivantes :

Connexion de type C

Connectez un câble de type C de votre périphérique externe au port de type C du ViewBoard.

Branchement DisplayPort

1. Connectez un câble DisplayPort de votre périphérique externe au port DisplayPort du ViewBoard.
2. Connectez un câble USB de votre périphérique externe au port TACTILE du ViewBoard.

Branchement HDMI

1. Connectez un câble HDMI de votre périphérique externe au port ENTRÉE HDMI du ViewBoard.
2. Connectez un câble USB de votre périphérique externe au port TACTILE du ViewBoard.

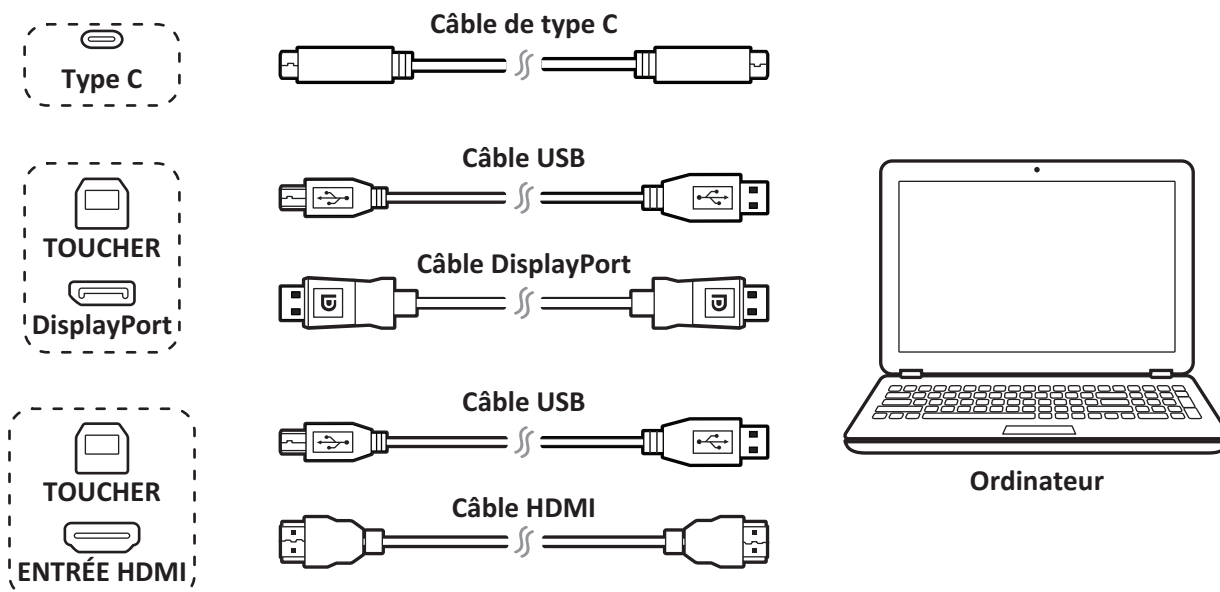

> Connexions RS232

Lorsque vous utilisez un câble de port série RS232 pour connecter votre écran à un ordinateur externe, certaines fonctions peuvent être contrôlées depuis l'ordinateur, y compris marche/arrêt, le réglage du volume, ...

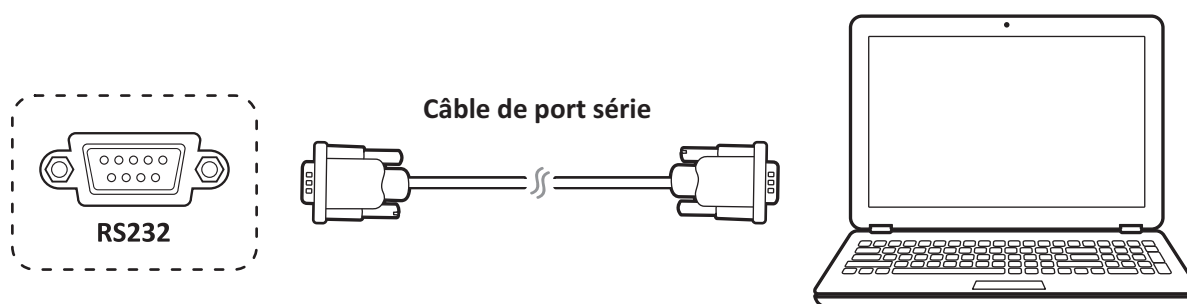

> Connexion du lecteur multimédia (audio et vidéo)

Pour connecter un lecteur multimédia :

1. Connectez le câble HDMI aux ports HDMI de votre ViewBoard et de votre périphérique.
2. Branchez le cordon d'alimentation de votre ViewBoard et allumez l'interrupteur d'alimentation du panneau arrière.
3. Appuyez sur le bouton Alimentation sur le côté droit du ViewBoard pour allumer l'écran.
4. Appuyez sur le bouton ENTRÉE de la télécommande et passez à la source d'entrée « Menu ».

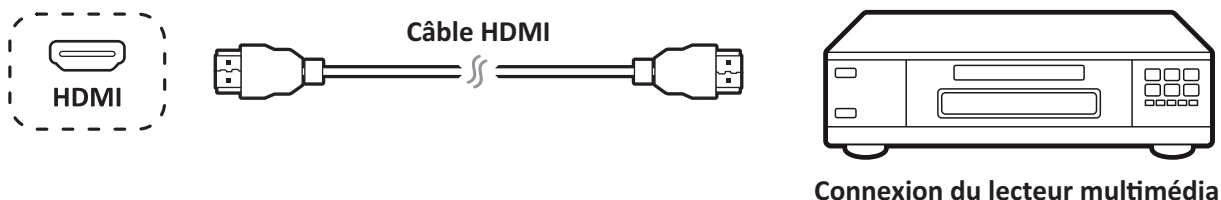

> Connexion SPDIF

Pour connecter un système de son externe :

1. Connectez un câble optique du port SPDIF au connecteur optique de votre système de son.
2. Branchez le cordon d'alimentation de votre ViewBoard et allumez l'interrupteur d'alimentation du panneau arrière.
3. Appuyez sur le bouton Alimentation sur le côté droit du ViewBoard pour allumer l'écran.

Remarque : Les sorties audio S/PDIF et des écouteurs fonctionnent uniquement sur un lecteur ViewBoard et les canaux HDMI et DP.

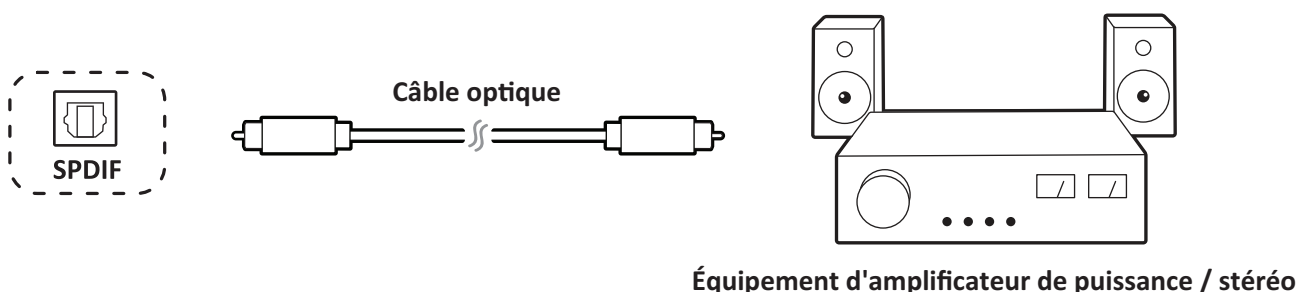

> Connexion pour la sortie vidéo

Pour afficher la vidéo sur un appareil d'affichage :

1. Connectez un câble HDMI au port ENTRÉE HDMI de votre appareil d'affichage et l'autre extrémité au port SORTIE HDMI de votre ViewBoard.
2. Pour l'audio, connectez une extrémité d'un câble audio au port EARPHONE de votre ViewBoard et l'autre extrémité à vos haut-parleurs.
3. Branchez le cordon d'alimentation de votre ViewBoard et allumez l'interrupteur d'alimentation du panneau arrière.
4. Appuyez sur le bouton Alimentation sur le côté droit du ViewBoard pour allumer l'écran.

Remarque : Les sorties audio S/PDIF et des écouteurs fonctionnent uniquement sur un lecteur ViewBoard et les canaux HDMI et DP.

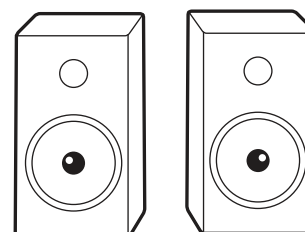
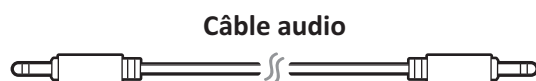

Haut-parleurs

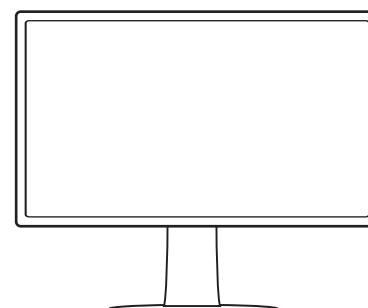
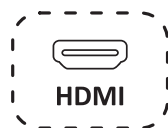

> Commencer l'utilisation

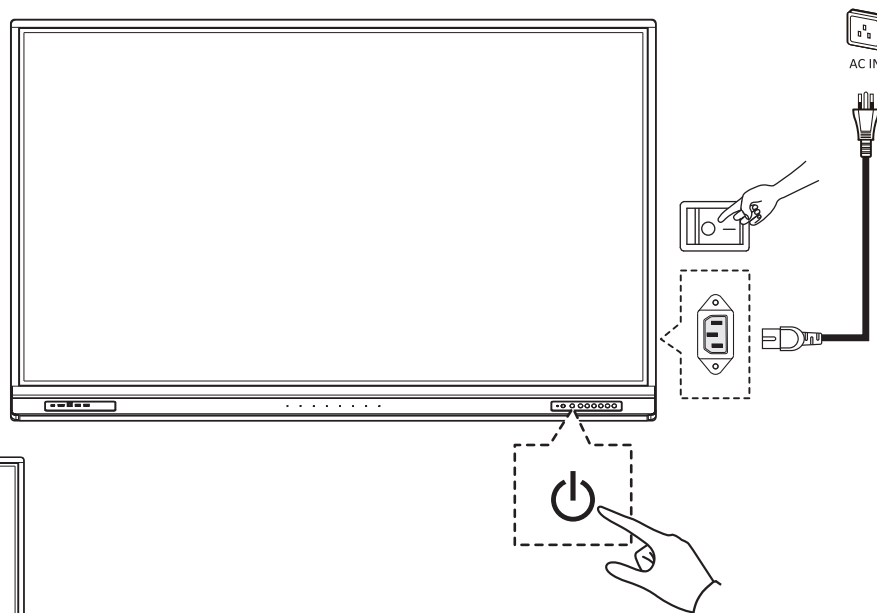
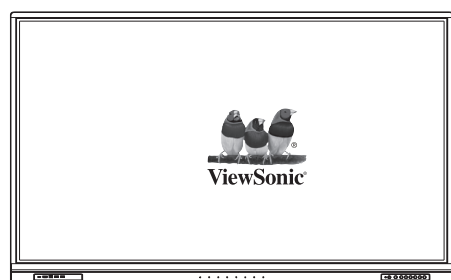



> Déclaration de conformité

Déclaration de conformité à la FCC : Cet appareil est conforme à l'article 15 des Règlements FCC. Son utilisation est soumise aux deux conditions suivantes : (1) cet appareil ne doit pas causer d'interférence nuisible et (2) cet appareil doit accepter toutes les interférences reçues, y compris les interférences pouvant causer un fonctionnement non souhaité.

Conformité à Industry Canada ICES-003 : CAN ICES-3 (B)/NMB-3(B)



ViewSonic Corporation (US/Canada/Amérique latine)

 : www.viewsonic.com/support/product-registration



États-Unis

 1-800-688-6688

 customerservice@viewsonic.com

Canada

 1-866-463-4775

 customerservice@viewsonic.com

Puerto Rico et îles Vierges

 <http://www.viewsonic.com/la/soporte/servicio-tecnico> (Español)

Amérique latine

 <http://www.viewsonic.com/la/soporte/servicio-tecnico-la/>



ViewSonic Europe Ltd.

 : www.viewsoniceurope.com

 +44 (0) 207 382 8251



Europe

 <http://www.viewsoniceurope.com/eu/support/call-desk/>



> Lieferumfang

- HDMI-Kabel (10ft/3m)
- Type-C-Kabel (5ft/1.5m)
- USB-Kabel für Touch (10ft/3m)
- Klammer x 5
- Webcam-Platte
- AAA-Batterie x 2
- Touchstift x 2
- Fernbedienung
- Radierer
- Webcam-Schraube x 4 (M4x7mm x2, M3x6mm x2)
- Schnellstartanleitung
- Konformitätserklärung
- RS232-Adapter
- Netzkabel (je nach Region unterschiedlich)
- Wandmontageschraube x 4 (M8x20mm x4)

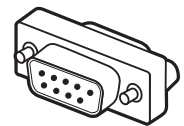
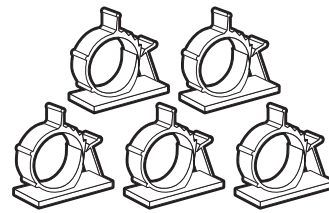
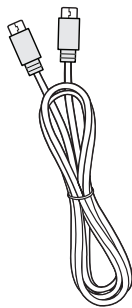
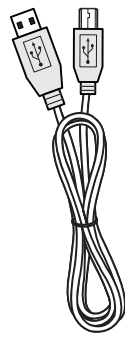
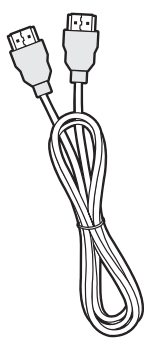
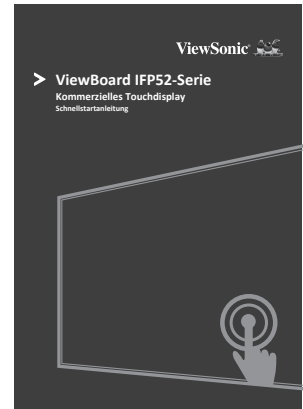
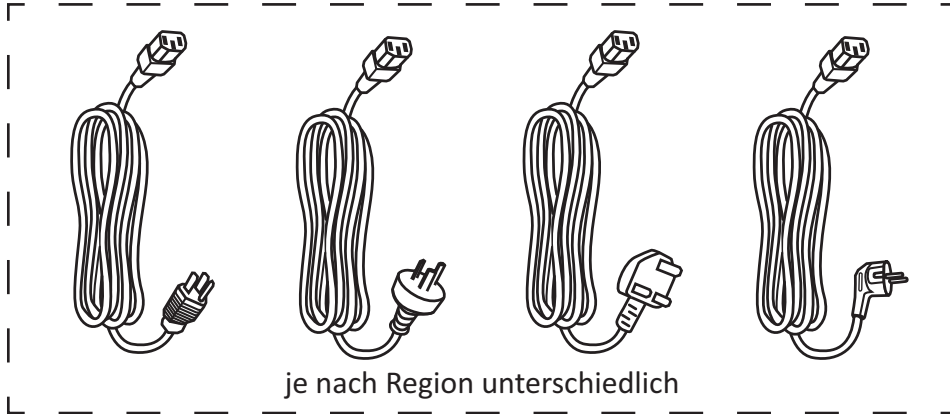

M8 X 4



M3 X 2



M4 X 2

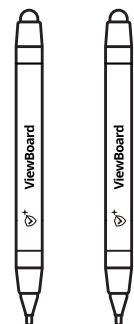
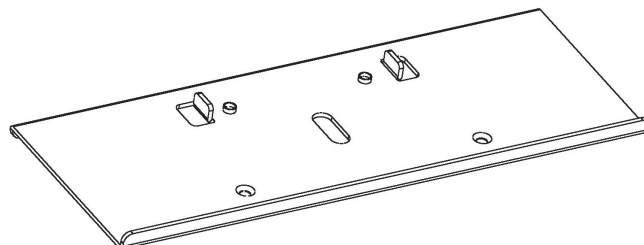
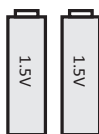
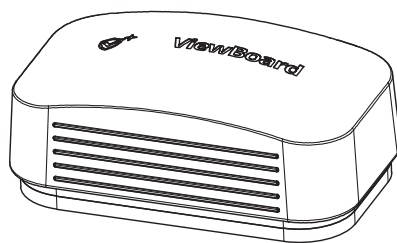

➤ Wandmontageset – Spezifikationen (separat erhältlich)

DEUTSCH

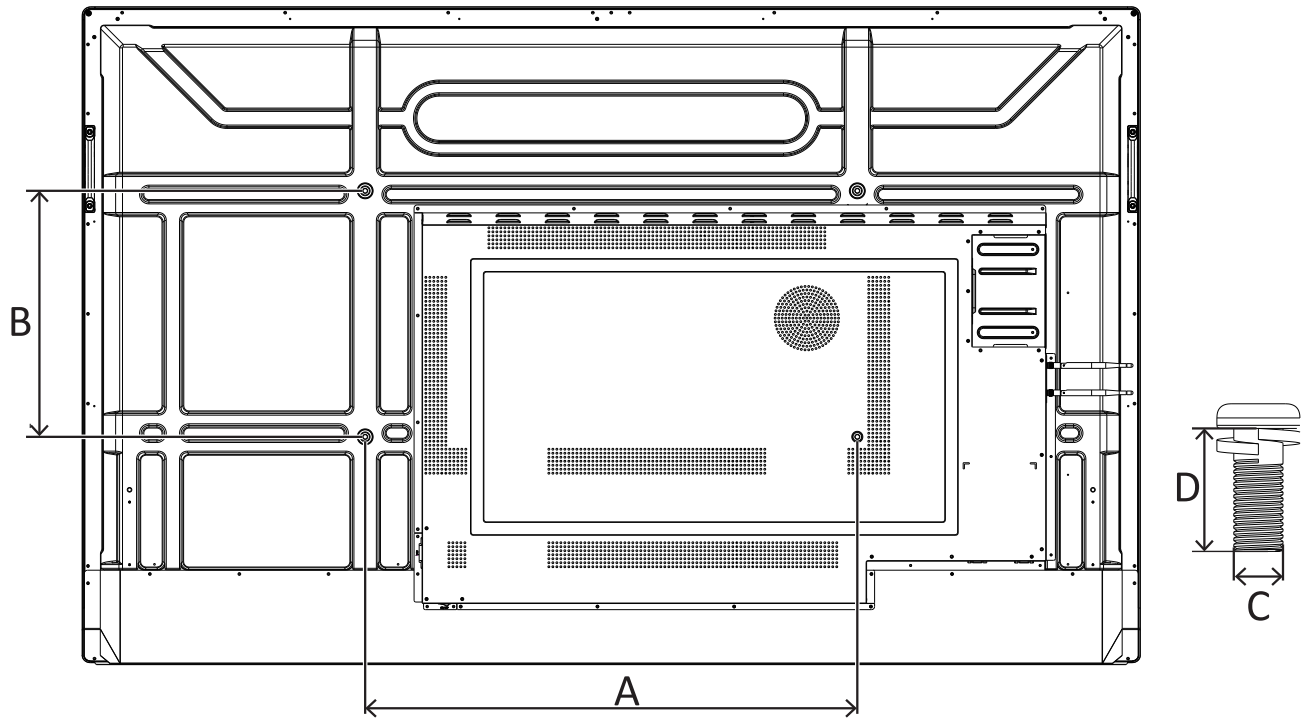

Zoll	VESA-Spezifikationen (A × B)	Standardschraube (C × D)	Menge
IFP6552-Serie	600 × 400 mm	M8 x 20 mm	4
IFP7552-Serie	800 × 400 mm	M8 x 20 mm	4
IFP8652-Serie	800 × 600 mm	M8 x 20 mm	4

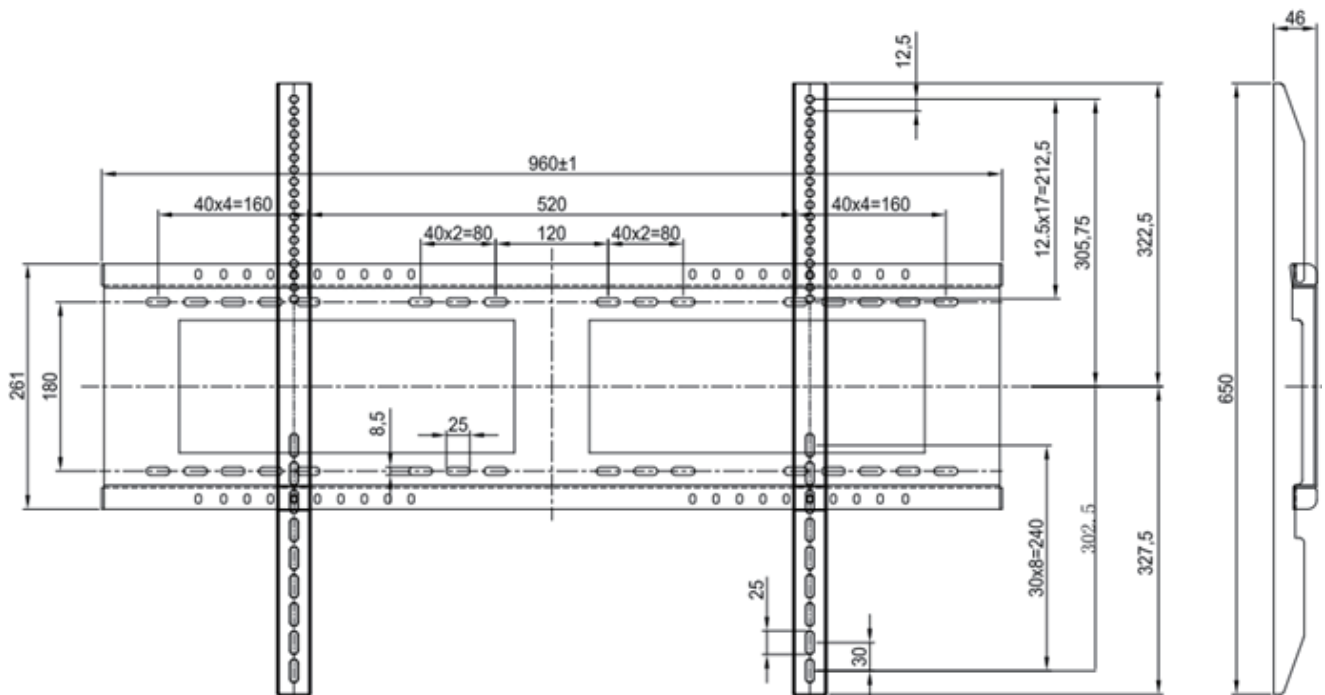

> Warnhinweise zur Installationsumgebung

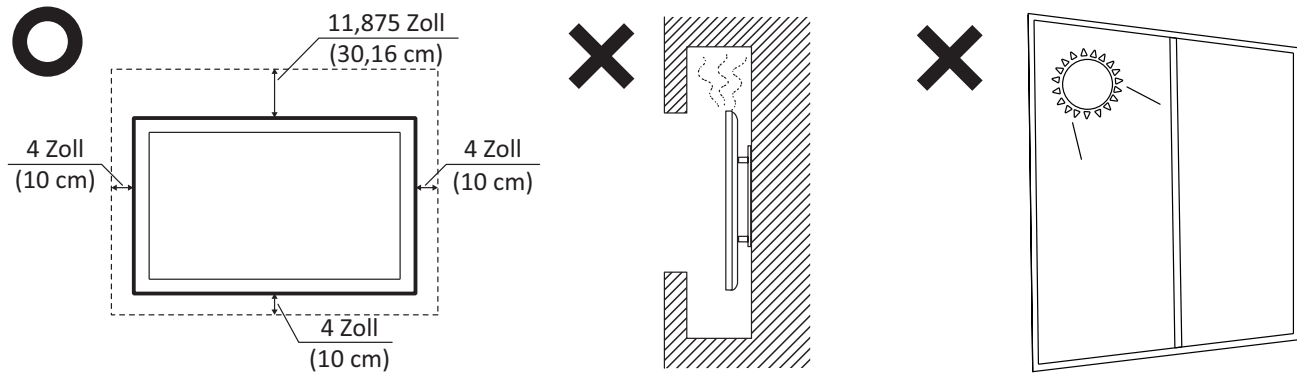

> Bedienfeldübersicht

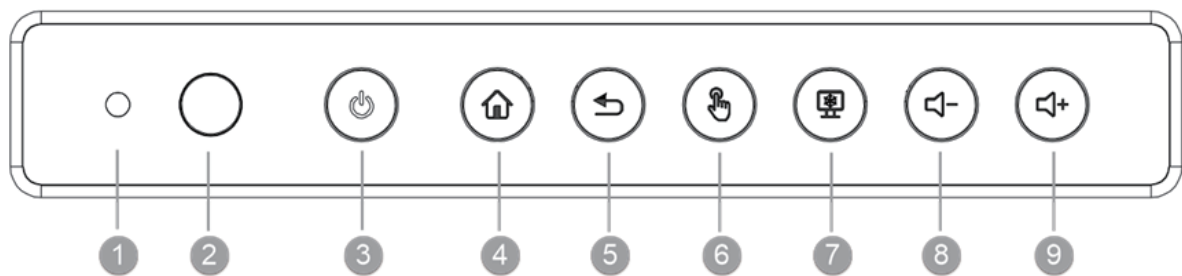

Element	Beschreibung
1	Umgebungslichtsensor zur Überwachung des Umgebungslichts
2	Fernbedienungsempfänger
3	Betriebsanzeige Kurz drücken: Zum Einschalten des Gerätes. Taste zum alleinigen Ein-/Aus-switchen der Anzeigehintergrundbeleuchtung drücken Gedrückt halten: Schaltet das Gerät ab.
4	Zurück zur Hauptschnittstelle des ViewBoard-Players
5	Zurück zur vorherigen Ebene des ViewBoard-Players
6	Touchscreen de-/aktivieren
7	Aktuelles Bild am Bildschirm einfrieren
8	Lautstärke verringern
9	Lautstärke erhöhen

> Übersicht über die Fernbedienung

- 1 Ein- und Ausschalten
- 2 Bildschirmaufnahme
- 3 *PC: Windows-Taste
- 4 Schreiben starten
- 5 Zur Startseite des eingebetteten Players zurückkehren
- 6 Zurück / zur vorherigen Seite zurückkehren
- 7 Lautstärke erhöhen / verringern
- 8 Zahlenfeld
- 9 Informationen
- 10 Eingangsquellenwahl
- 11 Mediensteuerungstaste
Rot: Wiedergabe / Pause
Grün: Stopp
Gelb: Vorwärts
Blau: Rückwärts
- 12 *PC: Menütaste
- 13 *PC: Dialogfenster beenden
- 14 Einstellungsmenü
- 15 Tasten Oben/Unten/Rechts/Links/OK
- 16 Bildschirm einfrieren
- 17 Stummschaltung ein / aus
- 18 Helligkeit erhöhen / verringern
*PC: Seite nach oben / Seite nach unten
- 19 Leeranzeige
- 20 Anpassen des Seitenverhältnisses.

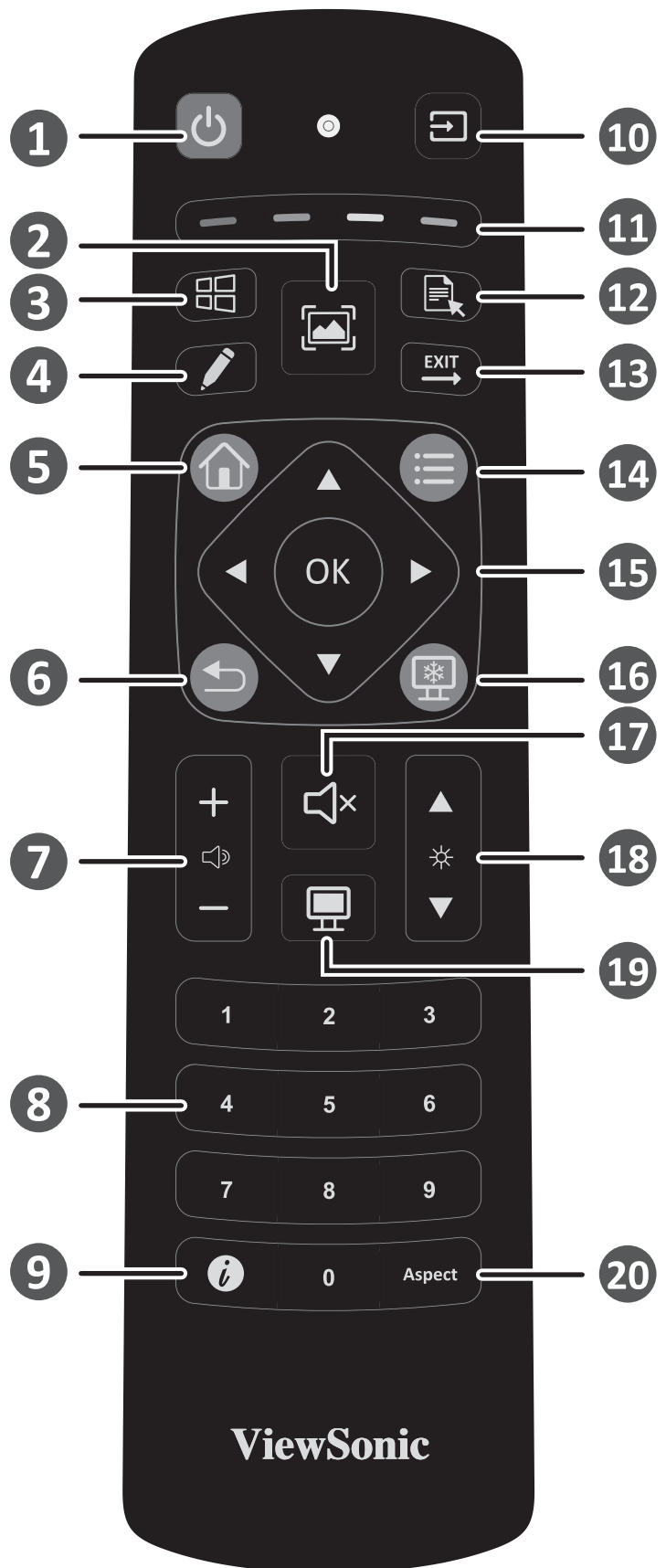

*PC-Taste: Nicht alle Modelle unterstützen diese Funktionen

> I/O-Anschlüsse

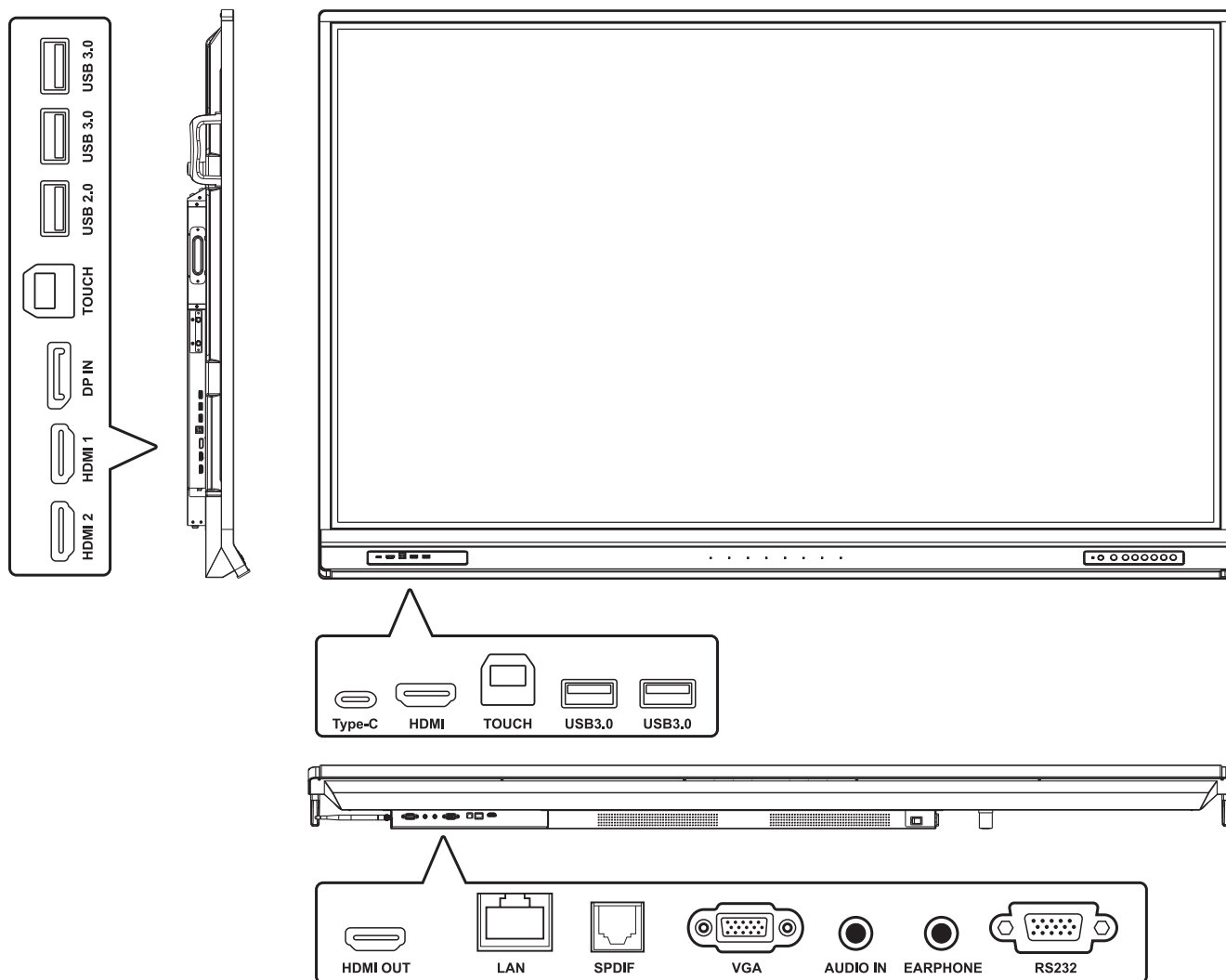

> USB- und Netzwerkverbindungen

An Ihr ViewBoard können Sie unterschiedlichste USB-Geräte und andere Peripherie anschließen, wie bei jedem PC.

USB-Peripherie

Verbinden Sie den USB-Stecker des Gerätes mit dem USB-Port.

Netzwerk- und Modemkabel

Schließen Sie das Router-Kabel an den LAN-Anschluss an.

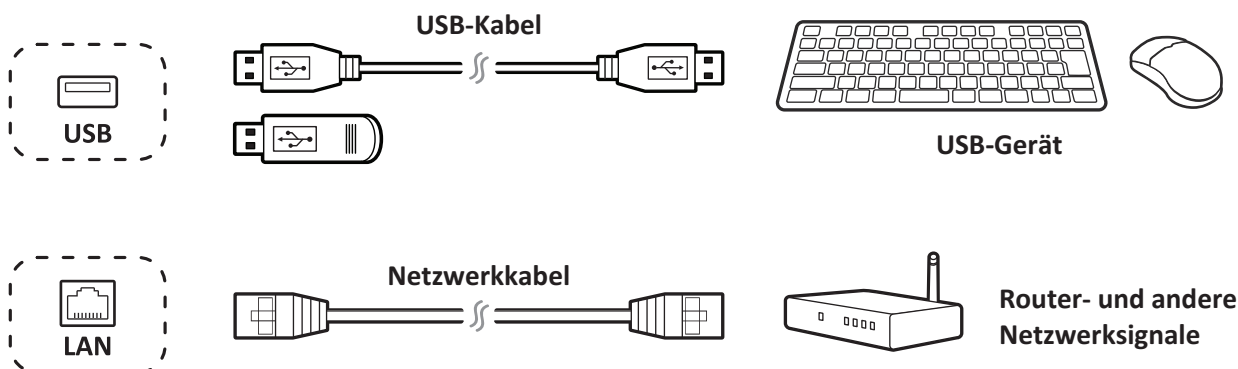

> Externe Geräte verbinden und Touch-Verbindung herstellen

Ihr(e) externes/externen Gerät(e) können in einer der folgenden Konfigurationen verbunden werden:

Type-C-Verbindung

Verbinden Sie ein Type-C-Kabel von Ihrem externen Gerät mit dem Type-C-Anschluss am ViewBoard.

DisplayPort-Verbindung

1. Verbinden Sie Ihr externes Gerät über ein DisplayPort-Kabel mit dem DisplayPort-Anschluss des ViewBoard.
2. Verbinden Sie das externe Gerät per USB-Kabel mit dem Touch-Ausgang (TOUCH) des ViewBoard.

HDMI-Verbindung

1. Verbinden Sie Ihr externes Gerät über ein HDMI-Kabel mit dem HDMI IN (HDMI-Eingang) des ViewBoard.
2. Verbinden Sie das externe Gerät per USB-Kabel mit dem Touch-Ausgang (TOUCH) des ViewBoard.

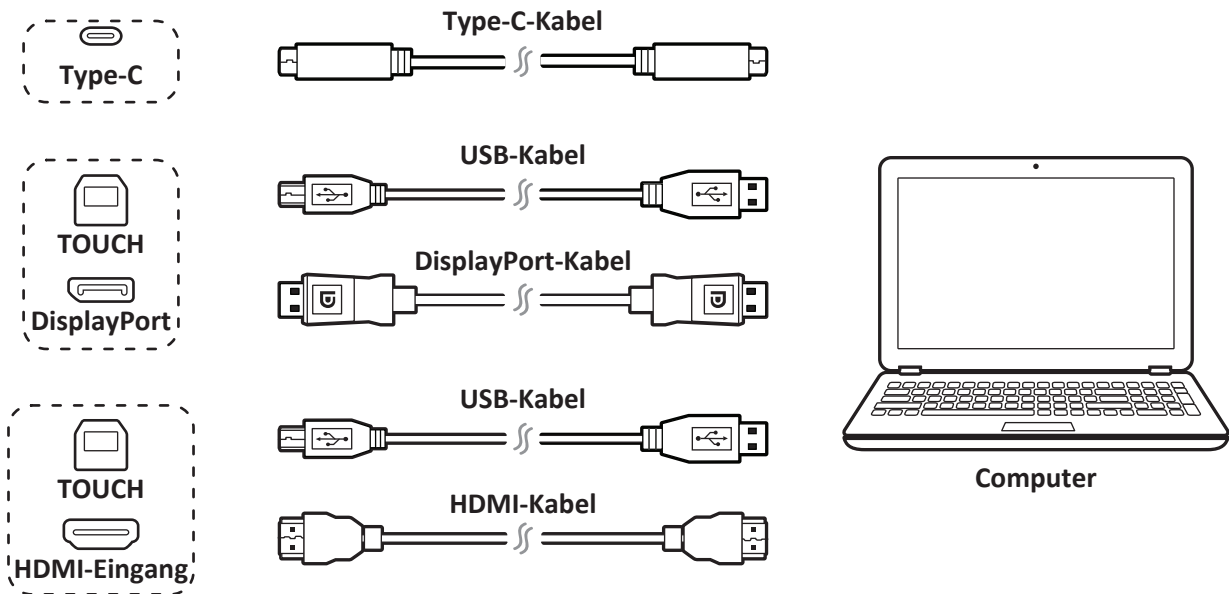

> RS-232-Verbindungen

Wenn Sie Ihr Display über ein serielles RS232-Kabel mit einem externen Computer verbinden, können Sie bestimmte Funktionen per PC steuern – beispielsweise Ein-/Ausschalten, Lautstärkeregelung und mehr.

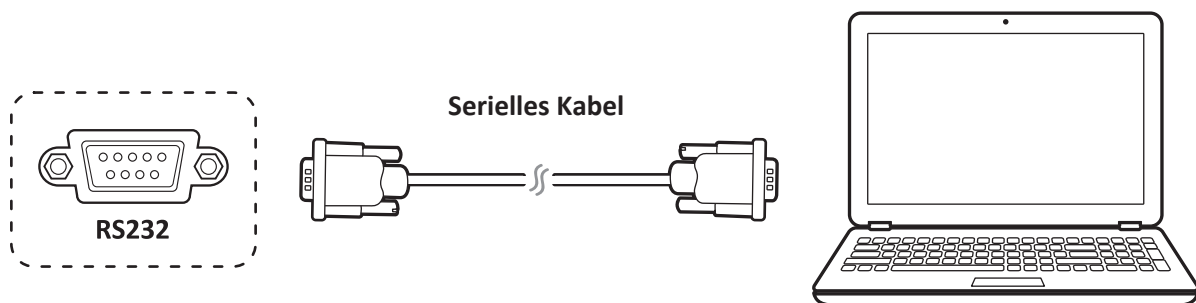

> Medienplayer (Audio und Video) anschließen

So stellen Sie eine Verbindung zum Media Player her:

1. Verbinden Sie die HDMI-Anschlüsse Ihres ViewBoard über ein HDMI-Kabel mit dem externen Gerät.
2. Schließen Sie das Netzkabel Ihres ViewBoard an, schalten Sie das Gerät mit dem Ein-/Ausshalter an der Rückwand ein.
3. Schalten Sie das ViewBoard mit der Ein-/Austaste an der rechten Seite des Gerätes ein.
4. Drücken Sie die INPUT-Taste an der Fernbedienung und schalten Sie zur „HDMI“-Eingangsquelle um.

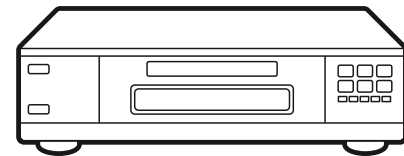
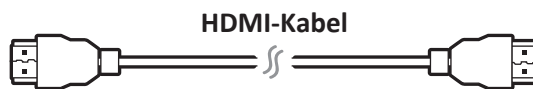
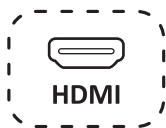

Medienplayer

> SPDIF-Verbindung

So stellen Sie eine Verbindung zu einem externen Soundsystem her:

1. Verbinden Sie den SPDIF-Anschluss über ein optisches Kabel mit dem optischen Anschluss Ihres Audiosystems.
2. Schließen Sie das Netzkabel Ihres ViewBoard an, schalten Sie das Gerät mit dem Ein-/Ausshalter an der Rückwand ein.
3. Schalten Sie das ViewBoard mit der Ein-/Austaste an der rechten Seite des Gerätes ein.

Hinweis: S/PDIF und Kopfhörer-Audioausgang funktionieren nur bei ViewBoard Player, HDMI und DP-Kanal.

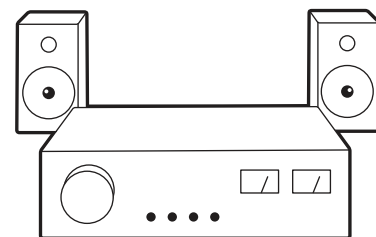

Verstärker/Stereoanlage

> Verbindung mit Videoausgang

So geben Sie Video über ein Anzeigegerät aus:

1. Verbinden Sie ein HDMI-Kabel mit dem HDMI-Eingang (HDMI IN) Ihres Anzeigegerätes und das andere Ende mit dem HDMI-Ausgang (HDMI OUT) Ihres ViewBoard.
2. Verbinden Sie bei Audio ein Ende eines Audiokabels mit dem EARPHONE Ihres ViewBoard und das andere Ende mit Ihren Lautsprechern.
3. Schließen Sie das Netzkabel Ihres ViewBoard an, schalten Sie das Gerät mit dem Ein-/Ausmacher an der Rückwand ein.
4. Schalten Sie das ViewBoard mit der Ein-/Austaste an der rechten Seite des Gerätes ein.

Hinweis: S/PDIF und Kopfhörer-Audioausgang funktionieren nur bei ViewBoard Player, HDMI und DP-Kanal.

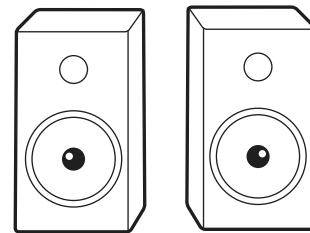

Lautsprecher

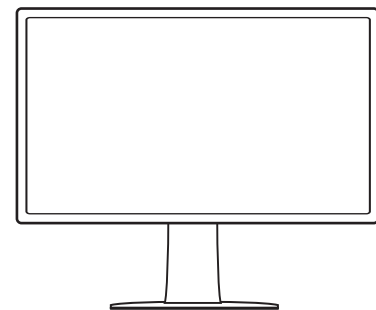
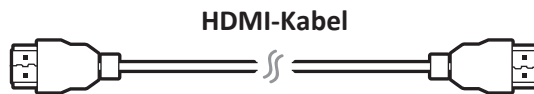

> Mit der Nutzung beginnen

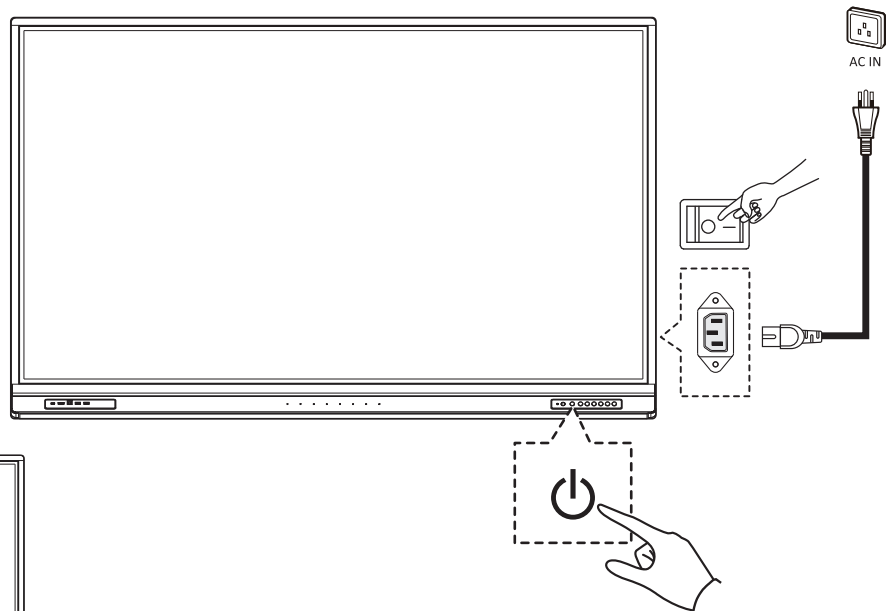
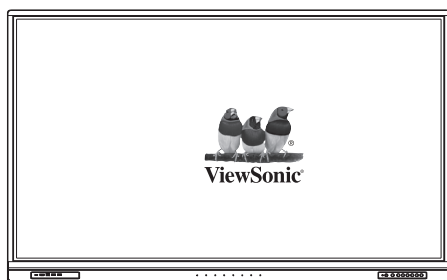



> Konformitätserklärung

FCC-Erklärung: Dieses Gerät erfüllt Teil 15 der FCC-Regularien. Der Betrieb unterliegt den folgenden beiden Voraussetzungen: (1) Dieses Gerät darf keine Störungen verursachen, und (2) dieses Gerät muss jegliche empfangenen Störungen hinnehmen, einschließlich Störungen, die zu unbeabsichtigtem Betrieb führen können.

Konformität mit Industry Canada ICES-003: CAN ICES-3 (B)/NMB-3(B)



ViewSonic Corporation (USA/Kanada/Lateinamerika)

 : www.viewsonic.com/support/product-registration



Vereinigte Staaten

 1-800-688-6688

 customerservice@viewsonic.com

Kanada

 1-866-463-4775

 customerservice@viewsonic.com

Puerto Rico und Jungferninseln

 <http://www.viewsonic.com/la/soporte/servicio-tecnico> (Español)

Lateinamerika

 <http://www.viewsonic.com/la/soporte/servicio-tecnico-la/>



ViewSonic Europe Ltd.

 : www.viewsoniceurope.com

 +44 (0) 207 382 8251



Europe

 <http://www.viewsoniceurope.com/eu/support/call-desk/>



ViewSonic-Kundencenter



Optionales Zubehör

> Isi Kemasan

- Kabel HDMI (10ft/3m)
- Kabel tipe-c (5ft/1.5m)
- Kabel USB untuk sentuh (10ft/3m)
- Penjepit x 5
- Pelat webcam
- Baterai AAA x 2
- Pena sentuh x 2
- Remote control
- Penghapus
- Sekrup webcam x 4 (M4x7mm x2, M3x6mm x2)
- Panduan mulai ringkas
- Pernyataan kepatuhan
- Adaptor RS232
- Kabel daya (dikirim sesuai wilayah)
- Sekrup pemasangan dinding x 4 (M8x20mm x4)

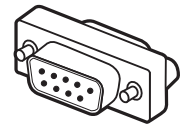
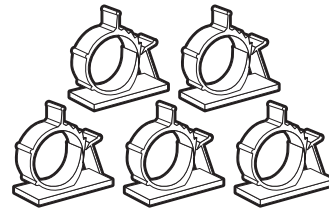
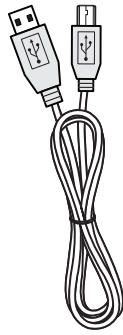
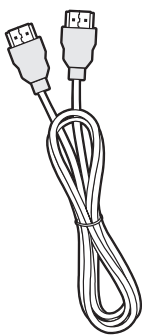
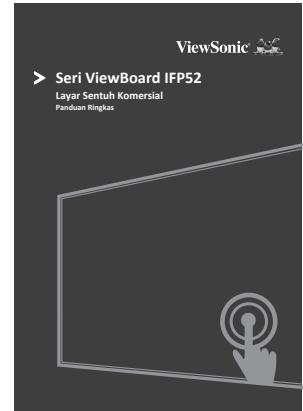
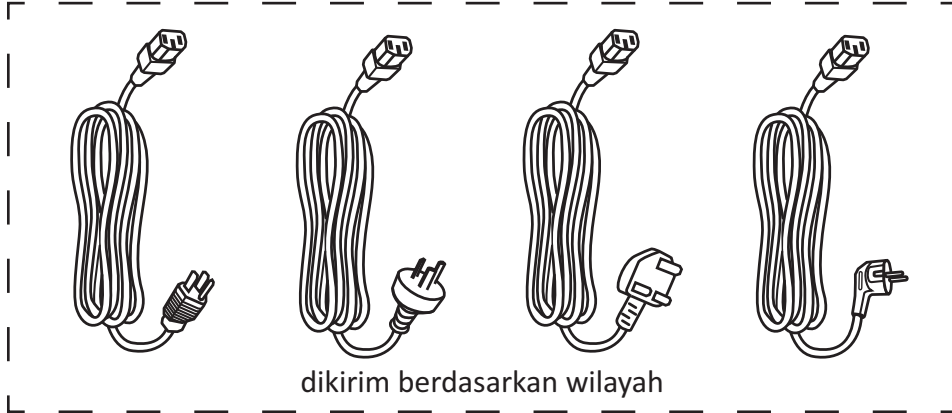

M8 X 4



M3 X 2



M4 X 2

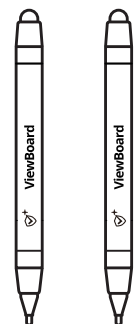
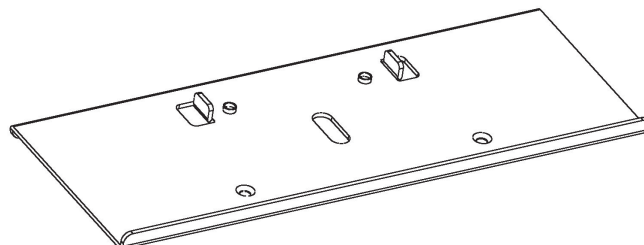
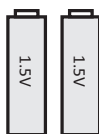
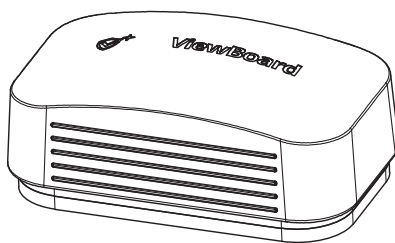

> Perhatian Lingkungan Pemasangan

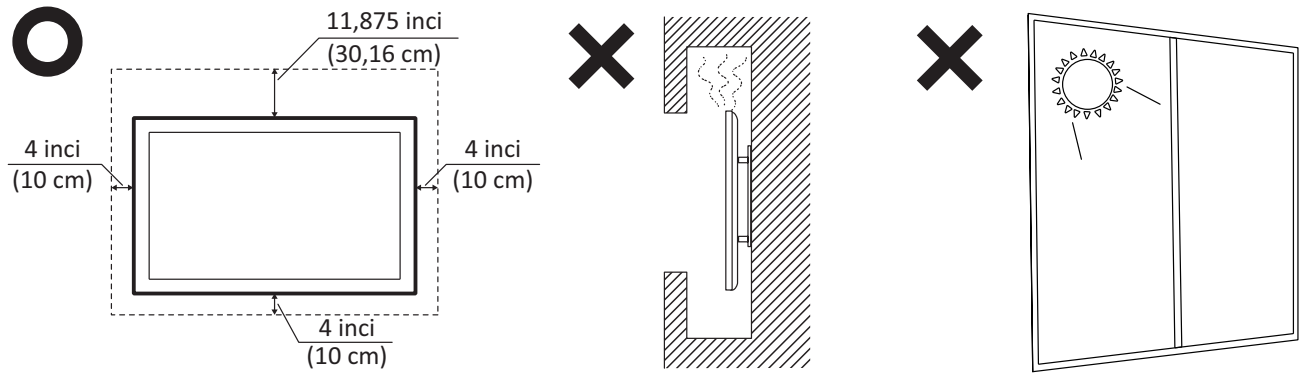

> Ikhtisar Panel Kontrol

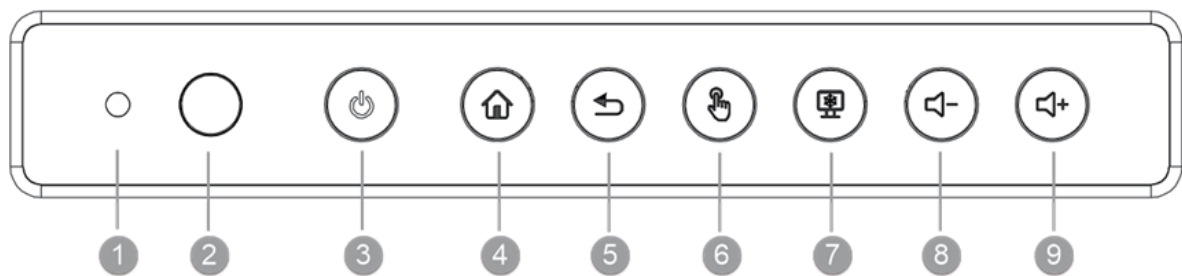

Item	Keterangan
1	Sensor cahaya sekitar untuk memantau cahaya sekitar
2	Penerima remote control
3	Lampu indikator daya Tekan tombol ini untuk mengaktifkan perangkat. Tekan tombol ini untuk mengaktifkan/menonaktifkan lampu latar monitor saja. Tekan dan tahan tombol untuk menonaktifkan perangkat.
4	Kembali ke antarmuka utama pemutar ViewBoard
5	Kembali ke tingkat sebelumnya pemutar ViewBoard
6	Nonaktifkan/aktifkan layar sentuh
7	Bekukan gambar saat ini di layar
8	Kurangi Volume
9	Tambah Volume

> Ikhtisar Remote Control

- 1 Daya hidup/mati
- 2 Rekaman layar
- 3 *PC: Tombol "Windows"
- 4 Menulis Startup
- 5 Kembali ke Layar Beranda pemutar Tertanam
- 6 Mundur / Kembali ke halaman sebelumnya
- 7 Memperbesar/Memperkecil volume suara
- 8 Keypad Angka
- 9 Informasi
- 10 Pemilihan sumber input
- 11 Tombol kontrol media
Merah: PUTAR/JEDA
Hijau: BERHENTI
Kuning: MAJU
Biru: MUNDUR
- 12 *PC: Tombol "Menu"
- 13 *PC: Keluar dari kotak dialog
- 14 Menu Pengaturan
- 15 Tombol Naik/Turun/Kanan/Kiri/OK
- 16 Bekukan Layar
- 17 Senyap/Tidak senyap
- 18 Menambah / Mengurangi kecerahan
*PC: Page Up / Page Down
- 19 Layar Kosong
- 20 Menyesuaikan rasio aspek

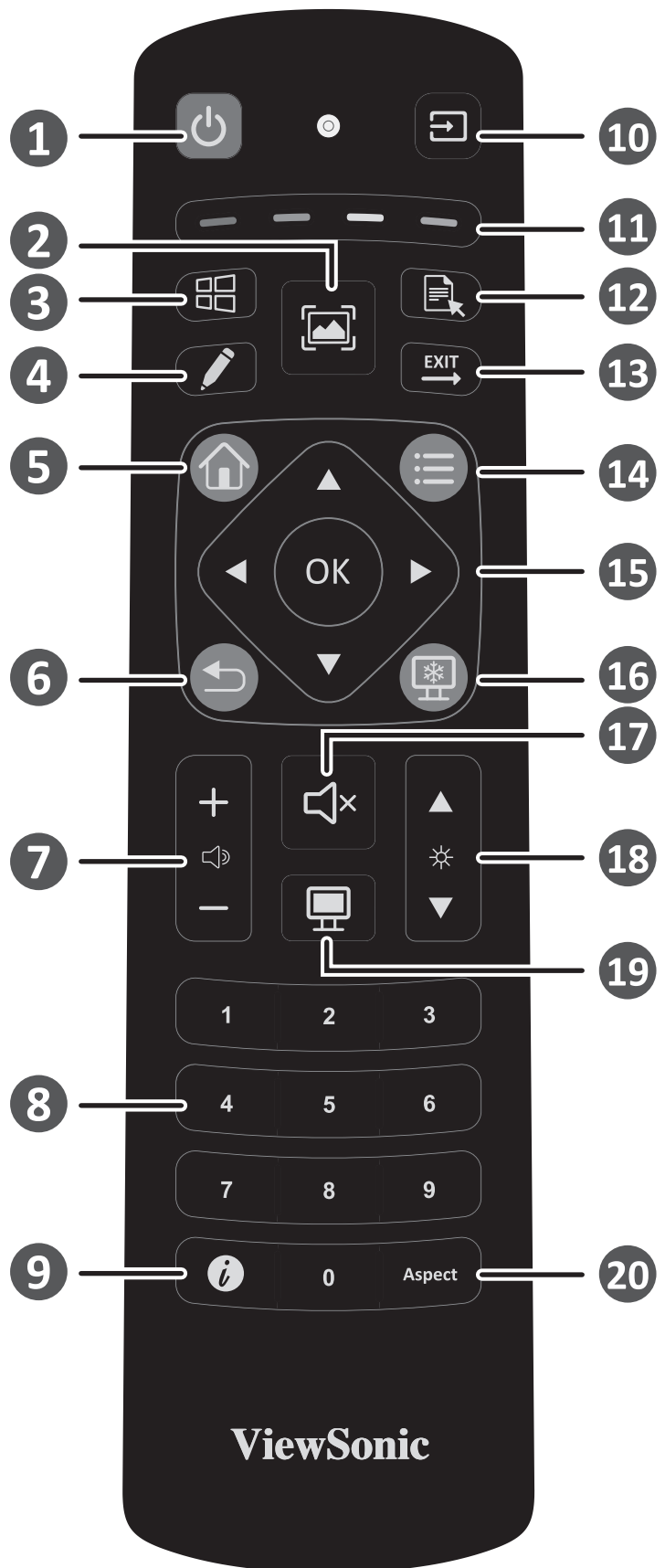

*Tombol PC: Tidak semua model mendukung fungsi ini

➤ Port I/O

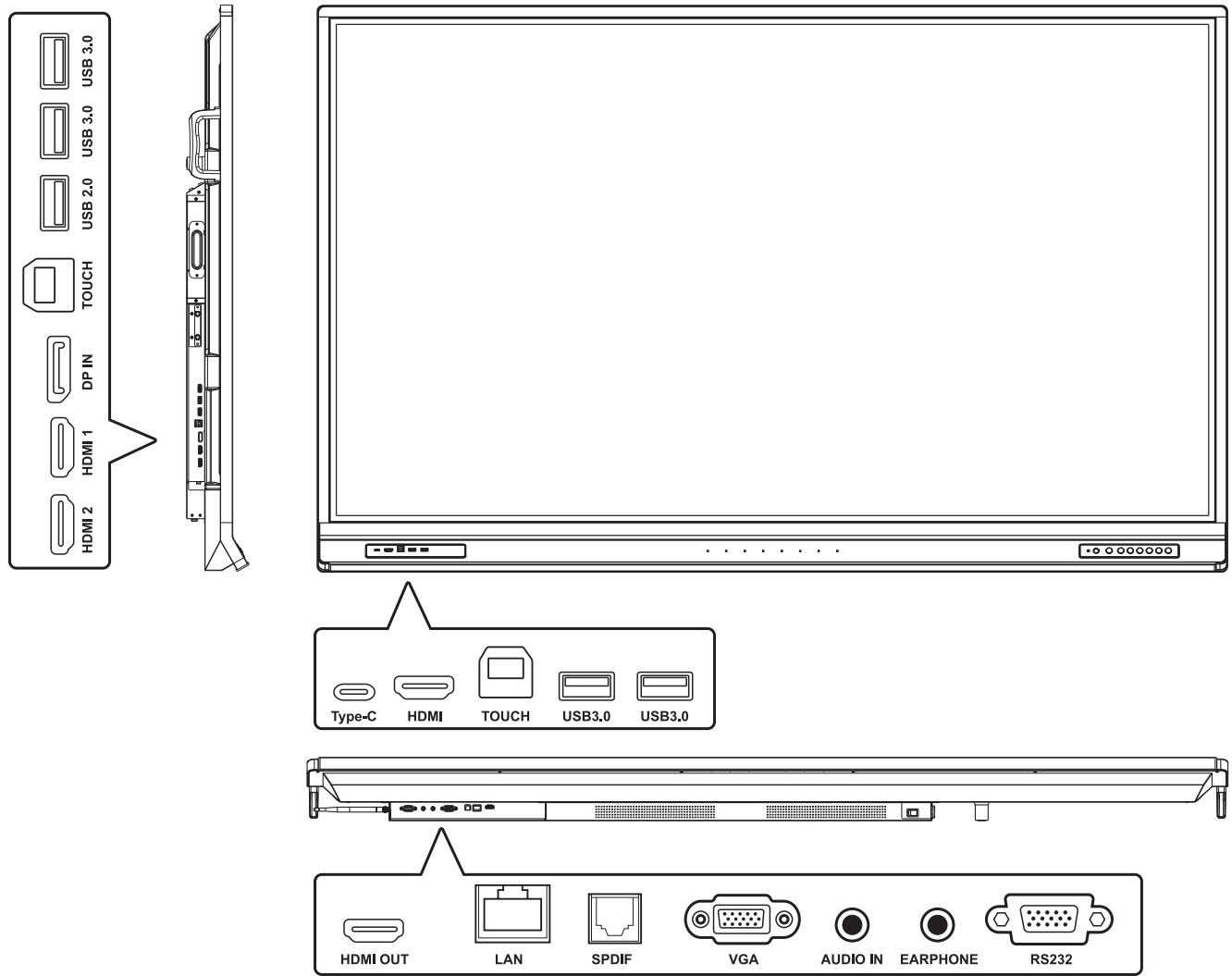

➤ USB dan Koneksi Jaringan

Sama seperti PC manapun, mudah untuk menyambungkan berbagai perangkat USB dan periferan lain ke ViewBoard Anda.

Periferal USB

Colokkan kabel perangkat USB ke port USB.

Kabel Jaringan dan Modem

Colokkan kabel router ke port LAN.

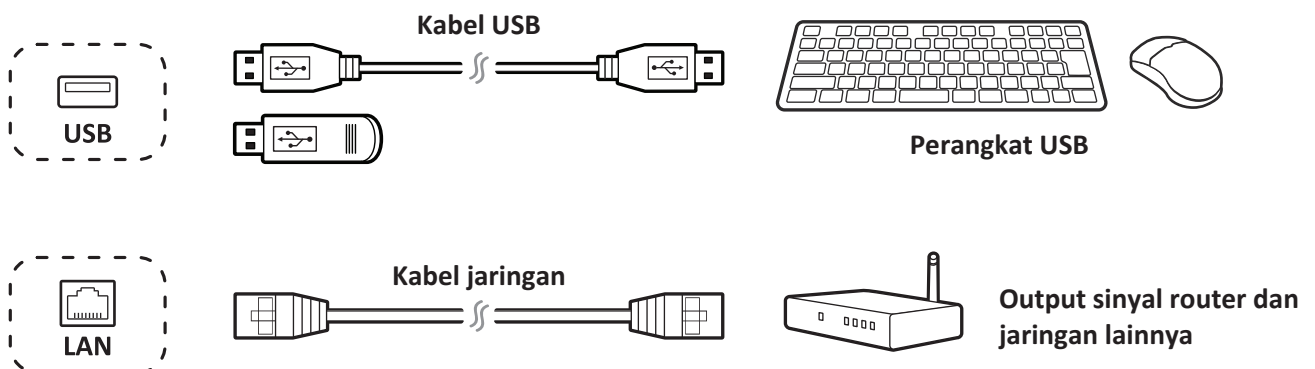

> Menyambungkan Perangkat Eksternal dan Sambunga Sentuh

Perangkat eksternal Anda bisa disambungkan dengan konfigurasi berikut:

Sambungan Tipe C

Sambungkan kabel Tipe C dari perangkat eksternal Anda ke port Tipe C di ViewBoard.

Sambungan DisplayPort

1. Sambungkan kabel DisplayPort dari perangkat eksternal Anda ke port DisplayPort di ViewBoard.
2. Sambungkan kabel USB dari perangkat eksternal Anda ke port TOUCH di ViewBoard.

Sambungan HDMI

1. Sambungkan kabel HDMI dari perangkat eksternal Anda ke port HDMI IN di ViewBoard.
2. Sambungkan kabel USB dari perangkat eksternal Anda ke port TOUCH di ViewBoard.

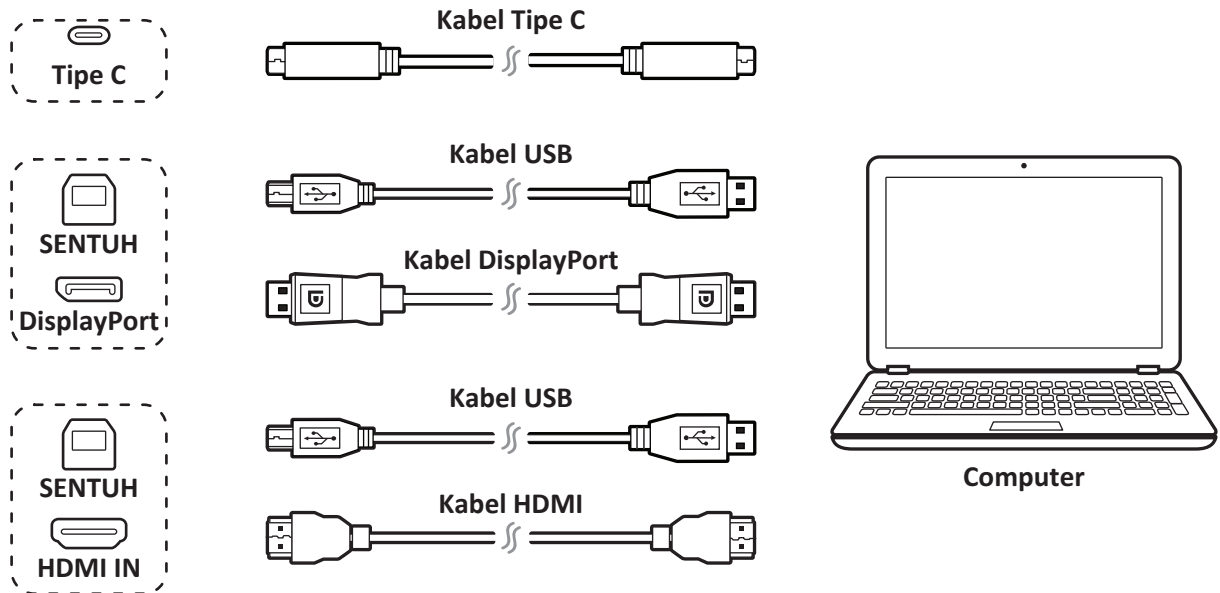

> Sambungan RS232

Ketika Anda menggunakan kabel port serial RS232 untuk menyambungkan monitor ke komputer eksternal, beberapa fungsi bisa dikendalikan oleh PC, termasuk daya hidup/mati, penyesuaian volume dan banyak lagi.

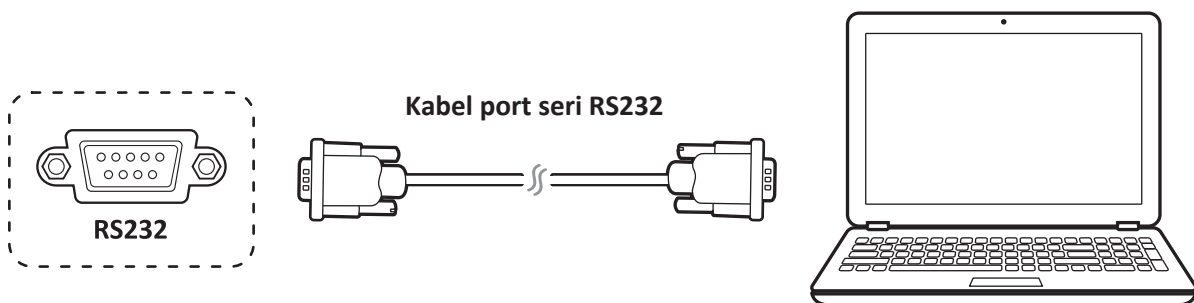

> Sambungan Pemutar Media (Audio dan Video)

Untuk menyambung ke pemutar media:

1. Sambungkan kabel HDMI ke port HDMI di ViewBoard Anda dan perangkat periferan Anda.
2. Colokkan kabel daya ViewBoard Anda, dan nyalakan sakelar catu daya panel belakang.
3. Tekan tombol Daya di sisi kanan ViewBoard untuk mengaktifkan layar.
4. Tekan tombol INPUT pada remote control dan beralih ke sumber input "HDMI".

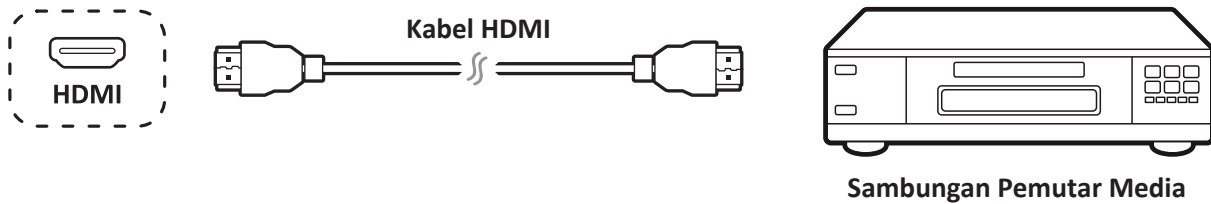

> Sambungan SPDIF

Untuk menyambungkan ke sound system eksternal:

1. Sambungkan kabel optik dari port SPDIF ke konektor optik sistem suara.
2. Colokkan kabel daya ViewBoard Anda, dan nyalakan sakelar catu daya panel belakang.
3. Tekan tombol Daya di sisi kanan ViewBoard untuk mengaktifkan layar.

Catatan: Output audio S/PDIF & Earphone bekerja pada Pemutar ViewBoard, HDMI, dan saluran DP saja.

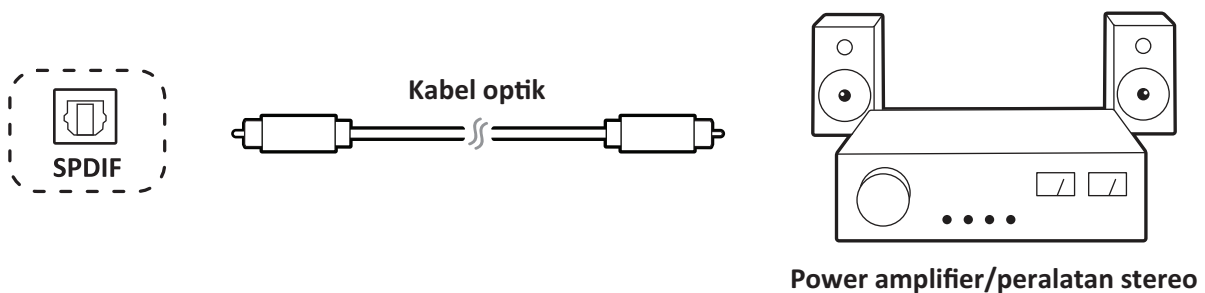

> Sambungan Output Video

Mengeluarkan video melalui perangkat layar:

1. Sambungkan kabel HDMI ke port HDMI IN perangkat monitor Anda, dan di ujung lain port HDMI OUT ViewBoard Anda.
2. Untuk audio, sambungkan satu ujung kabel audio ke port EARPHONE ViewBoard dan ujung lain ke speaker Anda.
3. Colokkan kabel daya ViewBoard Anda, dan nyalakan sakelar catu daya panel belakang.
4. Tekan tombol Daya di sisi kanan ViewBoard untuk mengaktifkan layar.

Catatan: Output audio S/PDIF & Earphone bekerja pada Pemutar ViewBoard, HDMI, dan saluran DP saja.

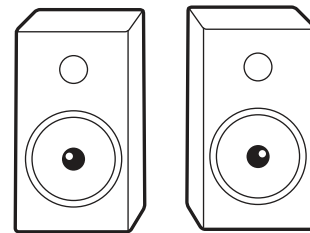

Speaker

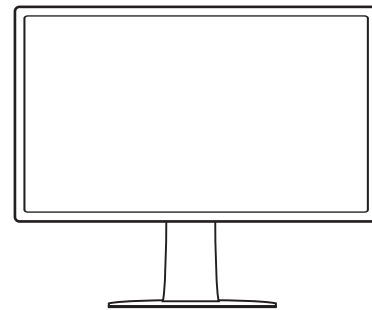
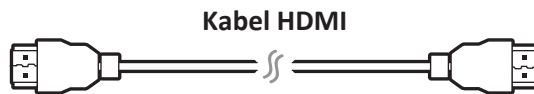

> Mulai Menggunakan

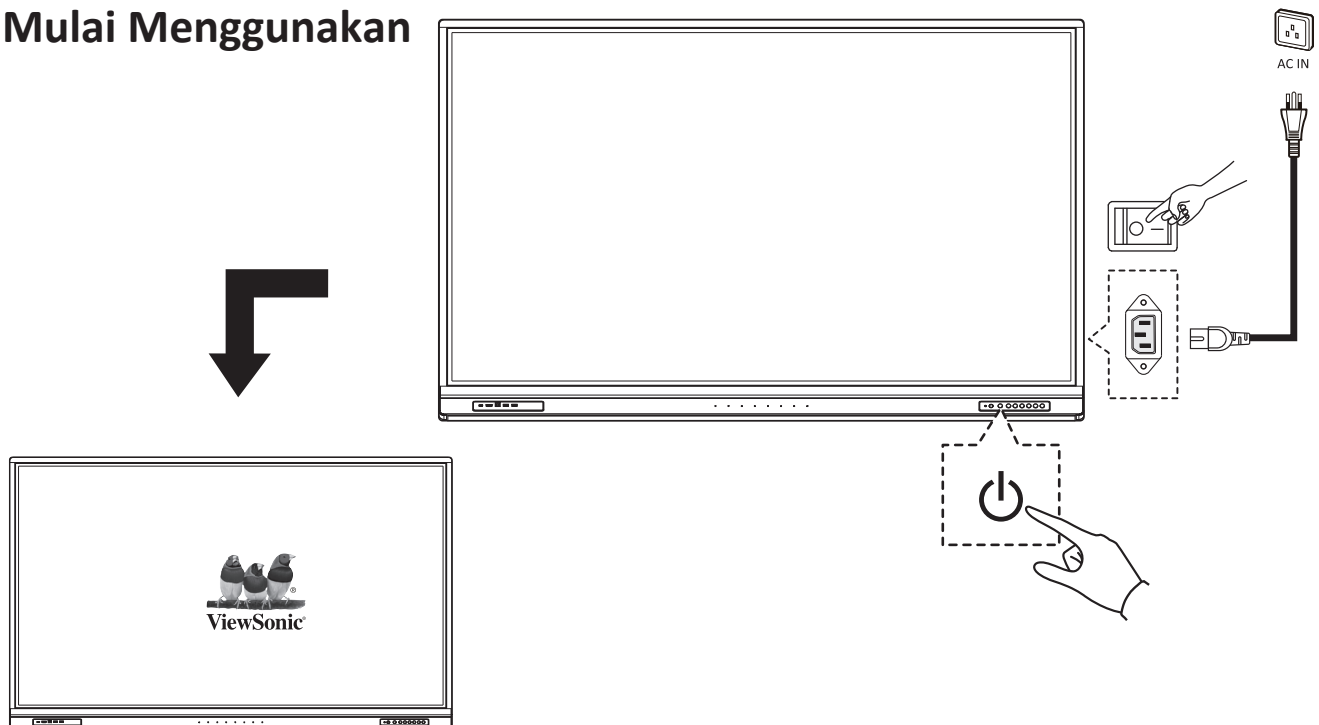



> Pernyataan Kesesuaian

Pernyataan Kepatuhan FCC: Perangkat ini sesuai dengan pasal 15 Peraturan FCC. Pengoperasian harus memenuhi dua kondisi sebagai berikut: (1) perangkat ini tidak boleh menimbulkan interferensi berbahaya, dan (2) perangkat ini harus menerima semua interferensi yang ditangkap, termasuk interferensi yang dapat mengakibatkan pengoperasian yang tidak diinginkan.

Kepatuhan Industry Canada ICES-003: CAN ICES-3 (B)/NMB-3(B)



ViewSonic Corporation (AS/Kanada/Amerika Latin)

 : www.viewsonic.com/support/product-registration



Amerika Serikat

 1-800-688-6688

 customerservice@viewsonic.com

Kanada

 1-866-463-4775

 customerservice@viewsonic.com

Puerto Riko & Kepulauan Virgin

 <http://www.viewsonic.com/la/soporte/servicio-tecnico> (Español)

Amerika Latin

 <http://www.viewsonic.com/la/soporte/servicio-tecnico-la/>



Pusat Dukungan ViewSonic



Aksesori Opsional

Hak Cipta © 2021 ViewSonic Corporation. Semua hak dilindungi undang-undang.

IFP52 series_QSG_1a_IND_20201215

> Contenuti della confezione

- Cavo HDMI (10ft/3m)
- Cavo tipo C (5ft/1.5m)
- Cavo USB per tocco (10ft/3m)
- Morsetto x 5
- Piastra webcam
- Batteria AAA x2
- Stilo x2
- Telecomando
- Gomma
- Viti webcam x4 (M4x7mm x2, M3x6mm x2)
- Guida rapida
- Dichiarazione di conformità
- Adattatore RS232
- Cavo d'alimentazione (dipende da regione)
- Viti montaggio a parete x4 (M8x20mm x4)

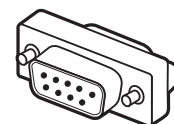
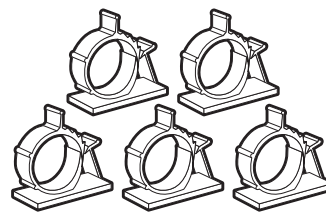
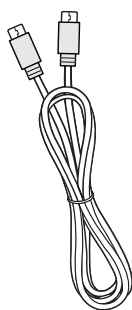
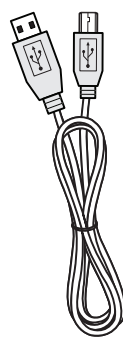
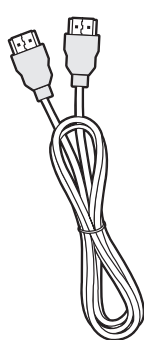
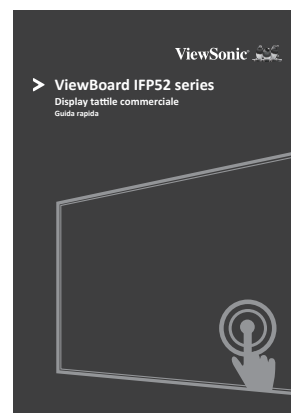
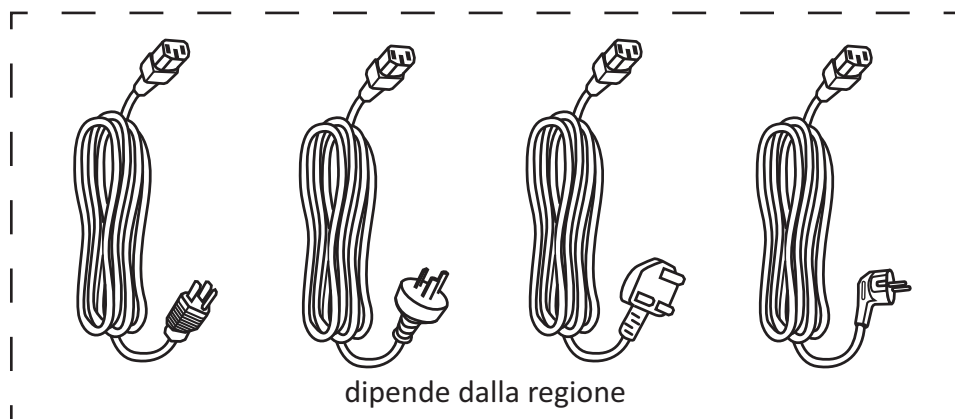

M8 X 4



M3 X 2



M4 X 2

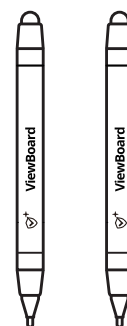
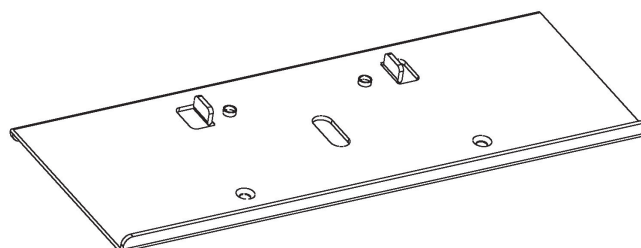
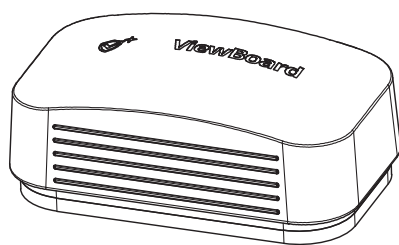

➤ Specifiche kit montaggio a parete (venduto separatamente)

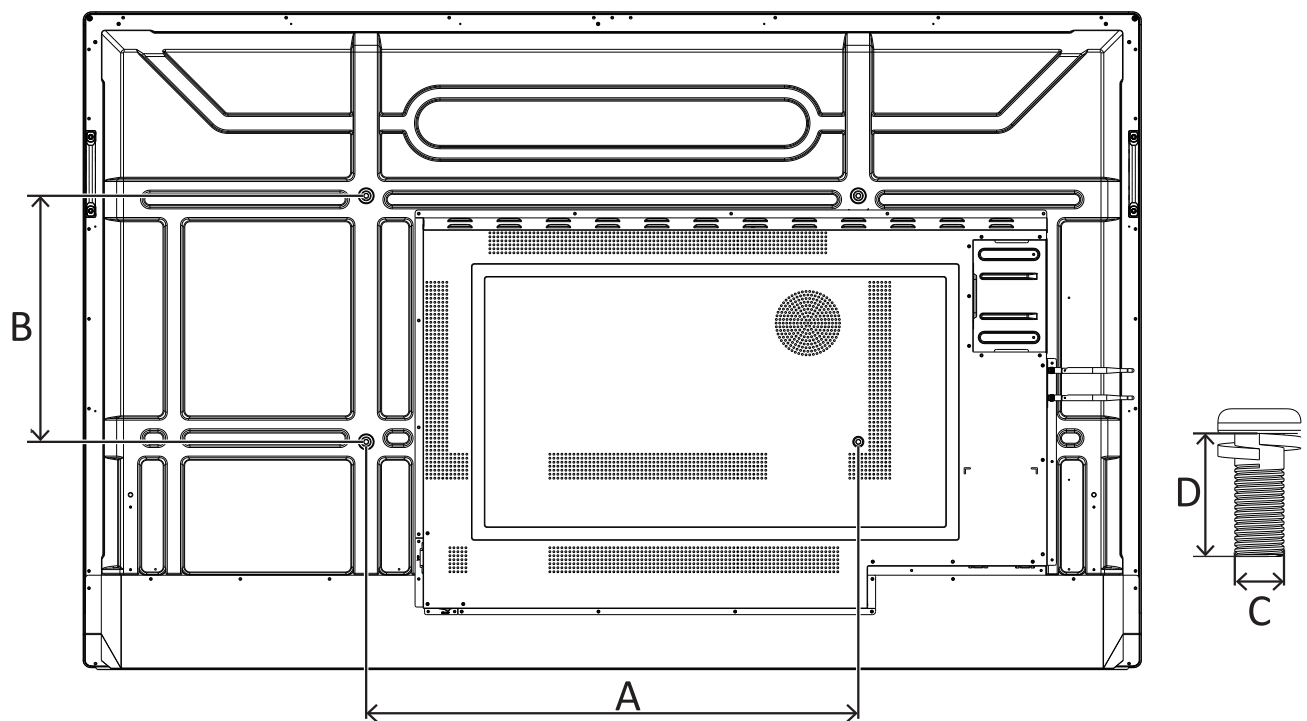

pollici	Specifiche VESA (A x B)	Vite standard (C x D)	Quantità
IFP6552 series	600 x 400 mm	M8 x 20 mm	4
IFP7552 series	800 x 400 mm	M8 x 20 mm	4
IFP8652 series	800 x 600 mm	M8 x 20 mm	4

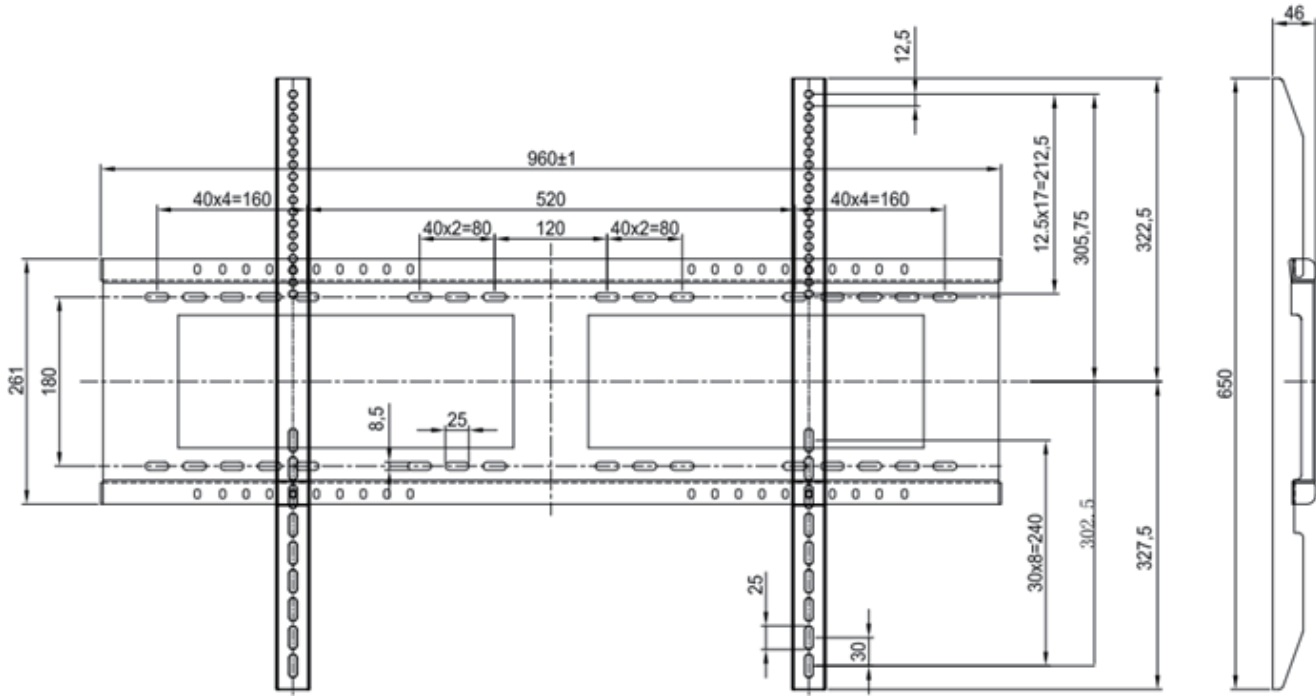

> Avviso ambiente di installazione

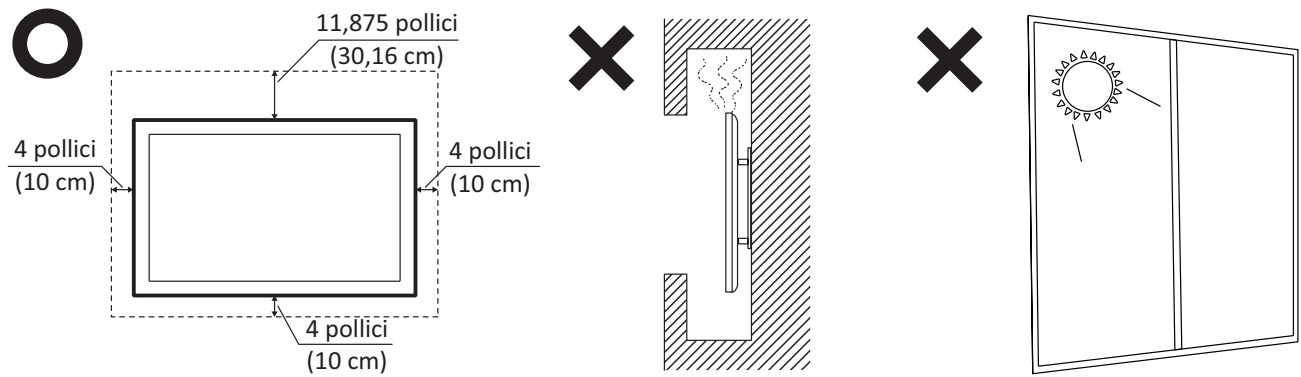

> Panoramica pannello di controllo

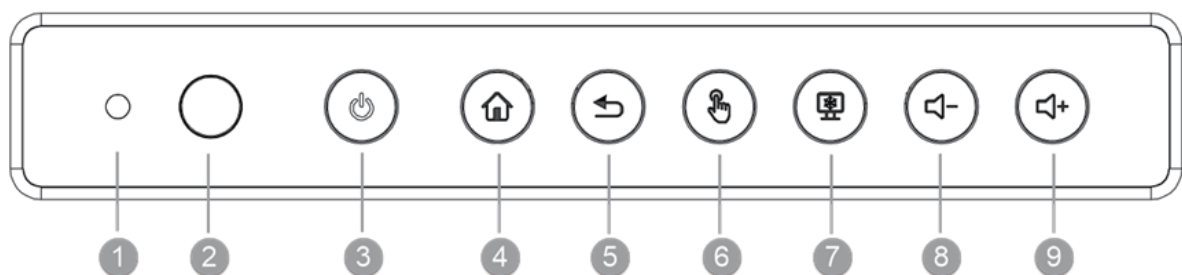

Voce	Descrizione
1	Sensore luce ambientale per monitorare la luce ambientale
2	Ricevitore del telecomando
3	Spia di alimentazione Premere il tasto per accendere il dispositivo Premere il tasto per accendere/spengere solo la retroilluminazione Tenere premuto il tasto per spegnere il dispositivo
4	Torna all'interfaccia principale del lettore ViewBoard
5	Torna al livello precedente del lettore ViewBoard
6	Disabilita/abilita il touchscreen
7	Blocca l'immagine corrente su schermo
8	Riduci il volume
9	Aumenta il volume

> Panoramica telecomando

- 1 Accensione/Spengimento
- 2 Acquisizione schermo
- 3 *PC: Tasto "Windows"
- 4 Avvia scrittura
- 5 Torna a schermata iniziale con lettore integrato
- 6 Indietro/Torna a pagina precedente
- 7 Aumenta/Riduci volume
- 8 Tastierino numerico
- 9 Informazioni
- 10 Selezione sorgente di ingresso
- 11 Tasto di controllo multimediale
Rosso: RIPRODUCI / PAUSA
Verde: STOP
Giallo: AVANTI
Blu: INDIETRO
- 12 *PC: Tasto "Menu"
- 13 *PC: Uscita
- 14 Menu impostazioni
- 15 Tasti su/giù/destra/sinistra/OK
- 16 Blocca schermo
- 17 Disattiva/Attiva audio
- 18 Aumenta/Riduci luminosità
*PC: Pagina su/Pagina giù
- 19 Schermo nero
- 20 Regola rapporto d'aspetto

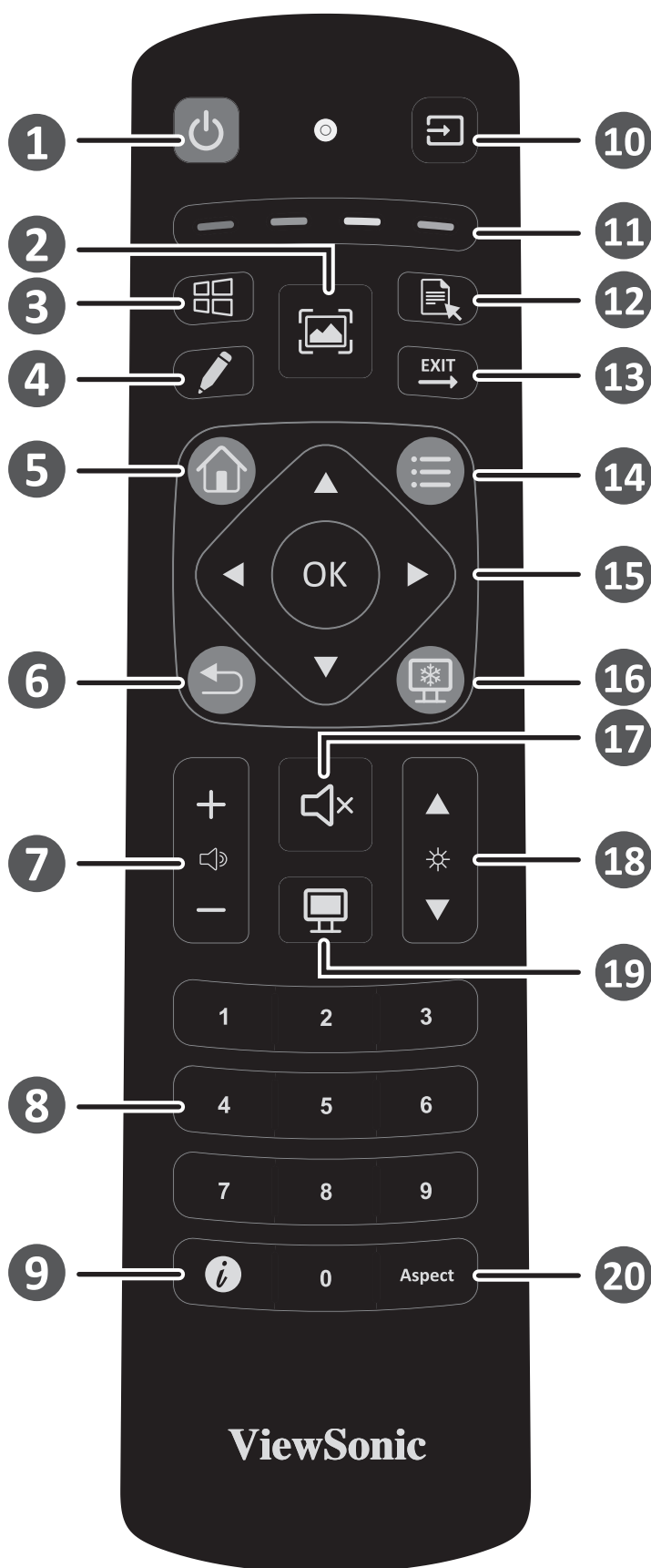

Tasto PC*: Non tutti i modelli supportano queste funzioni

> Porta I/O

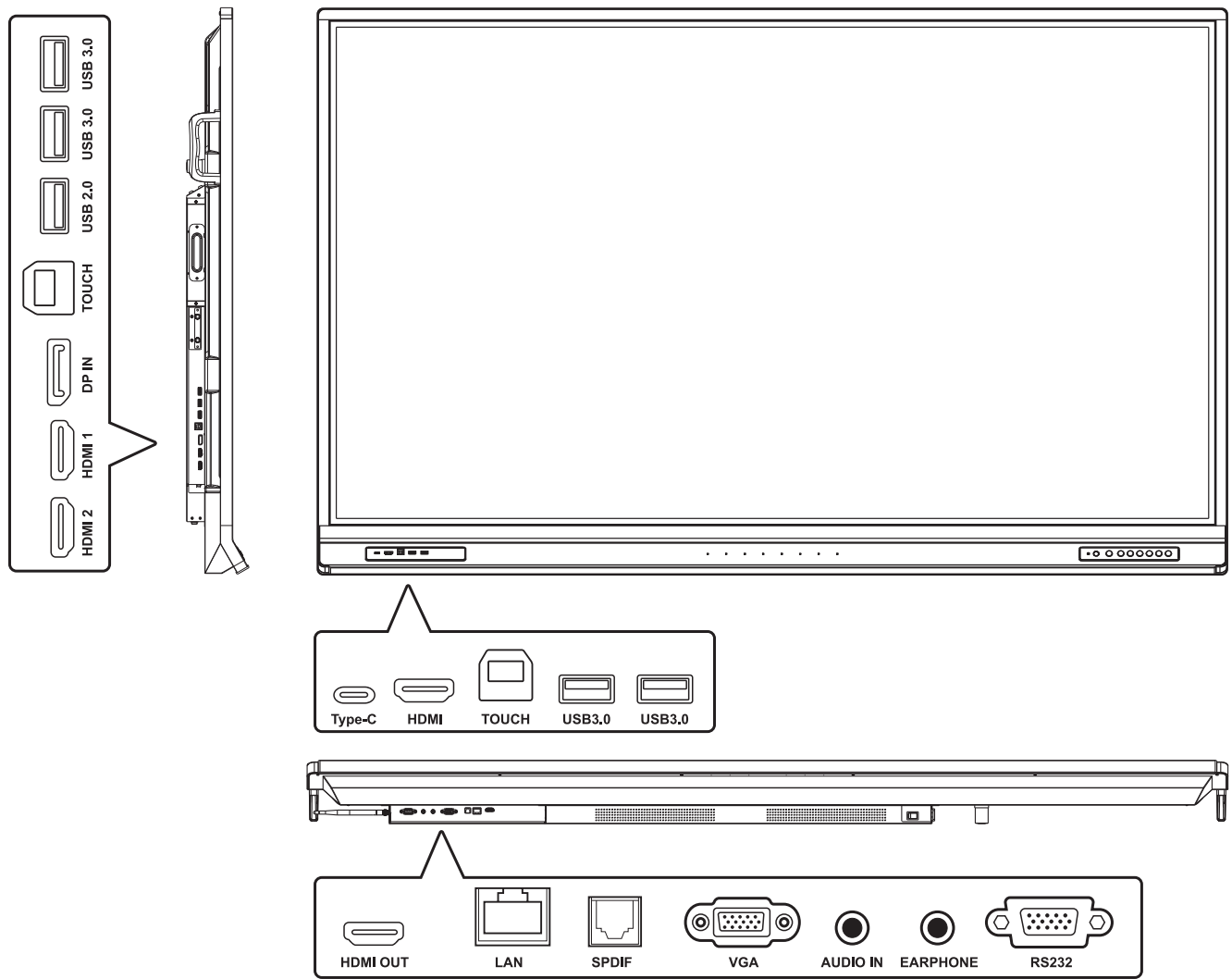

> Collegamenti USB e di rete

Come qualsiasi PC, è facile collegare vari dispositivi USB, dongle e le altre periferiche a ViewBoard.

Periferiche USB

Collegare il cavo del dispositivo USB nella porta USB.

Cavi modem e di rete

Collegare il cavo del router nella porta LAN.

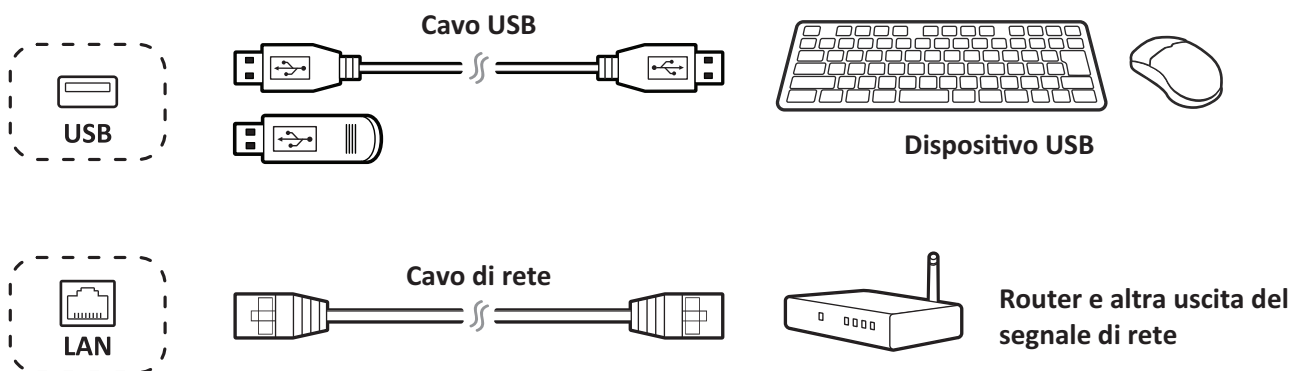

> Collegamento di dispositivi esterni e collegamento con un tocco

I dispositivi esterni possono essere collegati in una delle seguenti configurazioni:

Collegamento tipo C

Collegare un cavo tipo C dal dispositivo esterno a un porta tipo C su ViewBoard.

Collegamento DisplayPort

1. Collegare un cavo DisplayPort dal dispositivo esterno a un porta DisplayPort su ViewBoard.
2. Collegare un cavo USB dal dispositivo esterno a un porta TOUCH su ViewBoard.

Collegamento HDMI

1. Collegare un cavo DisplayPort dal dispositivo esterno a un porta di ingresso HDMI su ViewBoard.
2. Collegare un cavo USB dal dispositivo esterno a un porta TOUCH su ViewBoard.

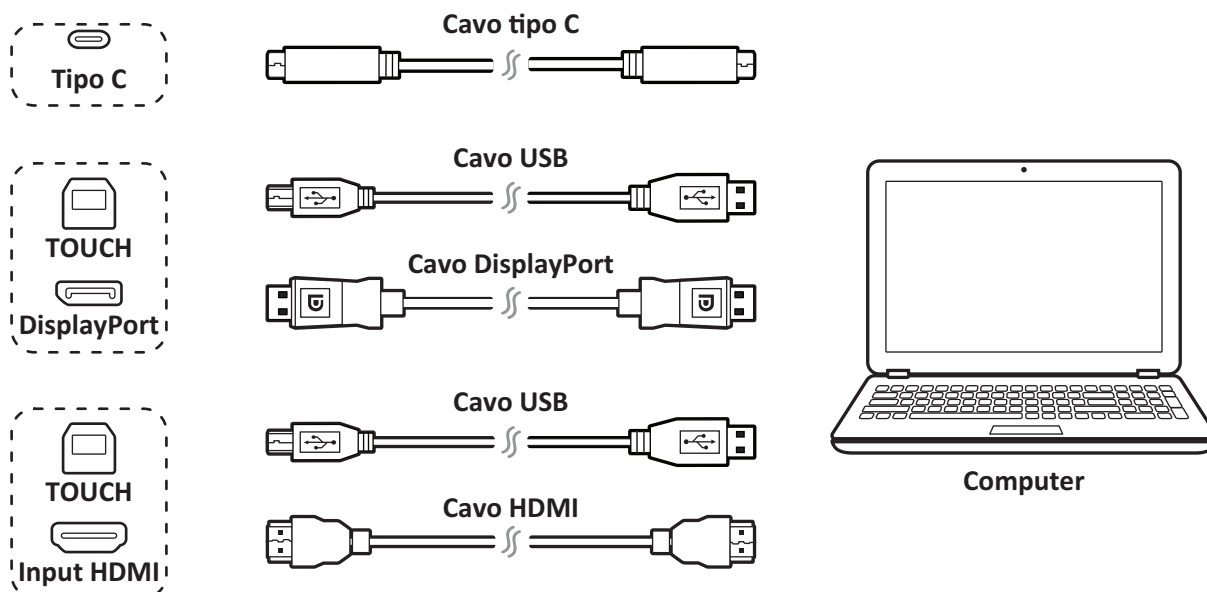

> Collegamenti RS232

Quando si utilizza un cavo per porta seriale RS-232 per collegare il display a un computer esterno, alcune funzioni possono essere controllate in dal PC, tra cui accensione/spegnimento, regolazione del volume e altro.

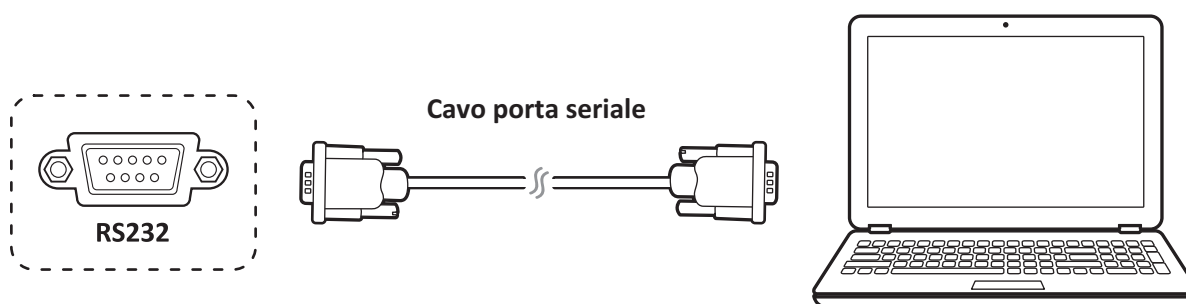

> Collegamento lettore multimediale (audio e video)

Per collegarsi a un lettore multimediale:

1. Collegare il cavo HDMI alle porte HDMI sul ViewBoard e periferica.
2. Collegare il cavo di alimentazione di ViewBoard e accendere l'interruttore di alimentazione del pannello posteriore.
3. Premere il pulsante di accensione sul lato destro di ViewBoard per accendere lo schermo.
4. Premere il pulsante INPUT sul telecomando e passare alla sorgente di ingresso "Menu".

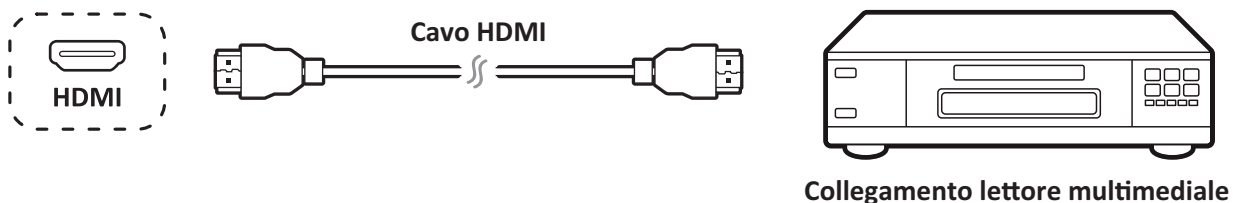

> Connessione SPDIF

Per collegarsi a un sistema audio esterno:

1. Collegare un cavo ottico dalla porta SPDIF al connettore ottico del sistema audio.
2. Collegare il cavo di alimentazione di ViewBoard e accendere l'interruttore di alimentazione del pannello posteriore.
3. Premere il pulsante di accensione sul lato destro di ViewBoard per accendere lo schermo.

Nota: L'uscita audio S/PDIF e cuffie funziona solo su ViewBoard Player, HDMI e canale DP.

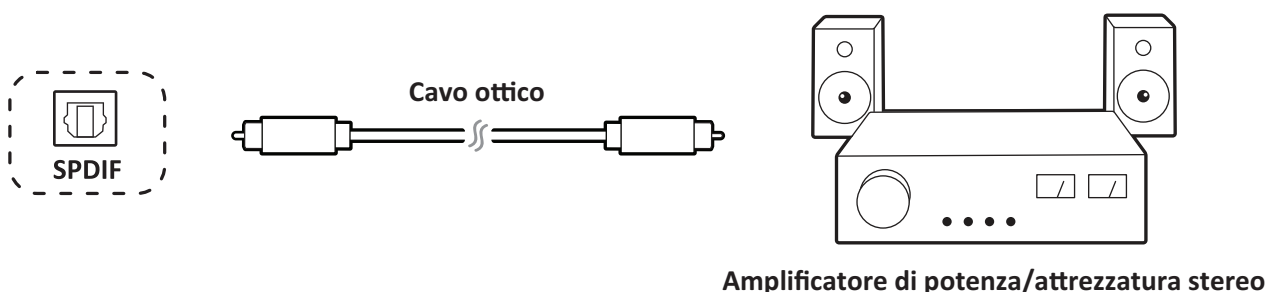

> Connessione uscita video

Per trasmettere video tramite un dispositivo di visualizzazione:

1. Collegare un cavo HDMI alla porta HDMI IN del dispositivo di visualizzazione e l'altra estremità alla porta HDMI OUT di ViewBoard.
2. Per l'audio, collegare un'estremità di un cavo audio alla porta EARPHONE di ViewBoard e l'altra estremità agli altoparlanti.
3. Collegare il cavo di alimentazione di ViewBoard e accendere l'interruttore di alimentazione del pannello posteriore.
4. Premere il pulsante di accensione sul lato destro di ViewBoard per accendere lo schermo.

Nota: L'uscita audio S/PDIF e cuffie funziona solo su ViewBoard Player, HDMI e canale DP.

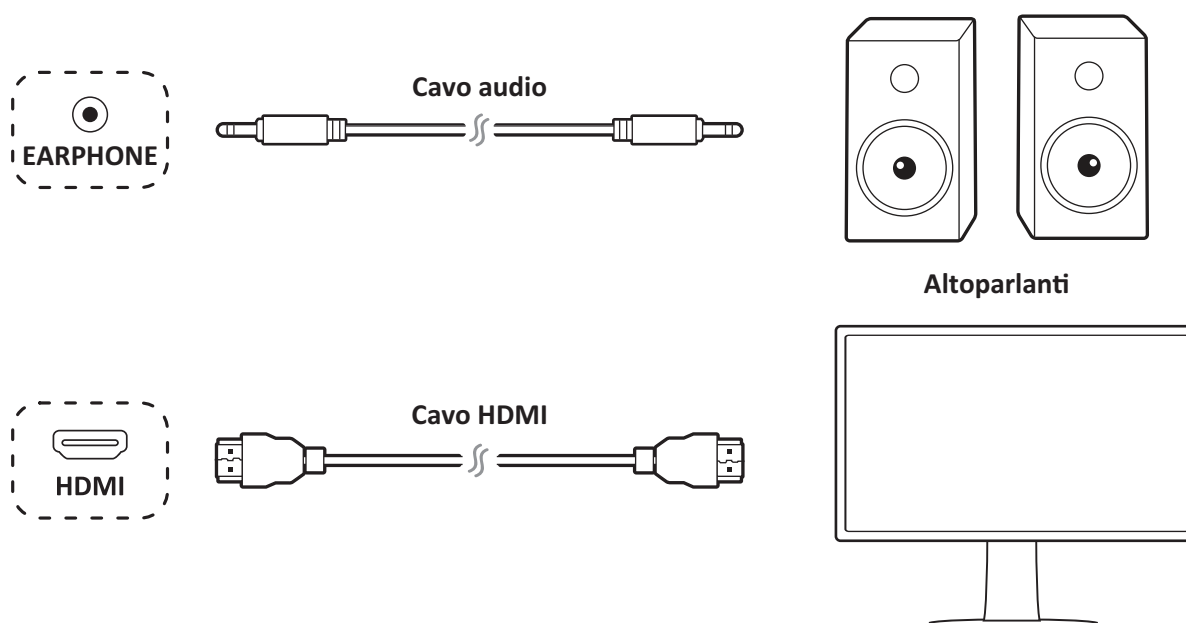

> Primo utilizzo

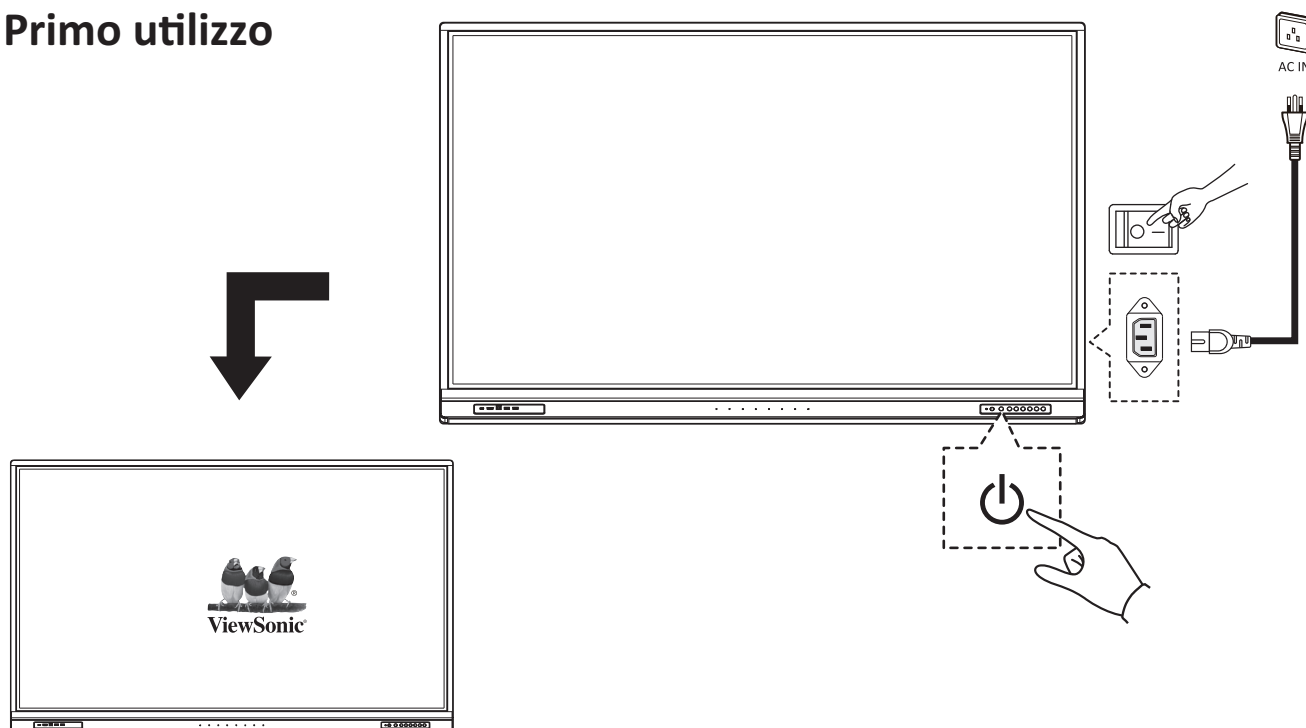



> Dichiarazione di conformità

Dichiarazione di conformità FCC: Questo dispositivo è conforme alla parte 15 delle norme FCC. Il funzionamento è soggetto alle seguenti due condizioni: (1) Questo dispositivo non può provocare interferenze dannose; (2) questo dispositivo deve accettare tutte le interferenze ricevute, incluse le interferenze che possono provocare operazioni indesiderate.

Conformità Industry Canada ICES-003: CAN ICES-3 (B)/NMB-3(B)



ViewSonic Corporation (US/Canada/Latin America)

 : www.viewsonic.com/support/product-registration



Stati Uniti

 1-800-688-6688

 customerservice@viewsonic.com

Canada

 1-866-463-4775

 customerservice@viewsonic.com

Puerto Rico & Virgin Islands

 <http://www.viewsonic.com/la/soporte/servicio-tecnico> (Español)

America Latina

 <http://www.viewsonic.com/la/soporte/servicio-tecnico-la/>



ViewSonic Europe Ltd.

 : www.viewsoniceurope.com

 +44 (0) 207 382 8251



Europe

 <http://www.viewsoniceurope.com/eu/support/call-desk/>



Centro di supporto ViewSonic



Accessori opzionali

> Innholdet i pakken

- HDMI-kabel (10ft/3m)
- Type-C-kabel (5ft/1.5m)
- USB-kabel for berøring (10ft/3m)
- Klemme x 5
- Webkameraplate
- AAA-batteri x 2
- Berøringspenn x 2
- Fjernkontroll
- Viskelær
- Webkamera-skruer x 4 (M4x7mm x2, M3x6mm x2)
- Hurtigstartveiledning
- Samsvarserklæring
- RS232-adapter
- Strømkabel (i henhold til område)
- Veggmonteringsskruser x 4 (M8x20mm x4)

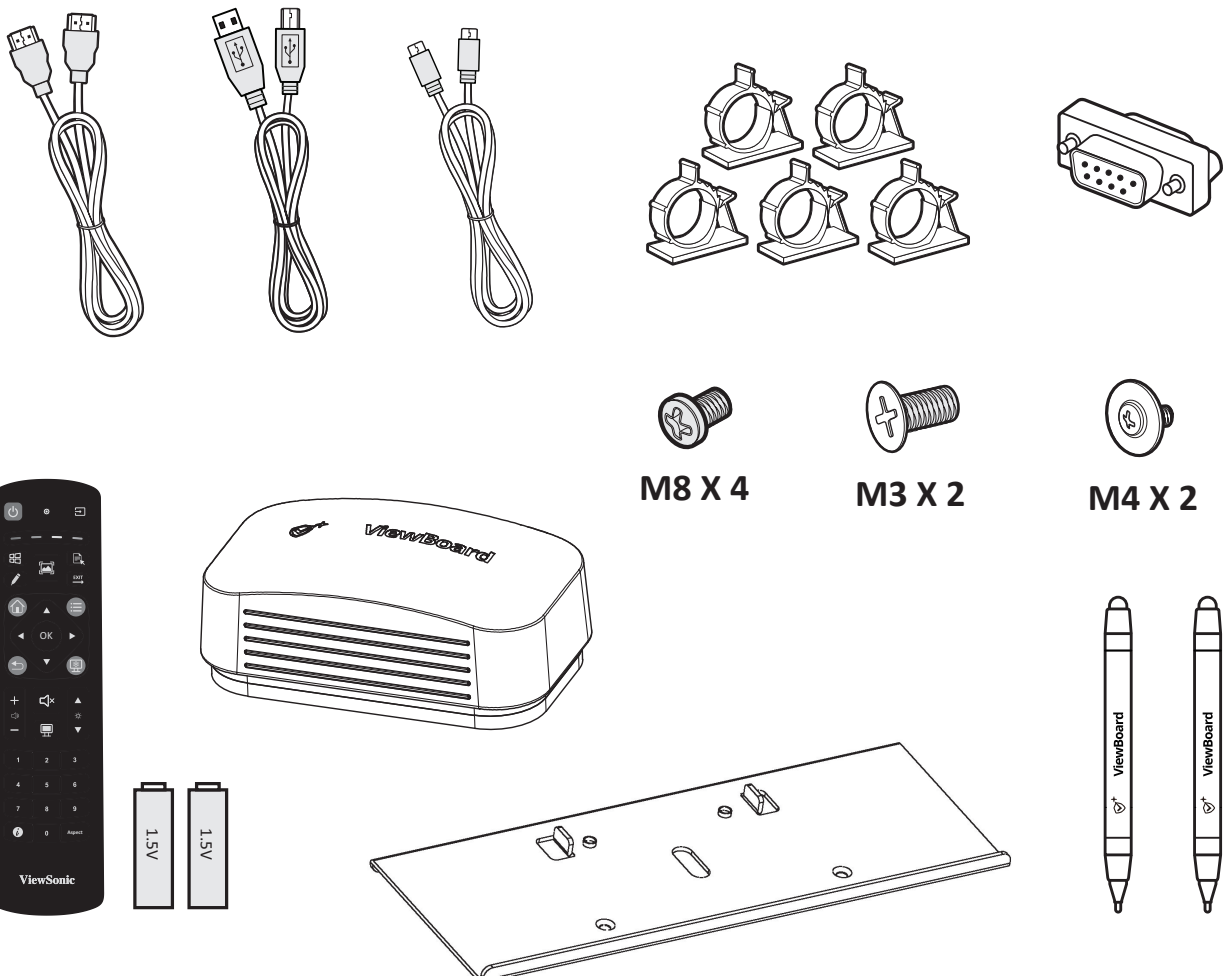
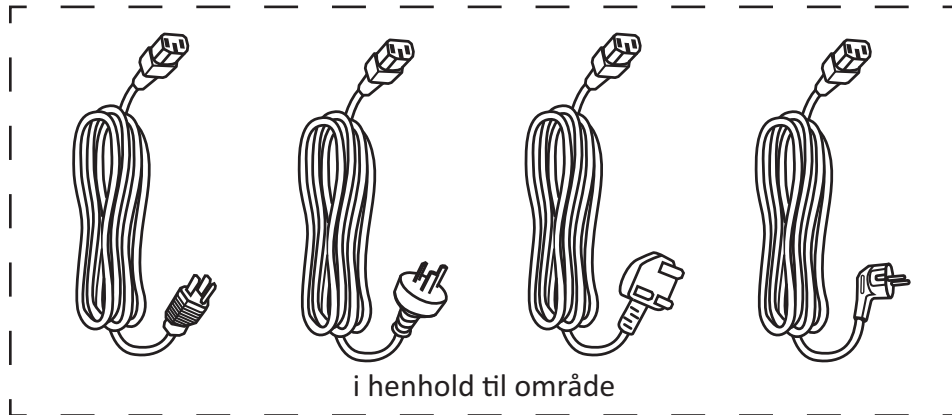

➤ Spesifikasjoner for veggmonteringssett (solgt separat)

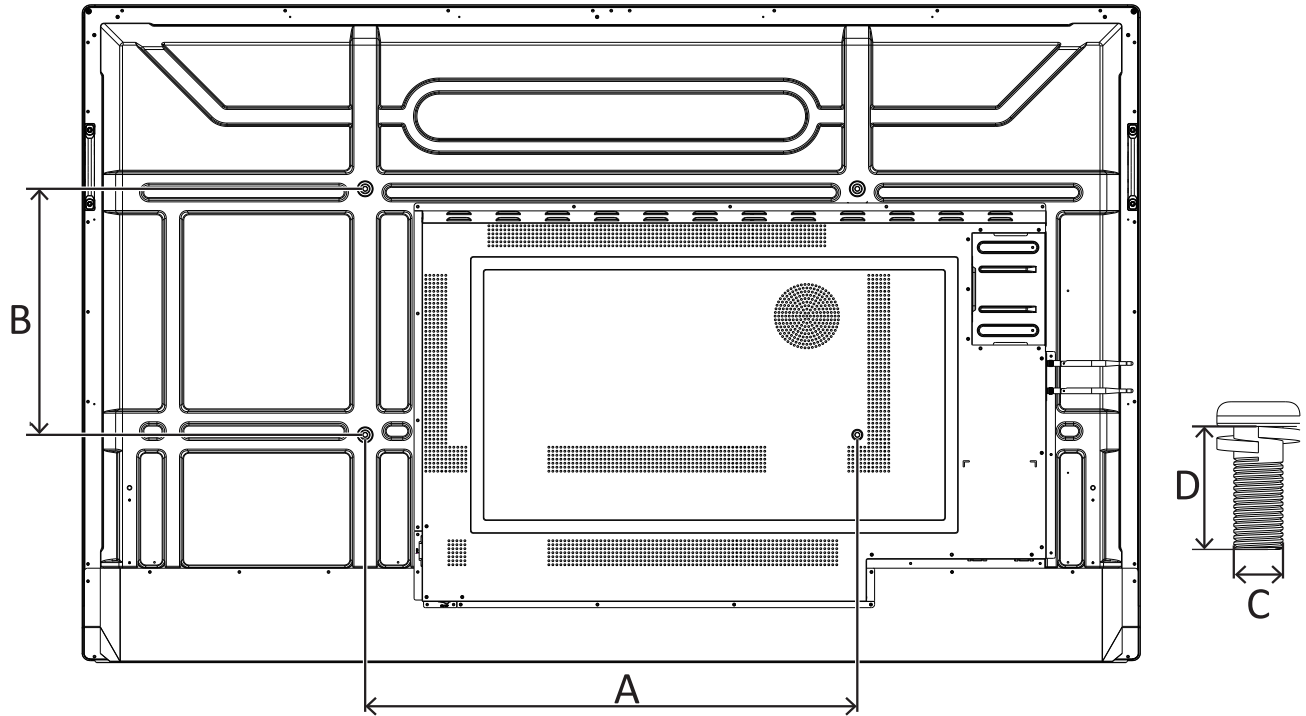

tomme	VESA-spes. (A x B)	Standardskrue (C x D)	Antall
IFP6552-serien	600 x 400 mm	M8 x 20 mm	4
IFP7552-serien	800 x 400 mm	M8 x 20 mm	4
IFP8652-serien	800 x 600 mm	M8 x 20 mm	4

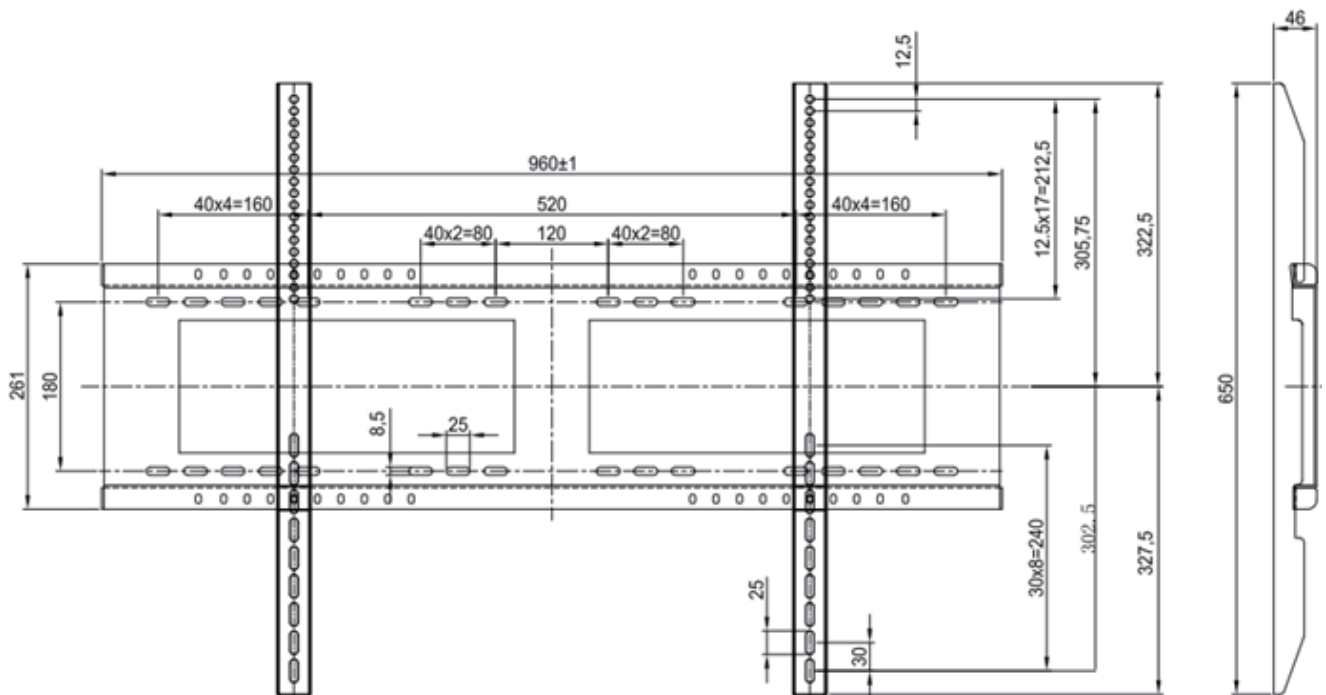

> Obs om installasjonsmiljø

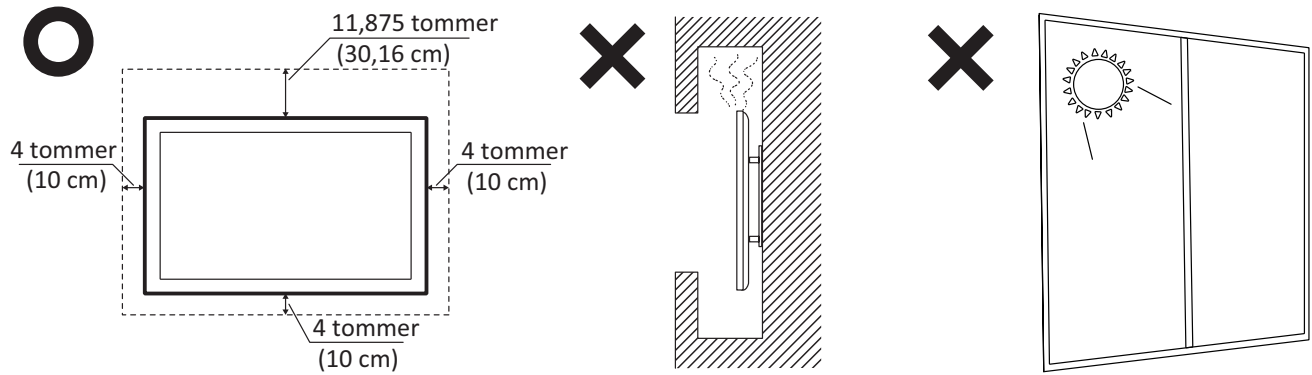

> Oversikt over kontrollpanel

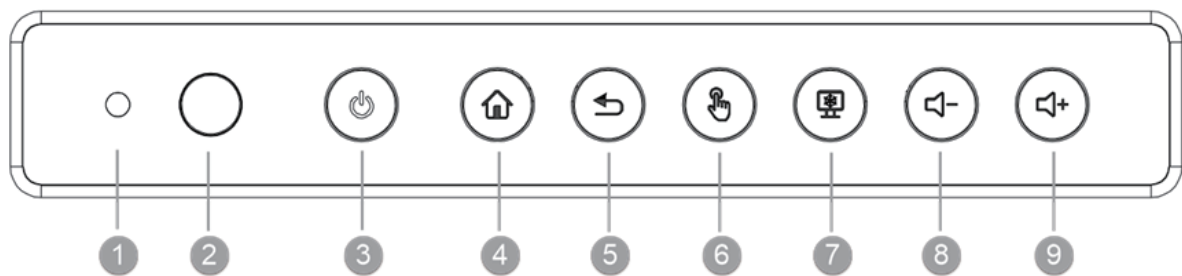

Element	Beskrivelse
1	Omgivelsessensor for å overvåke omgivelseslyset
2	Fjernkontrollmottaker
3	Strømindikatorlampe Trykk knappen for å slå på enheten Trykk knappen for bare å slå av/på baklyset på skjermen Trykk og hold inne knappen for å slå av enheten
4	Tilbake til hovedgrensesnittet til ViewBoard-spilleren
5	Tilbake til forrige nivå på ViewBoard-spilleren
6	Deaktiver/aktiver berøringsskjermen
7	Frys gjeldende bilde på skjermen
8	Reduser lydstyrken
9	Øk lydstyrken

> Oversikt over fjernkontroll

- 1 Strøm på/av
- 2 Skjermopptak
- 3 *PC: «Windows»-knapp
- 4 Start skriving
- 5 Tilbake til skjerm til innebygd spiller
- 6 Tilbake / forrige side
- 7 Øk/senk lydstyrke
- 8 Talltastatur
- 9 Information (Informasjon)
- 10 Valg av inngangskilde
- 11 Mediekontrollknapp
Rød: SPILL AV / PAUSE
Grønn: STOPP
Gul: FREMOVER
Blå: BAKOVER
- 12 *PC: «Meny»-knapp
- 13 *PC: Avslutt dialogboks
- 14 Innstilling-meny
- 15 Opp-/Ned-/Høyre-/Venstre-/OK-knapper
- 16 Frys skjerm
- 17 Demp / Slå av demping
- 18 Øk/senk lysstyrke
*PC: Side opp / side ned
- 19 Tøm skjerm
- 20 Juster sideforhold

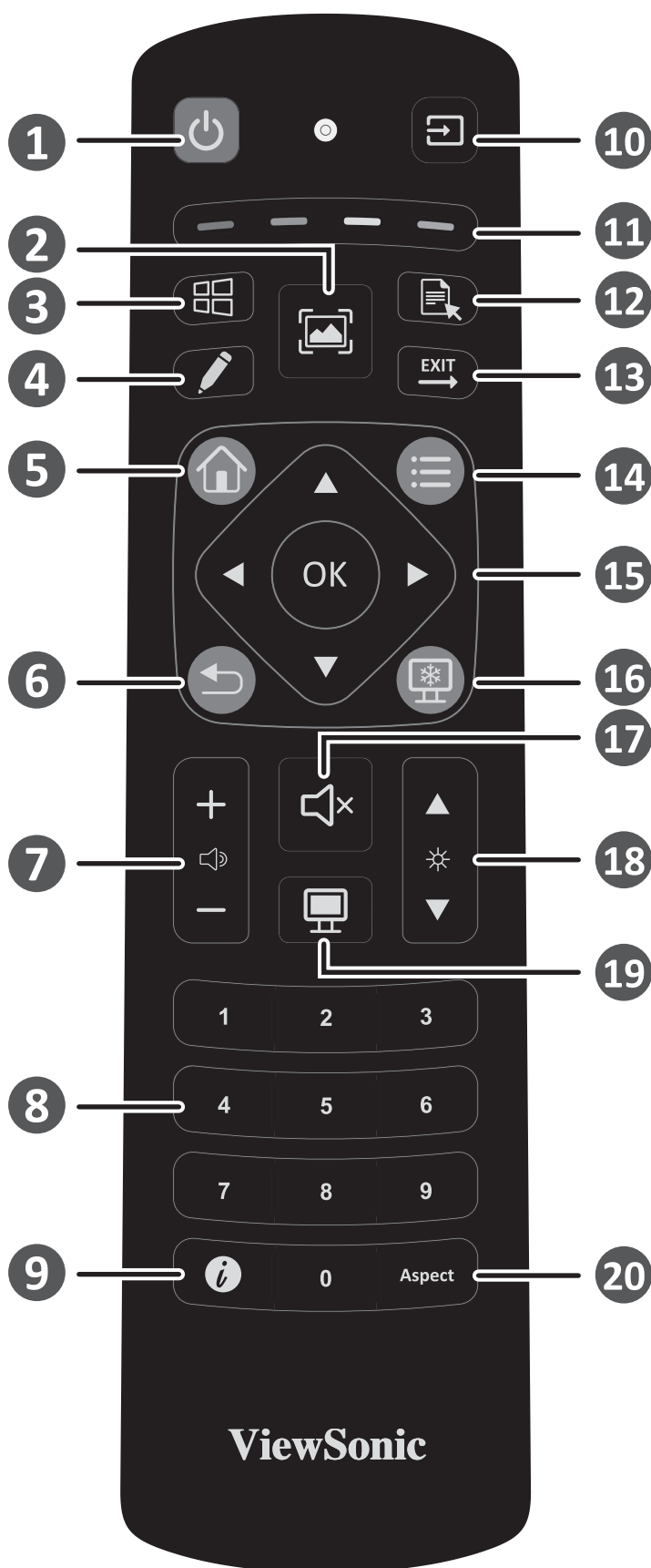

*PC-knapp: Ikke alle modeller støtter disse funksjonene

> I/U-port

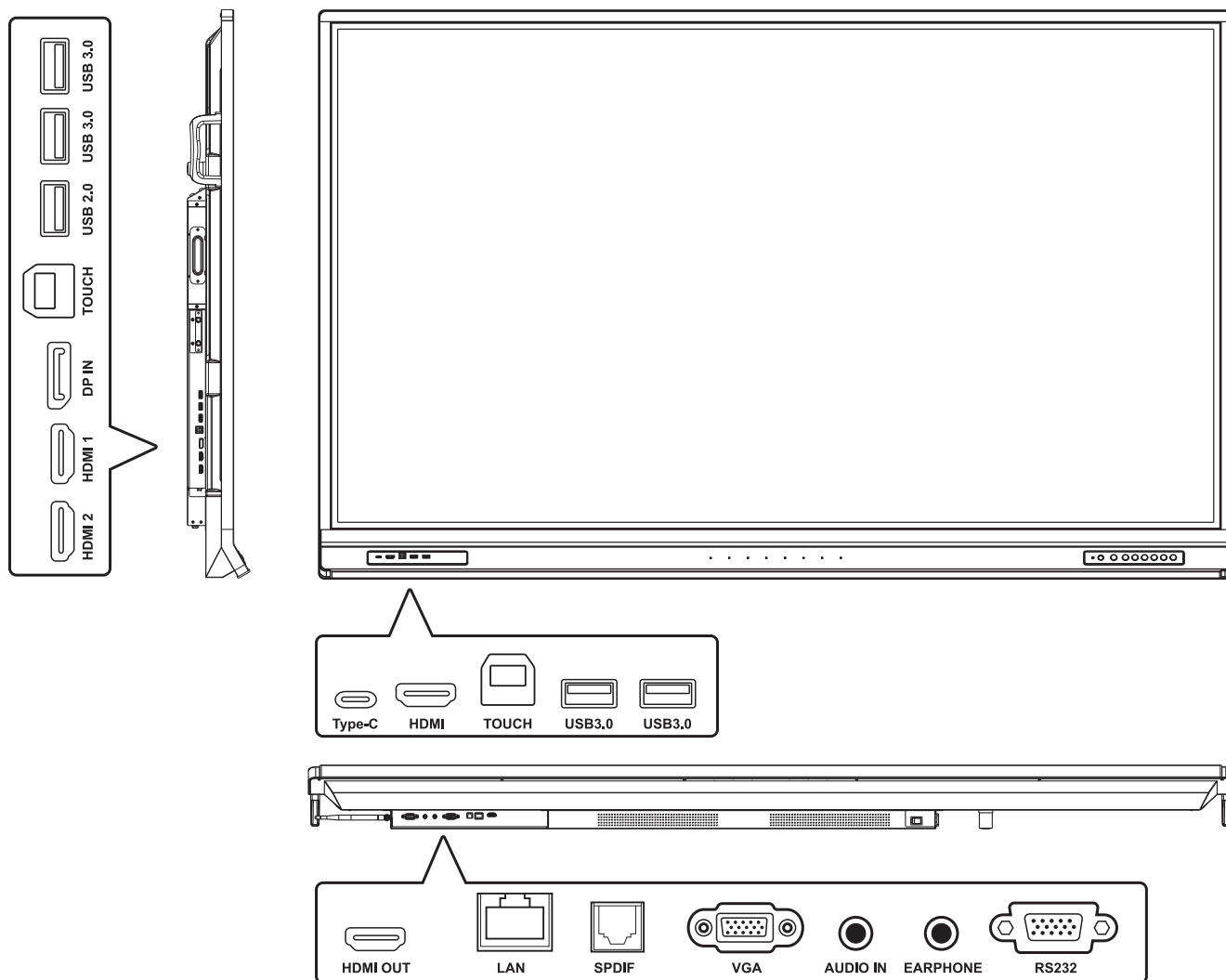

> USB- og nettverkstilkobling

Akkurat som med en PC er det enkelt å koble forskjellige USB-enheter og annet ekstrautstyr til ViewBoard.

USB-utstyr

Sett kabelen til USB-enheten i USB-porten.

Nettverks- og modemkabler

Sett ruteren fra kabelen inn i LAN-porten.

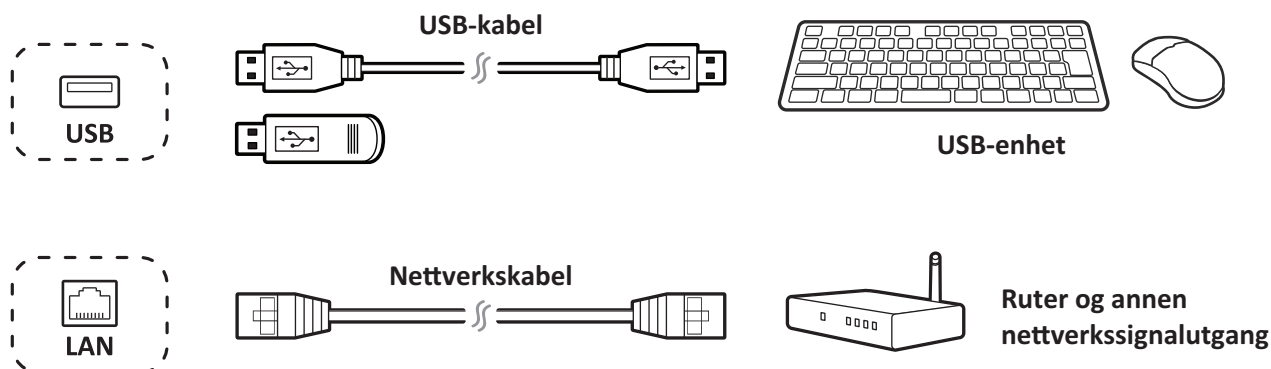

> Koble til eksterne enheter og berøringsforbindelse

Du kan koble til eksterne enheter i en av følgende konfigurasjoner:

Type C-tilkobling

Koble en Type C-kabel fra den eksterne enheten til Type C-porten på ViewBoard.

DisplayPort-tilkobling

1. Koble en DisplayPort-kabel fra den eksterne enheten til DisplayPort-porten på ViewBoard.
2. Koble en USB-kabel til den eksterne enheten fra TOUCH-porten på ViewBoard.

HDMI-tilkobling

1. Koble en HDMI-kabel fra den eksterne enheten til HDMI IN-porten på ViewBoard.
2. Koble en USB-kabel til den eksterne enheten fra TOUCH-porten på ViewBoard.

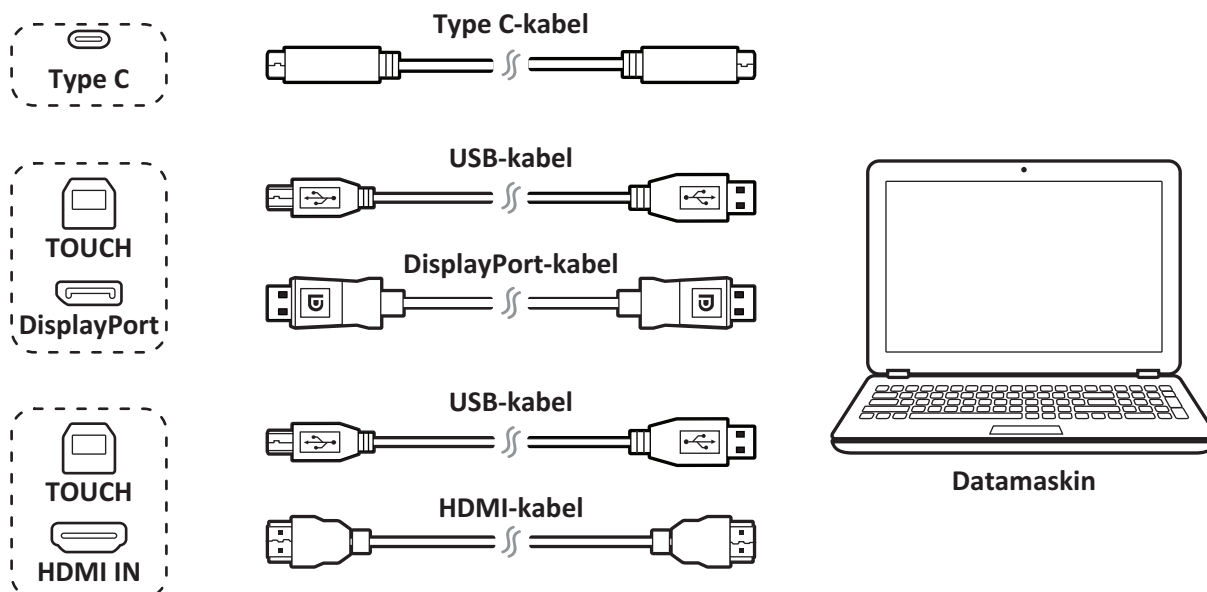

> RS232-tilkoblinger

Når du bruker en RS232-seriellportkabel for å koble skjermen til en ekstern datamaskin, kan noen funksjoner styres av PC-en, inkludert strøm på/av, volumjustering og mer.

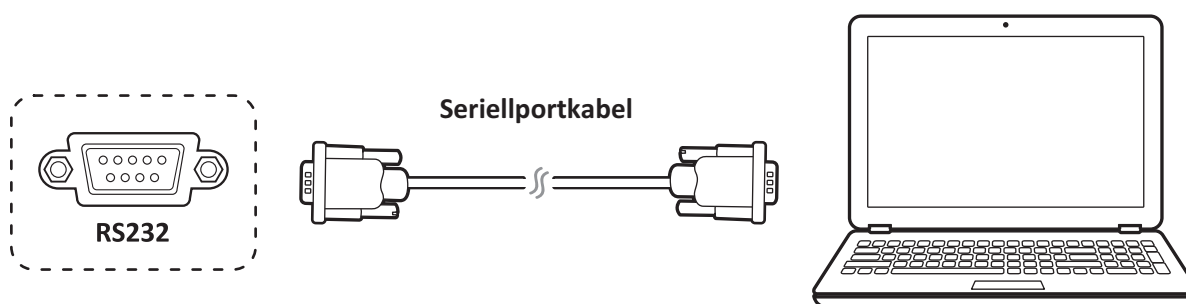

> Koble til mediespiller (lyd og video)

Koble til en mediespiller:

1. Koble HDMI-kabelen til HDMI-portene på ViewBoard og utstyrsenheten.
2. Sett inn strømledningen til ViewBoard, og slå på bryterne på bakpanelet.
3. Trykk strømknappen på av høyre side av ViewBoard for å slå på skjermen.
4. Trykk INPUT-knappen på fjernkontrollen for å bytte til «HDMI»-inngangskilden.

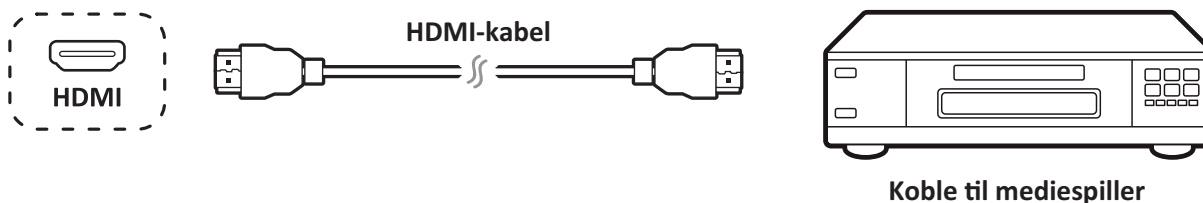

> SPDIF-kontakt

Slik kobler du til et eksternt lydsystem:

1. Koble en optisk kabel fra SPDIF-porten til lydsystemets optiske kontakt.
2. Sett inn strømledningen til ViewBoard, og slå på bryterne på bakpanelet.
3. Trykk strømknappen på av høyre side av ViewBoard for å slå på skjermen.

Obs: S/PDIF og hodetelefonlyduttgang fungerer bare på ViewBoard spiller, HDMI og DP-kanal.

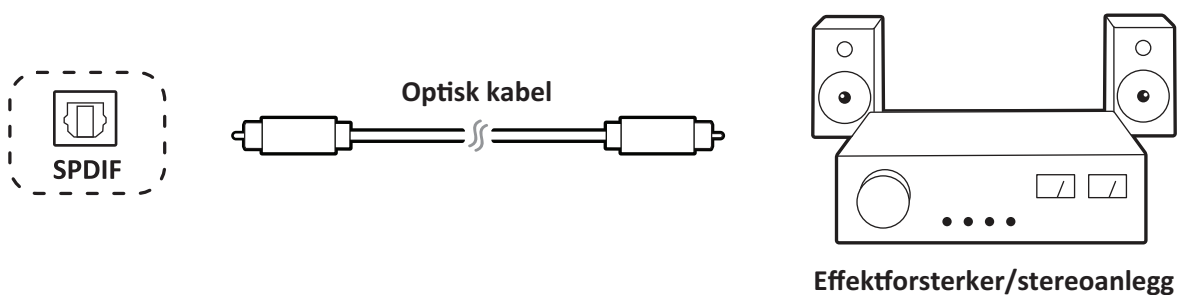

> Videoutgangstilkobling

Slik sender du ut video via en visningsenhet:

1. Koble en HDMI-kabel til HDMI IN-porten på skjermenheten, og den andre enden til HDMI OUT-porten på ViewBoard.
2. For lyd kobler du den ene enden av en lyd kabel til EARPHONE-porten på ViewBoard og den andre enden til høyttalerne.
3. Sett inn strømledningen til ViewBoard, og slå på bryterne på bakpanelet.
4. Trykk strømknappen på av høyre side av ViewBoard for å slå på skjermen.

Obs: S/PDIF og hodetelefonlyduttgang fungerer bare på ViewBoard spiller, HDMI og DP-kanal.

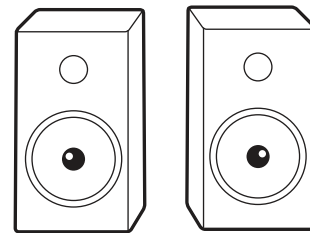

Høyttalere

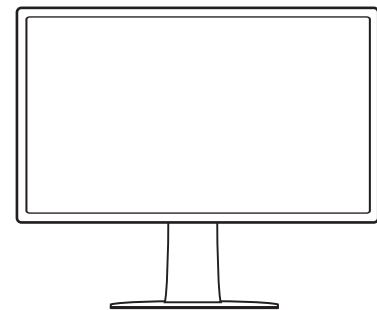

> Start å bruke

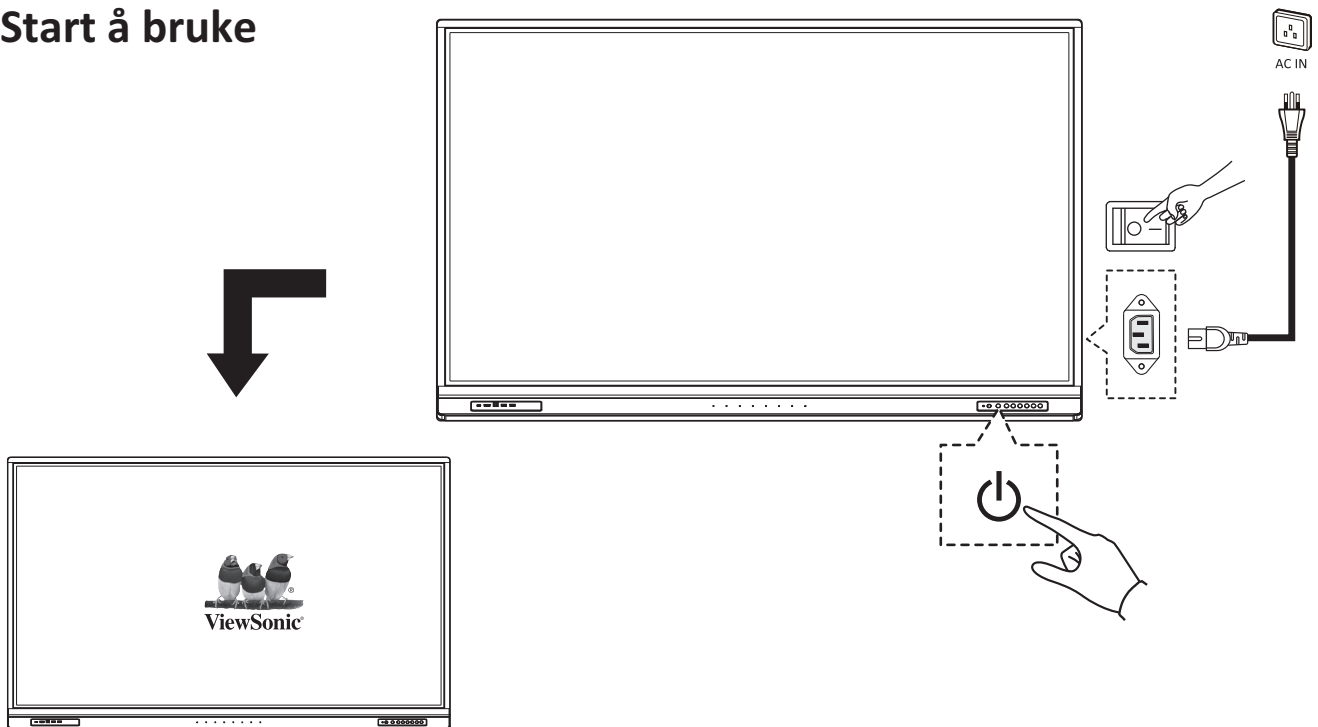



> Samsvarserklæring

FCC-samsvarserklæring: Denne enheten samsvarer med del 15 i FCC-reglene. Bruk er underlagt følgende to betingelser: (1) Denne enheten skal ikke forårsake skadelig interferens, og (2) denne enheten må godta all mottatt interferens, inkludert interferens som kan forårsake uønsket drift.

Samsvar med Industry Canada ICES-003: CAN ICES-3 (B)/NMB-3(B)



ViewSonic Corporation (USA/Canada/Latinamerika)

 : www.viewsonic.com/support/product-registration



USA

 1-800-688-6688

 customerservice@viewsonic.com

Canada

 1-866-463-4775

 customerservice@viewsonic.com

Puerto Rico og Jomfruøyene

 <http://www.viewsonic.com/la/soporte/servicio-tecnico> (Español)

Latinamerika

 <http://www.viewsonic.com/la/soporte/servicio-tecnico-la/>



ViewSonic Europe Ltd.

 : www.viewsoniceurope.com

 +44 (0) 207 382 8251



Europe

 <http://www.viewsoniceurope.com/eu/support/call-desk/>



ViewSonic støttecenter



Valgfritt tilbehør

➤ Zawartość opakowania

- Kabel HDMI (10ft/3m)
- Kabel typu c (5ft/1.5m)
- Kabel USB dla funkcji dotyku (10ft/3m)
- Zacisk x 5
- Płyta kamery internetowej
- Bateria AAA x 2
- Rysik x 2
- Pilot
- Gumka
- Śruby kamery internetowej x 4 (M4x7mm x2, M3x6mm x2)
- Instrukcja szybkiego uruchomienia
- Oświadczenie o zgodności
- Adapter RS232
- Kabel zasilający (dostarczany według regionu)
- Śruby do montażu na ścianie x 4 (M8x20mm x4)

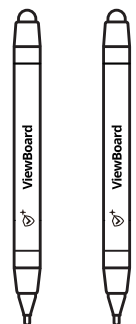
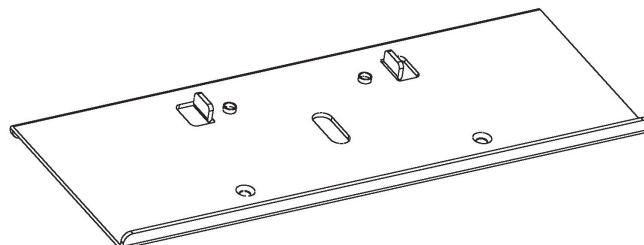
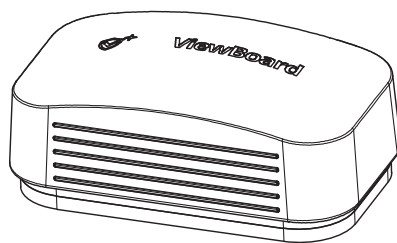
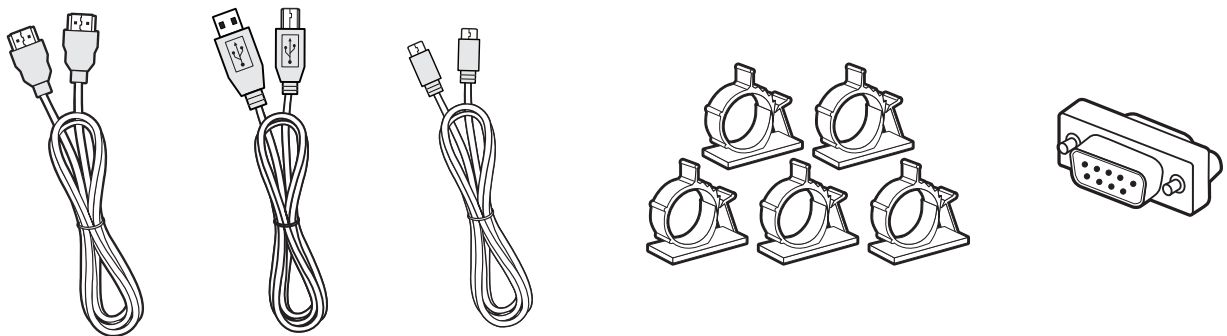
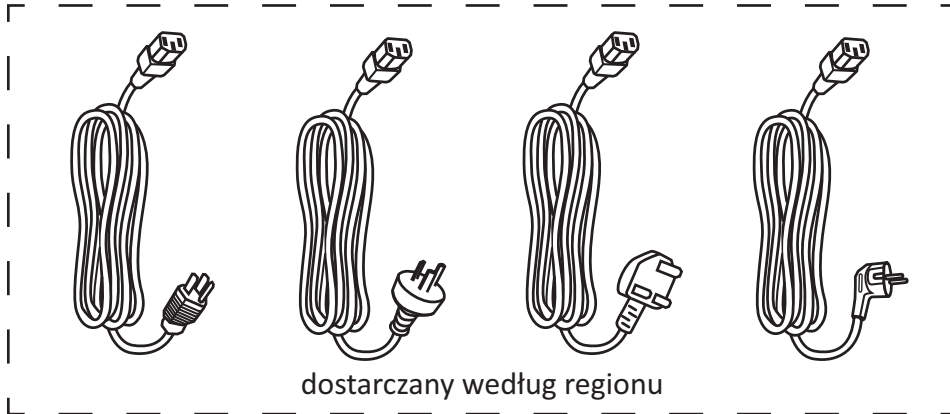

> Uwaga dotycząca środowiska instalacji

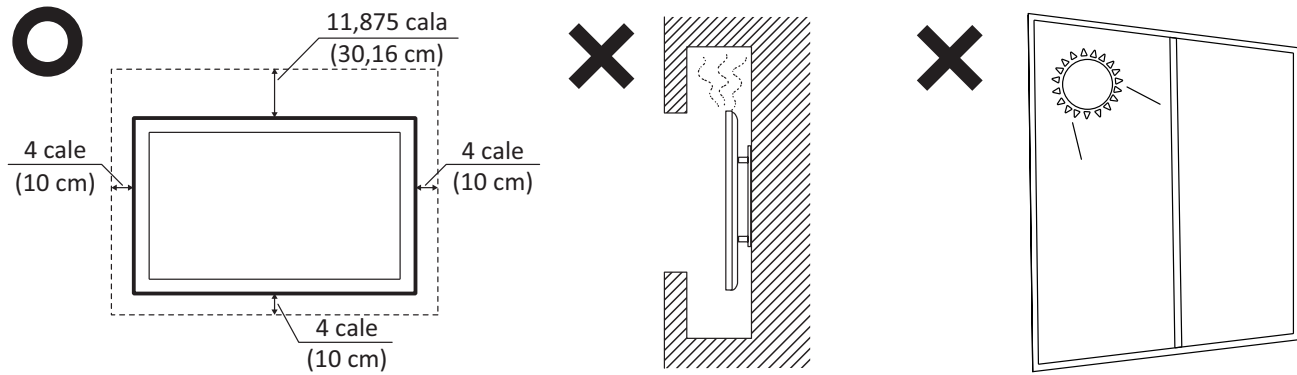

> Przegląd panela sterowania

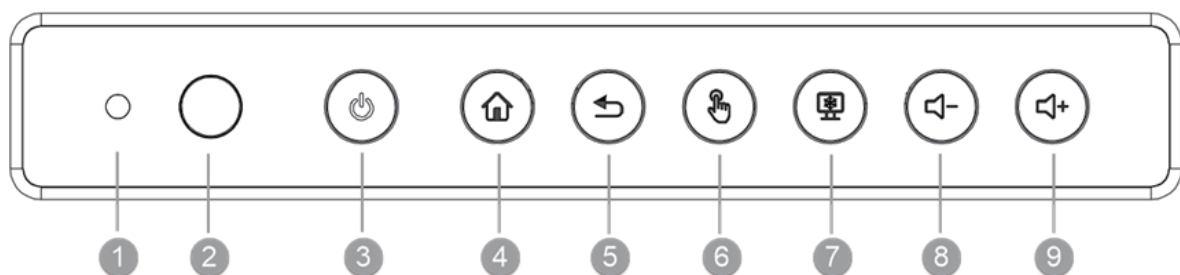

Element	Opis
1	Czujnik światła otoczenia do monitorowania światła otoczenia
2	Odbiornik pilota
3	Światło wskaźnika zasilania Naciśnij ten przycisk, aby włączyć urządzenie Naciśnij ten przycisk, aby wyłączyć/włączyć jedynie podświetlenie wyświetlacza Naciśnij i przytrzymaj ten przycisk, aby wyłączyć urządzenie
4	Powrót do głównego interfejsu odtwarzacza ViewBoard
5	Powrót do poprzedniego poziomu odtwarzacza ViewBoard
6	Wyłączenie/włączenie ekranu dotykowego
7	Zatrzymanie bieżącego obrazu na ekranie
8	Zmniejszenie głośności
9	Zwiększenie głośności

> Przegląd pilota

- 1 Włączenie/wyłączenie zasilania
- 2 Przechwytywanie ekranu
- 3 *Komputer PC: Przycisk "Windows"
- 4 Pisanie podczas uruchamiania
- 5 Cofnij do wbudowanego ekranu głównego odtwarzacza
- 6 Cofnij/Powrót do poprzedniej strony
- 7 Zwiększenie/zmniejszenie głośności
- 8 Klawiatura numeryczna
- 9 Informacje
- 10 Wybór źródła wejścia
- 11 Przycisk sterowania multimediami
Czerwony: ODTWARZAJ/PAUZA
Zielony: ZATRZYMAJ
Żółty: DO PRZODU
Niebieski: DO TYŁU
- 12 *Komputer PC: Przycisk "Menu"
- 13 *Komputer PC: Wyjście z okna dialogowego
- 14 Ustawienia
- 15 Przyciski W górę/W dół/W prawo/W lewo/OK
- 16 Zatrzymaj ekran
- 17 Wyciszenie/Wyłączenie wyciszenia
- 18 Zwiększenie/zmniejszenie jasności
*Komputer PC: Strona w górę/Strona w dół
- 19 Pusty ekran
- 20 Dopasowanie współczynnika proporcji

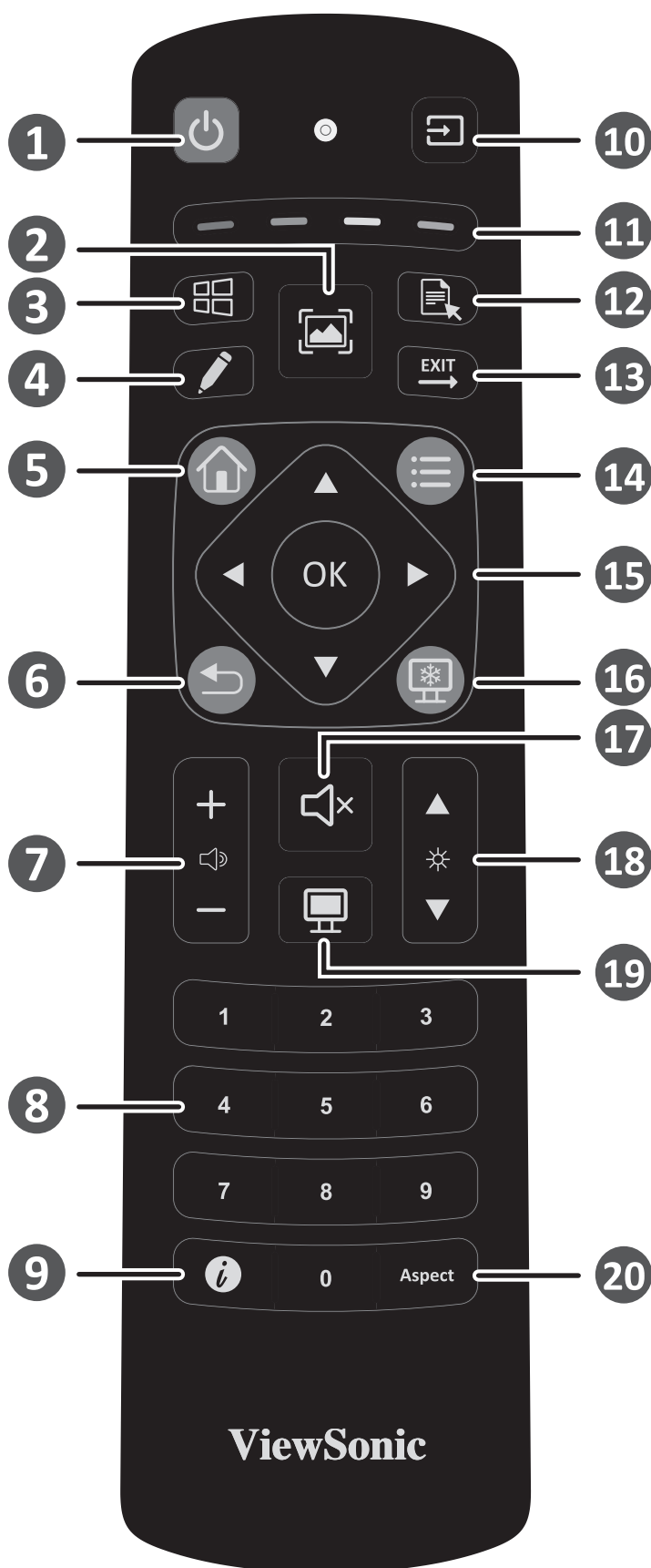

*Przycisk PC: Nie wszystkie modele obsługują te funkcje

➤ Port I/O

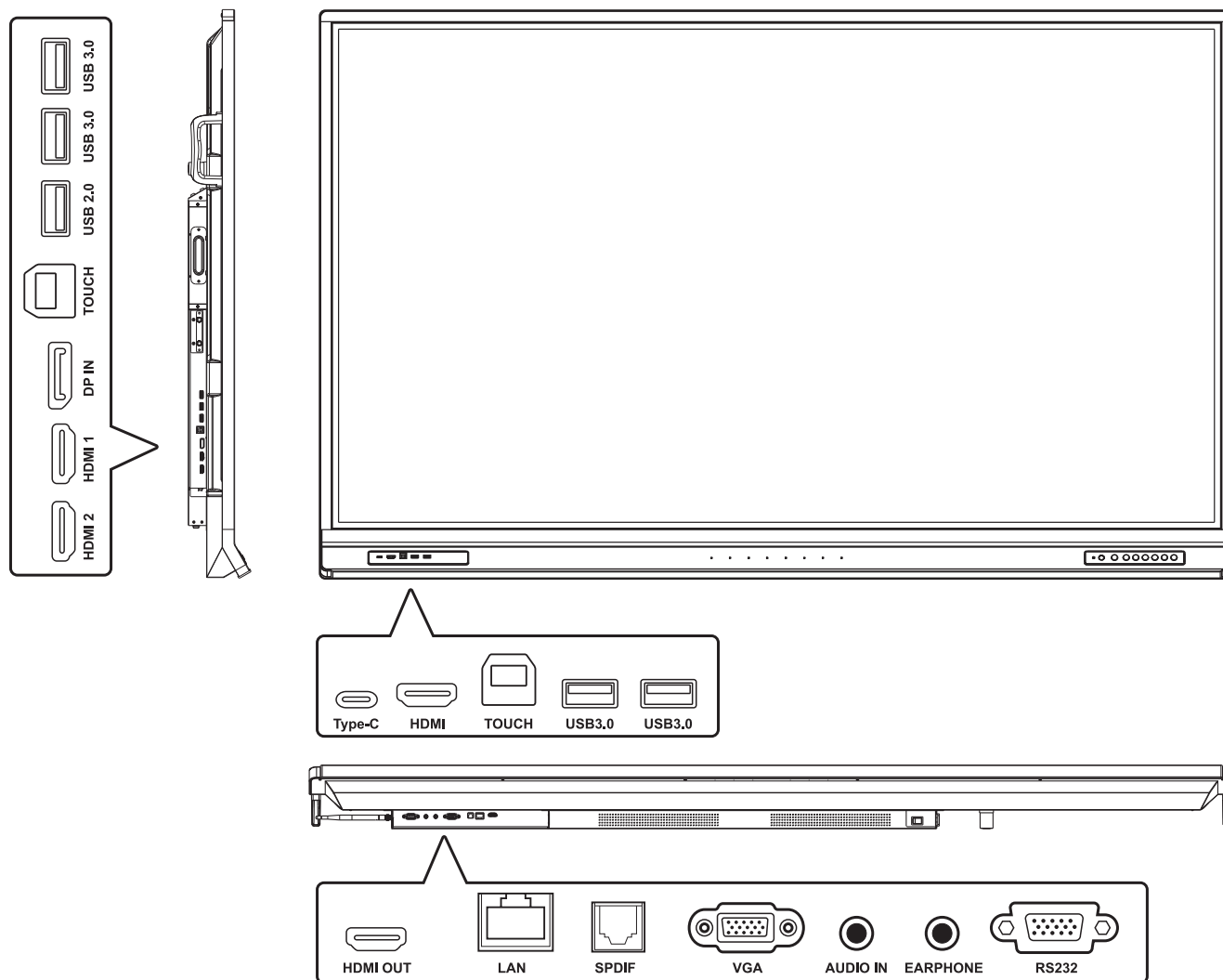

➤ USB i połączenia sieciowe

Podobnie jak w każdym komputerze PC, do monitora interaktywnego ViewBoard można łatwo podłączyć różne urządzenia USB i inne urządzenia peryferyjne.

Peryferyjne urządzenia USB

Podłącz kabel urządzenia USB do portu USB.

Kable sieciowe i modemowe

Podłącz kabel routera do portu LAN.

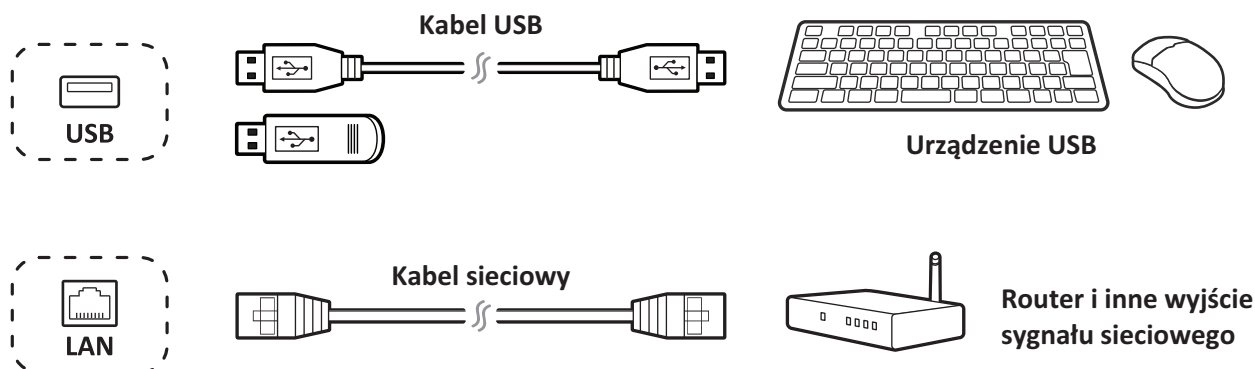

> Podłączenie urządzeń zewnętrznych i podłączenie panelu dotykowego

Urządzenie(a) zewnętrzne można podłączyć w dowolnej z następujących konfiguracji:

Podłączenie typu C

Podłącz kabel typu C z urządzenia zewnętrznego do portu typu C na ViewBoard.

Podłączenie DisplayPort

1. Podłącz kabel DisplayPort z urządzenia zewnętrznego do portu DisplayPort na ViewBoard.
2. Podłącz kabel USB do zewnętrznego urządzenia, z portu DOTYK ViewBoard.

Podłączenie HDMI

1. Podłącz kabel HDMI z urządzenia zewnętrznego do gniazda Wejście HDMI na ViewBoard.
2. Podłącz kabel USB do zewnętrznego urządzenia, z portu DOTYK ViewBoard.

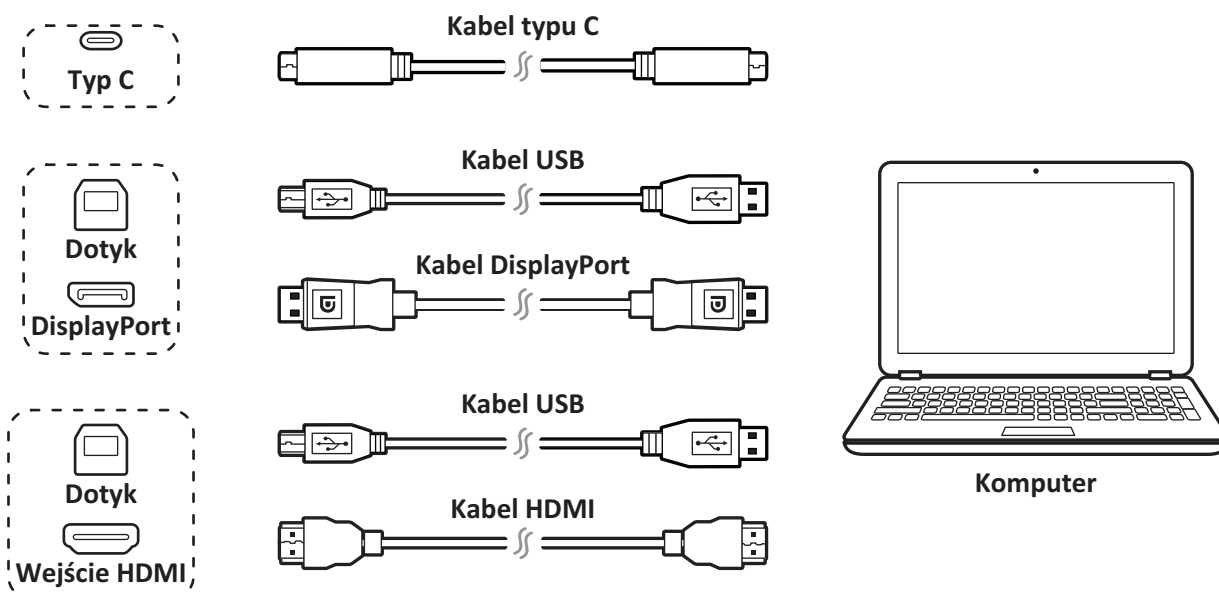

> Połączenia RS232

Gdy do połączenia wyświetlacza z zewnętrznym komputerem używany jest kabel portu szeregowego RS232, niektórymi funkcjami można sterować przez komputer PC, włącznie z włączeniem/wyłączeniem zasilania, regulacją głośności i więcej.

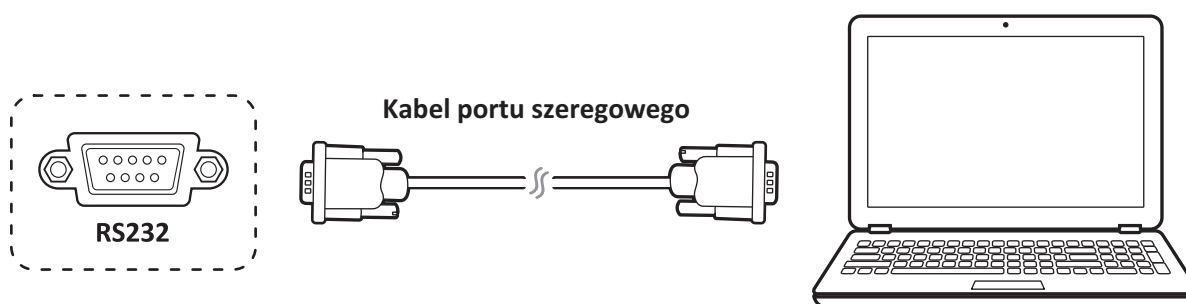

> Podłączanie odtwarzacza multimedialnych (Audio i wideo)

W celu podłączenia do odtwarzacza multimedialnych:

1. Podłącz kabel HDMI do portów HDMI monitora interaktywnego ViewBoard i urządzenia peryferyjnego.
2. Podłącz przewód zasilający monitora interaktywnego ViewBoard i włącz przełącznik zasilania na panelu tylnym.
3. Naciśnij przycisk Zasilanie z prawej strony monitora interaktywnego ViewBoard, aby włączyć ekran.
4. Naciśnij przycisk Wejście na pilocie, aby przełączyć na źródło wejścia "HDMI".

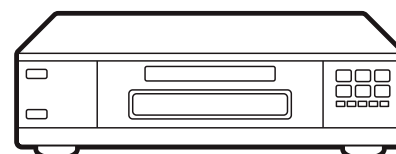
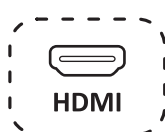

Podłączanie odtwarzacza multimedialnych

> Połączenie SPDIF

W celu podłączenia do zewnętrznego systemu dźwiękowego:

1. Podłącz kabel optyczny od gniazda SPDIF do złącza optycznego posiadanego systemu dźwiękowego.
2. Podłącz przewód zasilający monitora interaktywnego ViewBoard i włącz przełącznik zasilania na panelu tylnym.
3. Naciśnij przycisk Zasilanie z prawej strony monitora interaktywnego ViewBoard, aby włączyć ekran.

Uwaga: Wyjście audio S/PDIF i wyjście audio słuchawek, działają wyłącznie z ViewBoard odtwarzaczem, HDMI i kanałem DP.

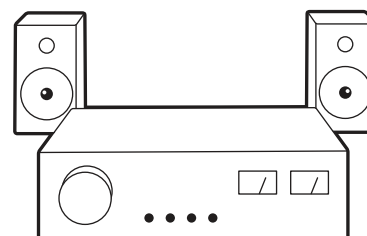
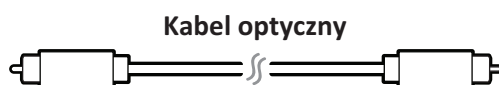
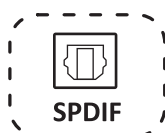

Wzmacniacz z zasilaniem/urządzenie stereo

> Połączenie wyjścia wideo

Aby wyprowadzić wideo przez urządzenie wyświetlania:

1. Podłącz kabel HDMI do gniazda Wejście HDMI urządzenia wyświetlania, a drugi koniec do gniazda Wyjście HDMI monitora interaktywnego ViewBoard.
2. Dla audio, podłącz jeden koniec kabla audio do gniazda EARPHONE monitora interaktywnego ViewBoard, a drugi koniec do głośników.
3. Podłącz przewód zasilający monitora interaktywnego ViewBoard i włącz przełącznik zasilania na panelu tylnym.
4. Naciśnij przycisk Zasilanie z prawej strony monitora interaktywnego ViewBoard, aby włączyć ekran.

Uwaga: Wyjście audio S/PDIF i wyjście audio słuchawek, działają wyłącznie z ViewBoard odtwarzaczem, HDMI i kanałem DP.

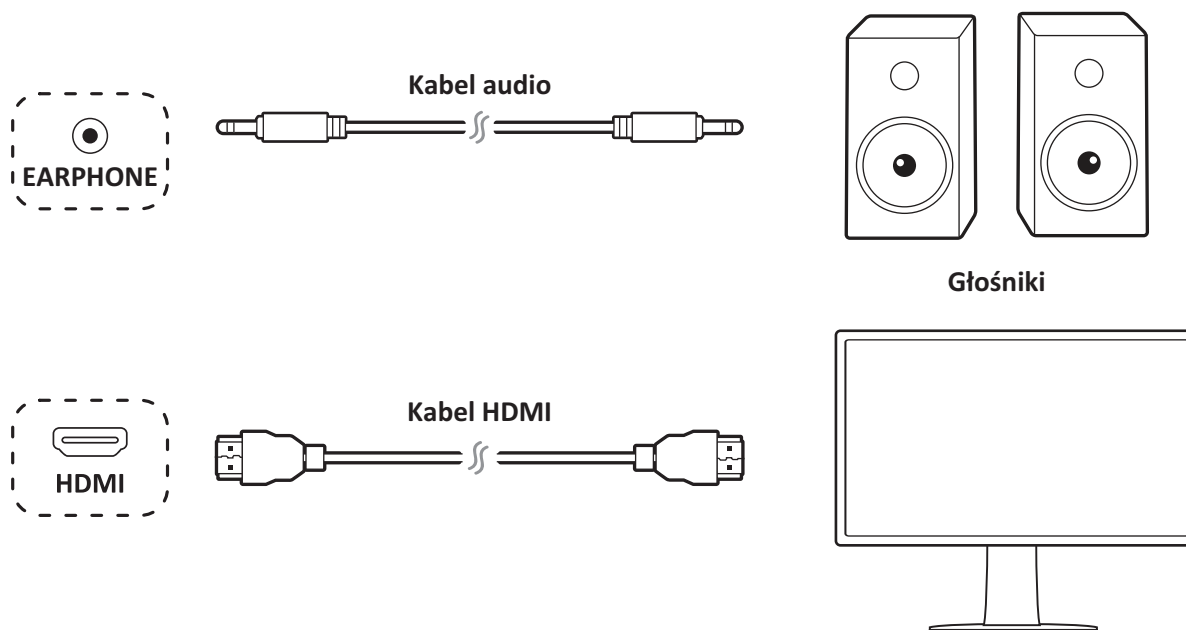

> Rozpoczęcie używania

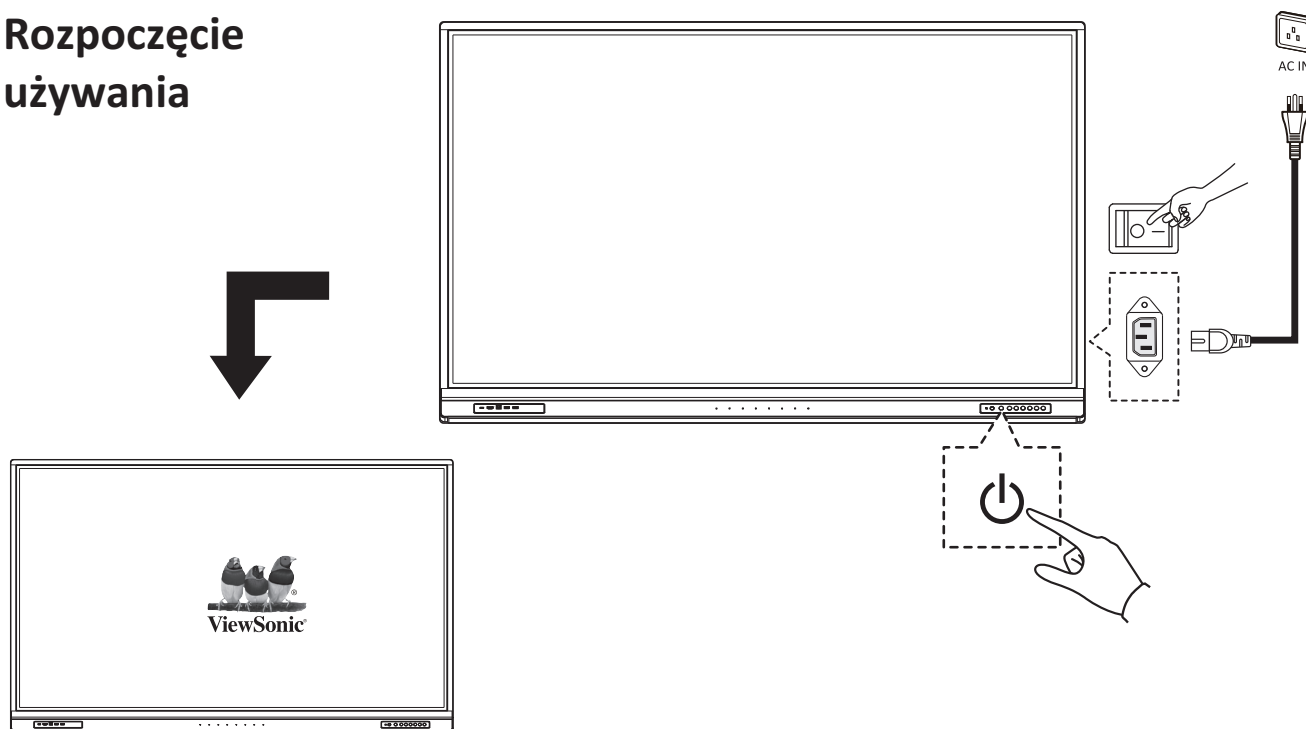



> Oświadczenie o zgodności

Oświadczenie o zgodności z FCC: To urządzenie jest zgodne z częścią 15 przepisów FCC. Jego działanie podlega następującym dwóm warunkom: (1) to urządzenie nie może powodować szkodliwych zakłóceń oraz (2) to urządzenie musi akceptować wszystkie odbierane zakłócenia, włącznie z zakłóceniami, które mogą powodować nieoczekiwane działanie.

Zgodność z przepisami Industry Canada ICES-003: CAN ICES-3 (B)/NMB-3(B)



ViewSonic Corporation (USA/Kanada/Ameryka Łacińska)

 : www.viewsonic.com/support/product-registration



Stany Zjednoczone

 1-800-688-6688

 customerservice@viewsonic.com

Kanada

 1-866-463-4775

 customerservice@viewsonic.com

Portoryko i Wyspy Dziewicze

 <http://www.viewsonic.com/la/soporte/servicio-tecnico> (Español)

Ameryka Łacińska

 <http://www.viewsonic.com/la/soporte/servicio-tecnico-la/>



ViewSonic Europe Ltd.

 : www.viewsoniceurope.com

 +44 (0) 207 382 8251



Europe

 <http://www.viewsoniceurope.com/eu/support/call-desk/>



➤ Комплектация

- Кабель HDMI (10ft/3m)
- Кабель Type-C (5ft/1.5m)
- USB-кабель для сенсорной панели (10ft/3m)
- Зажим - 5 шт.
- Крепежная пластина для веб-камеры
- Батареи типа AAA (2 шт.)
- Стилус-перо (2 шт.)
- Пульт ДУ
- Инструмент для стирания изображения
- Винты для крепления веб-камеры (4 шт.) (M4x7mm x2, M3x6mm x2)
- Краткое руководство
- Декларация соответствия
- Адаптер RS232
- Кабель питания (поставляется в зависимости от региона)
- Винты для настенного крепления (4 шт.) (M8x20mm x4)

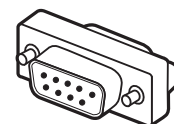
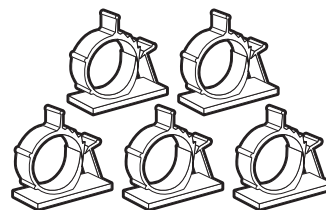
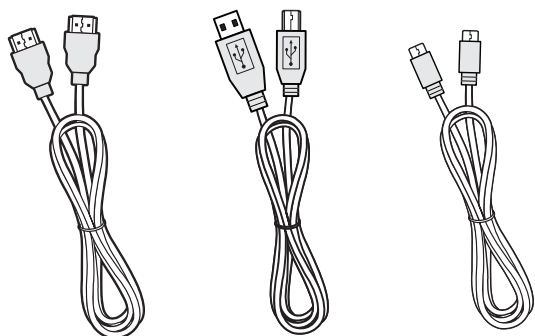
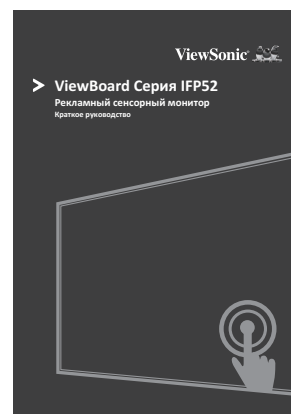

M8 X 4



M3 X 2



M4 X 2

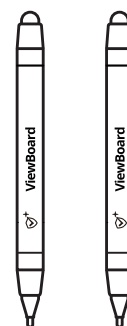
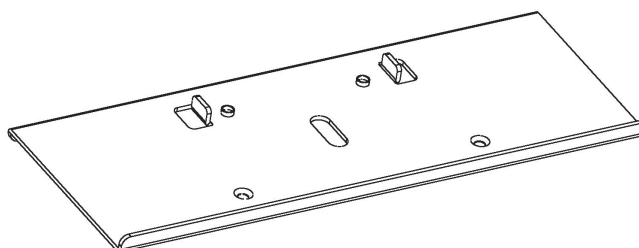
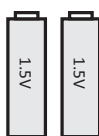
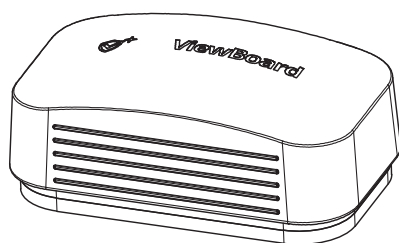

➤ Характеристики комплекта для крепления на стену
(продано отдельно)

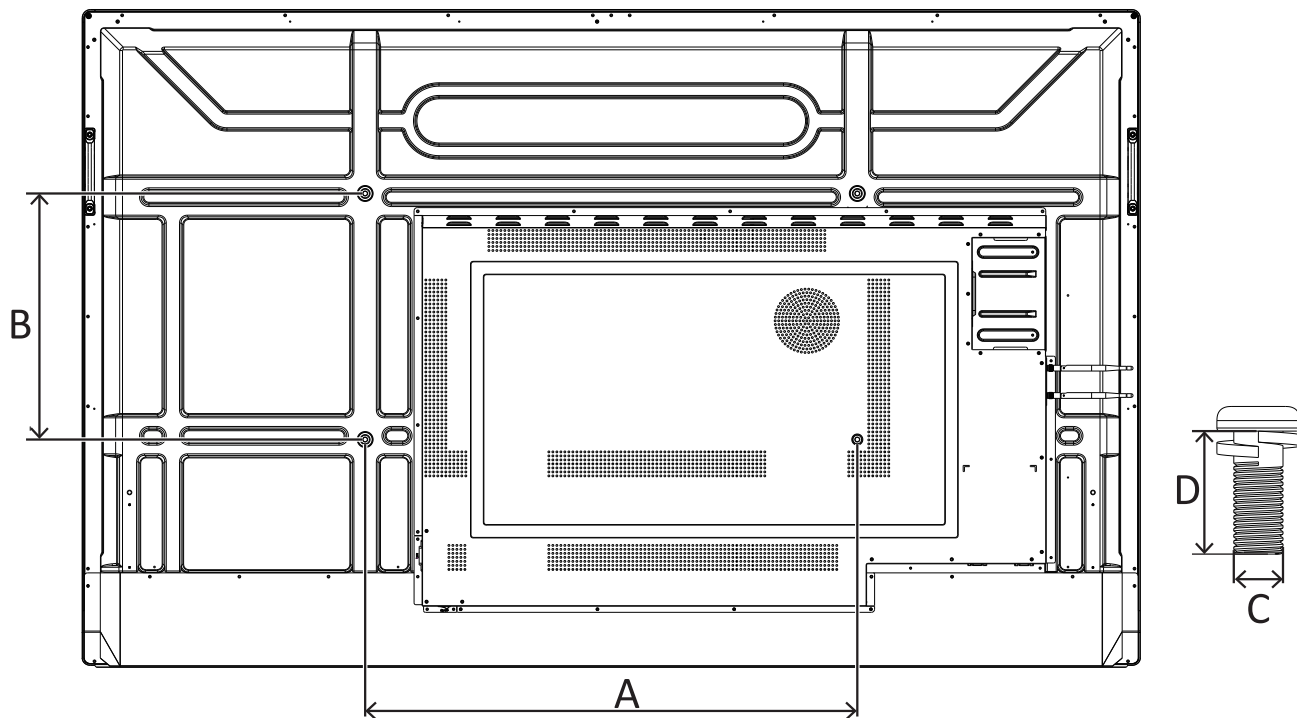

дюйм.	Параметры VESA (A x B)	Стандартный винт (C x D)	Количество
Серия IFP6552	600 x 400 мм	M8 x 20 мм	4
Серия IFP7552	800 x 400 мм	M8 x 20 мм	4
Серия IFP8652	800 x 600 мм	M8 x 20 мм	4

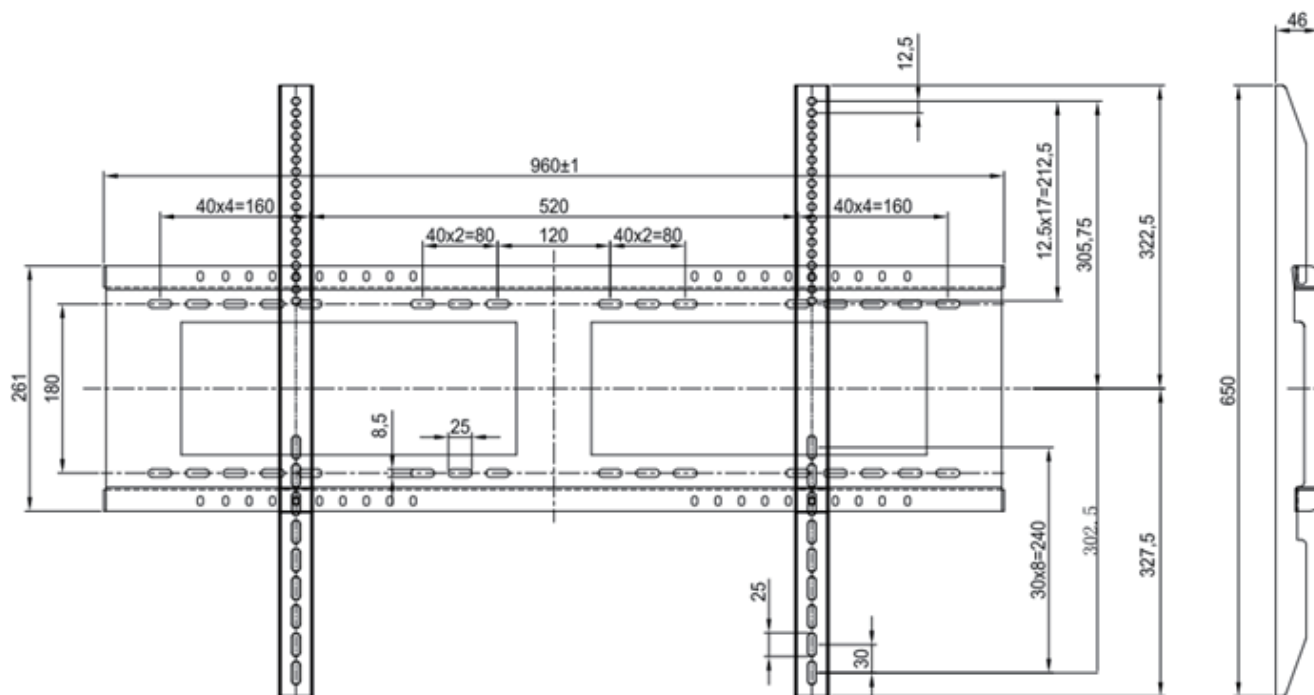

> Условия установки

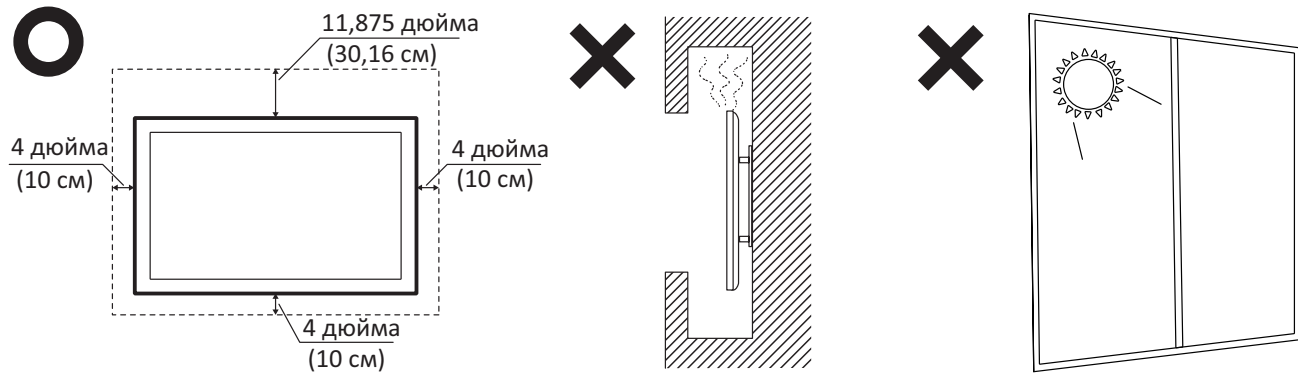

> Обзор панели управления

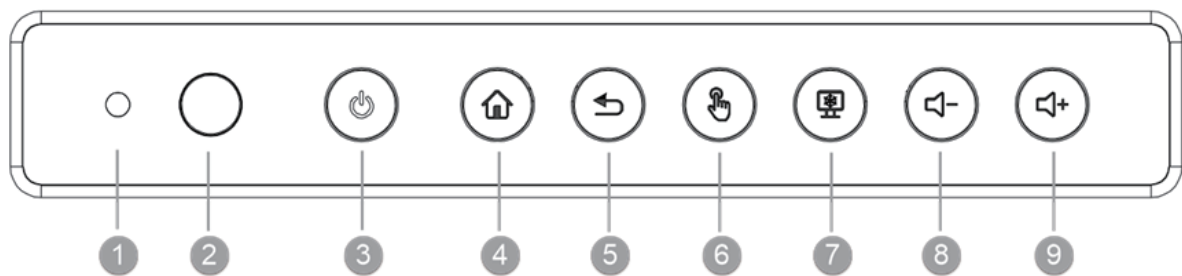

Пункт	Описание
1	Датчик освещения для контроля внешнего освещения
2	Приемник пульта ДУ
3	Световой индикатор питания Нажмите данную кнопку для включения устройства Нажмите данную кнопку для включения/отключения только подсветки дисплея Нажмите данную кнопку для выключения устройства
4	Возврат к основному интерфейсу проигрывателя ViewBoard
5	Возврат к предыдущему экрану проигрывателя ViewBoard
6	Отключить/включить сенсорный экран
7	«Заморозить» текущее изображение на экране
8	Уменьшить громкость
9	Увеличить громкость

> Обзор пульта ДУ

- 1 Питание вкл./выкл.
- 2 Захват экрана
- 3 *ПК: Кнопка «Windows»
- 4 Запуск ПО для письма
- 5 Возврат к Главному экрану Встроенного проигрывателя
- 6 Назад / Возврат на предыдущую страницу
- 7 Увеличение / уменьшение уровня громкости
- 8 Кнопки ввода цифр
- 9 Информация
- 10 Выбор источника входного сигнала
- 11 Кнопки управления мультимедийными устройствами
Красный: ВОСПРОИЗВЕДЕНИЕ/ПАУЗА
Зеленый: СТОП
Желтый: ВПЕРЕД
Синий: НАЗАД
- 12 *ПК: Кнопка «Меню»
- 13 *ПК: Выход из диалоговых окон
- 14 Меню настроек
- 15 Кнопки Вверх/Вниз/Вправо/Влево/ОК
- 16 Замерший экран
- 17 Отключение звука / включение звука
- 18 Увеличение/уменьшение яркости экрана
*ПК: Предыдущая страница / Следующая страница
- 19 Пустой экран
- 20 Настройки соотношения сторон экрана

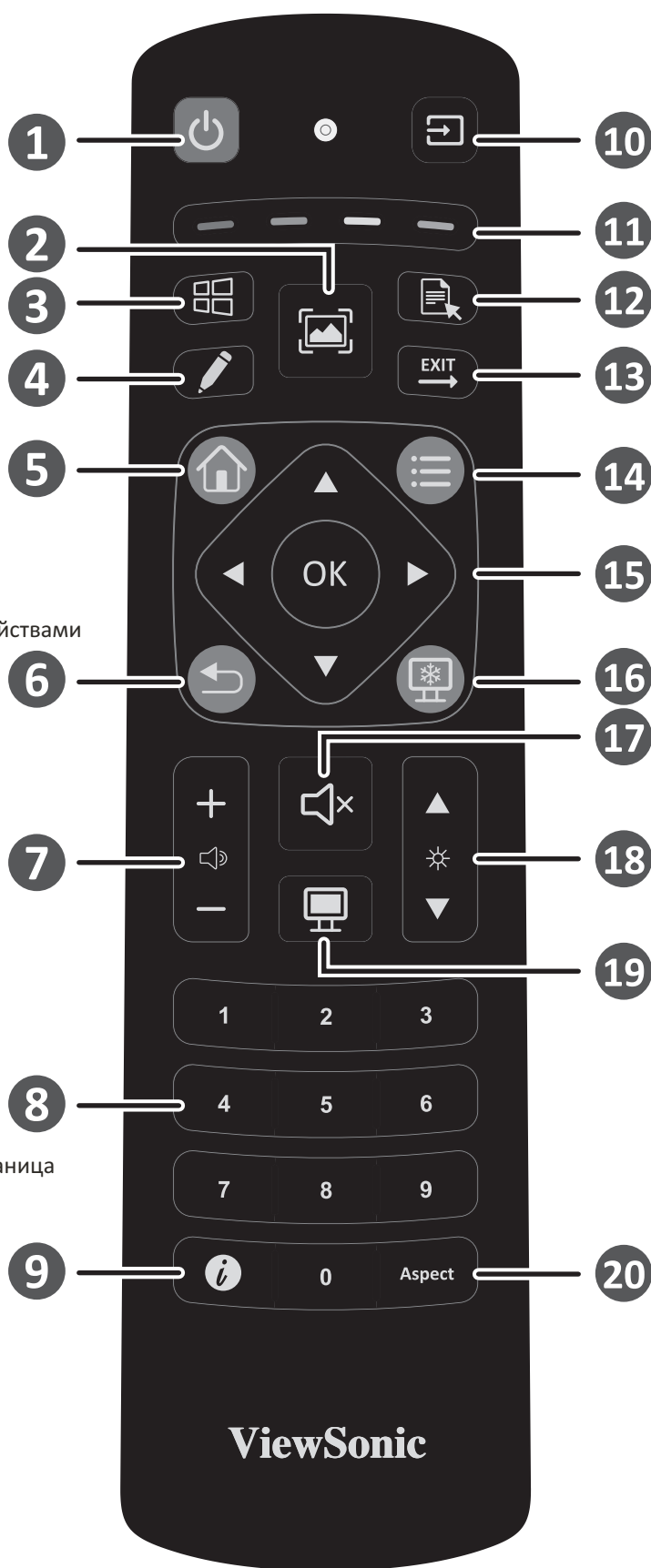

*Кнопка ПК: Не все модели поддерживают данные функции.

➤ Порт ввода-вывода

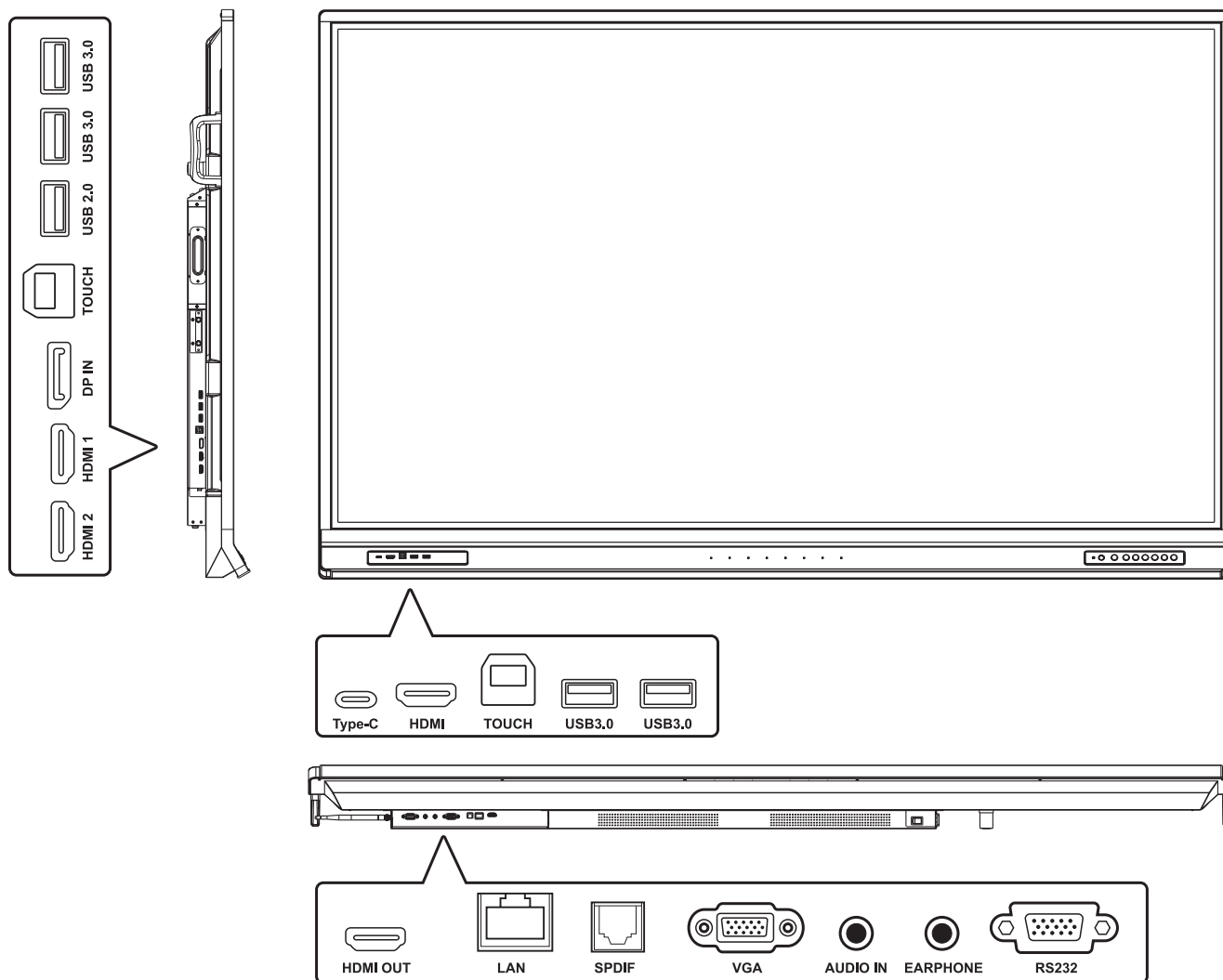

➤ USB и сетевые соединения

Как и любой ПК, к ViewBoard можно легко подключить различные USB-устройства и другие периферийные устройства.

Периферийное оборудование с интерфейсом USB

Подключите кабель USB-устройства к USB-порту.

Подключение к сети и кабели модемов

Подключите кабель маршрутизатора к порту LAN.

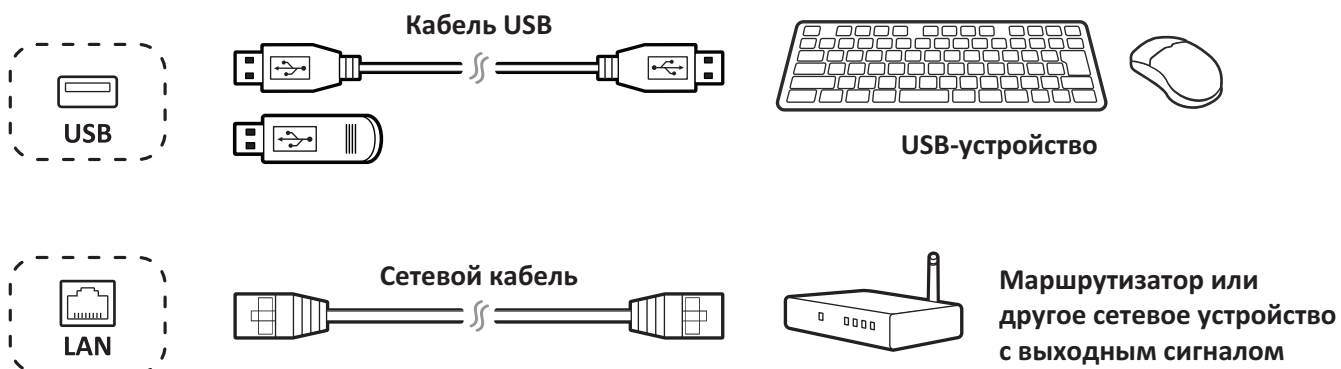

> Подключение внешних устройств и сенсорное подключение

Внешнее устройство(ва) может быть подключено в любой из следующих конфигураций:

Подключение через интерфейс Type C

Подключите кабель Type-C от внешнего устройства к порту Type-C на ViewBoard.

Подключение кабелем DisplayPort

1. Подключите кабель DisplayPort от внешнего устройства к порту DisplayPort на ViewBoard.
2. Подключите USB-кабель к внешнему устройству от порта TOUCH на ViewBoard.

Подключение кабелем HDMI

1. Подключите кабель HDMI от внешнего устройства к порту HDMI IN на ViewBoard.
2. Подключите USB-кабель к внешнему устройству от порта TOUCH на ViewBoard.

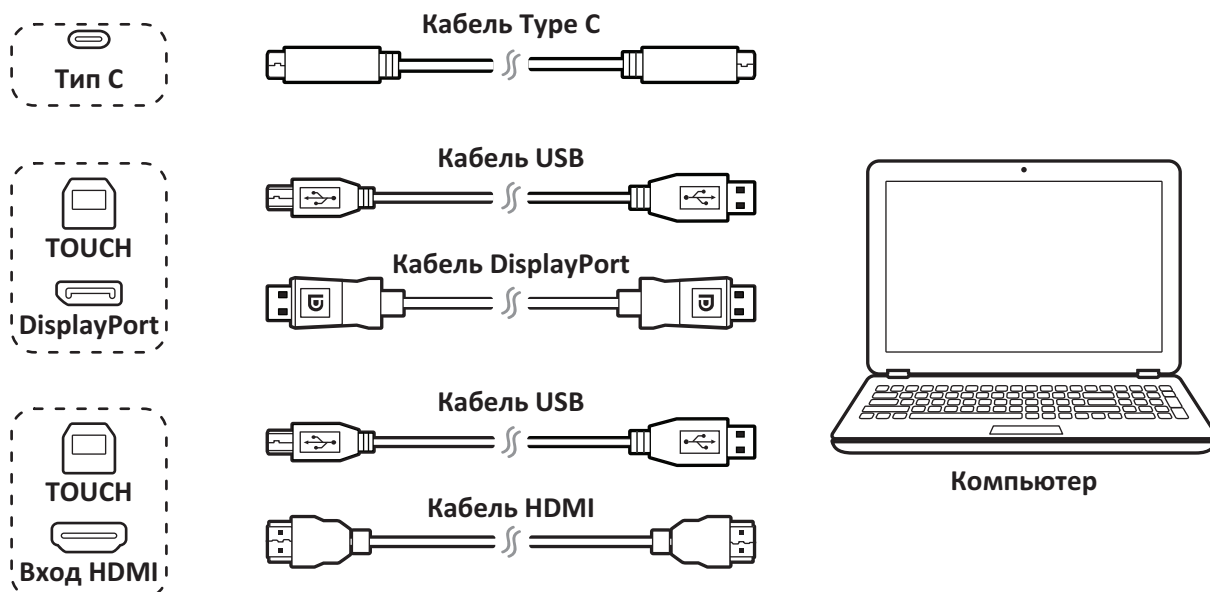

> Подключения RS232

При использовании кабеля последовательного интерфейса RS232 для соединения дисплея с внешним компьютером через ПК можно будет управлять некоторыми функциями, в том числе включением и выключением питания, регулировкой уровня громкости и др.



➤ Подключение медиаплеера (аудио и видео)

Порядок подключения медиаплеера.

1. Подключите кабель HDMI к портам HDMI на ViewBoard и периферийном устройстве.
2. Подключите шнур питания ViewBoard и включите переключатель питания на задней панели.
3. Нажмите кнопку питания на правой стороне ViewBoard, чтобы включить экран.
4. Нажмите кнопку INPUT (ВВОД) на пульте дистанционного управления и выберите источник входного сигнала HDMI.

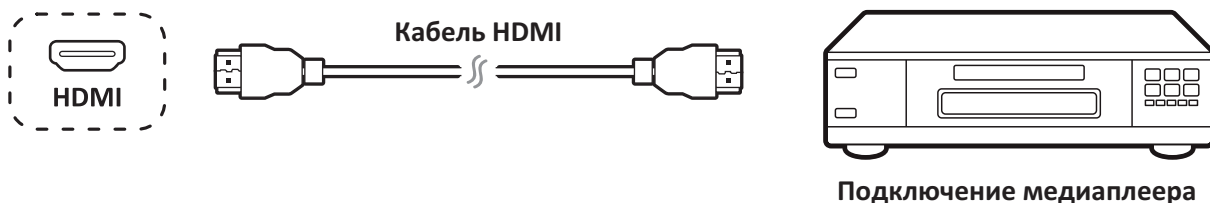

➤ Подключение SPDIF

Для подключения к внешней акустической системе выполните следующие действия.

1. Подключите оптический кабель от порта SPDIF к оптическому разъему акустической системы.
2. Подключите шнур питания ViewBoard и включите переключатель питания на задней панели.
3. Нажмите кнопку питания на правой стороне ViewBoard, чтобы включить экран.

Примечание. Выход S/PDIF и аудиовыход для наушников работают только с каналами ViewBoard Player, HDMI и DP.

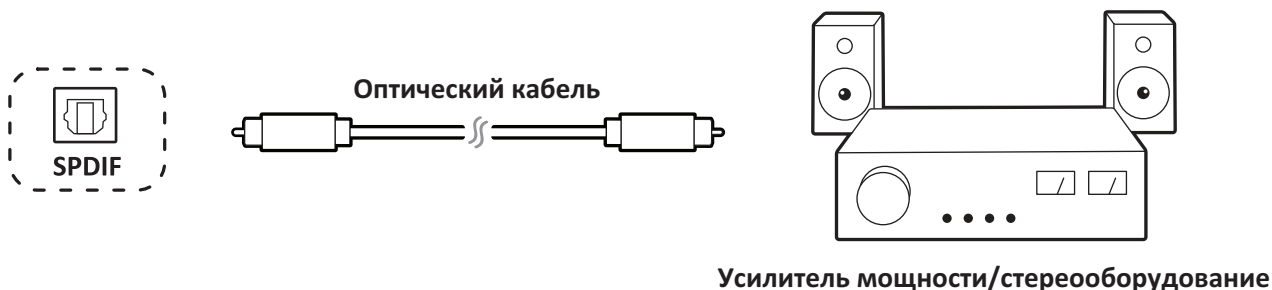

➤ Подключение видеовыхода

Для вывода видеосигнала через устройство отображения выполните следующие действия.

1. Подключите кабель HDMI к порту HDMI IN на дисплее, а другой конец кабеля — к порту HDMI OUT на ViewBoard.
2. Для передачи аудиосигнала подключите один конец аудиокабеля к порту AUDIO OUT на ViewBoard, а другой конец — к динамикам.
3. Подключите шнур питания ViewBoard и включите переключатель питания на задней панели.
4. Нажмите кнопку питания на правой стороне ViewBoard, чтобы включить экран.

Примечание. Выход S/PDIF и аудиовыход для наушников работают только с каналами ViewBoard Player, HDMI и DP.

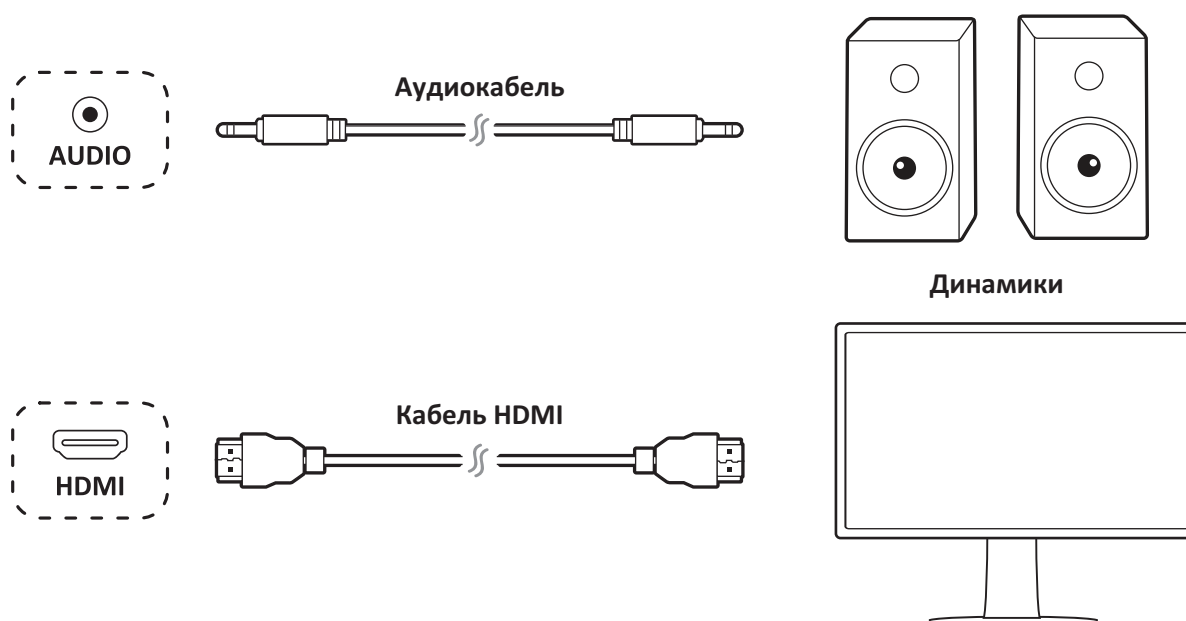

➤ Подготовка к работе

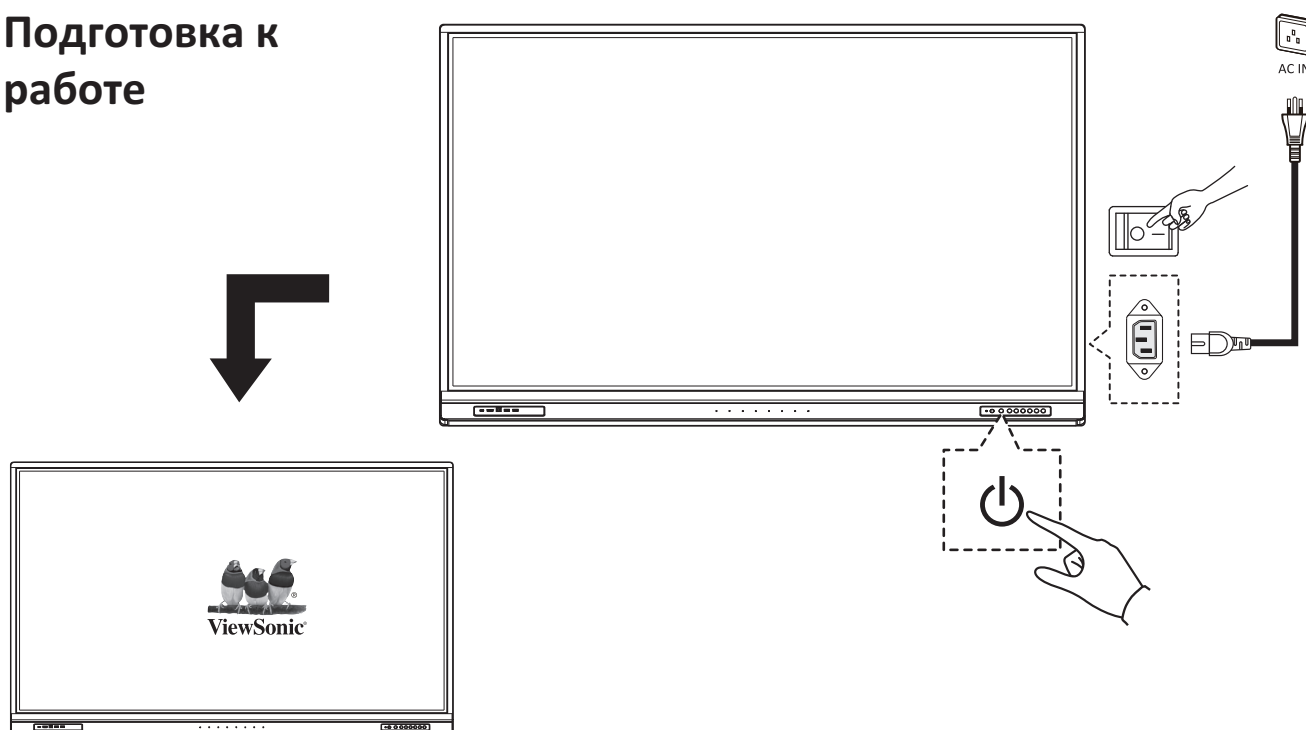



> Соответствие стандартам

Соответствие требованиям ФКС США: Данное устройство соответствует требованиям правил FCC, часть 15. При использовании устройства должны соблюдаться два следующих условия: (1) данное устройство не должно быть источником помех; (2) данное устройство должно быть устойчивым к помехам, создаваемым другими приборами, включая такие помехи, которые могут стать причиной его неправильной работы.

Соответствие промышленному стандарту Канады ICES-003: CAN ICES-3 (B)/NMB-3(B)



Корпорация ViewSonic (США/ Канада/ Латинская Америка)

 : www.viewsonic.com/support/product-registration



США

 1-800-688-6688

 customerservice@viewsonic.com

Канада

 1-866-463-4775

 customerservice@viewsonic.com

Пуэрто-Рико и Виргинские острова

 <http://www.viewsonic.com/la/soporte/servicio-tecnico> (Español)

Латинская Америка

 <http://www.viewsonic.com/la/soporte/servicio-tecnico-la/>



ViewSonic Europe Ltd.

 : www.viewsoniceurope.com

 +44 (0) 207 382 8251



Europe

 <http://www.viewsoniceurope.com/eu/support/call-desk/>



Центр поддержки
ViewSonic



Дополнительная
принадлежность

➤ Contenido del paquete

- Cable HDMI (10ft/3m)
- Cable Tipo C (5ft/1.5m)
- Cable USB para función táctil (10ft/3m)
- Abrazadera x 5
- Placa de cámara web
- Pila de tipo AAA x 2
- Lápiz táctil x 2
- Mando a distancia
- Borrador
- Tornillos de la cámara web x 4 (M4x7mm x2, M3x6mm x2)
- Guía de inicio rápido
- Declaración de conformidad
- Adaptador RS232
- Cable de alimentación (envío según región)
- Tornillos para instalación en pared x 4 (M8x20mm x4)

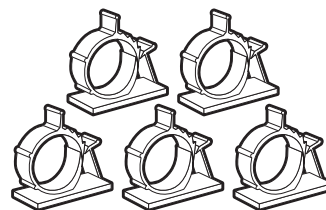
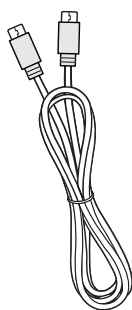
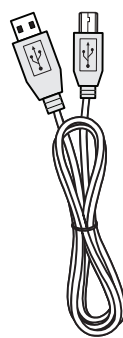
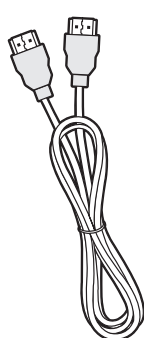
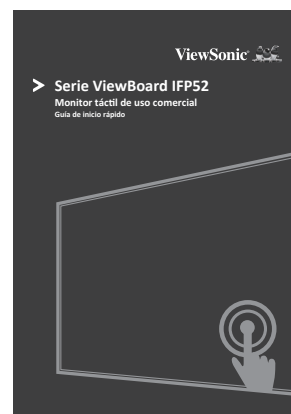
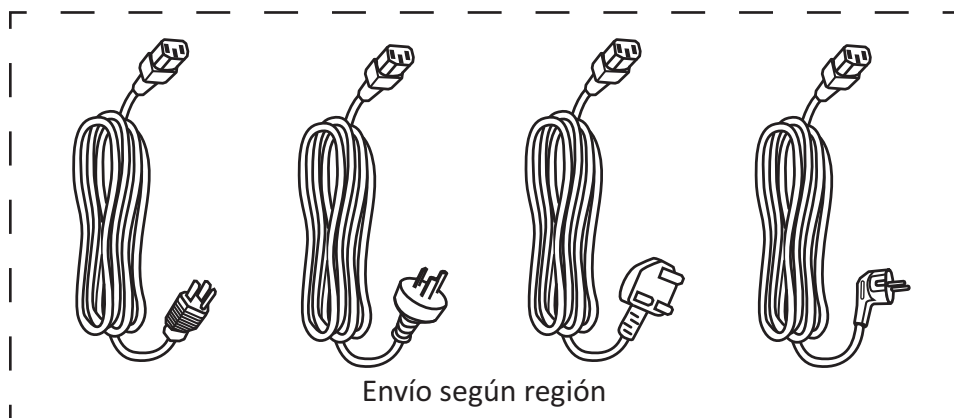

M8 X 4



M3 X 2



M4 X 2

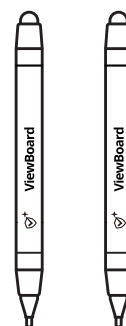
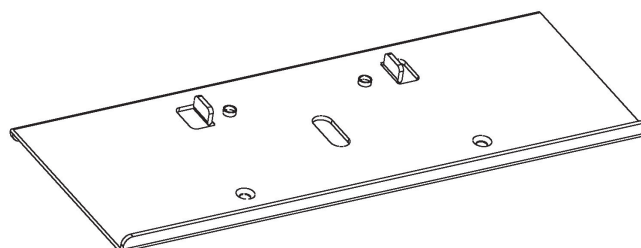
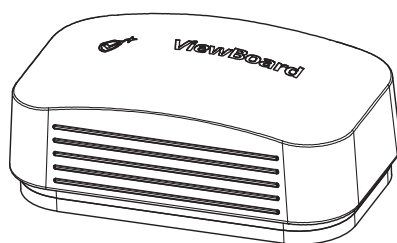

> Atención al entorno de instalación

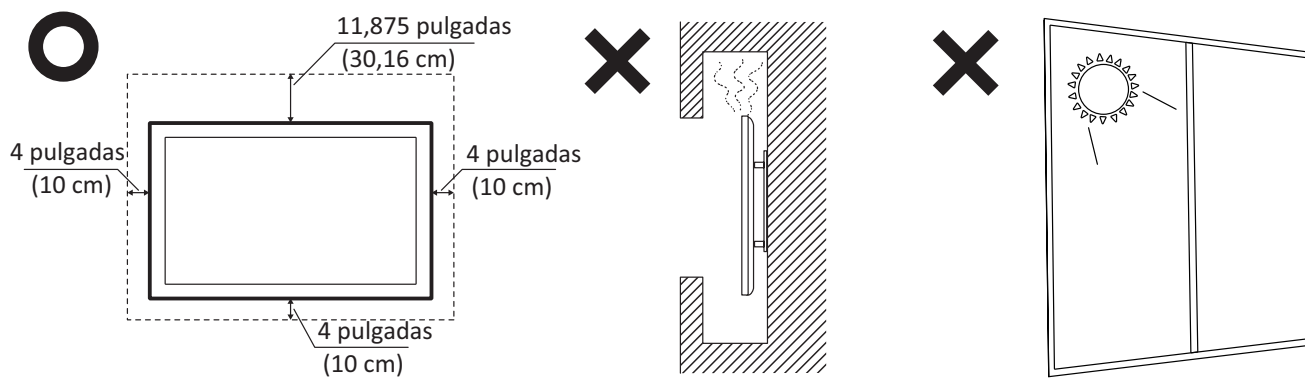

> Información general del panel de Control

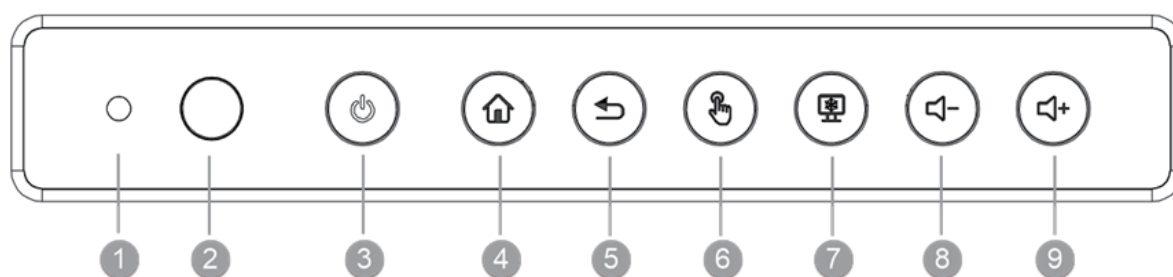

Elemento	Descripción
1	Sensor de luz ambiental para supervisar la luz ambiente
2	Receptor del mando a distancia
3	Indicador luminoso de alimentación Presione la tecla para encender el dispositivo. Presione la tecla para apagar o encender la luz de fondo de la pantalla solamente. Mantenga presionada la tecla para apagar el dispositivo.
4	Volver a la interfaz principal del reproductor ViewBoard
5	Volver al nivel anterior del reproductor ViewBoard
6	Deshabilitar o habilitar la pantalla táctil
7	Congelar la imagen actual en la pantalla
8	Bajar volumen
9	Subir volumen

> Información general del mando a distancia

- 1 Encendido/Apagado
- 2 Captura de pantalla
- 3 *PC: Botón "Windows"
- 4 Escritura de inicio
- 5 Volver a la pantalla de inicio del reproductor incorporado
- 6 Atrás/Volver a la página anterior
- 7 Subir o bajar volumen
- 8 Teclado numérico
- 9 Información
- 10 Selección de fuente de entrada
- 11 Botón Control multimedia
Rojo: REPRODUCIR / PAUSA
Verde: DETENER
Amarillo: AVANZAR
Azul: RETROCEDER
- 12 *PC: Botón "Menu"
- 13 *PC: Salir del cuadro de diálogo
- 14 Menú de configuración
- 15 Teclas Arriba/Abajo/Derecha/Izquierda/Aceptar
- 16 Congelar pantalla
- 17 Silencio/Desactivar silencio
- 18 Subir o bajar brillo
*PC: Re Pág/Av Pág
- 19 Pantalla en blanco
- 20 Pulse este botón para ajustar la relación de aspecto.

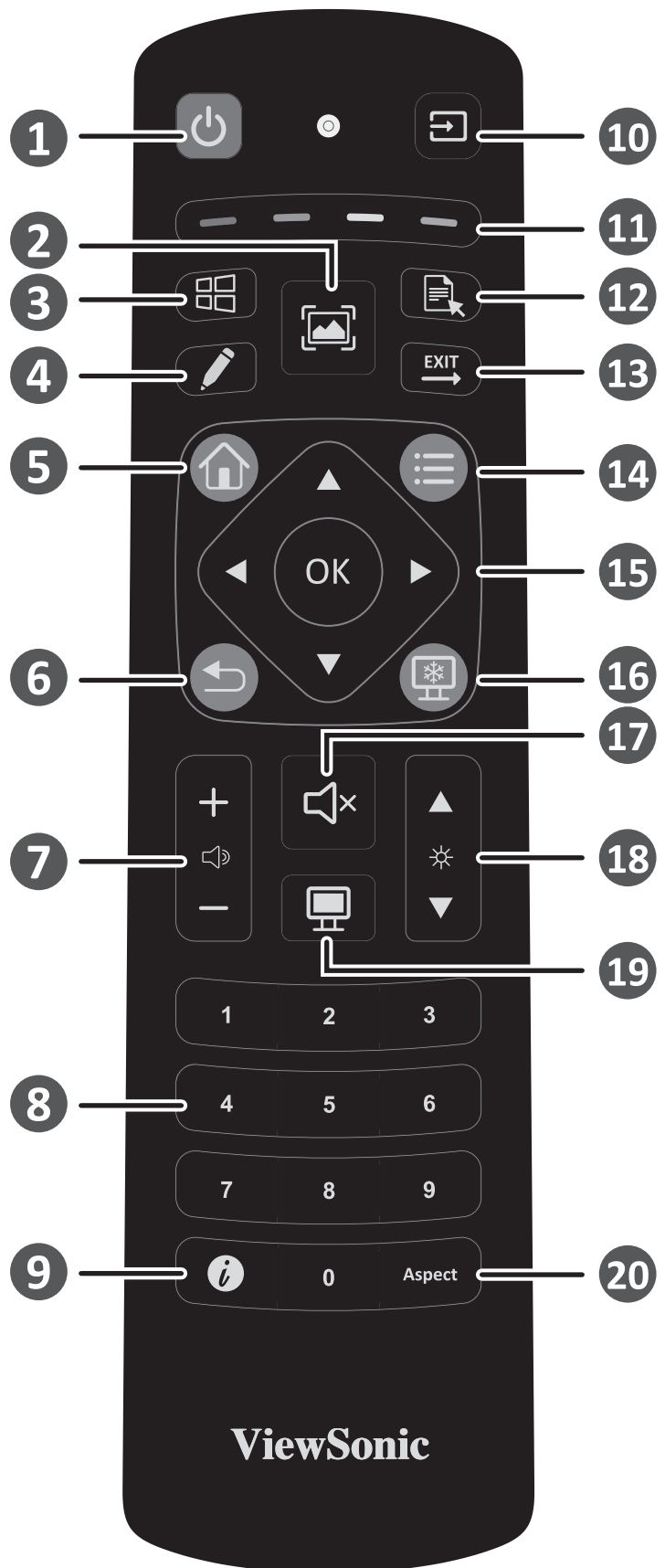

*Botón PC: No todos los modelos admiten estas funciones

➤ Puerto de E/S

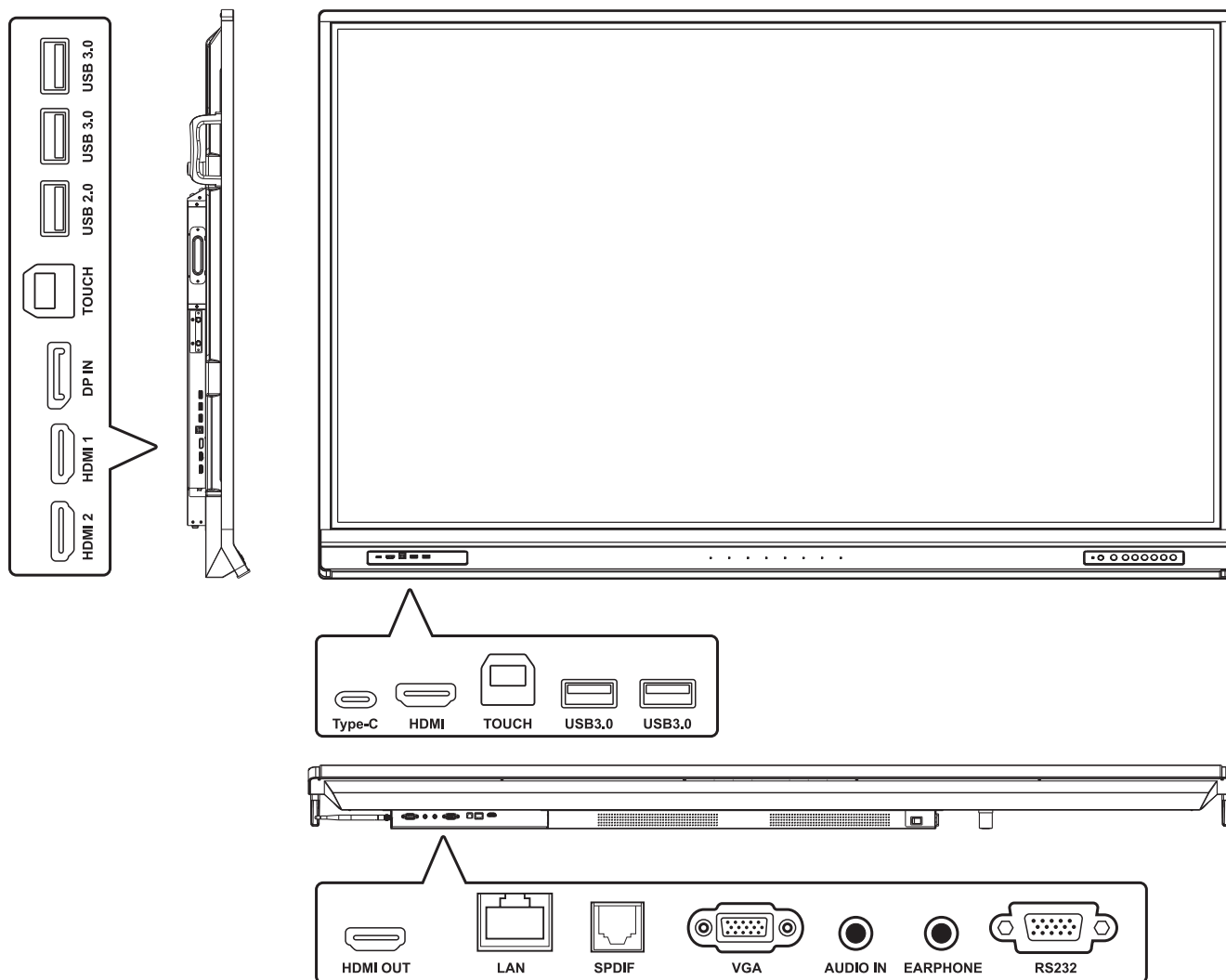

➤ Conexiones USB y de red

Al igual que sucede con cualquier PC, es fácil conectar varios dispositivos USB y otros periféricos a su ViewBoard.

Periféricos USB

Enchufe el cable del dispositivo USB en el puerto USB.

Cables para conexión en red y del módem

Enchufe el cable del enrutador en el puerto LAN.

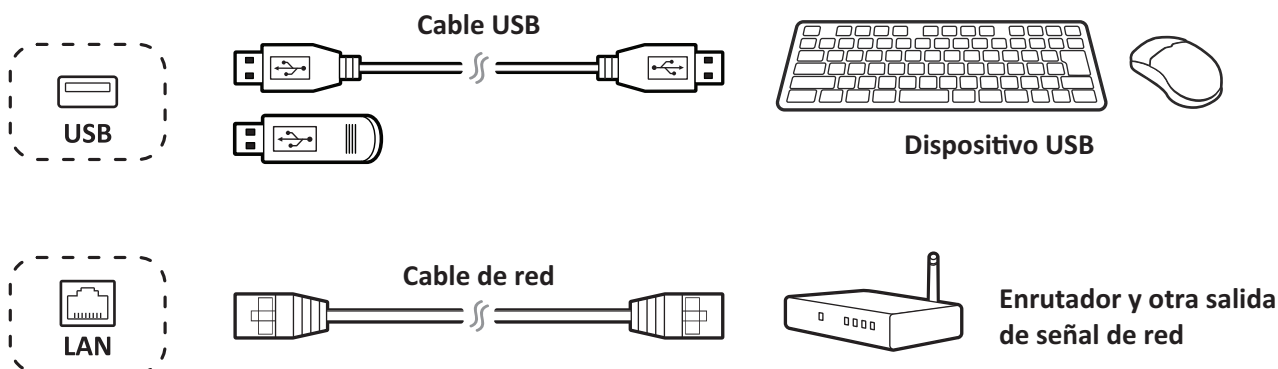

> Conectar dispositivos externos y conexión táctil

Los dispositivos externos se pueden conectar en cualquiera de las siguientes configuraciones:

Conexión Tipo C

Conecte un cable Tipo C desde el dispositivo externo al puerto Tipo C de su ViewBoard.

Conexión DisplayPort

1. Conecte un cable DisplayPort desde el dispositivo interno al puerto DisplayPort de su ViewBoard.
2. Conecte un cable USB al dispositivo externo desde el puerto TÁCTIL de su ViewBoard.

Conexión HDMI

1. Conecte un cable HDMI desde el dispositivo interno al puerto ENTRADA HDMI de su ViewBoard.
2. Conecte un cable USB al dispositivo externo desde el puerto TÁCTIL de su ViewBoard.

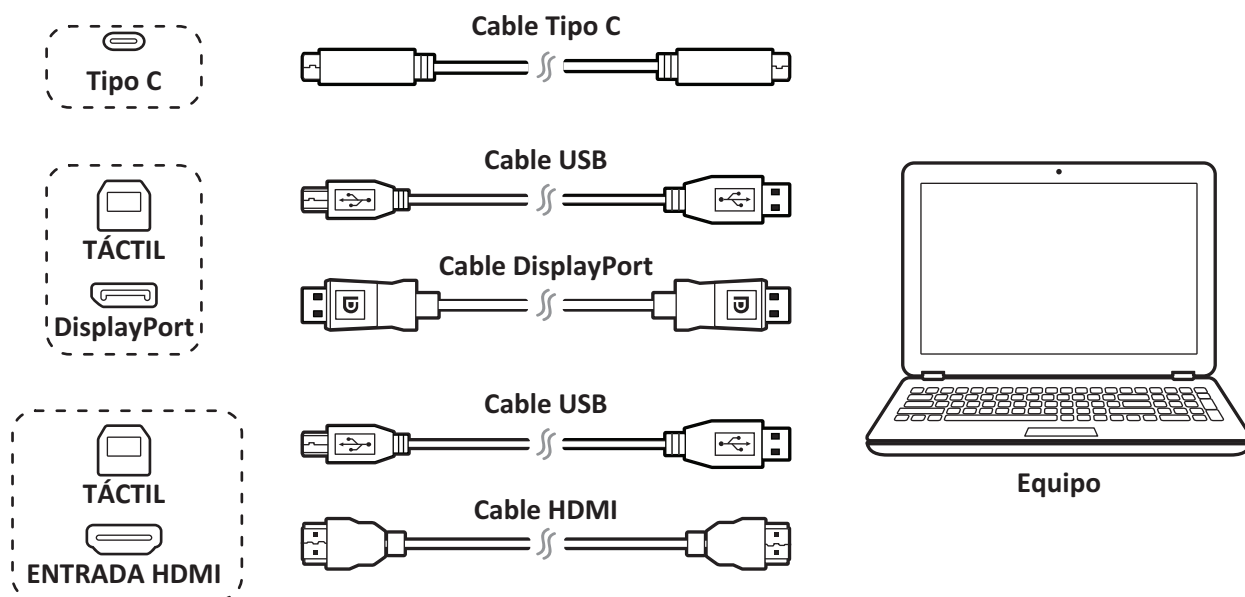

> Conexiones RS232

Cuando utilice un cable de puerto serie RS232 para conectar la pantalla a un equipo externo, determinadas funciones se pueden controlar mediante su PC, como el encendido y apagado de la alimentación, el ajuste de volumen, etc.

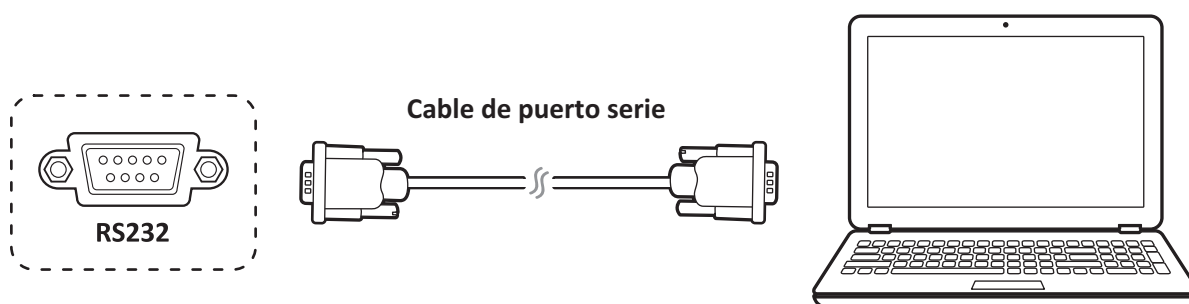

> Conexión con reproductor multimedia (audio y vídeo)

Para conectar un reproductor multimedia:

1. Conecte el cable HDMI a los puertos HDMI de su ViewBoard y el dispositivo periférico.
2. Enchufe el cable de alimentación de su ViewBoard y gire el interruptor de alimentación del panel posterior.
3. Presione el botón de encendido del lado derecho de su ViewBoard para encender la pantalla.
4. Presione el botón ENTRADA del mando a distancia y cambie a la fuente entrada "HDMI".

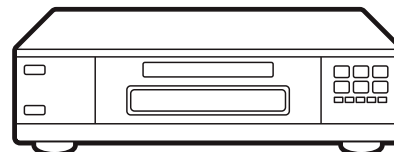
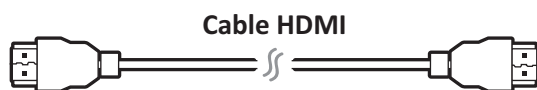
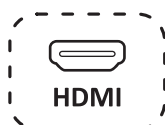

Conexión con reproductor multimedia

> Conexión SPDIF

Para realizar la conexión con un sistema de sonido externo:

1. Conecte un cable óptico entre el puerto SPDIF y el conector óptico del sistema de sonido.
2. Enchufe el cable de alimentación de su ViewBoard y gire el interruptor de alimentación del panel posterior.
3. Presione el botón de encendido del lado derecho de su ViewBoard para encender la pantalla.

Nota: La salida de S/PDIF y auriculares solo funciona en el canal ViewBoard Player, HDMI y DP.

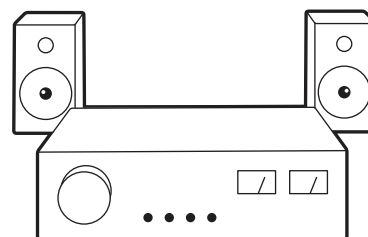
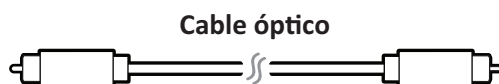

Amplificador de potencia y equipo estéreo

> Conexión de salida de vídeo

Para transmitir vídeo a través de un dispositivo de visualización:

1. Conecte un cable HDMI al puerto ENTRADA HDMI del dispositivo de visualización y el otro extremo al puerto SALIDA HDMI de su ViewBoard.
2. Para audio, conecte un extremo de un cable de audio al puerto EARPHONE de su ViewBoard y el otro extremo a los altavoces.
3. Enchufe el cable de alimentación de su ViewBoard y gire el interruptor de alimentación del panel posterior.
4. Presione el botón de encendido del lado derecho de su ViewBoard para encender la pantalla.

Nota: La salida de S/PDIF y auriculares solo funciona en el canal ViewBoard Player, HDMI y DP.

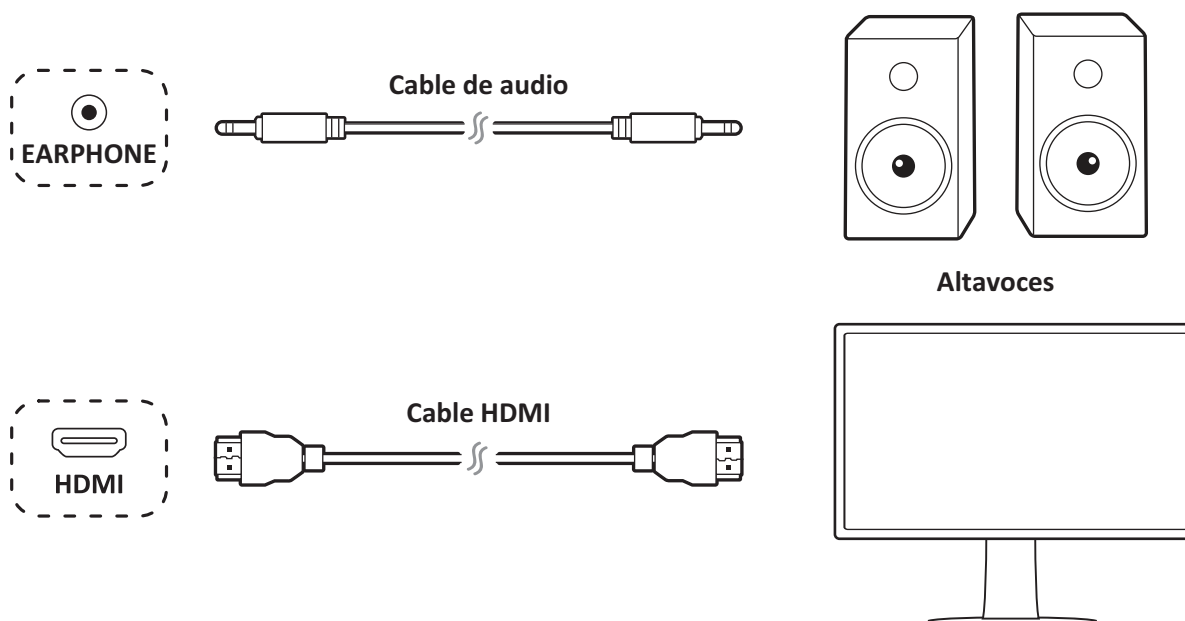

> Empezar a usar

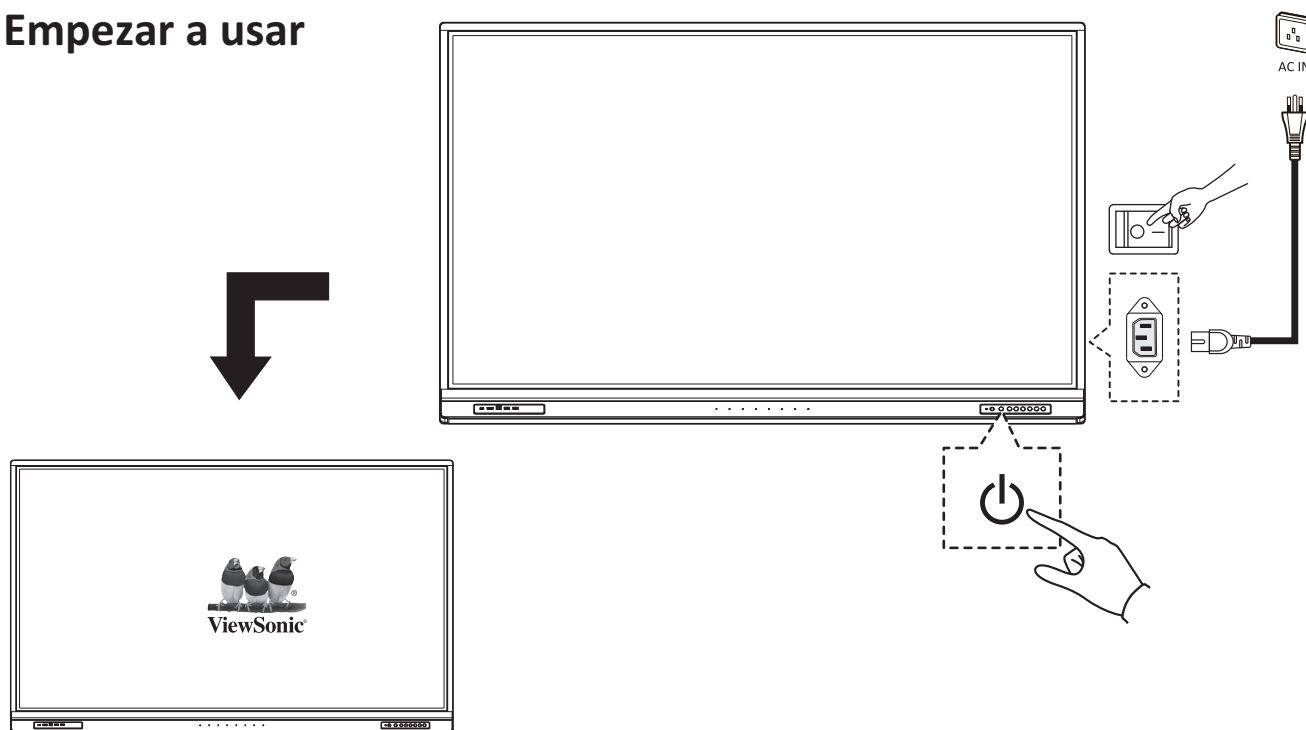



> Declaración de conformidad

Declaración de cumplimiento de la FCC: Este dispositivo cumple el Apartado 15 de las normas FCC. El funcionamiento está sujeto a las siguientes dos condiciones: (1) este dispositivo no deberá causar interferencias perjudiciales y (2) este dispositivo deberá aceptar cualquier interferencia que reciba, incluidas interferencias que puedan causar un funcionamiento no deseado.

Cumplimiento del estándar Industry Canada ICES-003: CAN ICES-3 (B)/NMB-3(B)



ViewSonic Corporation (EE.UU./Canadá/América Latina)

 : www.viewsonic.com/support/product-registration



Estados Unidos

 1-800-688-6688

 customerservice@viewsonic.com

Canadá

 1-866-463-4775

 customerservice@viewsonic.com

Puerto Rico e Islas Vírgenes

 <http://www.viewsonic.com/la/soporte/servicio-tecnico> (Español)

América Latina

 <http://www.viewsonic.com/la/soporte/servicio-tecnico-la/>



ViewSonic Europe Ltd.

 : www.viewsoniceurope.com

 +44 (0) 207 382 8251



Europe

 <http://www.viewsoniceurope.com/eu/support/call-desk/>



> Paketets innehåll

- HDMI-kabel (10ft/3m)
- Typ-C-kabel (5ft/1.5m)
- USB-kabel för peka (10ft/3m)
- Klämma x 5
- Platta för webbkamera
- AAA-batteri x 2
- Pekpena x 2
- Fjärrkontroll
- Sudd
- Webbkameraskruvar x 4 (M4x7mm x2, M3x6mm x2)
- Snabbstartsguide
- Försäkran om efterlevnad
- RS232-adapter
- Strömkabel (medföljer efter region)
- Väggh monteringskruvar x 4 (M8x20mm x4)

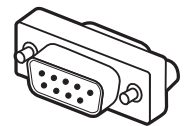
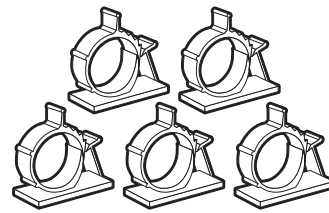
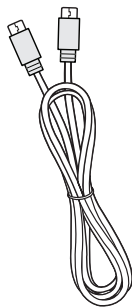
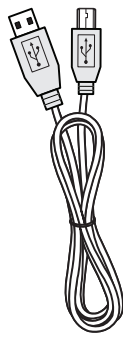
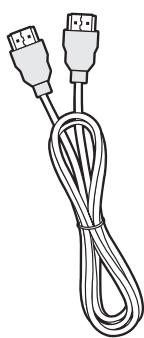
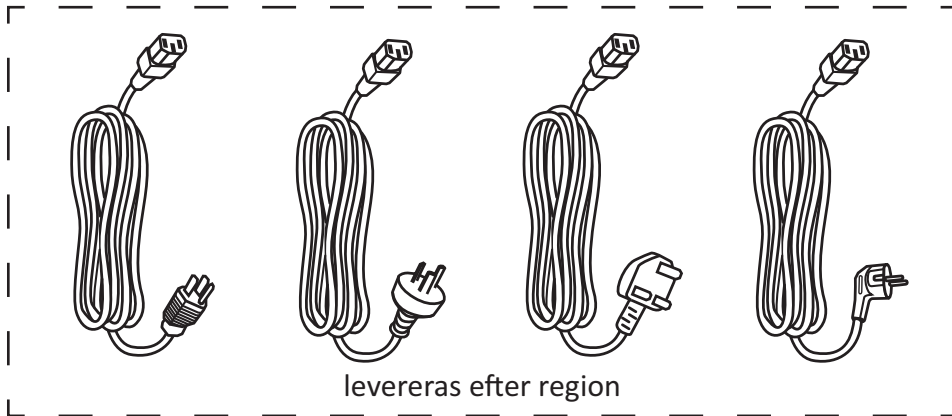

M8 X 4



M3 X 2



M4 X 2

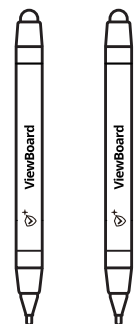
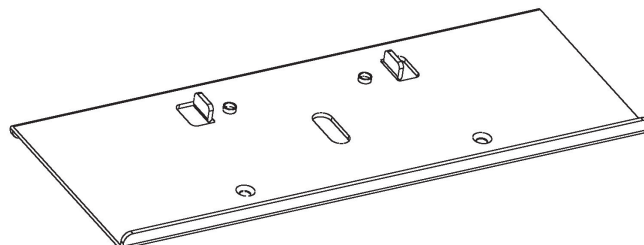
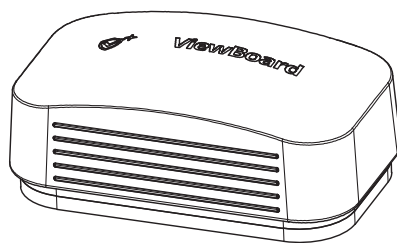

➤ Vägghäste (säljs separat), specifikationer

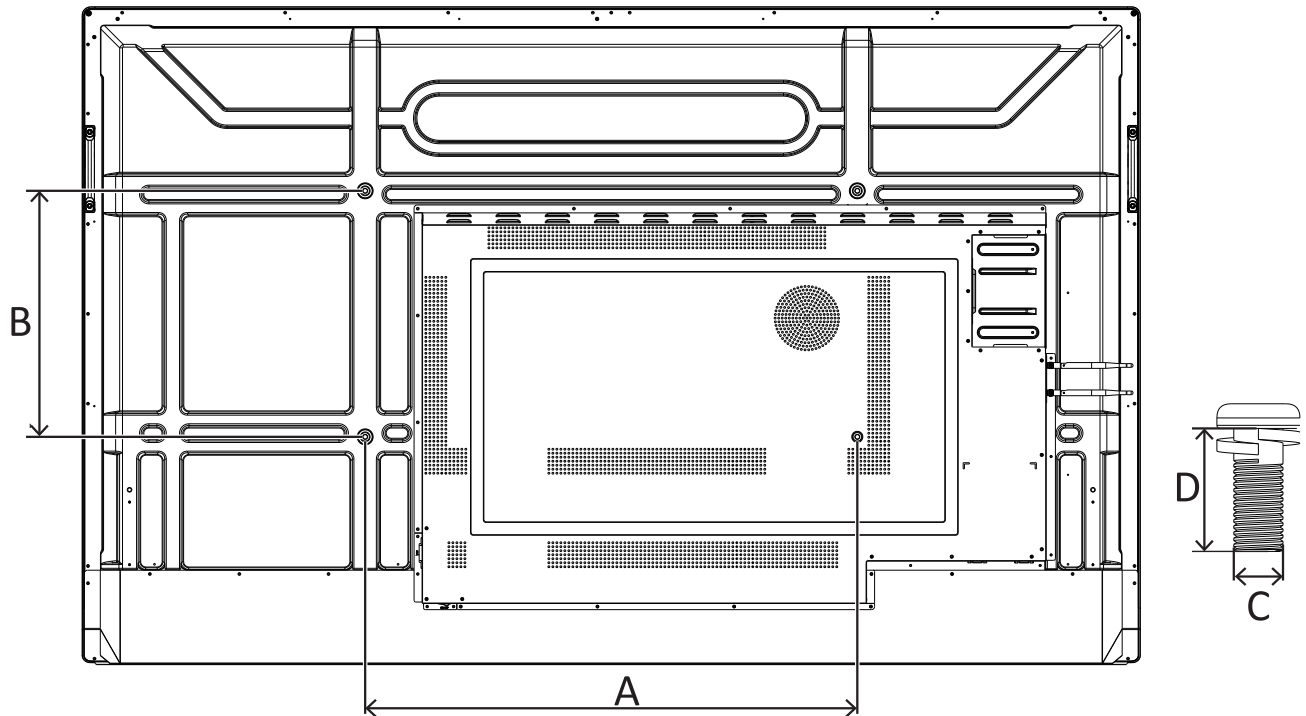

tum	VESA Spec. (A x B)	Standardskruv (C x D)	Kvantitet
IFP6552-serien	600 x 400 mm	M8 x 20 mm	4
IFP7552-serien	800 x 400 mm	M8 x 20 mm	4
IFP8652-serien	800 x 600 mm	M8 x 20 mm	4

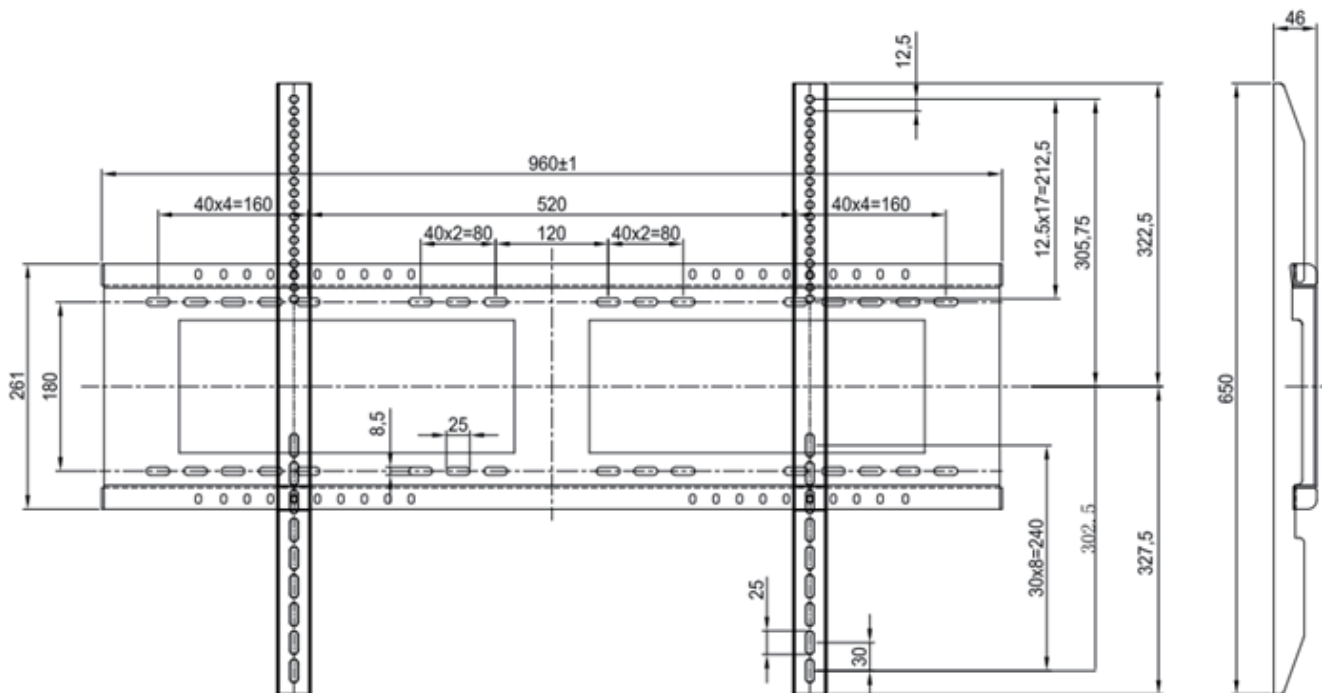

> Installationsmiljö

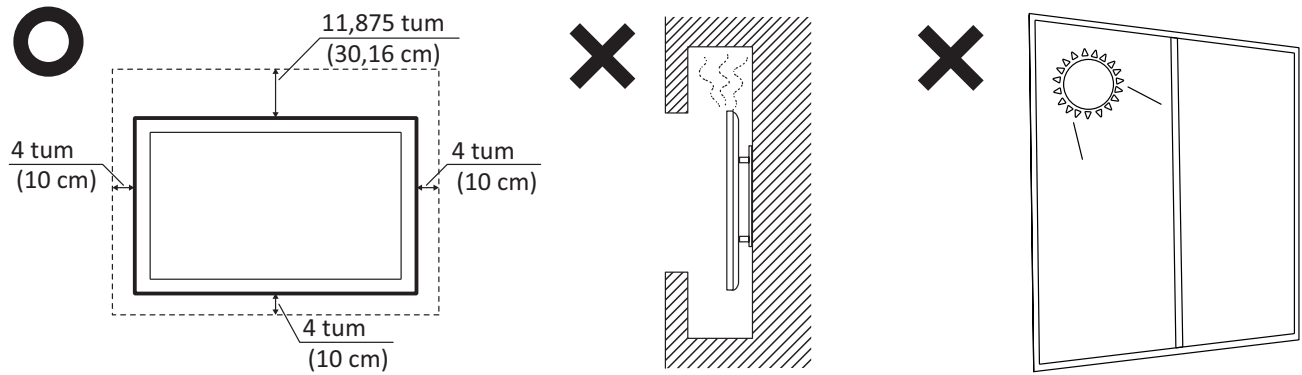

> Kontrollpanel, översikt

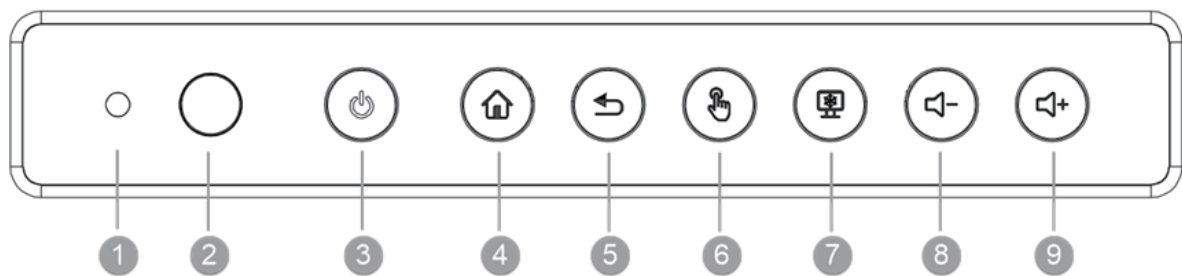

Objekt	Beskrivning
1	Ljussensor för att detektering av omgivande ljus
2	Fjärrkontrollmottagare
3	Strömindikator Tryck på knappen för att slå på enheten Tryck på knappen för att endast stänga av/på skärmens bakgrundsbelysning Håll ned knappen för att stänga av enheten
4	Tillbaka till ViewBoard-spelarens huvudgränssnitt
5	Återgå till ViewBoard-spelarens tidigare nivå
6	Inaktivera/aktivera pekskärmen
7	Frys aktuell bild på skärmen
8	Minska volymen
9	Öka volymen

> Fjärrkontroll, översikt

- 1 Ström på/av
- 2 Skärmdump
- 3 *PC: "Windows"-knappen
- 4 Börja skriva
- 5 Tillbaka till inbäddade spelarens startskärm
- 6 Tillbaka/återgå till föregående sida
- 7 Öka/minska volymen
- 8 Sifferknappsats
- 9 Information
- 10 Val av ingångskälla
- 11 Mediekontrollknappar
Röd: SPELA/PAUSA
Grön: STOPP
Gul: FRAMÅT
Blå: BAKÅT
- 12 *PC: "Meny"-knapp
- 13 *PC: Stäng dialogrutan
- 14 Inställningsmeny
- 15 Upp/Ned/Höger/Vänster/OK-knappar
- 16 Frys skärm
- 17 Tyst/stäng av ljudet
- 18 Öka/minska ljusstyrkan
*PC: Sida upp/sida ner
- 19 Tom skärm
- 20 Justera bildförhållandet

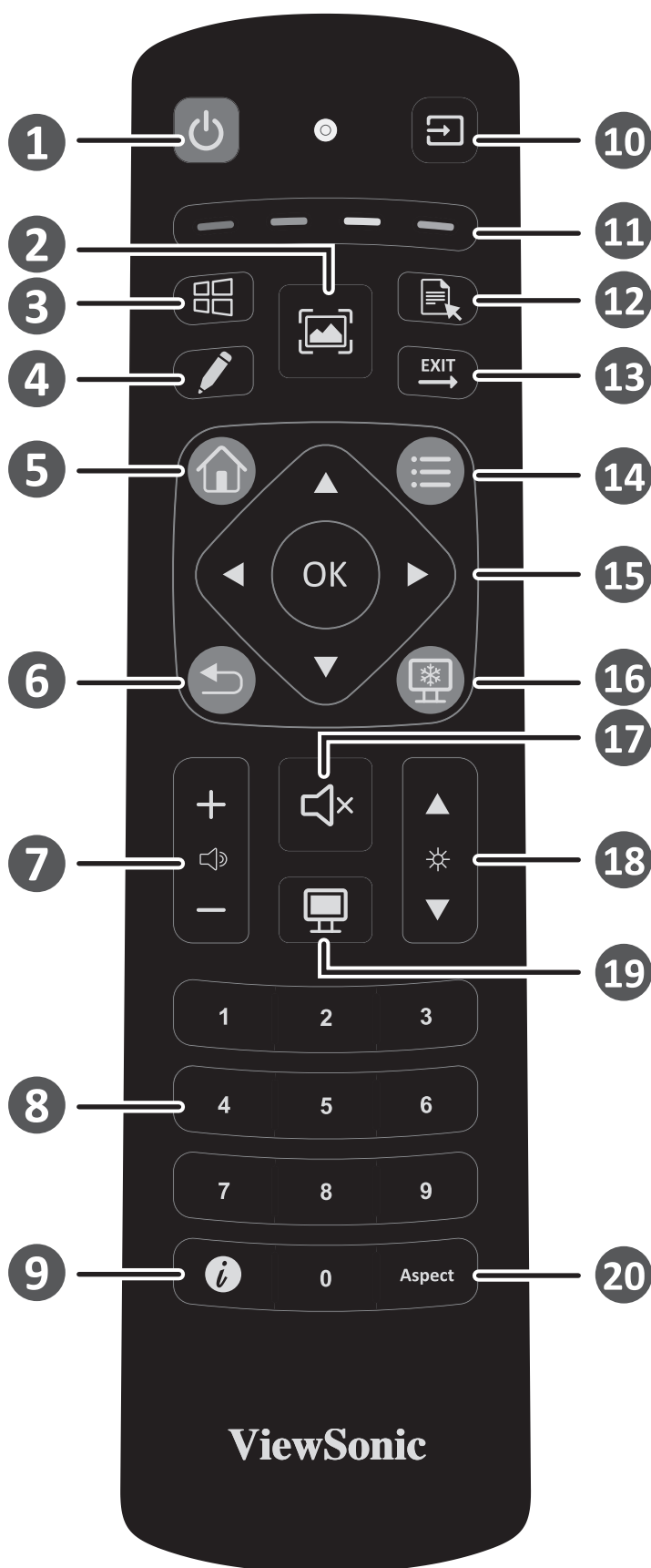

*PC-knapp: Inte alla modeller stöder dessa funktioner

> I/O-port

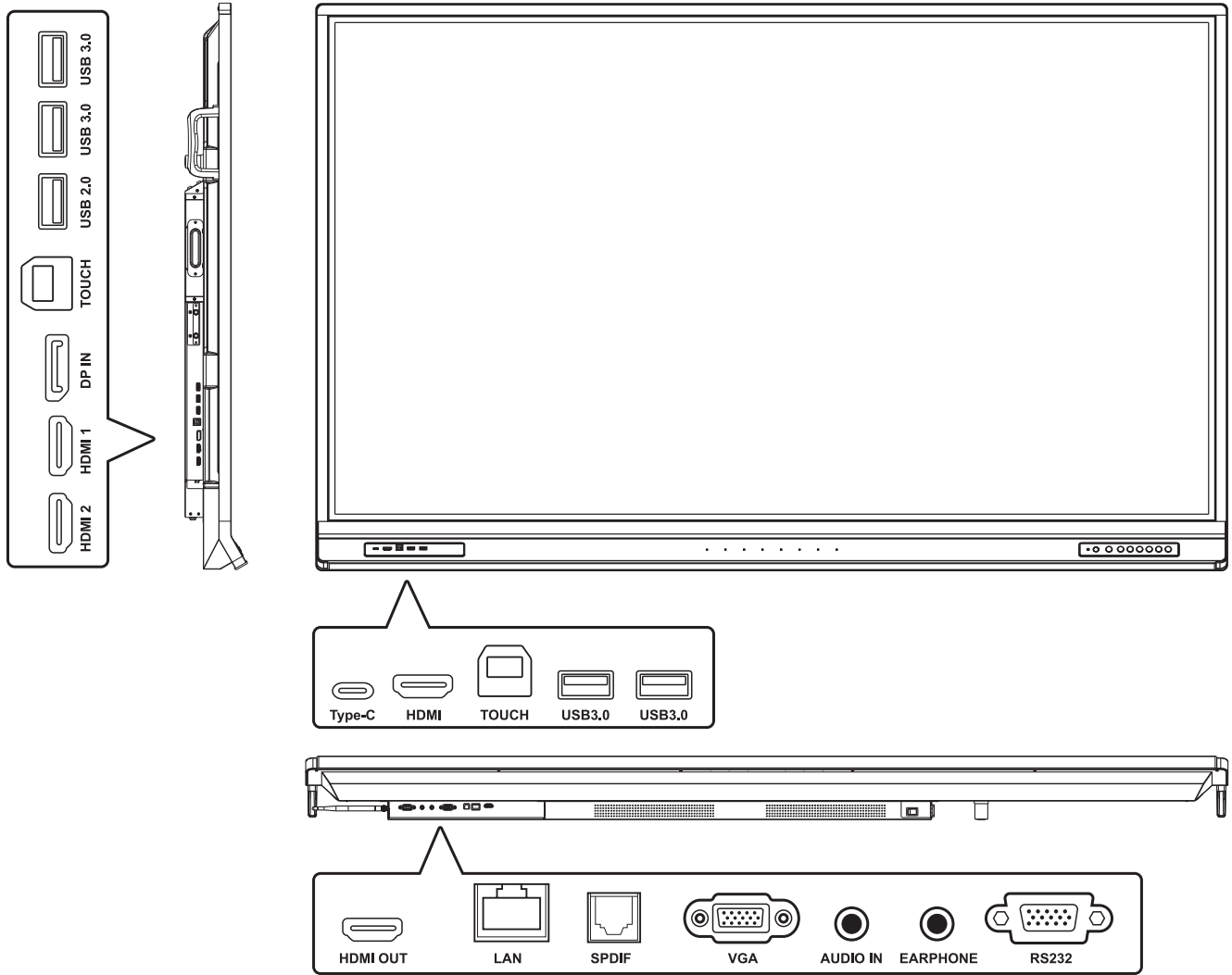

> USB- och nätverksanslutningar

Precis som med alla datorer är det enkelt att ansluta olika USB-enheter och annan kringutrustning till din ViewBoard.

USB-kringutrustning

Anslut USB-enhetens kabel till USB-porten.

Nätverks- och modemkablar

Anslut routerkabeln till LAN-porten.

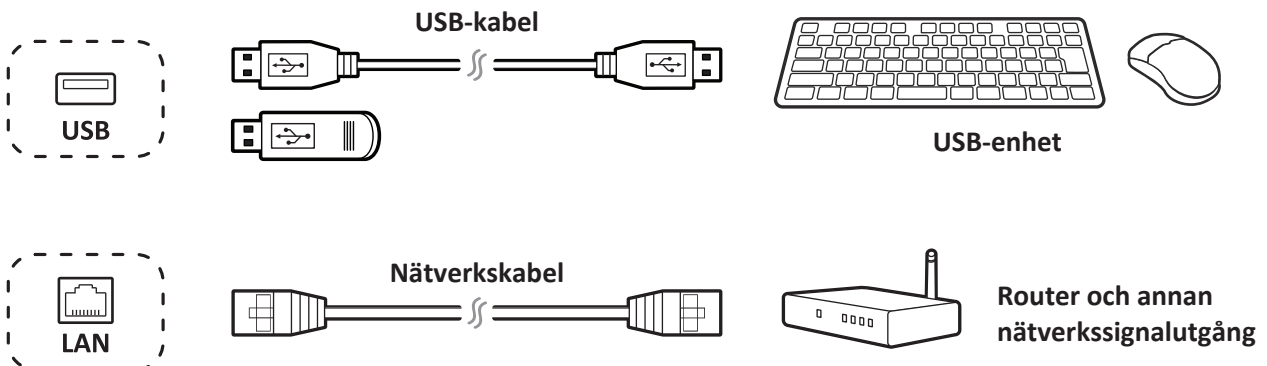

> Ansluta externa enheter och pekanslutning

Dina externa enheter kan anslutas i en av följande konfigurationer:

Typ C-anslutning

Anslut en Typ-C-kabel från din externa enhet till Typ-C-porten på ViewBoard.

DisplayPort-anslutning

1. Anslut en DisplayPort-kabel från din externa enhet till DisplayPort-porten på ViewBoard.
2. Anslut en USB-kabel till den externa enheten från TOUCH-porten på ViewBoard.

HDMI-anslutning

1. Anslut en HDMI-kabel från din externa enhet till HDMI IN-porten på ViewBoard.
2. Anslut en USB-kabel till den externa enheten från TOUCH-porten på ViewBoard.

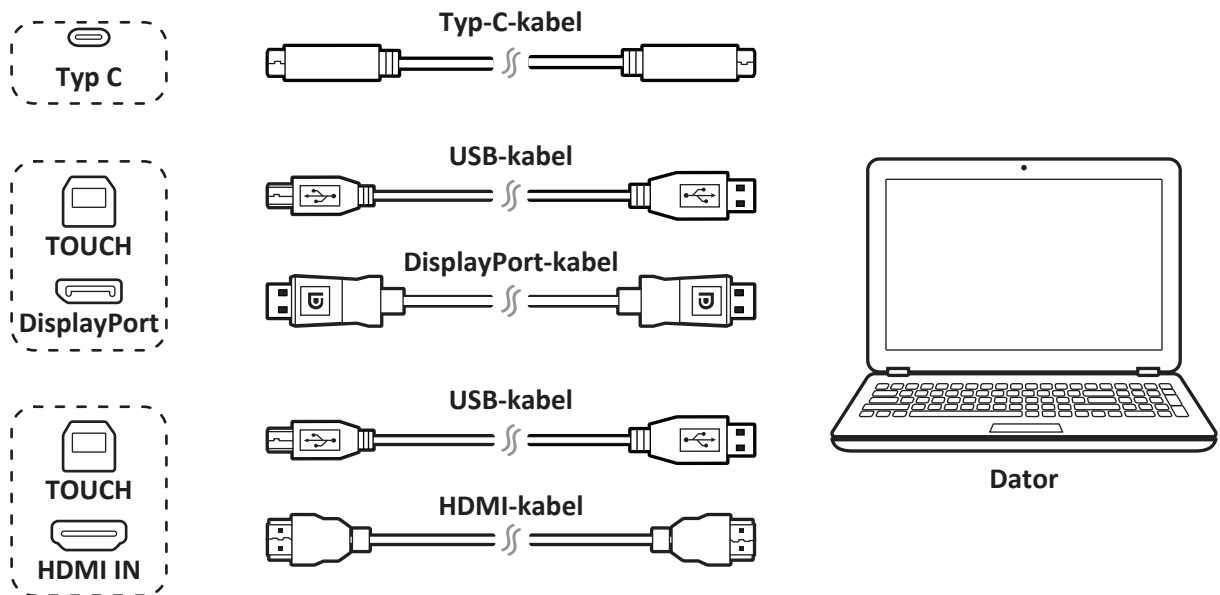

> RS232-anslutningar

När du använder en RS232 seriell port-kabel för att ansluta din skärm till en extern dator kan vissa funktioner styras av datorn, inklusive ström på/av, volymjustering med mera.

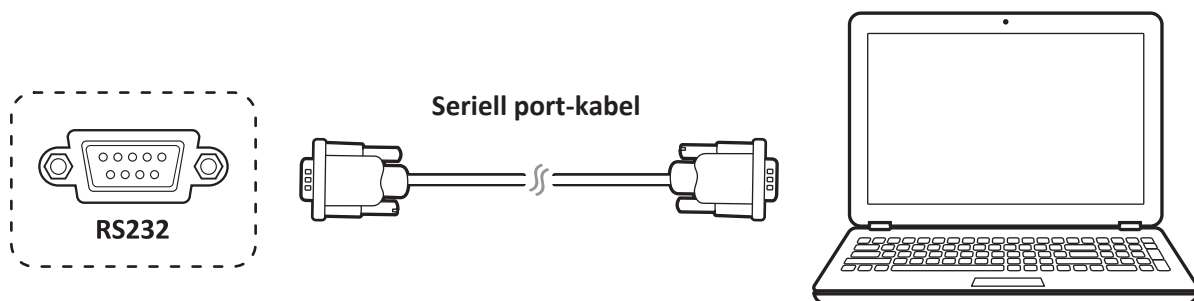

> Anslutning till mediaspelare (ljud och video)

Så här ansluter du till en mediaspelare:

1. Anslut HDMI-kabeln till HDMI-portarna på din ViewBoard och kringutrustning.
2. Anslut nätsladden på din ViewBoard och slå på strömbrytaren på bakpanelen.
3. Tryck på strömbrytaren till höger om ViewBoard för att slå på skärmen.
4. Tryck på ingångsknappen på fjärrkontrollen och växla till "HDMI" som ingångskälla.

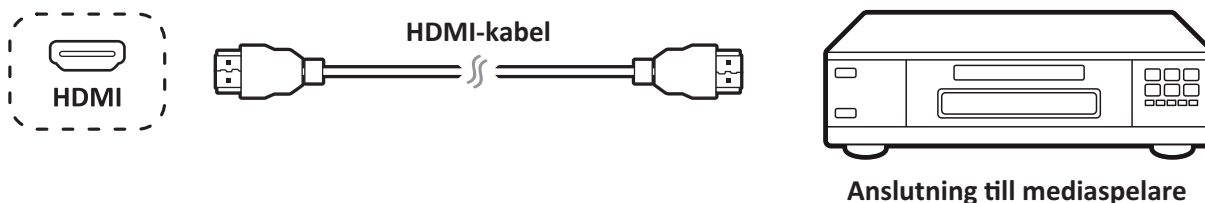

> SPDIF-anlutning

Så här ansluter du till ett externt ljudsystem:

1. Anslut en optisk kabel från SPDIF-porten till ljudsystemets optiska kontakt.
2. Anslut nätsladden på din ViewBoard och slå på strömbrytaren på bakpanelen.
3. Tryck på strömbrytaren till höger om ViewBoard för att slå på skärmen.

Obs! S/PDIF och hörlursutgång fungerar endast på ViewBoard Player, HDMI och DP-kanal..

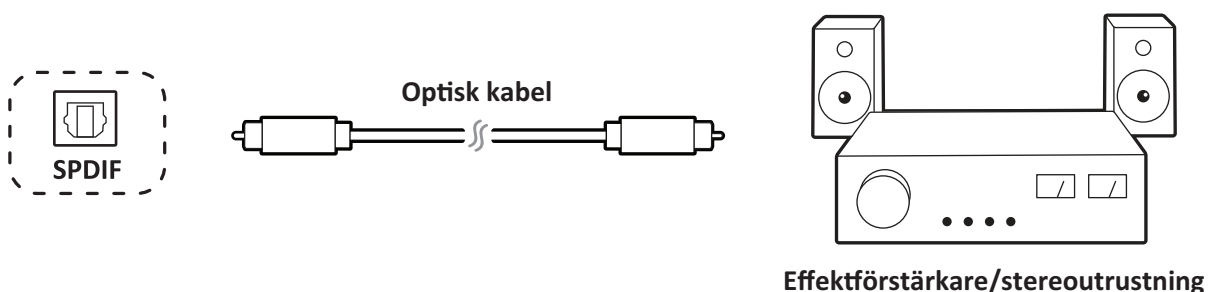

> Videoutgång

För att mata ut video via en skärmenhet:

1. Anslut en HDMI-kabel till HDMI IN-porten på din skärmenhet och den andra änden till HDMI OUT-porten på din ViewBoard.
2. För ljud, anslut ena änden av en ljudkabel till din ViewBoards EARPHONE-port och den andra änden till dina högtalare.
3. Anslut nätsladden på din ViewBoard och slå på strömbrytaren på bakpanelen.
4. Tryck på strömbrytaren till höger om ViewBoard för att slå på skärmen.

Obs! S/PDIF och hörlursutgång fungerar endast på ViewBoard Player, HDMI och DP-kanal.

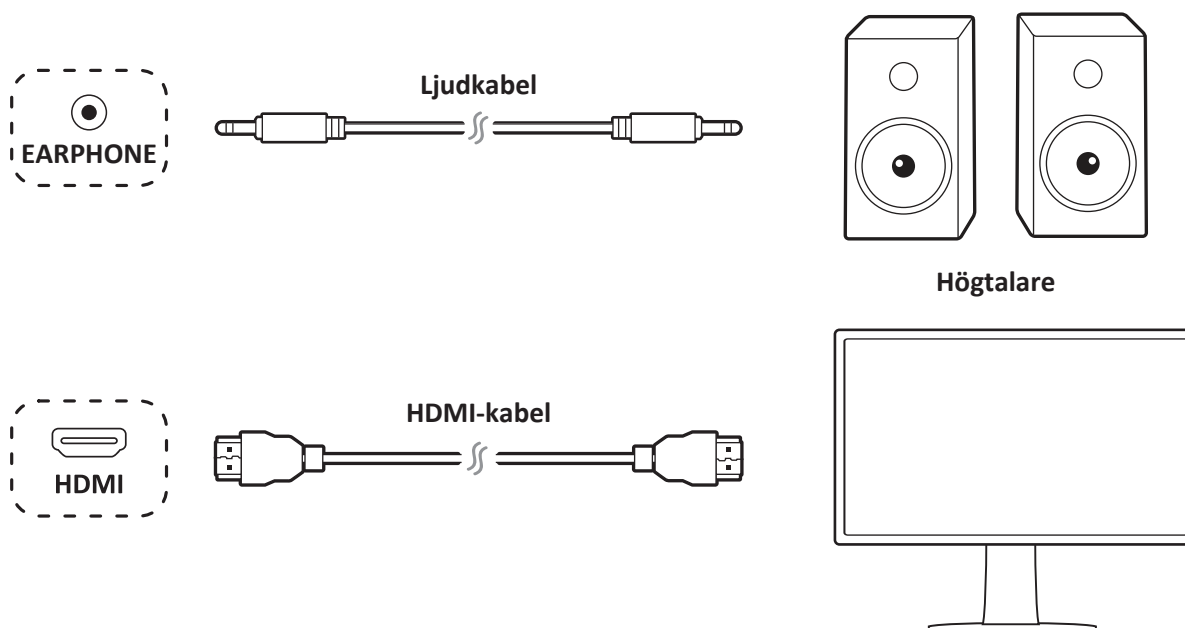

> Börja använda

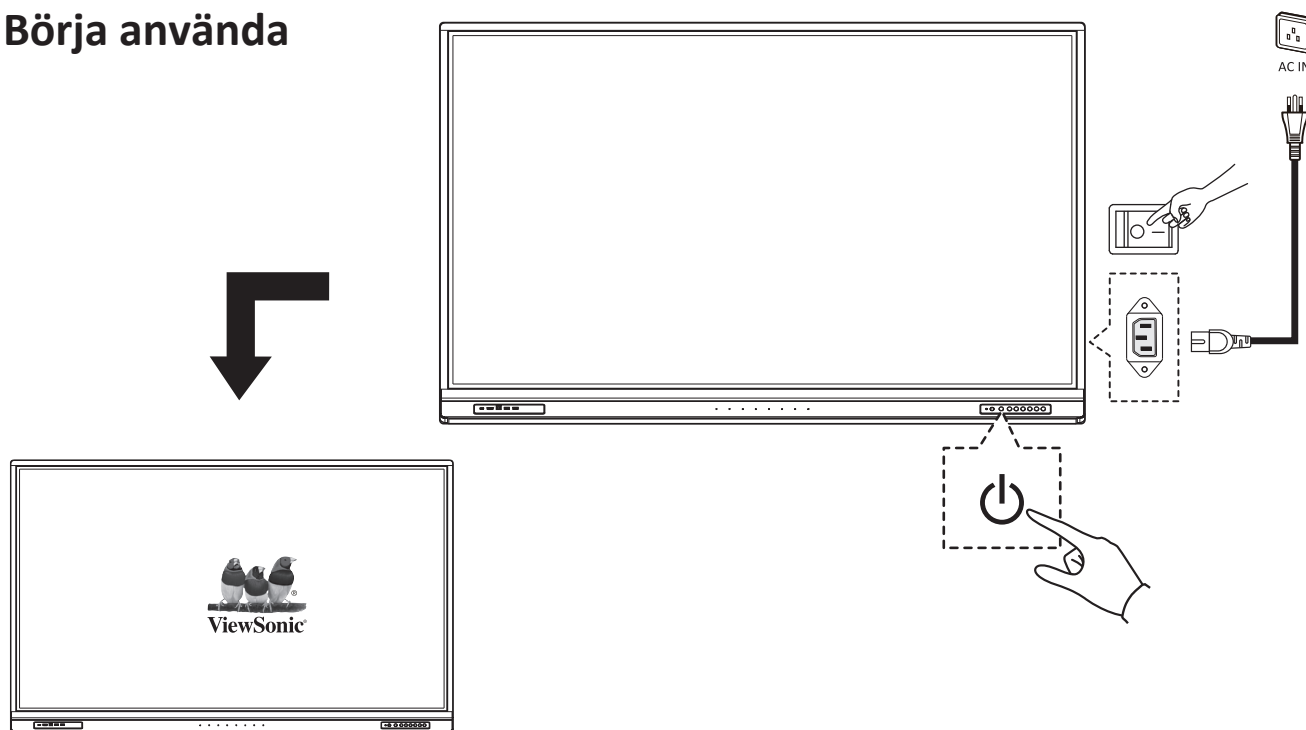



> Förklaring om överensstämmelse

Uttalande gällande FCC-efterlevnad: Denna enhet överensstämmer med avsnitt 15 i FCC-reglerna. Användningen är underställd följande två villkor: (1) Enheten får inte orsaka skadliga störningar och (2) Denna enhet måste acceptera alla mottagna störningar, inklusive störningar som kan orsaka oönskad funktion.

Industry Canada ICES-003-efterlevnad: CAN ICES-3 (B)/NMB-3(B)



ViewSonic Corporation (USA/Kanada/Latinamerika)

 : www.viewsonic.com/support/product-registration



United States

 1-800-688-6688

 customerservice@viewsonic.com

Canada

 1-866-463-4775

 customerservice@viewsonic.com

Puerto Rico och Jungfruöarna

 <http://www.viewsonic.com/la/soporte/servicio-tecnico> (Español)

Latin America

 <http://www.viewsonic.com/la/soporte/servicio-tecnico-la/>



ViewSonic Europe Ltd.

 : www.viewsoniceurope.com

 +44 (0) 207 382 8251



Europe

 <http://www.viewsoniceurope.com/eu/support/call-desk/>



ViewSonic supportcenter



Extra tillbehör

> Paket İçeriği

- HDMI kablosu (10ft/3m)
- Tip-c kablo (5ft/1.5m)
- Dokunma için USB kablosu (10ft/3m)
- Kelepçe x 5
- Web kamerası plakası
- AAA pil x 2
- Dokunmatik kalem x 2
- Uzaktan kumanda
- Silgi
- Webcam vidası x 4 (M4x7mm x2, M3x6mm x2)
- Hızlı başlangıç kılavuzu
- Uygunluk beyanı
- RS232 adaptörü
- Güç kablosu (bölgeye göre gönderilir)
- Duvara montaj vidaları x 4 (M8x20mm x4)

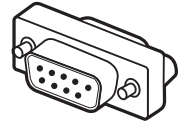
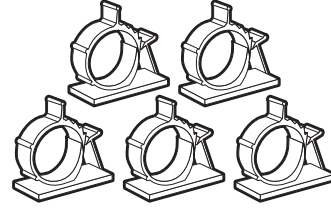
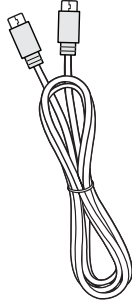
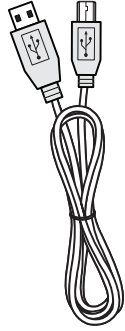
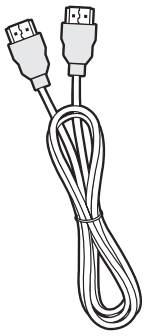
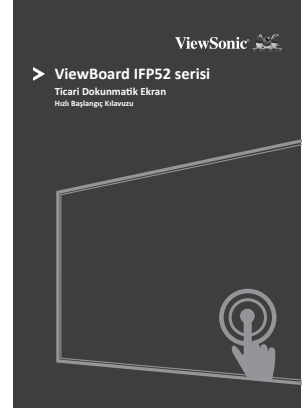
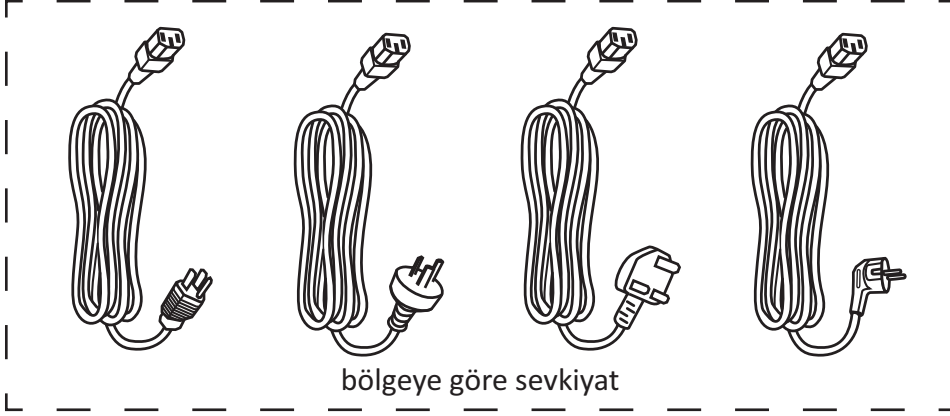

M8 X 4



M3 X 2



M4 X 2

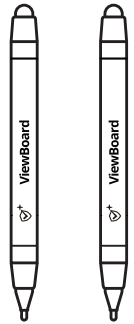
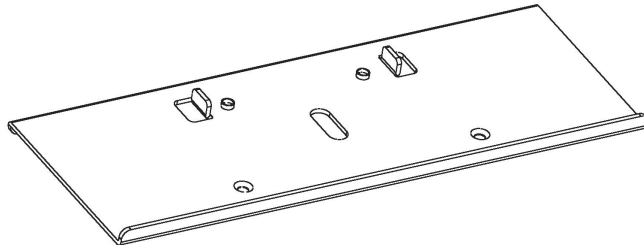
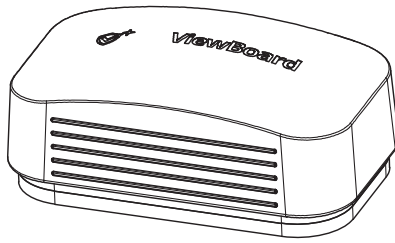

> Kurulum Ortamı Uyarısı

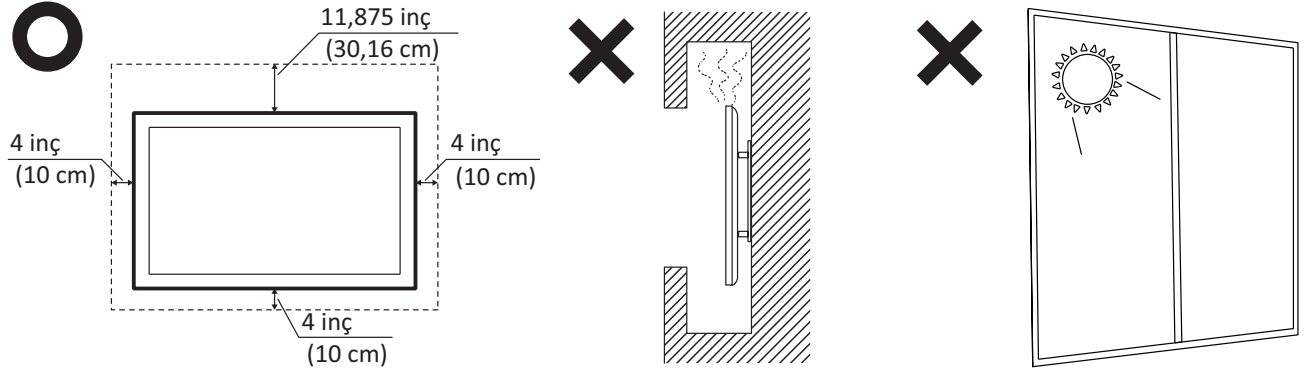

> Kontrol Paneline Genel Bakış

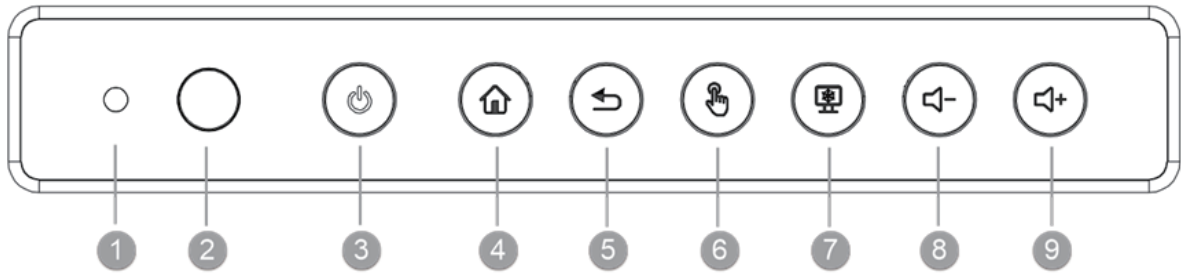

Öge	Açıklama
1	Ortam ışığını izlemek için ortam ışığı sensörü
2	Uzaktan kumanda alıcısı
3	Güç göstergesi ışığı Cihazı açmak için tuşa basın Yalnız ekran arka ışığını açmak/kapatmak için tuşa basın Cihazı kapatmak için tuşu basılı tutun
4	ViewBoard oynatıcı ana arayüzüne dön
5	ViewBoard oynatıcısında önceki seviyeye dön
6	Dokunmatik ekranı devre dışı bırak/etkinleştir
7	Ekrandaki mevcut görüntüyü dondur
8	Sesi Azalt
9	Sesi Artır

> Uzaktan Kumandaya Genel Bakış

- 1 Güç aç/kapat
- 2 Ekran yakalama
- 3 *Bilgisayar: "Windows" düğmesi
- 4 Başlangıç Yazımı
- 5 Gömülü oynatıcı Ana Ekranına dön
- 6 Geri / Önceki sayfaya dön
- 7 Sesi Artır / Azalt
- 8 Sayı Tuş Takımı
- 9 Bilgi
- 10 Giriş kaynağı seçimi
- 11 Medya kontrol düğmesi
Kırmızı: OYNAT / DURAKLAT
Yeşil: DURDUR
Sarı: İLERİ
Mavi: GERİ
- 12 *Bilgisayar: "Menü düğmesi"
- 13 *Bilgisayar: Çıkış iletişim kutusu
- 14 Ayar menüsü
- 15 Yukarı/Aşağı/Sağ/Sol/Tamam Tuşları
- 16 Ekranı dondurun
- 17 Sessiz / Ses Açık
- 18 Parlaklığı Artır/Azalt
*Bilgisayar: Sayfa Yukarı/Sayfa Aşağı
- 19 Karanlık Ekran
- 20 En boy oranını ayarla

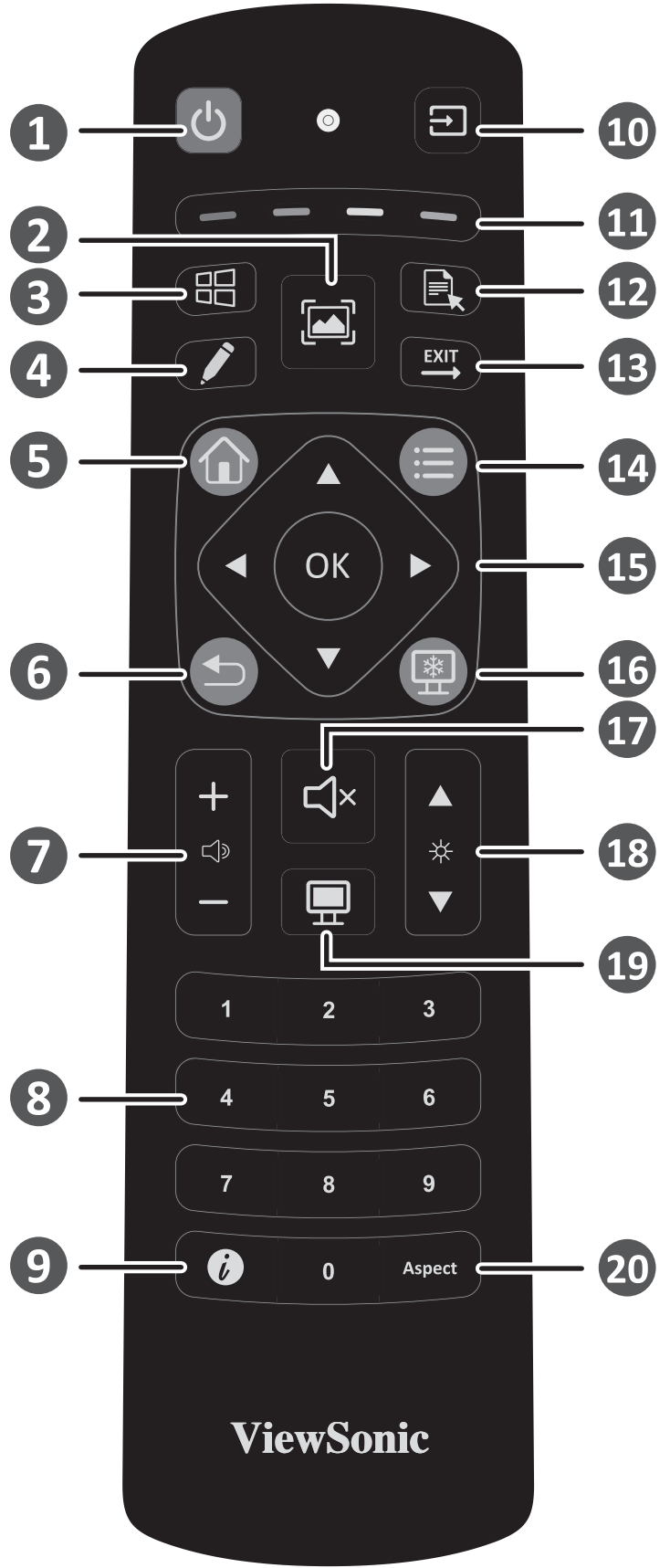

* PC düğmesi: Tüm modeller bu işlevleri desteklemez

> G/Ç bağlantı noktası

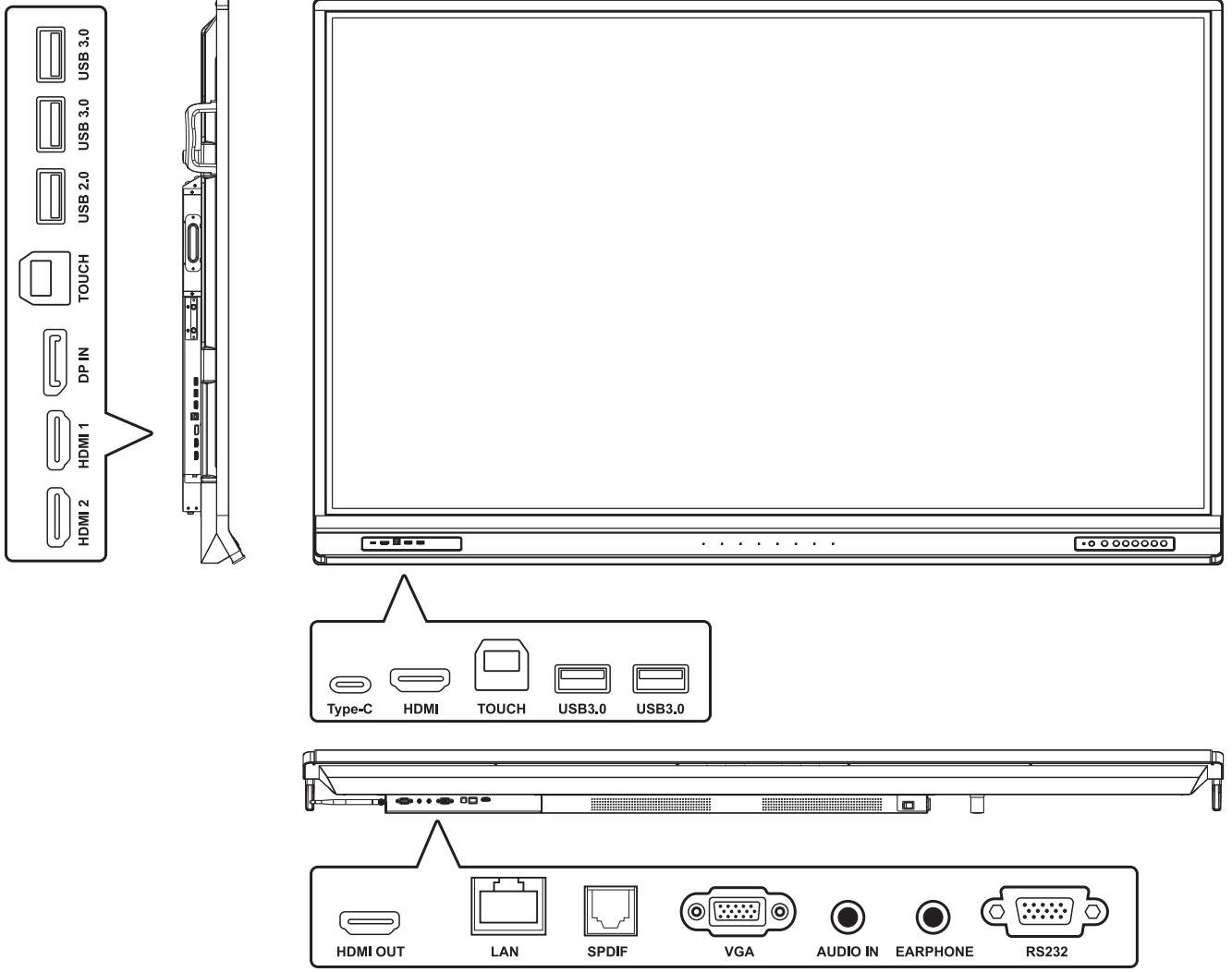

> USB ve Ağ Bağlantıları

Herhangi bir PC'de olduğu gibi, çeşitli USB cihazlarını ve diğer çevre birimlerini ViewBoard'ınıza bağlamak kolaydır.

USB Çevre Birimleri

USB aygıtı kablosunu USB bağlantı noktasına takın.

Ağ ve modem kabloları

Yönlendirici kablosunu LAN bağlantı noktasına takın.

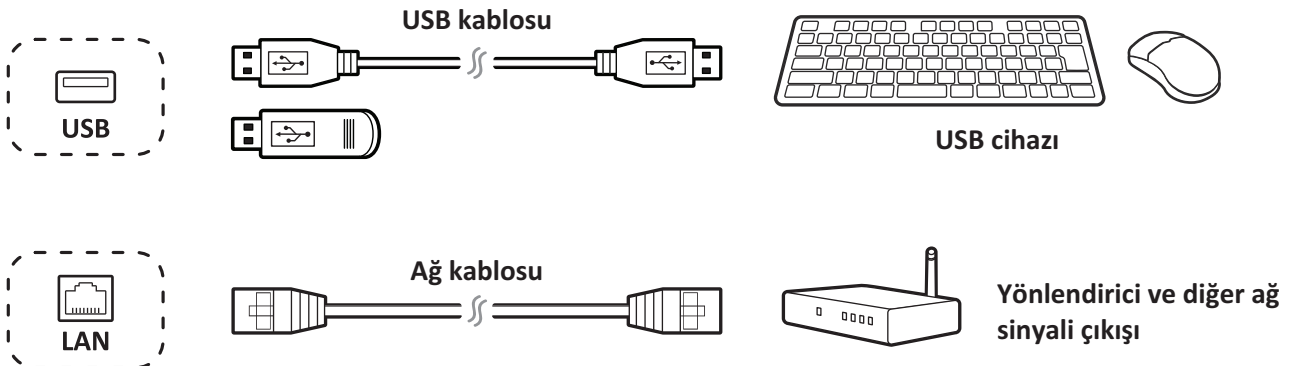

> Harici Aygıtları Bağlama ve Dokunmatik Bağlantı

Harici aygıtlarınız aşağıdaki yapılandırmalardan birinde bağlanabilir:

Tip C Bağlantı

Harici cihazınızdaki bir Tip-C kabloyu ViewBoard'daki Tip-C bağlantı noktasına bağlayın.

DisplayPort Bağlantısı

1. Harici cihazınızdaki bir DisplayPort kablosunu ViewBoard'daki DisplayPort bağlantı noktasına bağlayın.
2. ViewBoard'un TOUCH bağlantı noktasından harici cihaza bir USB kablosu bağlayın.

HDMI Bağlantısı

1. Harici cihazınızdaki bir HDMI kablosunu ViewBoard'daki HDMI In bağlantı noktasına bağlayın.
2. ViewBoard'un TOUCH bağlantı noktasından harici cihaza bir USB kablosu bağlayın.

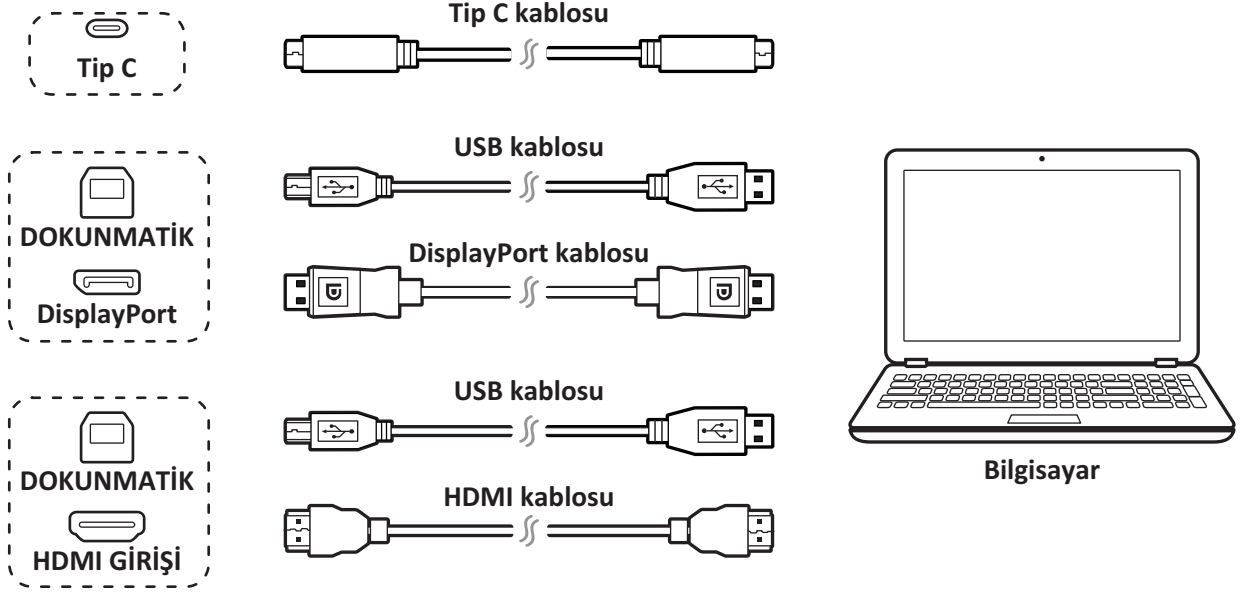

> RS232 Bağlantıları

Ekranınızı harici bir bilgisayara bağlamak için bir RS232 seri bağlantı noktası kablosu kullanırken, güç açma/kapatma, ses uyarı vb. dahil bazı işlevler PC ile kontrol edilebilir.

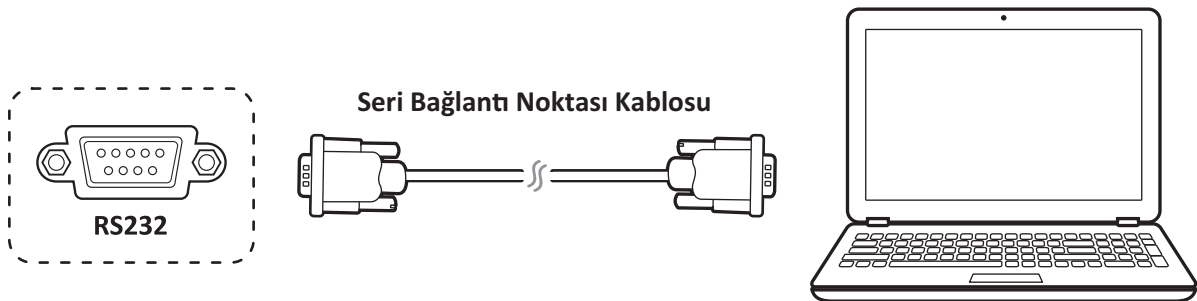

> Media Player (Ses ve Video) Bağlantısı

Bir ortam oynatıcıya bağlanmak için:

1. HDMI kablosunu ViewBoard'unuzdaki ve çevre birimi cihazınızdaki HDMI bağlantı noktalarına bağlayın.
2. ViewBoard'ınızın güç kablosunu takın ve arka panel güç kaynağı anahtarını açın.
3. Ekranı açmak için ViewBoard'un sağ tarafındaki Güç düğmesine basın.
4. Uzaktan kumanda üzerindeki INPUT (Giriş) düğmesine basın ve "HDMI" giriş kaynağına geçin.

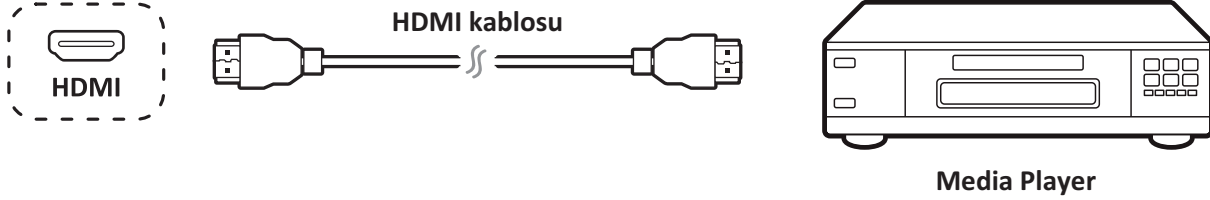

> SPDIF Bağlantısı

Harici bir ses sistemine bağlanmak için:

1. SPDIF bağlantı noktasından ses sisteminizin optik konnektörüne bir optik kablo bağlayın.
2. ViewBoard'ınızın güç kablosunu takın ve arka panel güç kaynağı anahtarını açın.
3. Ekranı açmak için ViewBoard'un sağ tarafındaki Güç düğmesine basın.

Not: S/PDIF ve Kulaklık ses çıkışı yalnızca ViewBoard Oynatıcı, HDMI ve DP kanalında çalışır.

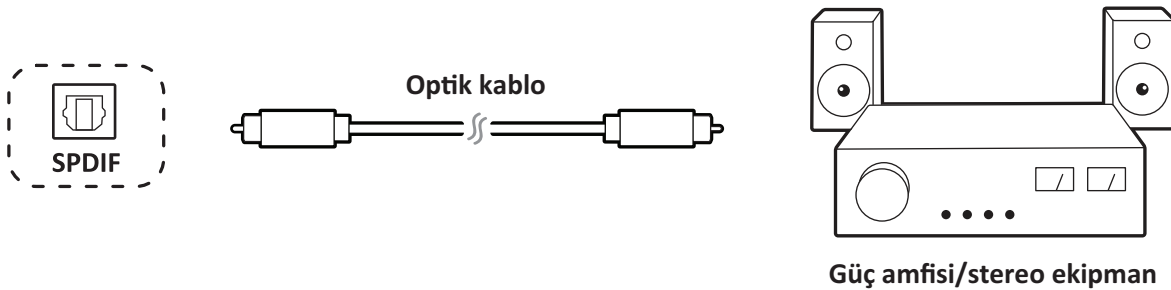

> Video Çıkışı Bağlantısı

Bir görüntüleme cihazı üzerinden video çıkışı yapmak için:

1. HDMI kablosunun bir ucunu görüntü cihazınızın HDMI IN (HDMI GİRİŞİ) bağlantı noktasına ve diğer ucunu ViewBoard'unuzun HDMI OUT (HDMI ÇIKIŞI) bağlantı noktasına takın.
2. Ses için, bir ses kablosunun bir ucunu ViewBoard'unuzun EARPHONE bağlantı noktasına ve diğer ucunu hoparlörlerinize bağlayın.
3. ViewBoard'ınızın güç kablosunu takın ve arka panel güç kaynağı anahtarını açın.
4. Ekranı açmak için ViewBoard'un sağ tarafındaki Güç düğmesine basın.

Not: S/PDIF ve Kulaklık ses çıkışı yalnızca ViewBoard Oynatıcı, HDMI ve DP kanalında çalışır.

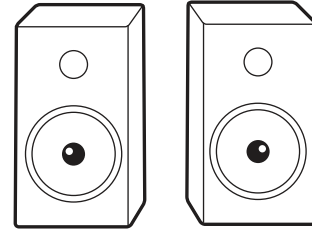
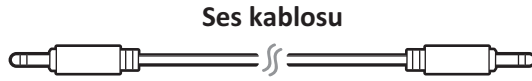

Hoparlörler

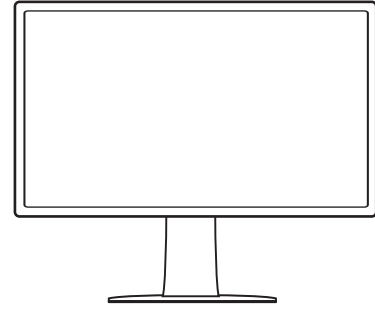
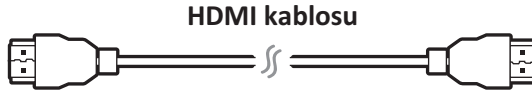

> Kullanıma Başla

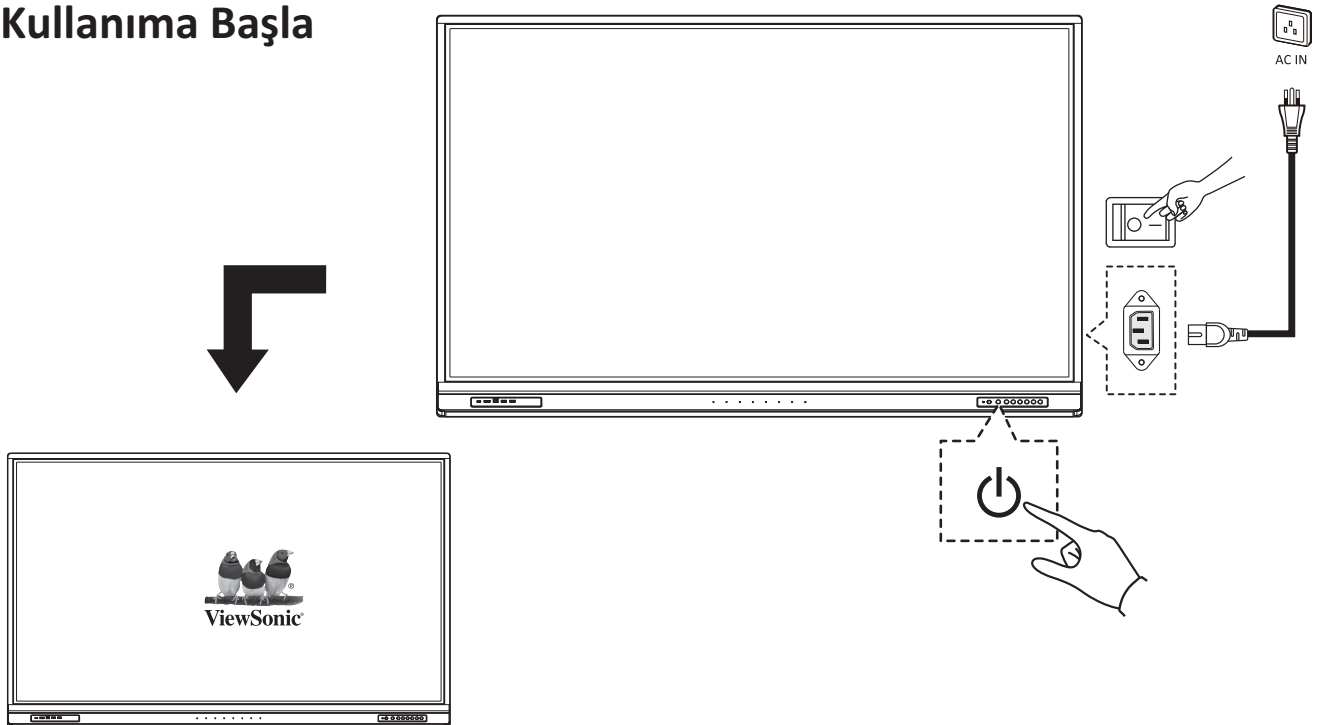



> Uyumluluk Bilgileri

FCC Uyumluluk Bildirimi: Bu aygıt, FCC Kuralları kısım 15'e uygundur. Kullanım aşağıdaki iki koşula bağlıdır: (1) Bu aygıt zararlı girişime neden olamaz ve (2) bu aygıt istenmeyen çalışmaya neden olabilen girişim dahil olmak üzere alınan her türlü girişimi kabul etmelidir.

Industry Canada ICES-003 Uyumu: CAN ICES-3 (B)/NMB-3(B)



ViewSonic Corporation (US/Kanada/Latin Amerika)

 : www.viewsonic.com/support/product-registration



Amerika Birleşik Devletleri

 1-800-688-6688

 customerservice@viewsonic.com

Kanada

 1-866-463-4775

 customerservice@viewsonic.com

Porto Riko & Virgin Islands

 <http://www.viewsonic.com/la/soporte/servicio-tecnico> (Español)

Latin Amerika

 <http://www.viewsonic.com/la/soporte/servicio-tecnico-la/>



ViewSonic Destek Merkezi



İsteğe Bağlı Aksesuar

> สิ่งต่างๆ ในกล่องบรรจุ

- สายเคเบิล HDMI (10ft/3m)
- สาย USB แบบ C (5ft/1.5m)
- สาย USB สำหรับ Touch (10ft/3m)
- ที่หนีบ x 5
- ฐานเว็บแคม
- แบตเตอรี่ AAA x 2

- ทัชเพน x 2
- รีโมทคอนโทรล
- ยางลบ
- สกรูเว็บแคม x 4 (M4x7mm x2, M3x6mm x2)
- คู่มือเริ่มต้นด่วน
- คำแถลงเรื่องการปฏิบัติตามข้อ

- กำหนด
- อะแดปเตอร์ RS232
 - สายไฟ (จัดส่งตามภูมิภาค)
 - สกรูยึดผนัง x 4 (M8x20mm x4)

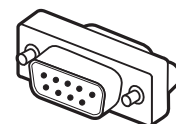
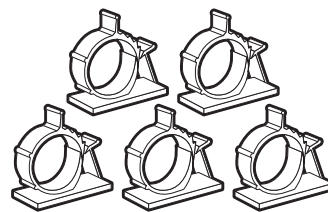
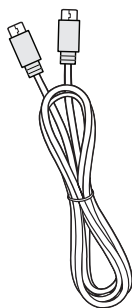
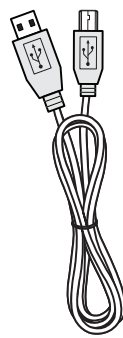
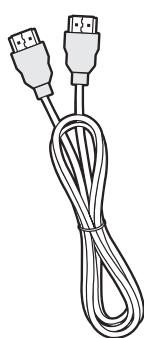
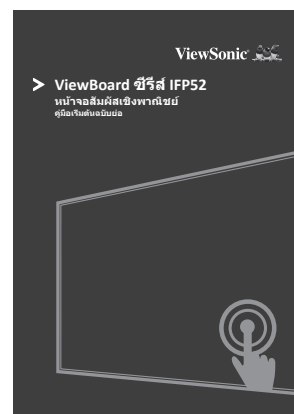
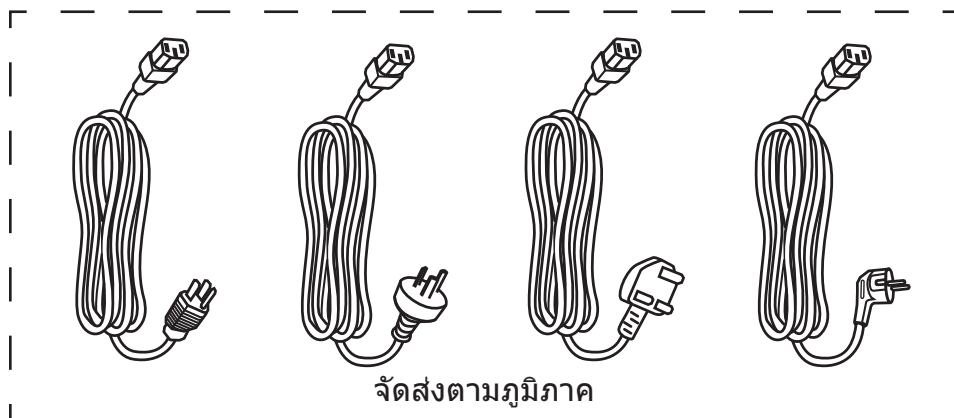

M8 X 4



M3 X 2



M4 X 2

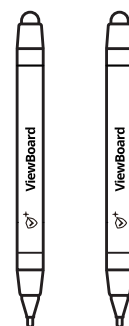
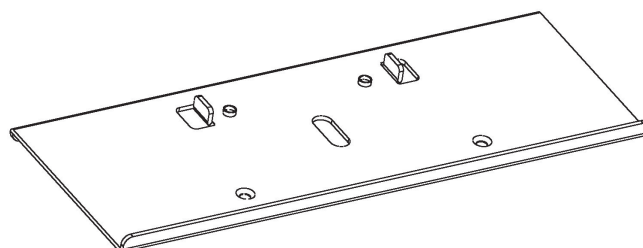
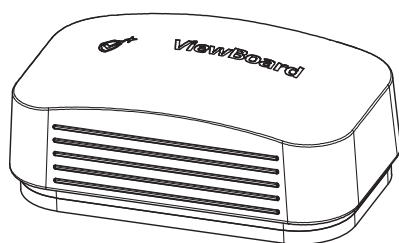

> ข้อมูลจำเพาะชุดยึดผนัง (แยกจำหน่าย)

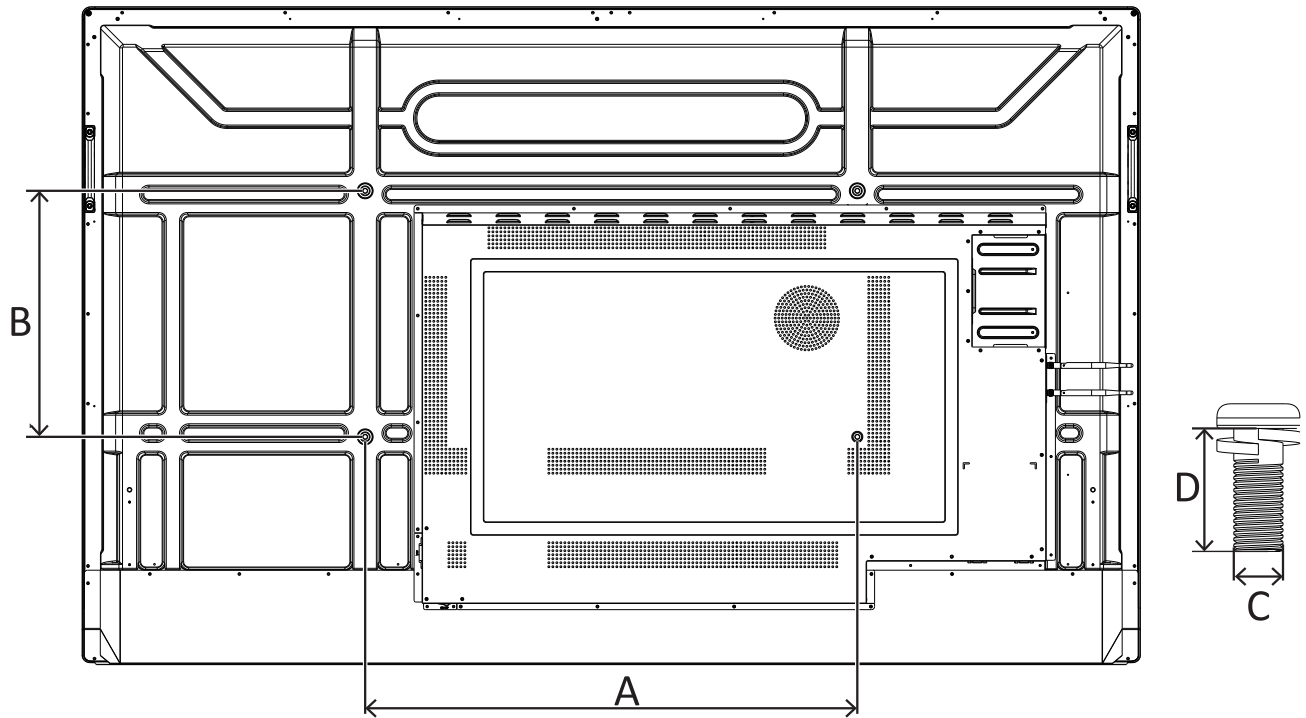

นิว	ข้อมูลจำเพาะ VESA (A x B)	สกรูมาตรฐาน (C x D)	จำนวน
ซีรีส์ IFP6552	600 x 400 มม.	M8 x 20 มม.	4
ซีรีส์ IFP7552	800 x 400 มม.	M8 x 20 มม.	4
ซีรีส์ IFP8652	800 x 600 มม.	M8 x 20 มม.	4

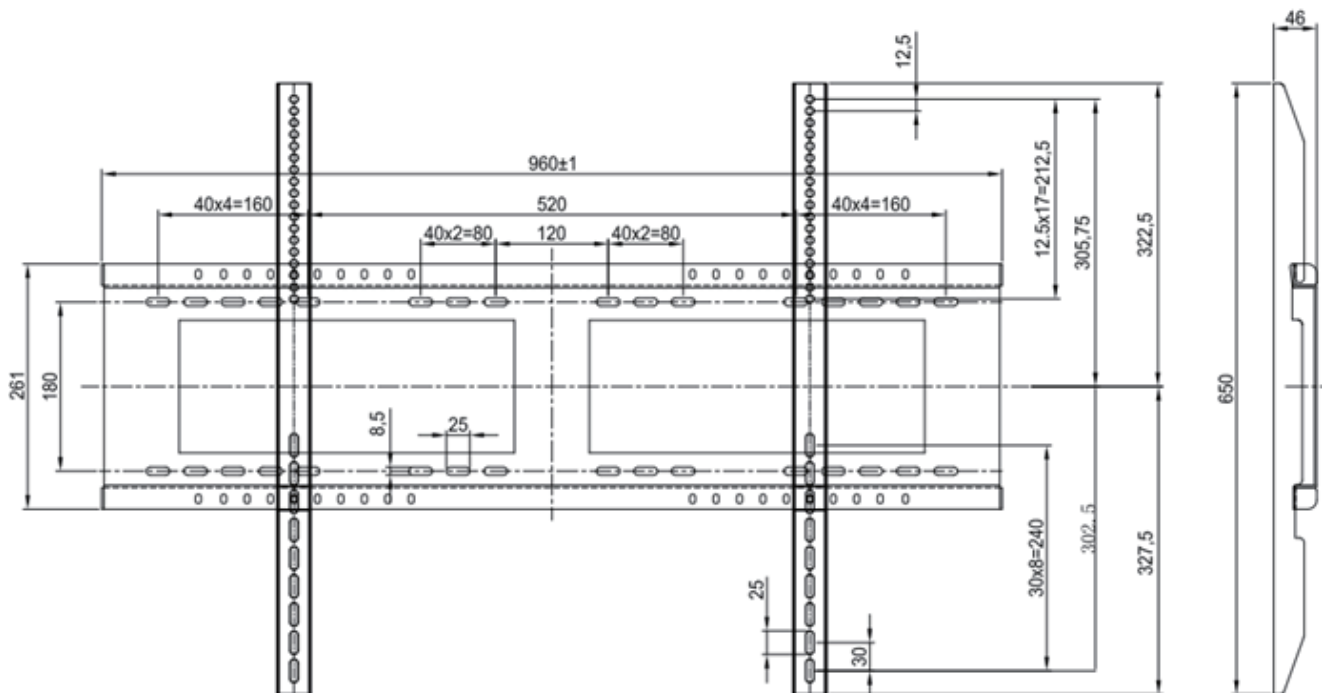

> ข้อควรระวังเรื่องสภาพแวดล้อมการติดตั้ง

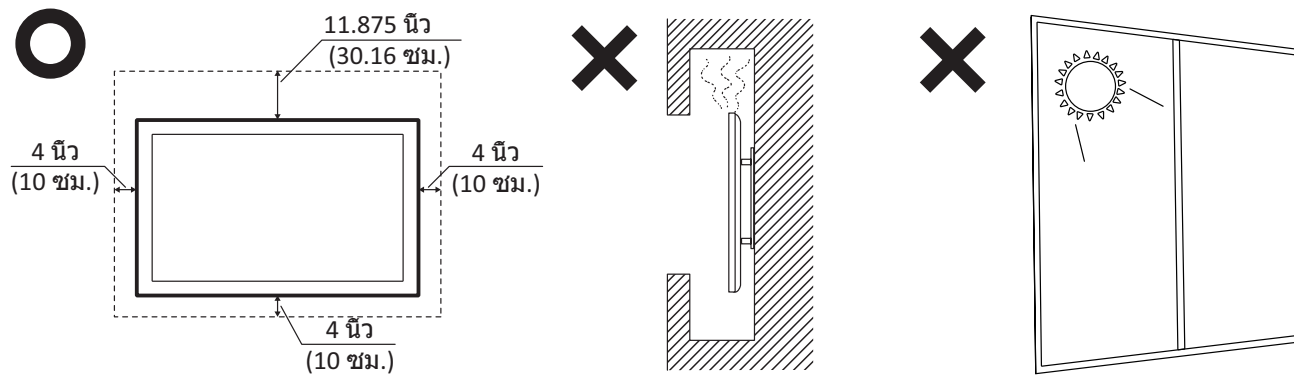

> ภาพรวมแผงควบคุม

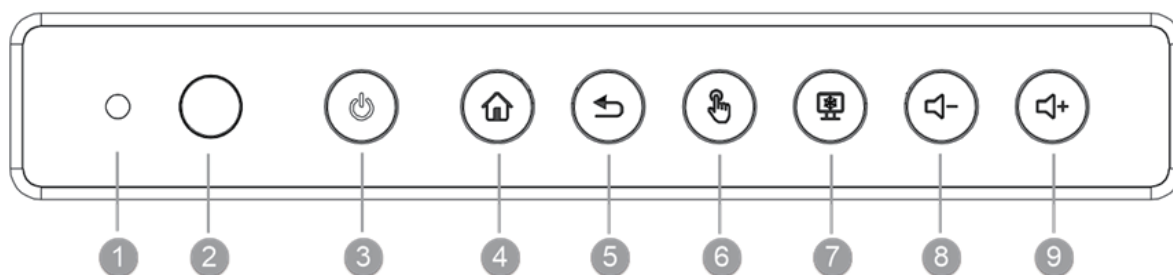

รายการ	คำอธิบาย
1	เซนเซอร์แสงแวดล้อมสำหรับการตรวจสอบสภาพแสงโดยรอบ
2	ตัวรับรีโมทคอนโทรล
3	ไฟแสดงสถานะการทำงาน กดปุ่มเพื่อเปิดเครื่อง กดปุ่มเพื่อปิด/เปิดไฟพื้นหลังของจอแสดงผลเท่านั้น กดปุ่มค้างเพื่อปิดเครื่อง
4	กลับไปทีอินเทอร์เฟซหลักของเครื่องเล่น ViewBoard
5	กลับไปทีเครื่องเล่น ViewBoard ระดับก่อนหน้า
6	ปิด/เปิดการใช้งานหน้าจอสัมผัส
7	หยุดภาพปัจจุบันบนหน้าจอ
8	ลดระดับเสียง
9	เพิ่มระดับเสียง

> การใช้งานรีโมทคอนโทรล

- 1 เปิด/ปิดเครื่อง
- 2 จับภาพหน้าจอ
- 3 *เครื่องพีซี: ปุ่ม “Windows”
- 4 การเขียนเพื่อเปิดเครื่อง
- 5 กลับไปที่หน้าจอโฮมของเครื่องเล่นภายในเครื่อง
- 6 กลับ/ย้อนไปที่หน้าก่อนหน้า
- 7 ปุ่มเพิ่ม / ลด
- 8 แป้นตัวเลข
- 9 ข้อมูล
- 10 การเลือกแหล่งสัญญาณเข้า
- 11 ปุ่มควบคุมสี
สีแดง: เล่น/หยุด
สีเขียว: หยุด
สีเหลือง: เดินหน้า
สีฟ้า: ถอยหลัง
- 12 *เครื่องพีซี: ปุ่ม “Menu”
- 13 *เครื่องพีซี: กล้องตัดจบการออก
- 14 เมนู การตั้งค่า
- 15 ปุ่มขึ้น/ลง/ขวา/ซ้าย/OK
- 16 หยุดหน้าจอ
- 17 ปิดเสียง / เลิกปิดเสียง
- 18 เพิ่ม / ลดความสว่าง
*เครื่องพีซี: Page Up / Page Down
- 19 หน้าจอว่าง
- 20 ปรับอัตราส่วนภาพ



*ปุ่มเครื่องพีซี: บางรุ่นอาจไม่รองรับฟังก์ชันนี้

> พอร์ต I/O

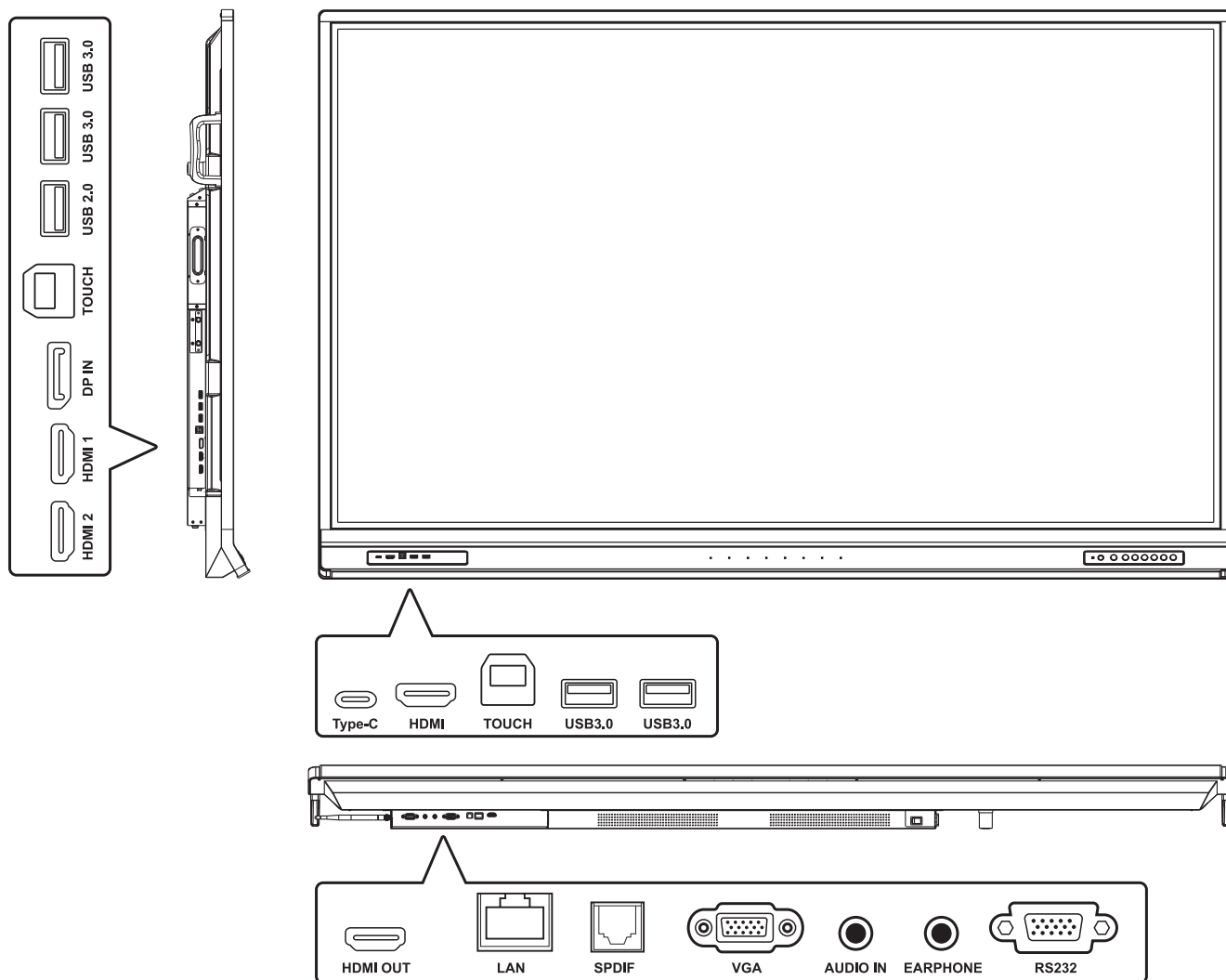

> การเชื่อมต่อ USB และระบบเครือข่าย

เหมือนกับ PC ทั่วไป การเชื่อมต่ออุปกรณ์ USB และอุปกรณ์ต่อพ่วงอื่น ๆ ไปยัง ViewBoard นั้นทำได้ง่าย

อุปกรณ์ต่อพ่วง USB

เสียบสายของอุปกรณ์ USB เข้าที่พอร์ต USB

สายเคเบิลเครือข่าย และโมเด็ม

เสียบสายเราเตอร์เข้าที่พอร์ต LAN

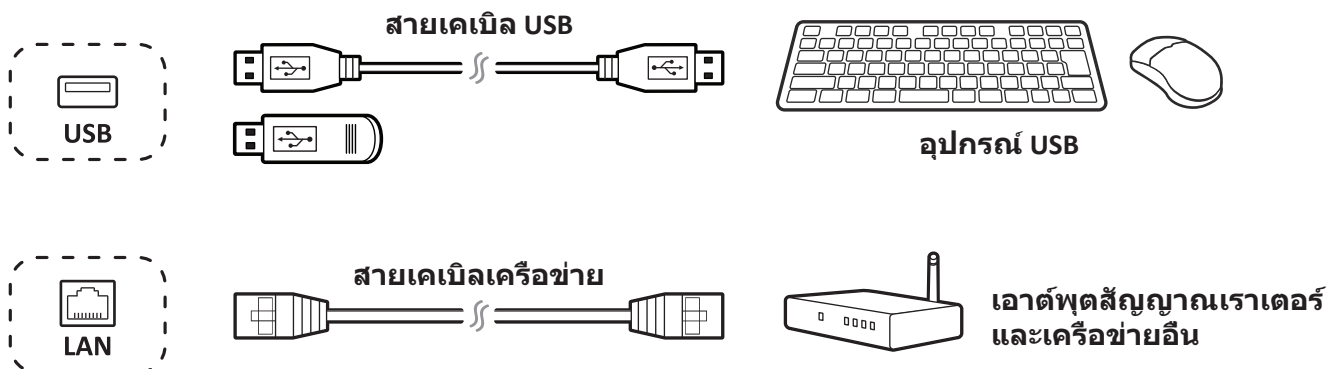

> การเชื่อมต่ออุปกรณ์ภายนอก และการเชื่อมต่อระบบสัมผัส

คุณสามารถเชื่อมต่ออุปกรณ์ภายนอกได้ในการกำหนดค่าต่อไปนี้:

การเชื่อมต่อ USB-C

เชื่อมต่อสายประเภท C จากอุปกรณ์ภายนอกของคุณเข้ากับพอร์ตประเภท C บน ViewBoard

การเชื่อมต่อ DisplayPort

1. เชื่อมต่อสาย DisplayPort จากอุปกรณ์ภายนอกของคุณเข้ากับพอร์ต DisplayPort บน ViewBoard
2. เชื่อมต่อสาย USB จากพอร์ต TOUCH ของ ViewBoard ไปที่อุปกรณ์ภายนอก

การเชื่อมต่อ HDMI

1. เชื่อมต่อสาย HDMI จากอุปกรณ์ภายนอกของคุณเข้ากับพอร์ต HDMI ขาเข้าบน ViewBoard
2. เชื่อมต่อสาย USB จากพอร์ต TOUCH ของ ViewBoard ไปที่อุปกรณ์ภายนอก

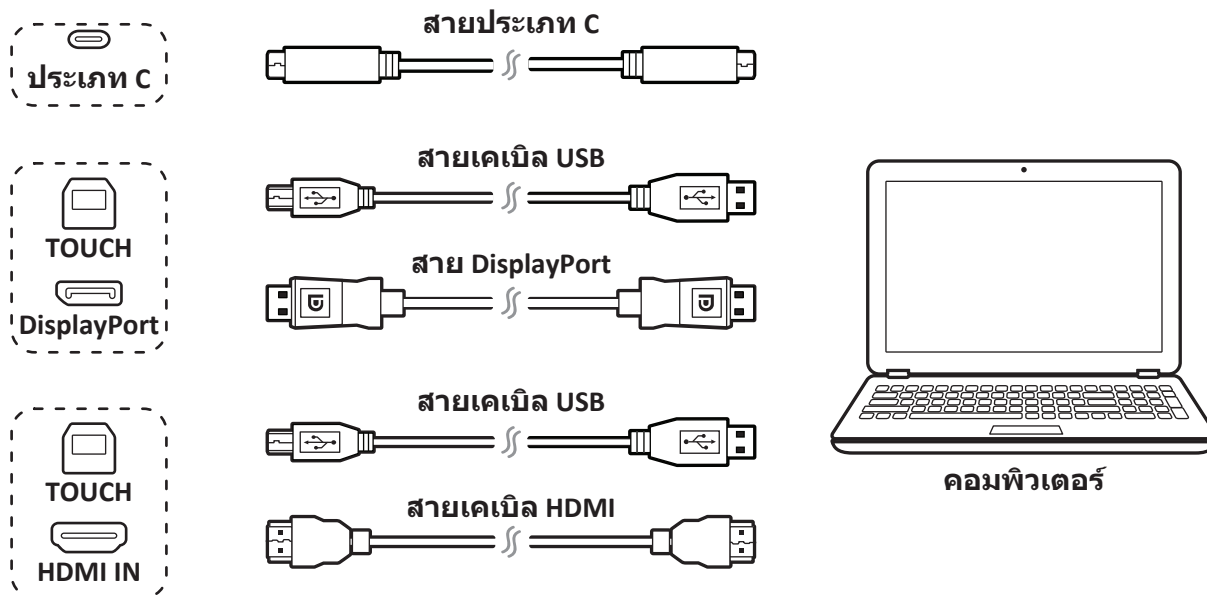

> การเชื่อมต่อ RS232

เมื่อคุณใช้สายพอร์ตซีเรียล RS232 เพื่อเชื่อมต่อจอแสดงผลไปที่คอมพิวเตอร์ภายนอก คุณสามารถควบคุมบางฟังก์ชันผ่านทาง PC ได้ ประกอบด้วย การเปิด/ปิดเครื่อง, การปรับระดับเสียง และอื่น ๆ

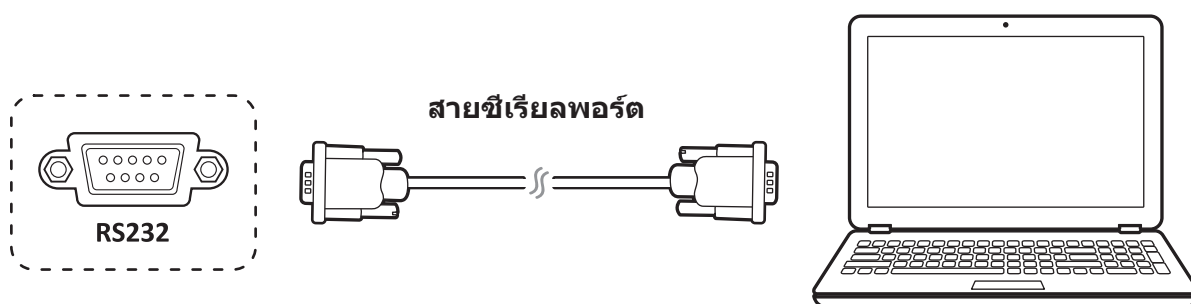

> การเชื่อมต่อเครื่องเล่นสื่อ (เสียงและภาพ)

ในการเชื่อมต่อไปยังมีเดียเพลเยอร์:

1. เชื่อมต่อสาย HDMI เข้าที่พอร์ต HDMI บน ViewBoard และอุปกรณ์ต่อพ่วงของคุณ
2. เสียบสายไฟของ ViewBoard และเปิดสวิตช์เปิดปิดที่แผงด้านหลัง
3. กดปุ่มเปิดปิดเครื่องที่ด้านขวามือของ ViewBoard เพื่อเปิดหน้าจอ
4. กดปุ่ม INPUT บนรีโมทคอนโทรล และเปลี่ยนไปใช้แหล่งสัญญาณเข้า "HDMI"

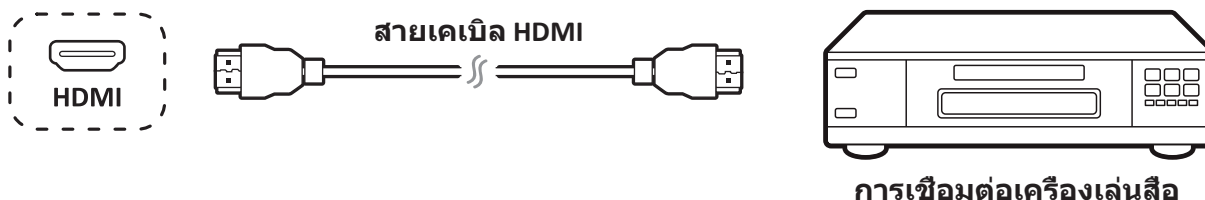

> การเชื่อมต่อ SPDIF

ในการเชื่อมต่อไปยังระบบเสียงภายนอก:

1. เชื่อมต่อสายออปติคัลจากพอร์ต SPDIF เข้าที่ขั้วต่อออปติคัลของระบบเสียงของคุณ
2. เสียบสายไฟของ ViewBoard และเปิดสวิตช์เปิดปิดที่แผงด้านหลัง
3. กดปุ่มเปิดปิดเครื่องที่ด้านขวามือของ ViewBoard เพื่อเปิดหน้าจอ

หมายเหตุ: แอต์พุตเสียง S/PDIF และหูฟังสามารถใช้งานได้เฉพาะกับช่องสัญญาณเครื่องเล่นในตัวเครื่อง, HDMI และ DP เท่านั้น

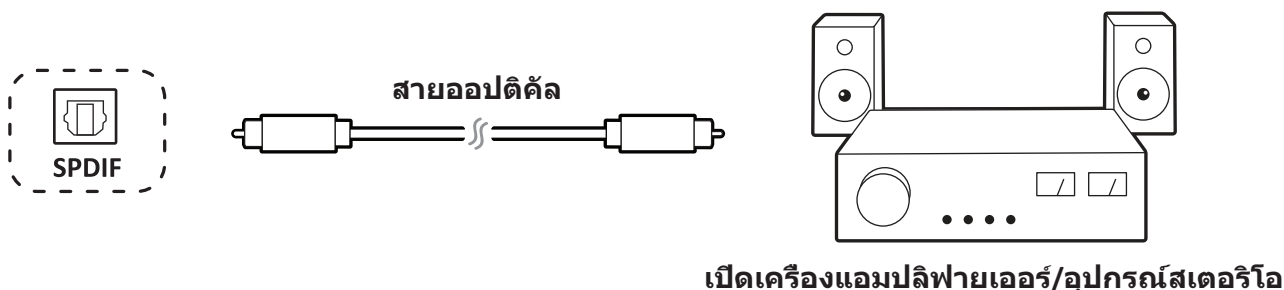

> การเชื่อมต่อเอาต์พุตวิดีโอ

ในการส่งสัญญาณวิดีโอออกผ่านอุปกรณ์แสดงผล:

1. เชื่อมต่อปลายด้านหนึ่งของสาย HDMI เข้าที่พอร์ต HDMI IN ของอุปกรณ์แสดงผลของคุณ และปลายอีกด้านหนึ่งเข้าที่พอร์ต HDMI OUT ของ ViewBoard
2. สำหรับสัญญาณเสียง เชื่อมต่อปลายสายด้านหนึ่งเข้าที่พอร์ต EARPHONE ของ ViewBoard และปลายอีกด้านหนึ่งเข้าที่ลำโพงของคุณ
3. เสียบสายไฟของ ViewBoard และเปิดสวิตช์เปิดปิดที่แผงด้านหลัง
4. กดปุ่มเปิดปิดเครื่องที่ด้านขวามือของ ViewBoard เพื่อเปิดหน้าจอ

หมายเหตุ: เอาต์พุตเสียง S/PDIF และหูฟังสามารถใช้งานได้เฉพาะกับช่องสัญญาณเครื่องเล่น ViewBoard, HDMI และ DP เท่านั้น

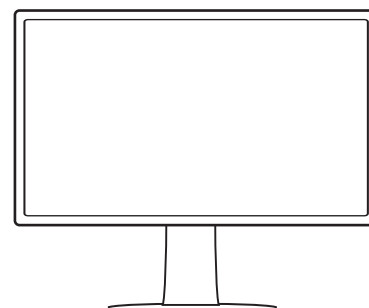
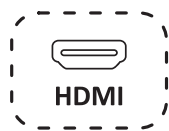
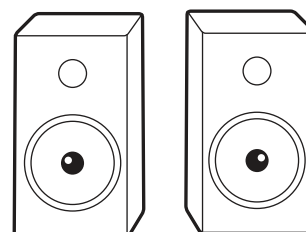

> เริ่มต้นใช้งาน

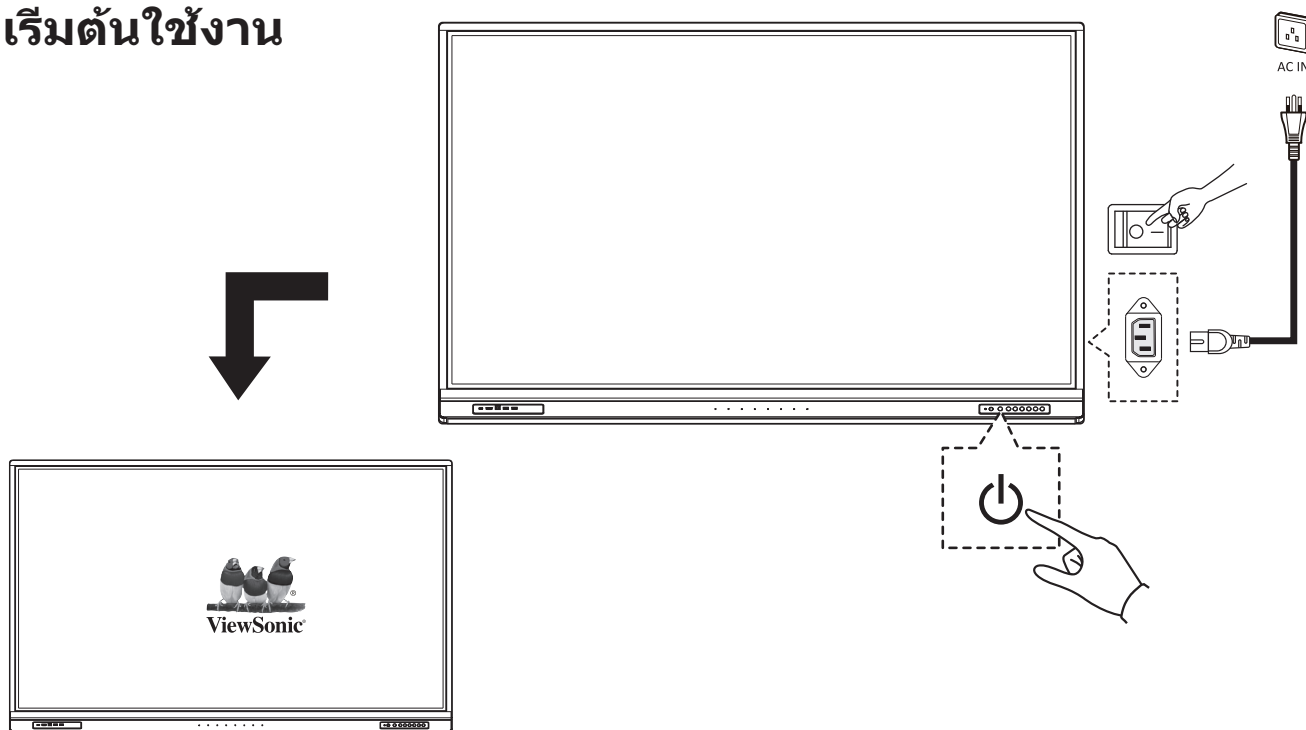



> คำแถลงเกี่ยวกับความสอดคล้อง

คำแถลงเรื่องการปฏิบัติตามข้อกำหนด FCC: อุปกรณ์นี้มีคุณสมบัติตรงตามกฎข้อบังคับ FCC ส่วนที่ 15 การทำงานต้องเป็นไปตามเงื่อนไขสองข้อต่อไปนี้: (1) อุปกรณ์นี้ต้องไม่ก่อให้เกิดการรบกวนที่เป็นอันตราย และ (2) อุปกรณ์นี้ต้องทนต่อการรบกวนที่ได้รับ รวมทั้งการรบกวนที่อาจก่อให้เกิดการทำงานที่ไม่พึงประสงค์ ปฏิบัติตามข้อกำหนดด้านอุตสาหกรรมแคนาดา ICES-003: CAN ICES-3 (B)/NMB-3(B)



ViewSonic Corporation (สหรัฐอเมริกา/แคนาดา/ละตินอเมริกา)

 : www.viewsonic.com/support/product-registration



สหรัฐอเมริกา

 1-800-688-6688

 customerservice@viewsonic.com

แคนาดา

 1-866-463-4775

 customerservice@viewsonic.com

เปอร์โตริโก & หมู่เกาะเวอร์จิน

 <http://www.viewsonic.com/la/soporte/servicio-tecnico> (Español)

ละตินอเมริกา

 <http://www.viewsonic.com/la/soporte/servicio-tecnico-la/>



ศูนย์บริการลูกค้า ViewSonic



อุปกรณ์เสริม

> 包裝內容物

- HDMI 線 (10ft/3m)
- Type-c 線 (5ft/1.5m)
- 用於觸控的 USB 線 (10ft/3m)
- 線夾 x 5
- 網路攝影機板
- AAA 電池 x 2
- 觸控筆 x 2
- 遙控器
- 橡皮擦
- 網路攝影機螺絲 x 4 (M4x7mm x2, M3x6mm x2)
- 快速啟用指南
- 符合性聲明
- RS232 轉接頭
- 電源線 (依地區出貨)
- 壁掛架螺絲 x 4 (M8x20mm x4)

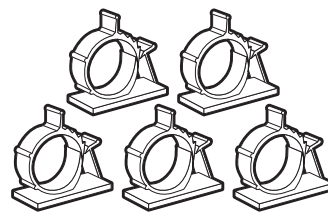
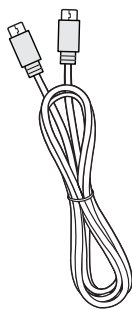
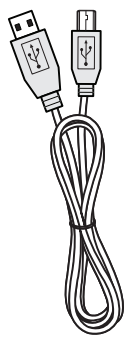
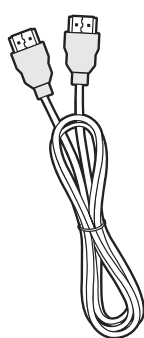
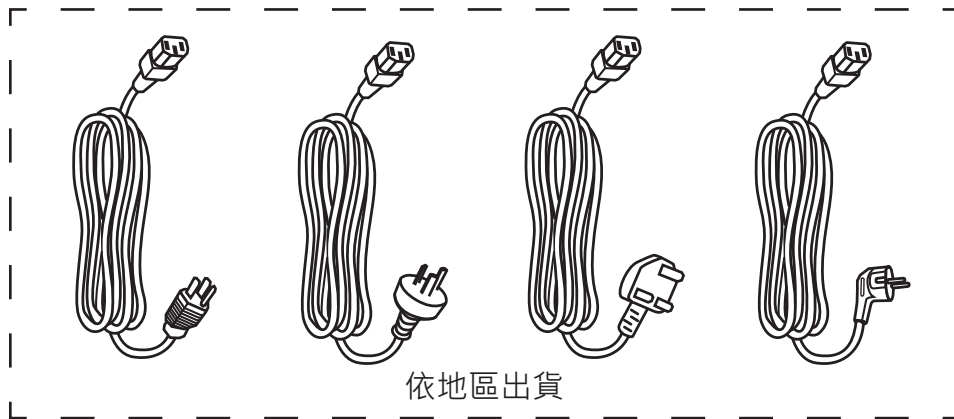

M8 X 4



M3 X 2



M4 X 2

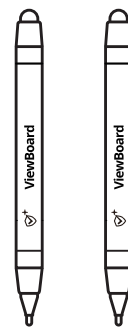
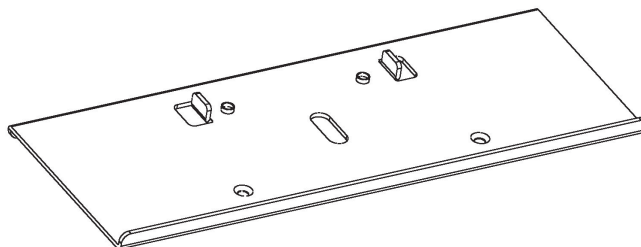
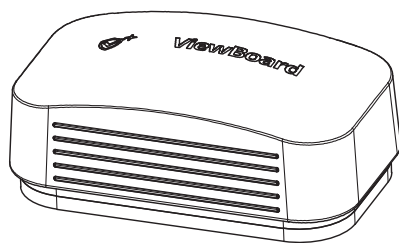

> 安裝環境注意事項

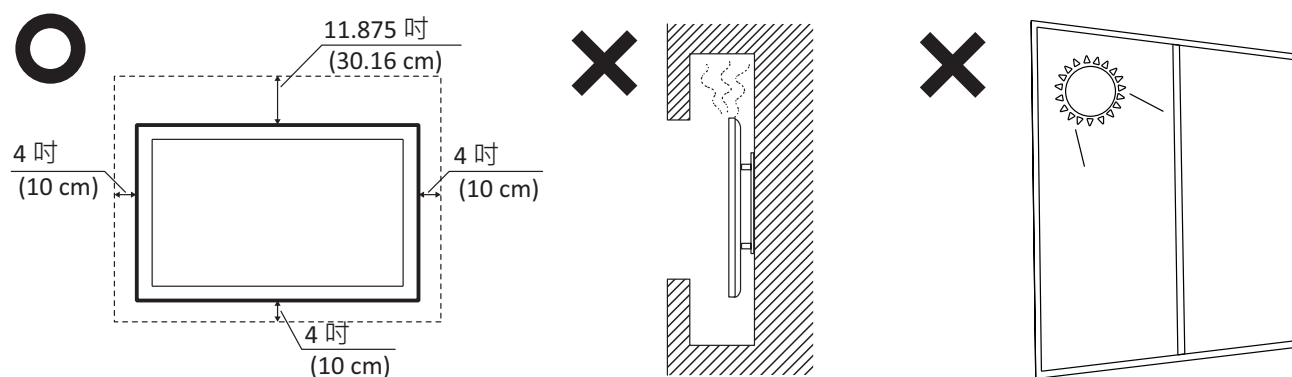

> 控制面板概觀

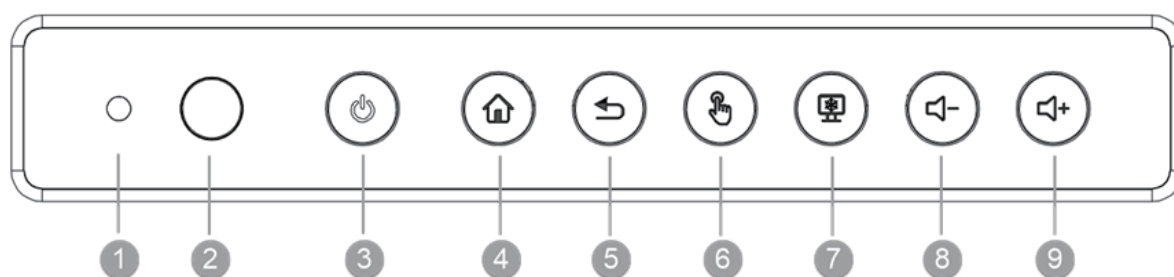

項目	說明
1	監控環境光的環境光感應器
2	遙控器接收器
3	電源指示燈 按下此鍵可開啟裝置 按下此鍵僅可關閉/開啟顯示背光 按住此鍵可關閉裝置
4	返回 ViewBoard 播放器主介面
5	返回 ViewBoard 播放器上一層
6	停用 / 啟用觸控螢幕
7	將目前影像定格在螢幕上
8	降低音量
9	調高音量

> 遙控器概觀

- 1 電源開啟 / 關閉
- 2 畫面擷取
- 3 *PC : 「Windows」按鈕
- 4 啟動書寫
- 5 返回嵌入式播放器首頁畫面
- 6 返回 / 返回上一頁
- 7 調高 / 調低音量
- 8 數字鍵
- 9 資訊
- 10 輸入來源選擇
- 11 媒體控制按鈕
紅色：播放 / 暫停
綠色：停止
黃色：向前
藍色：向後
- 12 *PC : 「功能表」按鈕
- 13 *PC : 退出對話方塊
- 14 設定選單
- 15 上 / 下 / 左 / 右 / 確定鍵
- 16 將畫面定格
- 17 靜音 / 解除靜音
- 18 調高 / 調低亮度
*PC : 上一頁 / 下一頁
- 19 空白畫面
- 20 調整長寬比

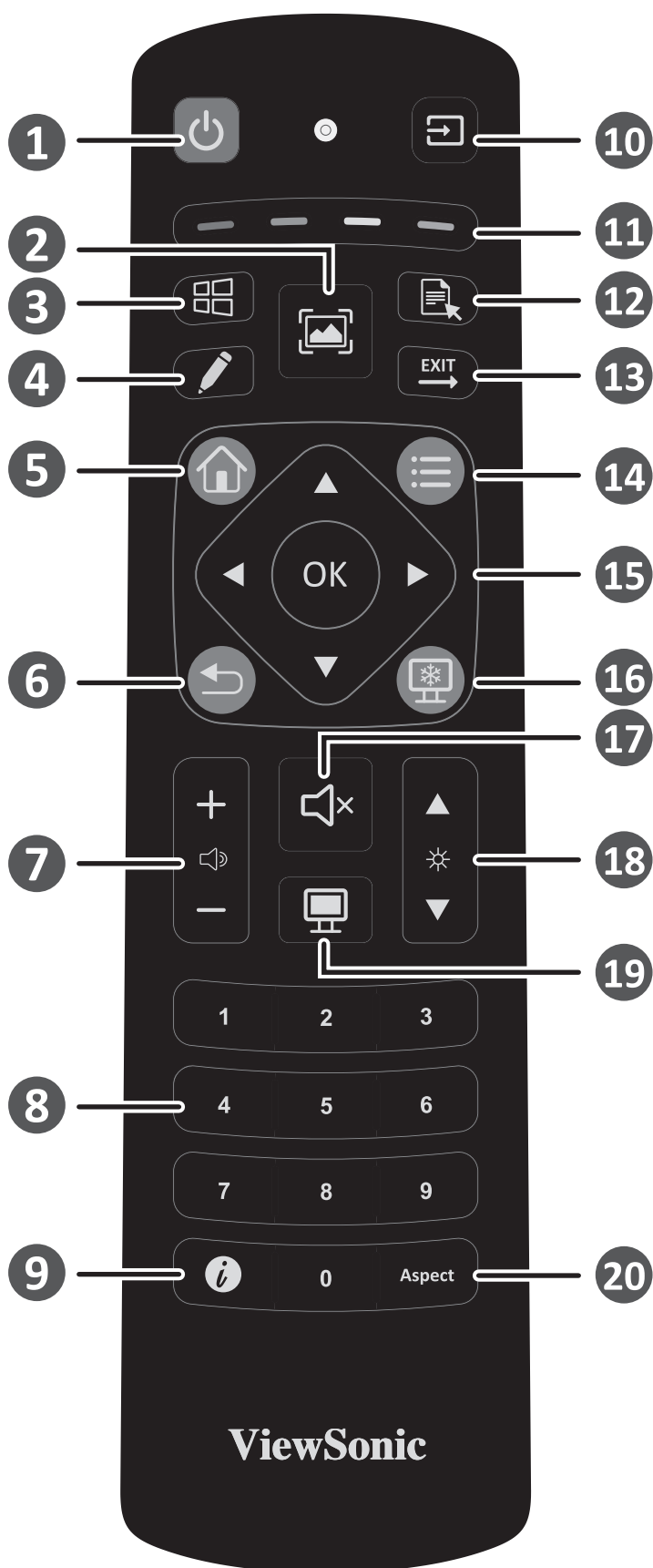

*PC 按鈕：並非所有機型都支援這些功能

> I/O 連接埠

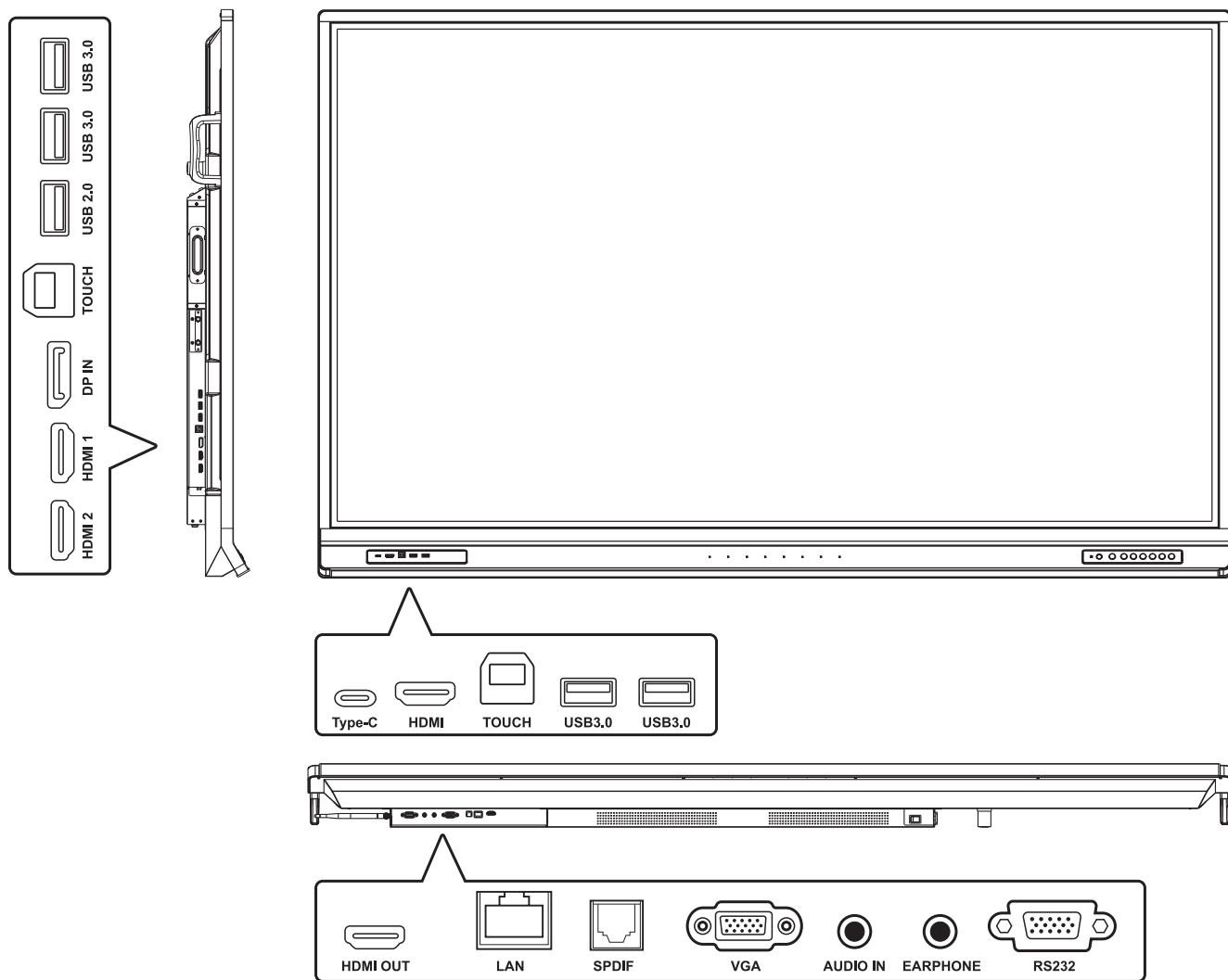

> USB 和網路連接

如同任何 PC，您可以輕鬆將各種 USB 裝置及其他周邊裝置連接至 ViewBoard。

USB 周邊裝置

將 USB 裝置連接線插入 USB 連接埠。

網路和數據機連接線

將路由器連接線插入 LAN 連接埠。

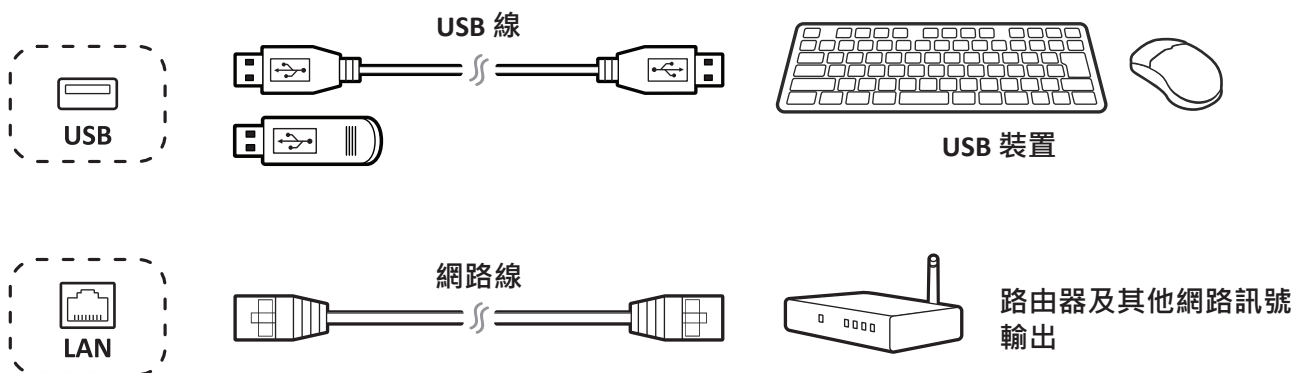

➤ 連接外部裝置和觸控連接

您的外部裝置可透過任一下列配置連接：

Type C 連接

將 Type C 線從外部裝置，連接到 ViewBoard 的 Type C 連接埠。

DisplayPort 連接

1. 將 DisplayPort 線從外部裝置連接到 ViewBoard 的 DisplayPort 連接埠。
2. 將 USB 線從 ViewBoard 的 TOUCH 連接埠，連接到外部裝置。

HDMI 連接

1. 將 HDMI 線從外部裝置連接到 ViewBoard 的 HDMI IN 連接埠。
2. 將 USB 線從 ViewBoard 的 TOUCH 連接埠，連接到外部裝置。

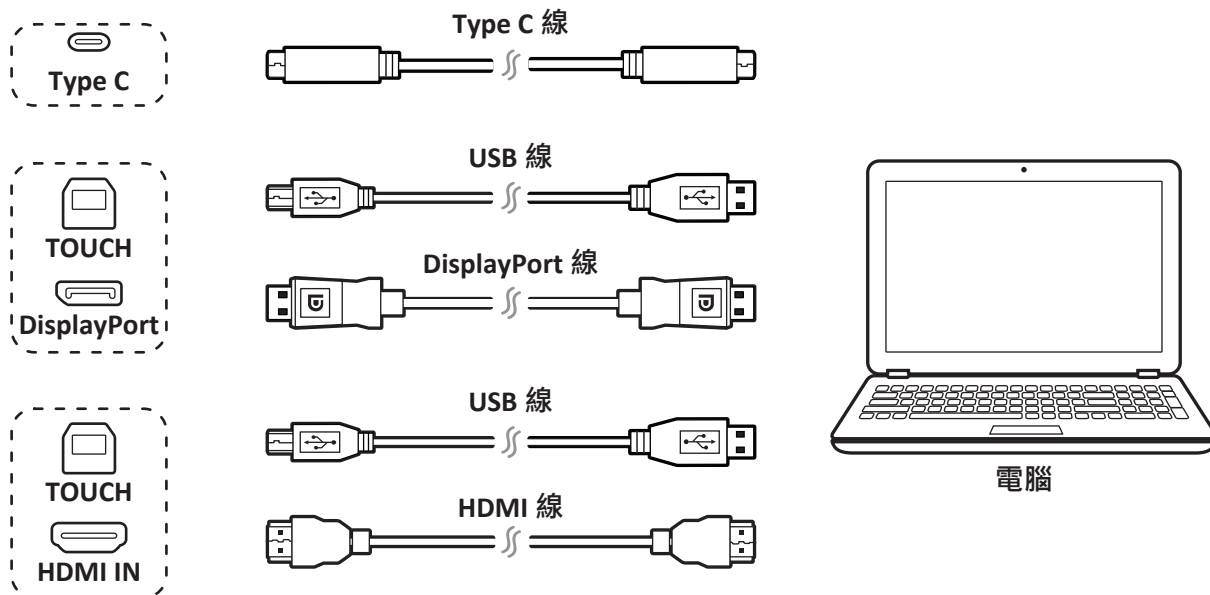

➤ RS232 連接

使用 RS232 序列埠連接線將顯示器連接至外部電腦時，可透過 PC 控制某些功能，包括電源開啟 / 關閉、音量調整等等。

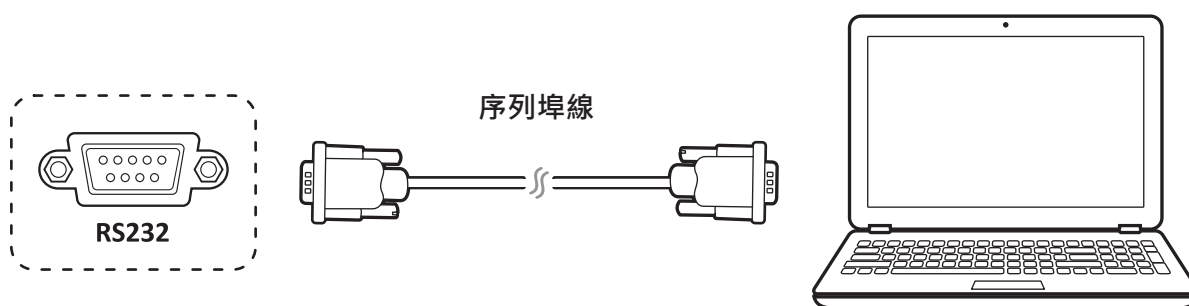

> 媒體播放器 (影音) 連接

若要連接至媒體播放器：

1. 將 HDMI 線連接至 ViewBoard 和周邊裝置的 HDMI 連接埠。
2. 插入 ViewBoard 的電源線，然後開啟後面板電源開關。
3. 按下 ViewBoard 右側的電源按鈕開啟螢幕。
4. 按下遙控器上的 INPUT 按鈕，並切換至「HDMI」輸入來源。

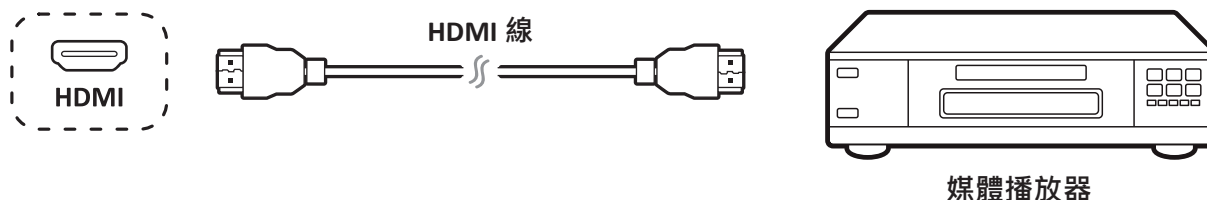

> SPDIF 連接

若要連接至外部音響系統：

1. 將光纖線從 SPDIF 連接埠，連接到音響系統的光纖接頭。
2. 插入 ViewBoard 的電源線，然後開啟後面板電源開關。
3. 按下 ViewBoard 右側的電源按鈕開啟螢幕。

備註：S/PDIF 與耳機音訊輸出僅會在 ViewBoard 播放器、HDMI 及 DP 通道上作用。

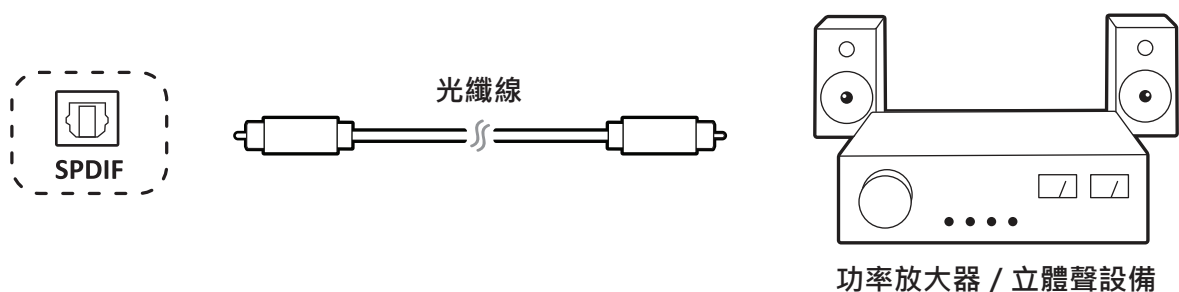

> 視訊輸出連接

若要透過顯示裝置輸出視訊：

1. 將 HDMI 線連接至顯示裝置的 HDMI IN 連接埠，另一端連接至 ViewBoard 的 HDMI OUT 連接埠。
2. 至於音訊，請將音訊線的一端連接至 ViewBoard 的 EARPHONE 連接埠，另一端連接至揚聲器。
3. 插入 ViewBoard 的電源線，然後開啟後面板電源開關。
4. 按下 ViewBoard 右側的電源按鈕開啟螢幕。

備註：S/PDIF 與耳機音訊輸出僅會在 ViewBoard 播放器、HDMI 及 DP 通道上作用。

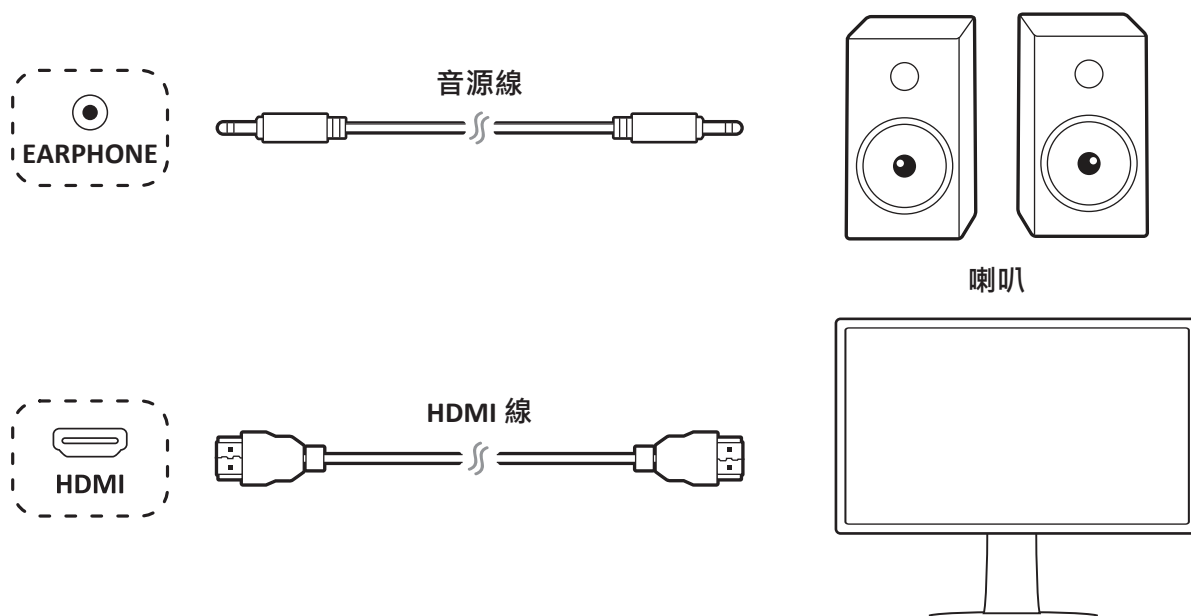

> 開始使用

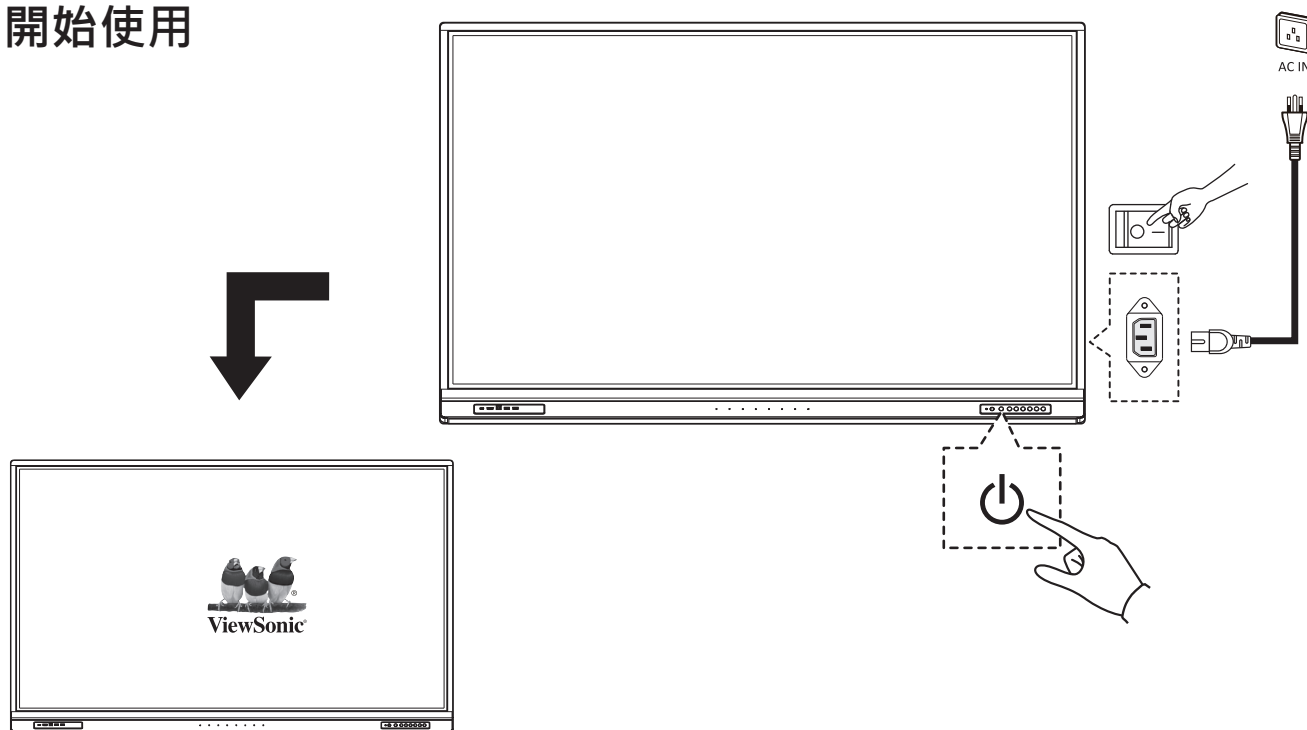



> 符合性聲明

FCC 符合性聲明：本設備符合 FCC 規則第 15 部分的規定。操作時有以下兩種情況：(1) 本裝置不會造成有害的干擾，以及 (2) 本裝置必須接受任何接收到的干擾，包括造成操作不良的干擾。
工業加拿大 ICES-003 符合性： CAN ICES-3 (B)/NMB-3(B)



ViewSonic Corporation (美國/加拿大/拉丁美洲)

 : www.viewsonic.com/support/product-registration



美國

 1-800-688-6688

 customerservice@viewsonic.com

加拿大

 1-866-463-4775

 customerservice@viewsonic.com

波多黎各與維爾京群島

 <http://www.viewsonic.com/la/soporte/servicio-tecnico> (西班牙文)

拉丁美洲

 <http://www.viewsonic.com/la/soporte/servicio-tecnico-la/>



ViewSonic 支援中心



選購配件

> 包装内容物

- HDMI 线 (10ft/3m)
- Type-c 线 (5ft/1.5m)
- 用于触控的 USB 线 (10ft/3m)
- 线夹 x 5
- 网络摄影机板
- AAA 电池 x 2
- 触控笔 x 2
- 遥控器
- 橡皮擦
- 网络摄影机螺丝 x 4 (M4x7mm x2, M3x6mm x2)
- 快速启用指南
- 符合性声明
- RS232 转接头
- 电源线 (依地区出货)
- 壁挂架螺丝 x 4 (M8x20mm x4)

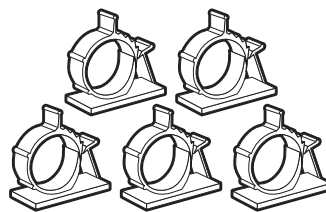
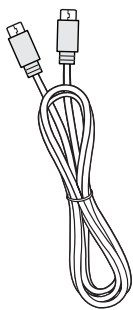
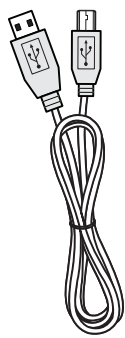
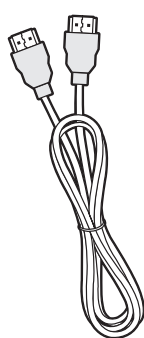
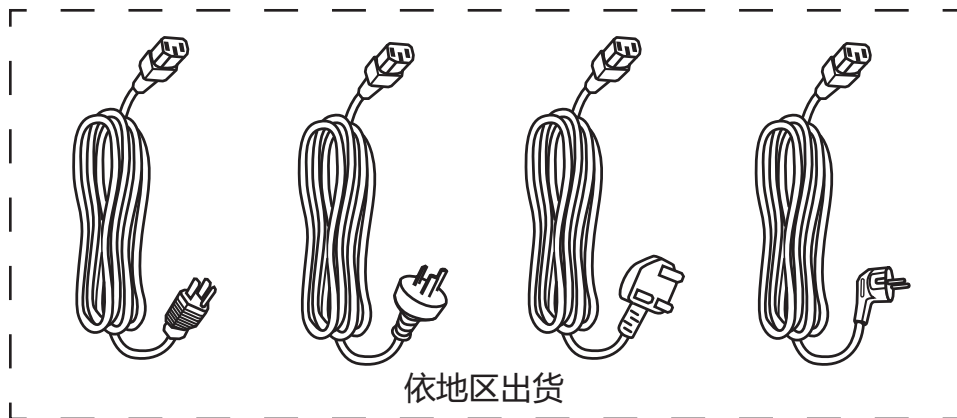

M8 X 4



M3 X 2



M4 X 2

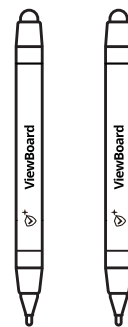
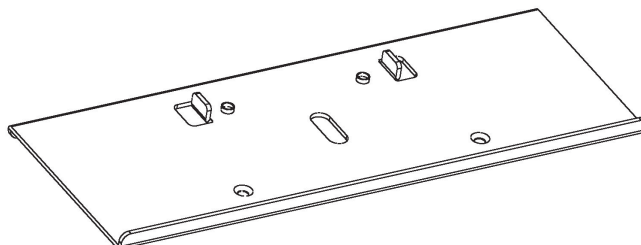
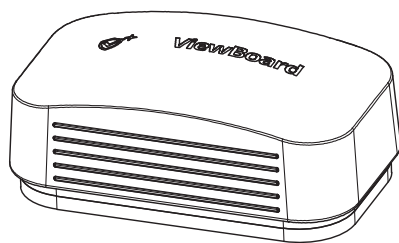

➤ 壁挂套件规格 (另外贩卖)

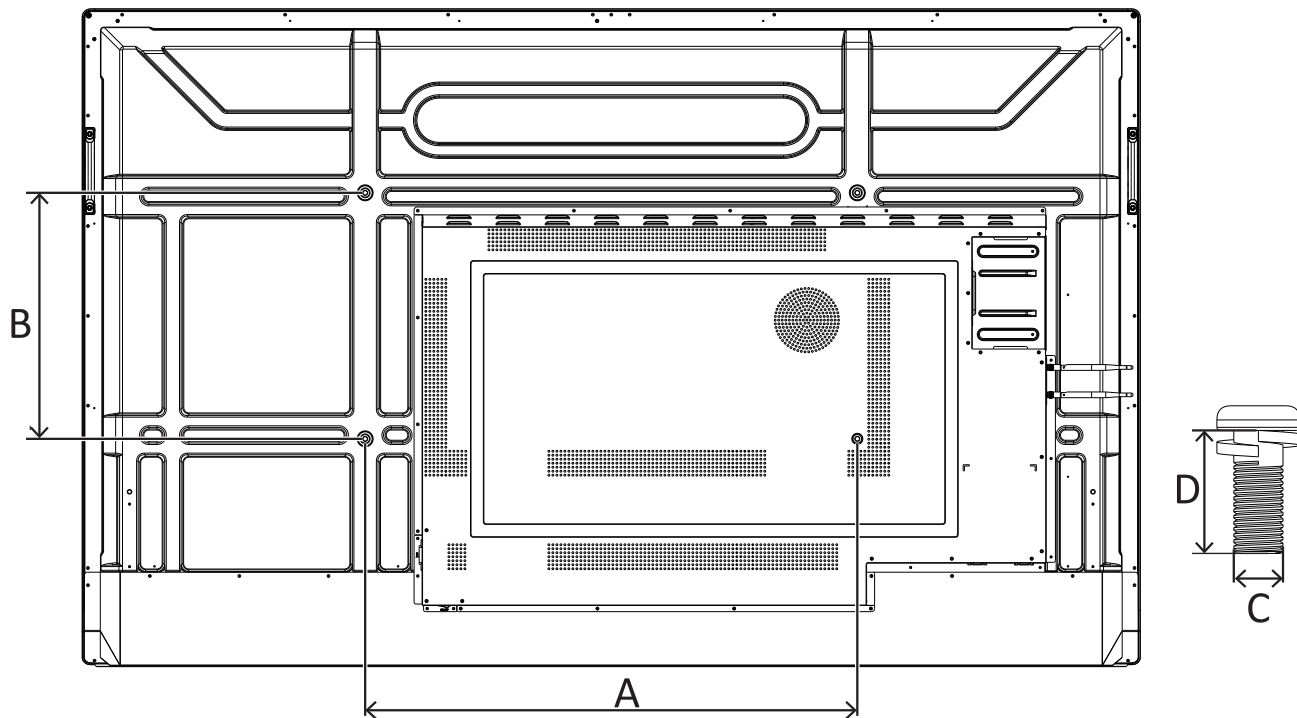

吋	VESA 规格 (A x B)	标准螺丝 (C x D)	数量
IFP6552 系列	600 x 400 mm	M8 x 20 mm	4
IFP7552 系列	800 x 400 mm	M8 x 20 mm	4
IFP8652 系列	800 x 600 mm	M8 x 20 mm	4

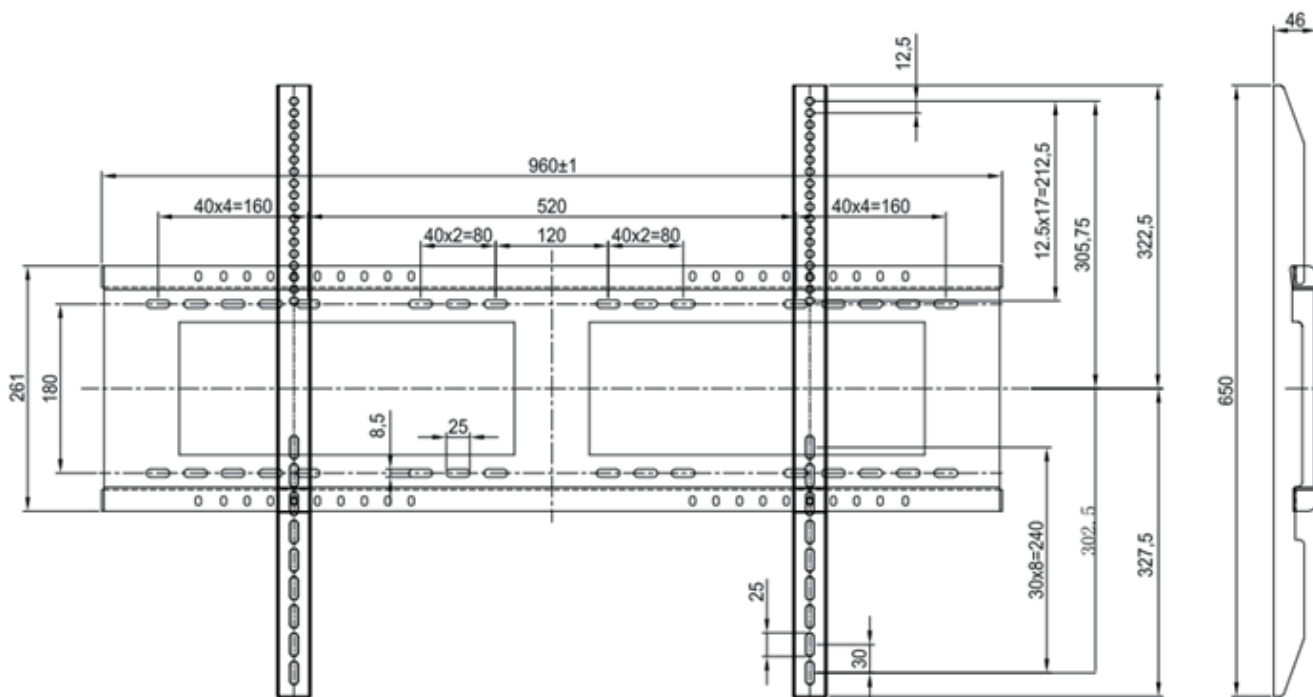

> 安装环境注意事项

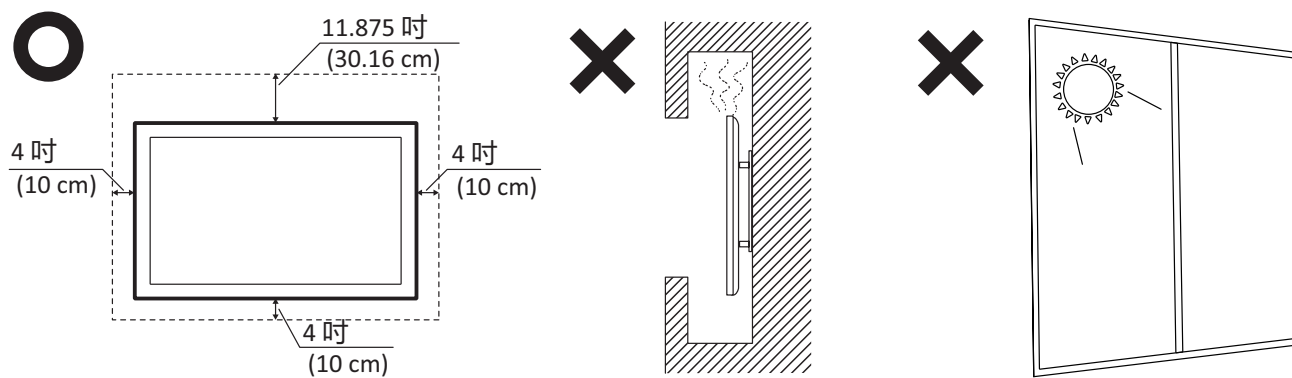

> 控制面板概观

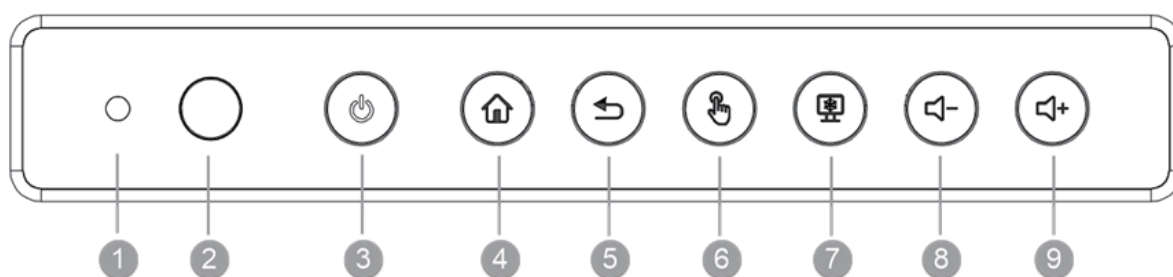

项目	说明
1	监控环境光的环境光传感器
2	遥控器接收器
3	电源指示灯 按下此键可开启装置 按下此键仅可关闭/开启显示背光 按住此键可关闭装置
4	返回 ViewBoard 播放器主界面
5	返回 ViewBoard 播放器上一层
6	停用 / 启用触控屏幕
7	将目前影像定格在屏幕上
8	降低音量
9	调高音量

> 遥控器概观

- ① 电源开启 / 关闭
- ② 画面撷取
- ③ *PC: 「Windows」按钮
- ④ 启动书写
- ⑤ 返回嵌入式播放器首页画面
- ⑥ 返回 / 返回上一页
- ⑦ 调高 / 调低音量
- ⑧ 数字键
- ⑨ 信息
- ⑩ 输入来源选择
- ⑪ 媒体控制按钮
 红色: 播放 / 暂停
 绿色: 停止
 黄色: 向前
 蓝色: 向后
- ⑫ *PC: 「菜单」按钮
- ⑬ *PC: 退出对话框
- ⑭ 设定选单
- ⑮ 上 / 下 / 左 / 右 / 确定键
- ⑯ 将画面定格
- ⑰ 静音 / 解除静音
- ⑱ 调高 / 调低亮度
 *PC: 上一页 / 下一页
- ⑲ 空白画面
- ⑳ 调整长宽比

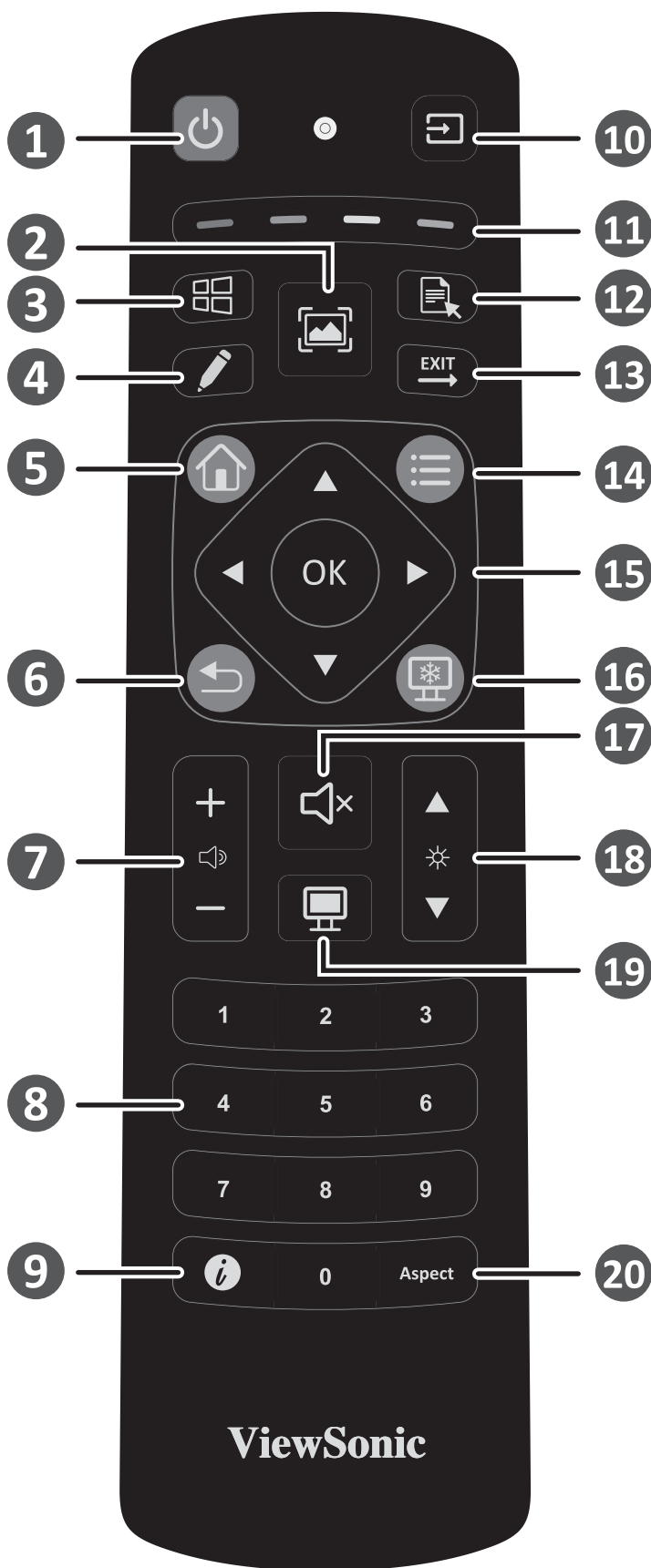

*PC 按钮: 并非所有机型都支援这些功能

> I/O 端口

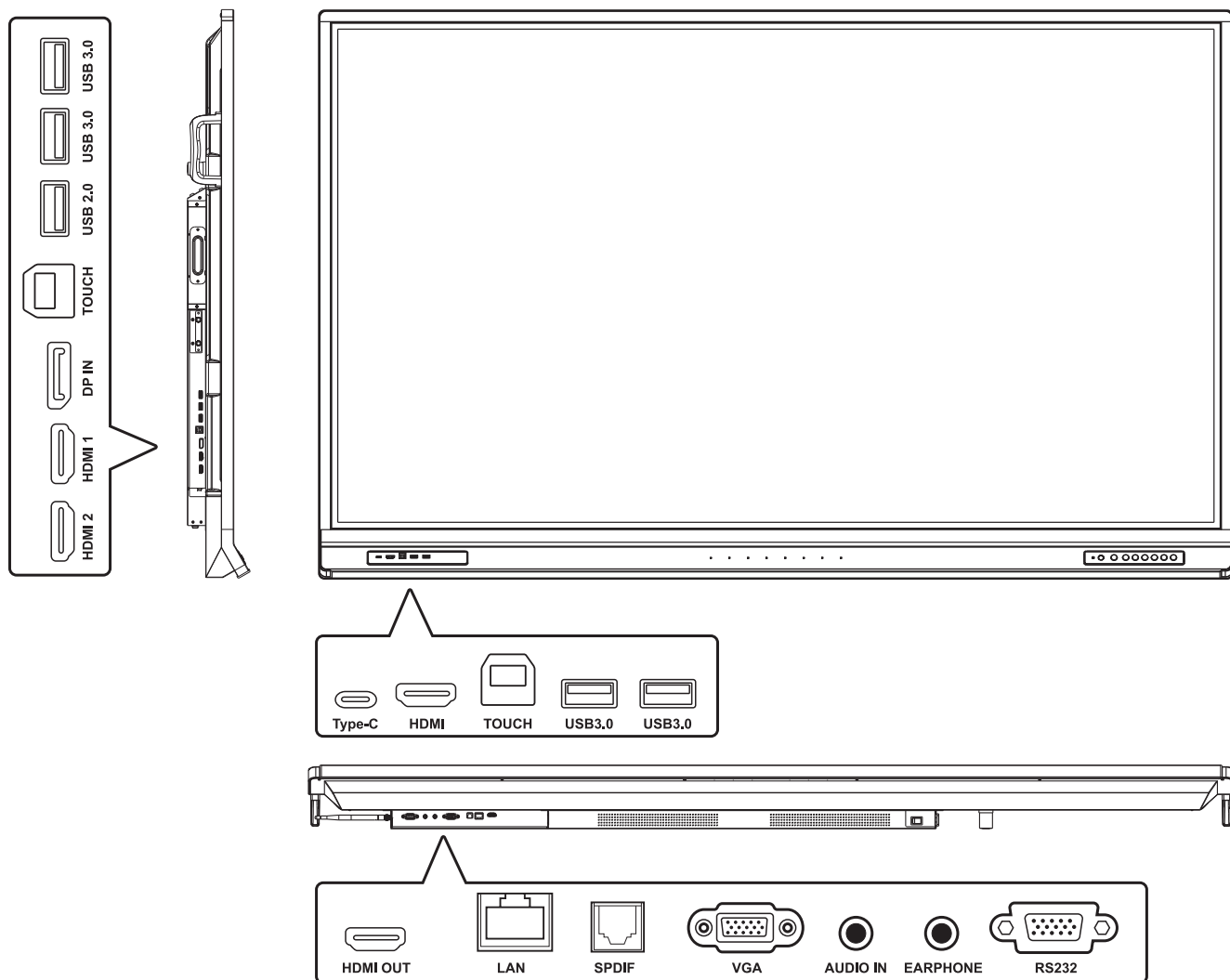

> USB 和网络连接

如同任何 PC，您可以轻松将各种 USB 装置及其他周边装置连接至 ViewBoard。

USB 周边装置

将 USB 装置连接线插入 USB 端口。

网络 and 调制解调器连接线

将路由器连接线插入 LAN 端口。

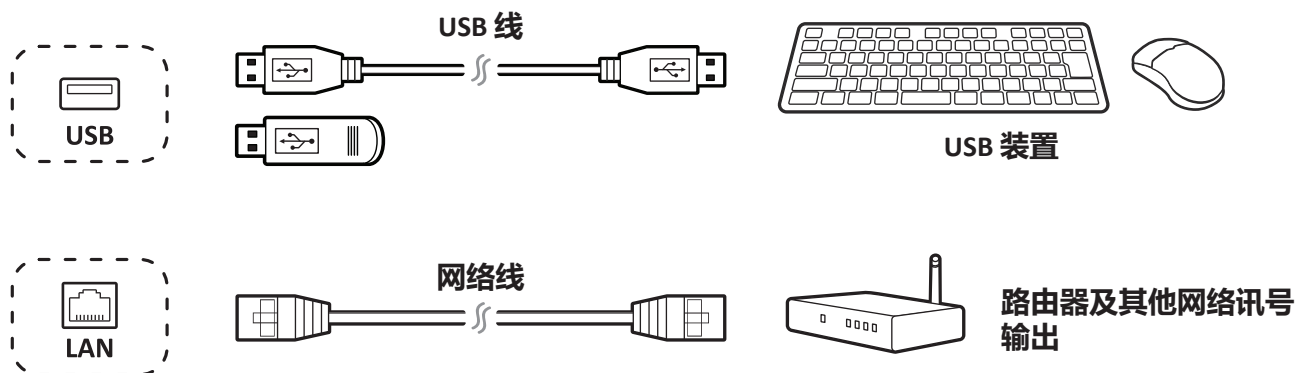

> 连接外部装置和触控连接

您的外部装置可透过任一下列配置连接：

Type C 连接

将 Type C 线从外部装置，连接到 ViewBoard 的 Type C 端口。

DisplayPort 连接

1. 将 DisplayPort 线从外部装置连接到 ViewBoard 的 DisplayPort 端口。
2. 将 USB 线从 ViewBoard 的 TOUCH 端口，连接到外部装置。

HDMI 连接

1. 将 HDMI 线从外部装置连接到 ViewBoard 的 HDMI IN 端口。
2. 将 USB 线从 ViewBoard 的 TOUCH 端口，连接到外部装置。

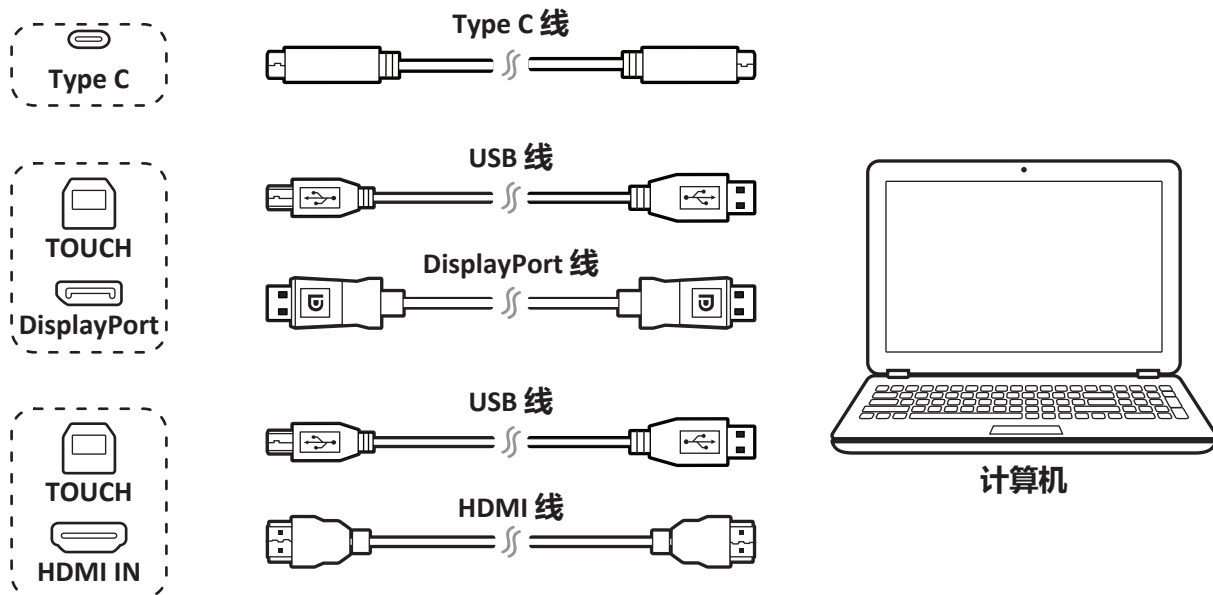

> RS232 连接

使用 RS232 串行端口连接线将显示器连接至外部计算机时，可透过 PC 控制某些功能，包括电源开启 / 关闭、音量调整等等。

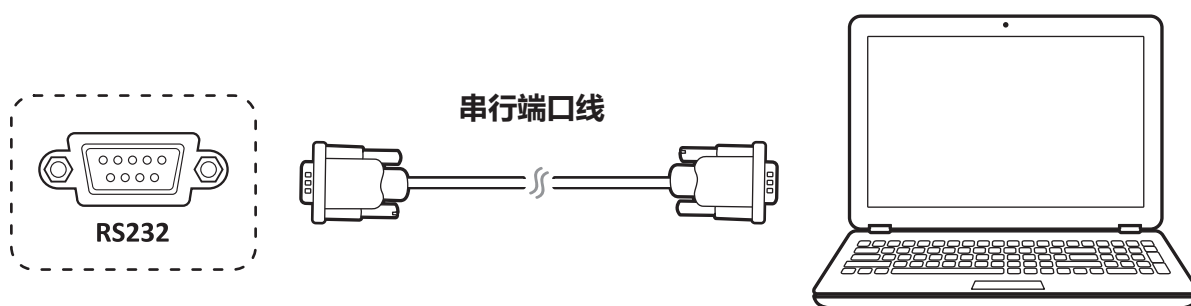

> 媒体播放器（影音）连接

若要连接至媒体播放器：

1. 将 HDMI 线连接至 ViewBoard 和周边装置的 HDMI 端口。
2. 插入 ViewBoard 的电源线，然后开启后面板电源开关。
3. 按下 ViewBoard 右侧的电源按钮开启屏幕。
4. 按下遥控器上的 INPUT 按钮，并切换至「HDMI」输入来源。

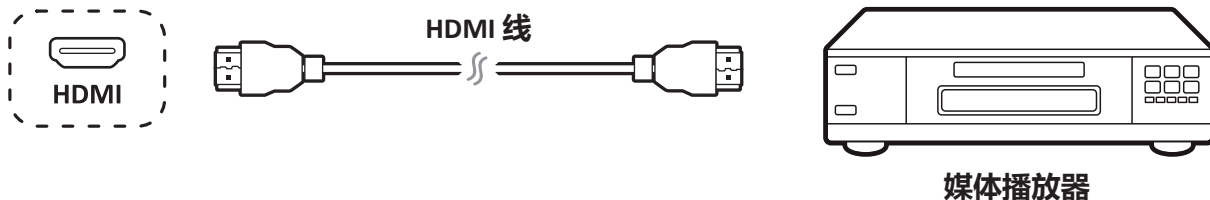

> SPDIF 连接

若要连接至外部音响系统：

1. 将光纤线从 SPDIF 端口，连接到音响系统的光纤接头。
2. 插入 ViewBoard 的电源线，然后开启后面板电源开关。
3. 按下 ViewBoard 右侧的电源按钮开启屏幕。

备注：S/PDIF 与耳机音讯输出仅会在 ViewBoard 播放器、HDMI 及 DP 通道上作用。

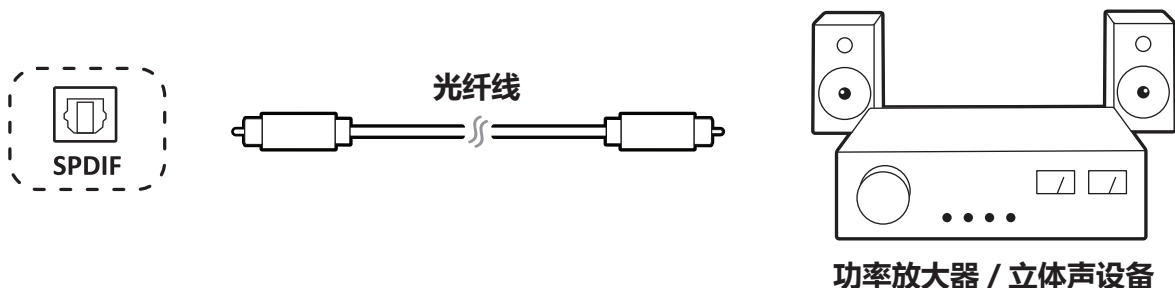

> 视讯输出连接

若要透过显示设备输出视讯：

1. 将 HDMI 线连接至显示设备的 HDMI IN 端口，另一端连接至 ViewBoard 的 HDMI OUT 端口。
2. 至于音频，请将音频线的一端连接至 ViewBoard 的 EARPHONE 端口，另一端连接至扬声器。
3. 插入 ViewBoard 的电源线，然后开启后面板电源开关。
4. 按下 ViewBoard 右侧的电源按钮开启屏幕。

备注： S/PDIF 与耳机音讯输出仅会在 ViewBoard 播放器、HDMI 及 DP 通道上作用。

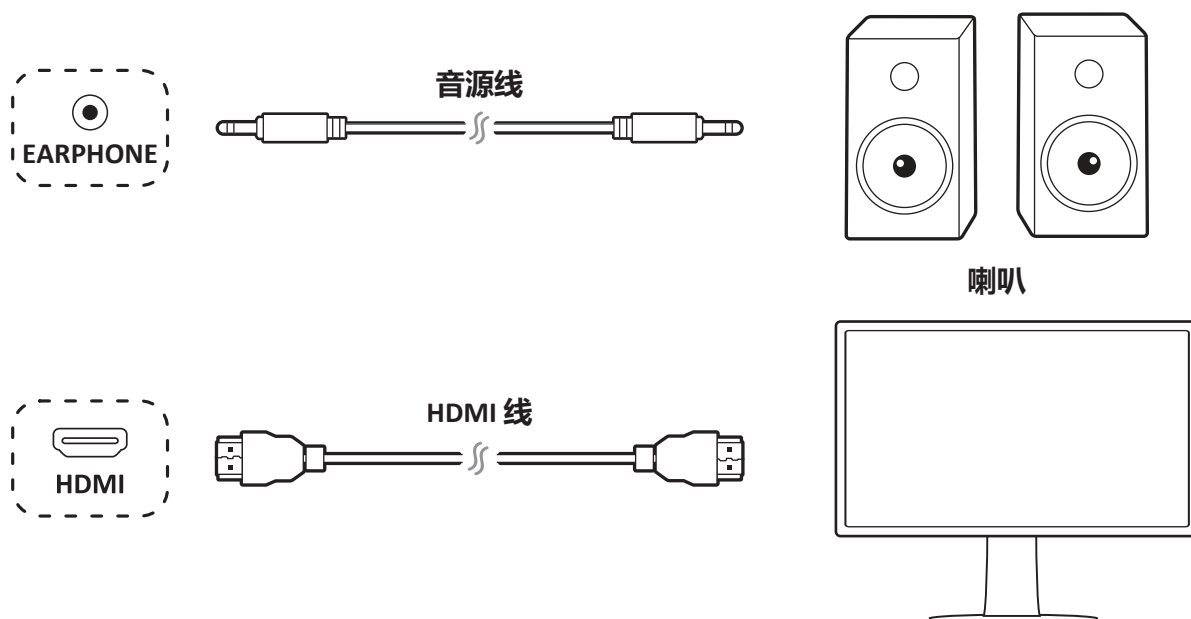

> 开始使用

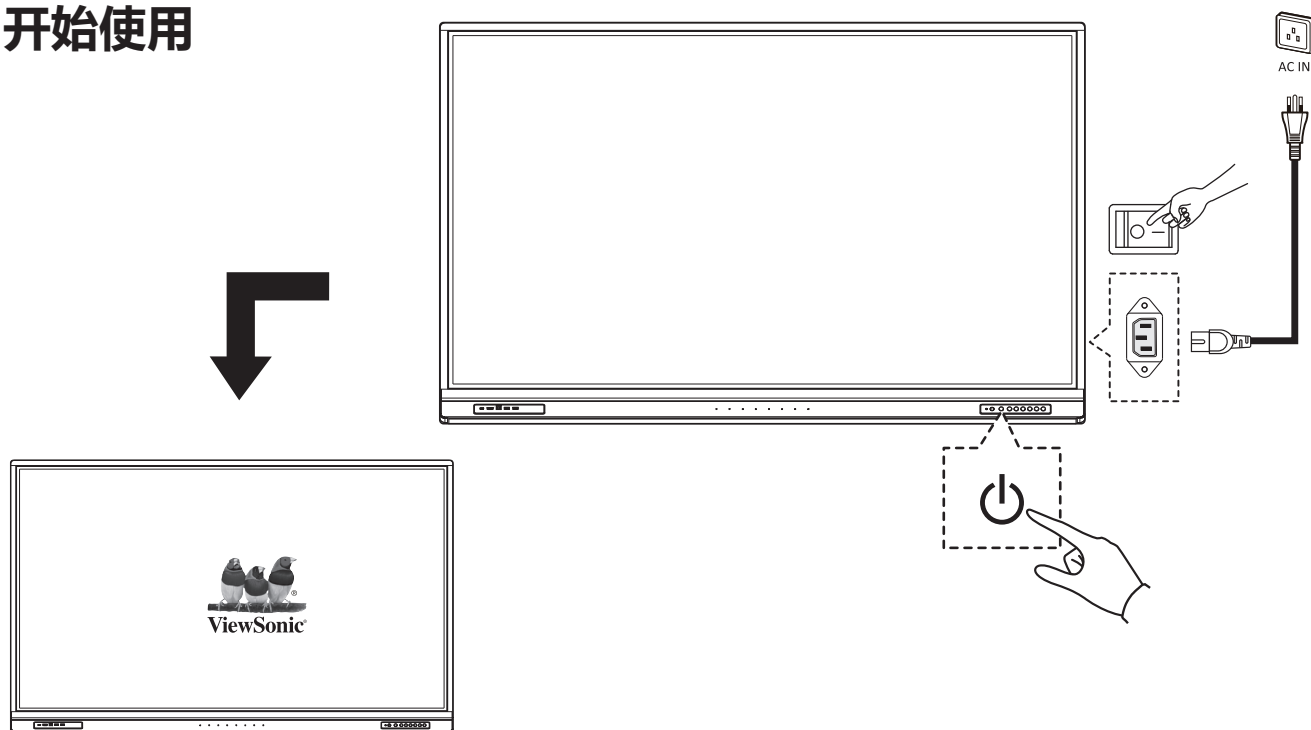



> 符合性声明

FCC 符合性声明：本设备符合 FCC 规则第 15 部分的规定。操作时有以下两种情况：(1) 本装置不会造成有害的干扰，以及 (2) 本装置必须接受任何接收到的干扰，包括造成操作不良的干扰。

工业加拿大 ICES-003 符合性： CAN ICES-3 (B)/NMB-3(B)



ViewSonic Corporation (美国/加拿大/拉丁美洲)

 : www.viewsonic.com/support/product-registration



美国

 1-800-688-6688

 customerservice@viewsonic.com

加拿大

 1-866-463-4775

 customerservice@viewsonic.com

波多黎各与维京群岛

 <http://www.viewsonic.com/la/soporte/servicio-tecnico> (西班牙文)

拉丁美洲

 <http://www.viewsonic.com/la/soporte/servicio-tecnico-la/>



ViewSonic 支持中心



选购配件

> 付属品

- HDMI ケーブル (10ft/3m)
- USB Type C ケーブル (5ft/1.5m)
- USB Type A/B ケーブル (10ft/3m)
- 電源ケーブル
- ウェブカメラプレート
- 単四電池 x 2
- タッチペン x 2
- リモコン
- 消しゴム
- ウェブカメラ用ネジ x 4 (M4x7mm x2, M3x6mm x2)
- RS232アダプター
- ケーブルクランプ x 5
- 壁取り付けネジ x 4 (M8x20mm x4)
- クイックスタートガイド
- 保証書

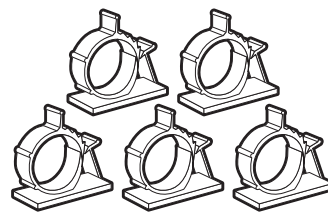
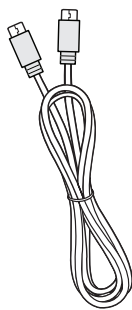
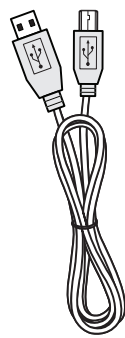
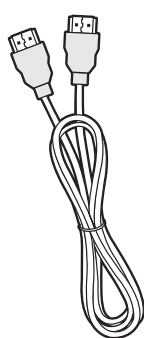
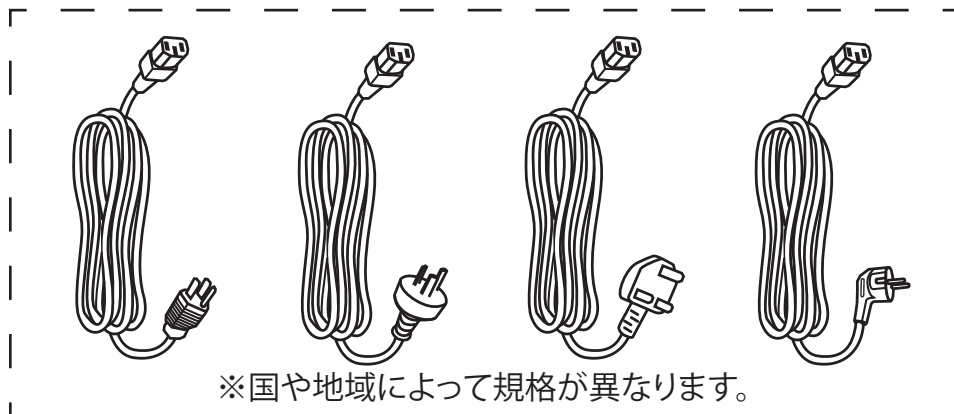

M8 X 4



M3 X 2



M4 X 2

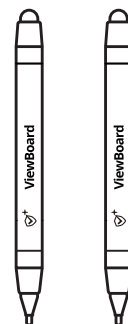
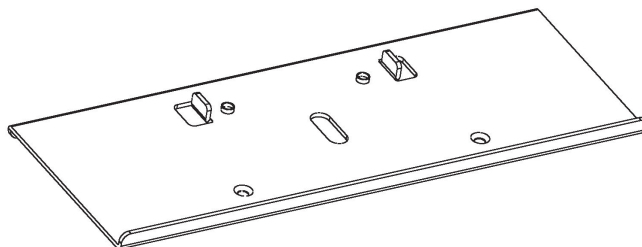
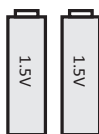
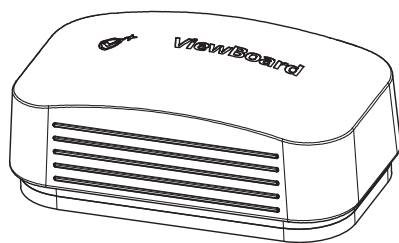

> 壁取り付けキットの仕様 (別売り)

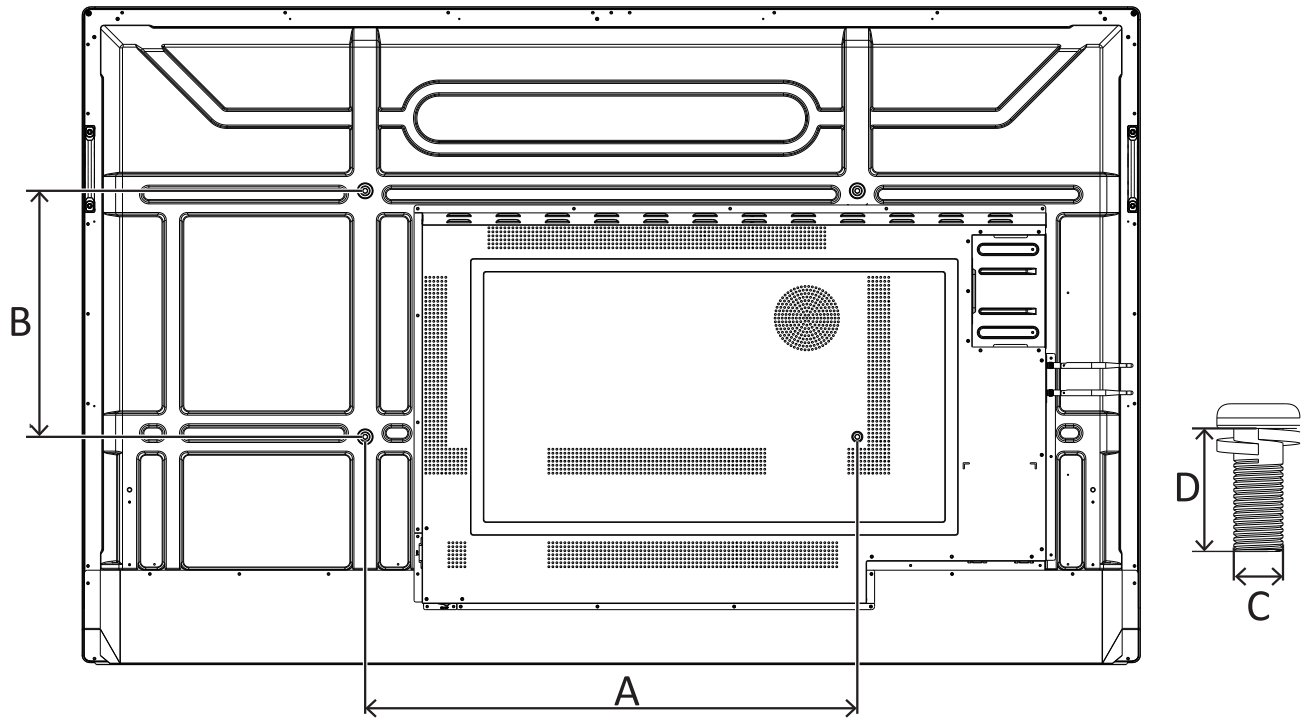

サイズ別 (型番)	VESA仕様 (A x B)	標準ネジ (C x D)	数量
IFP6552	600 x 400 mm	M8 x 20 mm	4
IFP7552	800 x 400 mm	M8 x 20 mm	4
IFP8652	800 x 600 mm	M8 x 20 mm	4

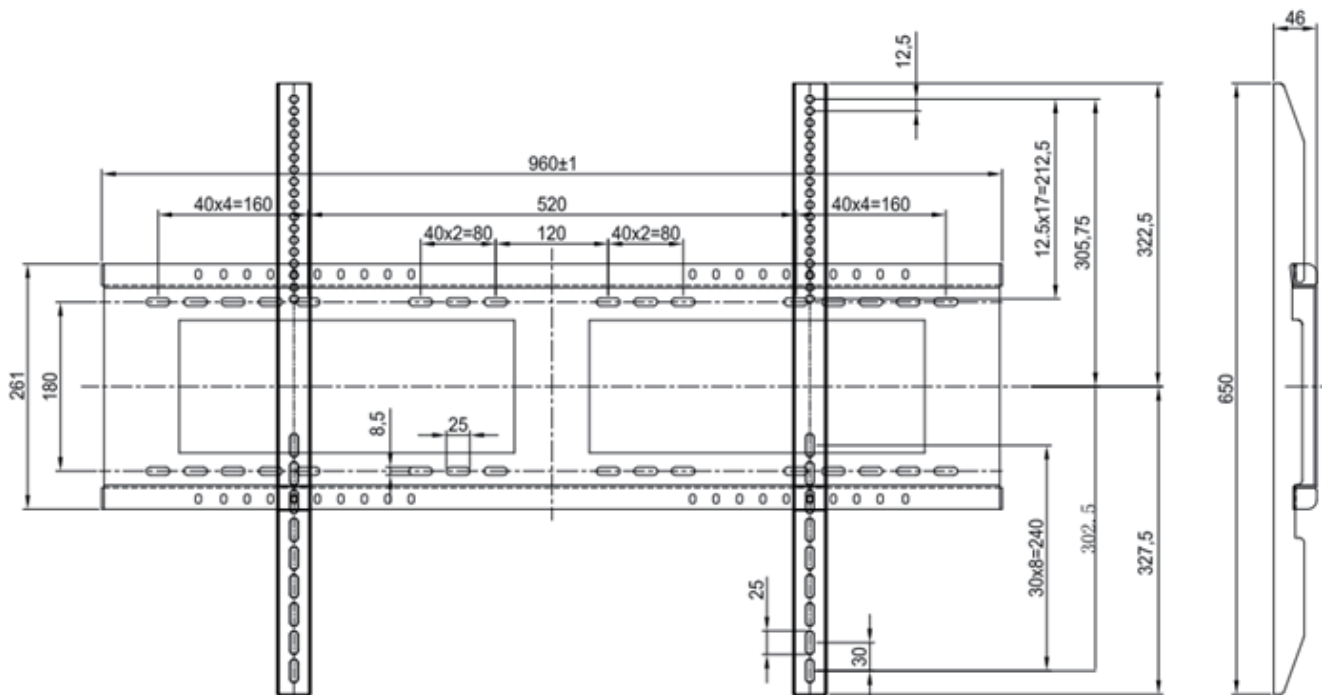

> 設置環境に関する注意事項

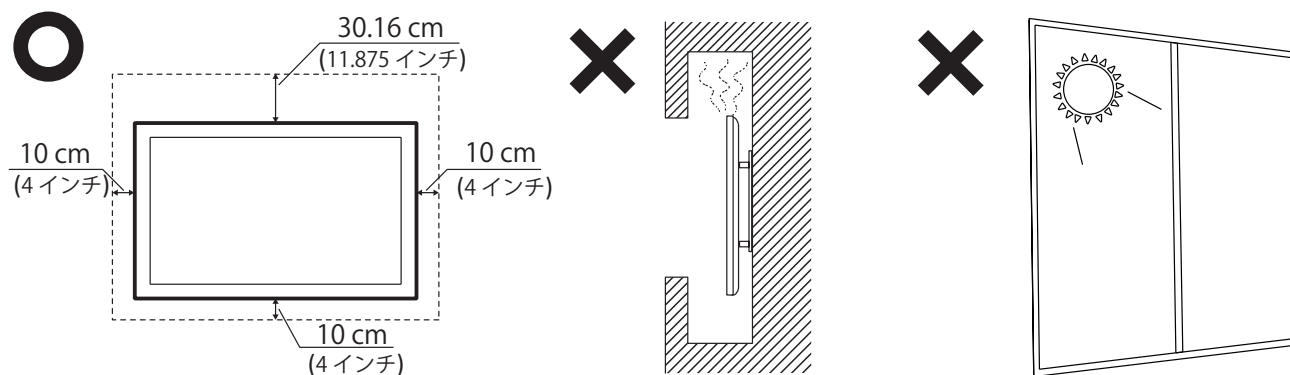

> コントロールパネルの概要

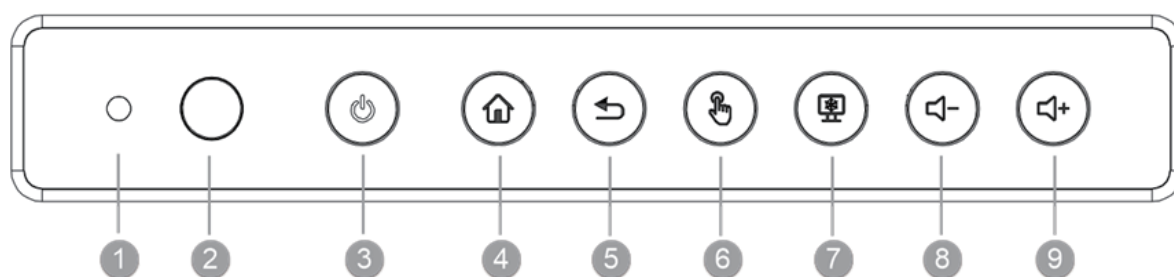

項目	詳細
①	周囲の明るさを検知する環境光センサー
②	リモコンレシーバー
③	電源インジケータ ボタンを押して、本機の電源を入れます。 ボタンを押して、本機のバックライトのみをオンまたはオフにします。 ボタンを押し続けると、本機の電源がオフになります。
④	ViewBoard プレーヤーのホーム画面に戻る。
⑤	ViewBoard プレーヤーの前のページに戻る。
⑥	タッチ機能を無効/有効にする。
⑦	画面上の現在の画像をフリーズする。
⑧	音量を下げる。
⑨	音量を上げる。

> リモコンの概要

- ① 電源オン/オフ
- ② 画面キャプチャ
- ③ Windowsボタン *PC
- ④ 書き込みの開始
- ⑤ ViewBoard プレーヤーのホーム画面に戻る
- ⑥ 戻る/前のページに戻る
- ⑦ 音量を上げる/下げる
- ⑧ 数字キーパッド
- ⑨ インフォメーション
- ⑩ 入力ソースの選択
- ⑪ メディアコントロールボタン
赤：再生/一時停止
緑：停止
黄：早送り
青：巻き戻し
- ⑫ メニューボタン *PC
- ⑬ ダイアログボックスの終了 *PC
- ⑭ 設定メニュー
- ⑮ 上/下/右/左/OK ボタン
- ⑯ 画面のフリーズ
- ⑰ ミュートの有効/解除
- ⑱ 輝度を上げる/下げる
*PC：ページアップ/ページダウン
- ⑲ ブランク画面
- ⑳ アスペクト比の調整

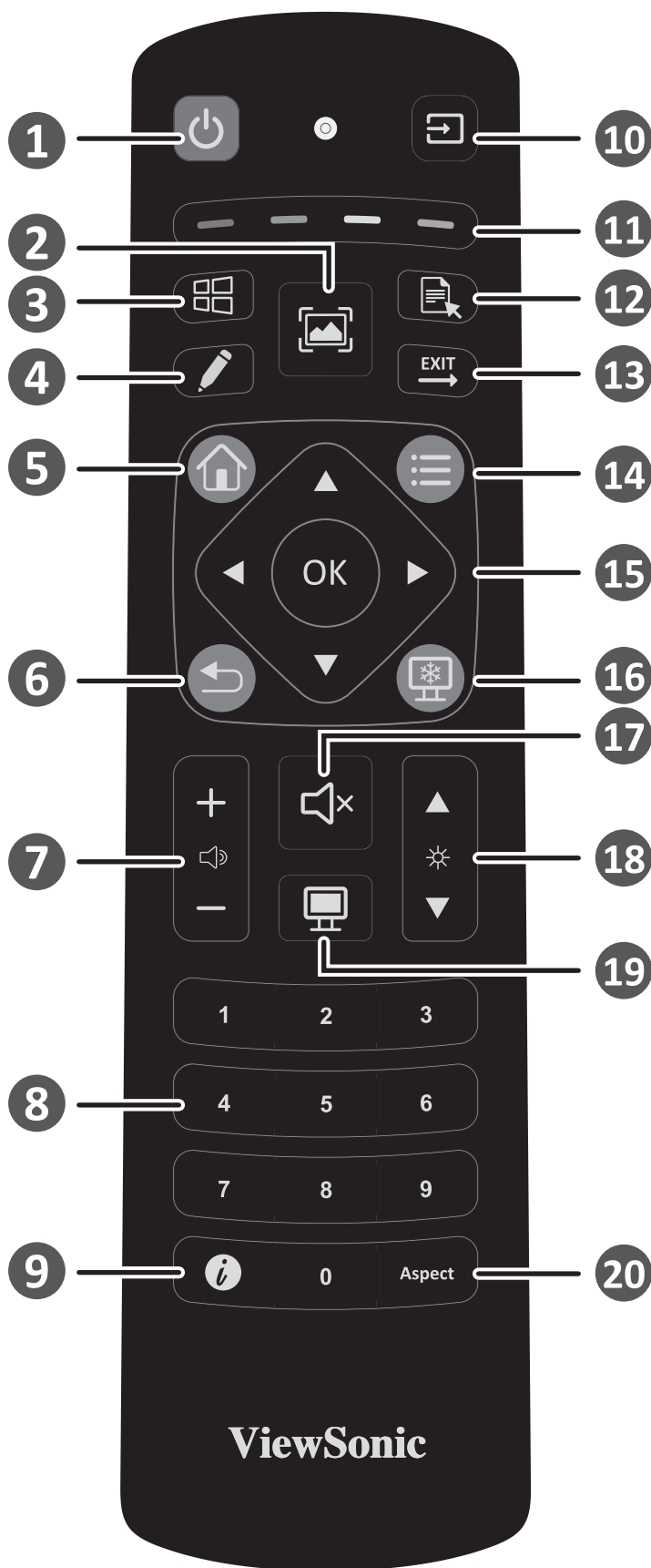

*PC: 型番によってこれらの機能に対応していない場合があります。

> 入出力ポート

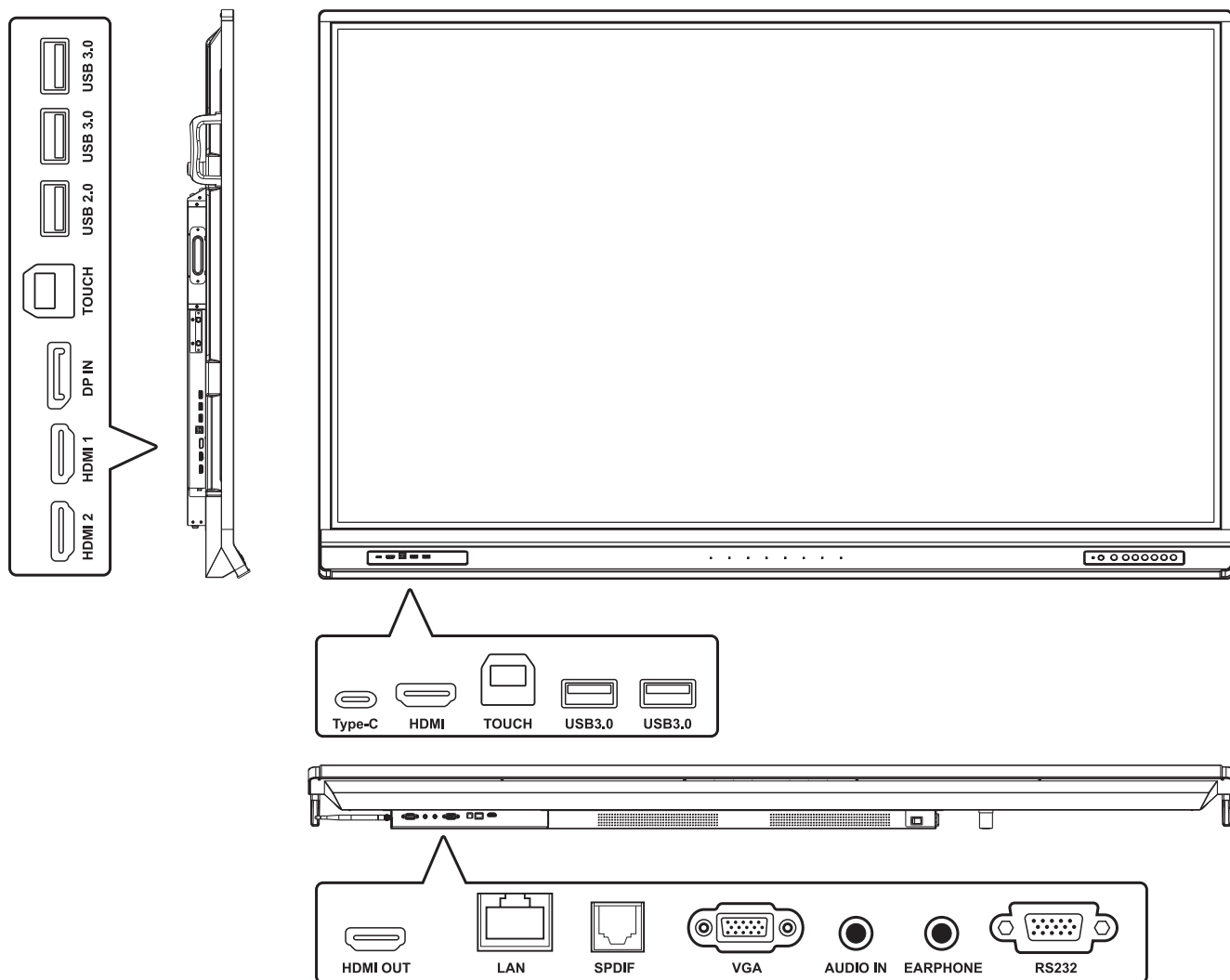

> USB およびネットワーク接続

パソコンのように、さまざまな USB デバイスや周辺機器を ViewBoard に簡単に接続できます。

USB 周辺機器

USB ケーブルを USB ポートに接続します。

ネットワーク

LAN ケーブルを LAN ポートに接続します。

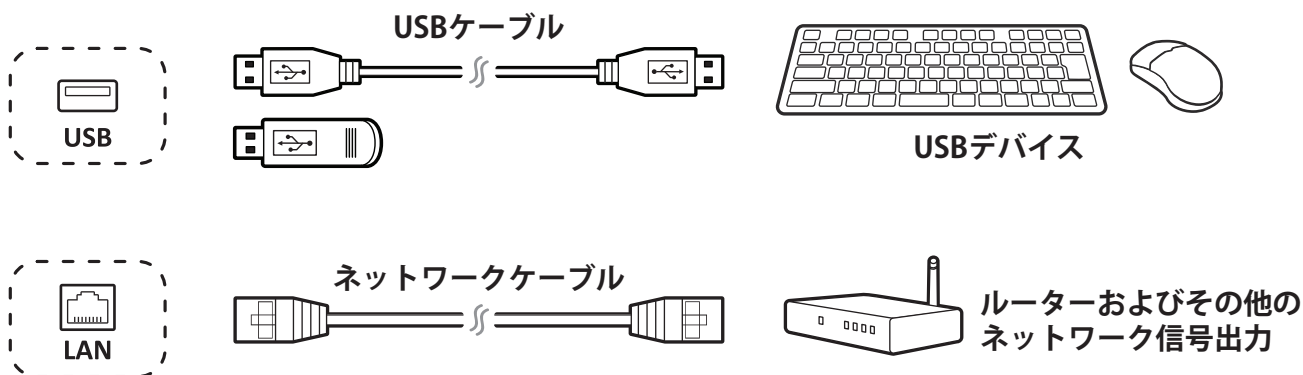

> 外部デバイスとタッチ接続

外部デバイスは、次の構成のいずれかで接続できます。

USB Type C 接続

USB Type C ケーブルを使って、外部デバイスを ViewBoard の USB Type C ポートに接続します。

DisplayPort 接続

1. DisplayPort ケーブルを使って、外部デバイスを ViewBoard の DisplayPort ポートに接続します。
2. USB ケーブルを使って、ViewBoard のタッチポートを外部デバイスに接続します。

HDMI 接続

1. HDMI ケーブルを使って、外部デバイスを ViewBoard の HDMI 入力ポートに接続します。
2. USB ケーブルを使って、ViewBoard のタッチポートを外部デバイスに接続します。

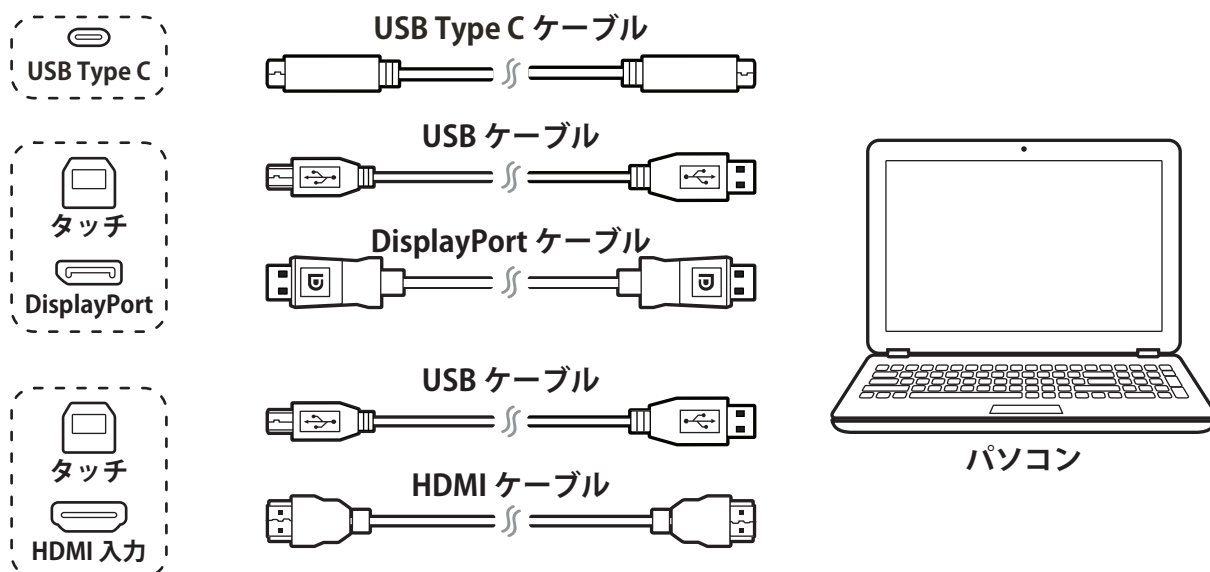

> RS232 接続

RS232 D-sub ケーブルを使用してディスプレイを外部パソコンに接続すると、電源のオン/オフ、または音量調整など、特定の機能をパソコンで制御できます。

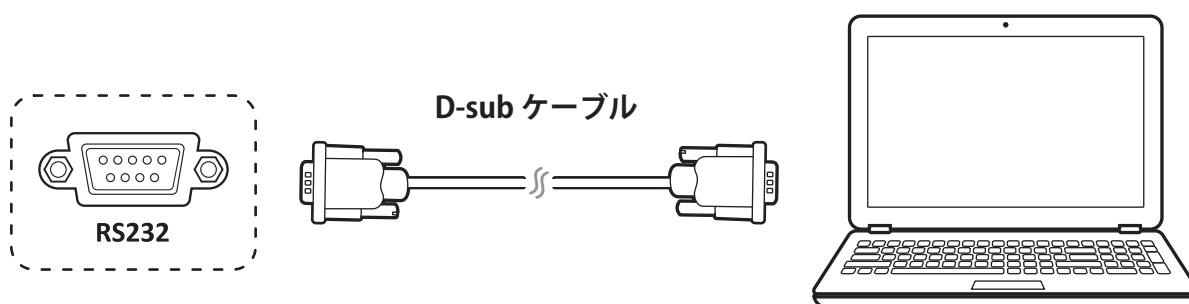

> 映像機器（オーディオおよびビデオ）接続

映像機器に接続するには：

1. HDMI ケーブルを使って、ViewBoard を映像機器の HDMI ポートに接続します。
2. ViewBoard の電源コードを差し込み、背面の電源スイッチをオンにします。
3. ViewBoard の右側にある電源ボタンを押して画面をオンにします。
4. リモコンの入力ボタンを押して、「HDMI」入力ソースに切り替えます。

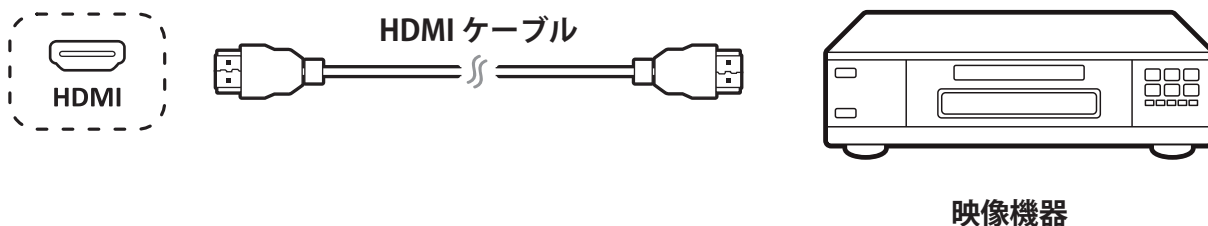

> S/PDIF 接続

外部サウンドシステムに接続するには：

1. 光ケーブルを使って、ViewBoard のS/PDIF ポートをサウンドシステムの光コネクタに接続します。
2. ViewBoard の電源コードを差し込み、背面の電源スイッチをオンにします。
3. ViewBoard の右側にある電源ボタンを押して画面をオンにします。

注意事項：

S/PDIF およびイヤホンオーディオ出力機能は、ViewBoard プレーヤー、HDMI、および DP チャンネルに対応します。

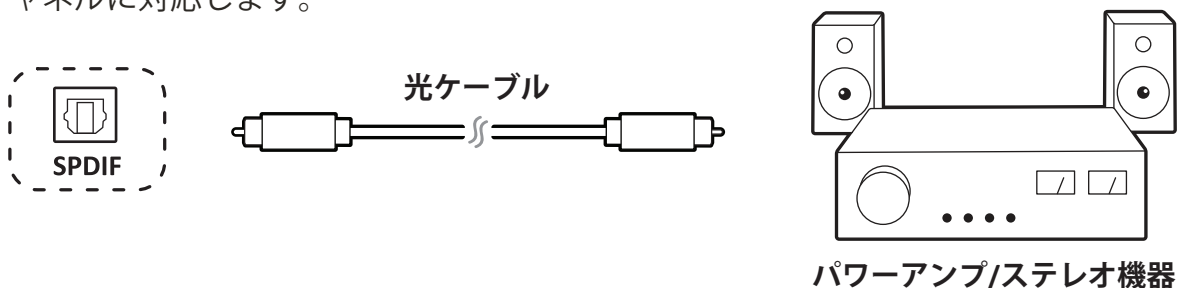

> ビデオ出力接続

ビデオをディスプレイ機器に出力するには：

1. HDMI ケーブルをディスプレイ機器の HDMI 入力ポートに接続し、もう一方を ViewBoard の HDMI 出力ポートに接続します。
2. オーディオケーブルの一方を ViewBoard のイヤホンポートに接続し、もう一方をスピーカーに接続します。
3. ViewBoard の電源コードを差し込み、背面の電源スイッチをオンにします。
4. ViewBoard の右側にある電源ボタンを押して画面をオンにします。

注意事項：

S/PDIFおよびイヤホンオーディオ出力は、ViewBoard プレーヤー、HDMI、および DP チャネルに対応します。



オーディオケーブル

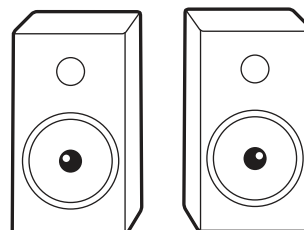

スピーカー

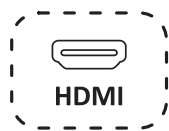

HDMI ケーブル

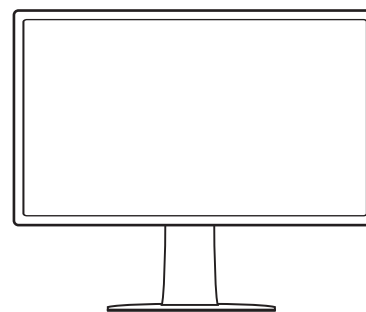
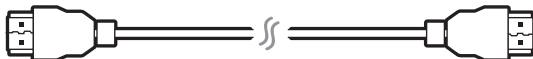

モニター

> 使用を開始する

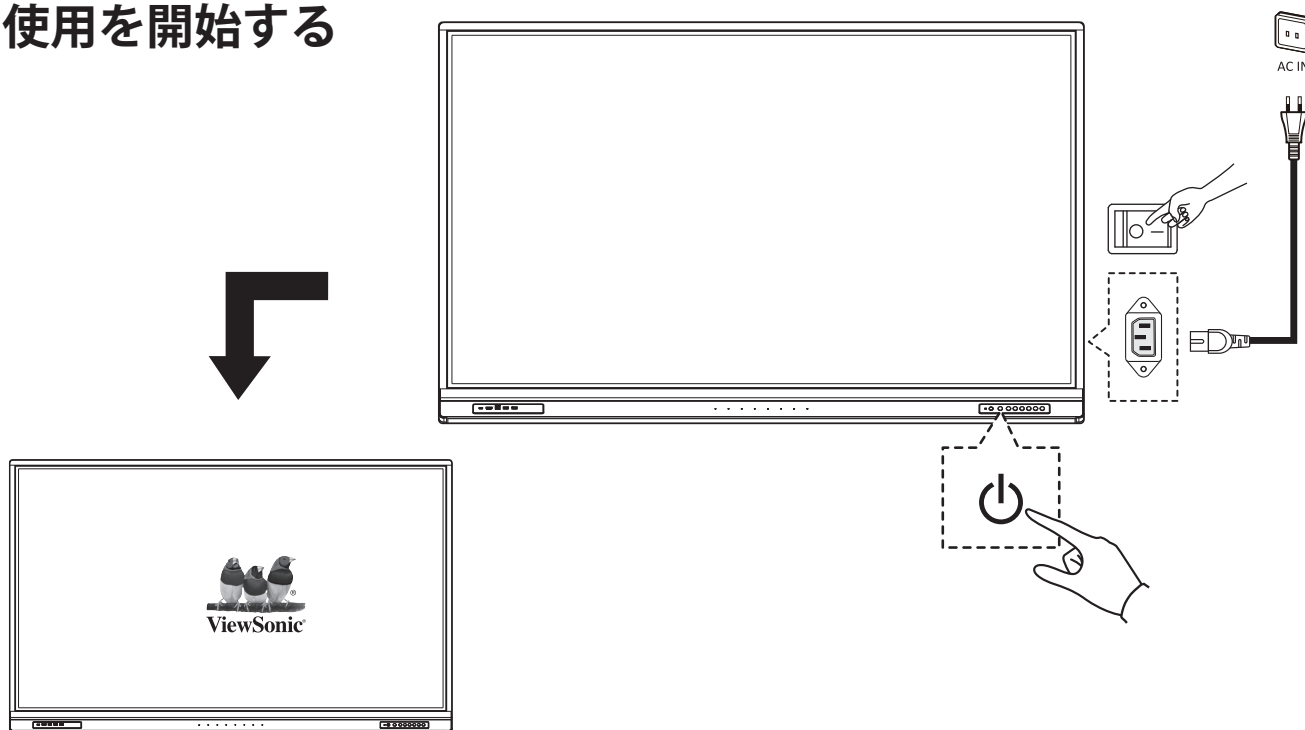

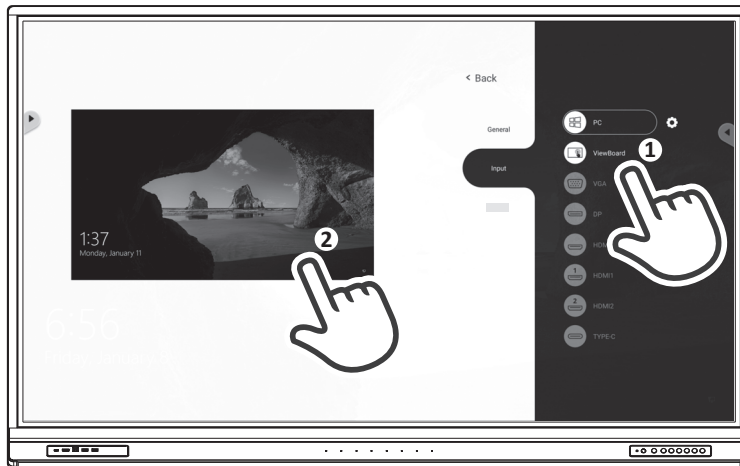

> コンプライアンス声明

FCCコンプライアンス声明: 本装置は、FCC規則パート15に準拠しています。操作は次の2つの条件に従うものとします：(1) 本装置は有害な干渉を引き起こさない場合があります。(2) 本装置は、望ましくない動作の原因となる干渉を含め、受信した干渉を受け入れなければなりません。

カナダ産業省ICES-003コンプライアンス: CAN ICES-3 (B)/NMB-3 (B)



ViewSonic カスタマーサポート

 : www.viewsonic.com/jp/support/



お問い合わせ

 050-3388-6832

 www.viewsonic.com/jp/contact/

 service@jp.viewsonic.com



ViewSonic
カスタマーサポートセンター

محتويات العلبة <

- دليل بدء تشغيل سريع
- بيان التوافق
- مهايئ RS232
- كبل طاقة (الشحن حسب المنطقة)
- عدد ٤ مسامير لكتيافة التثبيت بالحائط (M8x20mm x4)

- عدد ٢ بطارية AAA
- عدد ٢ قلم لمس
- وحدة تحكم عن بُعد
- ممحاة
- عدد ٤ مسامير كاميرا ويب
- (M4x7mm x2, M3x6mm x2)

- كبل HDMI (10ft/3m)
- كبل من نوع c (5ft/1.5m)
- كبل USB للمس (10ft/3m)
- عدد ٥ مشابك
- لوح كاميرا ويب

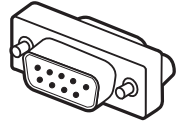
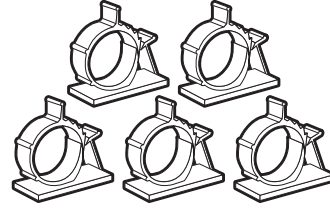
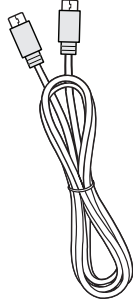
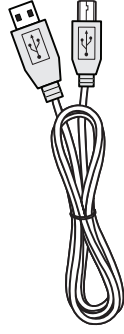
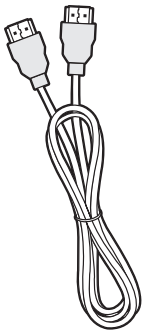
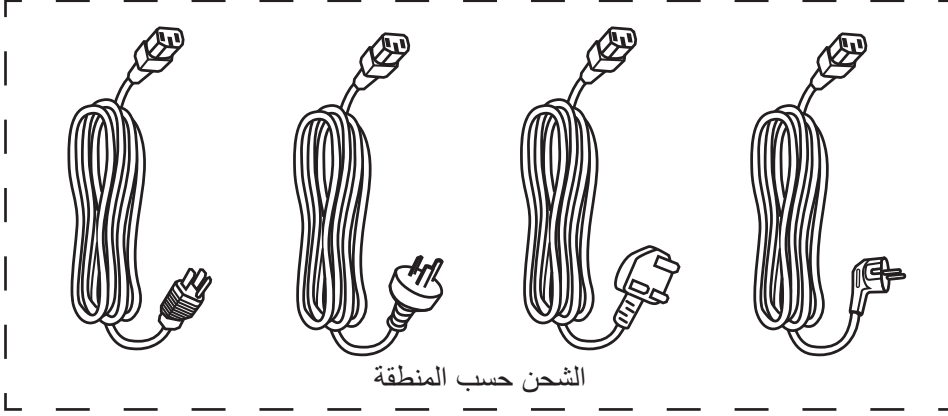

M8 X 4



M3 X 2



M4 X 2

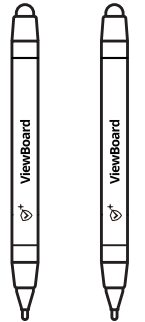
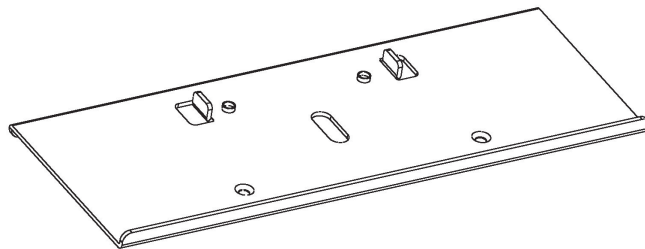
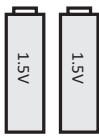
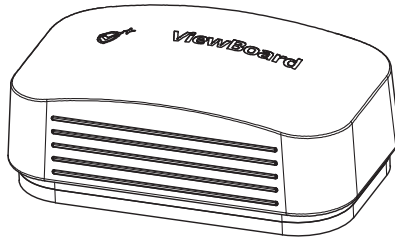

◀ مواصفات طاقم التثبيت بالحائط (تباع منفصلة)

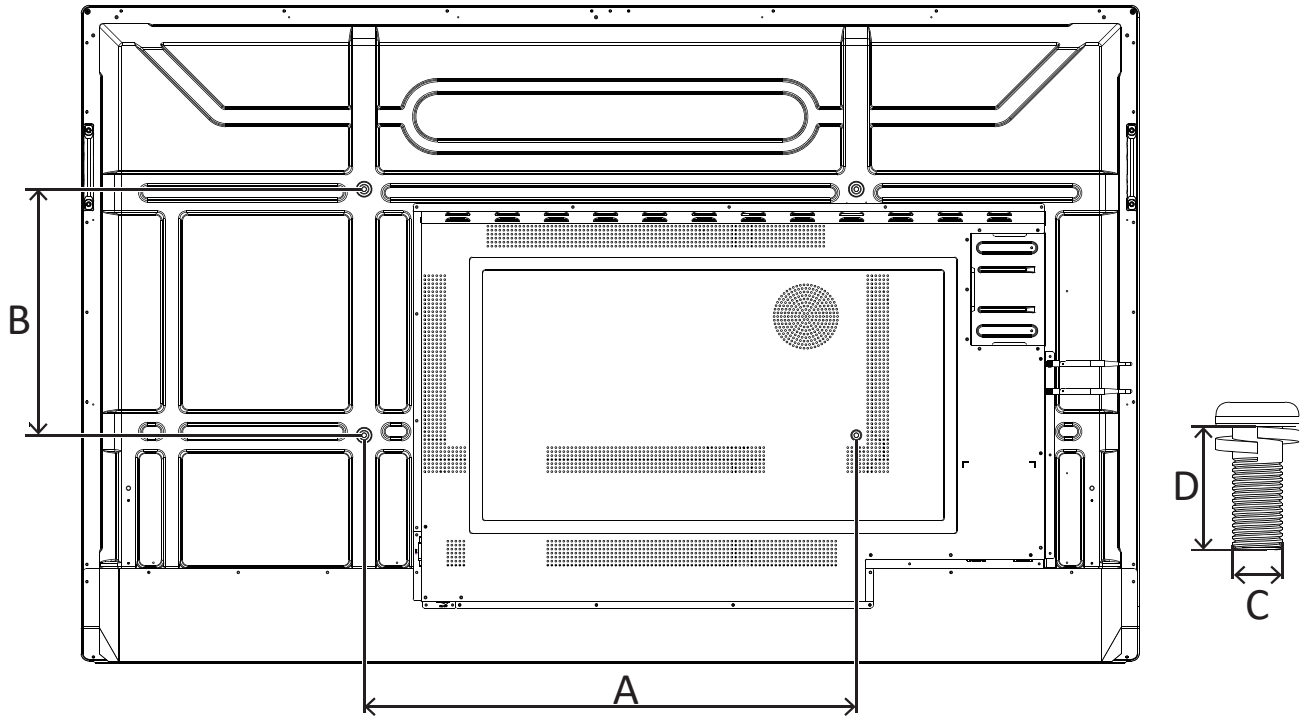

الكمية	برغي قياسي (C x D)	مواصفات VESA (A x B)	بوصة
٤	٢٠ x M8 مم	٤٠٠ x ٦٠٠ مم	سلسلة IFP6552
٤	٢٠ x M8 مم	٤٠٠ x ٨٠٠ مم	سلسلة IFP7552
٤	٢٠ x M8 مم	٦٠٠ x ٨٠٠ مم	سلسلة IFP8652

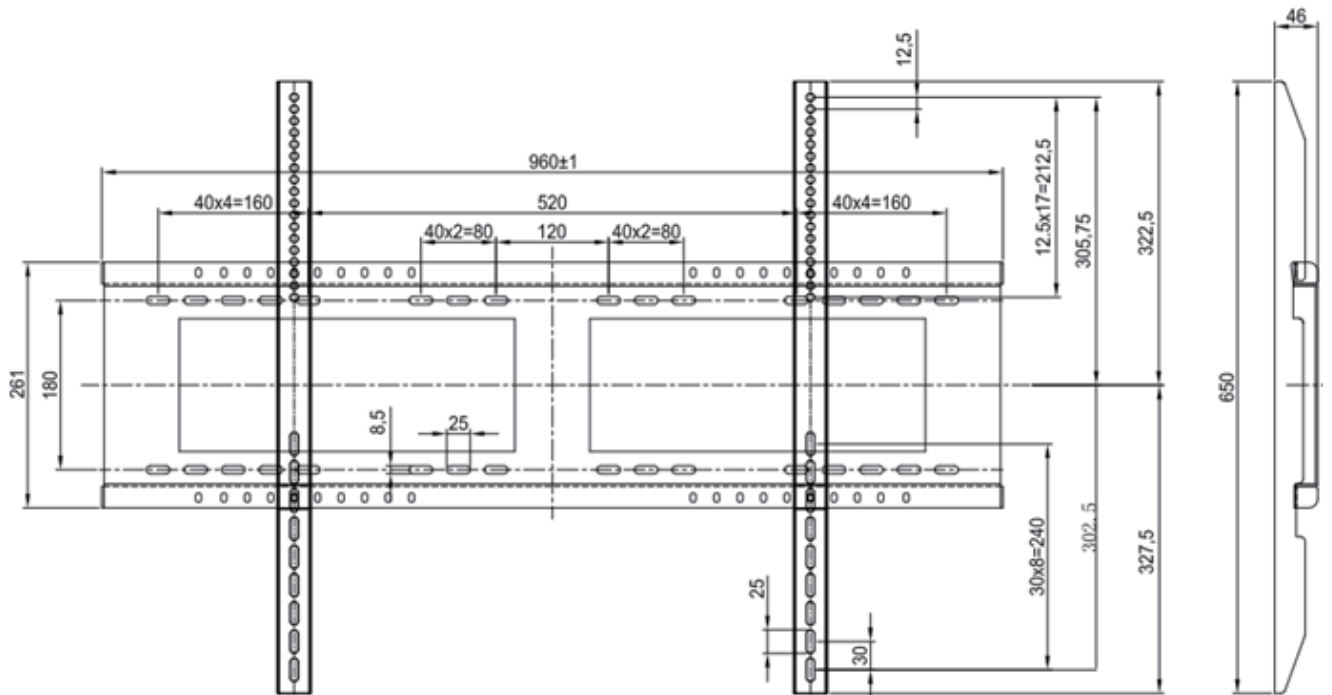

التبیهات الخاصة ببيئة التركيب

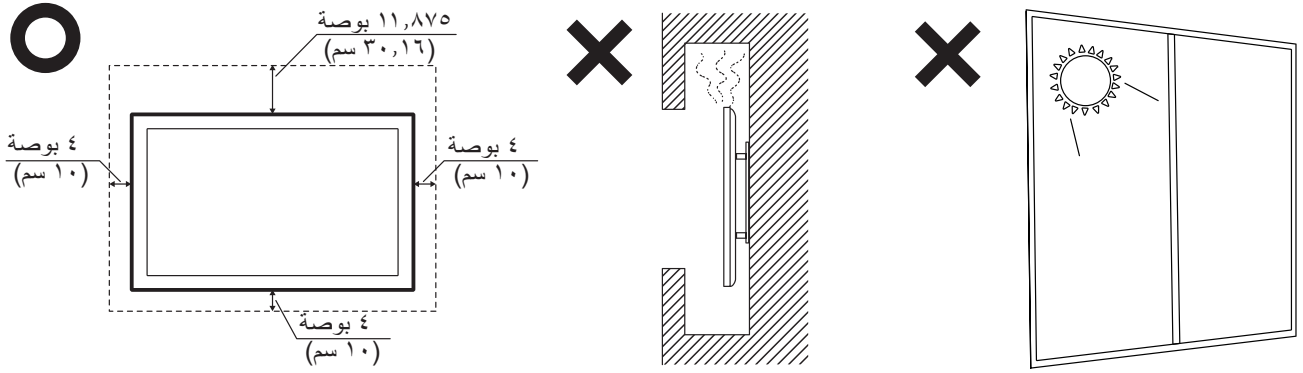

نظرة عامة على لوحة التحكم

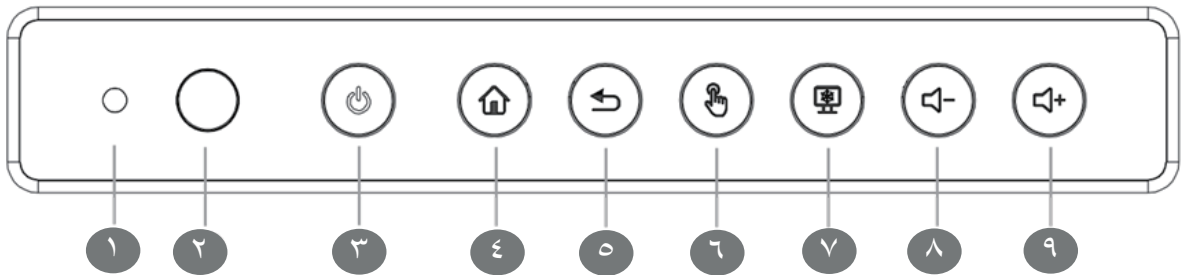

العنصر	الوصف
١	مستشعر إضاءة محيطية لمراقبة إضاءة البيئة المحيطة
٢	مستقبل أشعة وحدة التحكم عن بُعد
٣	مصباح مؤشر الطاقة اضغط على هذا المفتاح لتشغيل الجهاز اضغط على هذا المفتاح لإيقاف تشغيل الإضاءة الخلفية للشاشة أو تشغيلها اضغط مع الاستمرار على هذا المفتاح لإيقاف تشغيل الجهاز
٤	الرجوع إلى الواجهة الرئيسية لمشغل ViewBoard
٥	العودة إلى مستوى سابق لمشغل ViewBoard
٦	تعطيل شاشة اللمس أو تمكينها
٧	تجميد الصورة المعروضة حاليًا على الشاشة
٨	خفض مستوى الصوت
٩	رفع مستوى الصوت

← نظرة عامة على وحدة التحكم عن بُعد

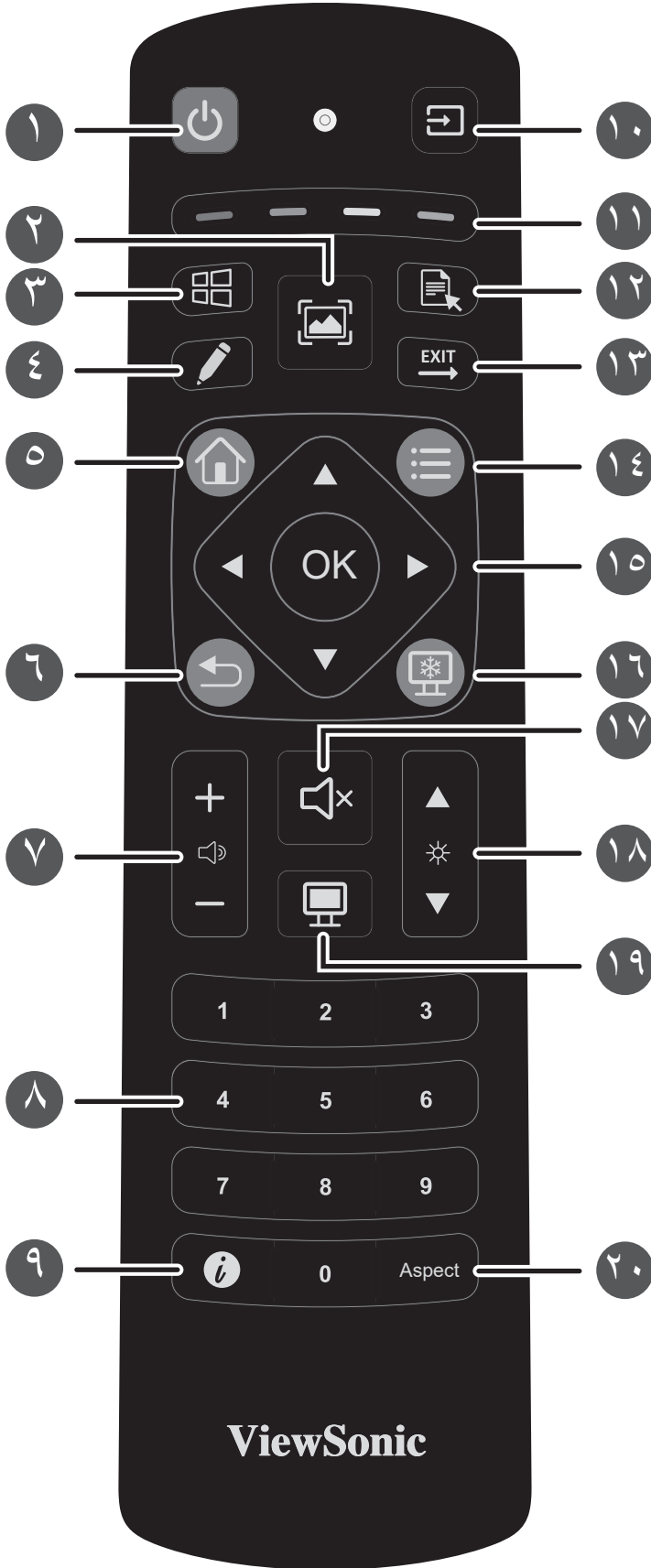

- ١ التشغيل/إيقاف التشغيل
- ٢ زر لقطة صورة الشاشة
- ٣ *الكمبيوتر الشخصي: زر "Windows"
- ٤ الكتابة عند بدء التشغيل
- ٥ الرجوع إلى الشاشة الرئيسية للمشغل المضمن
- ٦ الرجوع / العودة إلى الصفحة السابقة
- ٧ رفع / خفض مستوى الصوت
- ٨ لوحة مفاتيح الأرقام
- ٩ المعلومات
- ١٠ تحديد مصدر الدخل
- ١١ زر التحكم في الوسائط
أحمر: تشغيل/إيقاف مؤقت
أخضر: إيقاف
أصفر: تقديم للأمام
أزرق: إرجاع للخلف
- ١٢ *الكمبيوتر الشخصي: زر "القائمة"
- ١٣ *الكمبيوتر الشخصي: الخروج من مربع الحوار
- ١٤ قائمة الإعداد
- ١٥ مفاتيح الأسهم لأعلى/لأسفل/للليسار/لليمين/موافق
- ١٦ تجميد الشاشة
- ١٧ كتم الصوت / إلغاء كتم الصوت
- ١٨ رفع / خفض السطوع
*الكمبيوتر الشخصي: صفحة لأعلى / صفحة لأسفل
- ١٩ شاشة فارغة
- ٢٠ ضبط نسبة العرض إلى الارتفاع

*زر الكمبيوتر الشخصي: هذه الوظائف غير مدعومة في بعض الطرازات

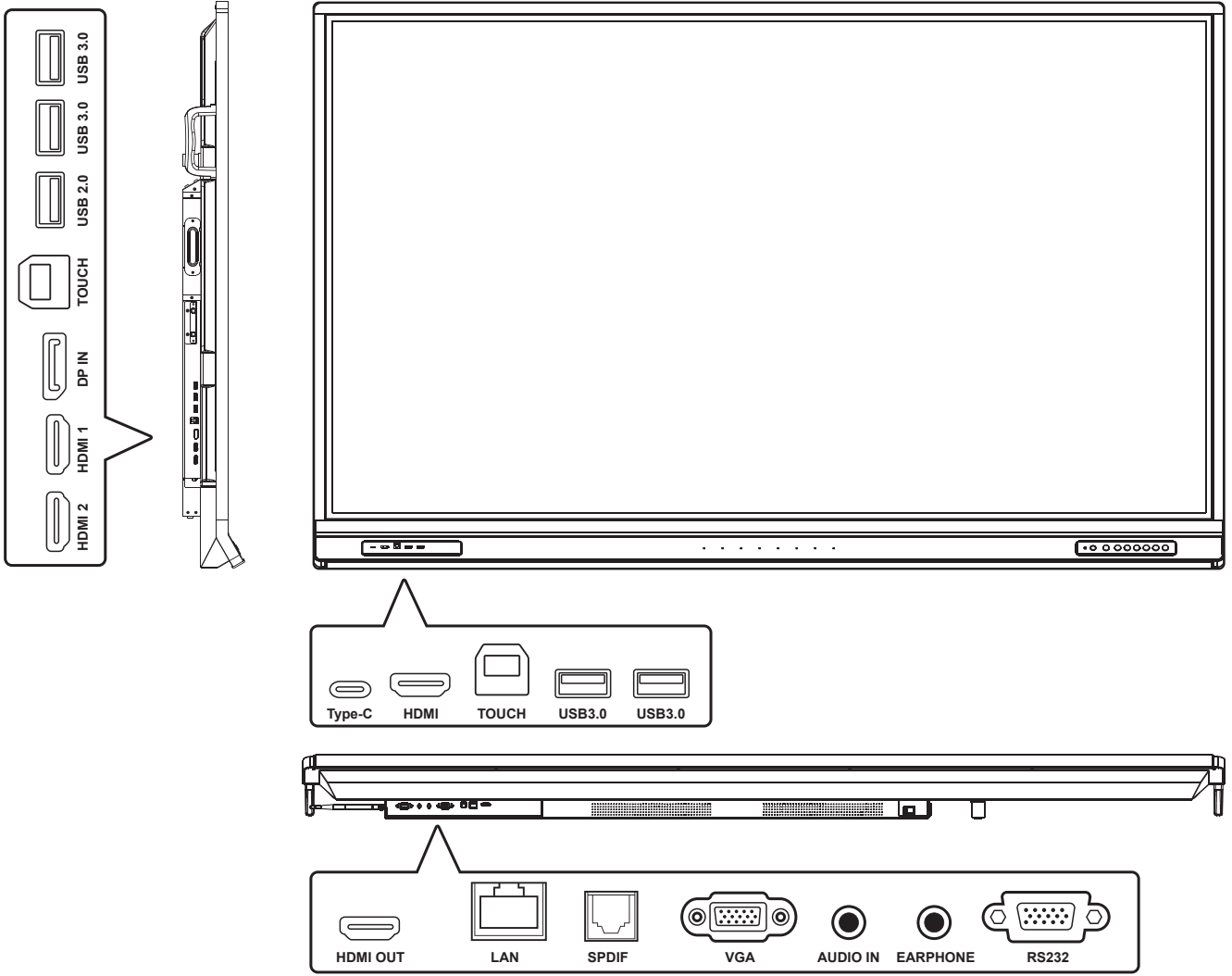

← توصيلات USB و بالشبكات

كما هو الحال تمامًا في أي جهاز كمبيوتر، من السهل توصيل عدة أجهزة USB وأجهزة طرفية أخرى بشاشة ViewBoard.

أجهزة USB الطرفية

وصِّل كبل جهاز USB بمنفذ USB.

كبلات المودم والشبكات

وصِّل كبل جهاز التوجيه (الراوتر) بمنفذ LAN.

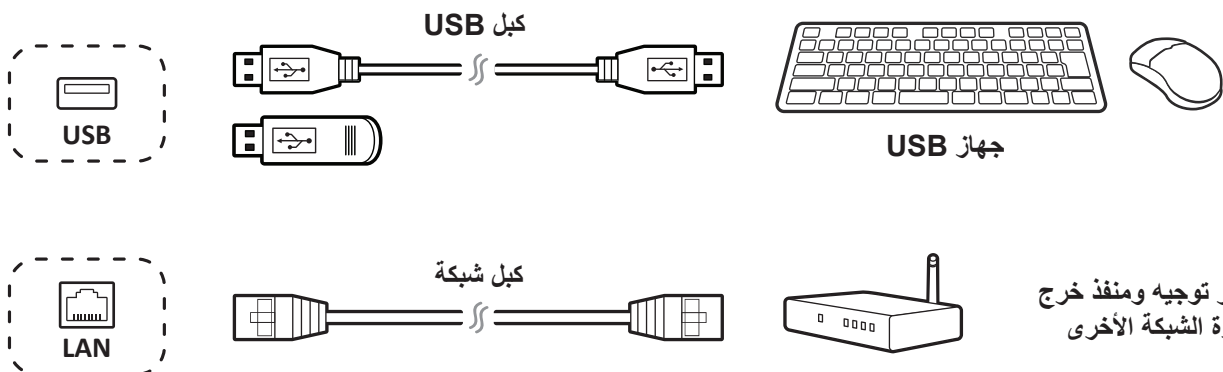

← توصيل أجهزة خارجية والتوصيل عبر منفذ اللمس

يمكن توصيل جهاز خارجي أو أجهزة خارجية باتباع أي من الطرق التالية:

التوصيل عبر كبل من نوع C

وصِّل كبلًا من نوع C من الجهاز الخارجي إلى منفذ من نوع C في ViewBoard.

توصيل DisplayPort

1- وصِّل كبل DisplayPort من الجهاز الخارجي إلى منفذ DisplayPort في ViewBoard.

2- وصِّل كبل USB بالجهاز الخارجي من منفذ اللمس TOUCH في ViewBoard.

توصيل HDMI

1- وصِّل كبل HDMI من الجهاز الخارجي إلى منفذ دخل HDMI IN في ViewBoard.

2- وصِّل كبل USB بالجهاز الخارجي من منفذ اللمس TOUCH في ViewBoard.

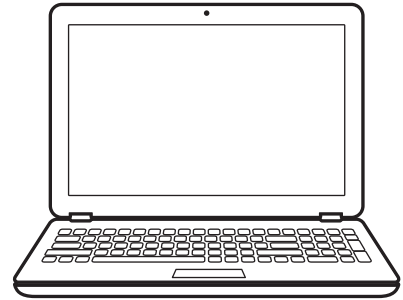
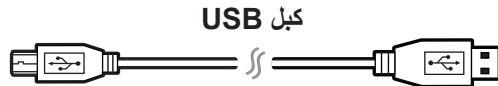
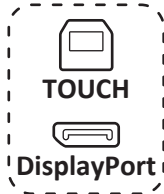
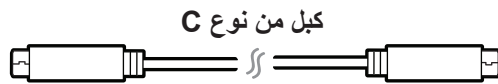

كمبيوتر

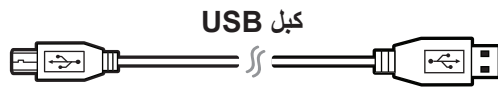
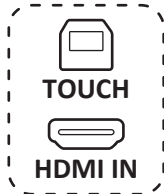

← توصيلات RS232

عند استخدام كبل المنفذ التسلسلي RS232 لتوصيل شاشتك بجهاز كمبيوتر خارجي، فإنه يمكن التحكم في بعض الوظائف عن طريق جهاز الكمبيوتر، بما في ذلك التشغيل / إيقاف التشغيل وضبط مستوى الصوت وغير ذلك المزيد.

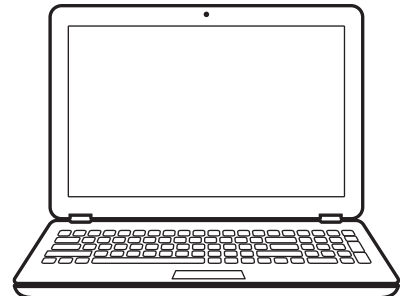
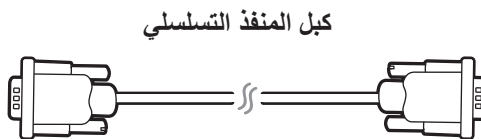
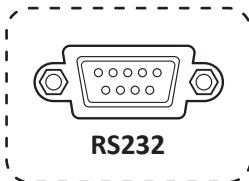

◀ توصيل مشغّل وسائط (صوت وفيديو)

لتوصيل مشغّل وسائط:

- 1- وصّل كبل HDMI بمنافذ HDMI في ViewBoard والجهاز الطرفي.
- 2- وصّل كبل طاقة ViewBoard وشغّل مفتاح إمداد الطاقة في اللوحة الخلفية.
- 3- اضغط على زر الطاقة في الجانب الأيمن من ViewBoard لتشغيل الشاشة.
- 4- اضغط على زر الدخل INPUT في وحدة التحكم عن بُعد ويُدلّ مصدر الدخل إلى "HDMI".

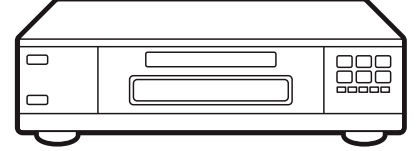
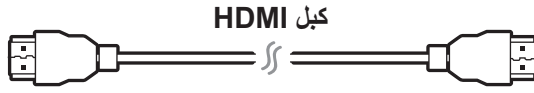

توصيل مشغّل وسائط

◀ توصيل SPDIF

للتوصيل بنظام صوت خارجي:

- 1- وصّل كبلًا صوتيًا من منفذ SPDIF إلى الموصل الصوتي في نظام الصوت.
- 2- وصّل كبل طاقة ViewBoard وشغّل مفتاح إمداد الطاقة في اللوحة الخلفية.
- 3- اضغط على زر الطاقة في الجانب الأيمن من ViewBoard لتشغيل الشاشة.

ملاحظة: لا يعمل خرج الصوت لكل من S/PDIF وسماعة الأذن إلا في قناة ViewBoard Player وHDMI وDP فقط.

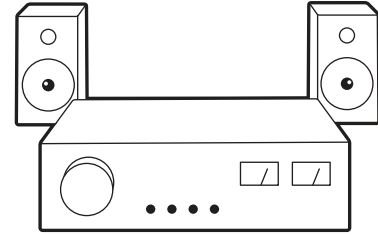
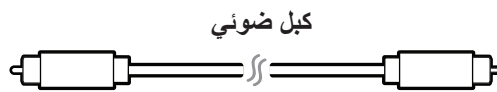

جهاز مضخم صوت/ستيريو

← توصيلات الفيديو

لإخراج فيديو عبر جهاز عرض:

- 1- وِصِل أحد طرفي كبل HDMI بمنفذ دخل HDMI IN في جهاز العرض، والطرف الآخر بمنفذ خرج HDMI OUT في ViewBoard.
- 2- بالنسبة إلى الصوت، وِصِل أحد طرفي كبل صوت بمنفذ خرج EARPHONE في ViewBoard والطرف الآخر بمكبرات الصوت.
- 3- وِصِل كبل طاقة ViewBoard وشغّل مفتاح إمداد الطاقة في اللوحة الخلفية.
- 4- اضغط على زر الطاقة في الجانب الأيمن من ViewBoard لتشغيل الشاشة.

ملاحظة: لا يعمل خرج الصوت لكل من S/PDIF وسماعة الأذن إلا في قناة ViewBoard Player وHDMI وDP فقط.

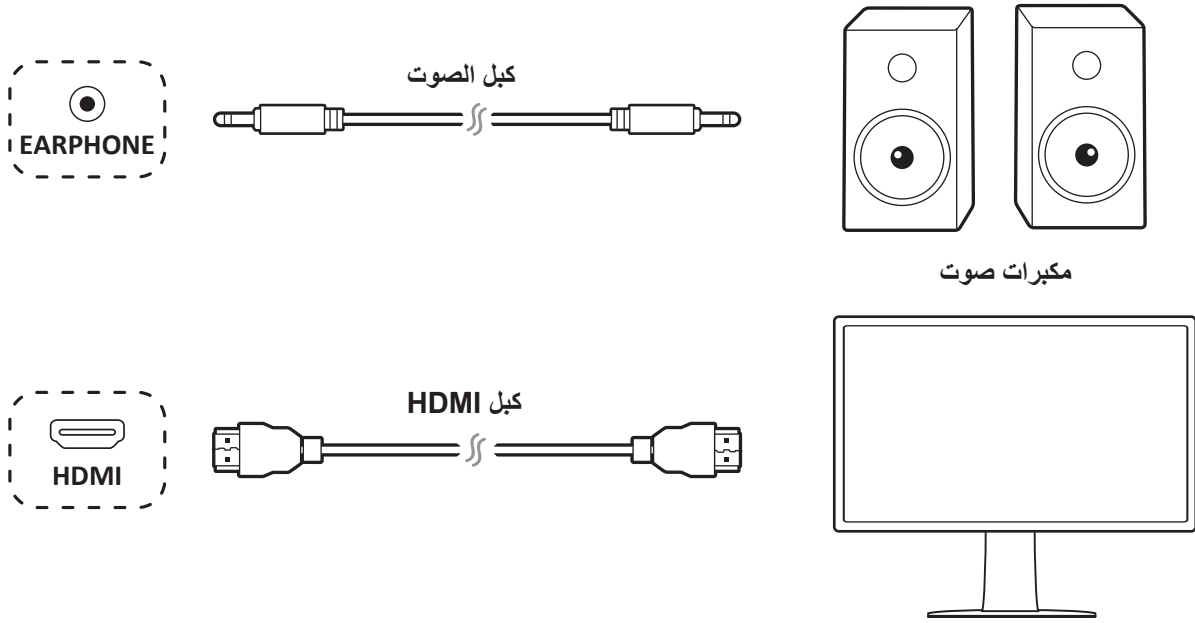

← بدء الاستخدام

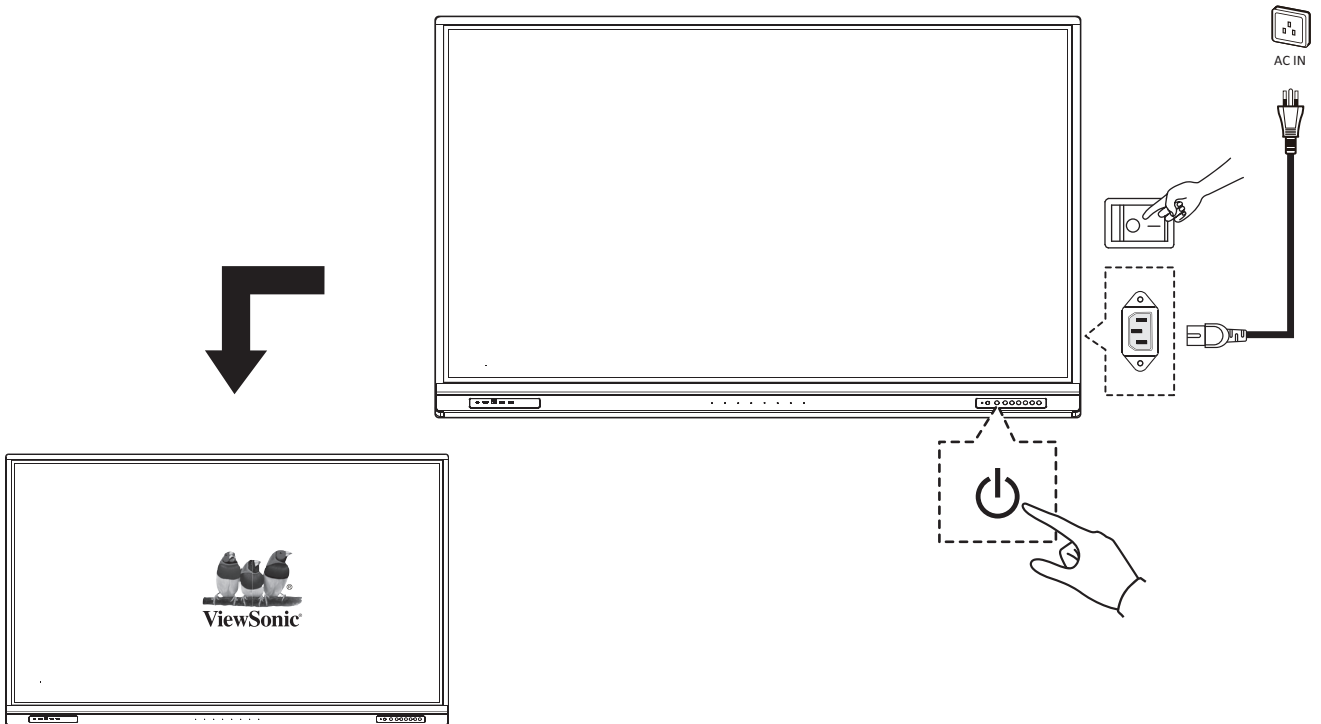



< بيان الامتثال

بيان لجنة الاتصالات الفيدرالية (FCC) لمعلومات التوافق: يتوافق هذا الجهاز مع الجزء ١٥ من قواعد لجنة الاتصالات الفيدرالية. ويخضع تشغيله إلى الشرطين التاليين: (١) ألا يتسبب هذا الجهاز في حدوث تداخل ضار، و(٢) أن يستقبل هذا الجهاز أي تداخل مستقبلي، بما في ذلك التداخل الذي قد يترتب عليه أوضاع تشغيل غير مرغوبة. معيار الامتثال ICES-003 للصناعة الكندية: CAN ICES-3 (B)/NMB-3(B)

شركة ViewSonic Corporation (الولايات المتحدة/كندا/أمريكا اللاتينية)
www.viewsonic.com/support/product-registraion : 



الولايات المتحدة الأمريكية

٦٦٨٨-٦٨٨-٨٠٠-١ 

customerservice@viewsonic.com 



كندا

٤٧٧٥-٤٦٣-٨٦٦-١ 

customerservice@viewsonic.com 

بورتوريكو وجزر فيرجن

<http://www.viewsonic.com/la/soporte/servicio-tecnico> (Español) 

أمريكا اللاتينية

<http://www.viewsonic.com/la/soporte/servicio-tecnico-la/> 



الملحق الاختياري



مركز دعم ViewSonic



ViewSonic®