

# Dell USB-C Monitor P2422HE/P2722HE

## User's Guide

**Model:** P2422HE/P2722HE  
**Regulatory model:** P2422HEb/P2422HEc/P2722HEt



 **NOTE:** A NOTE indicates important information that helps you make better use of your computer.

 **CAUTION:** A CAUTION indicates potential damage to hardware or loss of data if instructions are not followed.

 **WARNING:** A WARNING indicates a potential for property damage, personal injury, or death.

**Copyright © 2021 Dell Inc. or its subsidiaries. All rights reserved.** Dell, EMC, and other trademarks are trademarks of Dell Inc. or its subsidiaries. USB Type-C<sup>®</sup> and USB-C<sup>®</sup> are registered trademarks of USB Implementers Forum. Other trademarks may be trademarks of their respective owners.

2021 - 05

Rev. A00

# Contents

<b>About your monitor</b> . . . . .	<b>6</b>
Package contents . . . . .	6
Product features . . . . .	7
Identifying parts and controls . . . . .	9
Front view . . . . .	9
Back view . . . . .	10
Bottom view . . . . .	11
<b>Monitor specifications</b> . . . . .	<b>13</b>
<b>Resolution specifications</b> . . . . .	<b>14</b>
Supported video modes . . . . .	15
Preset display modes . . . . .	15
DP Multi-Stream Transport (MST) modes . . . . .	16
Electrical specifications . . . . .	16
Physical characteristics . . . . .	17
Environmental characteristics . . . . .	18
Pin assignments . . . . .	19
<b>Plug and play capability</b> . . . . .	<b>22</b>
<b>Universal Serial Bus (USB) interface</b> . . . . .	<b>22</b>
SuperSpeed USB 5 Gbps (USB3.2 Gen1) . . . . .	22
USB Type-C . . . . .	22
USB 3.2 downstream connector . . . . .	23
USB Type-C connector . . . . .	23
USB ports . . . . .	24
<b>RJ45 port (connector side)</b> . . . . .	<b>24</b>
Driver installation . . . . .	25
RJ45 connector LED status . . . . .	26
<b>LCD monitor quality and pixel policy</b> . . . . .	<b>26</b>



Maintenance guidelines . . . . .	27
Cleaning your monitor . . . . .	27
<b>Setting up the monitor . . . . .</b>	<b>28</b>
Attaching the stand . . . . .	28
Connecting your monitor . . . . .	31
Connecting the DisplayPort (DisplayPort to DisplayPort) cable. . . . .	32
Connecting the USB Type-C cable . . . . .	32
Connecting the HDMI cable (optional) . . . . .	32
Connecting the monitor for DP Multi-Stream Transport (MST) function . . . . .	33
Connecting the monitor for USB-C Multi-Stream Transport (MST) function . . . . .	33
Connecting the RJ45 cable (optional). . . . .	34
Dell Power Button Sync (DPBS) . . . . .	34
Connecting the monitor for DPBS for the first time . . . . .	37
Using DPBS function . . . . .	38
Connecting the monitor for USB-C Multi-Stream Transport (MST) function . . . . .	40
Connecting the monitor for USB-C . . . . .	41
Organizing your cables. . . . .	43
Removing the monitor stand . . . . .	43
VESA wall mounting (optional) . . . . .	44
<b>Operating the monitor . . . . .</b>	<b>45</b>
Power on the monitor . . . . .	45
Using the joystick control . . . . .	45
Using the On-Screen Display (OSD) menu . . . . .	46
Accessing the Menu Launcher . . . . .	46
Using the navigation keys . . . . .	47
Accessing the menu system . . . . .	48
OSD warning message . . . . .	59





Setting the maximum resolution . . . . .	64
Using the tilt, swivel, and vertical extension . . . . .	65
Tilt, swivel. . . . .	65
Vertical extension . . . . .	65
Rotating the monitor . . . . .	66
Rotate clockwise. . . . .	66
Rotate counterclockwise . . . . .	67
Adjusting the rotation display settings of your system . .	68
<b>Troubleshooting . . . . .</b>	<b>69</b>
Self-test. . . . .	69
Built-in diagnostics . . . . .	70
Common problems . . . . .	72
Product specific problems . . . . .	76
Universal Serial Bus (USB) specific problems . . . . .	78
<b>Appendix . . . . .</b>	<b>80</b>
FCC notices (U.S. only) and other regulatory information. . . . .	80
Contact Dell . . . . .	80
EU product database for energy label and product information sheet. . . . .	80





# About your monitor

## Package contents



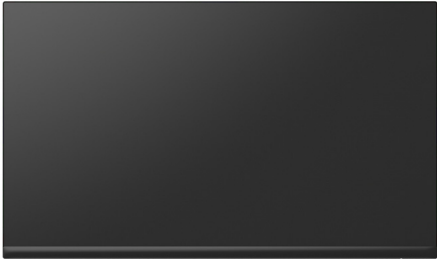

Your monitor ships with the components shown in the table below. If any component is missing, contact Dell technical support. For more information, see [Contact Dell](#).

 **NOTE: Some items may be optional and may not ship with your monitor. Some features may not be available in certain countries.**

 **NOTE: If you are attaching a stand that you purchased from any other source, follow the setup instructions that were included with the stand.**

	Display
	Stand riser
	Stand base



	Power cable (varies by country)
	DisplayPort to DisplayPort cable (1.8 meters)
	USB Type-C cable (1.8 meters)
	Cable tie
	<ul style="list-style-type: none"> <li>• Quick Setup Guide</li> <li>• Safety, Environmental, and Regulatory Information</li> </ul>

## Product features

The **Dell P2422HE/P2722HE** monitor has an active matrix, Thin-Film Transistor (TFT), Liquid Crystal Display (LCD) and LED backlight. The monitor features include:

- **P2422HE:** 60.47 cm (23.80 in.) viewable area (measured diagonally). 1920 x 1080 (16:9) resolution, plus full-screen support for lower resolutions.
- **P2722HE:** 68.60 cm (27 in.) viewable area (measured diagonally). 1920 x 1080 (16:9) resolution, plus full-screen support for lower resolutions.
- Wide viewing angle to allow viewing from a sitting or standing position.
- Color gamut of sRGB 99%.
- Digital connectivity with DisplayPort, USB Type-C and HDMI.



- Single USB Type-C to supply power (PD 65 W) to a compatible notebook while receiving video & data signal.
- Tilt, swivel, height, and rotate adjustment capabilities.
- Ultra-thin bezel minimizes the bezel gap in multi-monitor usage, enabling easier setup with an elegant viewing experience.
- Removable stand and Video Electronics Standards Association (VESA™) 100 mm mounting holes for flexible mounting solutions.
- Equipped with 1 USB Type-C upstream port and 4 SuperSpeed USB 5 Gbps (USB 3.2 Gen1) Type-A downstream ports.
- USB-C and RJ45 ports enable a single-cable, network-connected experience.
- Plug and play capability if supported by your system.
- On-Screen Display (OSD) adjustments for ease of set-up and screen optimization.
- Power and joystick buttons lock.
- Security lock slot.
- Stand lock.
- ≤ 0.3 W in Standby Mode.
- Optimize eye comfort with a flicker-free screen and low blue light feature.
- The monitor uses Low Blue Light panel and is in compliance with TUV Rheinland (Hardware Solution) at factory reset/default setting mode (**Preset mode: Standard**).

 **WARNING: The possible long-term effects of blue light emission from the monitor may cause damage to the eyes, including eye fatigue, digital eye strain, and so on. ComfortView Plus feature is designed to reduce the amount of blue light emitted from the monitor to optimize eye comfort.**



# Identifying parts and controls

## Front view



Label	Description
1	Power LED indicator Solid white light indicates that the monitor is turned on and functioning normally. Blinking white light indicates that the monitor is in Standby Mode.



## Back view



**Back view with monitor stand**

Label	Description	Use
<b>1</b>	VESA mounting holes (100 mm x 100 mm - behind attached VESA Cover)	Wall-mount the monitor using VESA-compatible wall mount kit (100 mm x 100 mm).
<b>2</b>	Regulatory label	Lists the regulatory approvals.
<b>3</b>	Stand release button	Releases stand from the monitor.
<b>4</b>	Barcode, serial number, and Service Tag label	Refer to this label if you need to contact Dell for technical support.
<b>5</b>	Power On/Off button	To turn the monitor on or off.
<b>6</b>	Joystick	Use to control the OSD menu. (For more Information, see <a href="#">Operating the monitor</a> )
<b>7</b>	Cable-management slot	Use to organize cables by inserting them through the slot.



## Bottom view

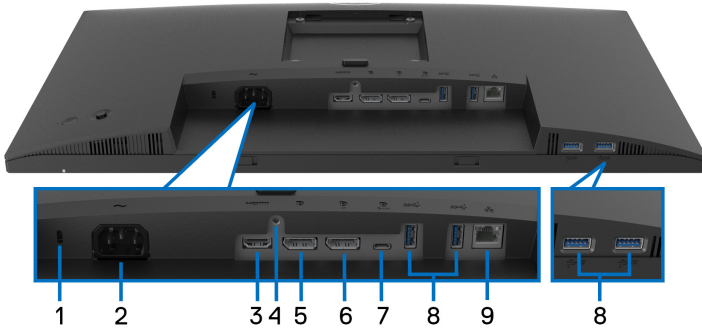

**Bottom view without monitor stand**

Label	Description	Use
1	Security lock slot	Secures the monitor with security lock (security lock not included).
2	Power connector	Connect the power cable (shipped with your monitor).
3	HDMI port	Connect your computer with the HDMI cable.
4	Stand lock	To lock the stand to the monitor using a M3 x 6 mm screw (screw not included).
5	DisplayPort (in)	Connect your computer with the DisplayPort cable (shipped with your monitor).
6	DisplayPort (out) 	DisplayPort output for MST (multi-stream transport) capable monitor. To enable MST, see <a href="#">Connecting the monitor for DP Multi-Stream Transport (MST) function</a> . <b>NOTE:</b> Remove the rubber plug when using DisplayPort out connector.



7	USB Type-C upstream port	<p>Connect the USB Type-C cable that came with your monitor to the computer. This port supports USB Power Delivery, Data, and DisplayPort video signal. The SuperSpeed USB 5 Gbps (USB 3.2 Gen1) Type-C port supports Alternate Mode DP1.2 with a maximum resolution of 1920 x 1080 at 60 Hz, PD 20 V/3.25 A, 15 V/3 A, 9 V/3 A, 5 V/3 A.</p> <p><b>NOTE:</b> USB Type-C is not supported on versions of Windows prior to Windows 10.</p>
8	SuperSpeed USB 5 Gbps (USB 3.2 Gen1) Type-A downstream port (4)	<p>Connect your USB device.*</p> <p><b>NOTE:</b> To use these ports, you must connect the USB Type-C cable (shipped with your monitor) to the USB Type-C upstream port on the monitor and to your computer.</p>
9	RJ45 port	<p>Connect the Internet. You can surf Internet via RJ45 only after you have connected the USB Type-C cable (shipped with your monitor) from the computer to the monitor.</p>

\*To avoid signal interference, when a wireless USB device has been connected to a USB downstream port, it is NOT recommended to connect any other USB devices to the adjacent port(s).





## Monitor specifications

Model	P2422HE	P2722HE
Screen type	Active matrix - TFT LCD	
Panel technology	In-Plane Switching Technology	
Aspect ratio	16:9	
Viewable image		
Diagonal	604.70 mm (23.80 in.)	686 mm (27 in.)
Width (active area)	527.04 mm (20.75 in.)	597.89 mm (23.54 in.)
Height (active area)	296.46 mm (11.67 in.)	336.31 mm (13.24 in.)
Total area	156246.27 mm <sup>2</sup> (242.15 in. <sup>2</sup> )	201076.38 mm <sup>2</sup> (311.67 in. <sup>2</sup> )
Pixel pitch	0.2745 mm x 0.2745 mm	0.3114 mm x 0.3114 mm
Pixel per inch (PPI)	93	82
Viewing angle	178° (vertical) typical 178° (horizontal) typical	
Luminance output	250 cd/m <sup>2</sup> (typical)	300 cd/m <sup>2</sup> (typical)
Contrast ratio	1000 to 1 (typical)	
Display screen coating	Anti-glare treatment of the front polarizer (3H) hard coating	
Color gamut	sRGB 99% (typical)	
Backlight	White LED edgelight system	
Response time	5 ms (Fast mode) 8 ms (Normal mode)	
Color depth	16.7 million colors (8 bit)	



Connectivity	<ul style="list-style-type: none"> <li>• 1 x HDMI port version 1.4 (HDCP 1.4)</li> <li>• 1 x DisplayPort version 1.2 (HDCP 1.4)</li> <li>• 1 x DisplayPort (Out) with MST (HDCP 1.4)</li> <li>• 1 x USB Type-C upstream port (Alternate mode with DisplayPort 1.2, Power Delivery PD up to 65 W)*</li> <li>• 4 x SuperSpeed USB 5 Gbps (USB 3.2 Gen1) downstream port</li> <li>• 1 x RJ45 port</li> </ul>	
Border width (edge of monitor to active area)	5.38 mm (Top)	5.99 mm (Top)
	5.38 mm (Left/Right)	6.01 mm (Left/Right)
	16.66 mm (Bottom)	17.29 mm (Bottom)
Adjustability		
Height adjustable stand	150 mm	
Tilt	-5° to 21°	
Swivel	-45° to 45°	
Pivot	-90° to 90°	
Cable management	Yes	
Dell Display Manager compatibility	Easy Arrange and other key features	
Security	Security lock slot (cable lock sold separately)	

\*DisplayPort and USB Type-C (Alternate mode with DisplayPort 1.2): HBR2 is supported.

## Resolution specifications

Model	P2422HE/P2722HE
Horizontal scan range	30 to 83 kHz
Vertical scan range	56 to 76 Hz (automatic)
Maximum preset resolution	1920 x 1080 @ 60 Hz



## Supported video modes

<b>Model</b>	<b>P2422HE/P2722HE</b>
Video display capabilities (HDMI & DisplayPort & USB Type-C alternate mode)	480p, 576p, 720p, 1080i, 1080p

## Preset display modes

<b>Display mode</b>	<b>Horizontal frequency (kHz)</b>	<b>Vertical frequency (Hz)</b>	<b>Pixel clock (MHz)</b>	<b>Sync polarity (Horizontal /Vertical)</b>
720 x 400	31.50	70.10	28.30	-/+
640 x 480	31.50	59.90	25.20	-/-
640 x 480	37.50	75.00	31.50	-/-
800 x 600	37.90	60.30	40.00	+/+
800 x 600	46.90	75.00	49.50	+/+
1024 x 768	48.40	60.00	65.00	-/-
1024 x 768	60.00	75.00	78.80	+/+
1152 x 864	67.50	75.00	108.00	+/+
1280 x 720	45.00	59.90	74.25	-/+
1280 x 720	56.50	74.80	95.75	-/+
1280 x 1024	64.00	60.00	108.00	+/+
1280 x 1024	80.00	75.00	135.00	+/+
1600 x 900-R	60.00	60.00	108.00	+/+
1920 x 1080	67.50	60.00	148.50	+/+



## DP Multi-Stream Transport (MST) modes

MST Source Monitor	Maximum number of external monitor that can be supported
	1920 x 1080 @ 60 Hz

 **NOTE: Maximum external monitor resolution supported is 1920 x 1080 60Hz only.**

## Electrical specifications

Model	P2422HE	P2722HE
Video input signals	<ul style="list-style-type: none"> <li>• HDMI 1.4/DisplayPort 1.2*, 600 mV for each differential line, 100 ohm input impedance per differential pair</li> <li>• USB-C (with Alternate mode) signal input support</li> </ul>	
AC input voltage/frequency/current	100 VAC to 240 VAC / 50 Hz or 60 Hz $\pm$ 3 Hz / 1.50 A (typical)	100 VAC to 240 VAC / 50 Hz or 60 Hz $\pm$ 3 Hz / 1.70 A (typical)
Inrush current	<ul style="list-style-type: none"> <li>• 120 V: 40 A (Max.) at 0°C (cold start)</li> <li>• 240 V: 80 A (Max.) at 0°C (cold start)</li> </ul>	
Power consumption	<ul style="list-style-type: none"> <li>• 0.2 W (Off mode)<sup>1</sup></li> <li>• 0.3 W (Standby Mode)<sup>1</sup></li> <li>• 14.5 W (On mode)<sup>1</sup></li> <li>• 118 W (Max.)<sup>2</sup></li> <li>• 14.79 W (Pon)<sup>3</sup></li> <li>• 48.02 kWh (TEC)<sup>3</sup></li> </ul>	<ul style="list-style-type: none"> <li>• 0.20 W (Off mode)<sup>1</sup></li> <li>• 0.20 W (Standby Mode)<sup>1</sup></li> <li>• 17.1 W (On mode)<sup>1</sup></li> <li>• 132 W (Max.)<sup>2</sup></li> <li>• 16.99 W (Pon)<sup>3</sup></li> <li>• 54.6 kWh (TEC)<sup>3</sup></li> </ul>

\*HBR2/DisplayPort 1.2 is supported.

<sup>1</sup> As defined in EU 2019/2021 and EU 2019/2013.

<sup>2</sup> Max brightness and contrast setting with maximum power loading on all USB ports.



<sup>3</sup> Pon: Power consumption of On mode as defined in Energy Star 8.0 version.  
 TEC: Total energy consumption in kWh as defined in Energy Star 8.0 version.

This document is informational only and reflects laboratory performance. Your product may perform differently, depending on the software, components and peripherals you ordered and shall have no obligation to update such information.

Accordingly, the customer should not rely upon this information in making decisions about electrical tolerances or otherwise. No warranty as to accuracy or completeness is expressed or implied.

 **NOTE: This monitor is ENERGY STAR certified. This product qualifies for ENERGY STAR in the factory default settings which can be restored by “Factory Reset” function in the OSD menu. Changing the factory default settings or enabling other features may increase power consumption that could exceed the ENERGY STAR specified limit.**



### Physical characteristics

Model	P2422HE	P2722HE
<b>Signal cable type</b>	<ul style="list-style-type: none"> <li>• Digital: DisplayPort, 20 pins</li> <li>• Digital: HDMI, 19 pins (cable not included)</li> <li>• Universal Series Bus: Type-C, 24 pins</li> </ul>	
<p><b>NOTE:</b> Dell monitors are designed to work optimally with the video cables that are shipped with your monitor. As Dell does not have control over the different cable suppliers in the market, the type of material, connector and process used to manufacture these cables, Dell does not guarantee video performance on cables that are not shipped with your Dell monitor.</p>		
<b>Dimensions (with stand)</b>		
Height (extended)	496.11 mm (19.53 in.)	534.15 mm (21.03 in.)
Height (compressed)	364.00 mm (14.33 in.)	384.15 mm (15.12 in.)
Width	537.80 mm (21.17 in.)	609.90 mm (24.01 in.)
Depth	179.57 mm (7.07 in.)	190.10 mm (7.48 in.)
<b>Dimensions (without stand)</b>		
Height	318.50 mm (12.54 in.)	359.60 mm (14.16 in.)



Width	537.80 mm (21.17 in.)	609.90 mm (24.01 in.)
Depth	52.15 mm (2.05 in.)	52.15 mm (2.05 in.)
<b>Stand dimensions</b>		
Height (extended)	410.80 mm (16.17 in.)	428.30 mm (16.86 in.)
Height (compressed)	364.00 mm (14.33 in.)	381.50 mm (15.02 in.)
Width	245.00 mm (9.65 in.)	268.00 mm (10.55 in.)
Depth	179.57 mm (7.07 in.)	190.10 mm (7.48 in.)
Base	245.00 x 173.00 mm (9.65 in. x 6.81 in.)	268.00 x 185.00 mm (10.55 in. x 7.28 in.)
<b>Weight</b>		
Weight with packaging	8.38 kg (18.47 lb)	9.62 kg (21.21 lb)
Weight with stand assembly and cables	6.00 kg (13.23 lb)	7.14 kg (15.74 lb)
Weight without stand assembly (For wall mount or VESA mount considerations - no cables)	3.81 kg (8.40 lb)	4.92 kg (10.85 lb)
Weight of stand assembly	1.76 kg (3.88 lb)	1.89 kg (4.17 lb)

## Environmental characteristics

Model	P2422HE	P2722HE
<b>Compliant standards</b>		
<ul style="list-style-type: none"> <li>ENERGY STAR certified monitor</li> <li>EPEAT registered where applicable. EPEAT registration varies by country. See <a href="http://www.epeat.net">www.epeat.net</a> for registration status by country.</li> <li>RoHS-compliant</li> <li>TCO and TCO Certified Edge Displays</li> <li>BFR/PVC free monitor (excluding external cables)</li> <li>Arsenic-free glass and Mercury-free for the panel only</li> </ul>		
<b>Temperature</b>		
Operating	0°C to 40°C (32°F to 104°F)	



Non-operating	<ul style="list-style-type: none"> <li>Storage: -20°C to 60°C (-4°F to 140°F)</li> <li>Shipping: -20°C to 60°C (-4°F to 140°F)</li> </ul>	
<b>Humidity</b>		
Operating	10% to 80% (non-condensing)	
Non-operating	<ul style="list-style-type: none"> <li>Storage: 5% to 90% (non-condensing)</li> <li>Shipping: 5% to 90% (non-condensing)</li> </ul>	
<b>Altitude</b>		
Operating	5,000 m (16,404 ft) (maximum)	
Non-operating	12,192 m (40,000 ft) (maximum)	
<b>Thermal dissipation</b>	<ul style="list-style-type: none"> <li>403.56 BTU/hour (maximum)</li> <li>49.59 BTU/hour (typical)</li> </ul>	<ul style="list-style-type: none"> <li>451.44 BTU/hour (maximum)</li> <li>58.48 BTU/hour (typical)</li> </ul>

## Pin assignments

### DisplayPort connector (in)

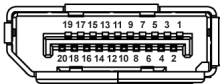

Pin number	20-pin side of the connected signal cable
<b>1</b>	ML3 (n)
<b>2</b>	GND
<b>3</b>	ML3 (p)
<b>4</b>	ML2 (n)
<b>5</b>	GND
<b>6</b>	ML2 (p)
<b>7</b>	ML1 (n)
<b>8</b>	GND
<b>9</b>	ML1 (p)
<b>10</b>	ML0 (n)
<b>11</b>	GND



<b>12</b>	ML0 (p)
<b>13</b>	GND
<b>14</b>	GND
<b>15</b>	AUX (p)
<b>16</b>	GND
<b>17</b>	AUX (n)
<b>18</b>	Hot Plug Detect
<b>19</b>	Re-PWR
<b>20</b>	+3.3 V DP_PWR

### DisplayPort connector (out)

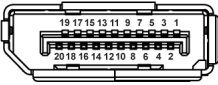

<b>Pin number</b>	<b>20-pin side of the connected signal cable</b>
<b>1</b>	ML0 (p)
<b>2</b>	GND
<b>3</b>	ML0 (n)
<b>4</b>	ML1 (p)
<b>5</b>	GND
<b>6</b>	ML1 (n)
<b>7</b>	ML2 (p)
<b>8</b>	GND
<b>9</b>	ML2 (n)
<b>10</b>	ML3 (p)
<b>11</b>	GND
<b>12</b>	ML3 (n)
<b>13</b>	CONFIG1
<b>14</b>	CONFIG2





<b>15</b>	AUX CH (p)
<b>16</b>	GND
<b>17</b>	AUX CH (n)
<b>18</b>	Hot Plug Detect
<b>19</b>	Return
<b>20</b>	DP_PWR

## HDMI connector

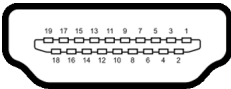

<b>Pin number</b>	<b>19-pin side of the connected signal cable</b>
<b>1</b>	TMDS DATA 2+
<b>2</b>	TMDS DATA 2 SHIELD
<b>3</b>	TMDS DATA 2-
<b>4</b>	TMDS DATA 1+
<b>5</b>	TMDS DATA 1 SHIELD
<b>6</b>	TMDS DATA 1-
<b>7</b>	TMDS DATA 0+
<b>8</b>	TMDS DATA 0 SHIELD
<b>9</b>	TMDS DATA 0-
<b>10</b>	TMDS CLOCK+
<b>11</b>	TMDS CLOCK SHIELD
<b>12</b>	TMDS CLOCK-
<b>13</b>	CEC
<b>14</b>	Reserved (N.C. on device)
<b>15</b>	DDC CLOCK (SCL)
<b>16</b>	DDC DATA (SDA)
<b>17</b>	DDC/CEC Ground
<b>18</b>	+5 V POWER
<b>19</b>	HOT PLUG DETECT



## Plug and play capability

You can install the monitor in any Plug and Play-compatible system. The monitor automatically provides the computer system with its Extended Display Identification Data (EDID) using Display Data Channel (DDC) protocols so that the system can configure itself and optimize the monitor settings. Most monitor installations are automatic; you can select different settings if desired. For more information about changing the monitor settings, see [Operating the monitor](#).

## Universal Serial Bus (USB) interface

This section gives you information about the USB ports that are available on the monitor.

### SuperSpeed USB 5 Gbps (USB3.2 Gen1)

Transfer speed	Data rate	Maximum power supported (each port)
SuperSpeed	5 Gbps	4.5 W
High speed	480 Mbps	4.5 W
Full speed	12 Mbps	4.5 W

### USB Type-C

USB Type-C	Description
Video	DisplayPort 1.2*
Data	SuperSpeed USB 5 Gbps (USB 3.2 Gen1)
Power Delivery (PD)	Up to 65 W

\*HBR2 is supported.



## USB 3.2 downstream connector



Pin number	9-pin side of the connector
1	VCC
2	D-
3	D+
4	GND
5	SSRX-
6	SSRX+
7	GND
8	SSTX-
9	SSTX+

## USB Type-C connector

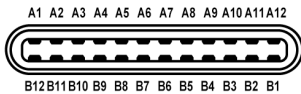

Pin Number	Signal Name	Pin Number	Signal Name
A1	GND	B1	GND
A2	TX1+	B2	TX2+
A3	TX1-	B3	TX2-
A4	VBUS	B4	VBUS
A5	CC1	B5	CC2
A6	D+	B6	D+
A7	D-	B7	D-
A8	SBU1	B8	SBU2
A9	VBUS	B9	VBUS



A10	RX2-	B10	RX1-
A11	RX2+	B11	RX1+
A12	GND	B12	GND

## USB ports

- 1 USB Type-C upstream - bottom
- 4 SuperSpeed USB 5 Gbps (USB 3.2 Gen1) Type-A downstream - bottom

**NOTE: SuperSpeed USB 5 Gbps (USB 3.2 Gen1) functionality requires a SuperSpeed USB 5 Gbps (USB 3.2 Gen1)-capable computer.**

**NOTE: The USB ports on the monitor work only when the monitor is turned On or in Standby mode. If you turn Off the monitor and then turn it On, the attached peripherals may take a few seconds to resume normal functionality.**

## RJ45 port (connector side)

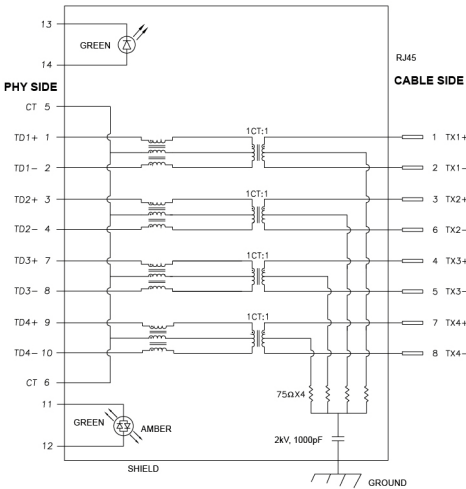

Pin number	Signal
1	TD1 +
2	TD1 -
3	TD2 +



4	TD2 -
5	CT
6	CT
7	TD3 +
8	TD3 -
9	TD4 +
10	TD4 -
11	GREEN_AMBER
12	GREEN_AMBER
13	GREEN
14	GREEN

### Driver installation

Install the Realtek USB GBE Ethernet Controller Driver available for your system. This is available for download at [www.dell.com/support](http://www.dell.com/support) under the “Driver and download” section.

Network (RJ45) data rate via USB-C max speed is 1000 Mbps.

 **NOTE: This LAN port is 1000Base-T IEEE 802.3az compliant, supporting Mac Address (Printed on model label) Pass-thru (MAPT), Wake-on-LAN (WOL) from standby mode (S3 only) and UEFI\* PXE Boot function, these 3 features depend on BIOS setting and OS version.**

\*UEFI stands for Unified Extensible Firmware Interface.



## RJ45 connector LED status



Label	LED	Color	Description
1	Left LED	Green	Link/Activity indicator: <ul style="list-style-type: none"><li>• Blinking - Activity on the port.</li><li>• Green On - Link is being established.</li><li>• Off - Link is not established.</li></ul>
2	Right LED	Amber or Green	Speed indicator: <ul style="list-style-type: none"><li>• Amber On - 1000 Mbps</li><li>• Green On - 100 Mbps</li><li>• Off - 10 Mbps</li></ul>

 **NOTE: The RJ45 cable is non in-box standard accessory.**

## LCD monitor quality and pixel policy

During the LCD Monitor manufacturing process, it is not uncommon for one or more pixels to become fixed in an unchanging state which are hard to see and do not affect the display quality or usability. For more information on Dell Monitor Quality and Pixel Policy, see [www.dell.com/pixelguidelines](http://www.dell.com/pixelguidelines).



## Maintenance guidelines

### Cleaning your monitor

 **CAUTION:** Read and follow the [Safety instructions](#) before cleaning the monitor.

 **WARNING:** Before cleaning the monitor, unplug the monitor power cable from the electrical outlet.



For best practices, follow the instructions in the list below when unpacking, cleaning, or handling your monitor:

- To clean your anti-static screen, lightly dampen a soft, clean cloth with water. If possible, use a special screen-cleaning tissue or solution suitable for the anti-static coating. Do not use benzene, thinner, ammonia, abrasive cleaners, or compressed air.
- Use a lightly-dampened, warm cloth to clean the monitor. Avoid using detergent of any kind as some detergents leave a milky film on the monitor.
- If you notice white powder when you unpack your monitor, wipe it off with a cloth.
- Handle your monitor with care as a darker-colored monitor may get scratched and show white scuff marks more than a lighter-colored monitor.
- To help maintain the best image quality on your monitor, use a dynamically changing screen saver and turn off your monitor when not in use.



# Setting up the monitor

## Attaching the stand

-  **NOTE: The stand is not installed at the factory when shipped.**
-  **NOTE: The following instructions are applicable only for attaching the stand that was shipped with your monitor. If you are attaching a stand that you purchased from any other source, follow the setup instructions that were included with the stand.**

To attach the monitor stand:

1. Follow the instructions on the flaps of carton to remove the stand from the cushion that secures it.
2. Remove the stand base and stand riser from the packaging cushion.

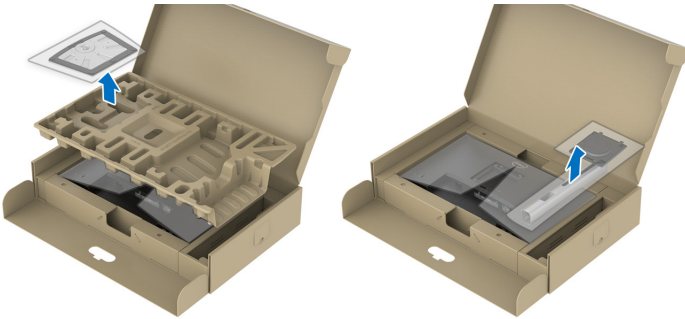

-  **NOTE: The graphics are used for the purpose of illustration only. The appearance of the package cushion may vary.**

3. Insert the stand base blocks fully into the stand slot.
4. Lift the screw handle and turn the screw clockwise.
5. After fully tightening the screw, fold the screw handle flat within the recess.

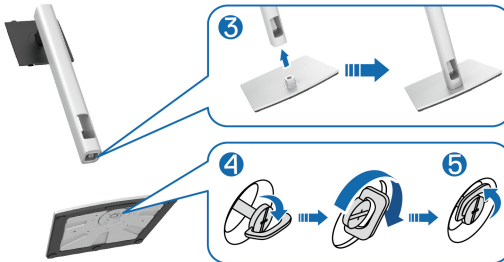



6. Lift the cover, as shown, to access the VESA area for stand assembly.



**NOTE:** Before attaching the stand assembly to the display, ensure that the front plate flap is opened to allow space for assembly.

7. Attach the stand assembly to the display.

- a. Fit the two tabs on the upper part of the stand to the groove on the back of the display.
- b. Press the stand down till it snaps into place.



8. Hold the stand riser and lift the monitor carefully, then place it on a flat surface.

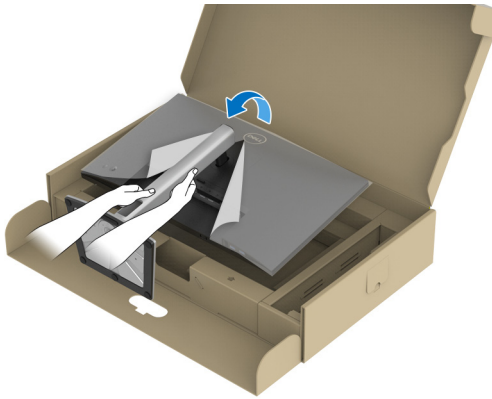

**NOTE: Lift the monitor carefully to prevent it from slipping or falling.**

9. Remove the cover from the monitor.

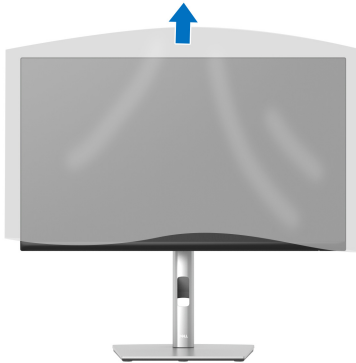

## Connecting your monitor

**⚠ WARNING:** Before you begin any of the procedures in this section, follow the [Safety instructions](#).

**✎ NOTE:** Dell monitors are designed to work optimally with Dell supplied inbox cables. Dell does not guarantee the video quality and performance when using non-Dell cables.

**✎ NOTE:** Route the cables through the cable-management slot before connecting them.

**✎ NOTE:** Do not connect all cables to the computer at the same time.

**✎ NOTE:** The graphics are used for the purpose of illustration only. The appearance of the computer may vary.

To connect your monitor to the computer:

1. Turn Off your computer and disconnect the power cable.
2. Route the power cable through the cable-management slot on the stand and then connect it to the monitor.



3. Connect the DisplayPort, USB Type-C, or HDMI cable from your monitor to the computer.



## Connecting the DisplayPort (DisplayPort to DisplayPort) cable

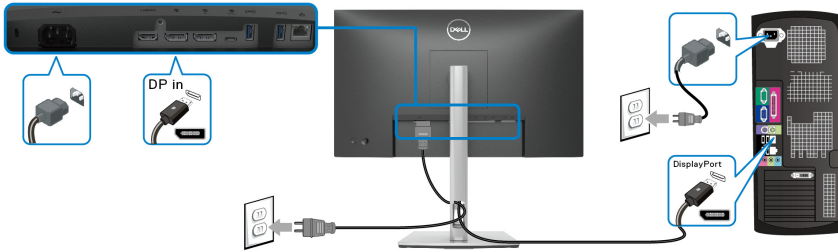

## Connecting the USB Type-C cable

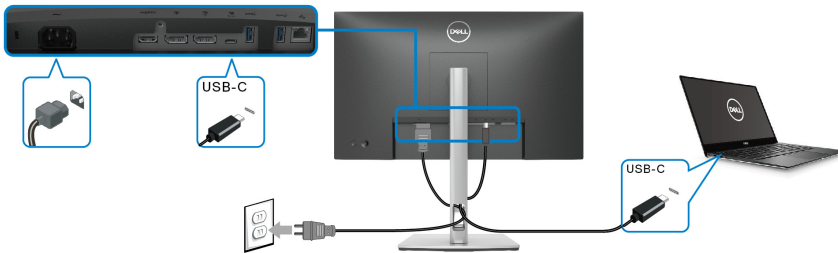

### **NOTE: Use the USB Type-C cable shipped with monitor only.**

- This port supports DisplayPort Alternate Mode (DP1.2 standard only).
- The USB Type-C power delivery compliant port (PD Version 3.0) delivers up to 65 W of power.
- If your notebook requires more than 65 W to operate and the battery is drained, it may not be powered up or charged with the USB PD port of this monitor.

## Connecting the HDMI cable (optional)

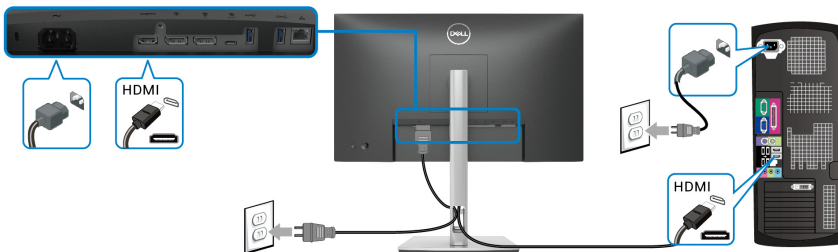

## Connecting the monitor for DP Multi-Stream Transport (MST) function

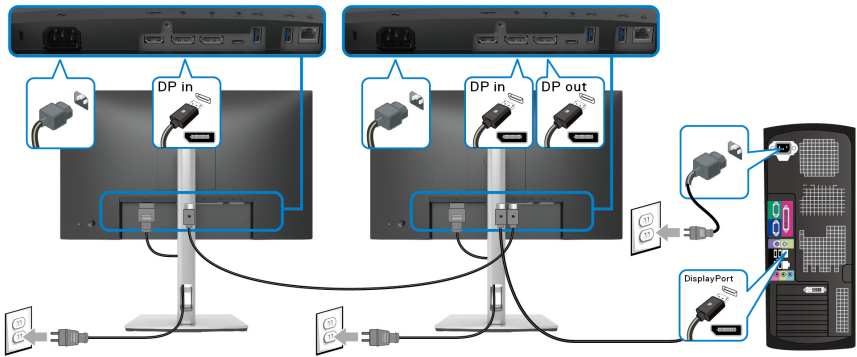

**NOTE:** This monitor supports the DP MST feature. To make use of this feature, your PC Graphics Card must be certified to DP1.2 with MST option.

**NOTE:** Remove the rubber plug when using DP out connector.

## Connecting the monitor for USB-C Multi-Stream Transport (MST) function

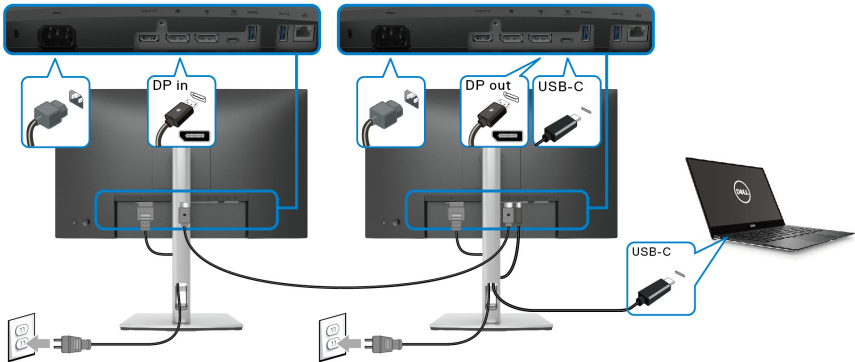

**NOTE:** The maximum number of supported monitors via MST is subjected to the bandwidth of the USB-C source.

**NOTE:** Remove the rubber plug when using the DP out connector.



## Connecting the RJ45 cable (optional)

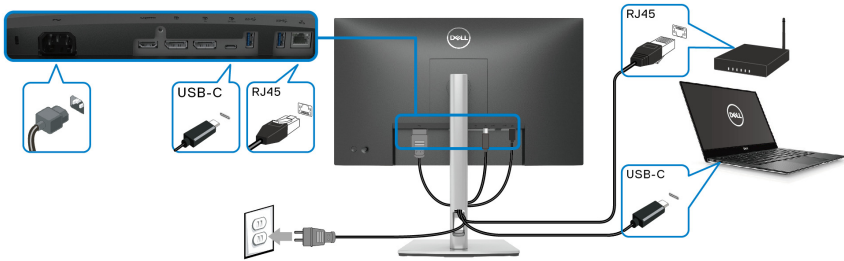

**NOTE:** The RJ45 cable is not an in-box standard accessory.

## Dell Power Button Sync (DPBS)

Your monitor is designed with Dell Power Button Sync (DPBS) feature to allow you to control PC system power state from the monitor power button. This feature is only supported with Dell platform which has built-in DPBS function, and is only supported over USB-C interface.

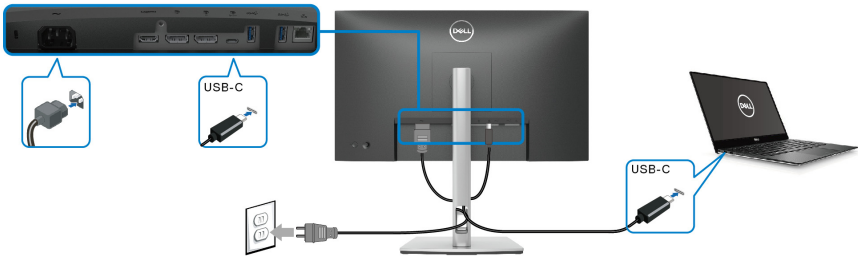

To make sure the DPBS function works for the first time, perform the following steps on the DPBS supported platform in the **Control Panel** first.

**NOTE:** DPBS only supports the USB Type-C upstream port.



## 1. Go to **Control Panel**.

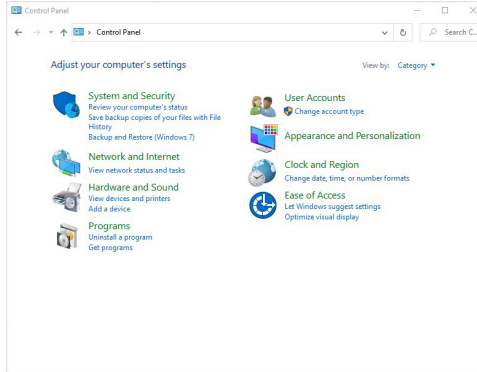

## 2. Select **Hardware and Sound**, followed by **Power Options**.

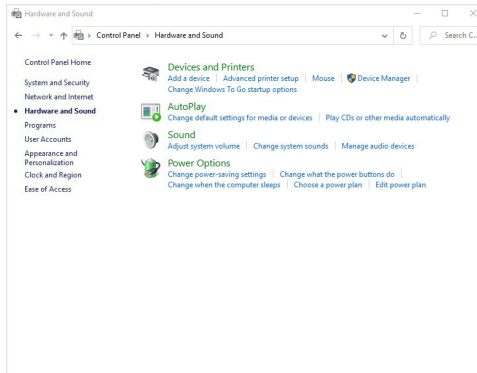

## 3. Go to **System Settings**.

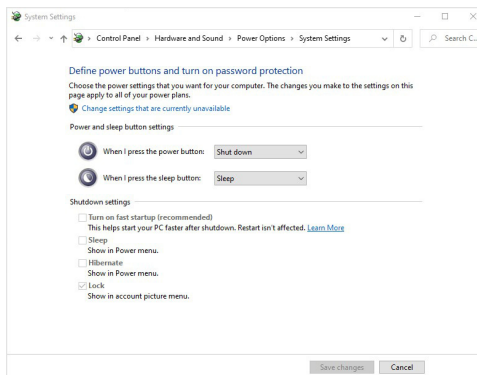

4. In the drop-down menu of **When I press the power button**, there are a few options for selection, namely **Do nothing/Sleep/Hibernate/Shut down**. You can select **Sleep/Hibernate/Shut down**.

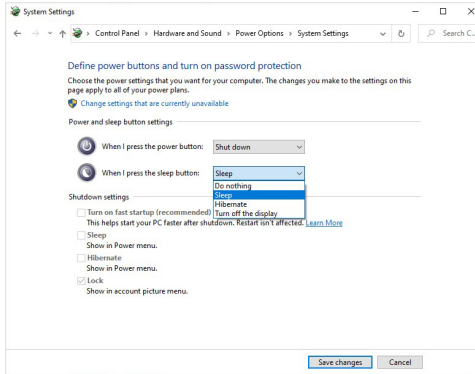
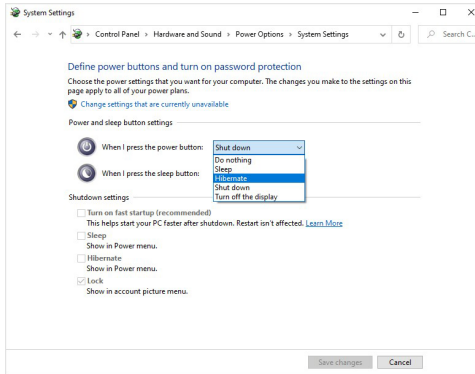

**NOTE:** Do not select “Do nothing”, otherwise the monitor power button will not be able to sync with PC system power state.





## Connecting the monitor for DPBS for the first time

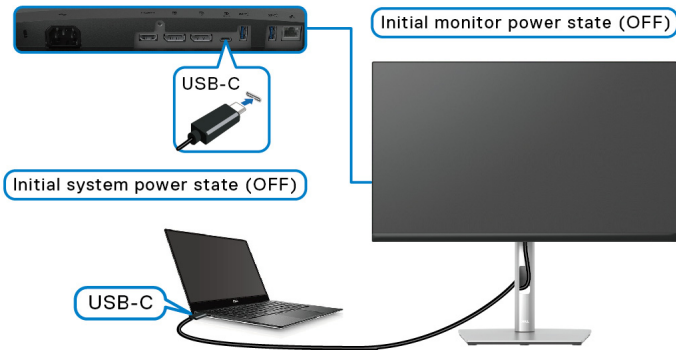

For the first time setting up the DPBS function:

1. Make sure both the PC and the monitor are OFF.
2. Press the monitor power button to turn ON the monitor.
3. Connect the USB-C cable from the PC to the monitor.
4. Both the monitor and PC will turn ON normally except Dell Optiplex 7090/3090 Ultra platform.
5. When you connect the Dell Optiplex 7090/3090 Ultra platform, you may see both the monitor and PC will turn ON momentarily. Wait for a while (approximately 6 seconds) and both the PC and monitor will turn OFF. When you press either the monitor power button or PC power button, both the PC and monitor will turn ON. The PC system power state is in sync with the monitor power button.

**NOTE:** When the monitor and PC are both at power OFF state for the first time, it is recommended that you turn ON the monitor first, then connect the USB-C cable from the PC to the monitor.

**NOTE:** You can power the Dell PC\* Ultra platform using its DC adaptor jack. Alternatively, you can power the Dell PC\* Ultra platform using the monitor's USB-C cable via Power Delivery (PD); please set USB-C Charging  65W to On in Off Mode.

\*Ensure to check the Dell PC for DPBS supportability.



## Using DPBS function

### Waking on the USB-C cable

When you connect the USB-C cable, the Monitor/PC state is as follows:

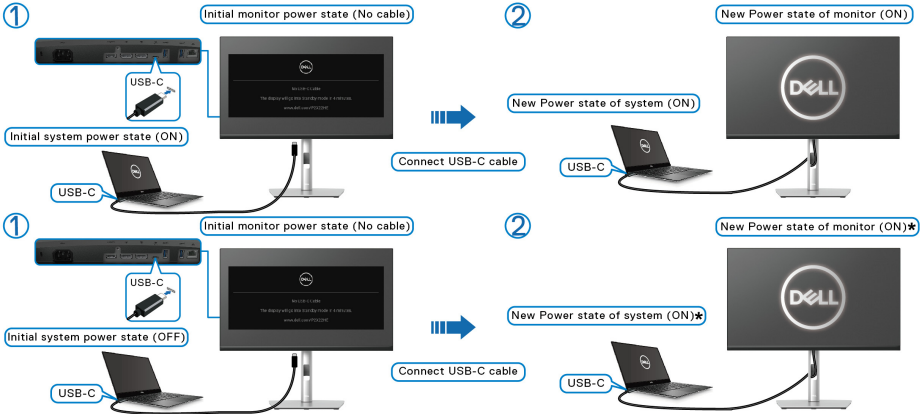

**\*Not all Dell PC systems support to wake up the platform via the monitor.**

When you press the monitor power button or PC power button, the Monitor/PC state is as follows:

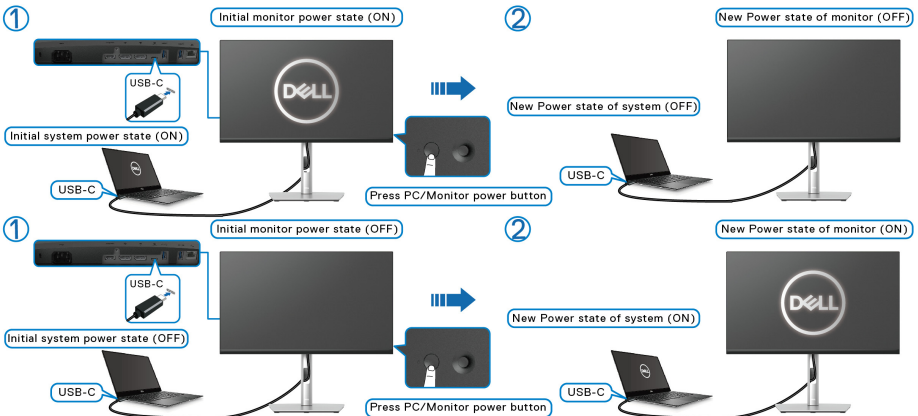

- When the monitor and the PC power state are both ON, **press and hold the monitor power button for 4 seconds**, the screen prompt will ask if you would like to shut down the PC.

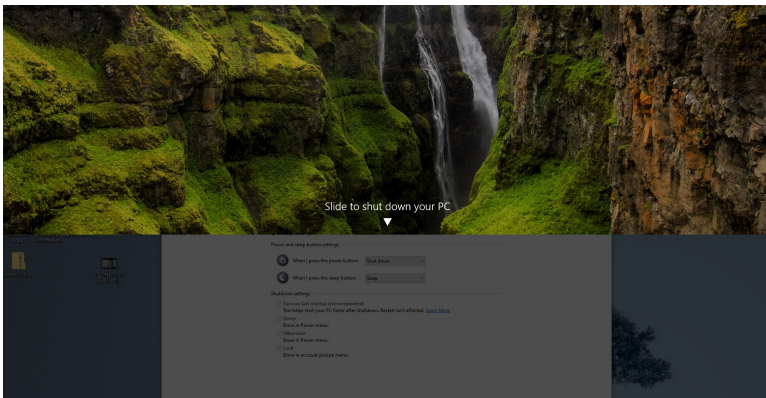
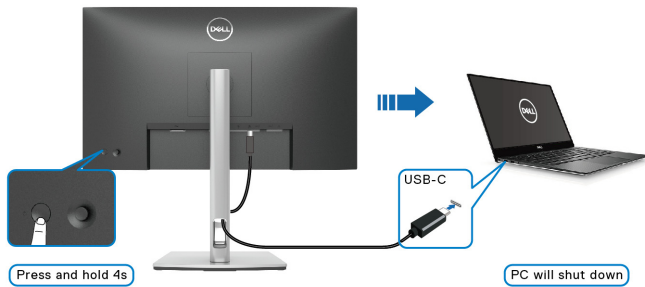

- When the monitor and the PC power state are both ON, **press and hold the monitor power button for 10 seconds**, the PC will shut down.

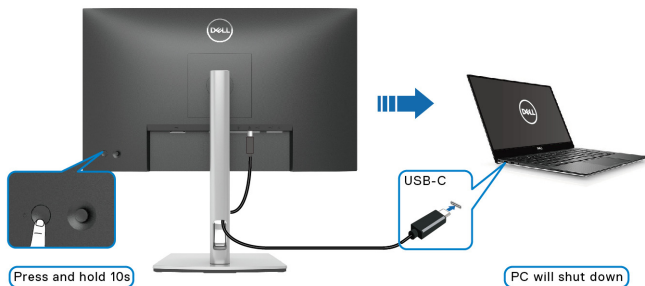

## Connecting the monitor for USB-C Multi-Stream Transport (MST) function

A PC is connected to two monitors in an initial OFF power state, and the PC system power state is in sync with Monitor 1 power button. When you press Monitor 1 or PC power button, both Monitor 1 and PC turns ON. Meanwhile, Monitor 2 will remain OFF. You need to manually press the power button on Monitor 2 to turn it ON.

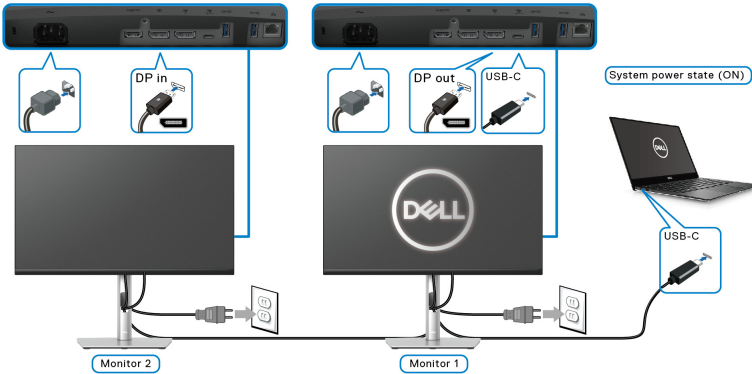

Similarly, a PC is connected to two monitors in an initial ON power state, and the PC system power state is in sync with Monitor 1 power button. When you press Monitor 1 or PC power button, both Monitor 1 and PC turns OFF. Meanwhile, Monitor 2 will be in Standby mode. You need to manually press the power button on Monitor 2 to turn it OFF.

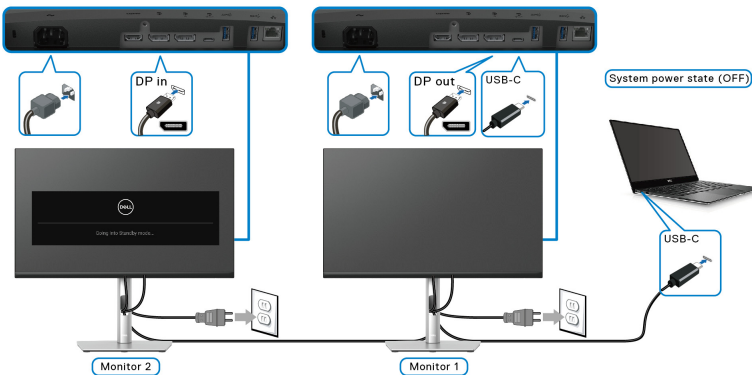

## Connecting the monitor for USB-C

The Dell PC\* Ultra platform has two USB-C ports, so both Monitor 1 and Monitor 2 power state can sync with the PC.

When the PC and two monitors are in an initial ON power state, pressing the power button on Monitor 1 or Monitor 2 will turn OFF the PC, Monitor 1, and Monitor 2.

\*Ensure to check the Dell PC for DPBS supportability.

**NOTE: DPBS only supports the USB Type-C upstream port.**

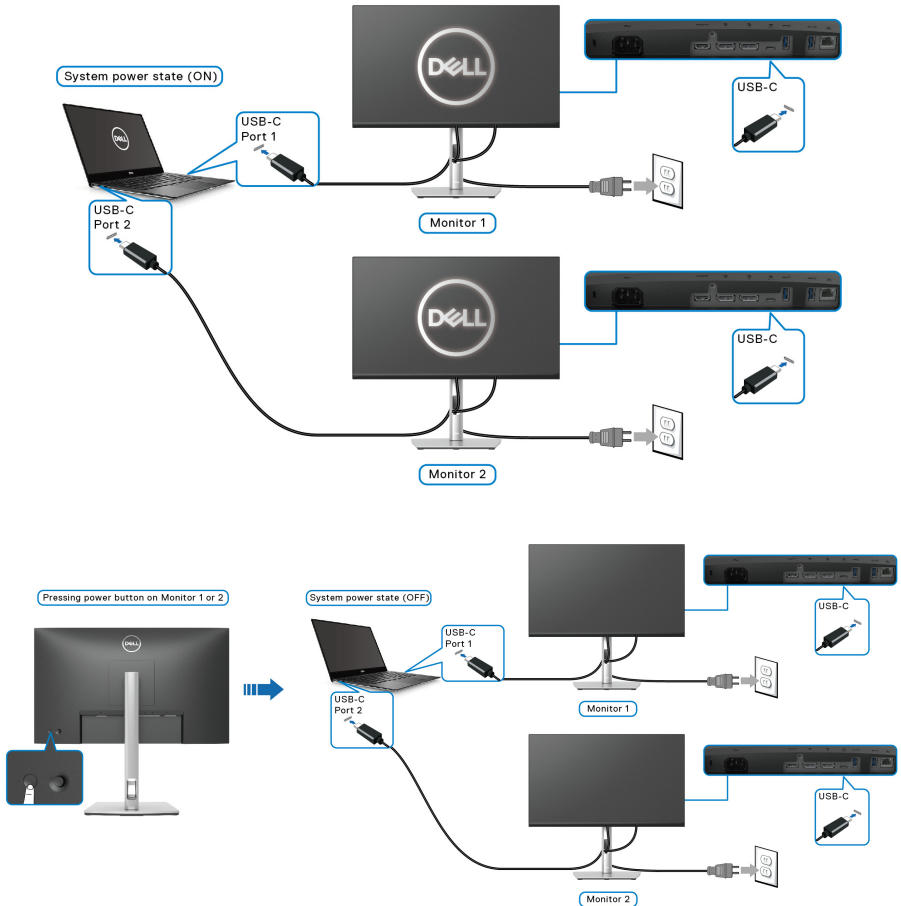

Ensure to set **USB-C Charging 65W to On in Off Mode**. When the PC and two monitors are in an initial OFF power state, pressing the power button on Monitor 1 or Monitor 2 will turn ON the PC, Monitor 1, and Monitor 2.

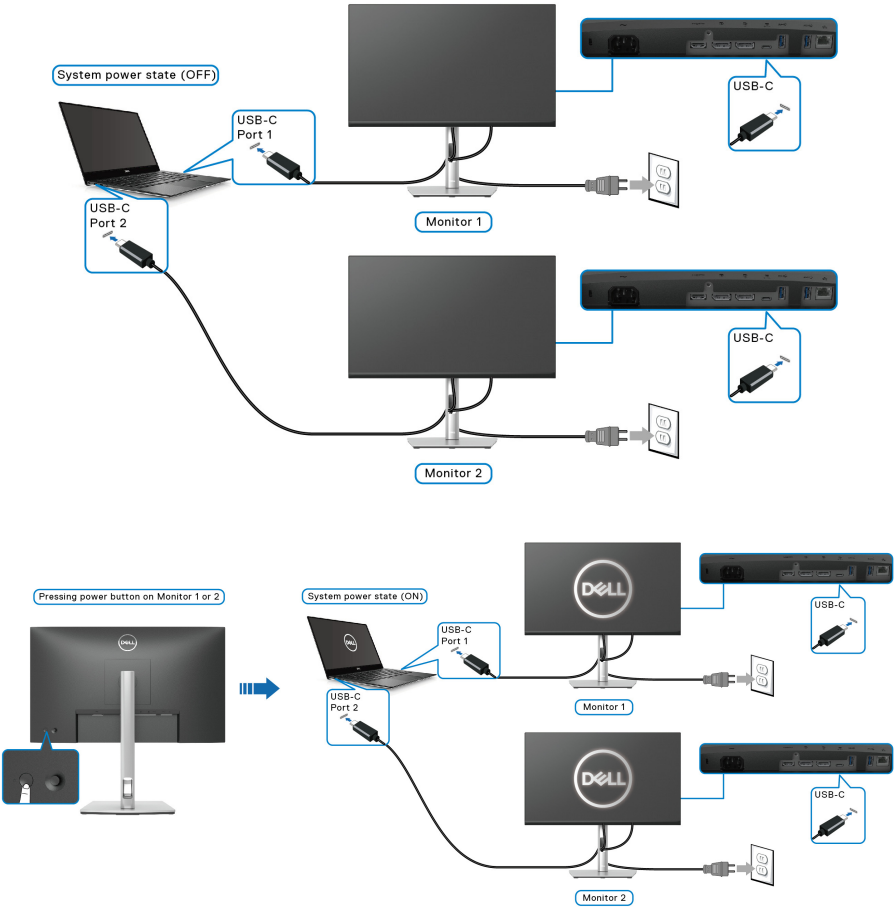



## Organizing your cables



After attaching all necessary cables to your monitor and computer, (See [Connecting your monitor](#) for cable attachment,) organize all cables as shown above.

## Removing the monitor stand

-  **NOTE:** To prevent scratches on the LCD screen when removing the stand, ensure that the monitor is placed on a soft, clean surface.
-  **NOTE:** The following instructions are applicable only for removing the stand that was shipped with your monitor. If you are removing a stand that you purchased from any other source, follow the setup instructions that were included with the stand.



To remove the stand:

1. Place the monitor on a soft cloth or cushion.
2. Press and hold the stand release button.
3. Lift the stand up and away from the monitor.



## VESA wall mounting (optional)

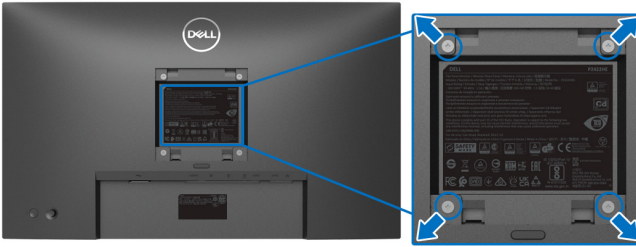

(Screw dimension: M4 x 10 mm).

Refer to the instructions that come with the VESA-compatible wall mounting kit.

1. Place the monitor panel on a soft cloth or cushion on a stable flat table.
2. Remove the stand. (See [Removing the monitor stand](#))
3. Use a Phillips crosshead screwdriver to remove the four screws securing the plastic cover.
4. Attach the mounting bracket from the wall mounting kit to the monitor.
5. Mount the monitor on the wall. For more information, see the documentation that is shipped with the wall mounting kit.

**NOTE:** For use only with UL or CSA or GS-listed wall mount bracket with minimum weight or load bearing capacity of 15.24 kg (P2422HE)/ 19.68 kg (P2722HE).





# Operating the monitor

## Power on the monitor

Press the Power button to turn On the monitor.

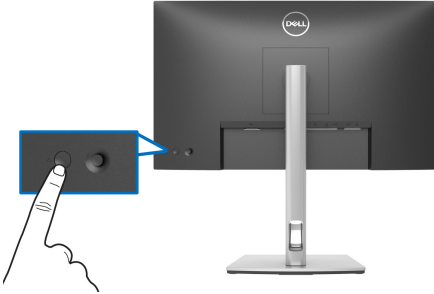

## Using the joystick control

Use the joystick control on the rear of the monitor to make On-Screen Display (OSD) adjustments.

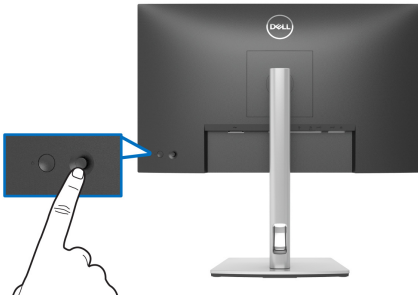

1. Press the joystick to launch the Menu Launcher.
2. Move the joystick up/down/left/right to toggle between options.
3. Press the joystick again to confirm the selection.

---

### Joystick

### Description

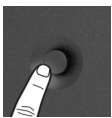

- When there is no OSD on the screen, press the joystick to launch the Menu Launcher. See [Accessing the Menu Launcher](#).
- When the OSD is displayed, press the joystick to confirm the selection or save the settings.



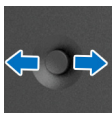

- For 2-way (right and left) directional navigation.
- Move right to enter the submenu.
- Move left to exit from the submenu.

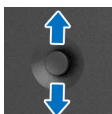

- For 2-way (up and down) directional navigation.
- Toggles between the menu items.
- Increases (up) or decreases (down) the parameters of selected menu item.

## Using the On-Screen Display (OSD) menu

### Accessing the Menu Launcher

When you toggle or press the joystick, the Menu Launcher appears to let you access the OSD main menu and shortcut functions,

To select a function, move the joystick.

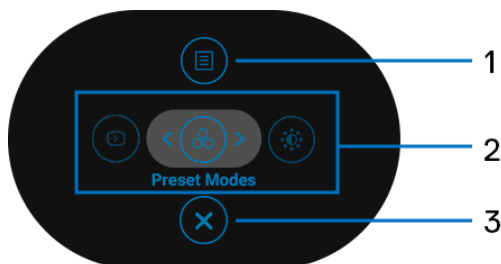

The following table describes the Menu Launcher functions:

Label	Icon	Description
1		To launch the On-Screen Display (OSD) main menu. See <a href="#">Accessing the menu system</a> .
	<b>Menu</b>	



---

2



### Shortcut functions

When you move the joystick to the left or right to toggle between the shortcut functions, the selected item will be highlighted and shifted to the center position. Press the joystick to enter its submenu. After you change the settings, press the joystick to save the changes before proceeding to another function or exit.

- **Input Source:** To choose an input source from the list of video signals that may be connected to your monitor.
- **Preset Modes:** To choose a preferred color mode from the list of preset modes.
- **Brightness/Contrast:** To access the adjustment sliders of brightness and contrast.

**NOTE:** You can set your preferred shortcut keys. See [Personalize](#) for details.

---

3



### Exit

To exit the Menu Launcher.

---

## Using the navigation keys

When the OSD main menu is active, move the joystick to configure the settings, following the navigation keys displayed below the OSD.

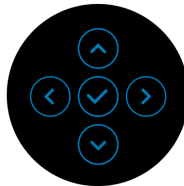

After you change the settings, press the joystick to save the changes before proceeding to another menu or exit the OSD menu.

 **NOTE:** To exit the current menu item and return to the previous menu, move the joystick to the left until you exit.



## Accessing the menu system

 **NOTE:** After you change the settings, press the joystick to save the changes before proceeding to another menu or exit the OSD menu.

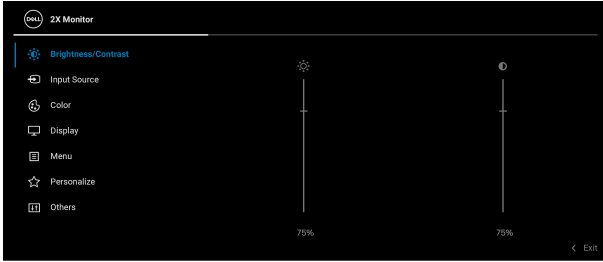
Icon	Menu and Submenus	Description
	<b>Brightness/Contrast</b>	Activate <b>Brightness/Contrast</b> adjustment.
		
	<b>Brightness</b>	Adjusts the luminance of the backlight. Move the joystick up to increase the brightness level or move the joystick down to decrease the brightness level (min. 0 / max. 100).
	<b>Contrast</b>	Adjusts the <b>Brightness</b> first, and then adjust the <b>Contrast</b> only if further adjustment is necessary. Move the joystick up to increase the contrast level or move the joystick down to decrease the contrast level (min. 0 / max. 100). The <b>Contrast</b> function adjusts the degree of difference between darkness and lightness on the monitor screen.





## Input Source

Selects between the different video signals that may be connected to your monitor.

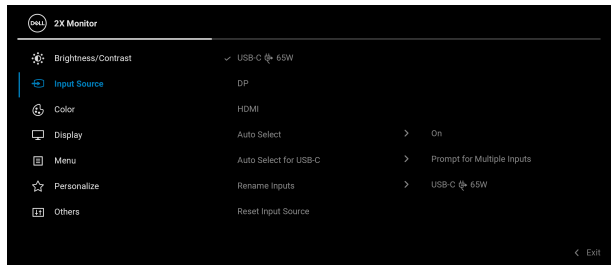

### USB-C 65W

Select the **USB-C 65W** input when you are using the USB Type-C connector. Press the joystick to confirm the selection.

### DP

Select the **DP** input when you are using the DisplayPort (DP) connector. Press the joystick to confirm the selection.

### HDMI

Select the **HDMI** input when you are using the HDMI connector. Press the joystick to confirm the selection.

### Auto Select

Allows you to scan for available input sources. The default is **On**.



---

**Auto Select for USB-C**

Allows you to set Auto Select for USB-C to:

- **Prompt for Multiple Inputs:** Always displays the “**Switch to USB-C Video Input**” message for you to choose whether to switch or not.
- **Yes:** Always switches to USB-C video input (without asking) when the USB Type-C cable is connected.
- **No:** Never automatically switches to USB-C video input when the USB Type-C cable is connected.

Press the joystick to confirm the selection.

**NOTE:** The option is available only when **Auto Select** is on.

---

**Rename Inputs**

Allows you to specify a preset input name for the selected input source. The preset options are **PC**, **PC 1**, **PC 2**, **Laptop**, **Laptop 1**, and **Laptop 2**. The default setting is **Off**.

**NOTE:** When you perform a rename for the USB-C input, the wattage value remains after the specified option, e.g., **PC 1**  **65W**.

**NOTE:** It is not applicable for the input names shown in the warning messages and **Display Info**.

---

**Reset Input Source**

Resets your monitor input settings to the factory settings.

---





## Color

Adjusts the color setting mode.

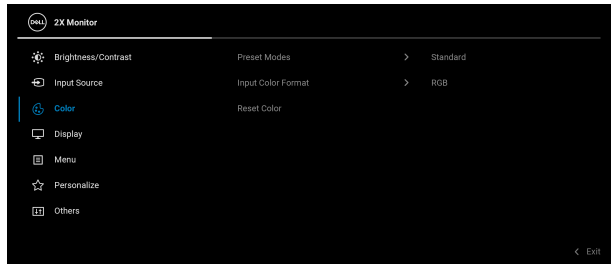

## Preset Modes

Allows you to choose from the list of preset color modes. Press the joystick to confirm the selection.

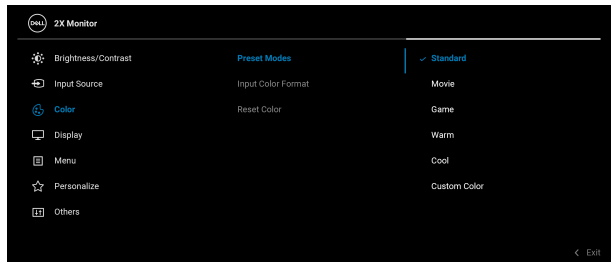

- **Standard:** Loads the monitor's default color settings. This is the default preset mode.
- **Movie:** Loads color settings ideal for movies.
- **Game:** Loads color settings ideal for most gaming applications.
- **Warm:** Presents colors at lower color temperatures. The screen appears warmer with a red/yellow tint.



---

## Preset Modes

- **Cool:** Presents colors at higher color temperatures. The screen appears cooler with a blue tint.
- **Custom Color:** Allows you to manually adjust the color settings. Move the joystick to adjust the R/G/B color values and create your own preset color mode.

---

## Input Color Format

Allows you to set the video input mode to:

- **RGB:** Select this option if your monitor is connected to a computer or a media player that supports RGB output.
- **YCbCr:** Select this option if your media player supports only YCbCr output.

Press the joystick to confirm the selection.

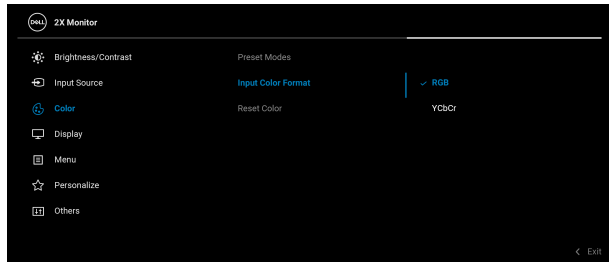

---

## Hue

Shifts the color of the video image to green or purple. This is used to adjust the desired flesh tone color. Move the joystick to adjust the hue level from '0' to '100'.

**NOTE: Hue** adjustment is available only when you select **Movie** or **Game** preset mode.

---





---

**Saturation**

Adjusts the color saturation of the video image. Move the joystick to adjust the saturation level from '0' to '100'.

**NOTE: Saturation** adjustment is available only when you select **Movie** or **Game** preset mode.

---

**Reset Color**

Resets your monitor's color settings to the factory settings.

---

**Display**

Use the **Display** menu to adjust images.

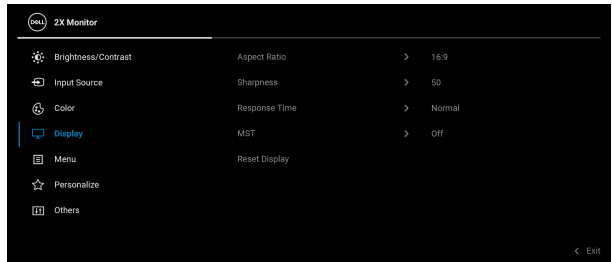

---

**Aspect Ratio**

Adjusts the image ratio to **16:9**, **4:3**, or **5:4**.

---

**Sharpness**

This feature can make the image look sharper or softer.

Move the joystick to adjust the sharpness level from '0' to '100'.

---

**Response Time**

Allows you to set the **Response Time** to **Normal** or **Fast**.

---

**MST**

DisplayPort Multi Stream Transport. The default setting is **Off**. To enable MST (DP out), select **On**.

**NOTE:** When the DisplayPort/USB Type-C cable and the DP downstream cable are connected, the OSD will set **MST** to **On** automatically. This action will only be done once after **Factory Reset** or **Reset Display** is selected.

---

**Reset Display**

Resets all display settings to the factory preset values.

---





## Menu

Select this option to adjust the settings of the OSD, such as, the languages of the OSD, the amount of time the menu remains on screen, and so on.

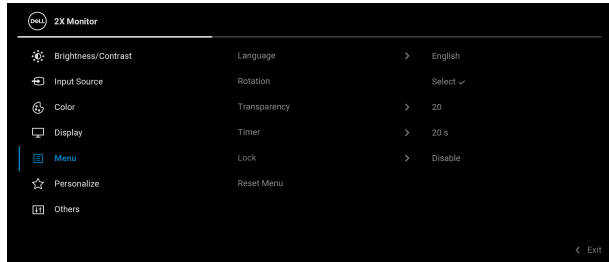

## Language

Sets the OSD display to one of the eight languages (English, Spanish, French, German, Brazilian Portuguese, Russian, Simplified Chinese, or Japanese).

## Rotation

Press the joystick to rotate the OSD and the screen by 0/90/180/270 degrees.

You can adjust the menu according to your display rotation.

## Transparency

Select this option to change the menu transparency by moving the joystick (min. 0 / max. 100).

## Timer

Sets the length of time the OSD will remain active after the last time you pressed a button.

Move the joystick to adjust the slider in 1 second increments, from 5 to 60 seconds.



---

## Lock

With the control buttons on the monitor locked, you can prevent people from accessing the controls. It also prevents accidental activation in multiple monitors side-by-side setup.

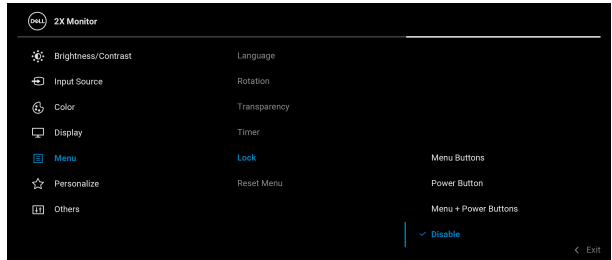

- **Menu Buttons:** All joystick functions are locked and not accessible by the user.
- **Power Button:** Only the Power button is locked and not accessible by the user.
- **Menu + Power Buttons:** Both the joystick & Power button are locked and not accessible by the user.

The default setting is **Disable**.

Alternative Lock Method: You can move and hold the joystick up/down/left/right for 4 seconds to set the lock options via the pop-up menu, and then press the joystick to confirm the configuration.

**NOTE:** To unlock the button(s), move and hold the joystick up/down/left/right for 4 seconds, and then press the joystick to confirm the changes and close the pop-up menu.

---

## Reset Menu

Resets all OSD settings to the factory preset values.

---





## Personalize

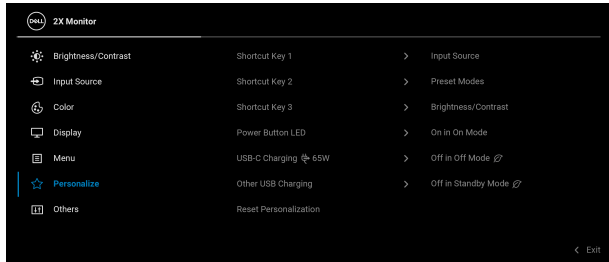

### Shortcut Key 1

### Shortcut Key 2

### Shortcut Key 3

Allows you to choose a feature from **Preset Modes**, **Brightness/Contrast**, **Input Source**, **Aspect Ratio**, **Rotation**, or **Display Info** and set it as a shortcut key.

### Power Button LED

Allows you to set the power LED indicator on or off to save energy.

### USB-C Charging 65W

The default setting is **Off in Off Mode**. Selecting **On in Off Mode** may automatically charge your notebook or mobile devices through the USB Type-C cable even when the monitor is in off mode.

### Other USB Charging

Allows you to enable or disable USB Type-A (Downstream Ports) charging function during monitor standby mode.

### Reset Personalization

Resets all settings under the **Personalize** menu to the factory preset values.





## Others

Select this menu to adjust the OSD settings, such as **DDC/CI**, **LCD Conditioning**, and so on.

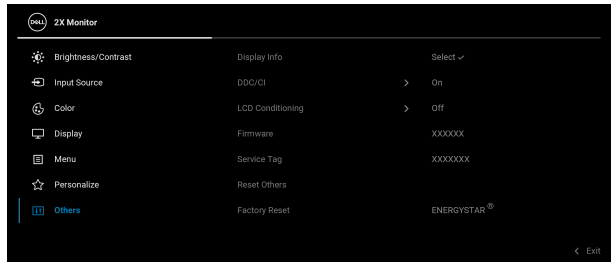

## Display Info

Displays the monitor's current settings.

### DDC/CI

**DDC/CI** (Display Data Channel/Command Interface) allows you to adjust the monitor settings using software on your computer. You can disable this feature by selecting **Off**.

Enable this feature for best user experience and optimum performance of your monitor.

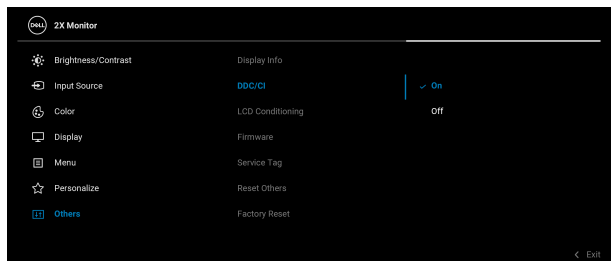

---

## LCD Conditioning

Helps reduce minor cases of image retention. Depending on the degree of image retention, the program may take some time to run. You can enable this feature by selecting **On**.

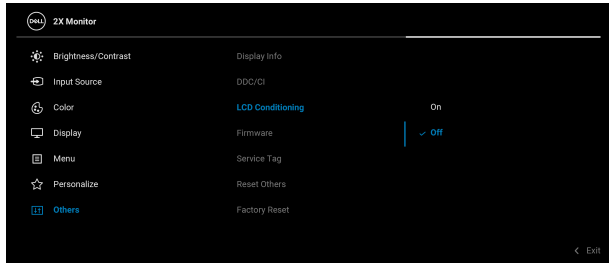

---

**Firmware** Displays the firmware version of your monitor.

---

**Service Tag** Displays the service tag of your monitor. This string is required when you look for phone support, check your warranty status, update drivers on Dell's website, etc.

---

**Reset Others** Resets all settings under the **Others** menu to the factory preset values.

---

**Factory Reset** Restore all preset values to the factory default settings. These are also the settings for ENERGY STAR® tests.

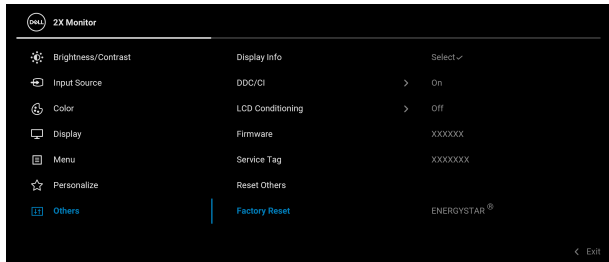

## OSD warning message

When the monitor does not support a particular resolution mode, you will see the following message:

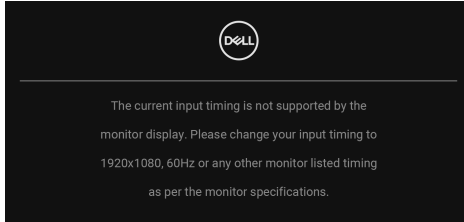

This means that the monitor cannot synchronize with the signal that it is receiving from the computer. See [Monitor specifications](#) for the Horizontal and Vertical frequency ranges addressable by this monitor. The recommended mode is **1920 x 1080**.

You will see the following message before the **DDC/CI** function is disabled:

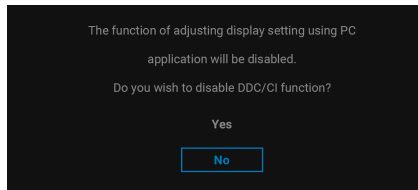

When you adjust the **Brightness** level above the default level for the first time, the following message appears:

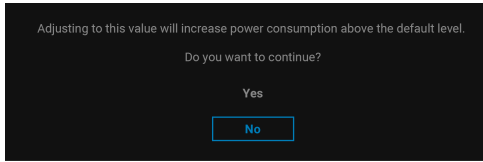

**NOTE:** If you select **Yes**, the message will not appear the next time you change the **Brightness** setting.

When you change the default setting of power saving features for the first time, such as **USB-C Charging 65W** or **Other USB Charging**, the following message appears:

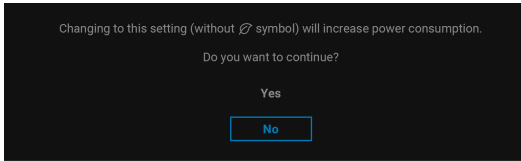

**NOTE:** If you select **Yes** for either of the features mentioned above, the message will not appear the next time you change the settings of these features. When you perform a factory reset, the message will appear again.

When the monitor goes into Standby mode, the following message appears:

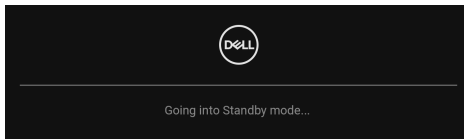

Activate the computer and wake up the monitor to gain access to the **OSD**.





The OSD functions only in the normal operation mode. If you press the joystick during the Standby mode, the following message will appear depending on the selected input:

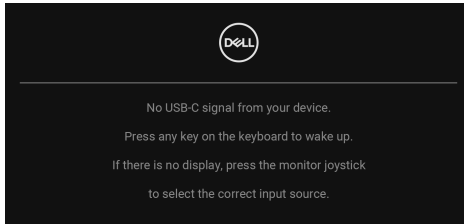

Activate the computer and the monitor to gain access to the [OSD](#).

 **NOTE: The message may be slightly different according to the connected input signal.**

If either USB Type-C, DisplayPort, or HDMI input is selected and the corresponding cable is not connected, the following message will appear:

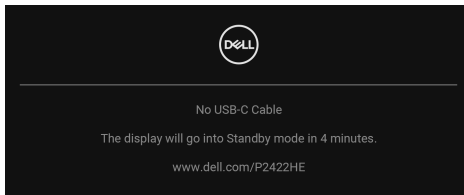

or

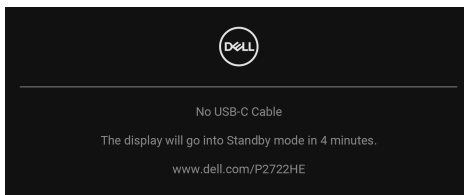

 **NOTE: The message may be slightly different according to the connected input signal.**



When the monitor is under DP/HDMI input and a USB Type-C cable is connected to a notebook that supports DP Alternate Mode, if **Auto Select for USB-C** is enabled, the following message appears:

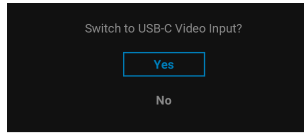

You will see the following message before the **Lock** function is activated:

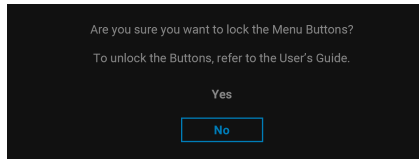

 **NOTE: The message may be slightly different according to the selected settings.**

When **Factory Reset** is selected, the following message appears:

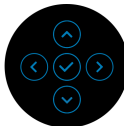
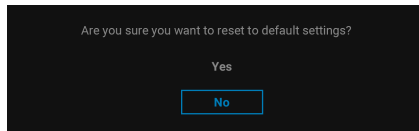

When **Yes** is selected, the following message appears.

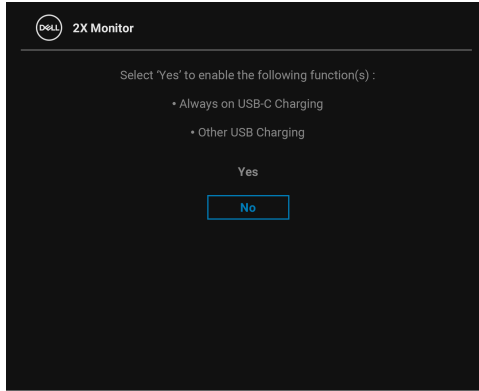

See [Troubleshooting](#) for more information.



## Setting the maximum resolution

To set the maximum resolution for the monitor:

In Windows® 7, Windows® 8, and Windows® 8.1:

1. For Windows® 8 and Windows® 8.1 only, select the Desktop tile to switch to classic desktop.
2. Right-click on the desktop and click **Screen resolution**.
3. Click the dropdown list of the **Screen resolution** and select **1920 x 1080**.
4. Click **OK**.

In Windows® 10:

1. Right-click on the desktop and click **Display settings**.
2. Click **Advanced display settings**.
3. Click the dropdown list of **Resolution** and select **1920 x 1080**.
4. Click **Apply**.

If you do not see 1920 x 1080 as an option, you may need to update your graphics driver. Depending on your computer, complete one of the following procedures:

If you have a Dell desktop or portable computer:

- Go to <http://www.dell.com/support>, enter your service tag, and download the latest driver for your graphics card.

If you are using a non-Dell computer (portable or desktop):

- Go to the support site for your computer and download the latest graphic drivers.
- Go to your graphics card website and download the latest graphic drivers.



## Using the tilt, swivel, and vertical extension

**NOTE:** The following instructions are applicable only for attaching the stand that was shipped with your monitor. If you are attaching a stand that you purchased from any other source, follow the setup instructions that were included with the stand.

### Tilt, swivel

With the stand attached to the monitor, you can tilt and swivel the monitor for the most comfortable viewing angle.

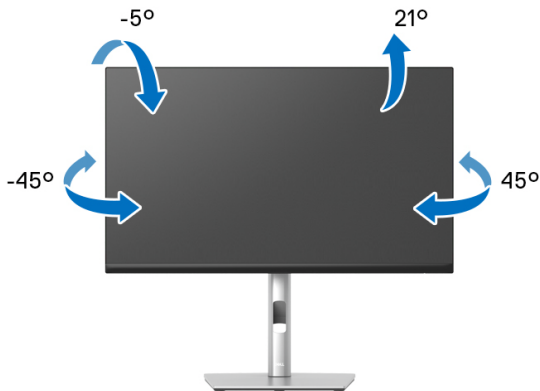

**NOTE:** The stand is not installed at the factory when shipped.

### Vertical extension

**NOTE:** The stand extends vertically up to 150 mm. The figure below illustrates how to extend the stand vertically.

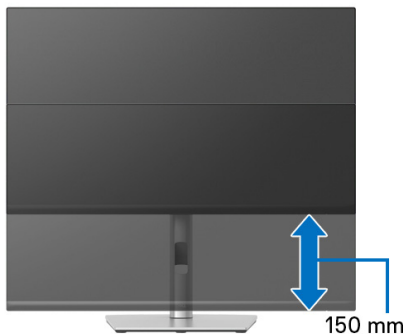

## Rotating the monitor

Before you rotate the monitor, your monitor should be fully vertically extended ([Vertical extension](#)) and fully tilted up to avoid hitting the bottom edge of the monitor.

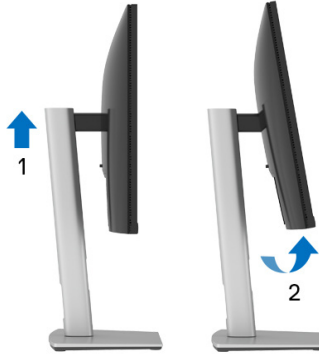

### Rotate clockwise



## Rotate counterclockwise



- NOTE: To use the Display Rotation function (Landscape versus Portrait view) with your Dell computer, you require an updated graphics driver that is not included with this monitor. To download the graphics driver, go to [www.dell.com/support](http://www.dell.com/support) and see the Download section for Video Drivers for latest driver updates.
- NOTE: When in the Portrait View Mode, you may experience performance degradation in graphic-intensive applications (3D Gaming and etc.).



## Adjusting the rotation display settings of your system

After you have rotated your monitor, you need to complete the procedure below to adjust the Rotation Display Settings of your system.

 **NOTE: If you are using the monitor with a non-Dell computer, you need to go the graphics driver website or your computer manufacturer website for information on rotating the 'contents' on your display.**

To adjust the Rotation Display Settings:

1. Right-click on the desktop and click **Properties**.
2. Select the **Settings** tab and click **Advanced**.
3. If you have an ATI graphics card, select the **Rotation** tab and set the preferred rotation.
4. If you have an nVidia graphics card, click the **nVidia** tab, in the left-hand column select **NVRotate**, and then select the preferred rotation.
5. If you have an Intel<sup>®</sup> graphics card, select the **Intel** graphics tab, click **Graphic Properties**, select the **Rotation** tab, and then set the preferred rotation.

 **NOTE: If you do not see the rotation option or it is not working correctly, go to [www.dell.com/support](http://www.dell.com/support) and download the latest driver for your graphics card.**





# Troubleshooting

**⚠ WARNING:** Before you begin any of the procedures in this section, follow the [Safety instructions](#).

## Self-test

Your monitor provides a self-test feature that allows you to check whether your monitor is functioning properly. If your monitor and computer are properly connected but the monitor screen remains dark, run the monitor self-test by performing the following steps:

1. Turn off both your computer and the monitor.
2. Unplug the video cable from the computer.
3. Turn on the monitor.

If the monitor cannot sense a video signal and is working correctly, the following message will appear:

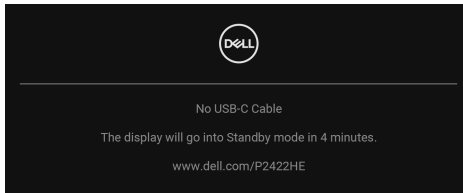

or

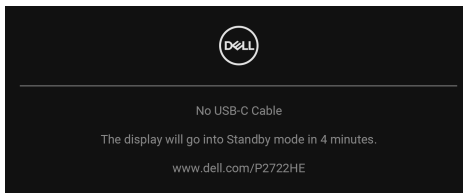

**✎ NOTE:** The message may be slightly different according to the connected input signal.

**✎ NOTE:** While in self-test mode, the power LED remains white.

4. This box also appears during normal system operation, if the video cable becomes disconnected or damaged.
5. Turn Off your monitor and reconnect the video cable; then turn On both your computer and the monitor.



If your monitor screen remains blank after you use the previous procedure, check your video controller and computer, because your monitor is functioning properly.

## Built-in diagnostics

Your monitor has a built-in diagnostic tool that helps you determine if the screen abnormality you are experiencing is an inherent problem with your monitor, or with your computer and video card.

To run the built-in diagnostics:

1. Ensure that the screen is clean (no dust particles on the surface of the screen).
2. Move and hold the joystick up/down/left/right for about 4 seconds until a pop-up menu appears.

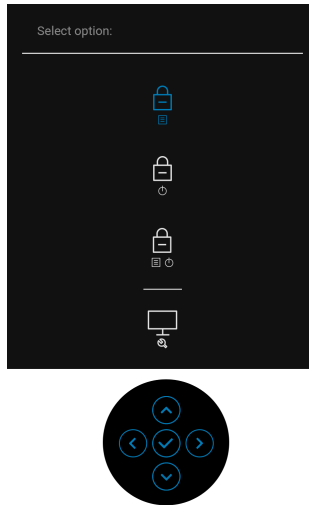

3. Move the joystick to highlight the Diagnostic icon  and then press the joystick to confirm. A gray test pattern appears.

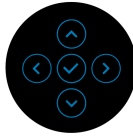
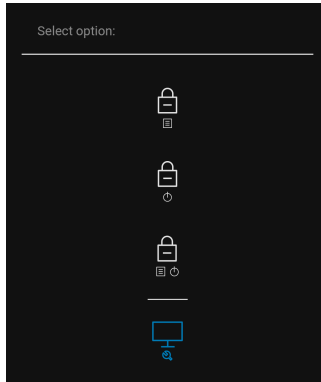

4. Carefully inspect the screen for abnormalities.
5. Press the joystick to change the test patterns.
6. Repeat steps 4 and 5 to inspect the display in red, green, blue, black, white, and text screens.
7. Press the joystick to end the diagnostic program.



## Common problems

The following table contains general information about common monitor problems you might encounter and the possible solutions:

Common symptoms	What you experience	Possible solutions
No Video/Power LED off	No picture	<ul style="list-style-type: none"><li>• Ensure that the video cable connecting the monitor and the computer is properly connected and secure.</li><li>• Verify that the power outlet is functioning properly using any other electrical equipment.</li><li>• Ensure that the power button is pressed fully.</li><li>• Ensure that the correct input source is selected in the <a href="#">Input Source</a> menu.</li></ul>
No Video/Power LED on	No picture or no brightness	<ul style="list-style-type: none"><li>• Increase brightness &amp; contrast controls via OSD.</li><li>• Perform monitor self-test feature check.</li><li>• Check for bent or broken pins in the video cable connector.</li><li>• Run the built-in diagnostics.</li><li>• Ensure that the correct input source is selected in the <a href="#">Input Source</a> menu.</li></ul>
Poor Focus	Picture is fuzzy, blurry, or ghosting	<ul style="list-style-type: none"><li>• Eliminate video extension cables.</li><li>• Reset the monitor to factory settings.</li><li>• Change the video resolution to the correct aspect ratio.</li></ul>
Shaky/Jittery Video	Wavy picture or fine movement	<ul style="list-style-type: none"><li>• Reset the monitor to factory settings.</li><li>• Check environmental factors.</li><li>• Relocate the monitor and test in another room.</li></ul>



Missing Pixels	LCD screen has spots	<ul style="list-style-type: none"> <li>• Cycle power On-Off.</li> <li>• Pixel that is permanently Off is a natural defect that can occur in LCD technology.</li> <li>• For more information on Dell Monitor Quality and Pixel Policy, see Dell Support site at: <a href="http://www.dell.com/pixelguidelines">www.dell.com/pixelguidelines</a>.</li> </ul>
Stuck-on Pixels	LCD screen has bright spots	<ul style="list-style-type: none"> <li>• Cycle power On-Off.</li> <li>• Pixel that is permanently off is a natural defect that can occur in LCD technology.</li> <li>• For more information on Dell Monitor Quality and Pixel Policy, see Dell Support site at: <a href="http://www.dell.com/pixelguidelines">www.dell.com/pixelguidelines</a>.</li> </ul>
Brightness Problems	Picture too dim or too bright	<ul style="list-style-type: none"> <li>• Reset the monitor to factory settings.</li> <li>• Adjust brightness &amp; contrast controls via OSD.</li> </ul>
Geometric Distortion	Screen not centered correctly	<ul style="list-style-type: none"> <li>• Reset the monitor to factory settings.</li> </ul>
Horizontal/Vertical Lines	Screen has one or more lines	<ul style="list-style-type: none"> <li>• Reset the monitor to factory settings.</li> <li>• Perform monitor self-test feature check and determine if these lines are also in self-test mode.</li> <li>• Check for bent or broken pins in the video cable connector.</li> <li>• Run the built-in diagnostics.</li> </ul>



Synchronization Problems	Screen is scrambled or appears torn	<ul style="list-style-type: none"> <li>• Reset the monitor to factory settings.</li> <li>• Perform monitor self-test feature check to determine if the scrambled screen appears in self-test mode.</li> <li>• Check for bent or broken pins in the video cable connector.</li> <li>• Restart the computer in the safe mode.</li> </ul>
Safety Related Issues	Visible signs of smoke or sparks	<ul style="list-style-type: none"> <li>• Do not perform any troubleshooting steps.</li> <li>• Contact Dell immediately.</li> </ul>
Intermittent Problems	Monitor malfunctions on & off	<ul style="list-style-type: none"> <li>• Ensure that the video cable connecting the monitor to the computer is connected properly and is secure.</li> <li>• Reset the monitor to factory settings.</li> <li>• Perform monitor self-test feature check to determine if the intermittent problem occurs in self-test mode.</li> </ul>
Missing Color	Picture missing color	<ul style="list-style-type: none"> <li>• Perform monitor self-test feature check.</li> <li>• Ensure that the video cable connecting the monitor to the computer is connected properly and is secure.</li> <li>• Check for bent or broken pins in the video cable connector.</li> </ul>



Wrong Color	Picture color not good	<ul style="list-style-type: none"> <li>• Try different <b>Preset Modes</b> in <b>Color</b> setting OSD. Adjust <b>R/G/B</b> value in <b>Custom Color</b> in <b>Color</b> settings OSD.</li> <li>• Change the <b>Input Color Format</b> to <b>RGB</b> or <b>YCbCr/YPbPr</b> in the <b>Color</b> settings OSD.</li> <li>• Run the built-in diagnostics.</li> </ul>
Image retention from a static image left on the monitor for a long period of time	Faint shadow from the static image displayed appears on the screen	<ul style="list-style-type: none"> <li>• Set the screen to turn off after a few minutes of screen idle time. These can be adjusted in Windows Power Options or Mac Energy Saver setting.</li> <li>• Alternatively, use a dynamically changing screensaver.</li> </ul>



## Product specific problems

Common symptoms	What you experience	Possible solutions
Screen image is too small	Image is centered on screen, but does not fill entire viewing area	<ul style="list-style-type: none"><li>• Check the <b>Aspect Ratio</b> setting in the <b>Display</b> settings OSD.</li><li>• Reset the monitor to factory settings.</li></ul>
Cannot adjust the monitor with the joystick	OSD does not appear on the screen	<ul style="list-style-type: none"><li>• Turn Off the monitor, unplug the power cord, plug it back, and then turn On the monitor.</li><li>• Check whether the OSD menu is locked. If yes, move and hold the joystick up/down/left/right for 4 seconds to unlock (for more information, see <a href="#">Lock</a>).</li></ul>
No input signal when user controls are pressed	No picture, the LED light is white	<ul style="list-style-type: none"><li>• Check the signal source. Ensure the computer is not in the power saving mode by moving the mouse or pressing any key on the keyboard.</li><li>• Check whether the signal cable is plugged in properly. Re-plug the signal cable if necessary.</li><li>• Reset the computer or video player.</li></ul>
The picture does not fill the entire screen	The picture cannot fill the height or width of the screen	<ul style="list-style-type: none"><li>• Due to different video formats (aspect ratio) of DVDs, the monitor may display in full screen.</li><li>• Run the built-in diagnostics.</li></ul>
No video at HDMI/DisplayPort/USB Type-C port	When connected to some dongle/docking device at the port, there is no video when unplugging/plugging the cable from the notebook	<ul style="list-style-type: none"><li>• Unplug the HDMI/DisplayPort/USB Type-C cable from dongle/docking device, then plug the docking HDMI/DisplayPort/USB Type-C cable to the notebook.</li></ul>





No network connection	Network dropped or intermittent	<ul style="list-style-type: none"> <li>Do not turn Off the monitor during network connection.</li> </ul>
The LAN port is not functioning	OS setting or cable connection issue	<ul style="list-style-type: none"> <li>Ensure that the latest BIOS and drivers for your computer are installed on your computer.</li> <li>Ensure that the RealTek Gigabit Ethernet Controller is installed in the Windows Device Manager.</li> <li>If your BIOS Setup has a LAN/GBE Enabled/Disabled option, make sure it is set to Enabled.</li> <li>Ensure that the Ethernet cable is connected securely on the monitor and the hub/router/firewall.</li> <li>Check the status LED of the Ethernet cable to confirm connectivity. Re-connect both ends of the Ethernet cable if the LED is not lit.</li> <li>First power off the computer and unplug the USB Type-C cable and the power cord from the monitor. Then, power on the computer and plug the power cord and the USB Type-C cable into the monitor.</li> </ul>



## Universal Serial Bus (USB) specific problems

Common symptoms	What you experience	Possible solutions
USB interface is not working	USB peripherals are not working	<ul style="list-style-type: none"><li>• Check that your monitor is turned On.</li><li>• Reconnect the upstream cable to your computer.</li><li>• Reconnect the USB peripherals (downstream connector).</li><li>• Turn off the monitor and turn it on again.</li><li>• Reboot the computer.</li><li>• Certain USB devices such as portable hard drive require higher power source; connect the drive to the computer directly.</li></ul>
USB Type-C port does not supply power	USB peripherals can not be charged	<ul style="list-style-type: none"><li>• Check that the connected device is compliant with the USB-C specification. The USB Type-C port supports USB 3.2 Gen1 and an output of 65 W.</li><li>• Check that you use the USB Type-C cable shipped with your monitor.</li></ul>
SuperSpeed USB 5 Gbps (USB 3.2 Gen1) interface is slow	SuperSpeed USB 5 Gbps (USB 3.2 Gen1) peripherals working slowly or not working at all	<ul style="list-style-type: none"><li>• Check that your computer is SuperSpeed USB 5 Gbps (USB 3.2 Gen1)-compatible.</li><li>• Some computers have USB 3.2, USB 2.0, and USB 1.1 ports. Ensure that the correct USB port is used.</li><li>• Reconnect the upstream cable to your computer.</li><li>• Reconnect the USB peripherals (downstream connector).</li><li>• Reboot the computer.</li></ul>



---

Wireless USB peripherals stop working when a USB 3.2 device is plugged in	Wireless USB peripherals responding slowly or only working as the distance between itself and its receiver decreases	<ul style="list-style-type: none"><li>· Increase the distance between the USB 3.2 peripherals and the wireless USB receiver.</li><li>· Position your wireless USB receiver as close as possible to the wireless USB peripherals.</li><li>· Use a USB-extender cable to position the wireless USB receiver as far away as possible from the USB 3.2 port.</li></ul>
---	--	--

---



# Appendix

## WARNING: Safety instructions

 **WARNING: Use of controls, adjustments, or procedures other than those specified in this documentation may result in exposure to shock, electrical hazards, and/or mechanical hazards.**

For information on safety instructions, see Safety, Environmental, and Regulatory Information (SERI).

## FCC notices (U.S. only) and other regulatory information

For FCC notices and other regulatory information, see the regulatory compliance website located at [www.dell.com/regulatory\\_compliance](http://www.dell.com/regulatory_compliance).

## Contact Dell

For customers in the United States, call 800-WWW-DELL (800-999-3355).

 **NOTE: If you do not have an active Internet connection, you can find contact information on your purchase invoice, packing slip, bill, or Dell product catalog.**

**Dell provides several online and telephone-based support and service options. Availability varies by country and product, and some services may not be available in your area.**

- Online technical assistance — [www.dell.com/support/monitors](http://www.dell.com/support/monitors)
- Contacting Dell — [www.dell.com/contactdell](http://www.dell.com/contactdell)

## EU product database for energy label and product information sheet

P2422HE: <https://eprel.ec.europa.eu/qr/549713>

P2422HE WOST: <https://eprel.ec.europa.eu/qr/562079>

P2722HE: <https://eprel.ec.europa.eu/qr/553243>

