

SAMSUNG

WASHING MACHINE DRUM TYPE

The model code is on the next page.

SERVICE Manual

REPAIR GUIDE

WASHING MACHINE (DRUM)



WW90T654DLH WW10T754DBH



WW90T986DSH WW90T684DLH WW90T534DAW

CONTENTS

1. Safety Instructions
2. Features and Specifications
3. Disassembly and Reassembly
4. Troubleshooting
5. Wiring Diagram
6. Reference

MODEL CODE

WW1*T*****	WW7*T*****	WW8*T*****		WW9*T*****	
WW10T4040CH	WW70T4020CE	WW80T4020CE	WW80T754ABH	WW90T4020CE	WW90T734DBT
WW10T4040CN	WW70T4020CH	WW80T4020CX	WW80T754ABT	WW90T4020EE	WW90T734DBX
WW10T534DAN	WW70T4020CW	WW80T4020EE	WW80T754DBH	WW90T4020EH	WW90T734DWH
WW10T534DAT	WW70T4020CX	WW80T4020EH	WW80T754DBT	WW90T4040CE	WW90T754ABH
WW10T534DAW	WW70T4020EE	WW80T4040CE	WW80T754DWH	WW90T4041CE	WW90T754ABT
WW10T534DTW	WW70T4020EW	WW80T4040EE	WW80T756ABH	WW90T4041CX	WW90T754DBH
WW10T554DAN	WW70T4040CE	WW80T4040EH	WW80T756AWT	WW90T4042CE	WW90T754DBN
WW10T554DAT	WW70T4040CN	WW80T4041EE	WW80T854ABH	WW90T4540AE	WW90T754DBT
WW10T554DAW	WW70T4040CW	WW80T4042CE	WW80T854ABT	WW90T4540AX	WW90T754DBX
WW10T554DAX	WW70T4040EE	WW80T4042EW	WW80T854DBH	WW90T4540TE	WW90T754DWH
WW10T554DTW	WW70T4042CE	WW80T4520TE	WW80T854DBT	WW90T4540TH	WW90T854ABH
WW10T604CLH	WW70T4042CX	WW80T4540AE	WW80T854DBX	WW90T4543AE	WW90T854ABT
WW10T604DHH	WW70T4042EW	WW80T4540AX	WW80T854DWT	WW90T4543TE	WW90T854DBH
WW10T634AHH	WW70T4540TE	WW80T4540TE	WW80T934ASH	WW90T534AAW	WW90T854DBT
WW10T634CLH	WW70T4543AE	WW80T4541TE	WW80T936ASH	WW90T534ATW	WW90T854DBX
WW10T634DLE	WW70T4543TE	WW80T4543AE	WW80T936DSH	WW90T534DAE	WW90T934ASH
WW10T634DLH	WW70T534AAE	WW80T4543TE	WW80T954ASE	WW90T534DAN	WW90T936ASH
WW10T634DLN	WW70T534ATW	WW80T534AAE	WW80T954ASH	WW90T534DAT	WW90T936DSH
WW10T634DLX	WW70T534DTW	WW80T534AAW	WW80T956ASE	WW90T534DAW	WW90T936DSX
WW10T654ALE	WW70T552DAE	WW80T534AAX	WW80TA026AE	WW90T534DAX	WW90T954ASH
WW10T654ALH	WW70T552DAT	WW80T534ATW	WW80TA026AH	WW90T534DTT	WW90T954ASX
WW10T654CLH	WW70T552DAW	WW80T534DAE	WW80TA026AT	WW90T534DTW	WW90T954DSH
WW10T654CLX	WW70T552DAX	WW80T534DAN	WW80TA026AX	WW90T554AAE	WW90T956ASE
WW10T654DLE	WW70T552DTW	WW80T534DAT	WW80TA026TE	WW90T554AAT	WW90T956DSH
WW10T654DLH	WW70T554ATT	WW80T534DAW	WW80TA026TH	WW90T554AAW	WW90T956DSX
WW10T654DLN	WW70T554DAE	WW80T534DAX	WW80TA026TT	WW90T554ATE	WW90T984CSH
WW10T654DLX	WW70T554DAN	WW80T534DTT	WW80TA046AE	WW90T554ATT	WW90T986ASE
WW10T684DHE	WW70T554DAT	WW80T534DTW	WW80TA046AH	WW90T554CAT	WW90T986ASH
WW10T684DLE	WW70T554DAW	WW80T552DAW	WW80TA046AN	WW90T554CAW	WW90T986DSH
WW10T684DLH	WW70T554DAX	WW80T554AAE	WW80TA046AT	WW90T554CAX	WW90T986DSX
WW10T684DLN	WW70T554DTT	WW80T554AAT	WW80TA046AX	WW90T554DAE	WW90TA026AE
WW10T734AWH	WW70T554DTW	WW80T554AAW	WW80TA046TE	WW90T554DAN	WW90TA026TE
WW10T734CBH	WW70TA026AE	WW80T554AAX	WW80TA046TH	WW90T554DAT	WW90TA046AE
WW10T734CBX	WW70TA026AH	WW80T554ATT	WW80TA046TT	WW90T554DAW	WW90TA046AH
WW10T734DBH	WW70TA026AT	WW80T554ATW	WW80TA047AT	WW90T554DAX	WW90TA046AN
WW10T734DBX	WW70TA026AX	WW80T554DAE	WW80TA047TT	WW90T554DTT	WW90TA046AT
WW10T734DWH	WW70TA026TE	WW80T554DAN	WW80TA049AE	WW90T554DTW	WW90TA046AX
WW10T754ABT	WW70TA026TH	WW80T554DAT	WW80TA049AH	WW90T604CLE	WW90TA046TE
WW10T754CBH	WW70TA026TT	WW80T554DAW	WW80TA049TE	WW90T604CLN	WW90TA046TH
WW10T754CBX	WW70TA046AE	WW80T554DAX	WW80TA049TH	WW90T606CHE	WW90TA046TT
WW10T754DBH	WW70TA046AH	WW80T554DTE	WW81T4042EW	WW90T606CLE	WW90TA047AE
WW10T754DBN	WW70TA046AN	WW80T554DTT	WW81T4543AE	WW90T634CLE	WW90TA047AX
WW10T754DBX	WW70TA046AX	WW80T554DTW	WW81T554AAW	WW90T634DHE	WW90TA049AE
WW10TA046AE	WW70TA046TE	WW80T604CLE	WW81T684AHH	WW90T634DHH	WW90TA049TH
WW10TA046AN	WW70TA046TH	WW80T634ALE	WW81T854ABT	WW90T634DLE	WW91T4543AE
WW10TP34DSG	WW70TA046TT	WW80T634ALH	WW81T956ASH	WW90T634DLH	WW91T956ASE
WW10TP34DSX	WW70TA049AE	WW80T634CLH	WW81TA049AE	WW90T634DLN	WW91T986ASH
WW10TP54DSX	WW70TA049AH	WW80T634CLE	WW81TA049AH	WW90T636AHH	WW91TA049AE
WW11T604DLE	WW70TA049AX	WW80T634DHE	WW81TA049TE	WW90T636ALH	WW91TA049TH
WW11T754DBH	WW70TA049TE	WW80T634DLE	WW81TA049TH	WW90T654ALH	WW92T656CLE
WW11TA046AH	WW70TA049TH	WW80T634DLH	WW82T4041EH	WW90T654DHE	WW92T736CBT
WW13T734CBH	WW71T4042CE	WW80T636ALH	WW83T554AAW	WW90T654DLE	WW94T756CBT
WW14T654CLE	WW71T4543AE	WW80T636CLH	WW83T554CAW	WW90T654DLH	WW95T534CAE
	WW71TA049AE	WW80T654ALE	WW83TA047AH	WW90T654DLN	WW95T654DLH
	WW71TA049TE	WW80T654ALX	WW84T734CBT	WW90T654DLX	WW95T754DBH
	WW71TA049TH	WW80T654DHE	WW84T954ASH	WW90T656AHE	WW95T956ASE
	WW7ET4543AE	WW80T654DLE	WW85T504DAE	WW90T656ALE	WW95T984DSH
	WW7ET4543AX	WW80T654DLH	WW85T554DAW	WW90T684ALE	WW95TA047AE
	WW7QT4543AE	WW80T656ALE	WW85T654DLH	WW90T684DHE	WW9ET4543AE
	WW7TT4042EH	WW80T684ALE	WW85T754DBH	WW90T684DLE	WW9GT684ALE
	WW7XTA049AH	WW80T684ALH	WW85T954DSH	WW90T684DLH	WW9GT754AWH
		WW80T684DHE	WW85T984DSH	WW90T684DLN	WW9TT4543TH
		WW80T684DLE	WW85TA047AE	WW90T734AWH	WW9XT654ALH
		WW80T684DLH	WW8ET4543AE	WW90T734DBH	WW90T4040CX
		WW80T684DLN	WW8ET554AAW	WW90T4040CT	WW95T534DAX
		WW80T734ABH	WW8ET754ABH		
		WW80T734AWH	WW8GT654ALH		
		WW80T734DBH	WW8TT554AAE		
		WW80T734DBT	WW8TT754AWH		
		WW80T734DWH	WW8XT854AWH		
		WW80T736ABH	WW8XT956ASH		

CONTENTS

1. Safety instructions	1
1-1. Safety instructions	1
2. Features and Specifications	4
2-1. Specifications	4
2-2. Comparing specifications with existing models	5
2-3. Options specifications	6
3. Disassembly and Reassembly	7
3-1. Tools for disassembly and reassembly	7
3-2. Standard disassembly drawings	8
4. Troubleshooting	30
4-1. Information Code	30
4-2. Problem check point	34
5. Wiring diagram	35
5-1. Wiring Diagram (Simple)	35
5-2. Wiring Diagram (LED)	36
5-3. Wiring Diagram (Q-Drive)	37
6. Reference	38
6-1. WW6000T Project name	38
6-2. Terminology	39

1. SAFETY INSTRUCTIONS

1-1. SAFETY INSTRUCTIONS

- ▶ Make sure to observe the following instructions to operate the product correctly and safely and prevent possible accidents and hazards while servicing.
 - ▶ Two types of safety symbols, Warning and Caution, are used in the safety instructions.
-



Hazards or unsafe practices that may result in severe personal injury or death.



Hazards or unsafe practices that may result in minor personal injury or property damage.

- ▶ Following the repair by a non-authorized service provider, self-repair or non-professional repair of the product, Samsung is not liable for any damage to the product, any injury or any other product safety issue caused by any attempt to repair the product which does not carefully follow these repair and maintenance instructions. Any damage to the product caused by an attempt to repair the product by any person other than a Samsung certified service provider will not be covered by the warranty.
-



BEFORE SERVICING

- (When servicing electrical parts or harnesses) Make sure to disconnect the power plug before servicing.
 - ✓ Failing to do so may result in a risk of electric shock.
-

- Advise consumers not to connect several appliances to a single power outlet at the same time.
 - ✓ There is a risk of fire due to overheating.

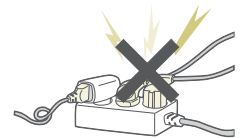

- When removing the power cord, make sure to hold the power plug when pulling the plug from the outlet.
 - ✓ Failing to do so may damage the plug or power outlet and result in fire or electric shock.

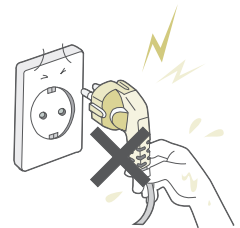

- When the washing machine is not being used, make sure to disconnect the power plug from the power outlet.
 - ✓ Failing to do so may result in result in accidental operation of the washing machine.

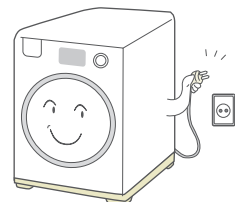

- Do not place or use gasoline, thinners, alcohol, or other flammable or explosive substances near the washing machine.
 - ✓ There is a risk of explosion and fire caused from electric sparks.
-

**WARNING****WHILE SERVICING**

- Check if the power plug and outlet are damaged, flattened, cut or otherwise degraded.
 - ✓ If faulty, replace it immediately.
 - Failing to do so may result in electric shock or fire.
 - Completely remove any dust or foreign material from the housing, wiring and connection parts.
 - ✓ This will prevent a risk of fire due to tracking and shorts in advance.
 - When connecting wires, make sure to connect them using the relevant connectors and check that they are properly connected.
 - ✓ Do not use tape instead of the connectors, it may cause fire due to tracking.
 - Make sure to discharge the PBA power terminals before starting the service.
 - ✓ Failing to do so may result in a high voltage electric shock.
 - When replacing the heater, make sure to fasten the nut after ensuring that it is inserted into the bracket-heater.
 - ✓ If not inserted into the bracket-heater, it touches the drum and causes noise and electric leakage.
 - Do not repair the washing machine without safety gloves.
 - ✓ It can cause injury.
-

**WARNING****AFTER SERVICING**

- Check the wiring.
 - ✓ Ensure that the wiring can not be damaged by any sharp edges or moving parts.
 - Check for any water leakage.
 - ✓ Perform a test run for the washing machine using the standard course and check whether there is any water leakage through the floor section or the pipes.
 - Advise consumers not to repair or service any part of the washing machine themselves.
 - ✓ This may result in personal injury and shorten the product lifetime.
-



**CAUTION****BEFORE SERVICING**

- Do not sprinkle water onto the washing machine directly when cleaning it.
 - ✓ This may result in electric shock or fire, and may shorten the product lifetime.



- Do not place any containers with water or any other liquid on the washing machine
 - ✓ If the water is spilled, it may result in electric shock or fire. This will also shorten the product lifetime.



- Do not install the washing machine in a location exposed to snow or rain.
 - ✓ This may result in electric shock or fire, and shorten the product lifetime.

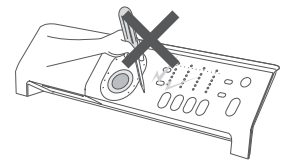

- Do not press a control button using a sharp tool or object.
 - ✓ This may result in electric shock or damage to the product.

**CAUTION****WHILE SERVICING**

- When wiring a harness, make sure to seal it completely so no liquid can enter.
 - ✓ Take care when disconnecting connectors, do not use excessive force as this may damage the connector.



- Check if there is any residue that shows that liquid entered the electric parts or harnesses.
 - ✓ If any liquid has entered into a part, replace it or completely remove any remaining moisture from it.

- If you need to place the washing machine on its back for servicing purposes, place a support(s) on the floor and lay it down carefully so its side is on the floor.
 - ✓ Do not lay it down on its front. This may result in the inside tub damaging parts.

- At least two people should work when working with heavy products.
-
-

2. FEATURES AND SPECIFICATIONS

2-1. SPECIFICATIONS





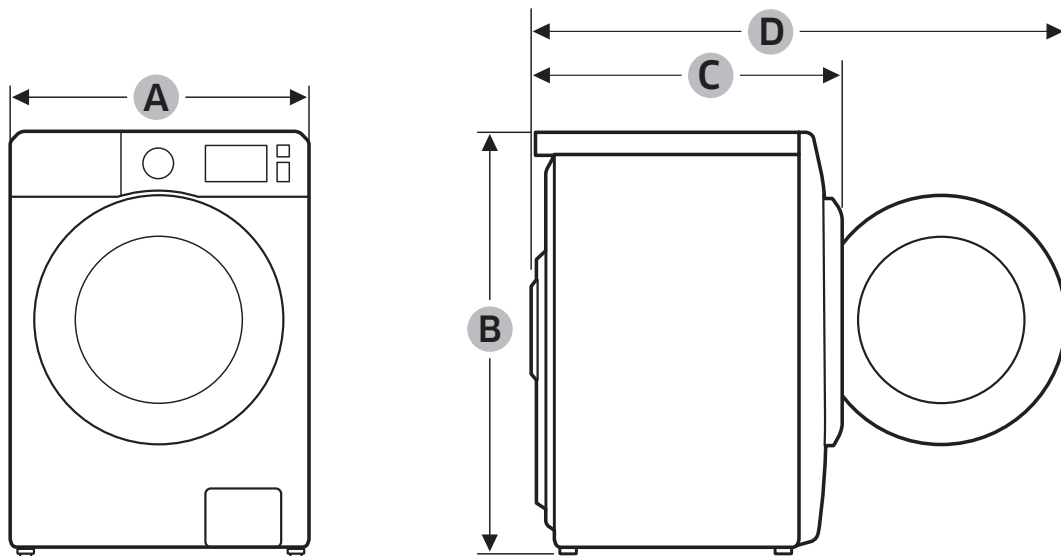

MODEL			WW90T654DLH	WW10T754DBH	WW90T986DSH	WW90T684DLH	WW90T534DAW	WW90T4540AX
Model name			Front loading washing machine					
Dimensions (mm)			600x850x550	600x850x600	600x850x600	600x850x550	600x850x550	600x850x550
Water pressure			50kPa-800kPa					
Net weight (kg)			70	74	75	70	68	68
Wash and spin capacity			9	10.5	9	9	9	9
Power consumption	Washing	220V	150W					
		240V	150W					
	Washing and heating	220V	2000W					
		240V	2400W					
	Spin	220V~240V	600W	600W	700W	600W	600W	600W
PUMPING			30W					
Spin revolutions			1400	1400	1600	1400	1400	1400

- please visit Samsung official website to receive most up-to-date information about software and product maintenance.









Model	WW90T654DLH	WW10T754DBH	WW90T986DSH	WW90T684DLH	WW90T534DAW	WW90T4540AX
Width (A)	600mm					
Height-Overall (B)	850mm					
Depth (C)	550mm	600mm	600mm	550mm	550mm	550mm
Depth with door open 90° (D)	1110mm	1160mm	1160mm	1110mm	1110mm	1110mm

2-2. COMPARING SPECIFICATIONS WITH EXISTING MODELS

Model name	WW90T654DLH	WW10T754DBH	WW90T986DSH	WW90T684DLH	WW90T534DAW	WW90T4540AX	WW6500K
Image							
Capacity	9	10.5	9	9	9	9	9
Main Spec	Drum Volume	63	70.5	65.9	63	63	63
	Max RPM	1400	1400	1600	1400	1400	1400
	Motor	DIT	DIT	DIT	DIT	DIT	BLDC
	Water Supply	Cold only	Cold only	Cold only	Cold only	Cold only	Cold only
	Drainage	Pump	Pump	Pump	Pump	Pump	Pump
USP	ECO BUBBLE	●	●	●	●	X	●
	Add Wash	●	●	●	●	X	●
	Steam	●	●	●	●	●	●
	AOW/AD	X/X	X/X	●/●	●/X	●/X	X/X
	Bubble Soak	●	●	●	●	●	X
	Super Speed	●	●	●	●	X	X
	Wifi	●	●	●	●	●	X
	Q-DRIVE	X	2nd	●	X	X	X
Design	DOOR	Good	Tint Door (Better)	Tint Door (Best)	Good	Basic	Basic
	Drum	Essential Diamond	Swirl+	Swirl+	Essential Diamond	Essential Diamond	Essential Diamond
	DISPLAY	Simple	Simple	Simple	Simple	Simple	LED
Dimension	600x850x550	600x850x600	600x850x600	600x850x550	600x850x550	600x850x550	600x850x550

2-3. OPTIONS SPECIFICATIONS





NO	Unit	Part Code	Figure	Description	Qty
1	Bolt Spanner	DC60-40146A		To remove the shipping bolts To adjust the leveling leg	1
2	Assy Hose Water	DC97-17845A (Cold) DC97-17845B (Hot)		To setup water supply.	Cold only 1, Cold+Hot 2(★)
3	Hose Water (Aqua-Stop)	DC67-00675A		To setup water supply.	1(★)
4	Manual Users	DC68-03649A-Z		To explain the product operation and installation	1
5	Cap Fixer	DC67-00307A		To cover the holes	3
6	Hose Hanger	DC67-00357A		To secure the drain hose.	1
7	Guide Liquid	DC61-03510A		To use liquid detergent.	1(★)

Note

- (★) is supplied for specific models only among those without water supply hoses.
- Customer can purchase additional water supply and drain hoses from a service center.
- For built-in models, the spanner, water supply and drain hoses are not supplied. Both the water supply and drain hoses are supplied during the installation.

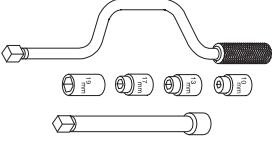
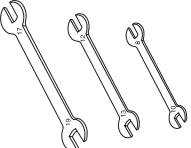
3. DISASSEMBLY AND REASSEMBLY

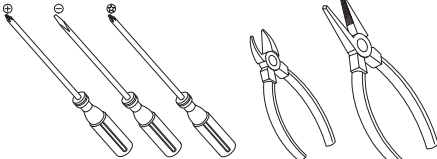
3-1. TOOLS FOR DISASSEMBLY AND REASSEMBLY

Tool	Type	Remarks
	Box driver	10mm Heater(1), Tub(12), Fixer screw(5), Motor(2), Balance(9) 13mm Shock Absorber (2 holes each in left/right), Damper(2), Damper(friction 2) 19mm Pulley(1)
	Double-ended spanner	10mm Replaced by box driver 13mm Leg 19mm
	Vice pliers	A Tool for protecting empty turning of bolt or abrasion from using box driver For disassembly of Spin drum
	Others (screwdriver, nipper, long nose pliers)	Common tools for servicing
	Torque wrench	The Tool for assembly of heater and Tub





- For information about purchasing parts and tool, please visit <http://www.samsung.com/support>

- For the part code information, please refer the attached file 'Exploded View'.



3-2. STANDARD DISASSEMBLY DRAWINGS

- ▶ This is a standard disassembly diagram and may differ from the actual product.
Use this material as a reference when disassembling and reassembling the product.



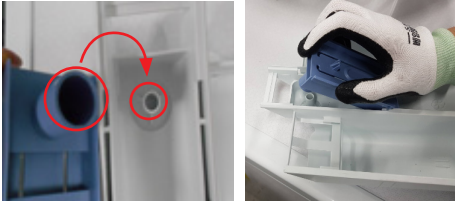

■ Disassembly

Part	Figure	Description
Assy Cover Top		<ol style="list-style-type: none"> 1. Remove 2 screws holding the Cover Top at the back of the unit using (+) screw driver.
		<ol style="list-style-type: none"> 2. Remove the Cover Top by lifting it up after pulling it back about 15mm.
Assy Drawer		<ol style="list-style-type: none"> 1. Open the Drawer by hand
		<ol style="list-style-type: none"> 2. While holding down the release lever inside the drawer (red box), slide open the drawer.
		<ol style="list-style-type: none"> 3. Pull up the Cap Rinse to remove it.



■ Reassembly

Part	Figure	Description
<p>Assy Drawer</p>		<p>1. Fit the hole and press the Cap Rinse so that it can be assembled.</p>
		<p>2. Make sure to fit the rail when reassembling the Assy drawer.</p>
		<p>3. Put the drawer in the right direction.</p>



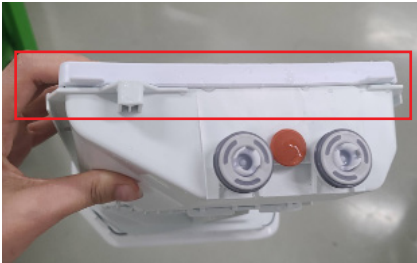

■ Disassembly

Part	Figure	Description
<p>Assy Drawer (Auto Dispense)</p>		<p>1. Pull to open the Drawer by hand.</p>
		<p>2. While holding down the release lever inside the drawer (red box) , slide open the drawer.</p>
	 	<p>3. Disassemble the Cover Drawer by hand.</p> <p>4. Pull up the Cap Rinse to remove it.</p>



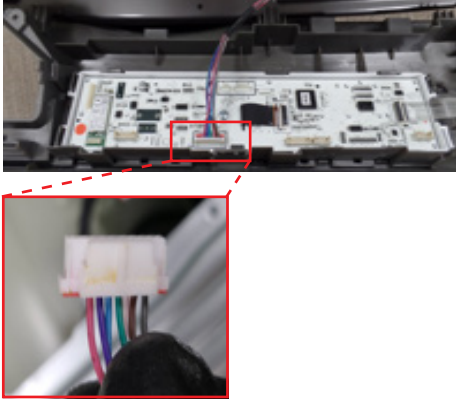

■ Reassembly

Part	Figure	Description
<p>Assy Drawer (Auto Dispense)</p>		<ol style="list-style-type: none"> 1. Fit the hole and press the Cap Rinse so that it can be assembled. 2. Assemble the Cover Drawer by hand.
		<ol style="list-style-type: none"> 3. Make sure to fit the rail when reassembling the Assy drawer.
		<ol style="list-style-type: none"> 4. Place the drawer in the right direction.



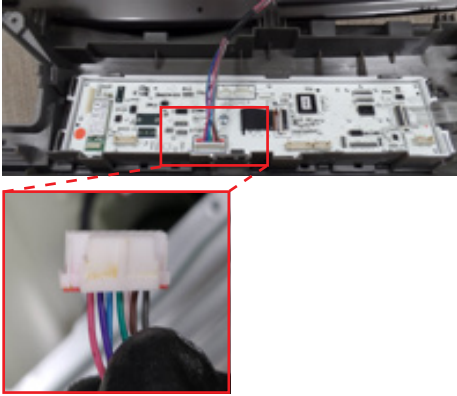

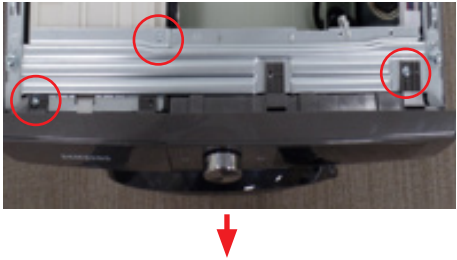
■ Disassembly

Part	Figure	Description
<p data-bbox="188 837 379 898">Assy Panel Control (Simple)</p> 		<p data-bbox="922 398 1434 454">- Before you start, disassemble Assy Cover Top, Assy Drawer.</p> <p data-bbox="922 465 1434 521">1. Remove 2 screws holding the drawer and panel using (+) screw driver.</p>
		<p data-bbox="922 674 1406 730">2. Remove the screws at the top of the ASSY-PANEL CONTROL using (+) screw driver. (3ea)</p>
		<p data-bbox="922 875 1410 958">3. Grab the panel and slightly push the housing drawer to remove the hook and pull the panel upwards to disassemble with body</p> <p data-bbox="956 981 1318 1010">☑ Be careful not to break the hook.</p>
		<p data-bbox="922 1234 1414 1346">4. Hold the ASSY-PANEL CONTROL while pulling it upwards and disassemble the terminal to remove it. Press the hook while removing the terminal.</p>





■ Reassembly

Part	Figure	Description
		<ol style="list-style-type: none"> 1. Connect the terminal by hand. Take a look at the hook and put it in the right place. <ul style="list-style-type: none"> ☑ Be careful not to break the hook. ☑ Make sure the Wire harness are not getting stuck in other parts.
<p>Assy Panel Control (Simple)</p> 	 	<ol style="list-style-type: none"> 2. Assemble the hook of housing drawer and assemble screws at the top of the ASSY-PANEL CONTROL with (+) screw driver.
		<ol style="list-style-type: none"> 3. Assemble 2 screws holding the drawer and panel with (+) screw driver.

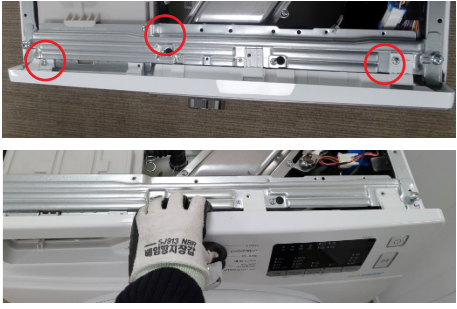

■ Disassembly

Part	Figure	Description
<p data-bbox="188 779 379 835">Assy Panel Control (LED)</p> 		<p data-bbox="927 416 1433 472">- Before you start, disassemble Assy Cover Top, Assy Drawer.</p> <p data-bbox="927 483 1433 539">1. Remove 2 screws holding the drawer and panel using (+) screw driver.</p>
		<p data-bbox="927 674 1433 730">2. Remove the screws at the top of the ASSY-PANEL CONTROL using (+) screw driver. (3ea)</p>
		<p data-bbox="927 831 1433 920">3. Grab the panel and slightly push the housing drawer to remove the hook and pull the panel upwards to disassemble with body.</p> <p data-bbox="959 931 1321 965">☑ Be careful not to break the hook.</p>
		<p data-bbox="927 1144 1433 1256">4. Hold the ASSY-PANEL CONTROL while pulling it upwards and disassemble the terminal to remove it. Press the hook while removing the terminal.</p>

■ Reassembly

Part	Figure	Description
<p data-bbox="188 750 379 806">Assy Panel Control (LED)</p> 		<p data-bbox="922 481 1401 537">1. Connect the terminal by hand. Take a look at the hook and put it in the right place.</p> <p data-bbox="959 548 1425 604">☑ Make sure the Wire harness are not getting stuck in other parts.</p>
		<p data-bbox="922 862 1425 940">2. Assemble the hook of housing drawer and assemble screws at the top of the ASSY-PANEL CONTROL with (+) screw driver.</p> <p data-bbox="959 952 1321 985">☑ Be careful not to break the hook.</p>
		<p data-bbox="922 1198 1385 1254">3. Assemble 2 screws holding the drawer and panel with (+) screw driver.</p>

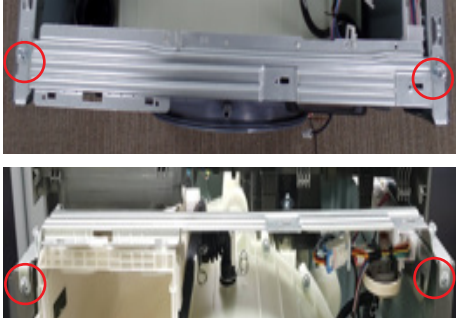
■ Disassembly

Part	Figure	Description
Assy Housing-Drawer		<p>Before you start, disassemble Assy Cover Top, Assy Panel Control.</p> <ol style="list-style-type: none"> 1. Remove 4 screws to disassemble frame plate-up using (+) screw driver.
		<ol style="list-style-type: none"> 2. Remove the Band-ring. (2ea) <ul style="list-style-type: none"> ☑ Be careful not to break the hose.

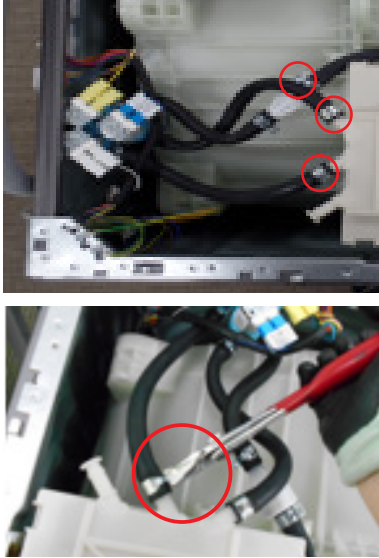
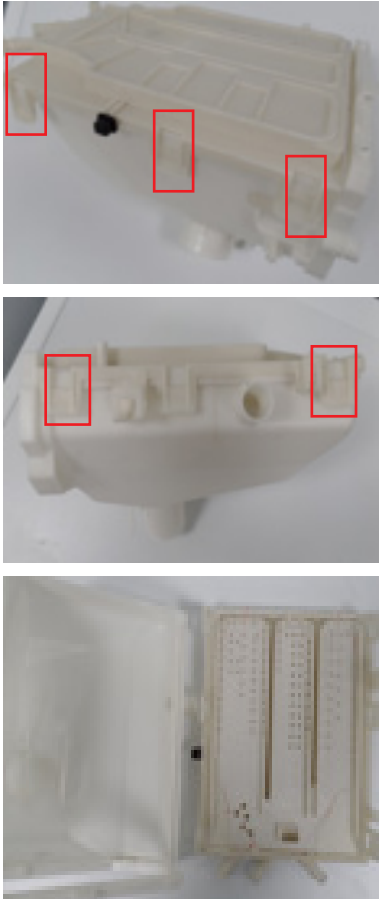
Part	Figure	Description
Assy Housing-Drawer		<p>3. Separate the water valve hose with long nose plier.</p>
		<p>4. Separate Housing Drawer low by pressing the hooks on both sides by hand. To fully separate, disassemble Water Valve.</p> <p><input checked="" type="checkbox"/> Be careful not to break the hook.</p>

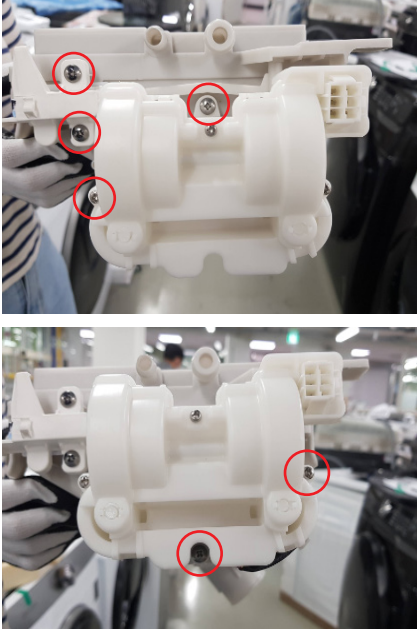
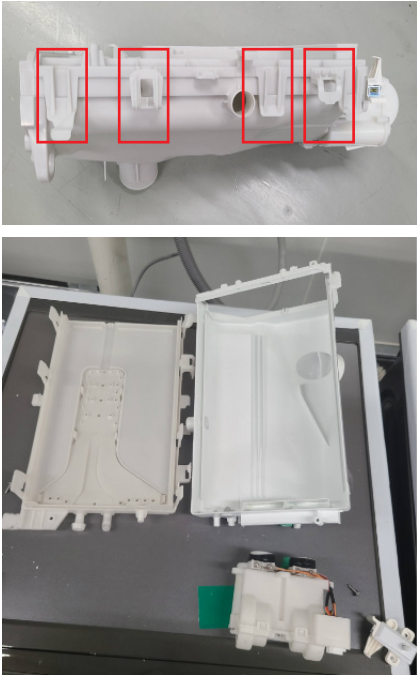
Part	Figure	Description
		<ol style="list-style-type: none"> 1. Disassemble the 6 screws holding the pump with (+) screw driver. To fully separate, disassemble Water Valve.
Assy Housing Drawer (Auto Dispense)		<ol style="list-style-type: none"> 2. Separate Housing Drawer low by pressing the hooks on both sides by hand. To fully separate, disassemble Water Valve.

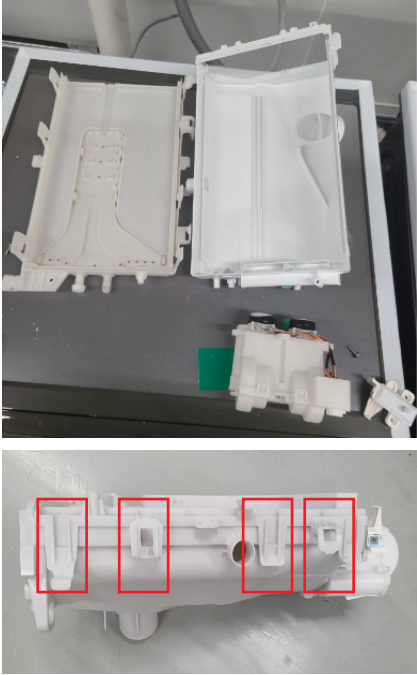
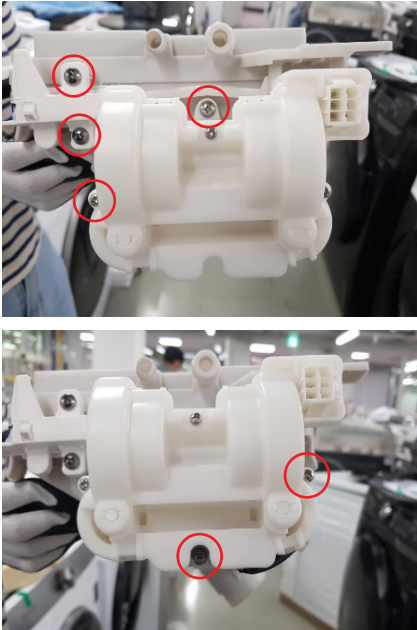

Part	Figure	Description
Assy Housing Drawer (Auto Dispense)		<ol style="list-style-type: none"> 1. Assemble the Housing Drawer low by pressing the hooks on both sides by hand.
		<ol style="list-style-type: none"> 2. Assemble the 6 screws holding the pump with (+) screw driver.

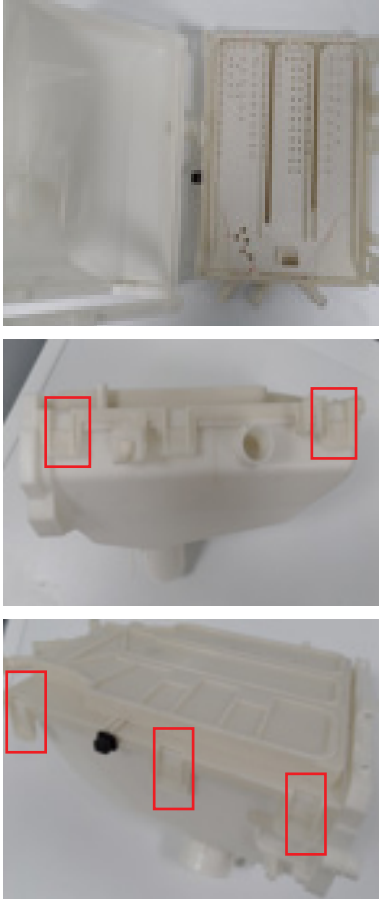
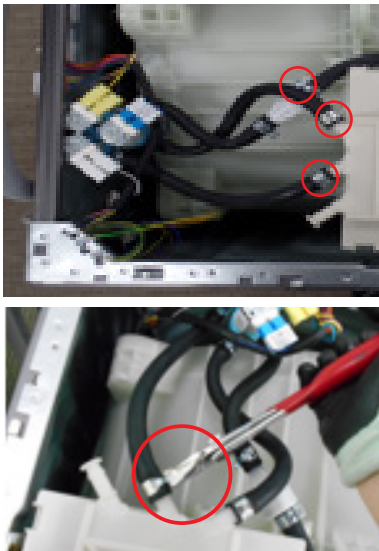

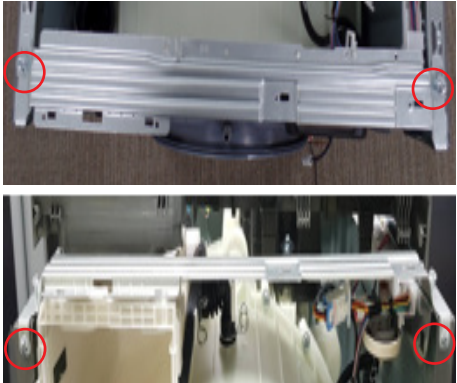

■ Reassembly

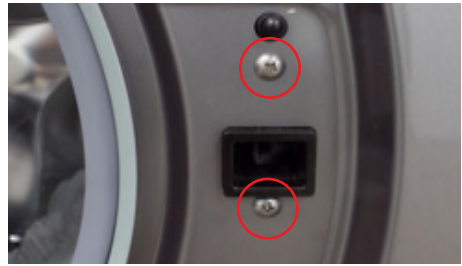
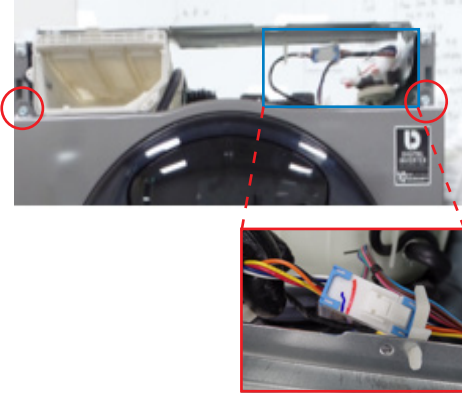
Part	Figure	Description
<p>Assy Housing-Drawer</p>		<ol style="list-style-type: none"> Assemble the Housing Drawer low by pressing the hooks on both sides by hand. <ul style="list-style-type: none"> ☑ Be careful not to break the hose.
		<ol style="list-style-type: none"> Assemble the water valve hose with long nose plier. <ul style="list-style-type: none"> ☑ Be careful not to break the hook. ☑ Make sure to insert the hoses and assemble the clamp, band rings correctly. There're risks of leakage or poor performance when it's misassembled.

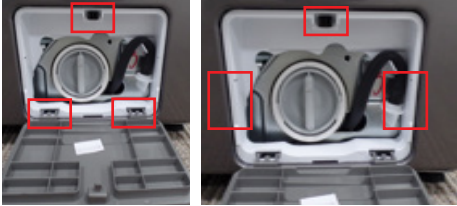

Part	Figure	Description
Assy Housing-Drawer		<p>3. Assemble the Band rings. (2ea)</p> <p>☑ Make sure to insert the hoses and assemble the clamp, band rings correctly. There're risks of leakage or poor performance when it's misassembled.</p>
		<p>4. Remove 4 screws to disassemble frame plate-up using (+) screw driver.</p>

■ Disassembly

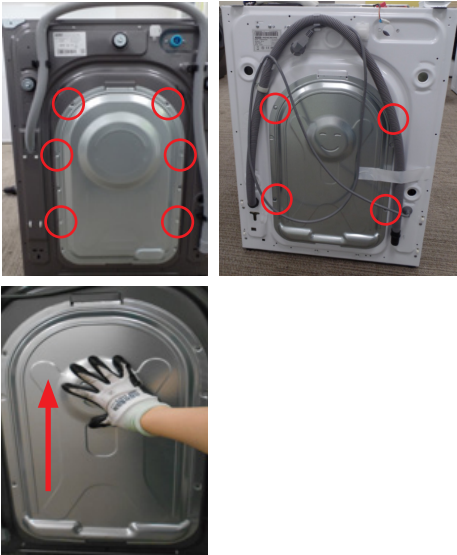

Part	Figure	Description
Frame Front		<p>Before you start, disassemble Assy Cover Top, Assy Panel Control.</p> <p>☑ Be careful not to tear up the diaphragm.</p> <p>1. Using long nose pliers, pick up one of the rings on Wire-Diaphragm which connect the spring and the wire ends. Then, separate the Wire-Diaphragm from the FRAME-FRONT and Disconnect the Diaphragm.</p>
		<p>2. Remove 2 screws holding the DOOR-LOCK switch with (+) screw driver.</p>
		<p>3. Disassemble the terminal (the blue box is terminal location) by pressing the blue circle part and remove 2 screws holding the Frame Front with (+) screw driver.</p>
		<p>4. Press the circled place to open up the cover filter.</p>
		<p>5. Remove 3 screws holding the bottom of the FRAME-FRONT with (+) screw driver.</p>

Part	Figure	Description
Frame Front		<p>6. Remove cover filter by hand.</p> <p>7. Press the hook to remove Guide cover filter using (-) screw driver.</p> <p> Be careful not to break the hook.</p>
		<p>8. Pull the Guide filter towards you.</p>
		<p>9. Lift Frame front up to disassemble.</p>
Cover-Back		<p>Unfasten 6(Depending on the model, there can be 4 screws) screws that hold the cover back in place with (+) screw driver.</p> <p>Remove the back cover by sliding it up. (When assembling, slide the back cover down.)</p>

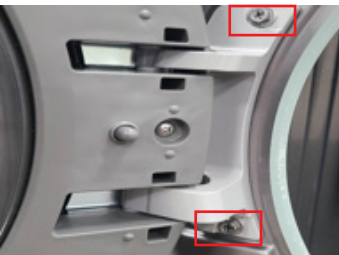

■ Disassembly

Part	Figure	Description
		<p>Before you start, disassemble Assy Cover Top, Assy Panel Control and Frame Front.</p> <ol style="list-style-type: none"> 1. Remove the wire by disassembling the 3 hooks using long nose plier.
Assy Door		<ol style="list-style-type: none"> 2. Disassemble the terminal and remove the holders using long nose pliers.
		<ol style="list-style-type: none"> 3. Remove 2 screws holding the Assy door. Remove the door by slightly lifting the door.



■ Reassembly

Part	Figure	Description
	 <p style="text-align: center;">BACK SIDE FRONT SIDE</p>	<p>1. Put the terminal through the biggest hole and assemble 3 hooks as shown in the pictures.</p>
		<p>2. Assemble the door with Frame Front by fitting the two hooks and assemble 2 screws holding the Assy door with (+) screw driver.</p>
Assy Door		<p>3. Assemble 3 hooks using hand.</p>
		<p>4. Assemble the terminal and the holders.</p> <p><input checked="" type="checkbox"/> Make sure the Wire harness are not getting stuck in other parts.</p>

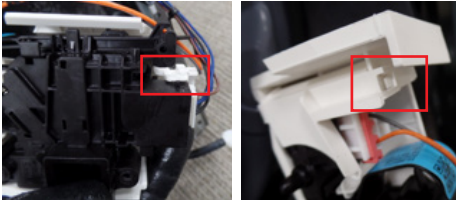
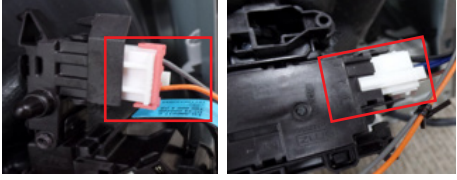
■ Disassembly

Part	Figure	Description
Door-Lock S/W		<p>Before you start, disassemble Assy Cover Top and Assy Panel Control.</p> <ol style="list-style-type: none"> 1. Open the Door. Remove the Wire Diaphragm and remove the Frame Front.
		<ol style="list-style-type: none"> 2. Remove 2 screws with (+) screw driver.
		<ol style="list-style-type: none"> 3. Remove Cover Door Switch by gently pushing the red box part with (-) screw driver.
		<ol style="list-style-type: none"> 4. Disassemble the terminals. (2ea)

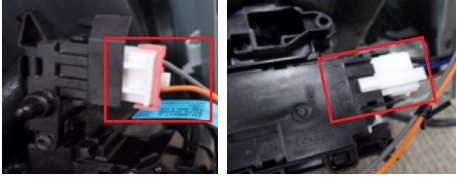
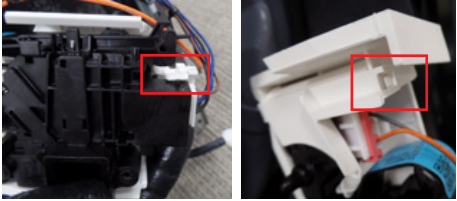

■ Reassembly

Part	Figure	Description
Door-Lock S/W		<p>1. Assemble the terminals. (2ea)</p> <p><input checked="" type="checkbox"/> Make sure the Wire harness are not getting stuck in other parts.</p>
		<p>2. Assemble the Cover Door Switch by gently pushing the red box part with hand.</p> <p><input checked="" type="checkbox"/> Make sure the Wire harness are not getting stuck in other parts.</p>
		<p>3. Assemble the screws with (+) screw driver. (2ea)</p> <p>4. Assemble the wire diaphragm and Frame Front. If the wire diaphragm is loose after assembly or is not correctly assembled at the correct position (5 o'clock or 7 o'clock), water leakage may occur.</p>





■ How to force open the locked Door

Part	Figure	Description
Door-Lock S/W		<p>Before you start, disassemble Cover Top first</p> <p>1. Put your hand to press the Door-Lock Switch. (The location you need to press is shown in the picture with arrow)</p>

■ Disassembly

Part	Figure	Description
Diaphragm		<p>Before you start, remove cover top, Assy Drawer, Assy Panel Control and Frame Front.</p> <ol style="list-style-type: none"> 1. Remove hose and clamp with long nose plier, and unfasten the screw with (+) screw driver.
		<ol style="list-style-type: none"> 2. Pull diaphragm towards you. <ul style="list-style-type: none"> ⚠ Be careful not to rip diaphragm.

■ Reassembly

Part	Figure	Description
Diaphragm		<p>1. Assemble the Diaphragm with tub by hand. Diaphragm and tub has triangle part make sure to fit them correctly.</p>
		
		<p>2. Assemble hose and clamp with long nose plier, and fasten the screw with (+) screw driver.</p>
		

4. TROUBLESHOOTING

4-1. INFORMATION CODE

- When an abnormal condition occurs, melody sounds and displays Info. code indications as shown in the following Info. codes are shown until the status has cleared.

No.	Information Type	Information Code	Causes	Corrective Actions
1	Water Level	1C	<ul style="list-style-type: none"> - The part of the hose where the water level sensor is located is damaged (punctured). - The hose is clogged with foreign material. - The hose is folded. - Too much lubricant has been applied to the insertion part of the air hose. - Hose engagement error (disengaged) - Part fault (Faulty internal soldering) - The water level sensor terminal is disengaged. - Main PBA fault 	<ul style="list-style-type: none"> • Water level sensor fault. • The water level sensor terminal is disengaged. • The part of the hose where the water level sensor folded. • Main PCB fault.
2	Motor	3C	<ul style="list-style-type: none"> - The PBA connector terminal is not connected. - The motor spin net is not engaged. - The motor's internal coil is damaged (short-circuited or cut) - Foreign material (a screw) has entered the motor. 	<ul style="list-style-type: none"> • Washing motor fault. • Check Washing motor connector . • Washing motor rotor/stator fault. • Main PCB fault .
		3C1	<ul style="list-style-type: none"> - Motor overloaded due to too much laundry (Non sensing) - PBA fault 	
		3C2	<ul style="list-style-type: none"> - The motor driving error from the PBA is weak : Unstable relay operation, etc. 	
		3C3	<ul style="list-style-type: none"> - The IPM terminal of the main PBA is not connected. - The DD motor cover is out of place. 	
		3C4	<ul style="list-style-type: none"> - The PCB housing terminal is not connected. - PBA fault - DD motor fault 	
3	Water Supply	4C	<ul style="list-style-type: none"> - Foreign material is entering the water supply valve. - The water supply valve terminal is not connected. (Wire disconnected) - The warm water and rinse connectors are wrongly connected to each other. - This occurs if the PCB terminal from the drain hose to the detergent drawer is not connected. Check whether the transparent hose is folded or torn. - This occurs Water pressure is weak, a certain time delay. - This occurs Water Valve by freezing in winter season. 	<ul style="list-style-type: none"> • Water supply valve fault. • Main PCB fault. • Freezing by winter season.
		4C2	<ul style="list-style-type: none"> - The water temperature is sensed as higher than 50 °C in the Wool or Lingerie courses 	-
4	Drain	5C	<ul style="list-style-type: none"> - The pump motor impeller is damaged internally. - The wrong voltage (220 V → 110 V) is supplied to the parts. - Part fault - This occurs due to freezing in the winter season. - The drain hose is clogged. (Injection error, foreign material) - Clogged with foreign material. - The water pump terminal is not connected : rubber band, bills, cotton, hair pins, coins. 	<ul style="list-style-type: none"> • Drain pump fault. • Freezing by winter season. • Check inside foreign material of drain pump. • Main PCB fault.

No.	Information Type	Information Code	Causes	Corrective Actions
5	Communication	AC	<ul style="list-style-type: none"> - The signals between the sub and main PBAs are not sensed because of a communications error. - Check the connector connections between the sub and main PBAs carefully. → Check for incorrect or loose connections, etc. - Remove the sub PBA C/Panel and check for any faulty soldering. 	<ul style="list-style-type: none"> • Main PCB and Sub PCB Signal Detection fault. • Main PCB and Sub PCB wire connection fault.
6	SWITCH (Main relay)	BC2	<ul style="list-style-type: none"> - A button other than the Power button is continually pressed (for more than 30 seconds). - Deformation of an internal plastic injection part. - A screw for assembling the sub PBA is tightened too much. 	<ul style="list-style-type: none"> • When pressed Power button. • When pressed button except for power button. • Main PCB relay fault.
7	COOLING	CC	<ul style="list-style-type: none"> - When the temperature of the water is greater than or equal to 55 °C, this code appears when the machine does not drain. (reason : It is unsafe for hot water to drain as may burn if touched). - Temperature sensor fault, or incorrect use. 	<ul style="list-style-type: none"> • Washing temperature sensor check. • Description PL Accident prevention.
8	DOOR	dC	<ul style="list-style-type: none"> - A switch contact error because of a deformation of the door hook. - When the door is pulled by force. - This occurs in the hot washes because the door is pushed due to a pressure difference from internal temperature changes. - S/W contact fault because of LID TC "L" transformation. 	<ul style="list-style-type: none"> • Door lock switch fault. • Drain pump fault. • Dry duct fan motor fault. • Main PCB fault .
		dC1	<ul style="list-style-type: none"> - The door lock switch terminal is connected incorrectly. - The door lock switch terminal is broken. - This occurs due to Low insulation of the wiring assy - Main PCB fault 	
		dC2	<ul style="list-style-type: none"> - This occurs if the Power switch is turned on/off continually and too much heat is generated (This error is difficult to be reproduced.) 	
9	HEATER	HC	<ul style="list-style-type: none"> - The washing heater is short-circuited or has a wire disconnected. 	<ul style="list-style-type: none"> • Heater fault. • Red temperature sensor at the center of the dry heater. • Steam function fault. • Freezing by winter season.
		HC1	<ul style="list-style-type: none"> - The washing heater in the tub has an error.(Contact error, temperature sensor fault) - If the water level sensor operates without water because water is frozen or for any other reason and the temperature sensor engaged at the bottom to prevent overheating for the washing heater detects a temperature of 100 to 150 °C, the washing machine turns the input power off. 	
		HC2	<ul style="list-style-type: none"> - This error occurs when the red temperature sensor at the center of the dry heater operates (at a temperature higher than 145 °C) : Corrective action – Press the button at the center lightly. The washing machine will operate normally. Alternatively, replace the temperature sensor if the temperature sensing is unstable because of functional degradation. 	

No.	Information Type	Information Code	Causes	Corrective Actions
10	Water Leakage	LC LC1	<ul style="list-style-type: none"> - Heater engagement fault. (out of place) - The air hose is out of place and water leakage occurs during the spin cycle. - The tub back at the safety bolts fixing part is broken. - Water leakage occurs at the front with foaming because of too much detergent. - Water leakage occurs because the connecting hose to the detergent drawer is connected incorrectly. - The drain pump filter cover is engaged incorrectly. - Water leakage occurs at the drain hose. - The duct condensing holding screws are worn. - The nozzle-diaphragm is engaged in the opposite direction or the rubber packaging is omitted. - Water leakage occurs because the screws that hold the tub back and front in place are fastened incorrectly. - The leakage sensor is faulty. 	<ul style="list-style-type: none"> • Check Water Leakage. • DV CASE foreign material occurs. • Leakage of the product inside the hose and parts molded problem.
11	OVER FLOW	OC OF	<ul style="list-style-type: none"> - Water is supplied continually because the water level detection does not work. - Because the drain hose is clogged and there is an injection error (at a narrow section), the water level detection does not work and water is supplied continually. - Water is supplied continually because of freezing or because there is foreign material in the water supply valve. - This may occur when the sensor is faulty or the pressure tube is blocked or damaged. 	<ul style="list-style-type: none"> • Water level sensor fault. • Freezing by winter season .
12	Temperature Sensor	TC1	<ul style="list-style-type: none"> - The washing heater in the tub has an error. (Contact error, temperature sensor fault) - The connector is connected incorrectly or is disconnected. - If the water level sensor operates without water because the water is frozen or for any other reason and the temperature sensor engaged at the bottom to prevent overheating for the washing heater detects a temperature of 100 to 150 °C, the washing machine turns the input power off. 	<ul style="list-style-type: none"> • Washing temperature sensor check. • Dry temperature sensor check • Dry condensing temperature sensor check. • Problems caused by the main PCB fault. • Problems caused by the freezing in winter.
		TC2	<ul style="list-style-type: none"> - The temperature sensor for the duct assy fan housing is faulty. (A sensor fault such as an internal short-circuit or wire disconnection) - The connector is out of place or has a contact error. 	
		TC3	<ul style="list-style-type: none"> - This occurs when the duct condensing temperature sensor is open. - This occurs when the duct condensing temperature sensor has a wire disconnected or is short-circuited. 	
13	UNBALANCE	UB	<ul style="list-style-type: none"> - As laundry causes this error, check the laundry. - Find the reason for the unbalance and solve it as directed in the user manual. 	<ul style="list-style-type: none"> • This occurs by laundry.

No.	Information Type	Information Code	Causes	Corrective Actions
14	Power	UC (9C)	<ul style="list-style-type: none"> - Power condition fault. - This occurs when under or over voltage is supplied. - Extension lead or plug adapter is being used. - Main PBA fault (sometimes) 	<ul style="list-style-type: none"> • Check the power supply, polarity and voltage. • Select a hot wash or dry cycle (wd only), measure the voltage supplied during heating. (A error occurs when under voltage is detected.) * Safety ensure safe working practices observed when testing live appliance. • Check if a socket outlet adaptor is being used. • Main PCB fault (sometimes)
15	Mems PBA	8C	<ul style="list-style-type: none"> - Error detected in the Mems PBA or data error detected. 	<ul style="list-style-type: none"> • Check the wire connections. Replace if necessary. <ol style="list-style-type: none"> 1. Check the wire connections. 2. Replace the Mems PBA. 3. Main PBA wire connection error or PBA's silver nano part malfunction. Replace if necessary.
16	Add Door	DDC	<ul style="list-style-type: none"> - A switch contact error because of damage to the Add Door switch. - When the add door is pulled by force. - This occurs in the hot wash because the add door is pushed due to a pressure difference from internal temperature changes. - S/W contact fault because of LID TC "L" transformation. 	<ul style="list-style-type: none"> • Add door open/close switch fault. • Main PCB fault.
		DC3	<ul style="list-style-type: none"> - The Add Door lock switch terminal is connected incorrectly. - The Add Door lock switch terminal is broken. - This occurs due to Low insulation of the wiring assy. - Main PCB fault. 	<ul style="list-style-type: none"> • Add door lock switch fault. • Main PCB fault.
17	Detergent Drawer Motor	6C	<ul style="list-style-type: none"> - Auto detergent dispense motor constrain - Auto detergent dispense motor wiring - Auto detergent dispense motor not operate 	<ul style="list-style-type: none"> • Check motor operation by pressing the laundry when you enter auto detergent dispenser. • If not operation change ASSY PUMP DRAIN.
18	Auto Dispense	6C1	- The input arrest of the detergent motor is sensed.	<ul style="list-style-type: none"> Check the wire and if necessary replace it. <ol style="list-style-type: none"> 1. Check Wire connection 2. Replace Assy Pump
		6C2	- The non-operation of the detergent motor is sensed.	
		6C3	- The in put arrest of the fabric softener motor is sensed.	
		6C4	- The non-operation of the fabric softener motor is sensed.	
		6C5	- The motor motion perception sensor fault	
		6C6	- The detergent level perception sensor fault	
		6C7	- The fabric softener level perception sensor fault	

4-2. PROBLEM CHECK POINT

PROBLEM	SOLUTION
The washing machine won't start.	<ul style="list-style-type: none"> • Make sure the washing machine is plugged in. • Make sure the door is properly closed. • Make sure the water tap is open. • Tap Start or Press Start/Pause button again.
Water supply is insufficient, or no water is supplied.	<ul style="list-style-type: none"> • Open the water tap fully. • Make sure the water supply hose is not frozen. • Make sure the water supply hose is not kinked or clogged. • Clean the filter on the water supply hose.
The washing machine vibrates badly, or makes noise.	<ul style="list-style-type: none"> • Make sure the washing machine is installed on a level floor. If the floor is not level, use the leveling feet to adjust the level. • Make sure that the shipping bolts are removed. • Make sure the washing machine is not touching any other object. • Make sure the laundry load is balanced.
The washing machine does not drain and/or spin.	<ul style="list-style-type: none"> • Make sure the drain hose is straightened all the way to the drain system. • Make sure the debris filter is not clogged.
The door won't open.	<ul style="list-style-type: none"> • Press the Start/Pause button to stop the washing machine. • The door stays locked as long as the washing machine is still hot inside after a heating operation. • It may take several seconds to disengage the door lock mechanism.
Button Check	<ul style="list-style-type: none"> • bC occurs. Refer the bC troubleshooting.
Can I open the Add Door at any time?	<ul style="list-style-type: none"> • The Add Door can be opened only when the indicator appears. However, it does not open in the following cases: <ul style="list-style-type: none"> - When the water temperature is above 55deg or the drying process is running, when the drum is rotating, at any point on the ECO drum clean cycle. - If you set the Child Lock for safety reasons. - When the drum wash or drum drying cycle is running that does not involve additional laundry.

5. WIRING DIAGRAM

5-1. WIRING DIAGRAM (SIMPLE)

► This Document can not be used without Samsung's authorization.



■ REFERENCE INFORMATION

BLK	BLACK
BLU	BLUE
GRN	GREEN
GRY	GRAY
NTR	NATURAL
ORG	ORANGE
PNK	PINK
RED	RED
SKYBLU	SKYBLUE
VIO	VIOLET
WHT	WHITE
YEL	YELLOW

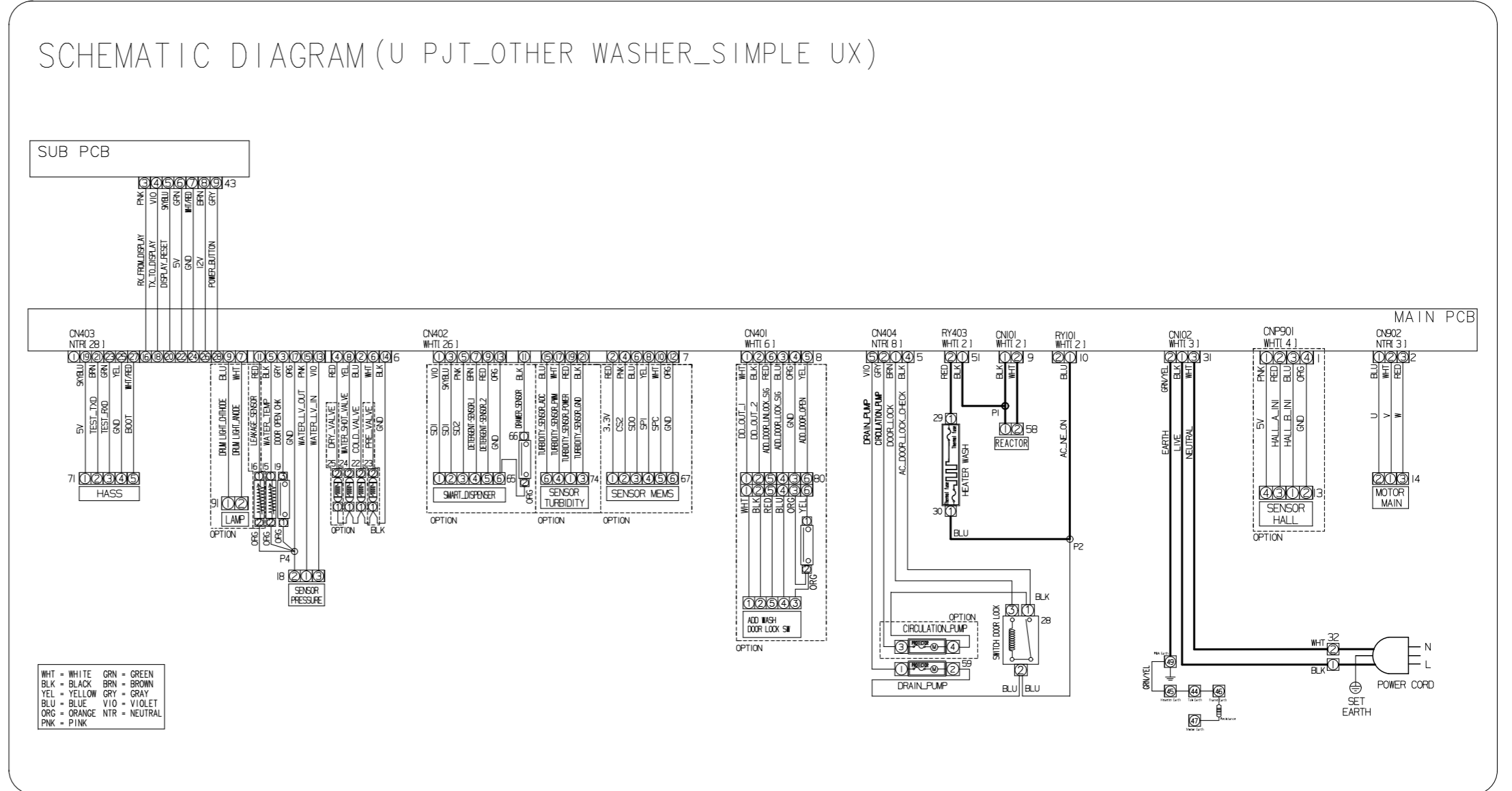

5-2. WIRING DIAGRAM (LED)

► This Document can not be used without Samsung's authorization.



REFERENCE INFORMATION

BLK	BLACK
BLU	BLUE
GRN	GREEN
GRY	GRAY
NTR	NATURAL
ORG	ORANGE
PNK	PINK
RED	RED
SKYBLU	SKYBLUE
VIO	VIOLET
WHT	WHITE
YEL	YELLOW

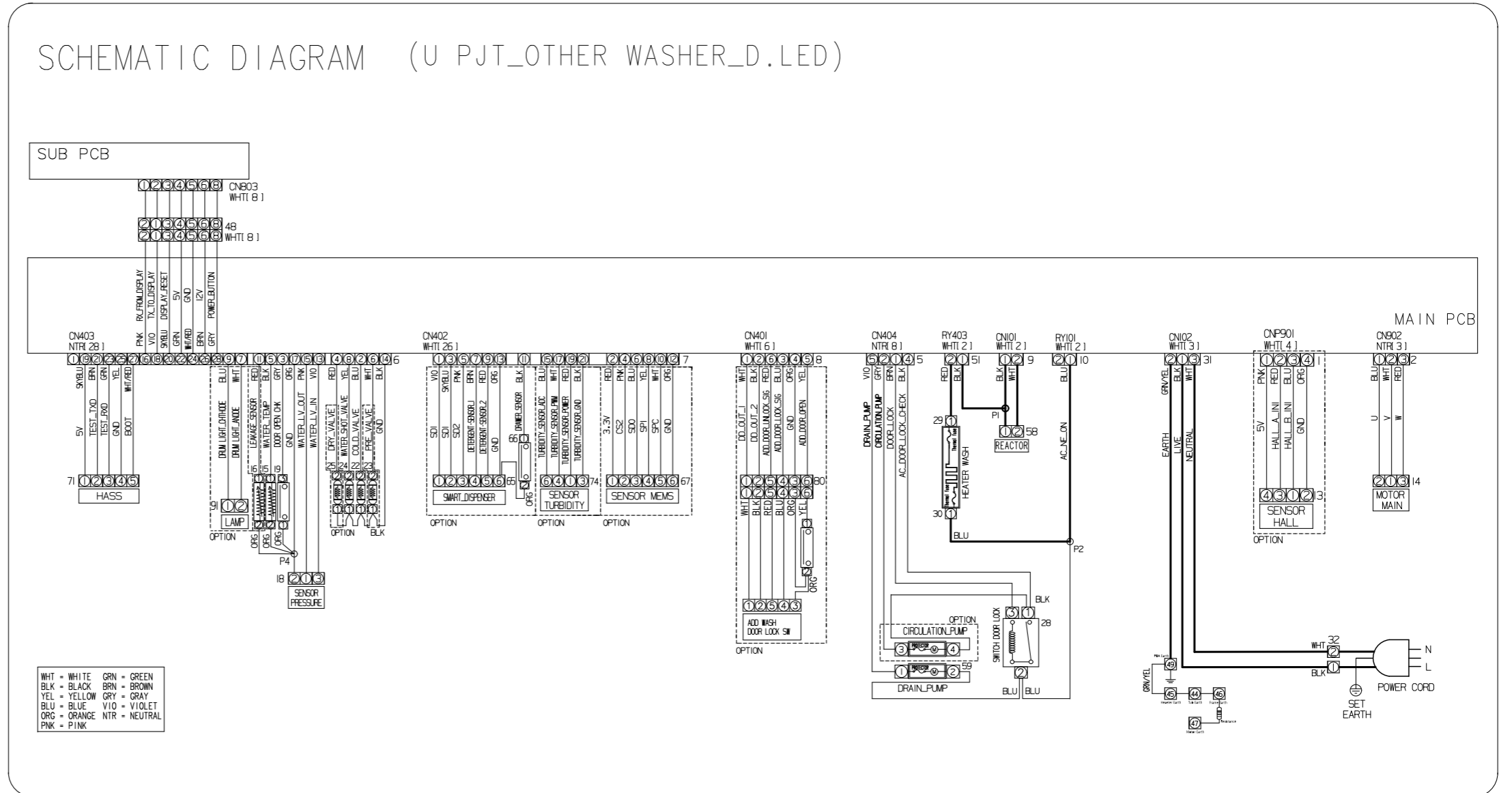

5-3. WIRING DIAGRAM (Q-DRIVE)

► This Document can not be used without Samsung's authorization.



REFERENCE INFORMATION

BLK	BLACK
BLU	BLUE
GRN	GREEN
GRY	GRAY
NTR	NATURAL
ORG	ORANGE
PNK	PINK
RED	RED
SKYBLU	SKYBLUE
VIO	VIOLET
WHT	WHITE
YEL	YELLOW

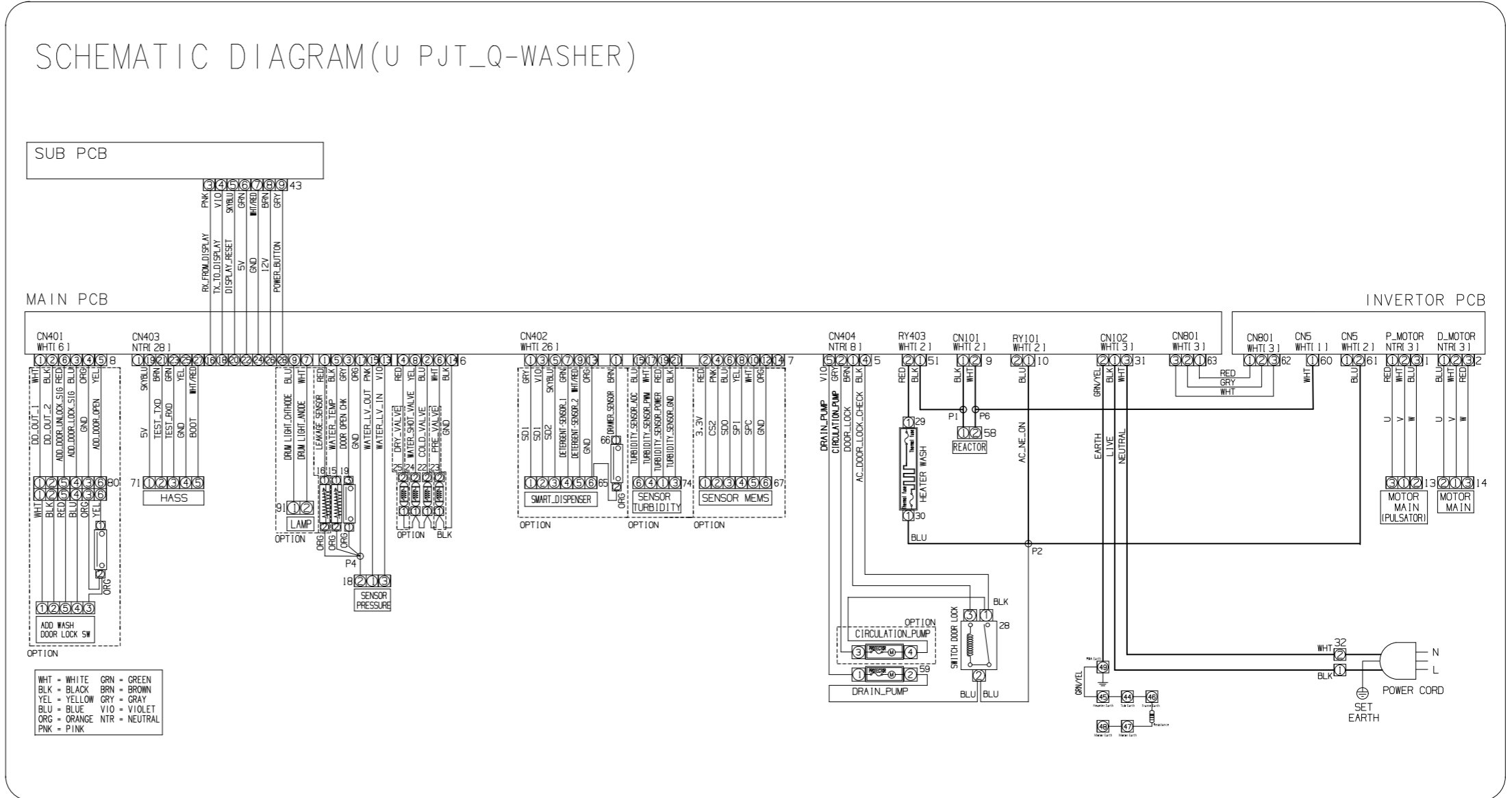

6. REFERENCE

6-1. WW6000T PROJECT NAME

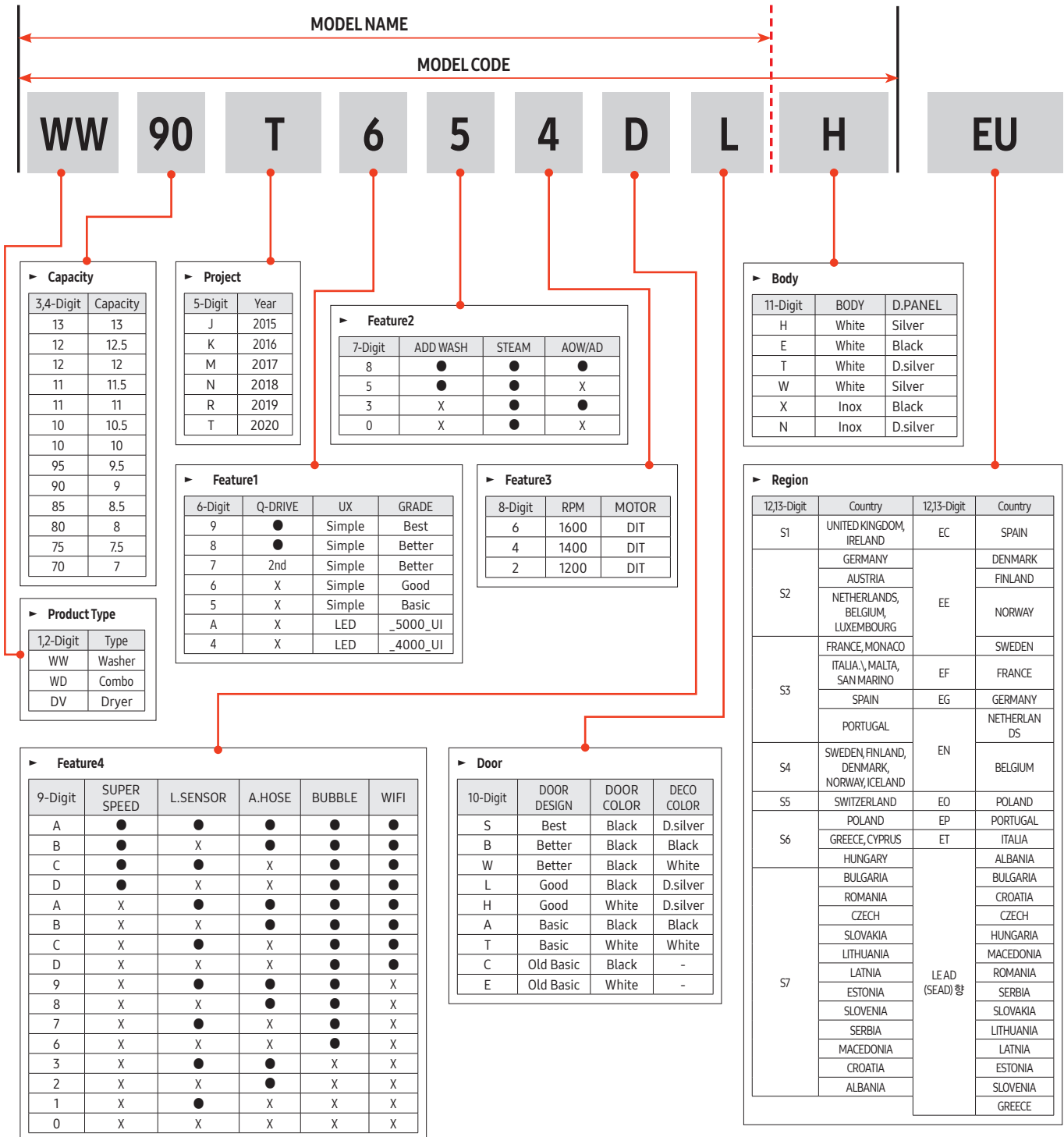

6-2. TERMINOLOGY

1. Drain Pump	The pump that drains the water from the washing machine generated while the washing machine is running
2. Heater	The heater is located on the tub inside the washing machine. It heats the water to increase wash efficiency.
3. Door Lock Switch	Detects whether the door of the washing machine is open or closed if the door is open while the washing machine is running the cycle is temporary stopped.



GSPN (GLOBAL SERVICE PARTNER NETWORK)

Area	Web Site
Europe, CIS, Mideast & Africa	gspn1.samsungcspportal.com
Asia	gspn2.samsungcspportal.com
North & Latin America	gspn3.samsungcspportal.com
China	china.samsungportal.com

This Service Manual is a property of Samsung Electronics Co.,Ltd.
Any unauthorized use of Manual can be punished under applicable
International and/or domestic law.

© 2020 Samsung Electronics Co.,Ltd. All rights reserved.

Printed in Korea