

Hisense User Manual

VIDAA U5

Contents

Live TV	5
Channel Scan.....	5
Channel List.....	7
Channel Edit.....	9
Favourite.....	10
Guide (EPG).....	11
PVR.....	13
Recording List.....	14
Timeshift.....	16
Connection	18
Wired Internet Connection.....	18
Wireless Internet Connection.....	19
Connecting Bluetooth Devices.....	20
Connecting Headphones.....	22
Connecting USB Devices.....	22
Connecting an Antenna.....	23
Connecting Audio Visual (AV) Devices.....	23
Connecting Speakers or Other Audio Receivers.....	25
Connecting a Digital Audio System to Use ARC/eARC.....	25
Using HDMI & CEC.....	26
Connecting a PC or a Game Console.....	28
Multi-screen	29
Screen Sharing.....	29
Content Sharing.....	29
Smart Functions	31
Getting Familiar with the Home Screen.....	31
Using a VIDAA Account.....	34
Using Voice Service.....	34
Media.....	40
App.....	43

Installing Mobile App to Control your TV.....	44
Picture and Sound.....	45
Adjusting the Picture Quality.....	45
Game Mode Settings.....	50
Adjusting the Sound Quality.....	51
Speakers Settings.....	54
Using Headphones.....	55
Accessibility and System.....	56
Accessibility.....	56
Setting Time.....	56
Using Timer.....	57
Using Parental Control.....	58
Setting Language and Location.....	58
Using Power Indicator.....	59
Enhanced Viewing.....	59
Setting Usage Mode.....	60
Using Remote Control Service.....	60
Upgrade.....	61
Reset to Factory Default.....	62
Troubleshooting.....	63
Picture Issues.....	63
Sound Issues.....	64
Network Issues.....	64
External Device Connection Issues.....	65
Apps.....	66
Media Files.....	66
Voice Service Issues.....	66
TV Status Diagnosis.....	67
Recording/Timeshift Issues.....	67
Other Issues.....	68
Using the E-Manual.....	69
Launching the E-Manual.....	69
Using the buttons in the E-Manual.....	69

Live TV

Channel Scan

You can scan for channels automatically or manually.



Note:

- Satellite/antenna/cable function may not be applicable in some models/countries/regions.

Auto Scan

Automatically scan for channels to view programmes from TV source.

INPUT > TV

Alternatively, in Live TV,   > **Settings** > **Channel** > **Auto Scan**.

If no TV channels were saved before, you will be prompted to do a channel search.

Satellite

- **Single satellite:** You can use single satellite if you only have one satellite equipped.
- **DiSEqC:** You can choose DiSEqC if you have DiSEqC equipment. Up to four satellites in DiSEqC 1.0 mode can be installed.

If you are using a motorized antenna, you can use DiSEqC 1.2 mode.

- **Unicable:** If your house is equipped with Unicable satellite distribution, you should use this option.

Please make sure that you know the Unicable band and frequency that can be used. The information should be available on the equipment or the landlord can provide it.

Antenna

- **Channel:** Select from **All Channels** or **Free Channels**. This option may not be available depending on countries/regions/operators.
- **Scan Mode:** Select from digital channels only (DTV), digital and analogue channels (DTV+ATV) or analogue channels only (ATV).

If you receive DVB-T or DVB-T2 signal, you can use DTV.

- **LCN:** Switch on/off LCN (Logical Channel Number).

Please note that some operators are restricted to manually change the channel order. If you switch off LCN, then the channel list can be edited after channel scan.

This function may not be applicable in some models/countries/regions.

Cable

- **Channel:** Select from **All Channels** or **Free Channels**. This option may not be available depending on countries/regions/operators.
- **Scan Mode:** Select from digital channels only (DTV), digital and analogue channels (DTV+ATV) or analogue channels only (ATV).
- **LCN:** Switch on/off LCN (Logical Channel Number).

Please note that some operators are restricted to manually change the channel order. If you switch off LCN, then the channel list can be edited after channel scan.

This function may not be applicable in some models/countries/regions.



Manual Scan

Manually scan for channels to view programmes from your TV sources through DTV or ATV.

In Live TV,   > **Settings** > **Channel** > **Advanced Settings** > **Manual Scan**

DTV Manual Scan

Manually scan for DTV channels to view programmes from a TV source.

When the DTV Manual Scan screen appears, press   button to select **Antenna**, **Cable** or **Satellite**, and select **Start** to commence the search of that channel. When the signal has been tuned, signal strength will be displayed on the screen.

ATV Manual Scan

Manually scan for ATV channels to view programmes from a TV source.

- **Frequency:** Input the channel frequency you want.
- **Picture System:** Select the Colour System.
- **Sound System:** Select the Sound System.

Live TV tutorial

After channel scanning is done for the first time, the screen will display Live TV operating tutorial, including:

 : Load the info bar

 : Load the channel list

 : Open the electronic programme guide (only available in some models/countries/regions)

 : Load onscreen menu

 : Call up search function

 : Jump to the previous channel

Note:

- The remote control buttons may vary depending on models/countries/regions.

Related Topic

- [Connecting an Antenna](#)

Channel List

Displaying the channel list

In Live TV, press  button to display the Channel List menu.

Alternatively, in Live TV,  > **Channel List**.

Entering the sub-menu of channel list

In Live TV,  > 

Introducing the sub-menu

In Live TV,  > 

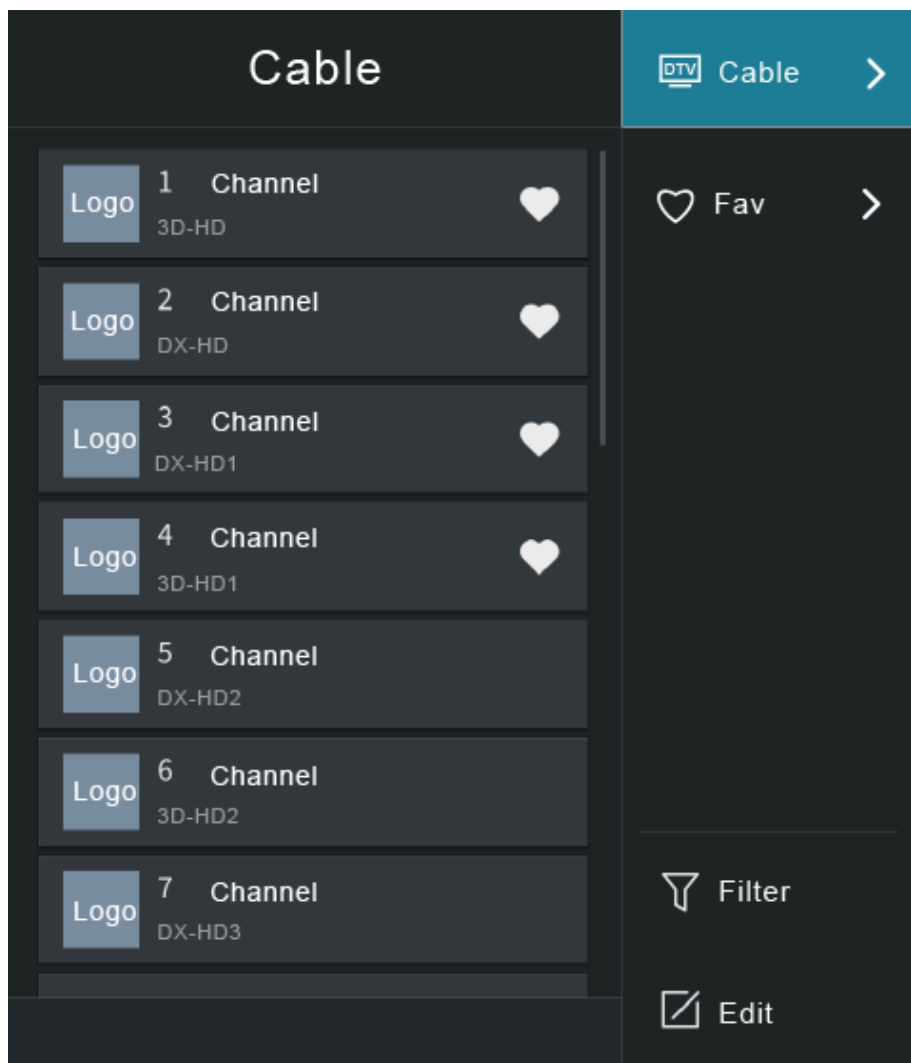

TV List

Display Live TV channel categories, such as **Cable** and **Antenna**.

Fav

Display favourite lists 1 to 4.

Filter

Select channels by **Content**, **HD**, **Child Lock**, **Scrambled** and **Sort**.

Some options in **Filter** may not be available in some models/countries/regions.

Edit

Edit the channel list.

Note:

- The sub-menu options may vary depending on models/countries/regions.

Channel Edit

Manually edit the channel list to your preference.

Editing Live TV channels

In Live TV, press **OK** **CH.LIST** > **▶** to select a Live TV channel category such as Antenna or Cable, then use D-pad to select **Edit**.



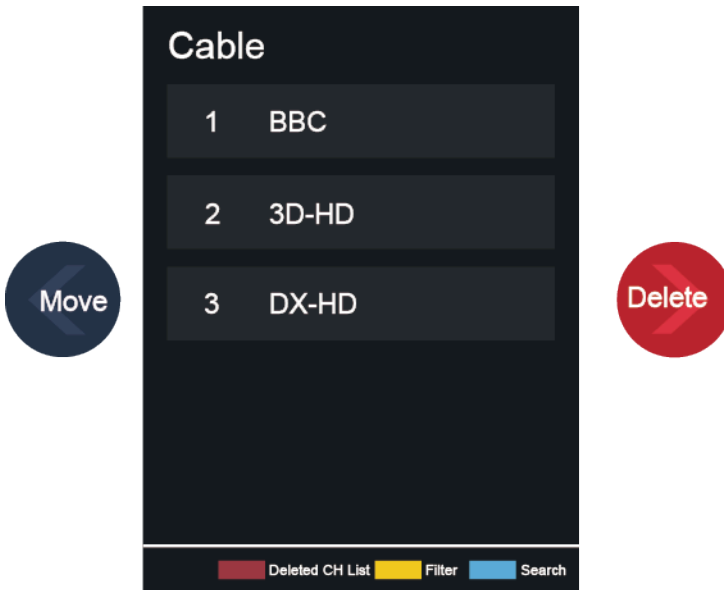





Alternatively, in Live TV, press **☰** **☰** button, select **Settings** > **Channel** > **Channel Edit**, and select a Live TV channel category such as Antenna or Cable.



- Press **OK** button on the selected channel, then a checkbox will appear. You can select multiple channels at the same time to move or delete.
- Move: Press **◀** button to move the selected channel.

Moving the channels could be restricted by the operator. If you want to be able to move channels, it is not recommended to choose an operator during channel scan, and LCN should be set to Off.

- Delete: Press **▶** button to delete the selected channel.

- Restore: Press  [RED] button, or press  button to call out the colour menu and select RED to enter the list of deleted channels. Press  button to restore the deleted channel.
- Filter: Press  [YELLOW] button or press  button to call out the colour menu and select YELLOW, the filter screen will pop up. Press  button to select options, and the channel list can be updated.
- Search: Press  [BLUE] button or press  button to call out the colour menu and select BLUE, to search the channel.

Exporting to USB

Allow you to export the current channel list to a USB storage device.

In Live TV,   > **Settings** > **Channel** > **Channel Edit** > **Export to USB**

Importing from USB

Allow you to import a previously exported channel list via a USB storage device.





In Live TV,   > **Settings** > **Channel** > **Channel Edit** > **Import from USB**

Related Topic



- [Connecting USB Devices](#)

Favourite

Adding a channel to a favourite list



1. In Live TV, press   button to call out the channel list.
2. Press   button and select the channel(s) you want to add to the favourite list.
3. Select **Add to Favourite**, and choose from **FAV1-FAV4**.
4. Then, a heart-shape icon will appear next to the added channel.

Viewing your favourite list

In Live TV, press   >  > **Fav** to call out the favourite list.

Editing the favourite list

In Live TV, press   >  > **Fav** >  to select **FAV1-FAV4**, then use D-pad to select **Edit**.

Alternatively, go to   > **Settings** > **Channel** > **Channel Edit**, and select **FAV1 - FAV4**.

You can add, move or remove favourite channels.

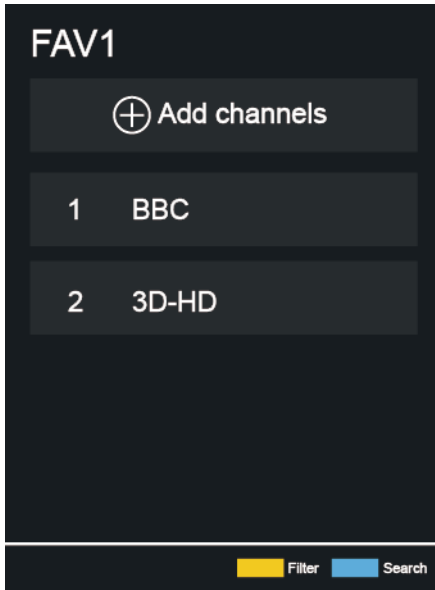

- Select **+** **Add channels** to add the selected channel to the favourite list.
- Select a channel in a favourite list, and press **←** button to move it.
- Select a channel in a favourite list, and press **→** button to remove it.

Note:



- These steps should be operated under the TV input.
- Before you edit the favourite lists, Channel Scan must be completed first.
- You can add channels from various reception types to the favourite list.

Guide (EPG)

The Guide (EPG) provides a convenient way to check TV programs for the upcoming 7 days. The information displayed by the Guide (EPG) is made available by the commercial television networks for digital channels only. The Guide (EPG) also provides a simple way to record your favourite programmes and a reminder function which can switch channel automatically at scheduled time, so that you will not miss programmes of interest. The availability and amount of programme information will vary depending on the particular broadcaster.

Note:



- The Guide (EPG) function is only available for digital channels. Analogue channels are not supported.

In Live TV, press  button, or press  > **Guide (EPG)** to display channel information on programme guide list.

- **Watch**

In Guide (EPG), when a current programme is selected, press  > **Watch** to switch to the channel you want to see.

- **PVR/Reminder**

In Guide (EPG), press  button to select the channels. Press  button to select programme based on the time schedule.



Press  button to select **PVR** or **Reminder**.

For more information, please refer to [Live TV > PVR](#) in this manual.



Note:

- Reminder in the Guide (EPG) is only available for programmes that haven't been aired yet.
- A storage device (space should be no less than 2G, and transfer rate should be no less than 4MB/s) must be attached to the TV for recording purposes. It is strongly recommended to use USB mobile hard disk drive instead of USB flash drive as the storage device. For more information, please refer to [Connecting USB Devices](#) in this manual.
- The TV will record the programme even in standby mode.
- The PVR function may not be applicable in some models/countries/regions.

- **Schedule**

In Guide (EPG), press  [RED] button or press  button to call out the colour menu and select RED, to view a list of scheduled reminders and recordings.



- **Programme Colour**

In Guide (EPG), press  [GREEN] button or press  button to call out the colour menu and select GREEN, to choose colours to indicate different genres in the Guide (EPG) for quick and easy viewing.

Note:

- This function may not be applicable in some models/countries/regions.

- **24h-**

In Guide (EPG), press  [YELLOW] button or press  button to call out the colour menu and select YELLOW, to select programmes of the previous day.

- **24h+**

In Guide (EPG), press [BLUE] button or press button to call out the colour menu and select BLUE, to select programmes of the next day.

PVR

The PVR function allows you to easily record digital television content for later viewing. The function is only available for digital channels. To use PVR, you must connect a storage device for recording. The format of the storage disk should be NTFS, FAT32. The PVR will not function if a data storage device has not been connected. For more information, please refer to [Connecting USB Devices](#) in this manual.

Schedule Recording

In Live TV, press > **PVR**.

Alternatively, press INFO to load the info bar, and select a programme and choose **PVR**.

If your remote has button, press it and use D-pad to select to set up PVR.

You can select recording mode from time, manual stop and program.

When you select time, you can set the appointment time and period.

In Guide (EPG), press the [RED] button or press button to call out the colour menu and select RED, to view the scheduled recording. In schedule recording list, you can readjust the reservation information that has been set.

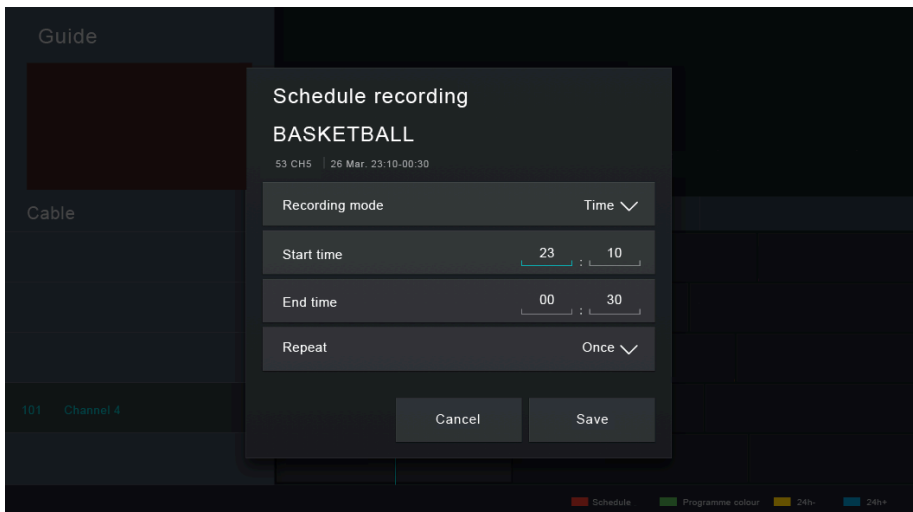

Standby Recording

If you press the power button during recording and select **Standby Recording**, your TV will go into standby mode but the recording process is still going on. If you press power button again to wake up the TV, the recording process will not be affected. After recording, the recorded file will be automatically saved to the disk.

Note:

- The storage space of your device should be no less than 2G (for 15 minutes high definition video). It is strongly recommended to use USB mobile hard disk drive instead of USB flash drive as the storage device.
- If the transfer rate of your hard disk is too slow, a pop-up notice will appear. In this case, you can use another disk with higher speed.
- The PVR function doesn't support analogue channels.
- Some broadcasters may restrict to record the programme.
- During the recording progress, channels locked with Channel Lock (password needed) are disabled to watch.
- Some channel-related configuration may conflict with background recording. In this case, a reminding window will pop up.
- The PVR function may not be applicable in some models/countries/regions.

Recording List

Accessing the recording list

View the list of recorded programmes and scheduled list.

To enter the recording list:

In Live TV,   > **Recording List**

Managing the recording list

In Live TV,   > **Recording List** > **Recorded**

You can watch, sort or delete recorded programmes.

Watch recorded programme

Select a recorded programme in the recording list, and press  button to watch it.

Sort recorded programme

Select **All**, and you can choose from the list to sort the recorded programme.

Note:



- This function may not be applicable in some models/countries/regions.

Delete recorded programme

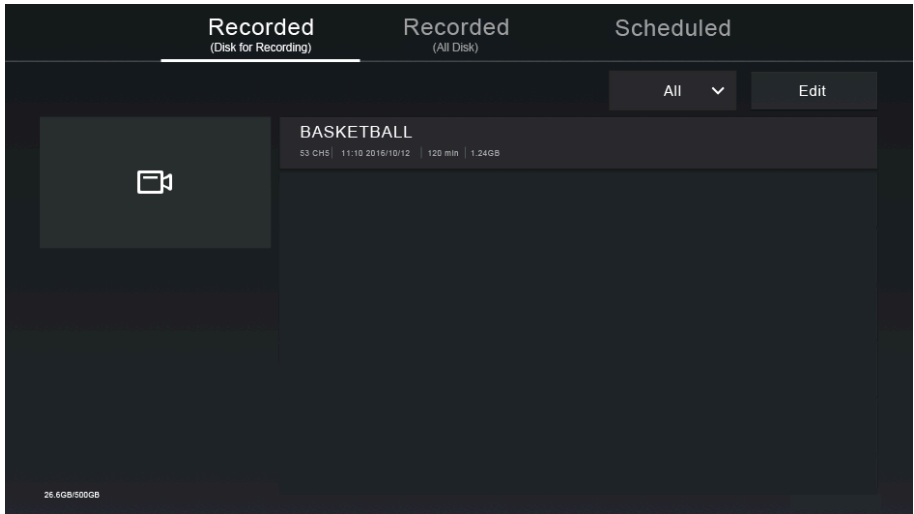
Select **Edit**, select a recorded programme in the recording list, and press  button to delete it.



If you connect more than one storage devices to the TV, **Recorded (Disk for Recording)** and **Recorded (All Disk)** are available on-screen to select.

In **Recorded (Disk for Recording)**, you can watch recorded programme of the storage device that is selected at   > **Settings > System > Advanced Settings > PVR & Time Shift > PVR Setup/Time Shift Setup**.

Managing the schedule list

In Live TV,   > **Recording List > Scheduled**

You can change scheduled recording information and reminder information, or cancel scheduled recordings or reminders.

Delete scheduled recording or reminder

Select **Edit**, select a scheduled recording or reminder in the schedule list, and press  button to delete it.

Edit scheduled recording or reminder

Select scheduled recording or reminder in the schedule list, and press  button to adjust it.

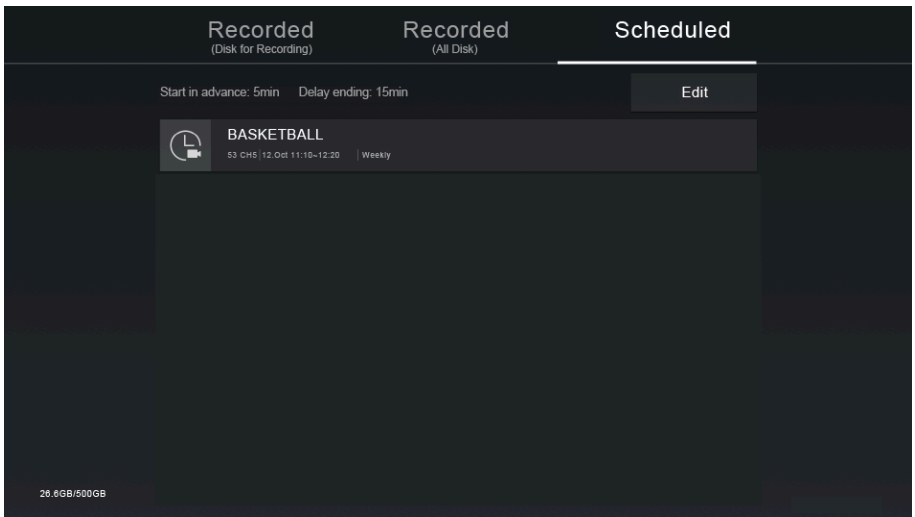

Note:

- The Recording List function may not be applicable in some models/ countries/regions.

Related Topic

- [Connecting USB Devices](#)
- [Recording/Timeshift Issues](#)

Timeshift





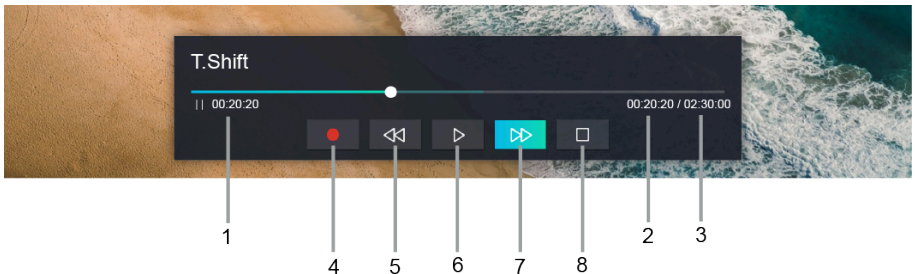

This option allows you to pause and rewind Live TV. This function operates by recording temporarily to a storage device. Please ensure your storage device is connected and there is enough free disk space. Otherwise, the timeshift function will not commence.

In Live TV, press > **Timeshift**, and then the playback bar will appear.

If your remote has button, press it and press button to launch Timeshift.

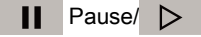

- 1 Unwatched time for buffered content

- 2 Current time
- 3 Total time
- 4  Record: to convert timeshift to live recording of current broadcast channel. Select  and the programme content you've watched in Timeshift before will also be saved in the storage device.
- 5  Fast backward: you can choose 2×, 4×, 8× or 16×.
- 6  Pause/  Play
- 7  Fast forward: you can choose 2×, 4×, 8× or 16×.
- 8  Stop Timeshift: to exit the function and watch the current broadcast.

Note:

- The Timeshift function doesn't support analogue channels.
- The storage space of the device should be no less than 2G. It is strongly recommended to use USB mobile hard disk drive instead of USB flash drive as the storage device.
- The Timeshift function may not be applicable in some models/countries/regions.

Related Topic

- [Connecting USB Devices](#)
- [Recording/Timeshift Issues](#)

Connection

Wired Internet Connection

Connecting to a wired (Ethernet) network

To get access to the Internet in a wired way, it is recommended to use a modem or router that supports Dynamic Host Configuration Protocol (DHCP). Modems and routers that support DHCP automatically provide the IP address, subnet mask, gateway, and DNS, so you don't have to enter them manually. Most home networks already have DHCP.

See the illustration below.

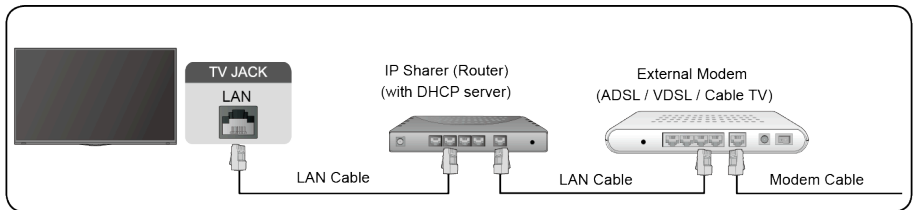

After connecting to a wired (Ethernet) network:

> **Settings** > **Network** > **Network Configuration**

Set the TV network by selecting **Network Configuration** and press button to enter the submenu.

- **Connection Type**

Choose a wired (Ethernet) network connection to access the Internet.

- **Ethernet**

Display network status.

- **IP Settings**

Configure the IP setting for your network connection.

Wake on LAN

> **Settings** > **Network** > **Wake on LAN**

Using an Ethernet connection and switching on **Wake on LAN**, this feature can make you turn on the TV from the standby mode, and push content to be broadcast on the TV with an app supporting the screencast feature in your mobile device.

Note:

- To use this function, make sure your TV and mobile device are connected to the same network environment.

- Enabling this function may result in higher energy consumption.

Related Topic

- [Network Issues](#)

Wireless Internet Connection

Connecting to a wireless network

To connect to an available wireless network, make sure that you turn on your WiFi and have the wireless router's SSID and password before attempting to connect.

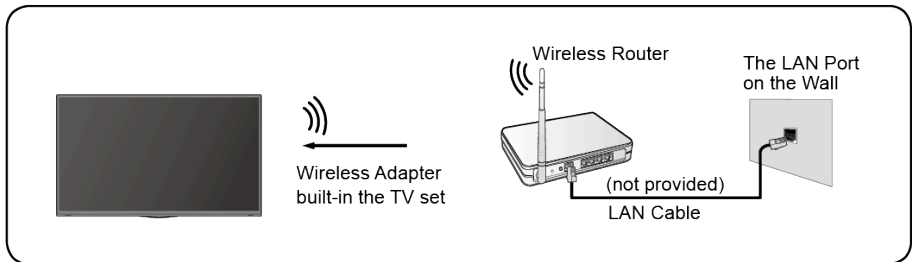

To get access to the Internet in a wireless way:

> **Settings** > **Network** > **Network Configuration**

Set the TV network by selecting **Network Configuration** and press button to enter the submenu.

- **Connection Type**

Choose a wireless network connection to access the Internet.

- **Advanced Settings**

Configure the advanced wireless network settings for the TV.

- **Add**

You can add wireless network.

- **Refresh**

Refresh wireless network.

Note:

- If no wireless router is found, select **Add** and enter the network name in the SSID.
- If no wireless router is found, select **Refresh**.

Wake on wireless network

> **Settings** > **Network** > **Wake on Wireless Network**

Using a wireless network connection and switching on **Wake on Wireless Network**, this feature can make you turn on the TV from the standby mode, and push content to be broadcast on the TV with an app supporting the screencast feature in your mobile device.

For more information about screencast feature, please refer to [Multi-screen > Screen Sharing](#) or [Content Sharing](#) in this manual.

Note:



- To use this function, make sure your TV and mobile device are connected to the same network environment.
- Enabling this function may result in higher energy consumption.

Related Topic

- [Network Issues](#)

Connecting Bluetooth Devices

You can connect to devices using Bluetooth technology.



  >  **Settings > Network > Bluetooth**

Note:



- Bluetooth function may not be applicable in some models/countries/regions.

Connecting a Bluetooth remote

Pair the Bluetooth remote with the TV.







1. Pair the Bluetooth remote to the TV after you power the TV on, and set   >  **Settings > Network > Bluetooth to On.**
2. Keep the remote control within 3 metres from the TV. Press any button (except power and mic button) to pair with the TV.

Note:

- In special cases, press and hold   button to pair.
- This function may not be applicable in some models/countries/regions.
- If an unknown error occurred with the remote, it could have been caused by interference. Try to remove what's causing the interference and pair it again.
- If an unknown error occurred with the remote while the battery power is normal, you can take out the batteries, press any key for 1~2 seconds, and insert them back. Then the remote will work normally.
- The remote cannot be paired to the TV while the TV is in standby mode.

Connecting a Bluetooth device

To pair a Bluetooth device, such as Bluetooth headphones, speakers, keyboards, mouse or even mobile devices:



1. Set   >  **Settings** > **Network** > **Bluetooth** to **On**.
2. Before pairing your Bluetooth devices, make sure they're in pairing mode and put devices within pairing range. To put your Bluetooth devices in pairing mode, refer to the manual of devices.
3. Find the Bluetooth device name in   >  **Settings** > **Network** > **Bluetooth** > **Equipment Management** and select it. The device will be automatically connected to the TV.

Note:

- Only one Bluetooth speaker or Bluetooth headphone can be connected to the TV. If a new Bluetooth speaker or headphone connects to the TV, the old one will be disconnected automatically.
- Compatibility issues may occur depending on the Bluetooth device.
- The TV and Bluetooth devices may disconnect depending on the distance between them.
- For more information about Bluetooth headphone settings, please refer to [Picture and Sound > Using Headphones](#) in this manual.

Listening to the audio through Bluetooth devices

Pair the Bluetooth audio devices using the TV's Bluetooth function. Refer to the user manual for your audio devices, such as Bluetooth speaker or sound bar, for detailed connection and usage.

After the Bluetooth connection is completed, go to   >  **Settings** > **Sound** > **Speakers** > **Audio Output**, and then select **BT Sound Bar** option to listen to the audio through bluetooth devices.

Note:

- Compatibility issues may occur depending on the Bluetooth device.
- The TV and Bluetooth device may disconnect depending on the distance between them.



TV Bluetooth speaker

  >  **Settings** > **Network** > **Bluetooth** > **TV Bluetooth Speaker**

TV Output: Mobile devices are connected to TV with Bluetooth. Sound outputs via TV speaker.

When your mobile device is connected to the TV via Bluetooth, you can play your mobile phone's music through TV built-in speakers. This function makes the TV perform as a speaker.

Go to your mobile Settings to enable Bluetooth, and choose the TV to connect.

To use this function, make sure to select **TV Speaker** at   >  **Settings** > **Sound** > **Speakers** > **Audio Output**.

Related Topic



- [Speakers Settings](#)

Connecting Headphones

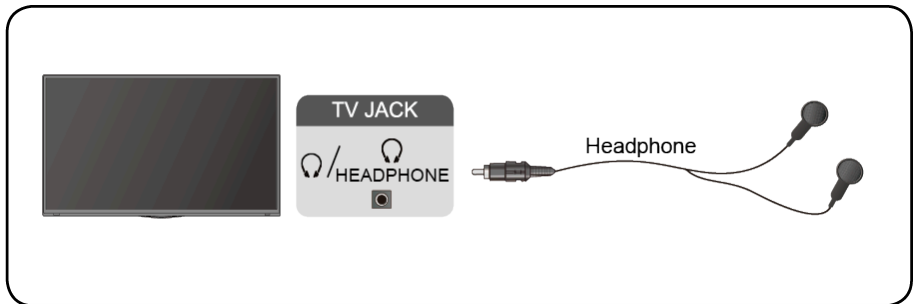
You can connect a pair of headphones (not provided) to the HEADPHONE port on your TV. While the headphone is connected, the sound from the built-in speakers will be disabled.



Note:

- Headphone port may not be available in some models.
- Headphones with microphones are not supported.
- If **Headphone with Speakers** is selected manually in   >  **Settings** > **Sound** > **Headphone** > **Headphone Mode**, the headphone and the TV will have sound output at the same time.
- For more information about headphone settings, please refer to [Picture and Sound > Using Headphones](#) in this manual.

Connecting USB Devices

Connect the USB devices, such as hard drives and USB sticks for browsing photos, or listening to music.

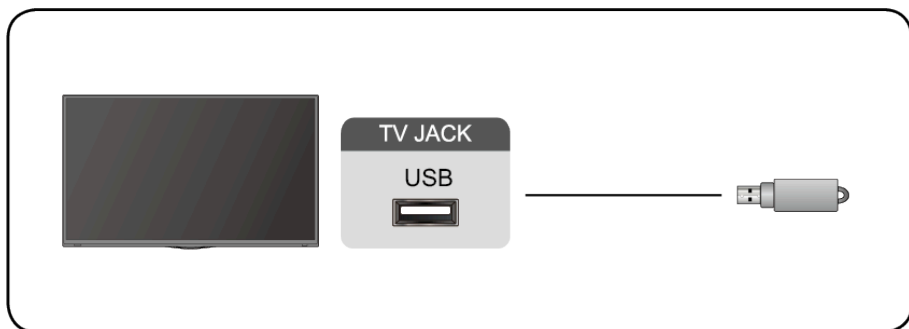

Note:

- Support the USB disk 4G, 8G, 16G, 32G, 64G, 128G and other common market sizes, and 8T hard drive is currently supported.
- Support format: NTFS, FAT32.
- Select the content you want to play or view. For more information, please refer to [Smart Functions > Media](#) in this manual.

Connecting an Antenna

You can connect an antenna cable to your TV.

Using your remote, select  **Input** icon in Home screen and select **TV** as the input source.

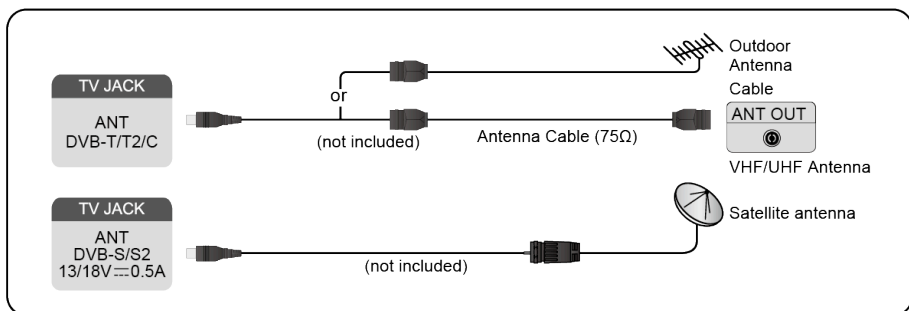

Related Topic

- [Channel Scan](#)

Connecting Audio Visual (AV) Devices

Connecting with a composite video cable

To connect an AV device with a composite video cable (not provided), see the illustration below.

When the connection is finished, using your remote, select  **Input** icon in Home screen, and select **AV** as the input source.

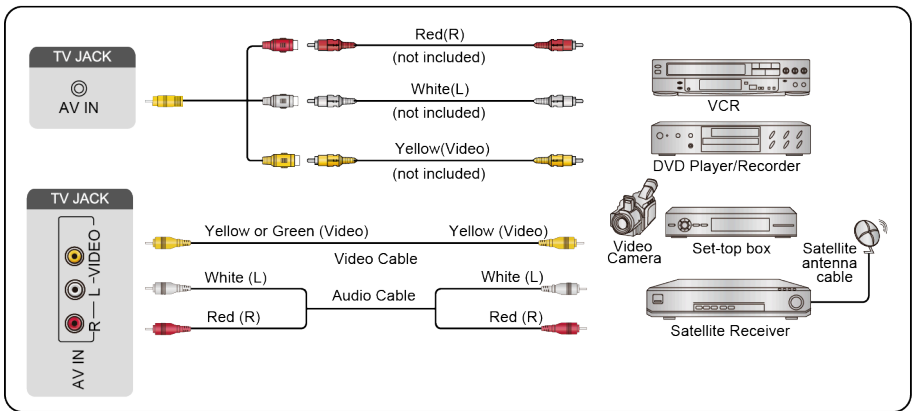

Note:

- AV IN port(s) may vary depending on models.
- AV IN port(s) may not be available in some models. Please use other port(s) to connect AV devices.

Connecting with an HDMI cable

To connect an AV device with an HDMI cable (not provided), see the illustration below.

When the connection is finished, using your remote, select the  **Input** in Home screen, and select the corresponding HDMI input.

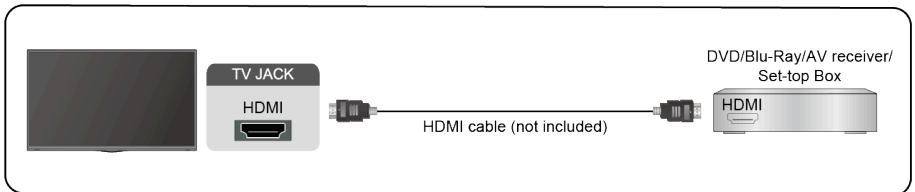

Note:

- Please refer to the User Manual that came with your device for step-by-step instructions.
- Some devices, such as DVD player, require HDMI signal to be set to output in the device's settings. Please consult your device's user manual for instructions.
- If there is no sound from your TV, configure the device's audio settings.



Related Topic

- [Using HDMI & CEC](#)

Connecting Speakers or Other Audio Receivers

To connect speakers or other audio receivers with an audio cable (not provided), see the illustration below.



Plug the connected devices into the main power socket before switching on the TV.

When the connection is finished, go to   >  **Settings** > **Sound** > **Speakers** > **Audio Output**, and select the **SPDIF Only** option.

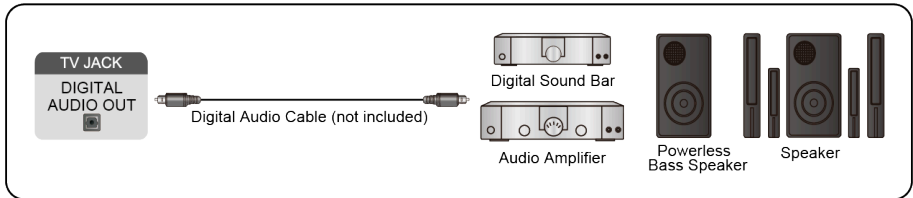
When a digital audio system is connected to the DIGITAL AUDIO OUT port, decrease the TV volume and your digital audio system volume.



Note:

- If you prefer to use Audio Return Channel/Enhanced Audio Return Channel, please refer to [Connection > Connecting a Digital Audio System to Use ARC/eARC](#) in this manual.
- You can connect the DIGITAL AUDIO OUT port on the back of the TV to the optical port on the amplifier. Then go to   >  **Settings** > **Sound** > **Speakers** > **Digital Audio Out** to select **Dolby Digital** to receive the Dolby Digital audio.

Related Topic

- [Speakers Settings](#)

Connecting a Digital Audio System to Use ARC/eARC

If you'd like to use the Audio Return Channel (ARC)/the Enhanced Audio Return Channel (eARC) feature to send sound from the TV by an HDMI cable to a digital sound system, you can connect it to the HDMI (ARC/eARC) port of your TV.

By using this feature, you can also control the sound system with your TV remote instead of using the remotes for each device.

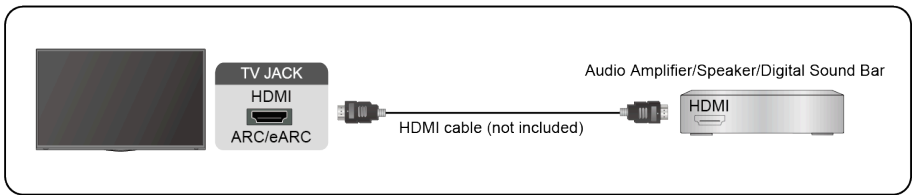

After the connection:

1. Power on the sound system.
2. Press button to select **Settings** icon in the Home screen.
3. Select **Sound > Speakers > Audio Output**, and select **ARC** option. If the device supports eARC function, press button to select **Settings** icon in the Home screen, and select **Sound > Speakers > eARC** to set eARC to **On**.

Note:

- It works only when the TV is connected to the audio receiver that supports the ARC/eARC function.
- If the device has an Input Selector feature, then make sure to change it to the TV.
- When this port is used for ARC/eARC function, it can be used as signal input when a DVD is connected to an amplifier and the amplifier is connected to the TV at the same time. Some amplifiers may not support series connection.
- 5.1 CH (channel) audio is available when the TV is connected to an external device that supports 5.1 channel surround sound. You can press button to select **Settings** icon in the Home screen, and select **Sound > Digital Audio Out** to choose **Dolby Digital Plus** to receive the 5.1 channel audio.

Related Topic

- [Speakers Settings](#)

Using HDMI & CEC

Use the TV remote to control external devices that are connected to the TV by an HDMI cable. The external devices need to support HDMI & CEC function.

> **Settings** > **System** > **HDMI & CEC**

Connecting an external device through HDMI & CEC function

> **Settings** > **System** > **HDMI & CEC** > **CEC Control**

Allow HDMI devices to control each other.

1. Set **CEC Control** to **On**.
2. Connect an HDMI & CEC compatible device to the TV.
3. Turn on the connected external device. The device will be connected to the TV automatically. After connection is finished, you can access the menu of the connected device on your TV screen using your TV remote and control the device.

Enabling device auto power off

  >  **Settings** > **System** > **HDMI & CEC** > **Device Auto Power Off**

Set to **On** to turn off HDMI & CEC compatible external devices when the TV is turned off.

Enabling device auto power on

  >  **Settings** > **System** > **HDMI & CEC** > **Device Auto Power On**

Set to **On** to turn on HDMI & CEC compatible external devices when the TV is turned on.



This feature is applicable when TV input source is preset to the corresponding external device.

Enabling TV auto power on

  >  **Settings** > **System** > **HDMI & CEC** > **TV Auto Power On**

Set to **On** to turn on the TV when HDMI & CEC compatible external devices is turned on.

HDMI format function

  >  **Settings** > **System** > **HDMI & CEC** > **HDMI Format**

Please select **Enhanced format** if your HDMI device supports 4K HDR. If it does not support 4K HDR, please select **Standard format**. If you are not sure, please select **Auto**.

Note:

- HDMI cables must be used to connect HDMI & CEC compatible devices to your TV.
- The HDMI & CEC feature of the connected device must be turned on.
- If you connect an HDMI device that is not HDMI & CEC compatible, all the HDMI & CEC control features do not work.
- Depending on the connected HDMI device, the HDMI & CEC control feature may not work.

- The HDMI & CEC feature supports One Touch Play, Routing Control, System Standby, Device OSD Name Transfer, Remote Control Pass Through, Give Device Power Status, System Audio Control.

Connecting a PC or a Game Console

PC

You can connect a PC to the TV with an HDMI cable to use your TV as a PC monitor.

After connecting the PC, press the   button, then select  **Input** icon in Home screen or press **INPUT** button. Select the connected PC as the input source.

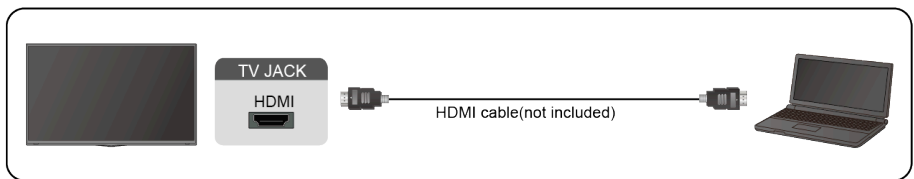



Note:

- For better image quality, set the PC's resolution, and make sure the resolution is supported by the TV.
- If there is no sound from your TV, change the PC's audio settings.
- If you want to connect your PC and TV wirelessly, please refer to [Multi-screen > Content Sharing](#) in this manual.

Game console

You can connect your game console with an HDMI cable to the TV.

To start a game from a game console:

1. Switch on your game console.
2. Press the   button, select  **Input** icon in Home screen or press **INPUT** button. Select the connected game console as the input source.
3. Start the game.

You can enable the game mode to optimise your TV's settings when playing games with a game console. For more information, please refer to [Picture and Sound > Game Mode Settings](#) in this manual.

Multi-screen

Screen Sharing

Mirror your mobile device screen to the TV.

Before using Screen Sharing, please set your TV to the wireless network connection.

INPUT > Screen Sharing

1. Turn on the casting function of your Android/Windows10 device. The setting icon may vary depending on the device. The feature may be called "Wireless display", "Smartview", "Wireless projection", etc.
2. Find the TV name in the searching list of your device and select it. Wait for the connection progress to complete and the content on your device will be displayed on the TV.

Note:

- Some mobile devices may not support casting.

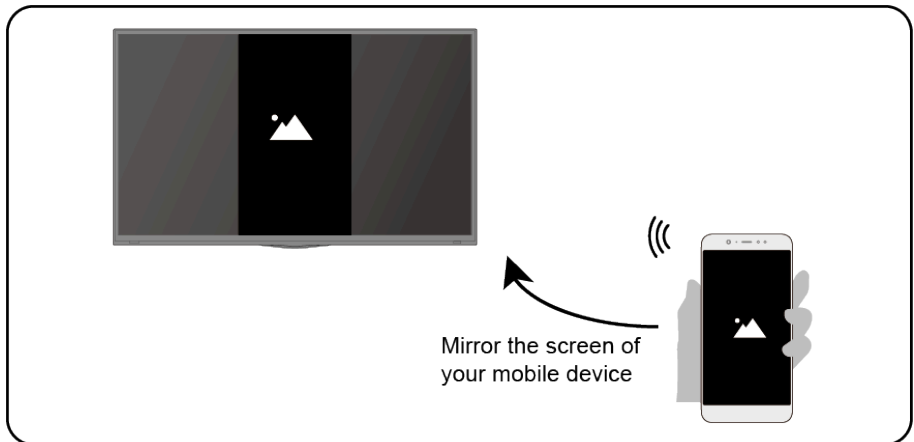

Related Topic



- [Wireless Internet Connection](#)

Content Sharing

Content Sharing allows you to view media content, like videos, music or photos saved in your Android/iOS/PC device on your TV screen.

Sharing media content from your Android/iOS/PC device





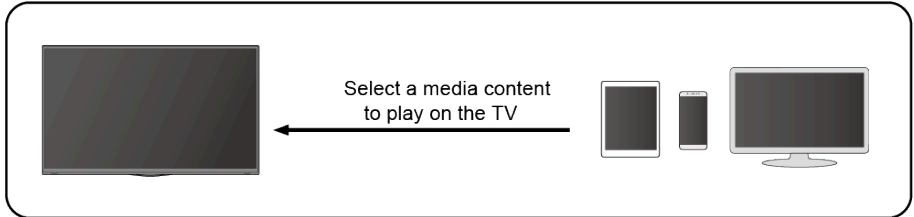



1. Connect your TV and Android/iOS/PC device to the same network.

2. Turn on Content Sharing at   >  **Settings > System > Application Settings > Content Sharing**.
3. Turn on the content sharing function in your Android/iOS/PC device.
4. Find the TV name in the searching list of your device and select it. Wait for the connection progress to complete.
5. In your Android/iOS/PC device, choose the media content you want to share on your TV.



Playing media content from your Android/iOS/PC device on the TV

You can connect media content saved in your Android/iOS/PC device to your local network and play the content on your TV.

1. Connect your TV and Android/iOS/PC device to the same network.
2. Turn on Content Sharing at   >  **Settings > System > Application Settings > Content Sharing**.
3. Make sure your media content in your Android/iOS/PC device are visible through local network.
4. On your TV, select a device with media content at   >  **Input**, or   > **My Apps > Media**. The media content list in your Android/iOS/PC device appears.
5. Select a media content item from the list to play.

Note:

- Some Android/iOS/PC devices may not support content sharing function. If your device doesn't support content sharing, you can download an app that supports the function to connect to your TV. For more information, please refer to [Smart Functions > Installing Mobile App to Control your TV](#) in this manual.
- The content may not be played depending on the file format.
- The content may not be played smoothly or the function may not work properly due to the network condition.

Related Topic

- [Wired Internet Connection](#)
- [Wireless Internet Connection](#)

Smart Functions

Getting Familiar with the Home Screen

Press  button on your remote control to enter the Home screen.

The Home screen serves as the central location to run the TV more conveniently.

To exit the Home screen, press **INPUT** button on your remote or use the navigation buttons to move the cursor to the  **Input** icon on the top of the screen, press **OK** button to enter, and select your desired input source.

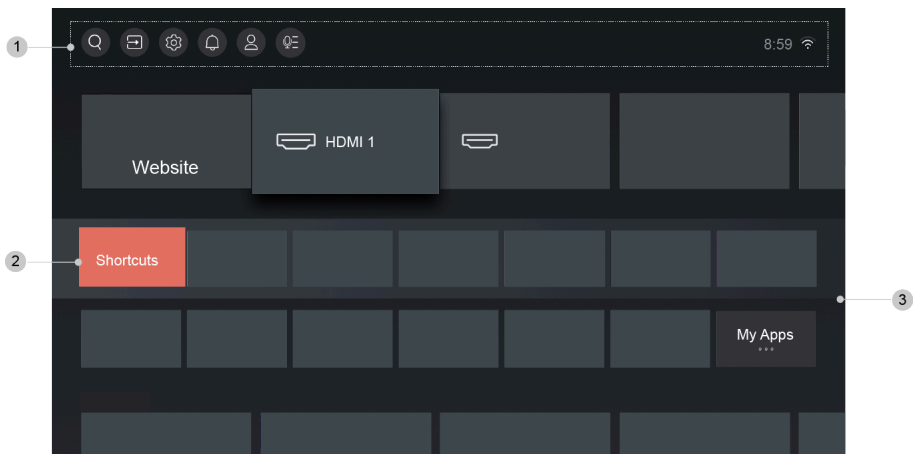

1 Navigation bar

2 Shortcuts

3 Apps

Using the navigation bar

The navigation bar refers to indicators and icons on the top of the Home screen.

Note:

- Indicators or icons may vary depending on models/countries/regions.

Search

Search the content you want.

Input

Select the Input source depending on the device you have connected to your TV.

Settings

Let you configure the TV.

Notifications

Allow pop-up notifications to appear for useful information and events that occur with your TV, including: **Advertising, New Arrivals, Warnings And Legal Statements, System Messages** and **Alexa Notification**. You can enable/disable each of these notifications at Settings in the notification centre.

You can view the list of event messages generated by the TV.

To delete all notifications, select **Clear All**.

Note:

- The Alexa Notification may not be applicable in some models/countries/regions.
- When you sign in your VIDAA account, please find Notifications in VIDAA Account on the Home screen.

VIDAA Account

Sign in your VIDAA account.

A VIDAA account gives you all the best features of your smart TV and always keeps it up to date.

For more information about VIDAA account, please refer to [Smart Functions > Using a VIDAA Account](#) in this manual.



Voice

Quick access to **Voice Service**. For more information, please refer to [Smart Functions > Using Voice Service](#) in this manual.

Time

You can always view the current time at the top of the Home screen.

Network



Connect your TV to the Internet through a wireless connection  or an Ethernet cable , and the corresponding icon will appear.

Using the Shortcuts



You can add inputs, channels and websites to the Home screen to have quick access to them for your convenience.

Add inputs to the home screen





1. Press **INPUT** button.

2. Move the focus to an input you want to add to the Home screen, and press   > **Add to home** > . The input icon will appear in Shortcuts on the Home screen.



Note:

- Some options in inputs source page cannot be added to the Home screen.
- To remove inputs from Shortcuts, just move the focus to a shortcut page and press   button on your remote control.

Add channels to the home screen

1. In Live TV, press   button to access the channel list.
2. Press   button and press  button to tick channel(s) that you'd like to add on the Home screen.
3. Select **Add to home**. The channel icon will appear in Shortcuts on the Home screen.



Note:

- To remove channels from Shortcuts, just move the focus to a shortcut page and press   button on your remote control.

Add webpages to the home screen

1. In Browser, visit a website you'd like to add on the Home screen.
2. Use the D-pad to move the focus to  **Add to home** icon in the top Browser navigation bar and select it.
3. Select **Add**, and this webpage will appear in Shortcuts on the Home screen.

Note:

- To remove webpages from Shortcuts, just move the focus on a shortcut page and press   button on your remote control.

Managing apps

  > **My Apps**

Select the item you want to move, press   button to manage, and press  button to store position.



Note:

- Some app may not be moved.

Using a VIDAA Account

Signing into an account



Before signing into your VIDAA account, make sure your TV is connected to network. For more about network settings, please refer to [Connection > Wired Internet Connection](#) or [Wireless Internet Connection](#) in this manual.

1. After the network is connected, press   button on your remote and select  **VIDAA Account** icon in the top navigation bar on the Home screen.
2. Register your device to your VIDAA Account. After entering your email and password, select **Sign In**.





Creating a new account

If you don't have a VIDAA account, create a new one to enjoy best features of your smart TV.

Before creating a new account, make sure your TV is connected to network. For more about network settings, please refer to [Connection > Wired Internet Connection](#) or [Wireless Internet Connection](#) in this manual.

1. After the network is connected, press   button on your remote and select  **VIDAA Account** icon in the top navigation bar on the Home screen.
2. Select **Create Account** on screen.
3. Enter your first name, last name, email address and password. First Name and Last Name are optional.
4. Select **Create Account**.

Using Voice Service



To access the Voice Service, press   button on your remote and select  **Voice** icon in the navigation bar. Alternatively, just press  button on your remote.

Note:



- Voice Service feature may not be applicable in some models/countries/regions.
- To use this function, End User License Agreement and corresponding smart feature privacy policy/terms and conditions may be required to agree.

Alexa

Interact with Alexa by pressing and hold the microphone button on your remote. You can ask Alexa to control this TV.







Before setting up Amazon Alexa Service, connect your TV to the network and sign in your VIDAA Account at   >  **VIDAA Account**. About more how to signing into the VIDAA Account, please refer to [Smart Function > Using a VIDAA Account](#) in this manual.

How to set up Alexa

1. Press   button to select  **Settings** icon, and select **System > Voice Service > Amazon Alexa**.
2. Select **Set voice assistant to Alexa** and **Set up now**. If you have selected Alexa in the Guide when you turn on the TV for the first time, it will directly guide you to the **Set up now** step.
3. Now, you are in the step "Connect your Amazon account". Scan the QR code with your phone, or visit the website on your phone or computer, and enter the on-screen code. The code will be expired after 10 minutes. If you don't have an Amazon account, create a new one.
4. After you connect the Amazon account, the TV screen changes into the next step. You can sign into your VIDAA account. If you have signed in before, this step will be skipped.
5. Give your TV a name from the list, or you can customise it.
6. Select **Authorize** and follow on-screen steps in Alexa Skill Setup settings.

Now, Alexa is set up and ready. You can enjoy interacting with Alexa using your voice by just pressing and holding the  button on your remote control. Ask Alexa after the tone.



Note:

- The Alexa function may not be applicable in some models/countries/regions.
- The setup steps above may vary. Please refer to the actual product.
- Shipment with voice remote control varies depending on TV models/countries/regions.
- You can use Alexa without signing in your account by selecting **Do it later**. In this case, you can still use your voice to change the channel and control playback. Sign in your account in the setting in anytime to enjoy more functions of Alexa.
- This feature requires Alexa built-in service. Otherwise, use external Alexa-enabled devices (e.g. Alexa App, Echo) to control your smart TV by using just your voice.
- Download and install remote control app on your mobile device at   >  **Settings > Support > Mobile App Download**. Press the microphone icon in the app to interact with Alexa on your TV.
- You can select the language used by Alexa at   >  **Settings > System > Voice Service > Amazon Alexa > Alexa Language**. This



feature requires Alexa built-in service, which varies depending on TV models and countries/regions.

Hands-free Wake-up

Interacting with Alexa by just using your voice, all hands-free.

Before using hands-free wake-up, connect your TV to the network and sign in your VIDAA Account at   >  **VIDAA Account**. About more how to signing into the VIDAA Account, please refer to [Smart Function > Using a VIDAA Account](#) in this manual.

How to use Hands-free Wake-up

1. Turn on the build-in microphone on the TV.
2. Press   button to select  **Settings** icon, and select **System > Voice Service > Amazon Alexa**.
3. Select **Set voice assistant to Alexa** and **Set up now**. If you have selected Alexa in the Guide when you turn on the TV for the first time, it will directly guide you to the **Set up now** step.
4. Select **Build-in Microphone**. And you can select **Wake up TV by voice** at the same time. When **Wake up TV by voice** is turned on, you can wake up the TV from standby mode by just saying "Alexa". Turn on **Wake up TV by voice** function will increase energy consuming.
5. Now, you are in the step "Connect your Amazon account". Scan the QR code with your phone, or visit the website on your phone or computer, and enter the on-screen code. The code will be expired after 10 minutes. If you don't have an Amazon account, create a new one.
6. After you connect the Amazon account, the TV screen changes into the next step. You can sign into your VIDAA account. If you have signed in before, this step will be skipped.
7. Give your TV a name from the list, or you can customise it.
8. Select **Authorize** and follow on-screen steps in Alexa Skill Setup settings.

Now, Hands-free Wake-up is set up and ready. Speak to the TV and just say "Alexa", then you can wake up Alexa in this TV.

Note:



- The Hands-free Wake-up function may not be applicable in some models/countries/regions.
- Build-in microphone may not be available in some models.
- The setup steps may vary. Please refer to the actual product.
- This feature requires Alexa built-in service.

Google Assistant

Setup Google Assistant, and enjoy Google Assistant service. You can ask for information, search for your favourite movies, control your TV and more, just by asking Google Assistant.

Before setting up Google Assistant, connect your TV to the network.

STEP 1: Set up Google Assistant on TV

1. Press  button on your remote to select  **Settings** icon, and select **System > Voice Service > Google Assistant**.
2. Set voice assistant to Google Assistant and press  button to set up. If you have selected Google Assistant in the Guide when you turn on the TV for the first time, it will directly guide you to the set up step.
3. Then, read on-screen terms of service and privacy policy, and select **I understand**.
4. Next, select **Allow** to enable information sharing.

STEP 2: Set up in Google Assistant app

Follow the setup instructions on-screen to set up Google Assistant.

1. Download and install the Google Assistant app on your mobile device, and open the app.
2. Speak to Google Assistant app, "Set up my Assistant device", and follow the instruction in the app to set up Google Assistant and sign in your Google account to this TV.

Google Assistant is set up and ready. Control your smart TV using your voice by just pressing and holding the  button on your remote control.



Note:

- The Google Assistant function may not be applicable in some models/countries/regions.
- The setup steps above may vary. Please refer to the actual product.
- Shipment with voice remote control varies depending on TV models/countries/regions.
- If you don't choose to set up Google Assistant in the mobile app, just press  button to continue without signing in your Google account. You can go to TV system settings later to sign in your Google account to enjoy personal queries by asking Google Assistant, like showing your photos, calendar and more on this device.



Google Smart Home Service

For some models or when you use the TV in certain countries/regions, Google Smart Home Service function is available. Set up Google Smart

Home Service to control your smart TV with Google Home devices or app. You can change channels or inputs, adjust volume and more.

Before setting up Google Smart Home Service, connect your TV to the network and sign in your VIDAA Account at   >  **VIDAA Account**. About more how to signing into the VIDAA Account, please refer to [Smart Function > Using a VIDAA Account](#) in this manual.

STEP 1: Set up Google Smart Home Service on TV

1. Press   button on your remote to select  **Settings** icon, and select **System > Voice Service > Google Smart Home Service**. Select **Set up now**.
2. Sign into your VIDAA account. If you have signed in before, this step will be skipped.
3. Give your TV a name.

STEP 2: Set up in Google Home app

Follow the setup instructions on-screen to set up Google Smart Home Service.

1. Download and install the Google Home app on your mobile device, and open the app.
2. Find and select VIDAA Voice service in the app.
3. Follow the instructions in the app to link your VIDAA account signed in on your TV to your Google Account.



Google Smart Home Service is set up and ready. Control your smart TV by using your voice through Google Home device or app.

Note:



- Google Smart Home Service may not be applicable in some models/countries/regions.
- The setup steps above may vary. Please refer to the actual product.

Yandex Smart Home Service

Yandex Alice voice assistant can obey certain commands to help you change the TV's configuration.

Before setting up Yandex Smart Home Service, connect your TV to the network and sign into your VIDAA Account at   >  **VIDAA Account**. About more how to signing into the VIDAA Account, please refer to [Smart Function > Using a VIDAA Account](#) in this manual.

STEP 1: Set up Yandex on TV

1. Press /  button on your remote to select  **Settings** icon, and select **System > Voice Service > Yandex Smart Home Service**. Select **Set up now**.
2. Sign into your VIDAA account. If you have signed in before, this step will be skipped.
3. Give your TV a name.

STEP 2: Set up in Yandex App

Follow the instruction on TV to enable Yandex Smart Home Service.

1. Download Yandex app on your mobile device.
2. Open the app and sign in your Yandex account.
3. In the Yandex app, go to "Devices" > "Smart Home", click add device icon, and select "VIDAA Voice".
4. Perform account linking using the same VIDAA account signed in on your TV.



Yandex Smart Home Service is set up and ready. Now you can control your smart TV with Yandex Alice devices or Yandex app to change channel, change inputs, adjust volume and more, just by asking Alice.

Note:

- The Yandex function may not be applicable in some models/countries/regions.
- The setup steps above may vary. Please refer to the actual product.

Voice service other issues

If you want to turn on your TV with Alexa-enabled devices (e.g. Echo, Echo show) or Google Home devices (e.g. Google Home, Google Nest Hub), please:

1. Turn on **Wake on LAN** and **Wake on Wireless Network** at /  >  **Settings > Network**.
2. Make sure your TV and Alexa-enabled devices/Google Home devices are connected to the same network environment.

Note:

- Only Alexa (Alexa skill is enabled) and Google Smart Home Service support turning on your TV with Alexa Echo or Google Home. Google Assistant (built-in) doesn't support this function.

Related Topic

- [Wired Internet Connection](#)
- [Wireless Internet Connection](#)

Media

> My Apps > Media

Media is a central location for you to view or listen to different types of content, such as photos, music and movies. You can view media content through the following methods:

- A USB thumb drive or hard drive.
- Compatible mobile phone, tablet or other personal devices: you can stream movies, music and photos that are stored on compatible personal device and play or view the content on your TV.

By default, there is **Content Sharing** displayed on the Media screen. If your mobile device is connected to the TV, its name also appears on the Media screen.

For more information about **Content Sharing**, please refer to [Multi-screen > Content Sharing](#) in this manual.

Playing media contents

> My Apps > Media > connected devices

Select the content you want to play on the screen, like pictures, videos and music.



- 1 Search the content you want to play.
- 2 Arrange the content list by **Grid**, **List**.

- 3 Sort the content list by **Name**, **Date modified**, **Size**.
- 4 Filter the content list by **All Media**, **Photo**, **Video**, **Music**, **Recorded**.
- 5 Create a photo, music, or video playlist.

Note:

- Some options in the above table may not be available in some models/countries/regions.

Playing background music during viewing pictures

1. Choose a picture to display.
2. Press **▲/▼** button to call out playbar.
3. Select **Background Music** and choose your music to create a Music Playlist.

Now you can play the background music during viewing pictures.

Media format list

Due to differences in programming tools and other factors, some of the file formats that are listed may not be supported.

Video Format

Container	Video Codec	File Extension Name	Resolution and Frame Rate
MPG	MPEG-2	.mpg .mpeg	1920 x 1080p @ 120fps
MPEG	MPEG-2		
MP4	MPEG4	.mp4	1920 x 1080p @ 120fps
	H.264(AVC)		3840 x 2160p @ 30fps
	H.265(HEVC)		3840 x 2160p @ 60fps
	AV1		3840 x 2160p @ 60fps
MOV	MPEG4	.mov	1920 x 1080p @ 120fps
	H.264(AVC)		3840 x 2160p @ 30fps
	H.265(HEVC)		3840 x 2160p @ 60fps
MKV	Mpeg2,4	.mkv	1920 x 1080p @ 120fps
	H.264(AVC)		3840 x 2160p @ 30fps
	H.265(HEVC)		3840 x 2160p @ 60fps
	AV1		3840 x 2160p @ 60fps
AVI	Mpeg2,4	.avi	1920 x 1080p @ 120fps

Container	Video Codec	File Extension Name	Resolution and Frame Rate
	H.264(AVC)		3840 x 2160p @ 30fps
FLV	H.264(AVC)	.flv	3840 x 2160p @ 30fps
	H.265(HEVC)		3840 x 2160p @ 60fps
WEBM	VP8	.webm	1920 x 1080p @ 120fps
	VP9		3840 x 2160p @ 60fps
	AV1		3840 x 2160p @ 60fps

Audio Format

Container	Audio Codec	File Extension Name
WAV	LPCM	.wav
	ADPCM	
MP3	Mpeg1-Layer3	.mp3
	Mpeg2-Layer3	
	Mpeg2.5-Layer3	
AAC	AAC-LC	.m4a .aac
	HE-AAC(v1/v2)	
WMA	WMA	.wma
	WMA Pro	
FLAC	FLAC	.flac

Photo Format

Container	File Extension Name	Mode of Operation	Resolution
JPEG	.jpg .jpeg	-	7680 x 4320
PNG	.png	no-interlace	
		interlace	
BMP	.bmp	-	
GIF	.gif	-	
TIF	.tiff	-	

Related Topic

- [Connecting USB Devices](#)

- [Media Files](#)

App



> My Apps

Numerous factory-installed apps are available for you to choose for your entertainment preferences.

Installing an app

Even though your TV has numerous factory-installed apps, there may be others that you'd like to download.







To install an app:

1.   > **My Apps** > **APP STORE**.
2. Use the navigation buttons on your remote to select the app that you want to install.
3. Select **Install**. The selected app is installed on the TV.

Note:

- To use this function, your TV must be connected to the Internet.
- Adding apps is free, but it might cost you money when using some apps.

Sorting apps in My Apps



1. In **My Apps** select the app you want to sort, and then press   button to select **Sort**.
2. Press     button to move it.
3. Press  button to store position.

Note:

- Some app may not be moved.

Removing an app in My Apps

You can only delete apps that you've installed to the TV. Factory-installed apps can not be deleted.

1. In **My Apps**, select the app you want to remove, and then press   button to select **Remove**.
2. Select **OK**. The selected app is deleted.

Related Topic







- [Wired Internet Connection](#)
- [Wireless Internet Connection](#)

Installing Mobile App to Control your TV

Press   button to select  **Settings** icon, and select **Support > Mobile App Download**.

You can scan the Mobile App download QR code on screen to install the app on your mobile to control your TV, such as turning the TV on or off, typing in with your mobile's keyboard, and sharing pictures or videos from your mobile to TV. This app is available on both Android and iOS.

To connect your TV after installing the mobile app:

1. Agree with end user license, and disclaimer and privacy policies on TV. If you are not sure whether you have agreed, check at   >  **Settings > Support > Disclaimer and Privacy**.
2. Make sure your mobile phone and TV are connected to the same network environment.
3. To use this function, switch on **Content Sharing** at   >  **Settings > System > Application Settings > Content Sharing**.
4. Open the mobile app and select the TV device you want to connect.

Related Topic

- [Wired Internet Connection](#)
- [Wireless Internet Connection](#)

Picture and Sound

Adjusting the Picture Quality

Adjust picture mode, picture size and other advanced picture settings.

Choosing a picture mode

  >  **Settings** > **Picture** > **Picture Mode**

Select a preset picture mode to best suit the content you're viewing.

Options may differ depending on models. Please refer to the actual product.

- **Standard**

Best suited for watching normal content, such as News, Drama or Documentary.

- **Cinema day**

Best suited for watching movies in a bright environment.

- **Cinema night**

Best suited for watching movies with dark environment.

- **Dynamic**

Best suited for the content that requires vivid picture quality.



- **Sports**

Optimized picture for watching sports.

- **Auto**

The picture mode will be adjusted automatically.

Note:

- Auto mode may not be applicable in some models/countries/regions, and to use this function, you must choose **Yes, Enable Enhanced Viewing** in the Enhanced Viewing when you turn the TV on for the first time, or at   >  **Settings** > **System** > **Advanced Settings** > **Enhanced Viewing**. For more information, please refer to [Accessibility and System > Enhanced Viewing](#) in this manual.

Low Blue Light

Cinema day and Cinema night are designed to reduce the level of blue light to protect your eyes.

Go to   >  **Settings** > **Picture** > **Picture Mode**, and select **Cinema day/Cinema night**.

To reduce the eye strain and protect eyes when you watch TV for a period of time, you are suggested to:

- Take regular and frequent breaks to avoid watching TV for a long period of time. Long time of watching may cause you eye fatigue. It is not recommended to watch TV for more than one hour.
- Look away from the TV screen and look at distance objects during the breaks for at least 10 minutes for eye care.
- Relax yourself during a break by doing eye exercises or outdoor activities.
- The best recommended viewing distance is 3 times the vertical height of the TV screen.

Proper breaks and exercises are proved excellent help to relieve eye strain and fatigue.

This feature may not be applicable in some models/countries/regions.

Changing the aspect ratio

  >  **Settings** > **Picture** > **Aspect Ratio**

Adjust the Aspect Ratio to stretch or zoom in on your picture.

- **Automatic**

Automatically switch Aspect Ratio between 16:9 and 4:3 based on the signal information.

- **16:9**

Best suited for 16:9 Widescreen content. This will also stretch 4:3 content to Widescreen.

- **4:3**

Best suited for 4:3 content.

- **Panoramic**

Provide a full-screen image by stretching the edges whilst leaving the middle untouched.

- **Movie Zoom**

Provide a full-screen image by zooming in on the movie.

- **Direct**

Point to point display also known as 1:1 Pixel Mapping.

Enabling Smart Scene function

  >  **Settings** > **Picture** > **Smart Scene**

You can turn on the Smart Scene function, and enable your TV to continually recognize the scene in the content watching and enhance the picture quality on all input sources.

Note:

- Some specific application has explicit constraints that the content recognition is not allowed.

- When **Game Mode** is turned on, **Smart Scene** will be switched off automatically and is not available to set.

Configuring advanced picture settings

  >  **Settings** > **Picture** > **Picture Mode Settings**

Adjust display settings for each Picture Mode. You can personalize the picture quality by adjusting the following settings.

- **Apply Picture Settings**

Adjust current picture mode to apply to all sources or just current source.

- **Backlight**

Set the overall brightness of the screen.

Note:

- The function name may vary depending on models.

The following option may differ depending on models. Please refer to the actual product.

Dynamic Backlight Control

Enhance the contrast ratio between light and dark areas of the picture.

This function may not be applicable in some models/countries/regions.

Backlight

Adjust how bright you want images to appear, lower settings create darker images (only when **Dynamic Backlight Control** is off).

This function may not be applicable in some models/countries/regions.

Automatic Light Sensor

Enable the TV to automatically adjust the picture settings according to the amount of ambient light in your room.

This function may not be applicable in some models/countries/regions.

Light Sensor Shift

This feature is adjustable only when Automatic Light Sensor is turned on. If you feel the picture is brighter than you expect, decrease the value. If you feel the picture is darker than you expect, increase the value.

This function may not be applicable in some models/countries/regions.

Local Dimming (or **Peak Brightness Dynamic Range** for some models)

Enable the TV to automatically adjust the backlight by sections according to the changes in the image and increase the contrast.

This function may not be applicable in some models/countries/regions.

- **Brightness**

Adjust the Brightness level to generate lighter or darker images.

- **Contrast**

Adjust the Contrast level to increase or decrease how bright images appear.

- **Colour Saturation**

Adjust the colour intensity of the picture for a more vibrant image.

- **Sharpness**

Adjust how sharp or soft edges of images appear.

- **Adaptive Contrast**

Automatically darken dark areas and lighten light areas of images to see more details.

- **Ultra Smooth Motion**

Reduce seeing afterimages that are left on the screen when viewing fast-moving objects.

This function may not be applicable in some models/countries/regions.

- **Clear Motion**

Making motion look clearer when flicker is desired.

This function may not be applicable in some models/countries/regions.

- **Noise Reduction**

Improve how clear the picture appears by reducing noise.

- **MPEG Noise Reduction**

Reduce MPEG block noise and provide clearer edge transitions.

- **Colour Temperature**

Adjust how warm (red) or cool (blue) the white areas of an image appears.

- **Expert Settings**

Adjust advanced picture settings based on your viewing preference.

- **Overscan**

Change the video size settings to slightly crop the edges of the displayed image.

This function may not be applicable in some models/countries/regions.

- **Reset Current Mode**

Restore all the picture settings in the current picture mode to the factory default values.

Configuring expert settings

  >  **Settings** > **Picture** > **Picture Mode Settings** > **Expert Settings**

Adjust the colour space and Gamma to best suit the content you're viewing.

- **Colour Gamut**

Change the range of colours the TV displays.

This function may not be applicable in some models/countries/regions.

- **Colour Tuner**

Adjust the Hue, Saturation and Brightness of colour settings.

- **White Balance**

Adjust the intensity of red, green and blue lights to view the true colours of all images in the picture.

- **Black Level**

Adjust the HDMI signal range to be more suitable for the content.

- **Gamma Adjustment**

Adjust the Gamma to alter how the TV will respond to the grayscale content. In a dark room choose a higher number like 2.4. In a brighter area select a lower number like 2.0. In general, 2.2 is normally recommended.

This function may not be applicable in some models/countries/regions.

- **Gamma Calibration**

Adjust selected Gamma curve.

This function may not be applicable in some models/countries/regions.

- **Viewing Angle**

Provide better watching experience with viewing angle.

This function is only available in VAC-supported models.

- **RGB Only Mode**

View images based on default settings or choose the colour red, blue or green.

- **Low Blue Light**

Eyes care: reduce the emission of blue light.

This function may not be applicable in some models/countries/regions.

Panel Refresh

Use **Panel Refresh** to reduce image retention effects.

Due to the optical characteristics of OLED, image retention may occur after the TV has been used for an extended period of time. **Panel Refresh** is recommended to correct picture quality issues and prevent image retention.

Do not pull the plug from the socket when you want to turn off the TV. Please press the power button on the remote to turn the TV off and **Panel Refresh** will be operated automatically when TV is in standby mode.

Power indicator light will blink when **Panel Refresh** is in progress. The whole progress will take about an hour, during the process, the screen will be turned off and TV will be shut down after the refresh completes.

You could also choose to manually start **Panel Refresh**.

To manually start **Panel Refresh**:

  >  **Settings** > **Picture** > **Panel Refresh**

Red flashing light indicates **Panel Refresh** in progress.

Note:



- This function is only available for OLED models.

Related Topic

- [Picture Issues](#)

Game Mode Settings

Enabling game mode

  >  **Settings** > **Picture** > **Game Mode**

You can turn the **Game Mode** on to optimize the TV's settings for you to enjoy a comfortable gaming experience with PC or game console connected to the TV.

In the Game Mode:

- Reducing input lag to make sure every press or click matches what's happening on the screen;
- Improving responsiveness to produce very little motion blur;
- Processing YUV 4:4:4 format signals precisely to present accurate image colours.

Note:

- This function may not be applicable in some input sources or applications.

Enabling auto low latency mode

  >  **Settings** > **Picture** > **Auto Low Latency Mode**

You can enjoy a smooth viewing experience with external devices connected to the TV when **Auto Low Latency Mode** is turned on.

Note:

- This function may not be applicable in some input sources or applications.
- When **Game Mode** is turned on, **Auto Low Latency Mode** will be switched off automatically and is not available to set.



Related Topic

- [Connecting a PC or a game console](#)

Adjusting the Sound Quality

Adjust sound mode and other advanced sound settings.

Choosing a sound mode

  >  **Settings** > **Sound** > **Sound Mode**

Select a preset sound mode to suit the type of content you are listening to.

- **Standard**

In Standard mode, the TV delivers a flat frequency response, which preserves the natural characteristics of the original sound.

- **Theatre**

Theatre mode increases the surround sound effect and provides a more prominent subwoofer response.

- **Music**

In Music mode, low and high frequencies are emphasized to enhance musical instrument reproduction.

- **Speech**

In Speech mode, low and high frequencies are attenuated to improve the reproduction and clarity of the human voice.

- **Late Night**

In Late Night mode, the TV will improve the reproduction and clarity of the human voice with a low volume level.



- **Sports**

Optimised sound for watching sports programmes.



- **Auto**

The sound mode will be adjusted automatically.

Note:

- Auto mode may not be applicable in some models/countries/regions, and to use this function, you must choose **Yes, Enable Enhanced Viewing** in the Enhanced Viewing when you turn the TV on for the first time, or at   >  **Settings** > **System** > **Advanced Settings** > **Enhanced Viewing**. For more information, please refer to [Accessibility and System > Enhanced Viewing](#) in this manual.

Dolby Atmos

  >  **Settings** > **Sound** > **Dolby Atmos**

Set Dolby Atmos to **On** to enhance the richness of sound, and you can enjoy an immersive listening experience.

This function may not be applicable in some models/countries/regions.

Audio Enhancement

  >  **Settings** > **Sound** > **Audio Enhancement**

Set **Audio Enhancement** to have audio experience provided by Dolby Atmos or DTS Virtual X according to your preference.

This function may not be applicable in some models/countries/regions.

Configuring advanced sound settings

  >  **Settings** > **Sound** > **Sound Mode Settings**

Tune the audio settings of the TV. You can personalise the sound quality by adjusting the following settings.

- **Apply Audio Settings**

Adjust current sound mode to apply to all source or just the current source.

- **Total Sonics**

Optimize overall sound quality by increasing bass, making dialogue clear and natural, and widening the sound field.

This function may not be applicable in some models/countries/regions.

- **Total Volume**

Maintain consistent loudness levels from wide dynamic range programmes, loud commercials, and channel or input changes.

This function may not be applicable in some models/countries/regions.

- **Total Surround**

Provide surround sound experience with psycho-acoustic processing to place sounds beside, behind, and above the viewer. For best results use with Total Sonics.

This function may not be applicable in some models/countries/regions.

- **Bass Boost**

Bass Boost uses DTS TruBass™ to enhance the perception of bass frequencies to provide deep, rich bass response from the TV's internal speakers.

This function may not be applicable in some models/countries/regions.

- **Surround Sound**

Surround sound uses DTS TruSurround™ to deliver an immersive surround sound experience from the TV's internal speakers.

This function may not be applicable in some models/countries/regions.

- **Dialogue Clarity**

Dialogue Clarity uses DTS Dialogue Clarity™ to boost the frequency range of the human voice so dialogue is clearly understood and heard above audio or surround effects.

This function may not be applicable in some models/countries/regions.

- **TruVolume**

Automatic control over drastic volume changes while watching TV programs or films, providing a more comfortable and consistent volume.

This function may not be applicable in some models/countries/regions.

- **Equalizer**

Boost the volume at different frequencies.

This function is only applicable when **TV Speakers** is selected at   >

 **Settings > Sound > Speakers > Audio Output.**

- **Subwoofer**

Built-in subwoofer switch.

This function may not be applicable in some models/countries/regions.

- **Bass Boost Value**

Built-in bass adjustment.

This function may not be applicable in some models/countries/regions.

- **Wall Mount Setup**

Automatically optimize the sound based on the position of the TV.

This function may not be applicable in some models/countries/regions.

- **Auto Volume Control**

Activate to prevent the volume from changing when you switch TV channels.

This function may not be applicable in some models/countries/regions.

- **Reset Current Mode**

Restore all of the audio settings in the current audio mode to the factory default values.



Note:

- Some models may not support decoding of DTS CD bitstreams. Playback of this format may produce undesirable noise.

[Related Topic](#)

- [Sound Issues](#)

Speakers Settings

  >  **Settings** > **Sound** > **Speakers**

Select the speakers which you want to use.

Audio Output

Select the speakers which you want to use.

Digital Audio Out

Select the digital audio output format that best suits the audio device type.



- **Auto:** the audio device automatically outputs in a supported format.
- **Pass Through:** the audio device outputs without any processing.
- **PCM:** the audio device outputs PCM (pulse code modulation) format.
- **Dolby Digital:** the audio device outputs Dolby Digital audio when connected to the TV via optical port.
- **Dolby Digital Plus:** the audio device outputs Dolby Digital Plus audio when connected to the TV via HDMI (ARC/eARC) port.

Note:

- This function is only applicable when   >  **Settings** > **Sound** > **Speakers** > **Audio Output** is set to **ARC** or **SPDIF Only**.
- When external audio devices are connected to the TV via optical, **PCM** and **Dolby Digital** are suggested.

Digital Audio Delay

Adjust the digital audio output delay time to sync sound from an external speaker with the images on the TV.

This function is only applicable when   >  **Settings** > **Sound** > **Speakers** > **Audio Output** is set to **ARC** or **SPDIF Only**.

Lip Sync

Synchronize the displayed image with the audio output.

This function may not be applicable in some Audio Output modes.



Balance

Adjust the left and right speaker strength to optimize audio for a specific location.

This function may not be applicable in some Audio Output modes.

This function is not applicable when **Dolby Atmos** is turned on.

eARC



Connect an audio device that supports eARC via HDMI (eARC), and set **eARC** to **On** to enjoy higher sound quality. This feature is available to set when   >  **Settings** > **Sound** > **Speakers** > **Audio Output** is set to **ARC**.

This function may not be applicable in some models/countries/regions.

Related Topic

- [Connecting Speakers or Other Audio Receivers](#)
- [Connecting a Digital Audio System to Use ARC/eARC](#)

Using Headphones

  >  **Settings** > **Sound** > **Headphone**

Set the sound output mode through headphones.

After connecting your wireline or Bluetooth headphone, or other external audio amplifiers, you can set up your TV to your preference.

This function may not be applicable in some models/countries/regions.

Headphone Mode

Change the way audio is sent through the type of device that's connected to your TV Audio Out port.

When you select **Headphone Only**, disable the TV speaker when you are using a headphone, a sound bar, ARC or any other external audio amplifiers. Only external devices have audio output.

When you select **Headphone with Speakers**, TV speaker and Headphone or other connected external devices have audio output.

Headphone Volume

Independently adjust the volume of audio out devices.

In **Headphone Only** mode, you can adjust the volume with volume button on your remote or in Headphone Volume menu on screen.

In **Headphone with Speakers** mode, the TV speaker volume can be adjusted with volume button on your remote normally. The volume of headphone can be adjusted in Headphone Volume menu on screen.

Related Topics

- [Connecting Bluetooth Devices](#)
- [Connecting Headphones](#)
- [Connecting Speakers or Other Audio Receivers](#)

Accessibility and System

Accessibility

  >  **Settings > Accessibility**

Accessibility function provides menu options and audio description to aid the visually or hearing impaired.

- **Menu Scheme**

Select menu scheme style from **Dark, Light**.

- **High Contrast Menu**

Improve contrast for visually impaired.

- **Menu Transparency**

Select menu transparency from **Off, Medium, High**.

- **Audio Type**

Audio Type

Select the audio type of programmes.

Voiceover Volume

Independently adjust the volume of voiceover.

- **Subtitle Settings**

Adjust Subtitle Settings for digital broadcast content.

Subtitle

Select whether to apply Subtitle to your TV. Select from **Off, Subtitle, Hard of Hearing Subtitles**.

Primary Subtitle

Set the default subtitle language for digital broadcast content.

Secondary Subtitle

Set the secondary subtitle language for digital broadcast content.

Note:

- The above functions may not be applicable in some models/countries/regions.

Setting Time

  >  **Settings > System > Time**

Set the current time based on your location.

- **Time Format**

Set the time to display in a 12 or 24-hour format.

- **Date/Time**

Set the Date and Time. You can set the date and time to automatically sync with Internet/broadcast or manually setup by yourself.

This function may not be applicable in some models/countries/regions.

- **Time Zone**

Select your time zone.

This function may not be applicable in some models/countries/regions.

- **Daylight Savings**

Select whether to apply Daylight Savings Time to the TV.

This function may not be applicable in some models/countries/regions.

Using Timer

> **Settings > System > Timer Settings**

Adjust the timer settings to suit your preference.

- **Sleep Timer**

Set the sleep timer to automatically turn the TV Off within a specified time: **Off, 15 Minutes, 30 Minutes, 60 Minutes, 90 Minutes, 120 Minutes or User Defined.**

- **Power On Timer**

Set the clock for the time you want the TV to turn on automatically. You can set the time only once or set the time in specified date by weekly.

- **Power Off Timer**

Set the clock for the time you want the TV to turn off automatically. You can set the time only once or set the time in specified date by weekly.

- **Menu Timeout**

Set the amount of time that you would like for the menu to display: **Off, 10s, 20s, 30s, 60s, 5 min.**

- **Auto Sleep**

Set the amount of time that you would like for TV auto power off without any activity: **Off, 3H, 4H.**

This function may not be applicable in some models/countries/regions.

- **Auto Standby with No Signal**

TV will go standby if there is no signal and the timer times out.

Using Parental Control

  >  **Settings** > **System** > **Parental Control**

Turn on Parental Control to block children from being able to view certain programmes.

If you have not set the PIN code before, create and confirm PIN window displays. Using the D-pad on your remote, create the password.

If you have set the PIN code before, enter PIN window displays.

Set PIN code at   >  **Settings** > **System** > **System PIN**.

- **Locks**

Turn on Locks to enable the Parental Control function.

You will see other Parental Control settings change from a greyed out state to highlighted. When this occurs, **Block Time**, **Channel Block**, **Content Block**, **Input Block**, **App Block**, or **Reset to Default** features are available to set.

- **Block Time**

Block the whole TV usage for a defined period of time, including Live TV, HDMI and apps.

- **Channel Block**

Block TV channels when you turn on the Parental Control feature. To use this function, please scan channels first.

- **Content Block**

Certain programme is blocked by age rating. The rating needs to be provided by the broadcaster.

- **Input Block**

Block content from devices that are connected to certain TV ports.

- **App Block**

Block access to certain apps.

- **Reset to Default**

Restore Parental Control back to the factory default setting.

Setting Language and Location

  >  **Settings** > **System** > **Language and Location**

Select the language used for this TV and your location.

- **Location**

Choose the location from where you will watch your TV.

- **Menu Language**

Set the default language for the TV menu.

- **Primary Audio**

Set the default audio output language for the type of digital broadcast content that you're viewing.

- **Secondary Audio**

Set the secondary audio output language for digital broadcast content.

- **Digital Teletext**

Adjust Teletext decoding.

Using Power Indicator

  >  **Settings > System > Advanced Settings > Power Indicator**

Set the Power Indicator light to stay **On** or **Off** when in standby mode.

  >  **Settings > System > Advanced Settings > Indicator Light Setting**

Set the indicator light from **Power**, **Always** or **Off**.

Note:

- The above functions may not be applicable in some models/countries/regions.

Enhanced Viewing

  >  **Settings > System > Advanced Settings > Enhanced Viewing**

You can turn on Enhanced Viewing features to enhance viewing experience.

- **Automatic Content Recognition**

Turn on Automatic Content Recognition (ACR) to enjoy amazing picture quality and audio quality adjustment for the content watching.

Note:

- This function may not be applicable in some models/countries/regions.
- To use this function, you should accept End User License Agreement and smart feature privacy policy/terms and conditions, and choose **Yes, Enable Enhanced Viewing** in the setting process.

You will see the other Enhanced Viewing settings change from a greyed out state to highlighted. When this occurs, **Picture Mode Auto Adaptation** and **Sound Mode Auto Adaptation** features will be enabled.

- **Picture Mode Auto Adaptation**

Automatically switch to the best picture mode for the content watching.

This function may not be applicable in some models/countries/regions.

- **Sound Mode Auto Adaptation**

Automatically switch to the best audio mode for the content watching.

This function may not be applicable in some models/countries/regions.

Setting Usage Mode



  >  **Settings** > **System** > **Advanced Settings** > **Usage Mode**

Set the TV to use in Home or Store mode.

- **Home Mode**

Select Home Mode for normal TV usage, and use less energy.

If you want to switch to Store Mode when the TV is in Home Mode, press



  button to select  **Settings**, and select **System** > **Advanced Settings** > **Usage Mode**, and choose **Store Mode**.

- **Store Mode**

Select Store Mode, and the TV will be on display in a retail setting. This mode effects E-Pos and other demo functions, and is only intended for use in retail stores.

When Store Mode is selected, press   button on your remote control to enter store mode settings.

If you want to switch to Home Mode when the TV is in Store Mode, press

  button to select  **Settings**, and select **System** > **Advanced Settings** > **Usage Mode**, and choose **Home Mode**.

Note:

- Enabling Store Mode could increase energy consumption.

Using Remote Control Service

  >  **Settings** > **Support** > **Remote Control Service**

Remote Control Service enables your TV to be controlled from the client server to let service agent diagnose the problem of your TV and dealing with the problem online efficiently.

To use this function:

1. Turn on **Remote Control Service**.
2. Select **Agree All** and **Confirm** in End User License Agreement page.
3. Select **Generate PIN** in Remote Control Service.

4. You can initiate a help request to service agent by hotline and provide the on-screen PIN.

Note:

- This function may not be applicable in some models/countries/regions.
- Steps above may vary. Please refer to the actual product.
- Keep the network connected when the Remote Control Service is running.

Upgrade

  >  **Settings > Support > System Upgrade**

Set your TV to receive the latest firmware.

- **Auto Firmware Upgrade**

Set your TV to automatically receive the latest firmware.

- **Check Firmware Upgrade**

Check to ensure that your TV has received the latest firmware.

Please ensure your TV is connected to the Internet.

- **Check OAD Upgrade**

Check to ensure that your TV has received the latest firmware via the tuner.

Note:

- Please ensure your TV is connected to the Internet.
- This function is only applicable when Thailand and Malaysia are selected in Location.

- **System App Auto Upgrade**

Set your system applications to automatically upgrade to the latest version. App auto upgrade will be done in the background. May need your confirmation on new Privacy Notices to complete upgrade in the progress.

- **Upgrade from USB**

Upgrade TV software from USB device.

Note:

- Please ensure the USB flash drive insert to USB 2.0 port of the TV.
- The updating files must be available in root directory.
- The format of the USB must be FAT32 and the partition table type must be MBR.

Related Topic

- [Connecting USB Devices](#)

Reset to Factory Default



  >  **Settings > Support > Reset to Factory Default**

Restore your TV to the factory default. Reset will clear your personal setup and information.

Troubleshooting









Picture Issues

When the TV has a picture problem, these steps may help resolve the problem.

  >  **Settings** > **Support** > **Self Diagnosis** > **Picture Test**

Before you review the list of problems and solutions below, use **Picture Test** to determine if the problem is caused by the TV. **Picture Test** displays a high definition picture that you can examine for flaws or faults.



- If the test picture does not appear or there is noise or distortion, the TV may have a problem. Contact the service company in your country/region.
- If the test picture is displayed properly, there may be a problem with an external device. Please check the connections.
- If the problem persists, check the signal strength or refer to the external device's user manual.

Problem	Possible Solutions
No picture, or black and white picture.	<ul style="list-style-type: none">• Unplug the TV power cord from AC outlet and re-plug after 60 seconds.• Check if the Colour Saturation is set to 50 or higher at   >  Settings > Picture > Picture Mode Settings > Colour Saturation.• Try different TV channels.
The picture is distorted.	<ul style="list-style-type: none">• The compression of video content may cause picture distortions, especially in fast moving pictures from sports programmes and action movies.• If the signal reception is weak or poor, screen distortion may be visible but it is not a malfunction.• Mobile phones used close to the TV (within 1m) may cause noise on analogue and digital channels.
The picture is blurry or flickering, or cuts out momentarily.	<ul style="list-style-type: none">•   >  Settings > Picture > Picture Mode Settings > Sharpness. You can try to increase or decrease the Sharpness.• If you use an external antenna, check the direction, position and connection of the antenna.• Adjust the direction of your antenna, or reset or fine tune the channel.
The picture appears red, purple, pink and other colours.	<ul style="list-style-type: none">•   >  Settings > Picture > Picture Mode Settings > Expert Settings > White Balance. You can try to increase or decrease the White Balance.

Problem	Possible Solutions
Picture distorted or appear wavy.	<ul style="list-style-type: none"> • Some electrical appliances may affect the TV. If you turn off the appliance and the interference goes away, then move it further away from TV. • Insert the power plug of the TV into another power outlet.

Sound Issues

When the TV has a sound problem, these steps may help resolve the problem.



  >  **Settings > Support > Self Diagnosis > Sound Test**

If the TV plays the **Sound Test** melody without distortion, there may be a problem with an external device or the broadcast signal's strength.



Problem	Possible Solutions
There is no sound or the sound is too low at maximum volume.	<ul style="list-style-type: none"> • Check the volume control of the device (cable or satellite box, DVD, Blu-ray, etc.) connected to your TV.
Picture is normal, but no sound.	<ul style="list-style-type: none"> • Check the volume settings. • Check if 'Mute' mode is set to on.
The speakers are making an odd sound.	<ul style="list-style-type: none"> • Make sure that the audio cable is connected to the correct audio output connector on the external device. • For antenna or cable connections, check the signal information. • A low signal level may cause sound distortions.
Sound distorted or appears wavy.	<ul style="list-style-type: none"> • Some electrical appliances may affect the TV. If you turn off the appliance and the interference goes away, then move it further away from TV. • Insert the power plug of the TV set into another power outlet.
Sound is blurry or cuts out momentarily.	<ul style="list-style-type: none"> • If you use an external antenna, check the direction, position and connection of the antenna. • Adjust the direction of your antenna or reset or fine tune the channel.

Network Issues

When the TV has difficulties in connecting to the Internet, these steps may help resolve the problem.













  >  **Settings > Support > Self Diagnosis > Network Test**

If the TV network is connected, the screen will display Connected successfully.

Problem	Possible Solutions
The TV cannot connect to your network or apps.	<ul style="list-style-type: none"> • Make sure the TV has a network connection. • Run   >  Settings > Support > Self Diagnosis > Network Test. • Contact your Internet service provider.
The wireless network connection failed.	<ul style="list-style-type: none"> • Make sure your wireless modem/router is on and connected to the Internet.
The wireless network signal is too weak.	<ul style="list-style-type: none"> • Position your wireless router, modem router, or access point in a central location. Avoid putting it in a corner.

External Device Connection Issues







When the TV has difficulties with external device connection, these solutions may help resolve the problem.

Problem	Possible Solutions
I have connected an external source to my TV but I get no picture and/or sound.	<ul style="list-style-type: none"> • Check whether the connection between the external device and your TV is correct. • Make sure you have made the correct selection of input source.
The cable box is no signal or weak signal.	<ul style="list-style-type: none"> • If there is no signal occasionally, unplug cable from TV and re-plug after 60 seconds. • If there is always no signal, or the signal cannot be restored after plugging and unplugging, you can try   >  Settings > System > HDMI & CEC > HDMI Format, to confirm whether the signal can be recognized. • Change to another HDMI port. • Change to another HDMI cable.
There is no sound.	<ul style="list-style-type: none"> • Check whether ARC is selected at   >  Settings > Sound > Speakers > Audio Out. If not, you need to check whether the external power amplifier device is connected to the ARC/eARC port or optical port of the TV. •   >  Settings > Sound > Speakers > Digital Audio Out. You can try to select PCM, Dolby Digital, or Dolby Digital Plus. • Whether the power amplifier device port is connected correctly. • If you select HDMI as input, you can try   >  Settings > System > HDMI & CEC > HDMI Format.

Problem	Possible Solutions
The remote control does not work.	<ul style="list-style-type: none"> • Confirm that TV still has power and is operational. • Change the new batteries in the remote control. • Check if the batteries are correctly installed. • If some buttons don't work, but the volume buttons can work normally, it seems there is a problem with the application.

Apps

When some apps aren't playing, this may help resolve the problem.

Problem	Possible Solutions
Netflix can't be played.	<ul style="list-style-type: none"> •   >  Settings > System > Application Settings > Netflix > Forced Closure, then reopen to try. • You can try to reset to the factory settings at   >  Settings > Support > Reset to Factory Default.

Media Files

When files aren't playing, this may help resolve the problem.

Problem	Possible Solutions
Some files can't be played.	<ul style="list-style-type: none"> • Most files can be played back, but you might experience problems with corrupted files or files with high-bitrate, unsupported resolution, unsupported container or codec formats.

Related Topic

- [Media](#)

Voice Service Issues

When some Voice service aren't playing, this may help resolve the problem.

Problem	Possible Solutions
Alexa can't be played.	<ul style="list-style-type: none"> • For more information about Alexa, please refer to Smart Functions > Using Voice Service > Alexa in this manual.

Problem	Possible Solutions
Google assistant can't be played.	<ul style="list-style-type: none"> You can try to log in Google account. If you receive "I don't understand" of the voice recognition, please change account or log out the account. After logging in to the Google account, the recognition language may be different. You need to log in to the Google account on the web page to set the voice language. For more information about Google Assistant, please refer to Smart Functions > Using Voice Service > Google Assistant in this manual.

TV Status Diagnosis

  >  **Settings > Support > Self Diagnosis**

Perform self diagnosis to test sound, picture and connections.

Use **Picture Test** to help diagnose video issues and **Sound Test** to diagnose sound issues. You can also view signal strength information for over-the-air digital signals by using **Network Test** and **Input Connection Test**. Additionally, you can view the status of the TV by using **Status Check**.

Recording/Timeshift Issues

When **Timeshift** or **Schedule recording** isn't working, these steps may help resolve the problem.

Problem	Possible Solutions
Schedule Recording cannot be used.	<ul style="list-style-type: none"> Check if there is a storage device connected to the TV. Check the free space of the storage device. The function will not work if there isn't enough storage space in the device. Check whether your storage device is damaged. If so, it is suggested to format your storage device. Recording will automatically stop if the signal becomes too weak. Recording or timeshift function may not work because of the slow speed of read-write for USB flash drive. Recording or timeshift function may not work because the storage format of your device is unsupported.

- The Recording/Timeshift functions may not be applicable in some models/countries/regions.

Related Topic

- [PVR](#)

- [Timeshift](#)



Other Issues

Use these procedures to resolve other issues that may occur.

Problem	Possible Solutions
The TV is hot.	<ul style="list-style-type: none"> • Watching TV for an extended period of time causes the panel to generate heat. The heat from the panel is dissipated through internal vents running along the top of the TV. • After extended use, you may feel hot when touching it. This heat, however, is not a defect and does not affect the TV's functionality.
The TV smells of plastic.	<ul style="list-style-type: none"> • This smell is normal and will dissipate over time.
The plastic cabinet makes a "clicking" type of sound.	<ul style="list-style-type: none"> • The "clicking" sound can be caused when the temperature of the TV changes. This change causes the TV cabinet to expand or contract, which makes the sound. This is normal and the TV is OK.
When I turn on my TV, there is a delay for a few seconds before the picture appears. Is this normal?	<ul style="list-style-type: none"> • Yes, this is normal. The TV is initializing and searching for previous setting information.

Using the E-Manual

Launching the E-Manual

  >  **Settings** > **Support** > **E-Manual**

View the embedded E-Manual that contains information about your TV's key features.

- The black background icon stands for the button on the remote control.
- The grey background icon stands for the icons on the TV screen for selecting.

Disclaimer:

Instructions and images through this manual are only for reference and may differ from the actual product.

Using the buttons in the E-Manual

Search

Search for the product feature information, and the E-Manual will provide all the titles and content that contains the search information.

QR Code

Scan the QR Code with your Smart Phone to Open the E-Manual on it.

Try Now button

Select **Try Now**, and it will guide you to the corresponding TV menu for running the function.

Guidelines

Note:

- Guidelines content is only applicable in Germany.

How are TV channels sorted and why?

Channel sorting

The availability of individual channel may depend on the selected reception path, such as satellite (DVB-S/S2), cable (DVB-C) or antenna (DVB-T2) and the signal strength.

Standard or an operator (Astra 19.2°, Vodafone (NRW, Hessen, BW) or Pÿur) can be selected for automatic channel search.

To sort channels when selecting an operator:

When an operator is selected, the channels are sorted based on the operator's criteria.

Channel sorting when selecting **Standard**:

After a successful channel search, the channels are sorted by genre. These include full programmes, children, sports, documentation or regional and local programmes.

Broadcasters with less coverage and, if available, international channels are listed in alphabetical order after the pre-sorted list.

If LCN (Logical Channel Number, only possible with cable reception) is activated during the channel search, the sorting takes place according to the criteria of the local cable network operator.

Search by Channel name

The search within Live TV can be opened with the **V** button. Here you can search for individual channels by name.

Radio Transmitter

Radio channels are listed in alphabetical order after the list of TV channels.

To make finding radio channels easier, the filter function of the channel list is recommended (please refer to [Channal List](#) in this manual).

Sponsored Content

On the basis of bilateral contracts with the respective broadcasters, individual channels are placed in a position defined by them in the channel list.

Sort Manually

The channel list can be manually sorted at any time. More information can be found in [Channel Edit](#) and [Favourite](#) in this manual.

How are apps sorted and why?

The applications on the VIDAA platform are positioned according to the bellow criteria.

In the Application Docker on the Home Launcher:

To ensure equal representation of apps and provide fair treatment of newly launched content partners, the applications are ordered based on the (i) global number of users, (ii) number of users in Germany, (iii) number of subscribers in Germany, (iv) share of local language content, (v) variety of content, and (vi) novelty of the platform. At all times the Application launcher must include:

- the 2 leading global SVOD platforms
- the 2 leading global TVOD platforms

- the 2 leading global AVOD platforms
- the leading local sports platform
- at least 4 leading local applications with predominantly German content
- at least 1 leading application with children's content
- at least 2 applications that have launched in the last 6 months



The ordering of applications is reviewed every 6 months and a new programming table is issued for newly connected devices.



In the My Apps section:



The applications are ordered in alphabetical order.

How can TV channels and apps be customized?









TV channels

In Live TV, press   >  to select a Live TV channel category such as Antenna or Cable, then use D-pad to select **Edit**.

Alternatively, in Live TV, press   button, select **Settings > Channel > Channel Edit**, and select a Live TV channel category such as Antenna or Cable.



- Press  button on the selected channel, then a checkbox will appear. You can select multiple channels at the same time to move or delete.
- Move: Press  button to move the selected channel.

Moving the channels could be restricted by the operator. If you want to be able to move channels, it is not recommended to choose an operator during channel scan, and LCN should be set to **Off**.

- Delete: Press  button to delete the selected channel.
- Restore: Press  [RED] button, or press  button to call out the colour menu and select RED to enter the list of deleted channels. Press  button to restore the deleted channel.
- Filter: Press  [YELLOW] button or press  button to call out the colour menu and select YELLOW, the filter screen will pop up. Press  button to select options, and the channel list can be updated.
- Search: Press  [BLUE] button or press  button to call out the colour menu and select BLUE, to search the channel.



Favourite list

Viewing your favourite list



In Live TV, press   >  > **Fav** to call out the favourite list. A heart-shaped icon appears next to your favourite channel.

Editing the favourite list

In Live TV, press   >  > **Fav** >  to select **FAV1 - FAV4**, then use D-pad to select **Edit**.

Alternatively, go to   > **Settings** > **Channel** > **Channel Edit**, and select **FAV1 - FAV4**.

You can add, move or remove favourite channels.

- Select  **Add channels** to add the selected channel to the favourite list.
- Select a channel in a favourite list, and press  button to move it.
- Select a channel in a favourite list, and press  button to remove it.

Apps

  > **My Apps**

Select the item you want to move, press   button to manage, and press  button to store position.

Note:

- Some app cannot be moved.

How are recommendations created?

Recommendations on the platform are dependent on the ability and willingness of partners to provide metadata to the platform. The content is positioned depending based on the following criteria:

Above applications:

The recommendations originate from the Content partners that are highlighted. They are in the domain of the end-user.

Bellow applications:

Recommendation rows are created by the editorial team, following these guidelines:

1. Content variety – Providing a broad selection of content
2. Type of access variety – Providing advertising-supported, subscription, and transactional content
3. Balance – Providing a balance between global and local content