

> IFP4320

Commercial Touch Display User Guide

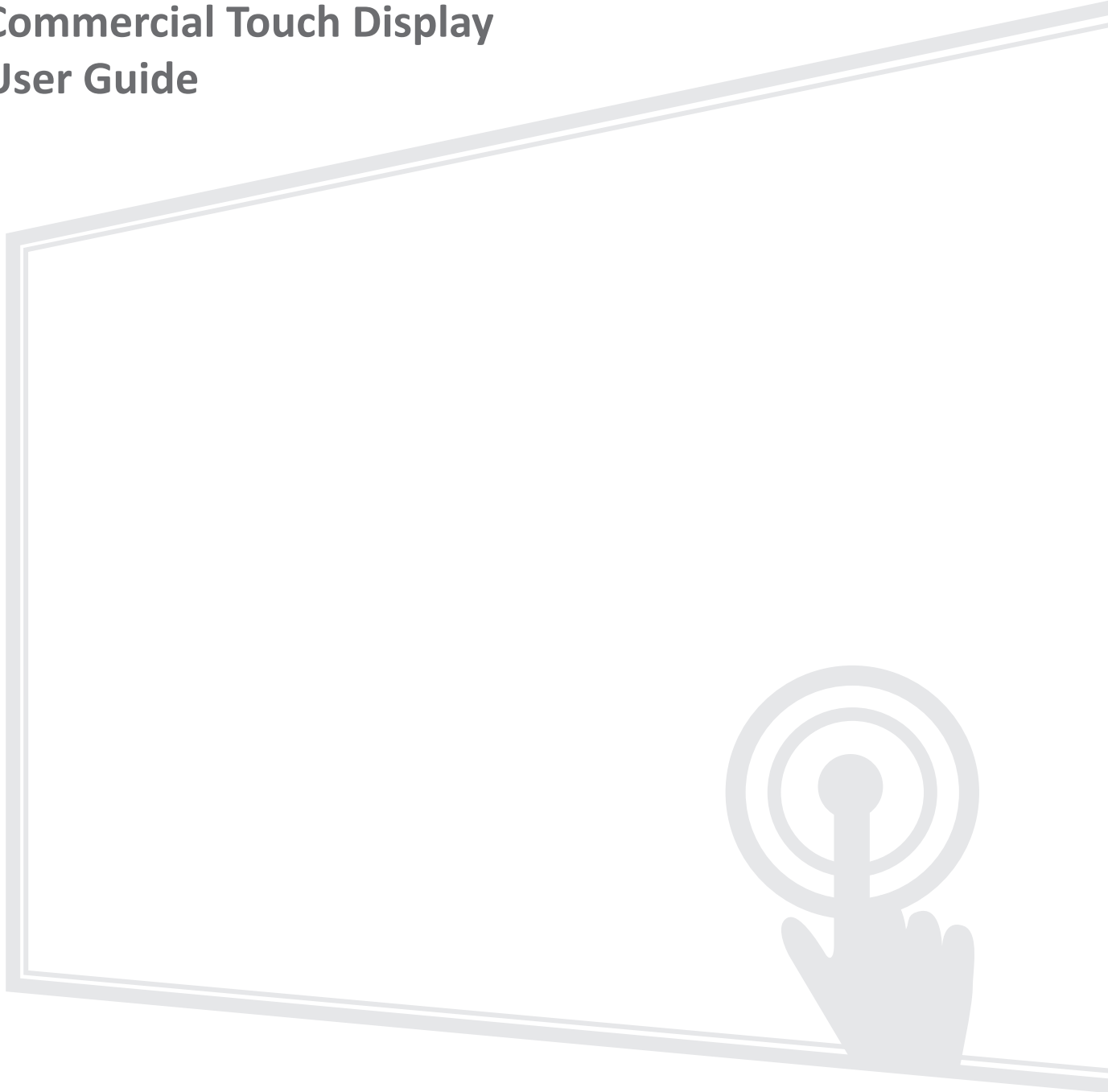

IMPORTANT: Please read this User Guide to obtain important information on installing and using your product in a safe manner, as well as registering your product for future service. Warranty information contained in this User Guide will describe your limited coverage from ViewSonic® Corporation, which is also found on our web site at <http://www.viewsonic.com> in English, or in specific languages using the Regional selection box in the upper right corner of our website. "Antes de operar su equipo lea cuidadosamente las instrucciones en este manual"

Model No. VS18454
P/N: IFP4320

Thank you for choosing ViewSonic®

As a world-leading provider of visual solutions, ViewSonic® is dedicated to exceeding the world's expectations for technological evolution, innovation, and simplicity. At ViewSonic®, we believe that our products have the potential to make a positive impact in the world, and we are confident that the ViewSonic® product you have chosen will serve you well.

Once again, thank you for choosing ViewSonic®!

> Safety Precautions

Please read the following **Safety Precautions** before you start using the device.

- Keep this user guide in a safe place for later reference.
- Read all warnings and follow all instructions.
- Do not use the device near water. To reduce the risk of fire or electric shock, do not expose the device to moisture.
- Never remove the rear cover. This display contains high-voltage parts. You may be seriously injured if you touch them.
- Avoid exposing the device to direct sunlight or other sources of sustained heat.
- Do not install near any heat sources such as radiators, heat registers, stoves, or other devices (including amplifiers) that may increase the temperature of the device to dangerous levels.
- Use a soft, dry cloth to clean the external housing. For more information, refer to the "Maintenance" section.
- When moving the device, be careful not to drop or bump the device on anything.
- Do not place the device on an uneven or unstable surface. The device may fall over resulting in an injury or a malfunction.
- Do not place any heavy objects on the device or connection cables.
- If smoke, an abnormal noise, or a strange odor is present, immediately turn the device off and call your dealer or ViewSonic®. It is dangerous to continue using the device.
- The device is a monitor with an LED backlight intended for general office use.
- Do not attempt to circumvent the safety provisions of the polarized or grounding-type plug. A polarized plug has two blades with one wider than the other. A grounding-type plug has two blades and a third grounding prong. The wide blade and the third prong are provided for your safety. If the plug does not fit into your outlet, obtain an adapter and do not attempt to force the plug into the outlet.
- When connecting to a power outlet, DO NOT remove the grounding prong. Please ensure grounding prongs are NEVER REMOVED.
- Protect the power cord from being treaded upon or pinched, particularly at the plug, and at the point where it emerges from the equipment. Ensure that the power outlet is located near the equipment so that it is easily accessible.

- Only use attachments/accessories specified by the manufacturer.
- When a cart is used, use with caution when moving the cart/equipment combination to avoid injury from tipping over.
- Disconnect the power plug from the AC outlet if the device is not being used for a long period of time.
- Place the device in a well-ventilated area. Do not place anything on the device that prevents heat dissipation. Also, avoid any direct lighting.

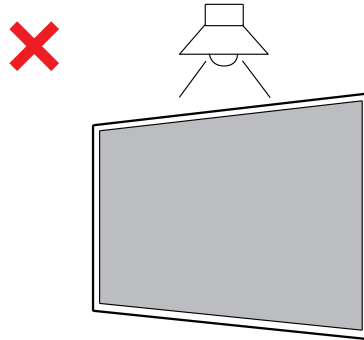
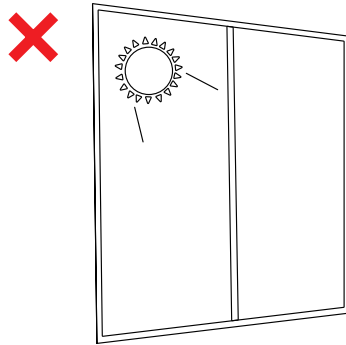
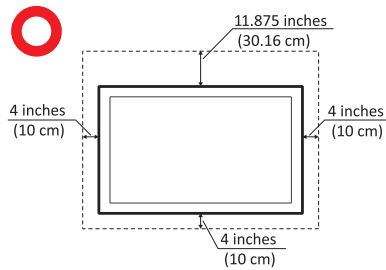
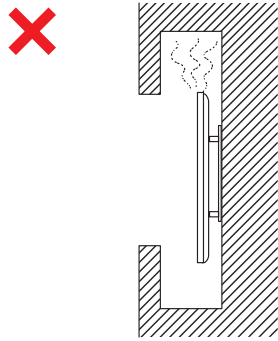

- **CAUTION:**

Immediately unplug your device from the wall outlet and refer servicing to a qualified service personnel under the following conditions:

- » When the power supply cord or plug is damaged.
- » If liquid has been spilled onto or objects have fallen into the unit.
- » If the unit has been exposed to moisture.
- » If the unit does not operate normally or has been dropped.

Never place the device in an unstable location. The device may fall, causing serious personal injury or death. Many injuries, particularly to children, can be avoided by taking simple precautions such as:

- » Using cabinets or stands recommended by the manufacturer of the device.
- » Only using furniture that can safely support the device.
- » Ensuring the device is not overhanging the edge of the supporting furniture.
- » Not placing the device on tall furniture (e.g., cupboards or bookcases) without anchoring both the furniture and the device to a suitable support.
- » Not placing the device on cloth or other materials that may be located between the device and supporting furniture.
- » Educating children about the dangers of climbing on furniture to reach the device or its controls.

If the existing device is going to be retained and relocated, the same considerations as above should be applied.

> Contents

Safety Precautions.....	3
Introduction	10
Package Contents	10
Wall Mounting Specifications (VESA)	11
Product Overview	12
Front Panel	12
Rear Panel	12
Control Panel.....	13
I/O Panels	14
Remote Control	16
Using Gestures	19
Select and Deselect an Object (Clicking)	19
Display Menu Options (Right-Clicking)	19
Double-Clicking	19
Moving an Object	20
Erasing Digital Ink	20
Making Connections	21
Connecting External Devices and Touch Connection	21
USB Type-C Connection.....	22
DisplayPort Connection.....	22
HDMI Connection	22
VGA Connection	22
DVI Connection.....	22
RS-232 Connection	23
USB and Networking Connections	24
Media Player Connection	25
SPDIF Connection	26

Using Your ViewBoard.....	27
Powering On/Off your ViewBoard.....	27
Initial Launch Setup	28
vLauncher - Customizable Welcome Screen.....	31
vLauncher Message.....	31
Applications.....	32
Toolbar	34
On-Screen Display (OSD) Menu	40
General Settings	41
Input Settings	42
Widget.....	43
Settings - HDMI & VGA Input Source.....	44
Audio Settings	44
Screen Settings.....	45
Display Settings	46
Low Blue Light Filter and Eye Health.....	47
Adjust Settings - (VGA Only).....	49
Settings - ViewBoard Player	50
Wireless & Network	50
Wi-Fi	51
Ethernet	52
Wireless Hotspot.....	53
VPN.....	54
Share	56
SAMBA.....	56
Display	58
Wallpaper	59
Protection.....	61
Preference.....	62
Touch	63
Language	63
Keyboard & Input Method	64
Date & Time	65
Boot Mode	66
Startup & Shutdown.....	67
Toolbar Setting	68

Input Source	69
Rename Input Source	70
Source.....	71
App	72
APP	73
System	75
Storage	76
Clone to USB.....	76
Display ID.....	77
Security.....	78
Privacy and Copyright Protection.....	80
System Update	81
About Device	82

Embedded Applications and Settings..... 83

Embedded Digital Whiteboarding App.....	83
Whiteboard	83
ViewBoard Cast	85
Cast Sender from Windows-based, Macbook, and Chrome devices.....	86
Cast Sender from Mobile Devices: iOS-based (iPhone, iPad) and Android OS based phone/tablet.	87
Screen Recorder	88
Other Default Applications.....	89
vSweeper.....	89
Screen Lock	90
Chromium.....	91
Folders.....	92

RS-232 Protocol..... 94

Description	94
RS-232 Hardware Specification	94
LAN Hardware Specification.....	95
RS-232 Communication Setting.....	95
LAN Communication Setting	95
Command Message Reference.....	95
Protocol	96
Set-Function Listing.....	96

Appendix.....	101
Specifications.....	101
Display Modes	102
VGA Mode	102
HDMI/DisplayPort/Type-C Mode	102
Troubleshooting	103
Maintenance.....	105
General Precautions	105
Cleaning the Screen.....	105
Cleaning the Case	105
Regulatory and Service Information	106
Compliance Information.....	106
FCC Compliance Statement.....	106
Industry Canada Statement.....	106
CAN ICES-3 (B)/NMB-3(B).....	106
CE Conformity for European Countries	106
Declaration of RoHS2 Compliance.....	107
ENERGY STAR® statement.....	108
Indian Restriction of Hazardous Substances	108
Product Disposal at End of Product Life	108
Copyright Information	109
Customer Service	110
Limited Warranty	111
Mexico Limited Warranty.....	114

> Introduction

Package Contents

- HDMI cable (3.28 ft/1 m)
- Power cable (5.9 ft/1.8 m)
- Remote control
- AAA battery x 2
- USB cable for touch (3.28 ft /1 m)
- Quick Start Guide
- RS-232 adapter
- USB Type-C cable (3.28 ft /1 m)
- STND-056
- Compliance Statement

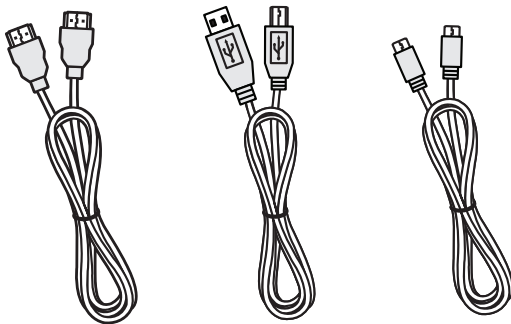
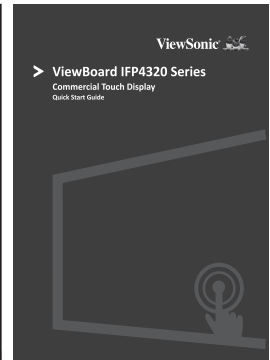
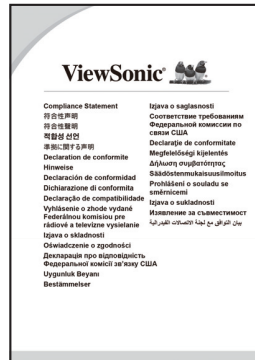
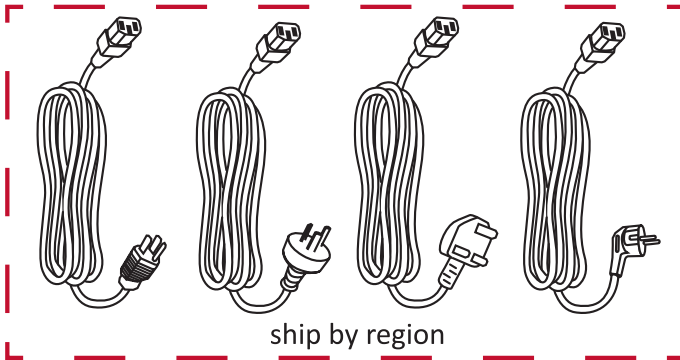

NOTE: The power cord and video cables included in your package may vary depending on your country. Please contact your local reseller for more information.

Wall Mounting Specifications (VESA)

NOTE: Please follow the instructions in the wall mount installation guide to install your wall mount or mobile mount bracket. If attaching to other building materials, please contact your nearest dealer.

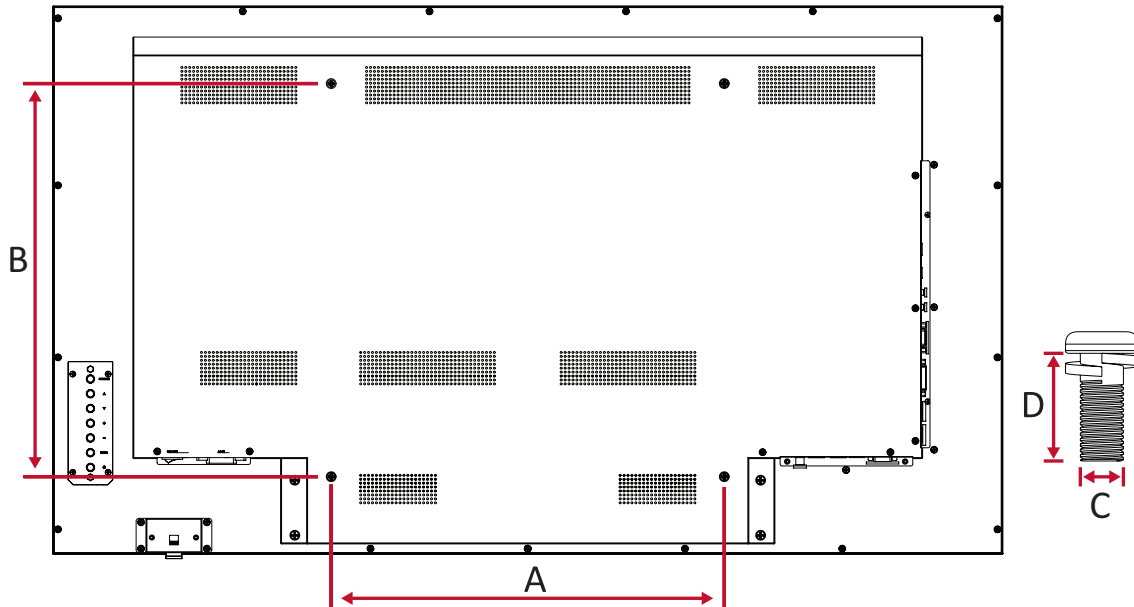

Model	VESA Spec. (A x B)	Standard Screw (C x D)	Quantity
IFP4320 Series	400 x 400 mm	M6 x 25 mm	4

NOTE: Do not use screws that are longer than the standard dimension, as they may cause damage to the inside of the display.

Product Overview

Front Panel



Rear Panel

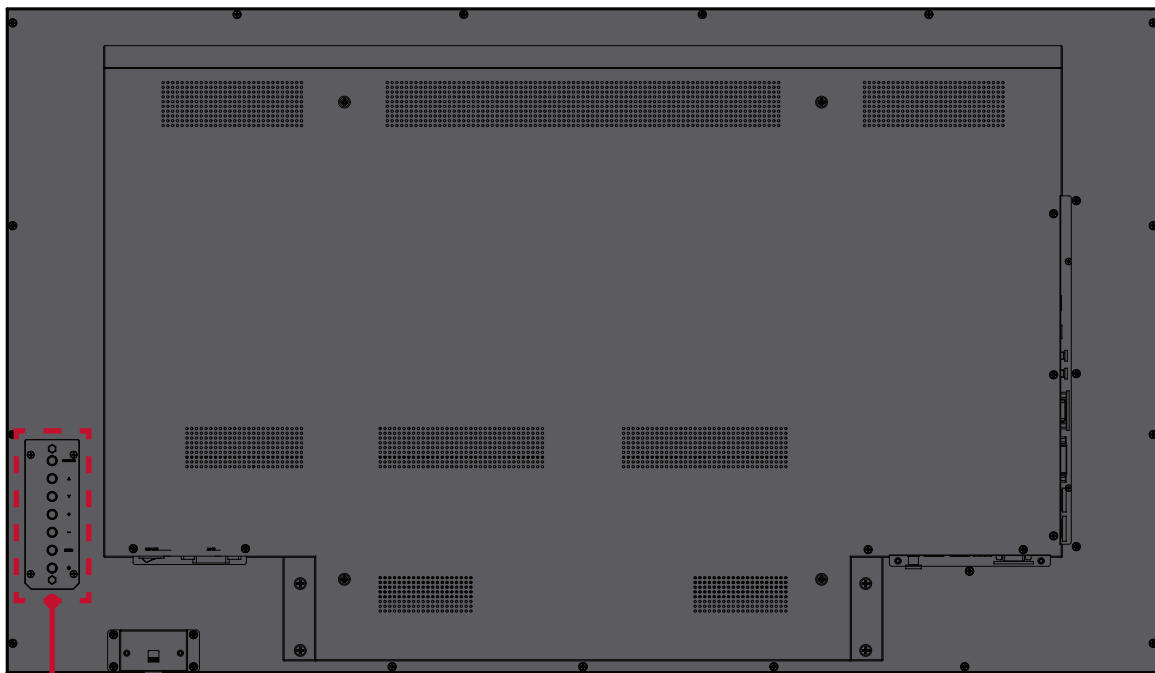

Control Panel

Control Panel

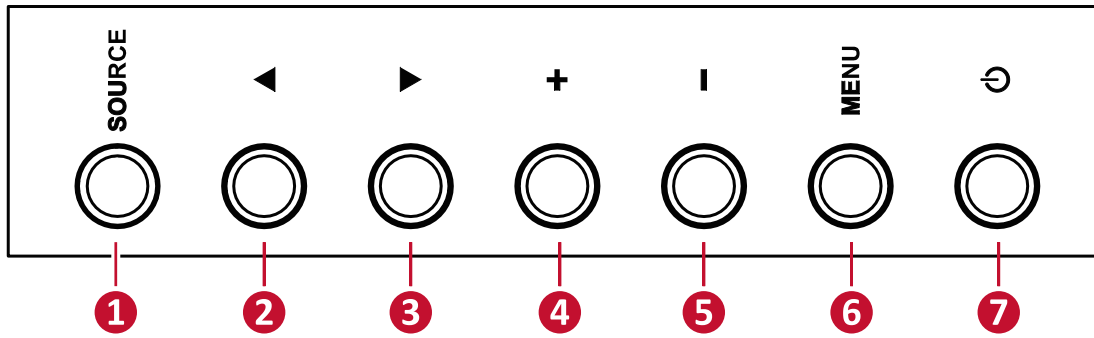

Number	Description
1	<ul style="list-style-type: none"> • Enter the signal source selection menu. • Select the signal source. • Confirm the operation under MENU.
2	In the OSD Menu, press the keys to select an item.
3	
4	<ul style="list-style-type: none"> • Increase the volume level. • In the OSD Menu, adjust the value of the selected item.
5	<ul style="list-style-type: none"> • Decrease the volume level. • In the OSD Menu, adjust the value of the selected item.
6	<ul style="list-style-type: none"> • Enter the Main Menu. • Confirm the operation in the SOURCE menu.
7	<ul style="list-style-type: none"> • Press to turn on/off the display's backlight. • Press and hold to turn on/off the device.

I/O Panels

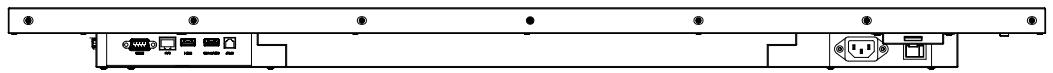
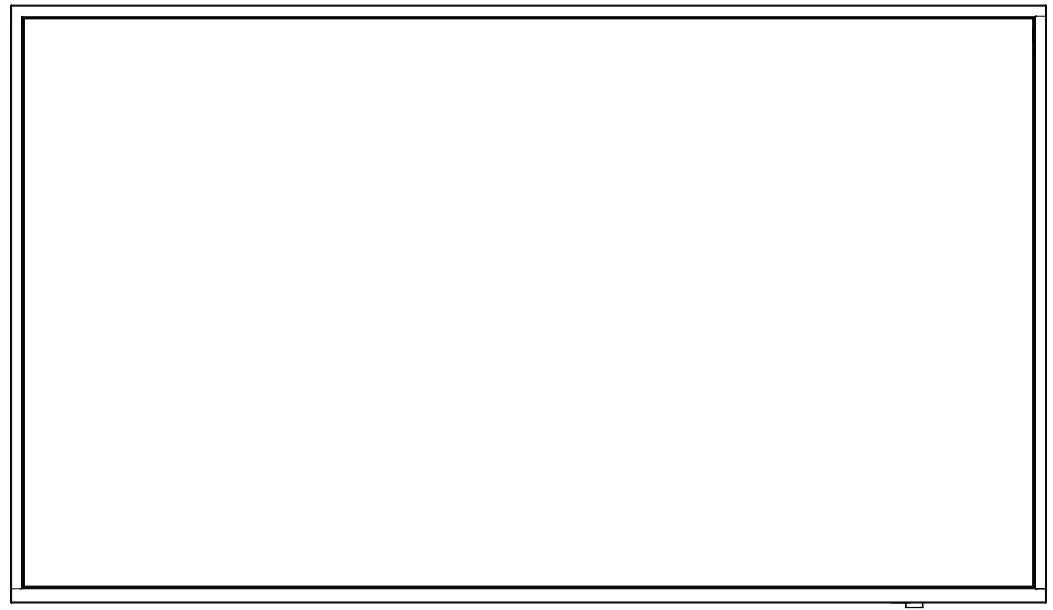
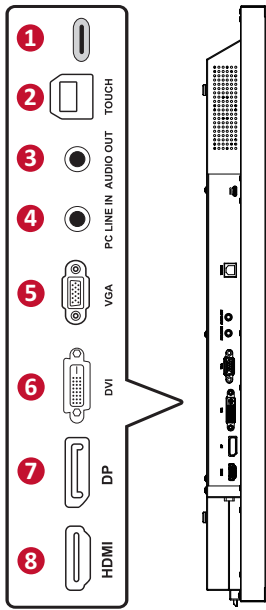

Number	Port	Description
1	USB Type-C	USB Type-C input; connect to a PC with USB Type-C output.
2	TOUCH	<ul style="list-style-type: none"> • Touch signal output to external PC. • After connection (with an external PC), the device connected to the USB 3.0 port can directly be used by the external PC.
3	Audio Out	Audio output to an external speaker/headset.
4	PC Line In	External computer audio input.
5	VGA	External computer video input.
6	DVI	DVI input; connect to a PC with DVI output.
7	DisplayPort	DisplayPort input; connect to a PC with DisplayPort output.
8	HDMI	High definition input; connect to a PC with HDMI output, set-top box, or other video device.
9	RS-232	Serial interface; used for mutual transfer of data between devices.
10	LAN	Standard RJ45 (10M/100M/1000M) Internet connection interface.
11	USB 1	Connect USB devices such as hard disks, keyboard, mouse, etc.
12	Smart USB	Connect USB devices such as hard disks, keyboard, mouse, etc. Automatically switches between PC and ViewBoard.
13	SPDIF	Multichannel sound via optical signals.

Remote Control

Number	Description
1	Power on/off
2	Screen capture
3	Startup writing
4	Back to the ViewBoard player Home Screen
5	Back/Return to the previous page
6	Increase/Decrease the Volume
7	Number Keypad
8	Information
9	Input source selection
10	Media control buttons: <ul style="list-style-type: none"> • Red: Play/Pause • Green: Stop • Yellow: Forwards • Blue: Backwards
11	Settings menu
12	Up/Down/Right/Left/OK
13	Freeze screen
14	Mute/Unmute
15	Increase/Decrease Brightness
16	Blank Screen
17	Adjust Aspect Ratio

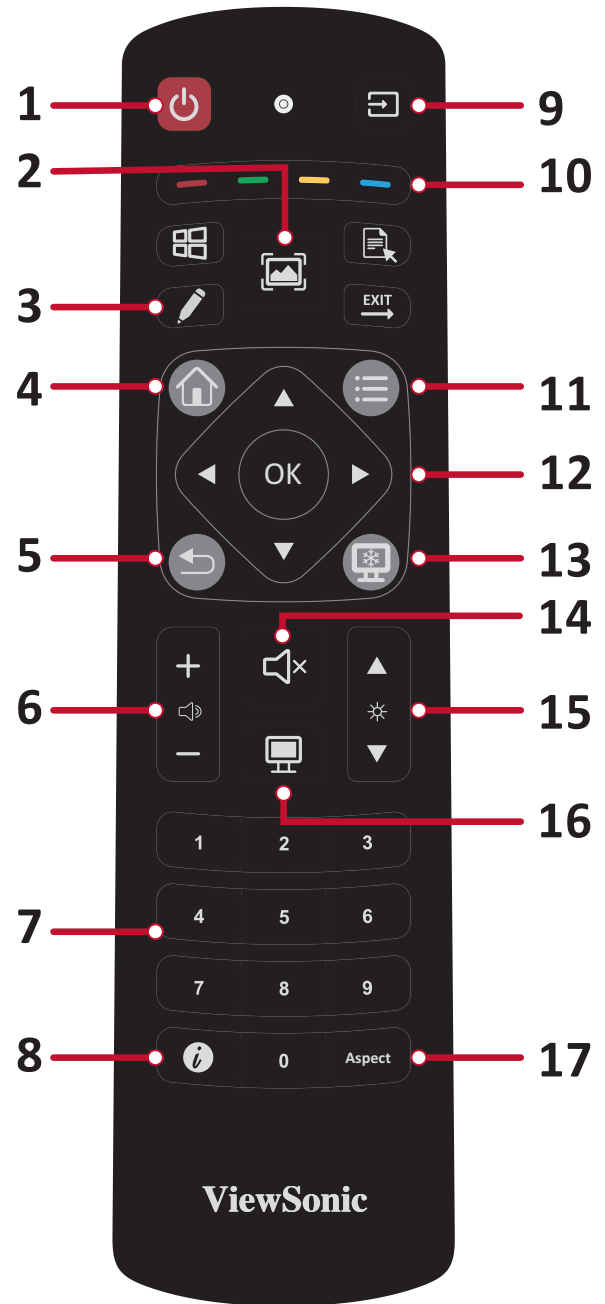

Inserting Remote Control Batteries

To insert batteries into the remote control:

1. Remove the cover on the rear of the remote control.
2. Insert two “AAA” batteries, ensuring the “+” symbol on the battery matches the “+” on the battery post.
3. Replace the cover by aligning it with the slot on the remote control and snapping the latch shut.

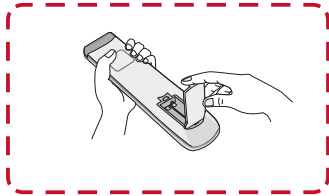

(1)

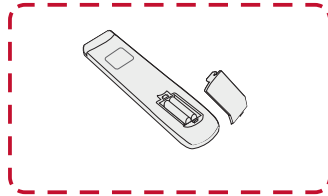

(2)

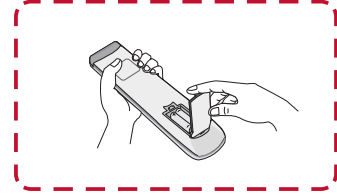

(3)

WARNING: There is a risk of explosion if batteries are replaced with the incorrect type.

NOTE:

- It is recommended that you do not mix battery types.
- Always dispose of old batteries in an environmentally friendly way. Contact your local government for more information on how to dispose of batteries safely.

Remote Control Receiver Range

The working range of the remote control is shown here. It has an effective range of 6 meters, 30° degrees left and right. Ensure there is nothing obstructing the remote control's signal to the receiver.

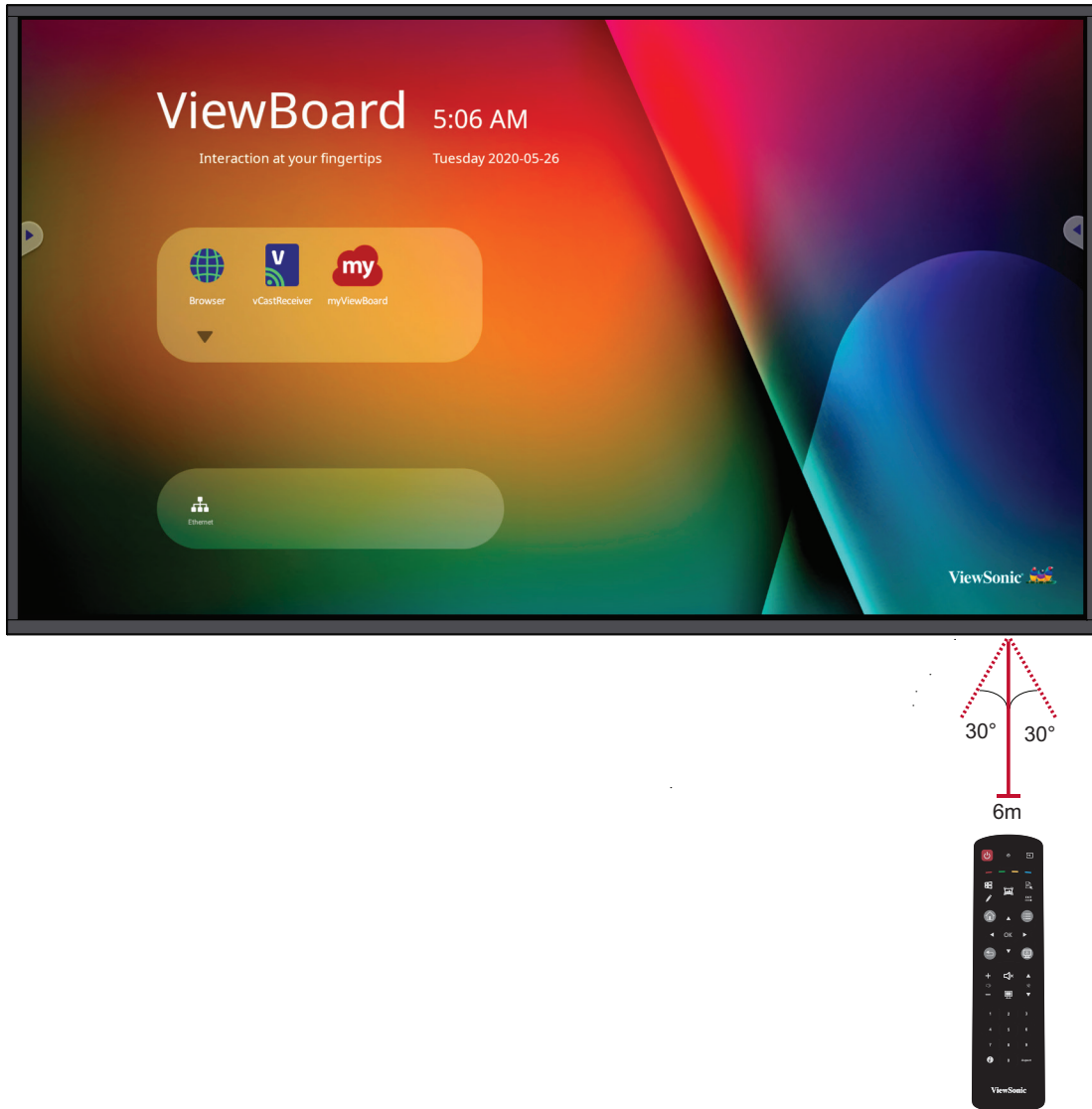

Using Gestures

Touch gestures allow the user to use pre-determined commands without using a keyboard or mouse. Using gestures on the ViewBoard, the user can select/deselect objects, change the location of an object, access settings, erase digital ink, and much more.

Select and Deselect an Object (Clicking)

Press and release the ViewBoard to select/deselect options or objects. This is like a single, standard left mouse click.



Display Menu Options (Right-Clicking)

Press and hold the ViewBoard with your finger. This is like a single, standard right mouse click.



Double-Clicking

Quickly press and release twice in the same location on the ViewBoard. This is like a double, standard left mouse click.



Moving an Object

Press and hold the object on the ViewBoard and slowly drag it with your finger to your desired location.

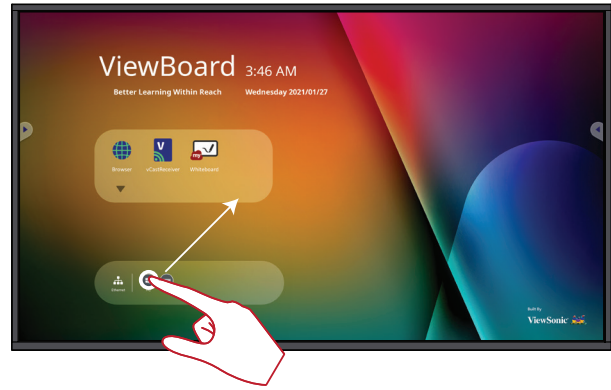

Erasing Digital Ink

Use your flattened hand, palm, or fist on the ViewBoard and move your hand across the area which you wish to erase.



> Making Connections

Connecting External Devices and Touch Connection

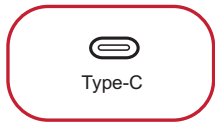

or

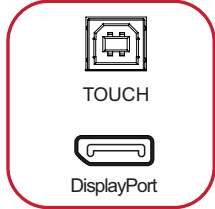

or

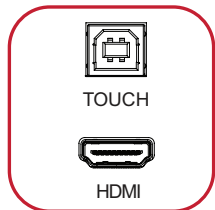

or

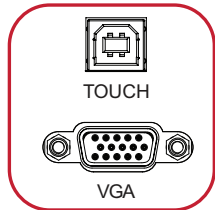

or

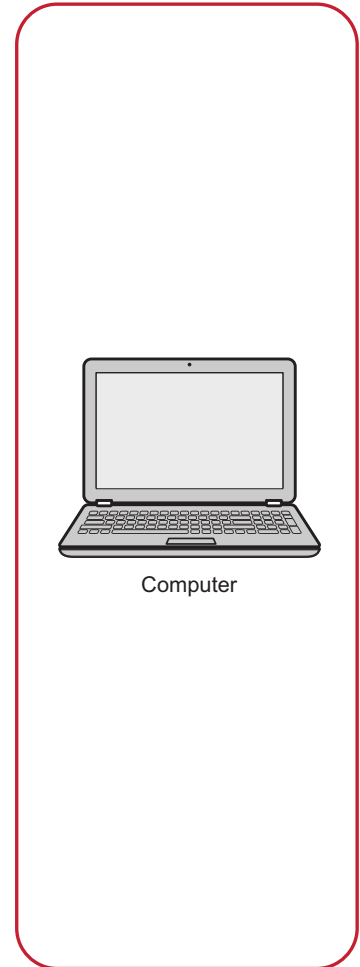
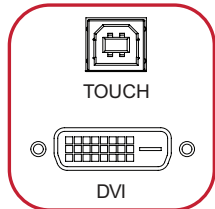

Your external device(s) can be connected in any of the following configurations:

USB Type-C Connection

To connect via USB Type-C:

Connect a USB Type-C cable from your external device to the **Type-C** port on the ViewBoard.

DisplayPort Connection

To connect via DisplayPort:

1. Connect a DisplayPort cable from your external device to the **DisplayPort** port on the ViewBoard.
2. Connect a USB cable to the external device from the **TOUCH** port of the ViewBoard.

HDMI Connection

To connect via HDMI:

1. Connect an HDMI cable from your external device to the **HDMI** port on the ViewBoard.
2. Connect a USB cable to the external device from the **TOUCH** port of the ViewBoard.

VGA Connection

To connect via VGA:

1. Connect a VGA cable from your external device to the **VGA** port on the ViewBoard.
2. Connect a USB cable to the external device from the **TOUCH** port of the ViewBoard.

DVI Connection

To connect via DVI:

1. Connect a DVI cable from your external device to the **DVI** port on the ViewBoard.
2. Connect a USB cable to the external device from the **TOUCH** port of the ViewBoard.

RS-232 Connection

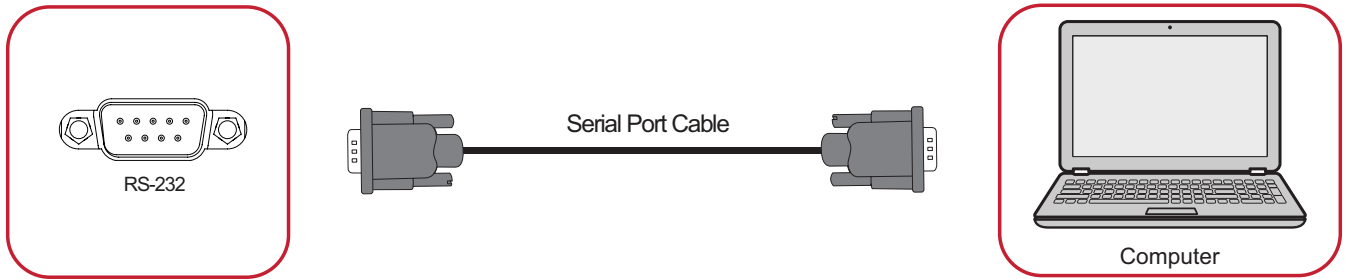

When you use a RS-232 serial port cable to connect your display to an external computer certain functions can be controlled remotely by the PC, including Power On/Off, Volume adjustment, Input select, Brightness, and more.

USB and Networking Connections

Just like any PC, it is easy to connect various USB devices and other peripherals to your ViewBoard.

USB Peripherals

Plug the USB device cable into the **USB** port.

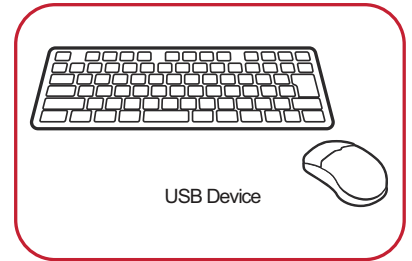
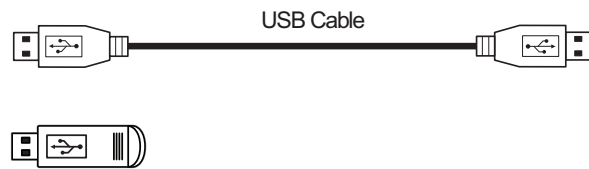
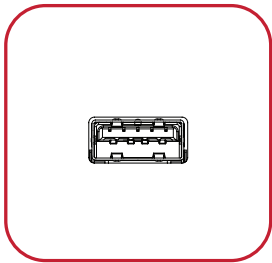

Networking and Modem cables

Plug the network cable into the **LAN** port.

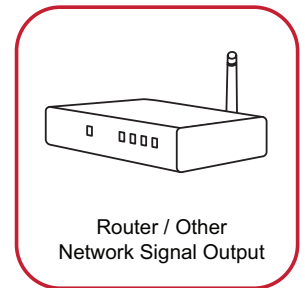
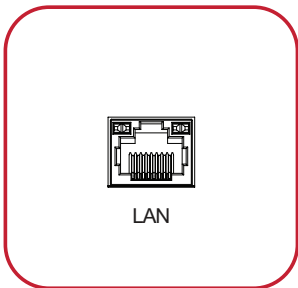

Media Player Connection

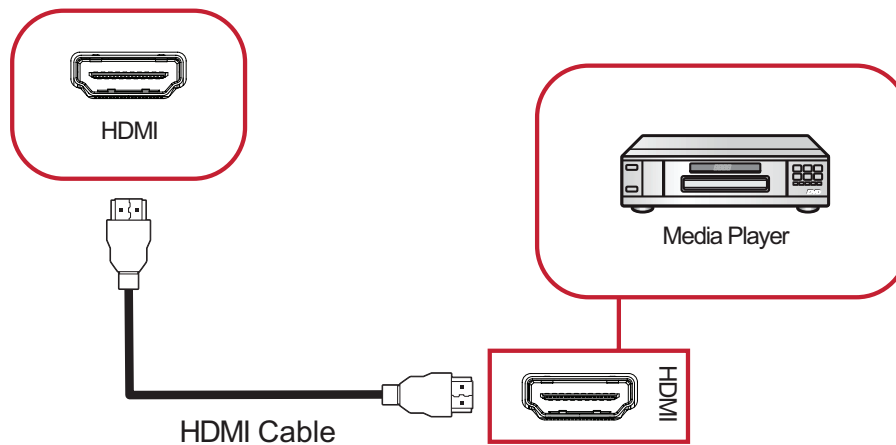

To connect to a media player:

1. Connect the HDMI cable to the **HDMI** ports on your ViewBoard and peripheral device.
2. Plug in the power cord of your ViewBoard, and turn on the power supply switch.
3. Press the **Power** button on the right-hand side of the ViewBoard to turn the screen on.
4. Press the **INPUT** button on the remote control and switch to the “HDMI” input source.

SPDIF Connection

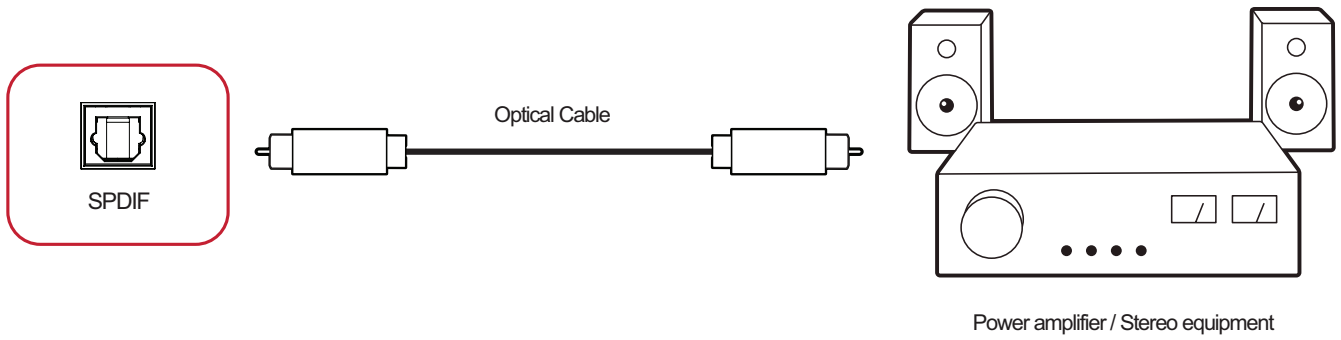

To connect to an external sound system:

1. Connect an optical cable from the **SPDIF** port to your sound system's optical connector.
2. Plug in the power cord of your ViewBoard, and turn on the power supply switch.
3. Press the **Power** button on the right-hand side of the ViewBoard to turn the screen on.



> Using Your ViewBoard

Powering On/Off your ViewBoard

1. Ensure the power cord is connected, plugged into a power outlet, and the power switch is in the “On” position.

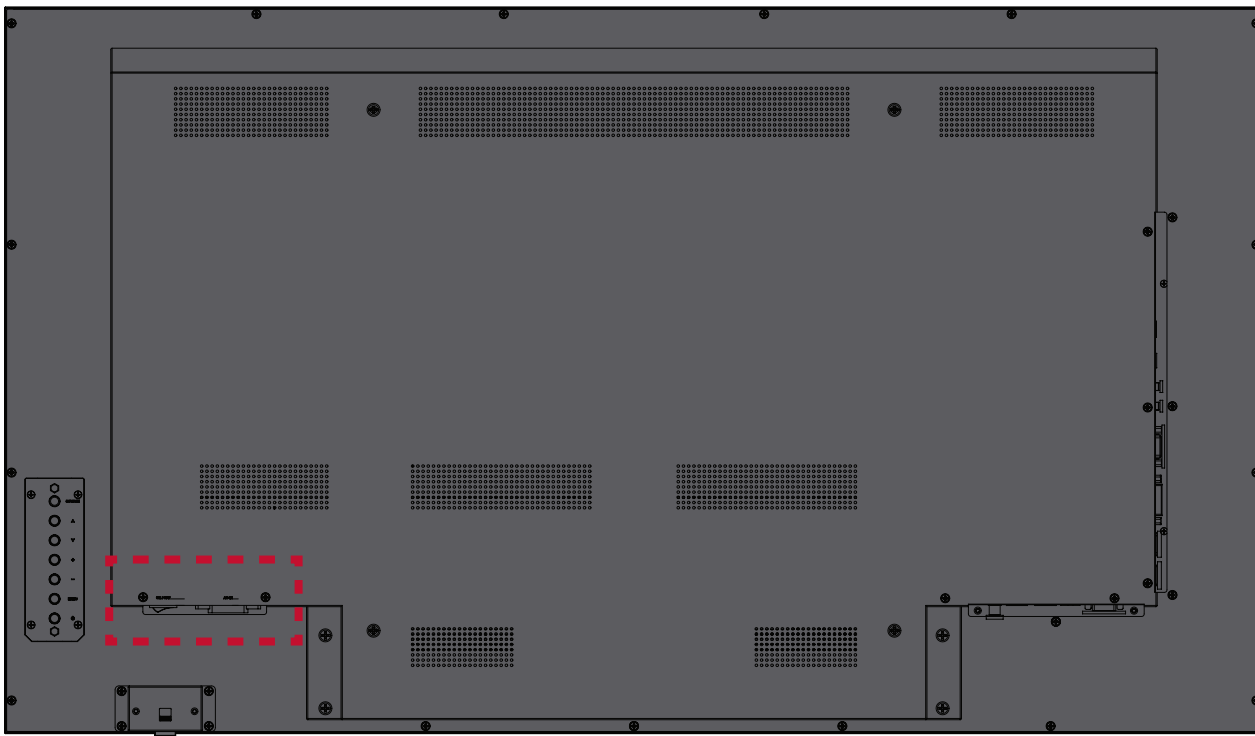
NOTE: The AC IN socket and Power Switch are located at the rear of the device.



2. Press the  Power button to turn on the ViewBoard.
3. To turn the ViewBoard off, press and hold the  Power button.

Initial Launch Setup

When you first turn on your ViewBoard, an initial setup wizard will launch.

1. Select your Language:

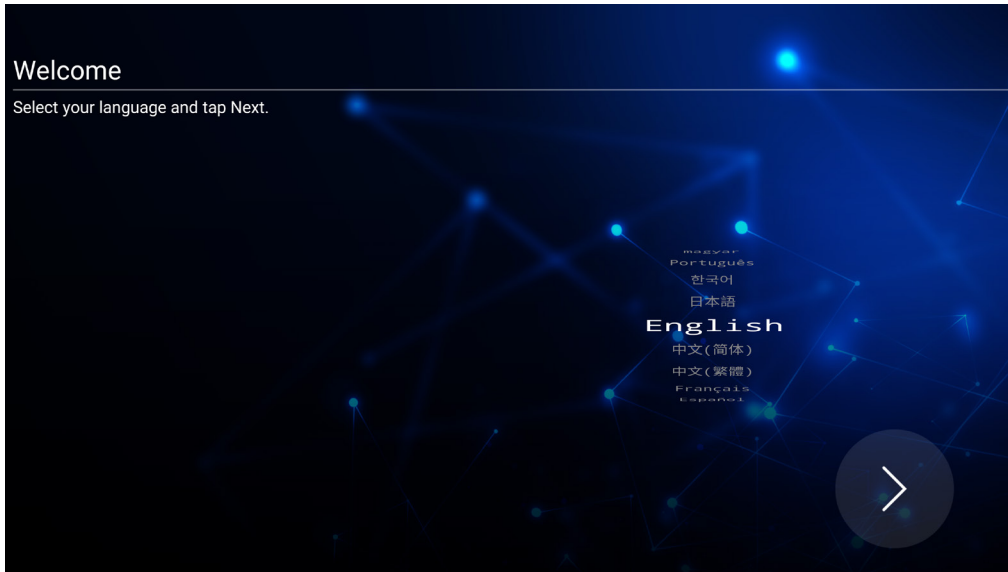

2. Setup and verify your LAN connection:

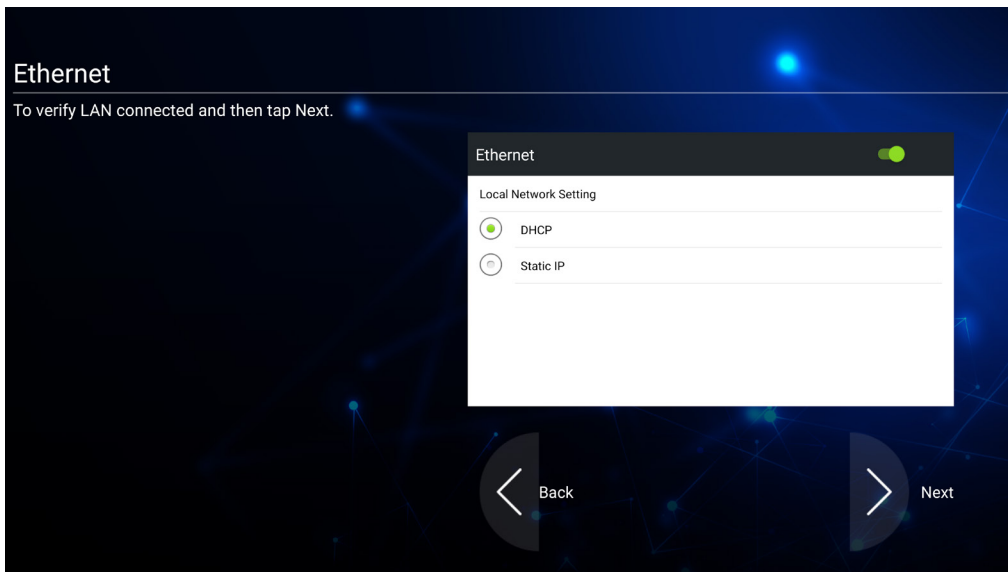

3. Select your Time Zone to set the Date and Time:

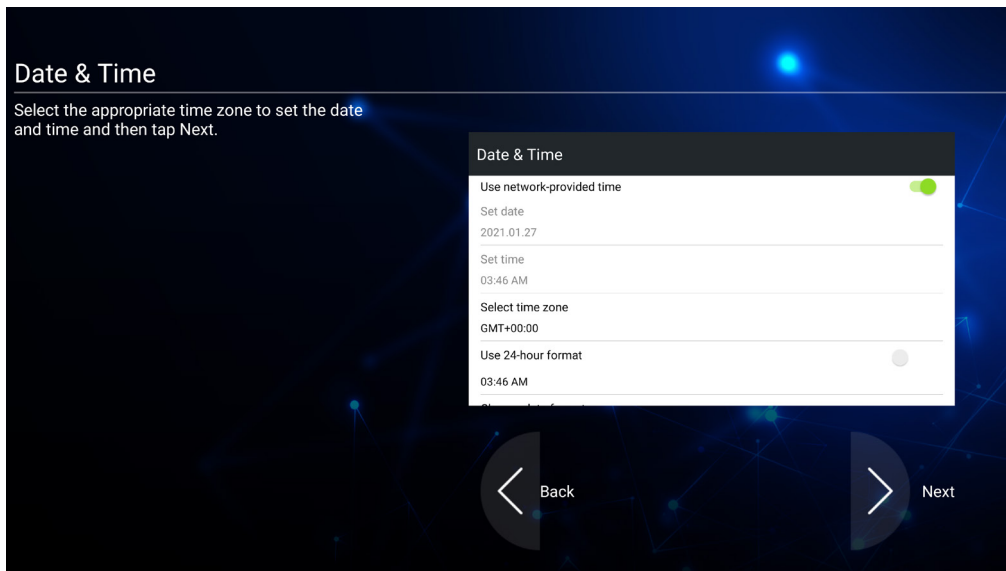

4. Select your preferred System Mode:

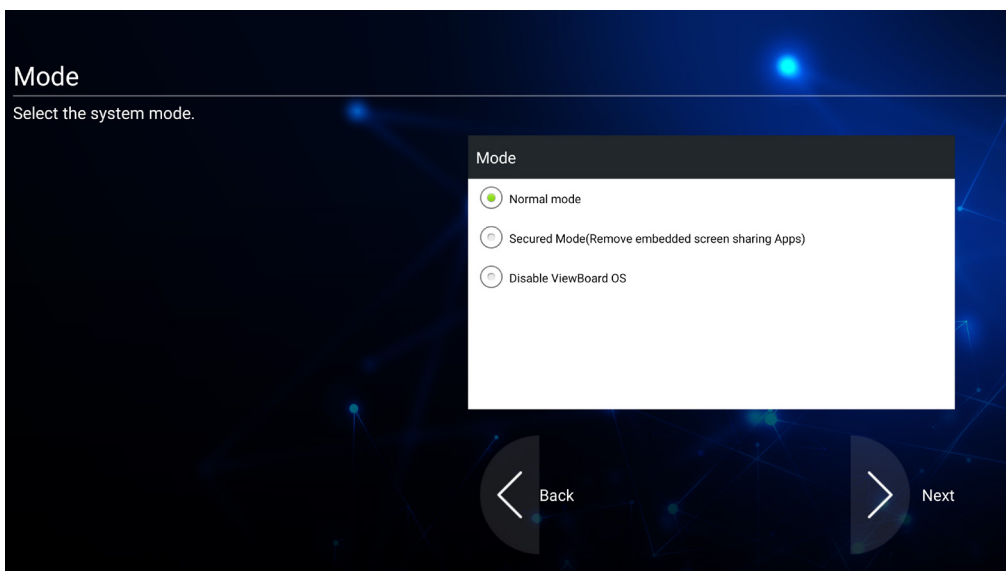

5. Select your Power Saving plan:

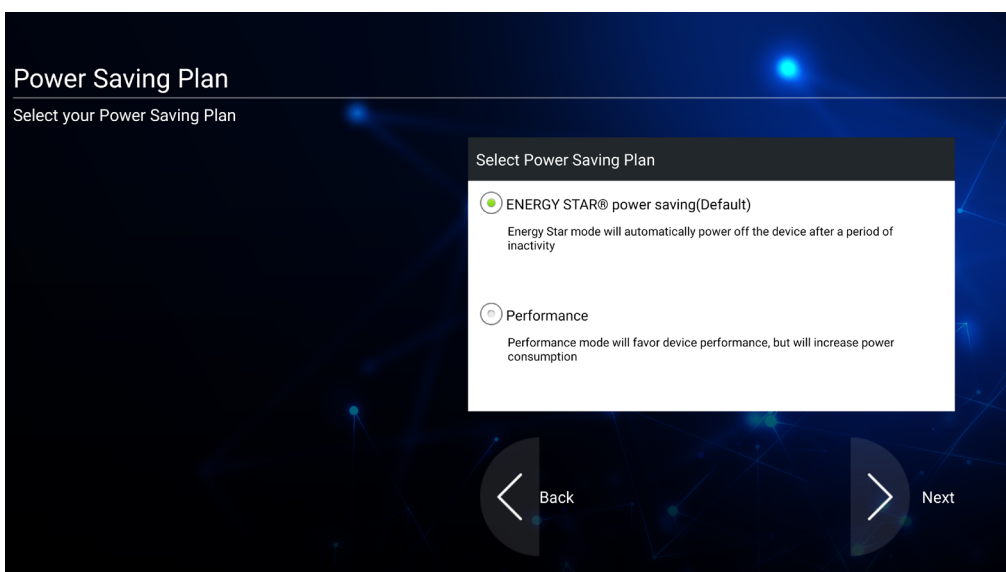

6. Accept or Decline the Privacy and Copyright Protection Terms.

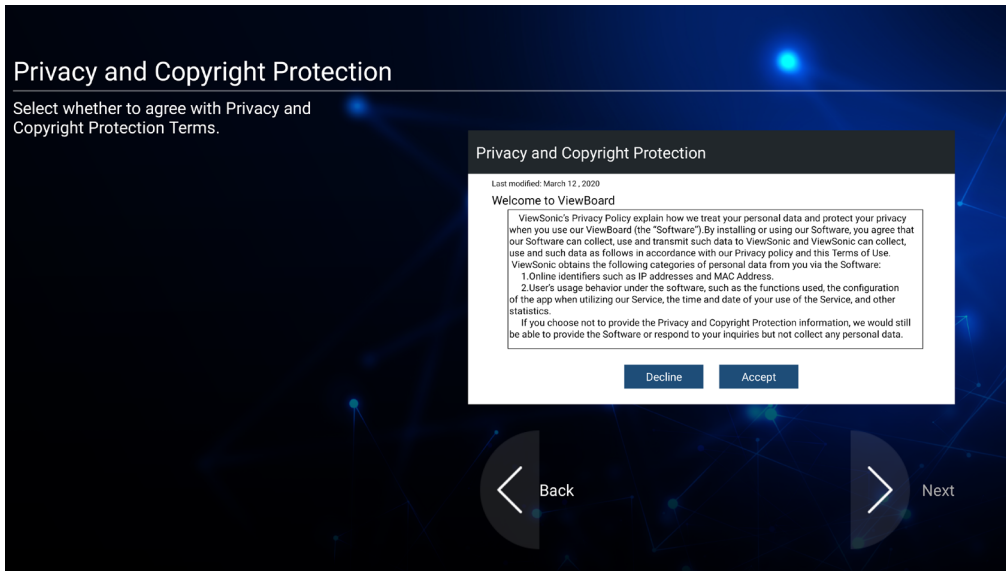

vLauncher - Customizable Welcome Screen

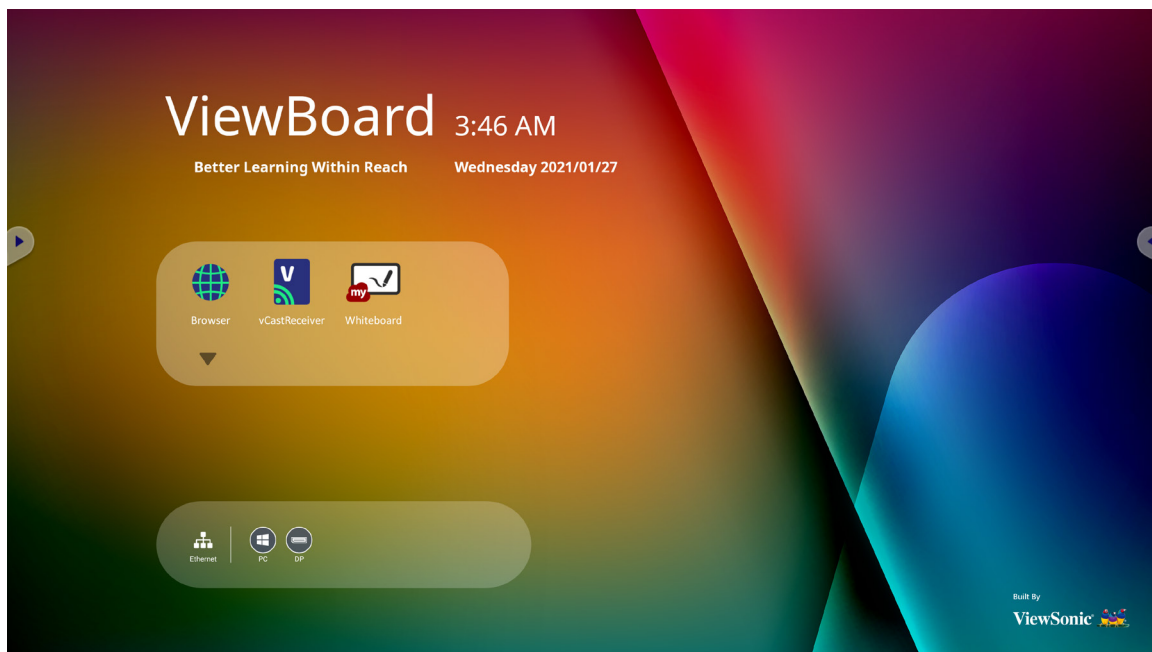

vLauncher Message

Both the vLauncher **Title** and **Subtitle** can be customized by tapping on them.



Additionally, a password can be set by tapping on **Set Password**.

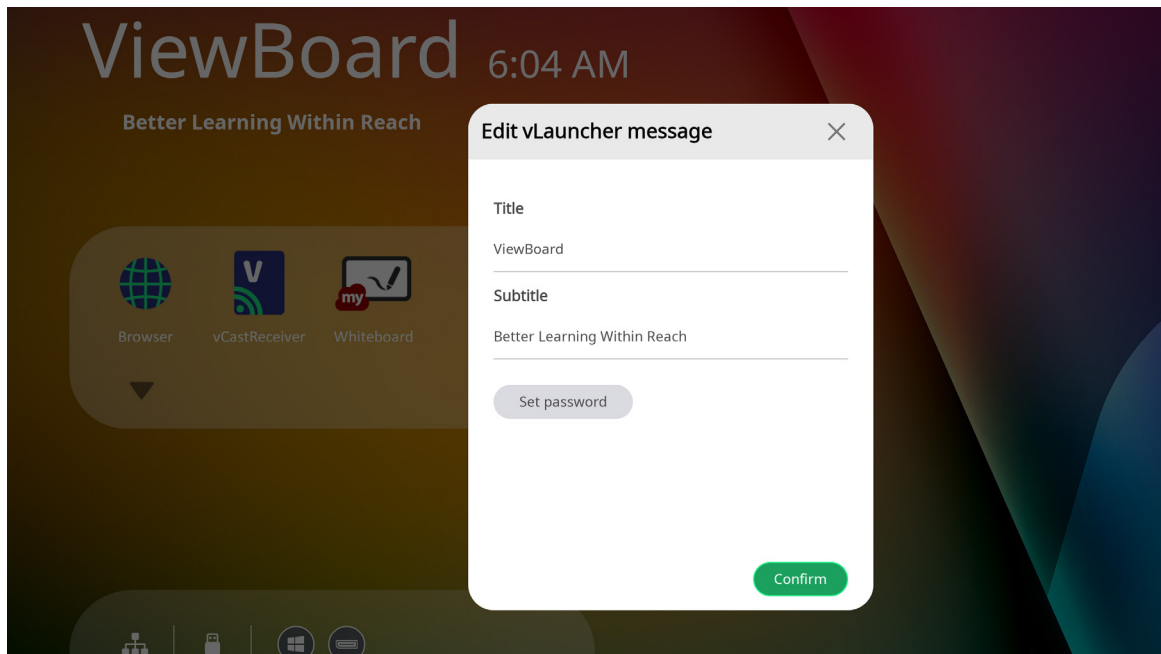

Applications

Installed applications can all be found on the welcome screen. To view all applications tap on the **Down Arrow**.

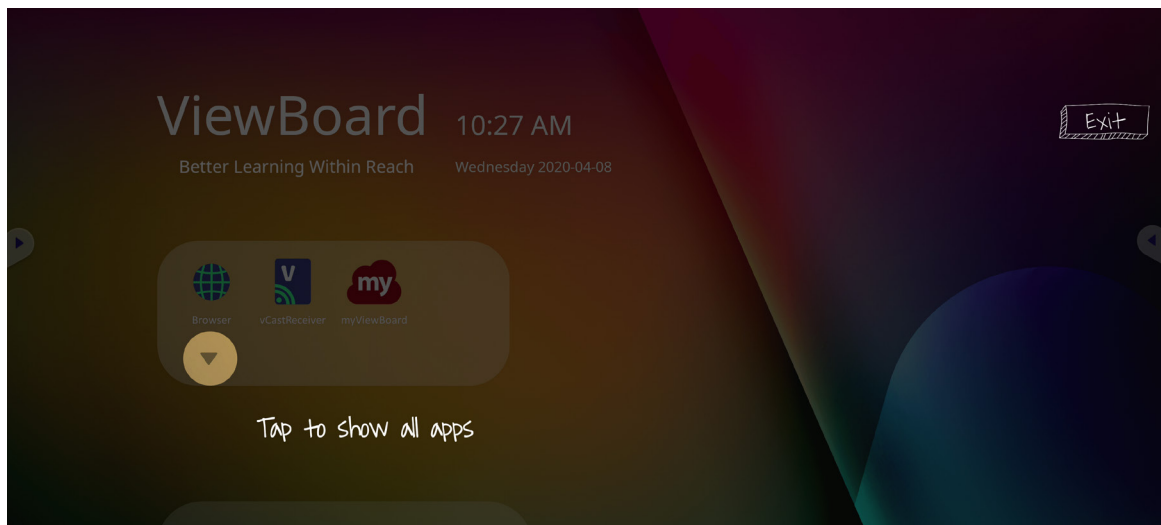

To hide the application drawer tap the **Up Arrow**.

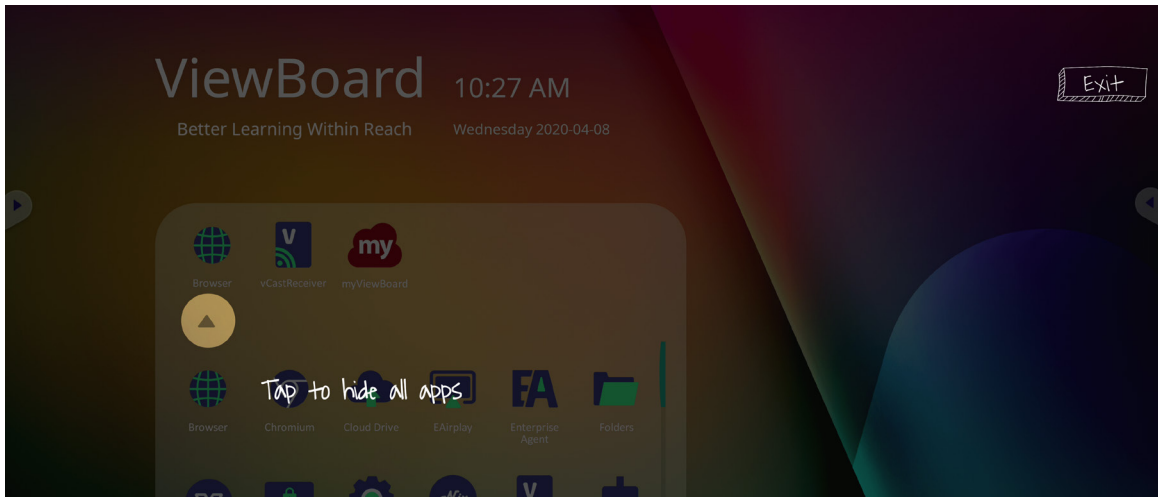



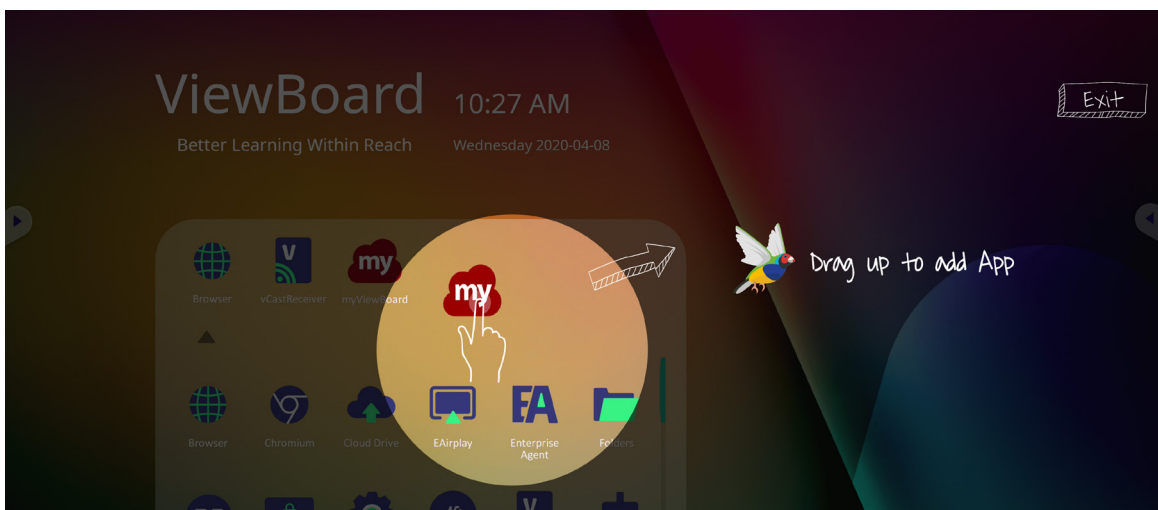



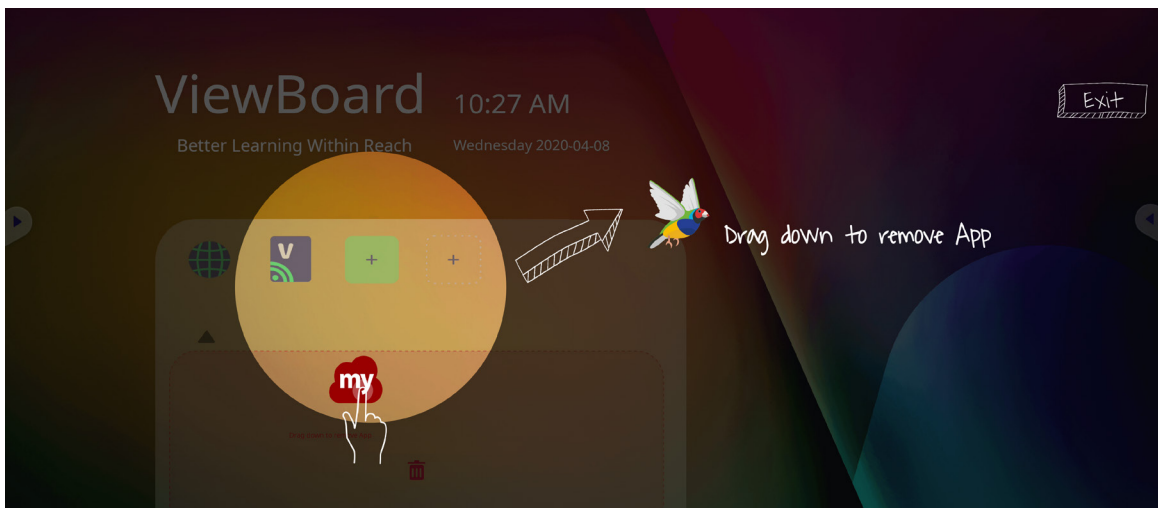







To add a shortcut to an application, tap, hold, and drag up the icon.







To remove an application shortcut, tap, hold, and drag the icon down.

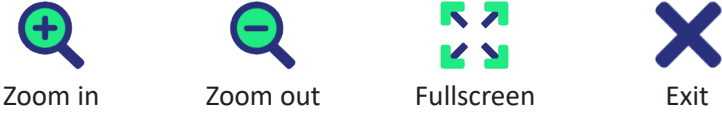

Icon	Description
 Back	Return to the previous operation screen. NOTE: Only for the Embedded Player source.
 Home	Return to the Home Screen of the Embedded Player.
 Recent	Display all embedded applications that are currently being used.
 App	View all installed applications.
 Whiteboard	Launch the Whiteboard software.
 Recorder	Record, view, and save the on-screen content.

Icon	Description
	<p>Access the pen, highlighter, clear, and save options.</p> <div style="display: flex; justify-content: space-around; align-items: center;"> <div style="text-align: center;"> Pen</div> <div style="text-align: center;"> Highlighter</div> <div style="text-align: center;"> Eraser</div> <div style="text-align: center;"> Undo</div> </div> <div style="display: flex; justify-content: space-around; align-items: center; margin-top: 10px;"> <div style="text-align: center;"> Redo</div> <div style="text-align: center;"> Clean</div> <div style="text-align: center;"> Save</div> <div style="text-align: center;"> Exit</div> </div>
 Draw	<p><u>Pen</u></p> <p>Annotate the overlay of any input source with black, white, yellow, orange, red, pink, green, or blue ink.</p> <p>NOTE: The default pen setting supports up to 10-point writing.</p>
	<p><u>Highlighter</u></p> <p>Mark and highlight with yellow, grey, gold, orange, red, pink, green or blue ink.</p> <p>NOTE: The default highlighter setting supports up to 10-point marking.</p>
	<p><u>Eraser</u></p> <p>Selectively remove the digital ink on the screen.</p>
	<p><u>Undo</u></p> <p>Undo the previous action.</p>
	<p><u>Redo</u></p> <p>Redo the previous action.</p>
	<p><u>Clean</u></p> <p>Clears all the digital ink on the screen.</p>
	<p><u>Save</u></p> <p>Save the screen image and any annotations.</p>
	<p><u>Exit</u></p> <p>Close the drawing tool.</p>

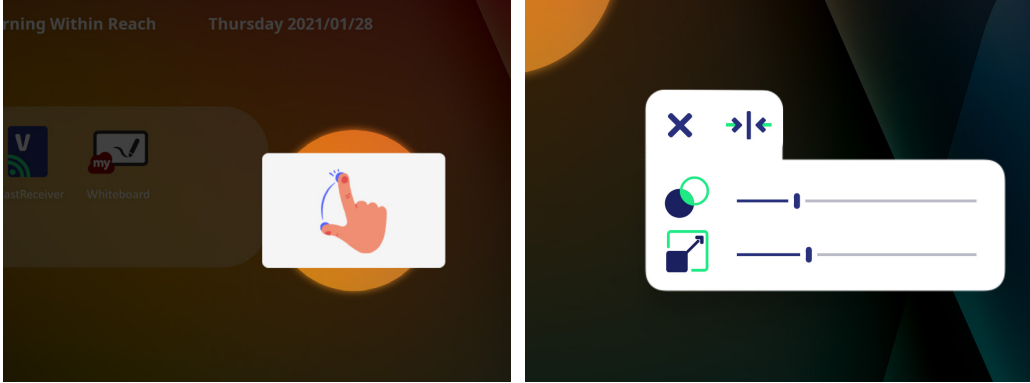
Icon	Description
	<p>View more applications within the ViewBoard tool bar.</p>  <p>Screen Freeze Spotlight Stopwatch Timer Hide/Unhide Screen Capture</p>
	<p><u>Screen Freeze</u> </p> <p>Convert the currently displayed content into a still image; then you can zoom in, zoom out, go back to full screen, and exit.</p>  <p>Zoom in Zoom out Fullscreen Exit</p>
	<p><u>Spotlight</u> </p> <p>Highlight the focus content zone. Tap the Setting icon to adjust the spotlight size and alpha blending effect.</p> 

Icon

Description

Stopwatch

Tapping **Start** will initiate the stopwatch.

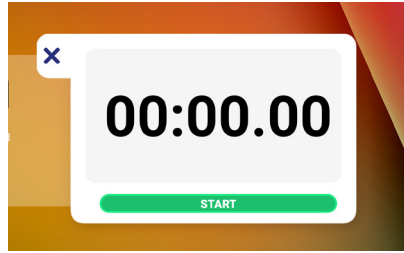

At any time, the stopwatch can be paused, resumed, split, or reset.

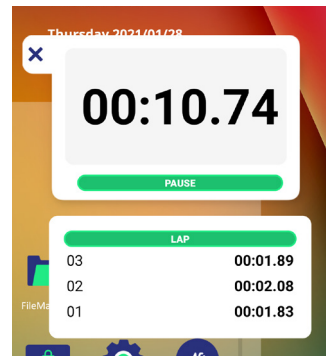
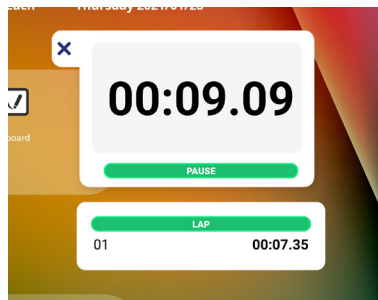

More

Timer

Access the countdown timer with an optional alarm setting. Touch and swipe to adjust the numeric values, then click **Start**.

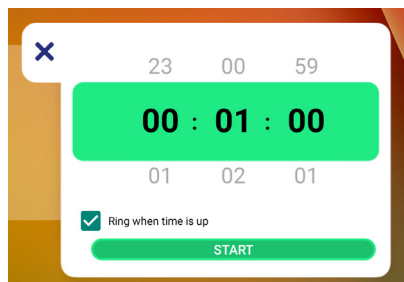

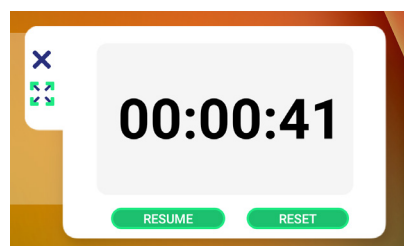
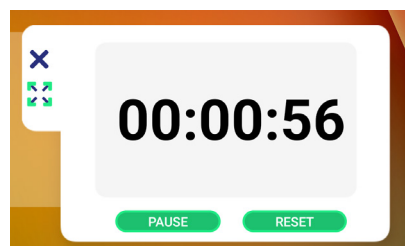

At any time, the countdown timer can be paused, resumed, or reset.



Hide/Unhide

Hide or unhide the Tool bar trigger icons.

Icon	Description
 More	<u>Screen Capture</u>  Take a screenshot of the current screen.
 Settings	Access the General Settings.

On-Screen Display (OSD) Menu

Access General Settings, Input Settings, and Widgets through the OSD Menu.

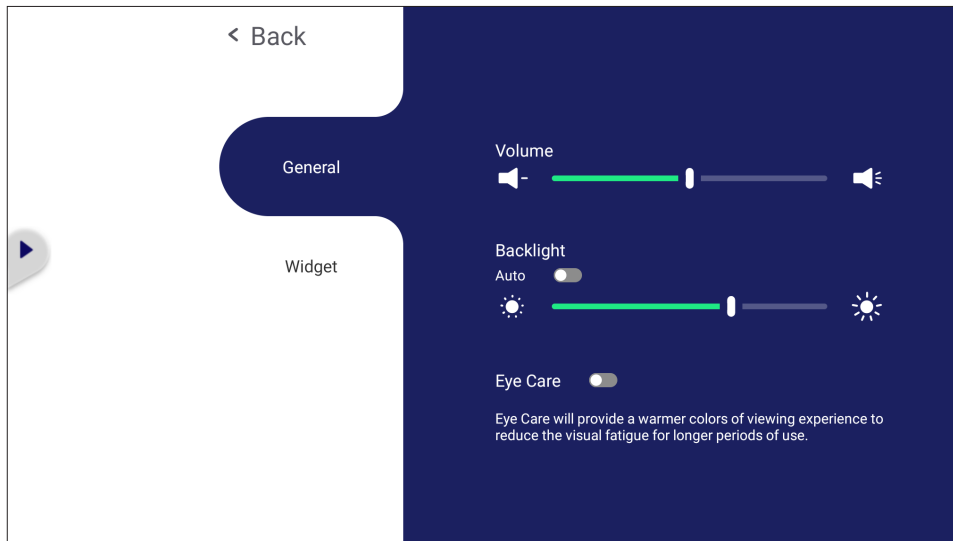

ViewBoard has two options for opening the OSD Menu:

Option 1

Long press anywhere in the vLauncher background.

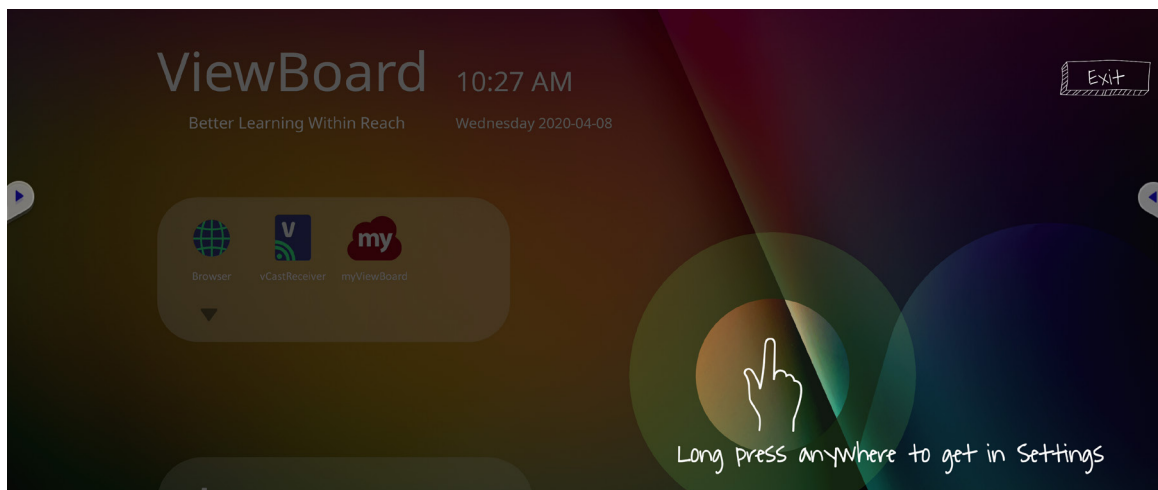

Option 2

Press the **INPUT** button on the remote control.

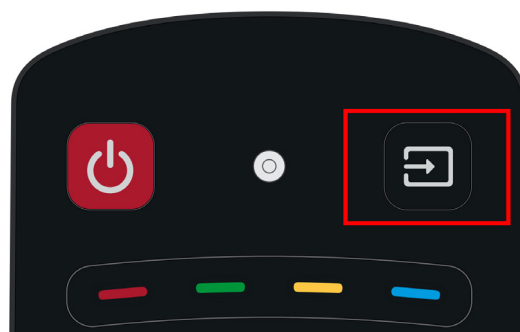

General Settings

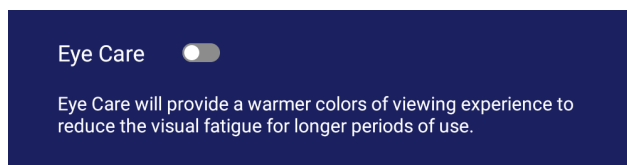
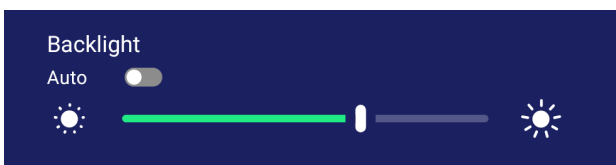



To adjust the Backlight and enable/disable Eye Care:

1. Press **INPUT** on the remote control or long press the vLauncher background and touch **General** on-screen (if needed) to display the **General Settings** menu.
2. Drag the brightness slider directly to adjust the backlight value, and/or touch On or Off to enable/disable the function.
3. Press  on the remote control, or touch a blank area outside of the menu to exit.





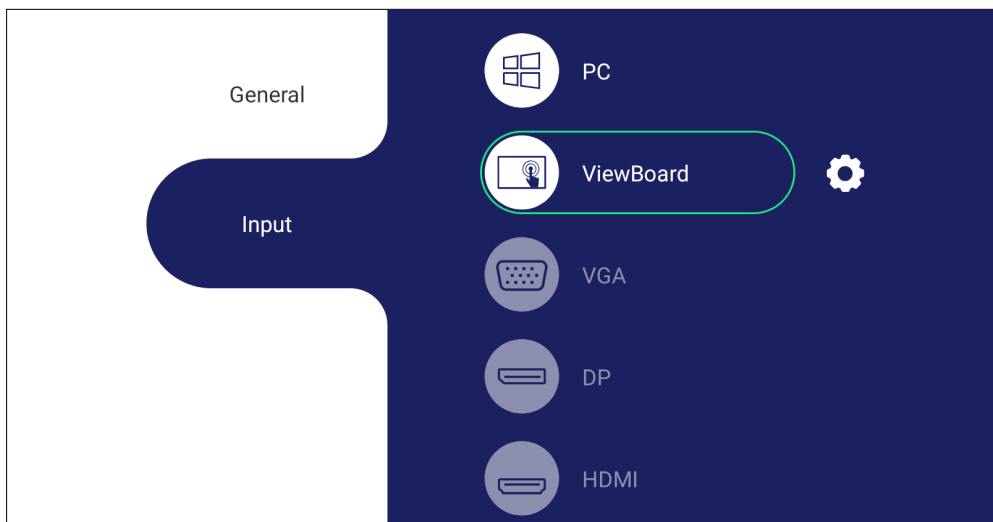

To adjust the Volume:

1. Press **INPUT** on the remote control or long press the vLauncher background and touch **General** on-screen (if needed) to display the **General Settings** menu.
2. Drag the volume slider directly to adjust the value.
3. Press  on the remote control to enable or disable the mute function.
4. Press  on the remote control, or touch a blank area outside of the menu to exit.

Input Settings



To select an Input Source:

1. Press **INPUT** on the remote control, press the setting button  on the front panel, or press the  setting icon from the toolbar to display the **Input Settings** menu.
2. Press **▼/▲/◀/▶** to select the input source you want.
NOTE: PC source will only display when the slot-in computer is connected.
3. Press  on the remote control, or touch the input source.
4. Press  on the remote control, or touch a blank area outside of the menu to exit.

NOTE: To adjust the settings of an input source, touch the setting icon next to the highlighted input source.

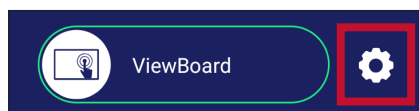

Widget

NOTE: Only available for the ViewBoard Player source.

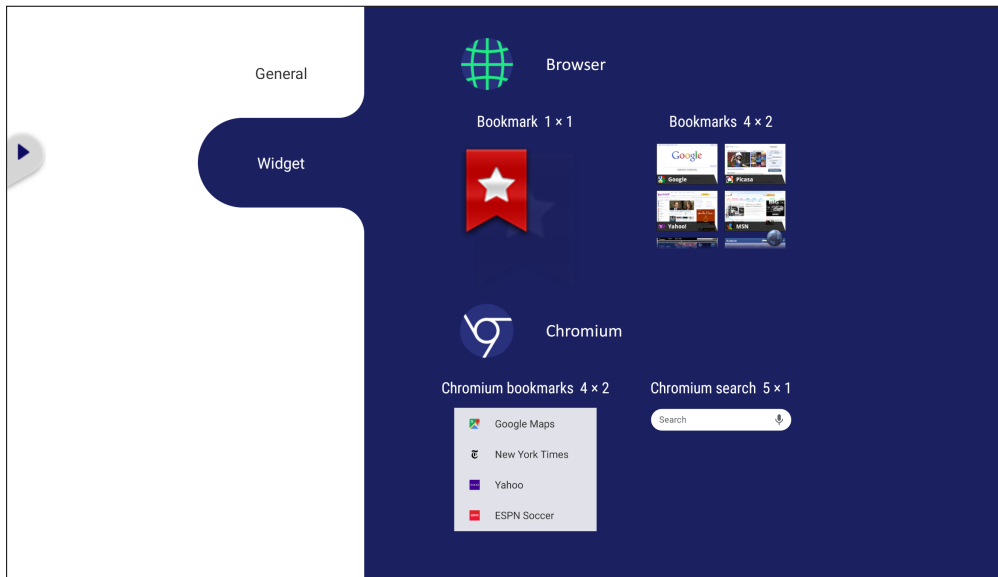

To add a widget to the vLauncher welcome screen:

1. Long press the vLancher background via touch to launch the OSD Menu.



2. Select **Widget**.

3. Touch and hold the desired widget.

4. Drag the widget onto the vLauncher background.

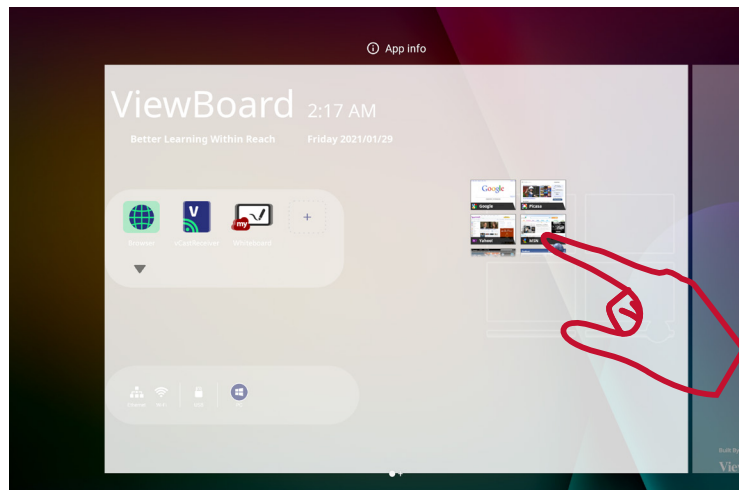

Settings - HDMI & VGA Input Source

Press **MENU** on the remote control or select the setting icon next to the input source in **Input Settings** to launch the **Settings** menu. Settings include: **Audio**, **Screen**, **Display**, and **Adjust**.

Audio Settings

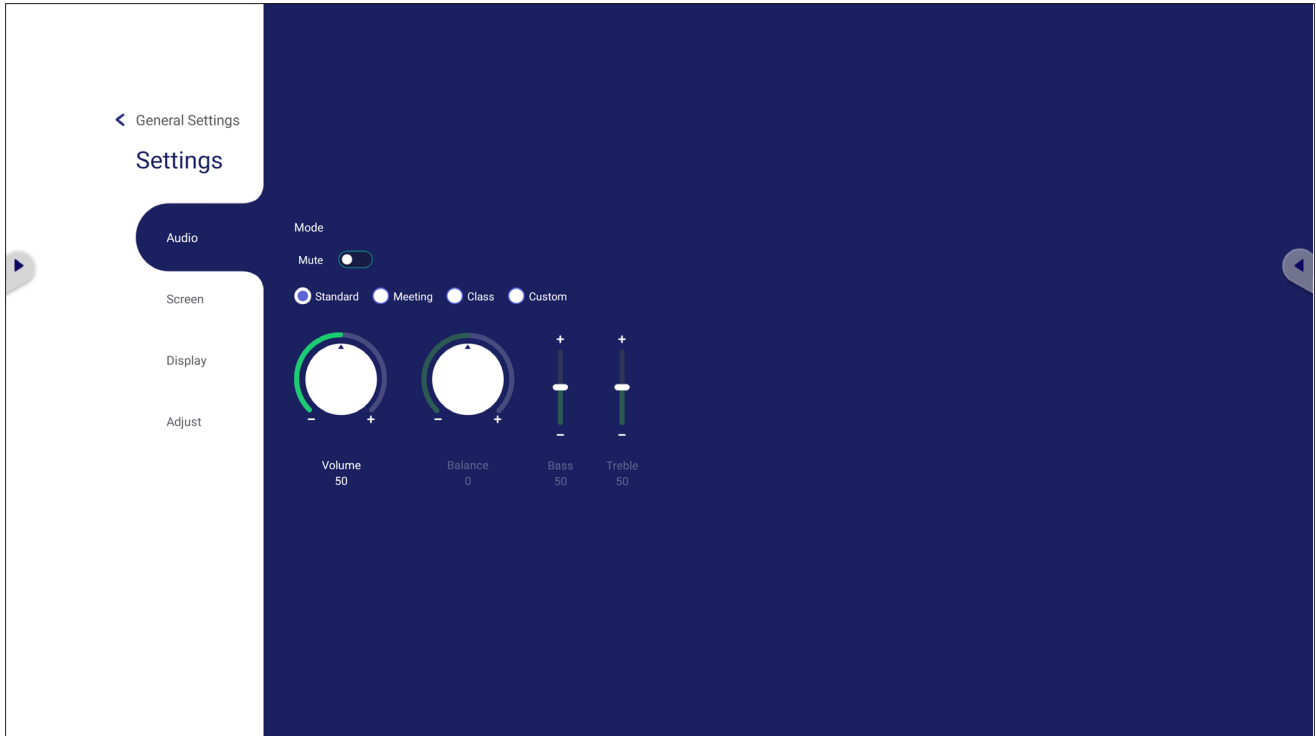

1. Press ▼ on the remote control and select the **Audio** menu.
2. Press ▼/▲/◀/▶ on the remote control or directly touch the option to select it.
3. Adjust the Volume, Bass, Treble, and Balance directly by touching and adjusting each value, or with the remote control by pressing (OK) to adjust the option.
4. Touch the Mute slider directly to enable/disable mute, or press 🔊x on the remote control.
5. Press (↩) on the remote control, or touch a blank area outside of the menu to exit.

Screen Settings

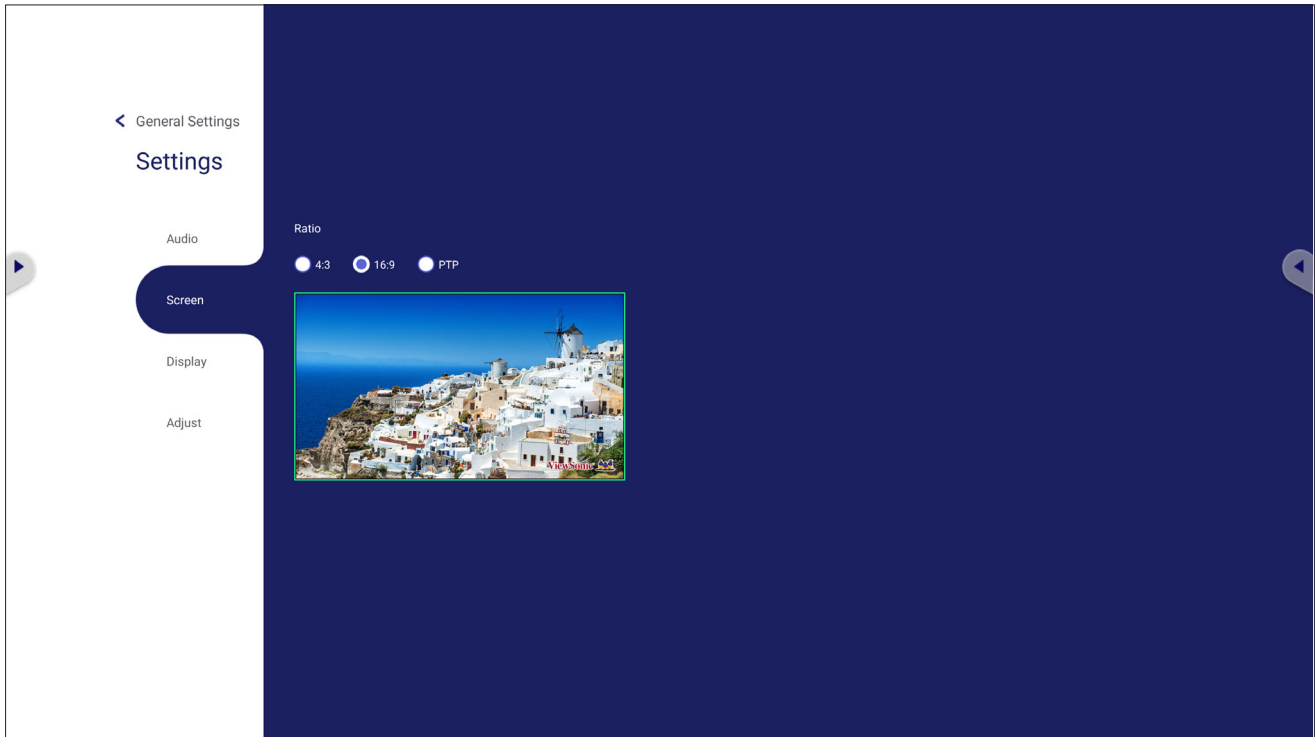

1. Press ▼ on the remote control and select the **Screen** menu.
2. Press ▼/▲/◀/▶ on the remote control or directly touch the option to select it.
3. Adjust your preference by touching each value directly, or with the remote control by pressing (OK).
4. Press (Back) on the remote control, or touch a blank area outside of the menu to exit.

Display Settings

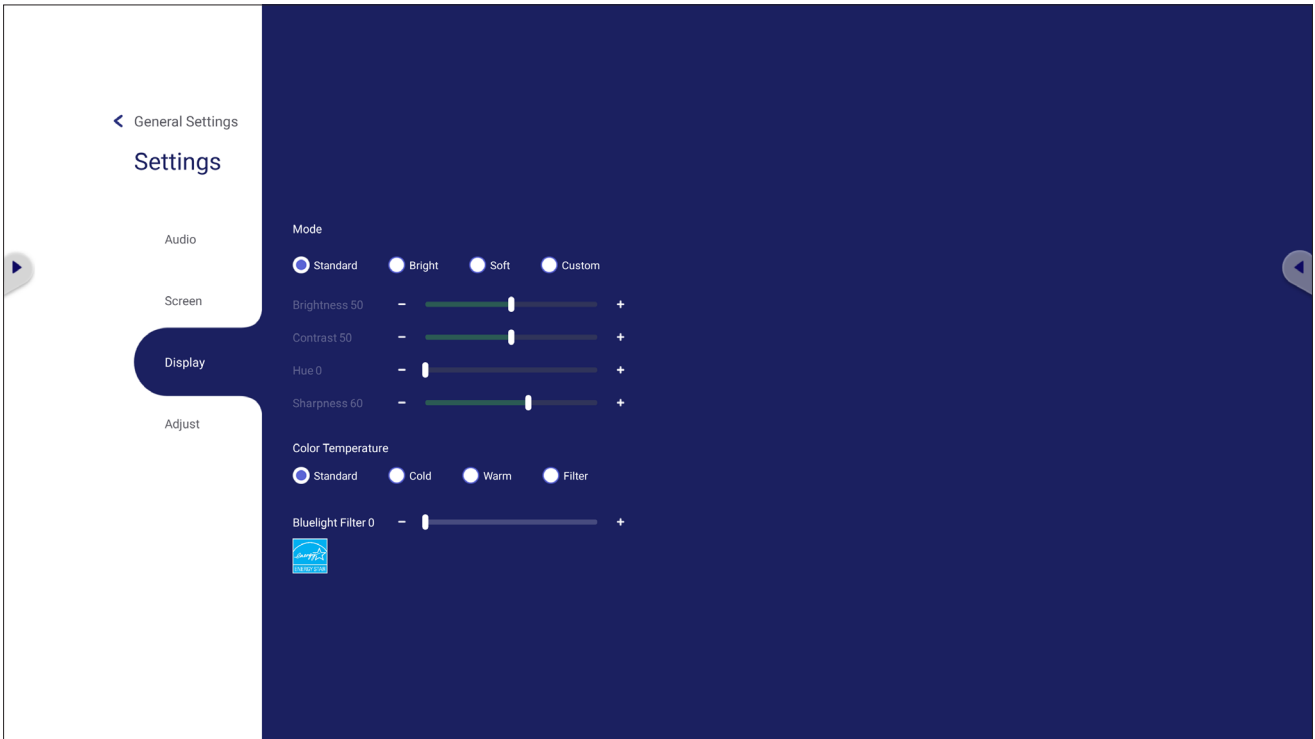

1. Press ▼ on the remote control and select the **Display** menu.
2. Press ▼/▲/◀/▶ on the remote control or directly touch the option to select it.
3. Adjust the Brightness, Contrast, Hue, and Sharpness directly by touching and adjusting each value, or with the remote control by pressing (OK) to adjust the option.
4. Drag the blue light slider directly to adjust the blue light value.



5. Press (Back) on the remote control, or touch a blank area outside of the menu to exit.

Low Blue Light Filter and Eye Health

The Blue Light Filter blocks high-energy blue light for a more comfortable viewing experience.

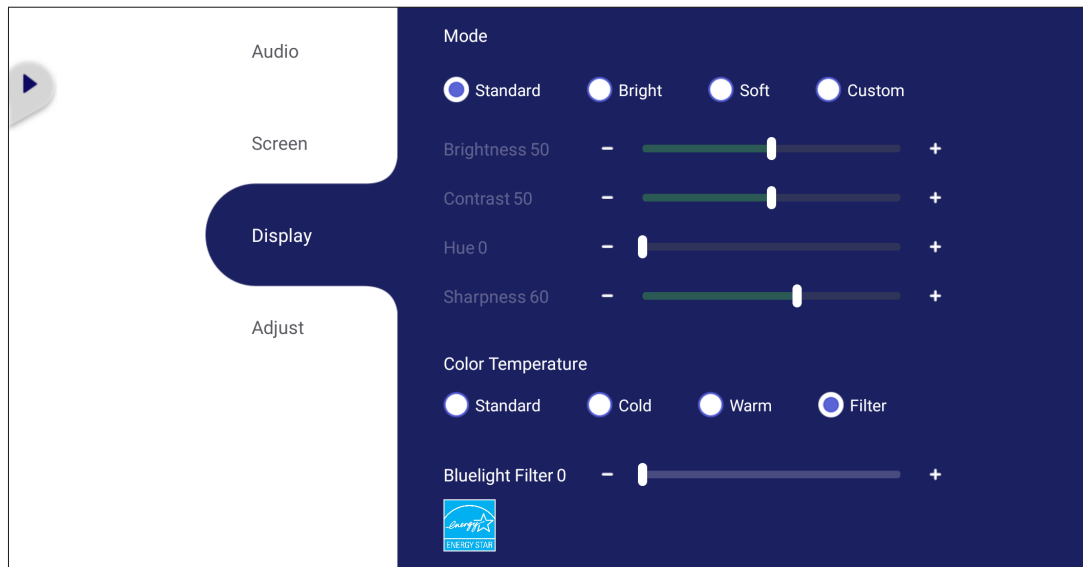

NOTE: To meet TÜV Rheinland low blue light certification, the Display Settings must be:

- Mode: Standard (Brightness and Contrast are 50)
- Color Temperature: Filter
- Blue light Filter: 0

Calculating Breaks

When viewing screens for extended periods, it is recommended to take periodic breaks from viewing. Short breaks of at least 10 minutes are recommended after one (1) hour of continuous viewing.

Taking shorter, more frequent breaks are generally more beneficial than longer, less frequent breaks.

Focus Fatigue (20-20-20 Rule)

To reduce the risk of eye fatigue by constantly looking at the screen, look away from the screen at least every 20 minutes and gaze at a distant object (at least 20 feet away) for at least 20 seconds.

Looking at Distant Objects

While taking breaks, users can further reduce eye strain and dryness by focusing on objects that are further away from them for 10-15 seconds, then gaze at something up close for 10-15 seconds. Repeat this up to 10 times. This exercise reduces the risk of your eyes' focusing ability to "lock up" after prolonged computer work.

Eye and Neck Exercises

Eye Exercises

Eye exercises can help minimize eye strain. Slowly roll your eyes to the left, right, up, and down. Repeat as many times as needed.

Exercises for the eyes

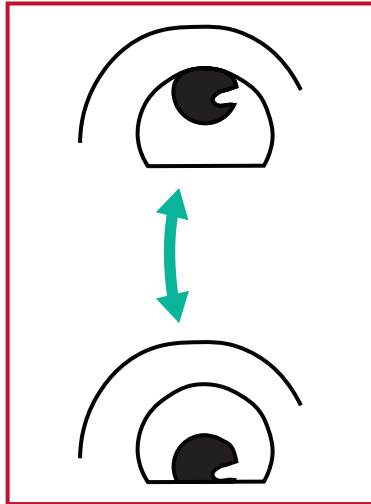

(1) Keep the body and the head upright. Move the eyes up to look at the ceiling, then turn down to look at the floor.

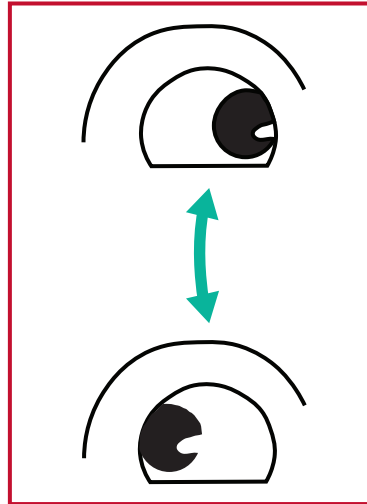

(2) Move the eyes left and right slowly to look at objects on the two sides.

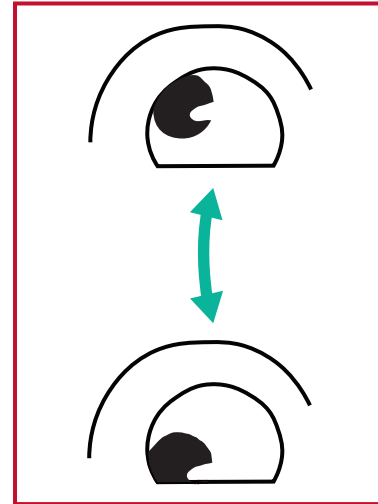

(3) Move the eyes to look at objects at the right upper direction and then right lower direction. Repeat for the left upper and left lower directions.

Neck Exercises

Neck exercises can also help minimize eye strain. Relax your arms and let them hang at your sides, bend forward slightly to stretch the neck, turn your head to the right and to the left. Repeat as many times as needed.

Adjust Settings - (VGA Only)



1. Press ▼ on the remote control and select the **Adjust** menu.
2. Press ▼/▲/◀/▶ on the remote control or directly touch the option to select it.
3. Adjust your preference by touching each value directly, or with the remote control by pressing (OK).
4. Press (Back) on the remote control, or touch a blank area outside of the menu to exit.

Settings - ViewBoard Player

When the ViewBoard is in the ViewBoard Player input source, press  on the remote control or tap the setting icon next to the input source in the On-Screen Display (OSD) Menu's Input Settings to enter the **Settings** menu.

Wireless & Network

Check current network connection status, set up and manage Wi-Fi, Ethernet, Bluetooth, and VPN, and establish a Wireless hotspot.

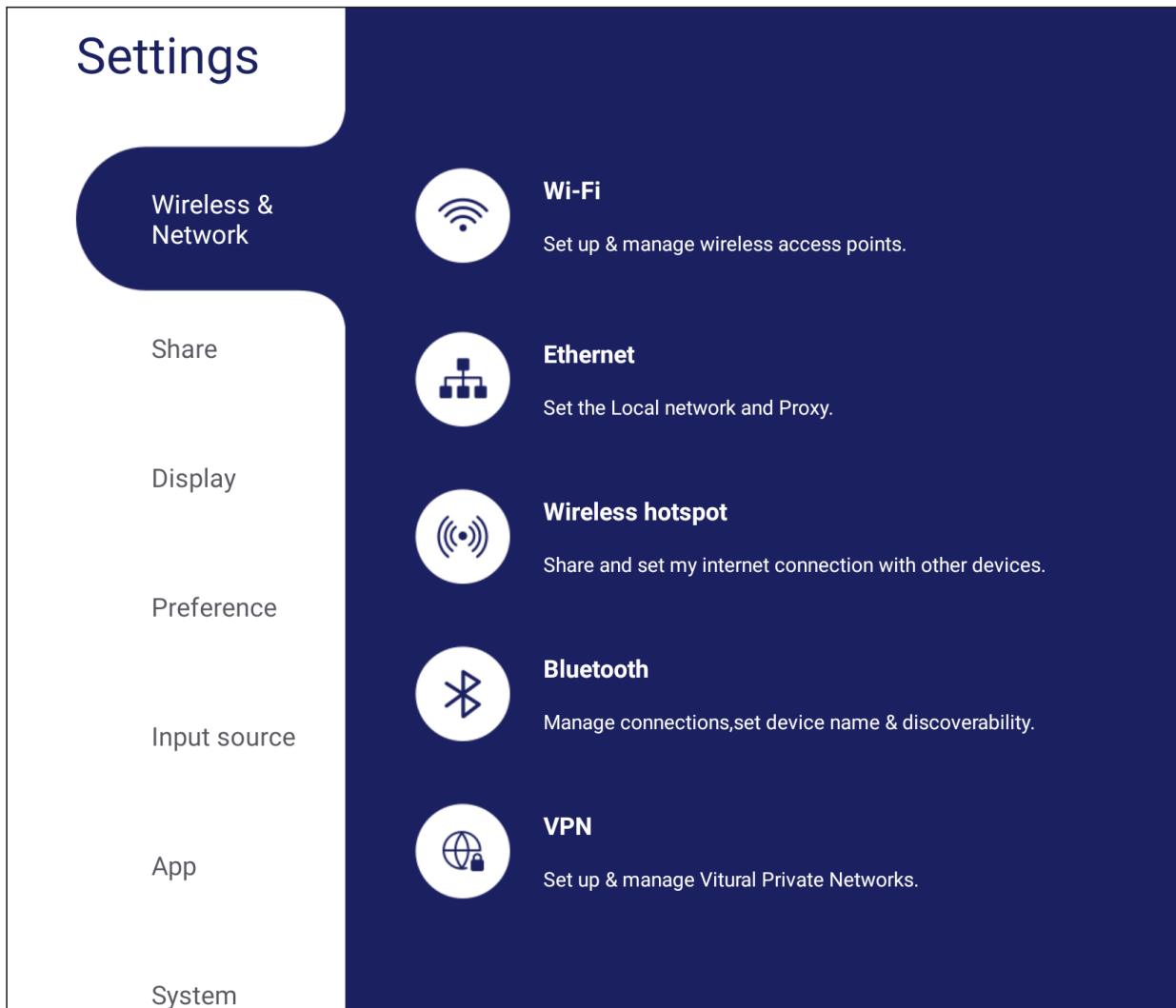

NOTE:

- Wi-Fi, Wireless hotspot and Bluetooth settings will appear when VS050B(optional) has been installed.
- Ethernet will disable automatically when Wi-Fi is enabled. Wi-Fi will disable automatically when Ethernet is enabled.
- Miracast will disable when Wireless hotspot is enabled. Wireless hotspot will disable when Miracast hotspot is enabled.

Wi-Fi

Setup and manage wireless access points.

- Tap the toggle button to turn Wi-Fi **On** or **Off**.

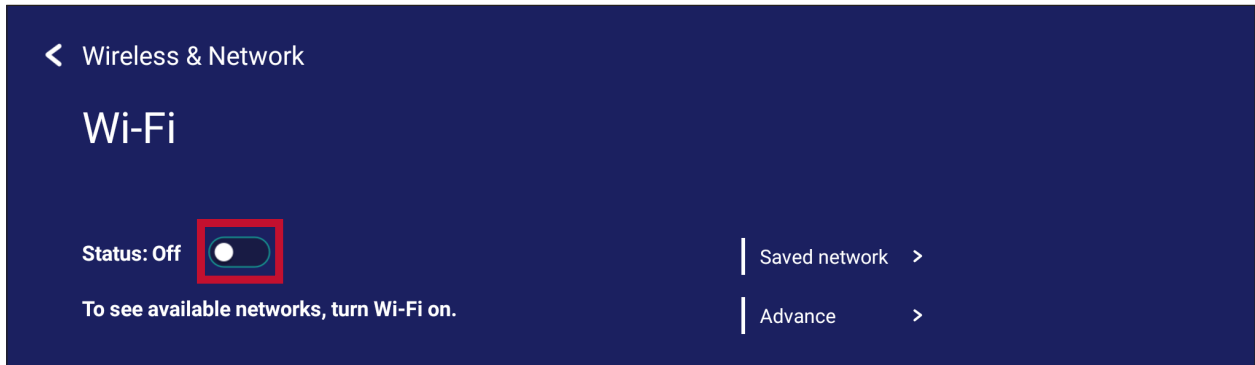

- Once **On**, you can: **Add a Network**, view **Saved Networks**, **Refresh** the network list, or view **Advanced** settings.

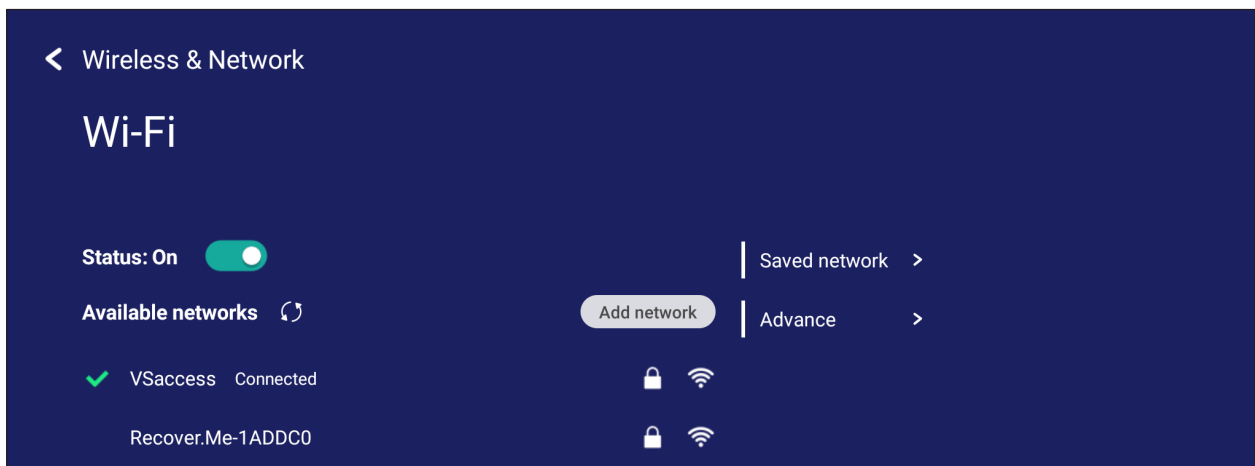

- In **Advanced** settings, you can toggle **Network notifications On** or **Off** and view **Network card info**.

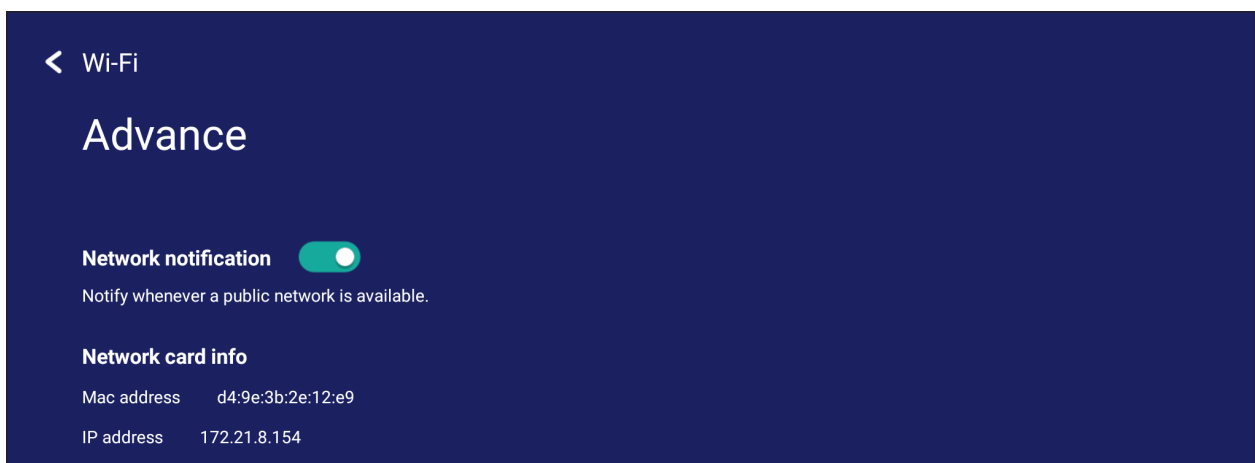

Ethernet

Set the local network and proxy.

- Tap the drop down menu to connect/disconnect the Ethernet.

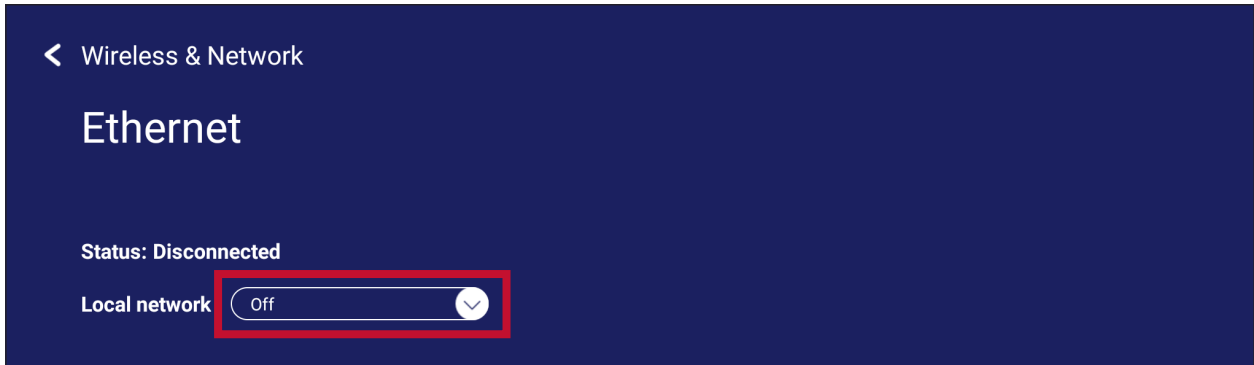

- You can adjust **Local network** and **Proxy** settings as well.

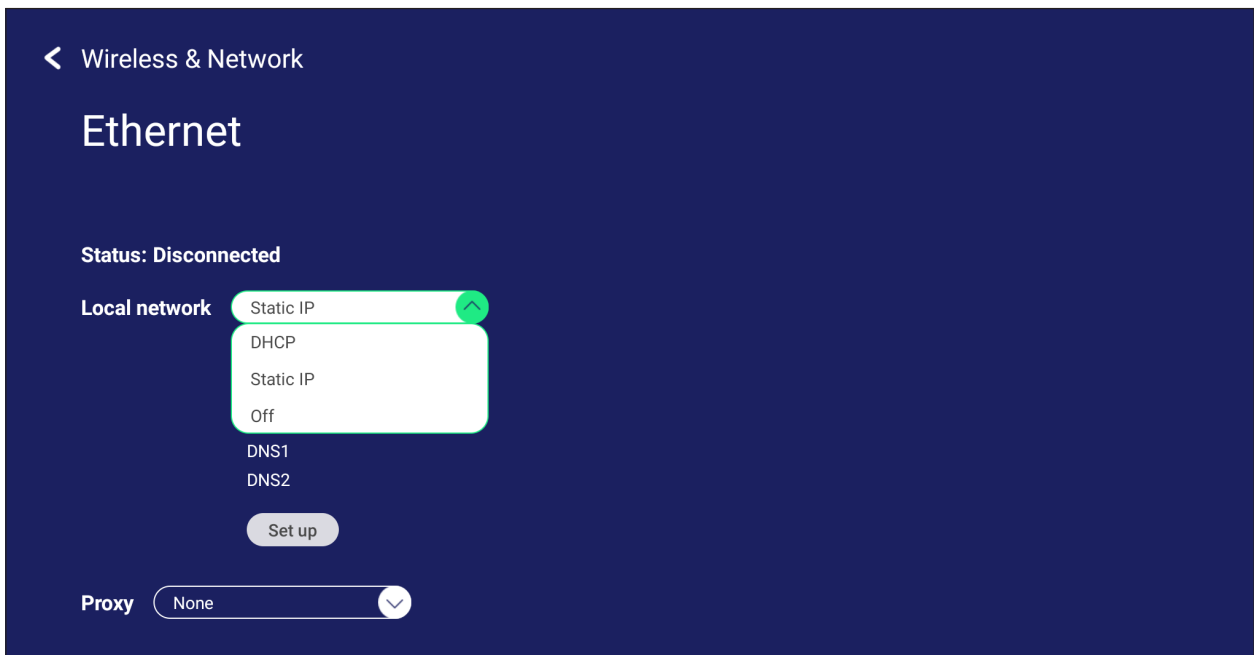

Wireless Hotspot

Set and share my internet connection with other devices.

- Tap the toggle button to turn **Wireless hotspot On** or **Off**.

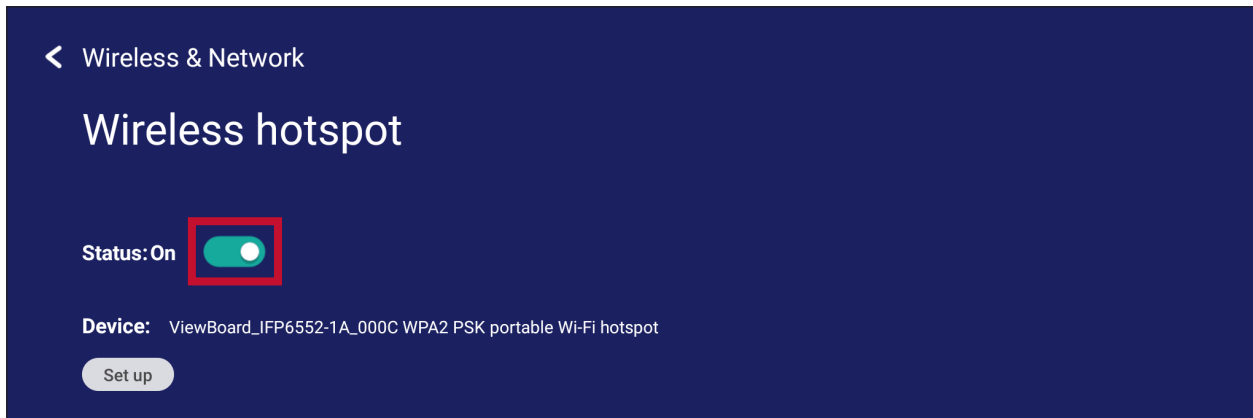

- Tap **Set up** to set the **Network name**, **Security**, and **Password**.

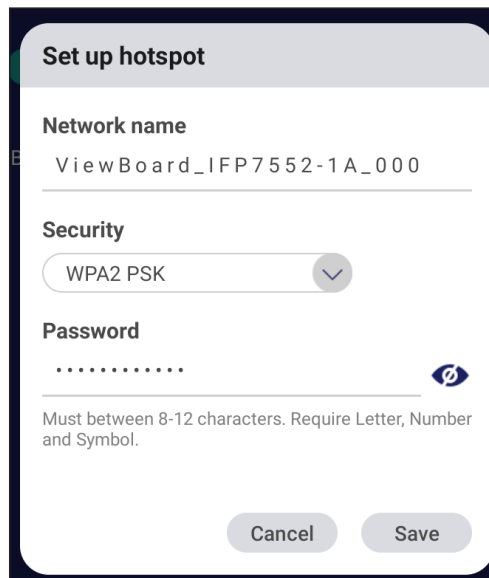

VPN

Setup and manage Virtual Private Networks.

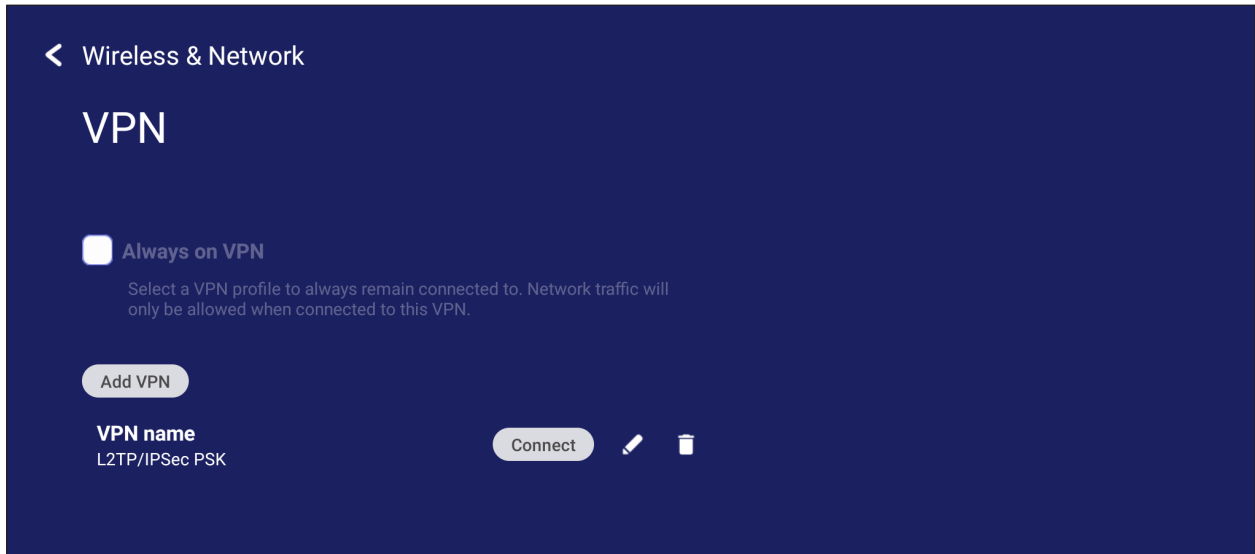

To create a VPN profile:

1. Go to: **Settings > Wireless & Network > VPN** and tap **Add VPN**.

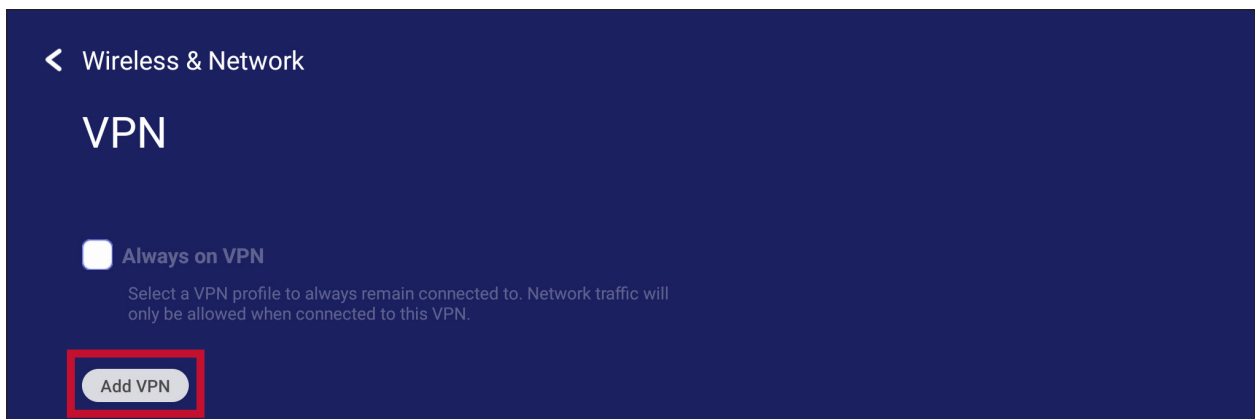

2. Key in the **Name**.

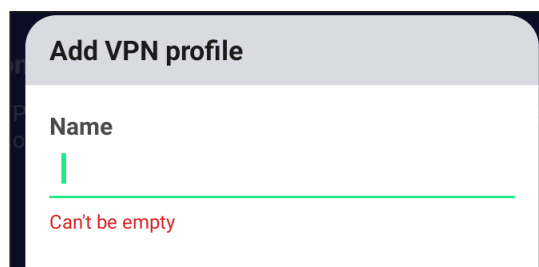

3. Select the VPN Type.

Add VPN profile

Name

Can't be empty

Type

PPTP

PPTP

L2TP/IPSec PSK

L2TP/IPSec RSA

IPSec Xauth PSK

IPSec Xauth RSA

IPSec Hybrid RSA

Advanced options

4. Choose to enable/disable **PPP encryption (MPPE)** and/or show **Advanced options**.

Server address

Can't be empty

PPP encryption(MPPE)

Advanced options

Username

Password

Always-on VPN

This VPN type can't stay connected at all times

Cancel Save

Share

SAMBA

The SAMBA Service provides file sharing via LAN. When the SAMBA Service is enabled, the user can explore the ViewBoard file system with a PC or mobile equipment.

1. To access, go to: **Settings > Share > SAMBA.**

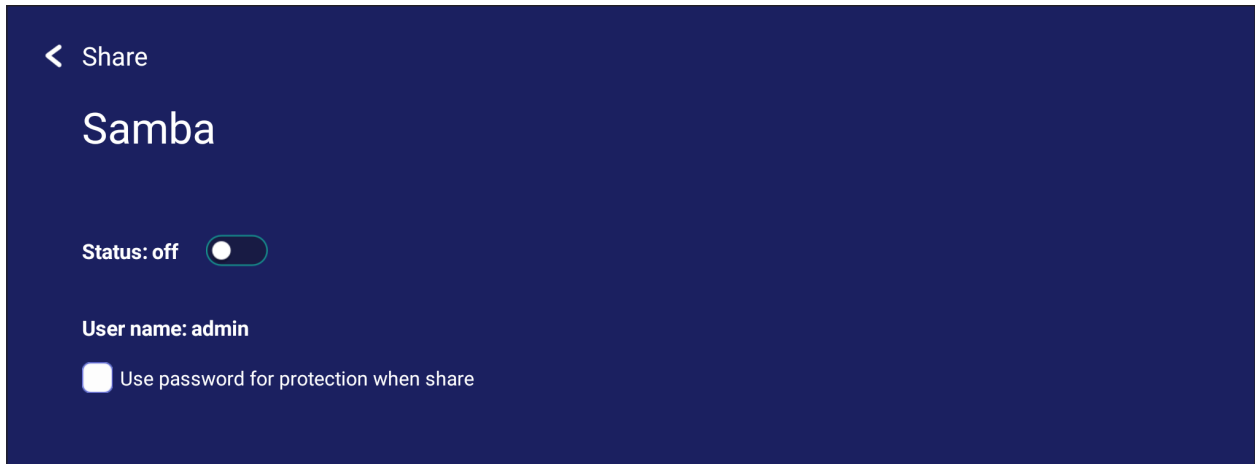

2. Tap the toggle button to enable the SAMBA Service, then set a password if needed.

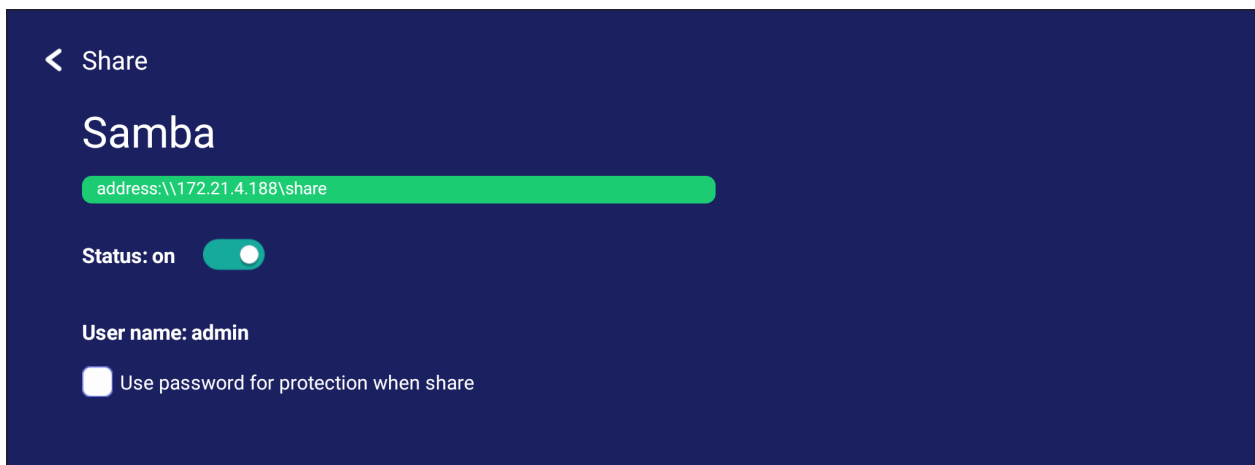

3. Ensure the ViewBoard and client equipment are connected to the same network.
4. Log in to the ViewBoard with the client equipment. Input the ViewBoard's IP address.



5. Key in the user name and password, then select **OK** (if necessary).

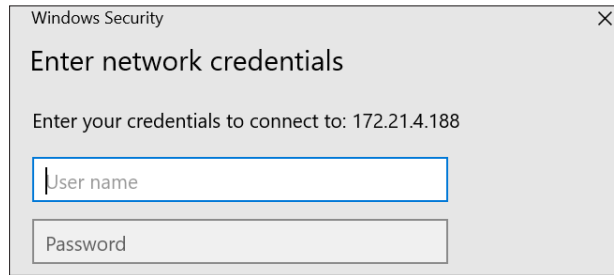

6. After a successful log in, the ViewBoard files will be available.

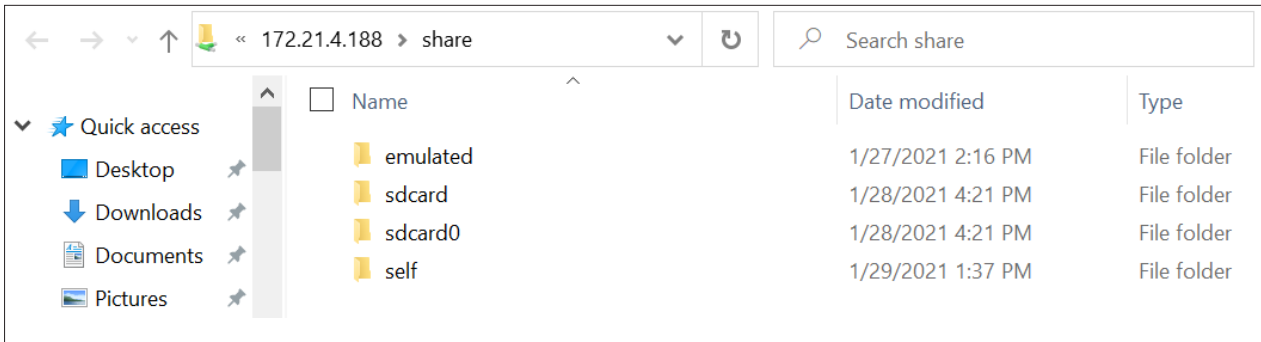

Display

Adjust the Wallpaper, Theme, and Protection settings.

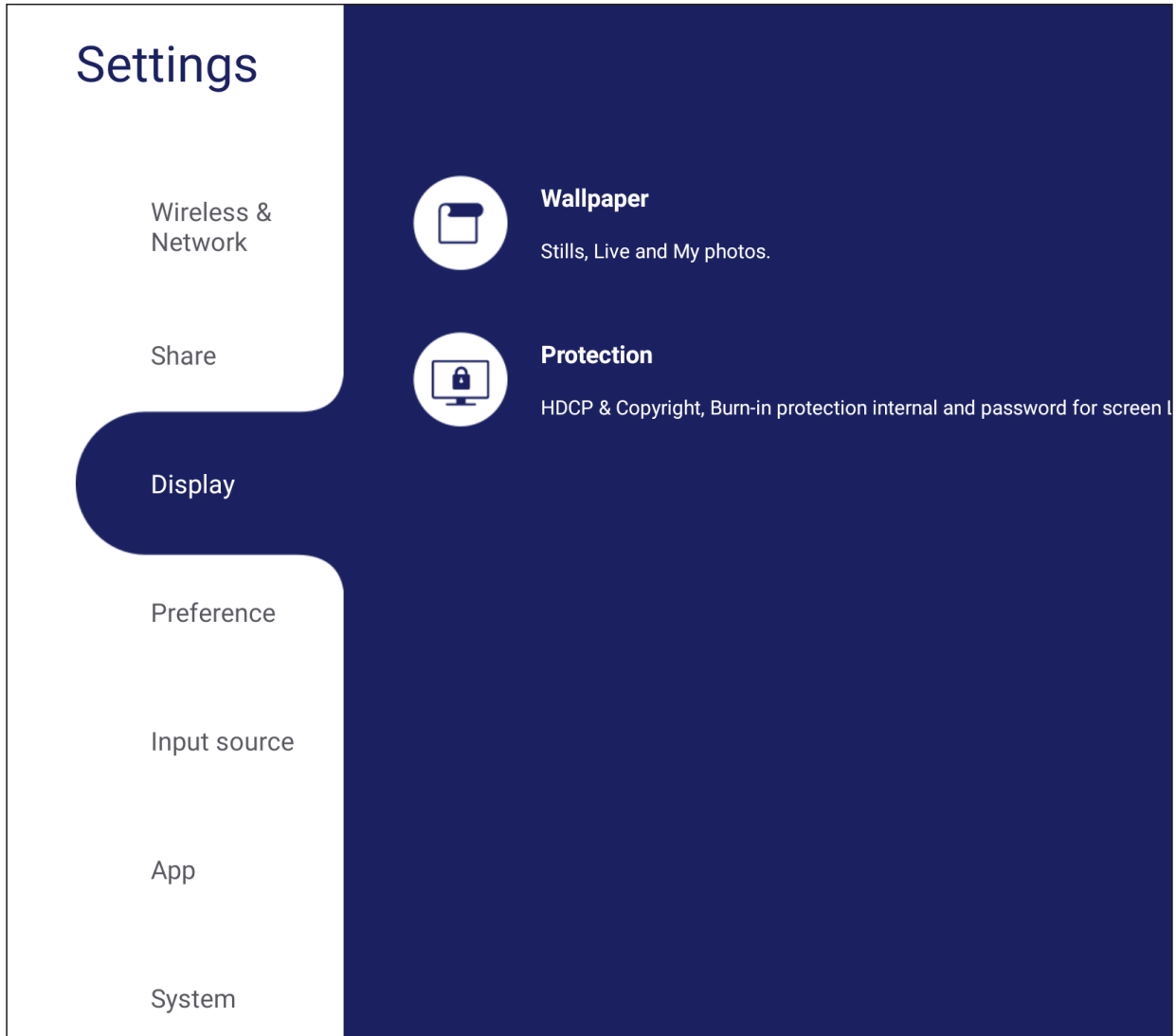

Wallpaper

Users can change their wallpaper with default images (both still and live), or use their own by tapping **My Photo** and selecting the image file.

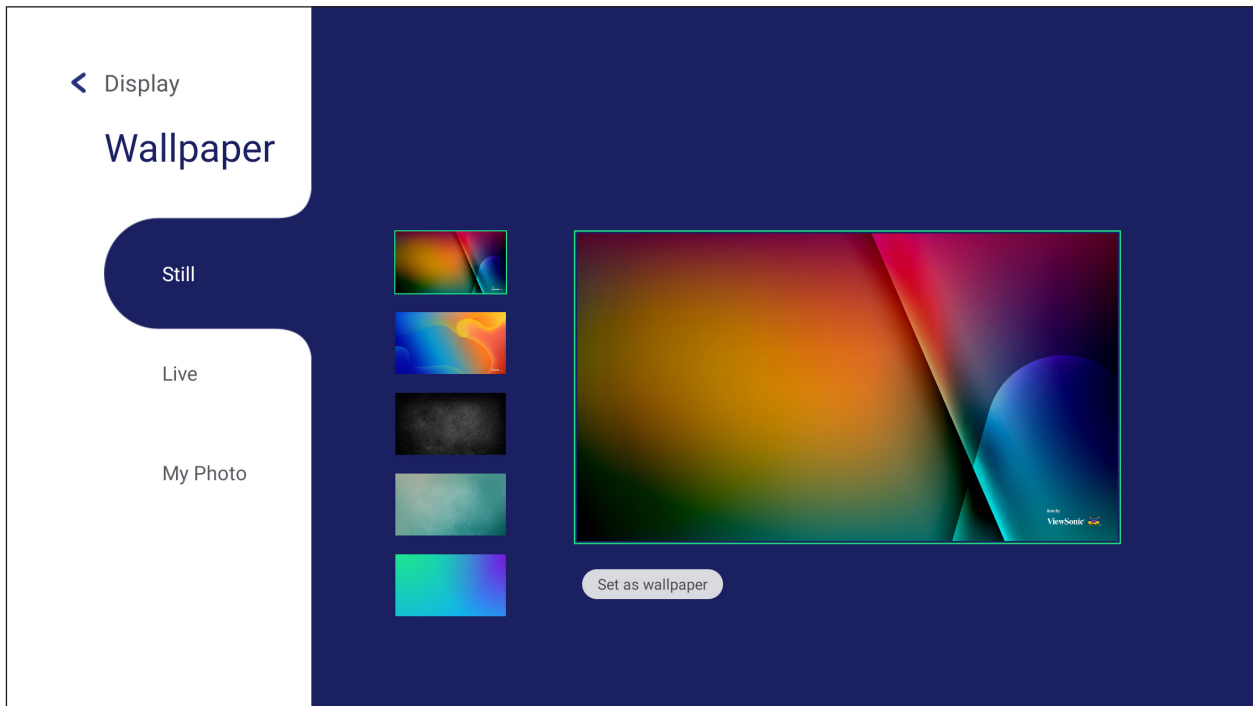

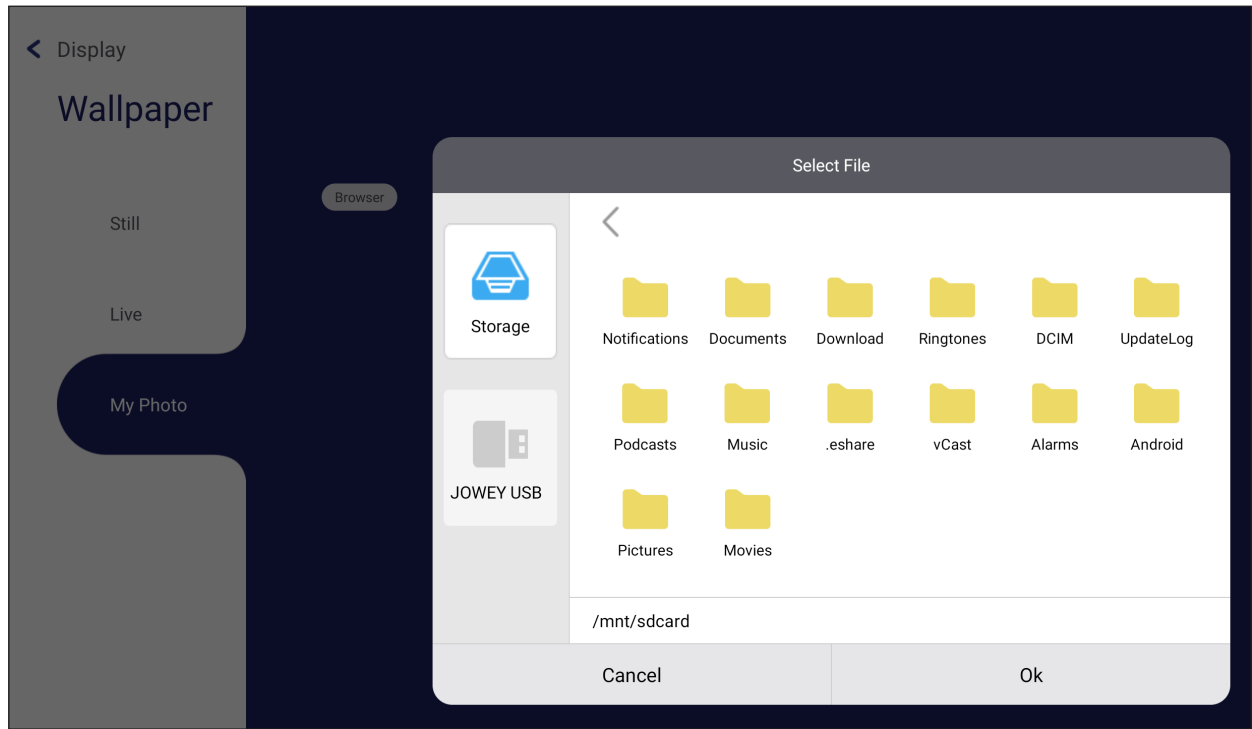

Protection

Toggle **HDCP & Copyright** and **Burn-in Protection Interval** On/Off, and set a **Password for Screen Lock**.

NOTE: Burn-in Protection allows the user to program the time between a gradually darker and brighter picture in minutes to prevent screen burn-in.

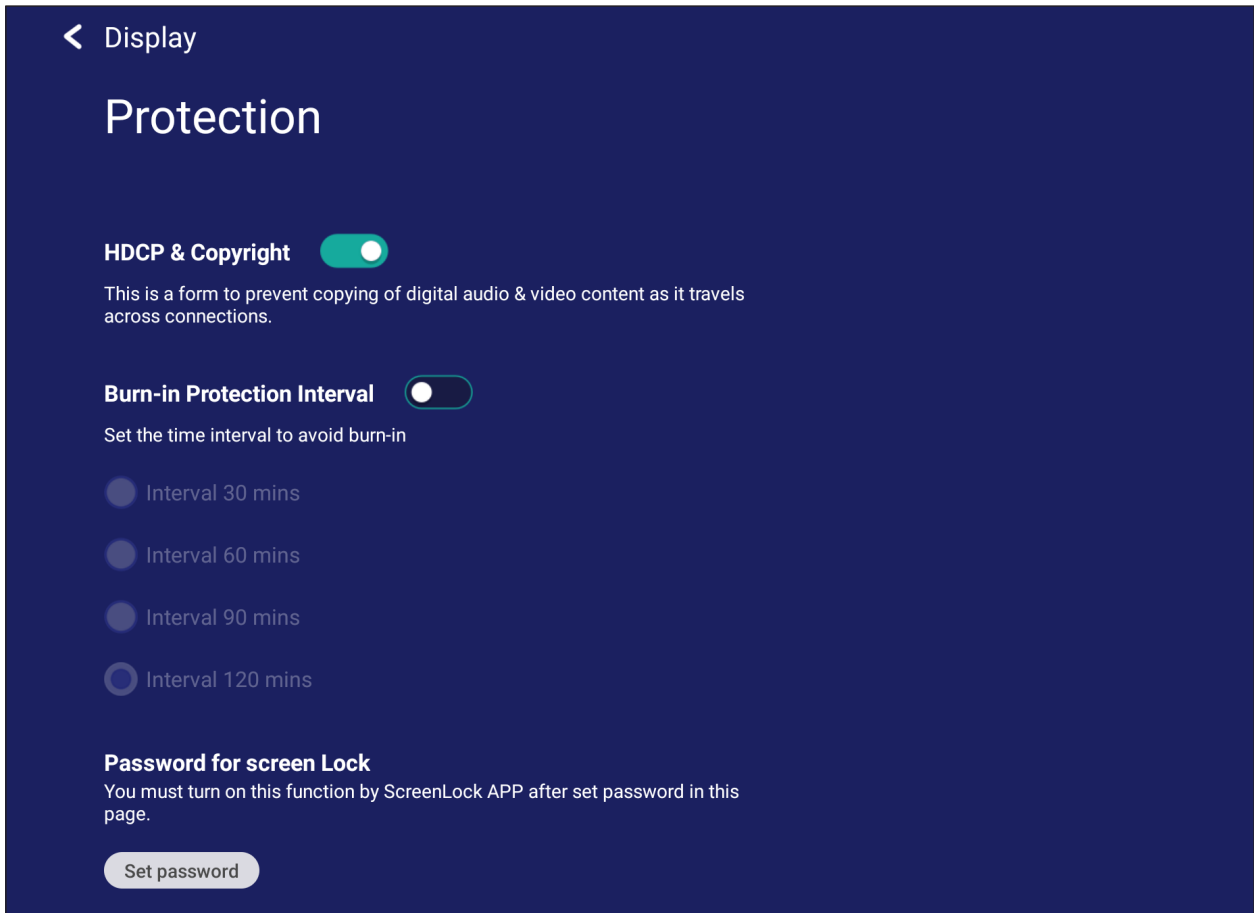

- To set up a password for screen lock, tap **Set Password** and enter the desired password.

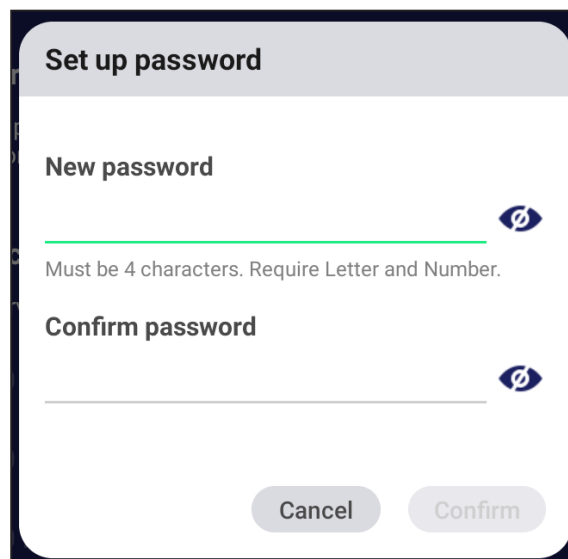

Preference

View and adjust **Touch, Language, Keyboard & Input, Date & Time, Boot Mode, Start up & Shut down, and Toolbar** settings.



Touch

Adjust **Touch Settings** and toggle **Touch Sounds** On/Off.



Language

Adjust and choose the preferred language from the available languages.

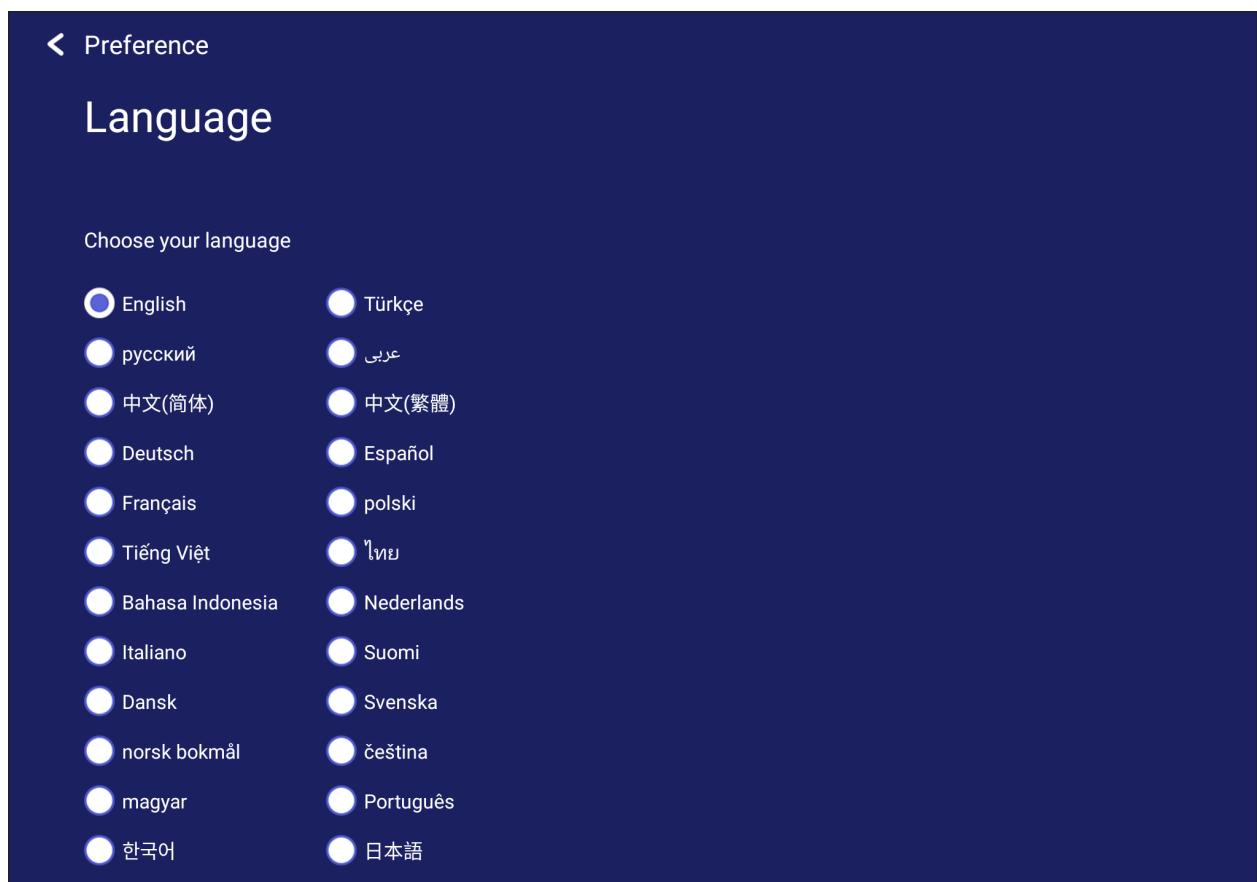

Keyboard & Input Method

Enable/disable the visual keyboard and/or change the default input method.

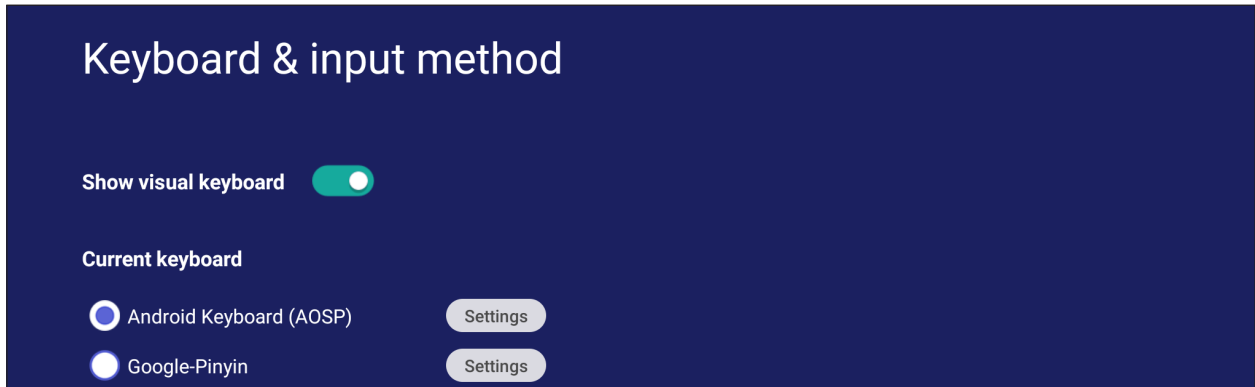

- Tap on **Settings** to adjust the advanced keyboard settings.

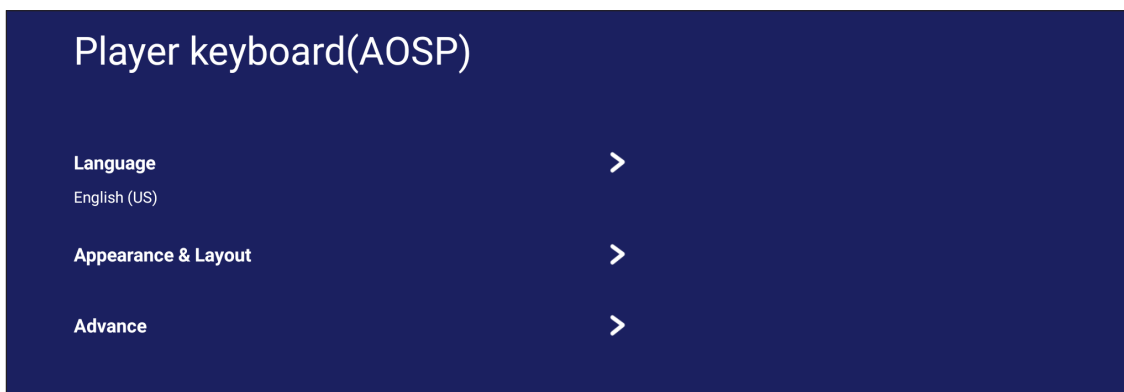
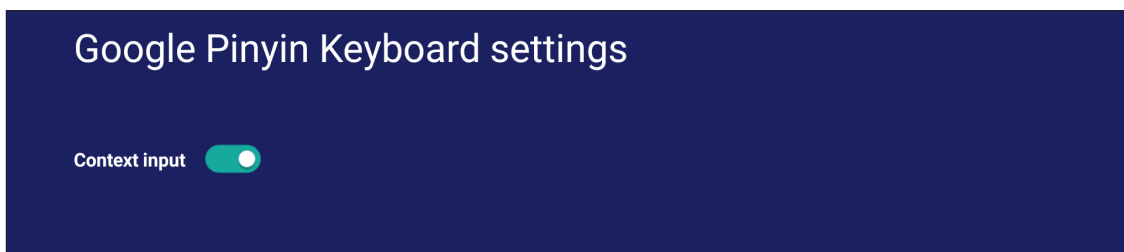

Date & Time

Set the system time and format.

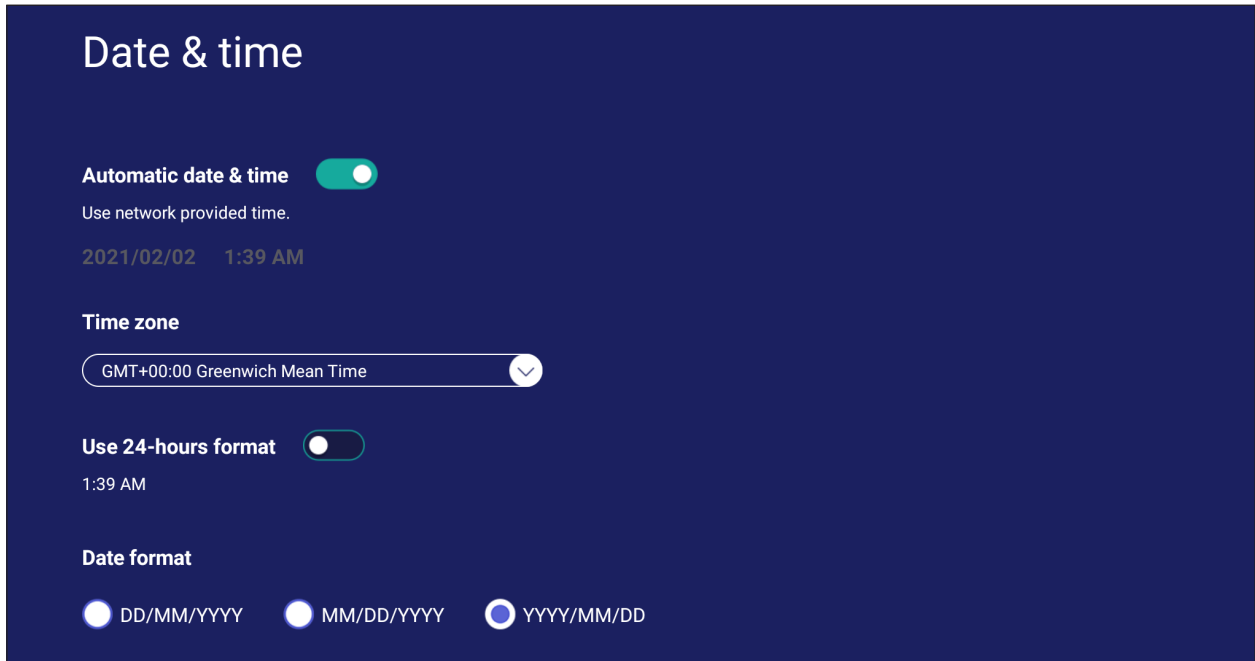

Item	Description
Automatic Date & Time	When enabled, the ViewBoard will automatically synchronize the date and time via the Internet.
Time Zone	Select the appropriate time zone.
Time Format	Choose from 12-hour or 24-hour time format. Simply toggle 24-hour format On/Off.
Date Format	Select from the available date formats.

Boot Mode

Adjust the preferred boot up mode and set/reset a password.

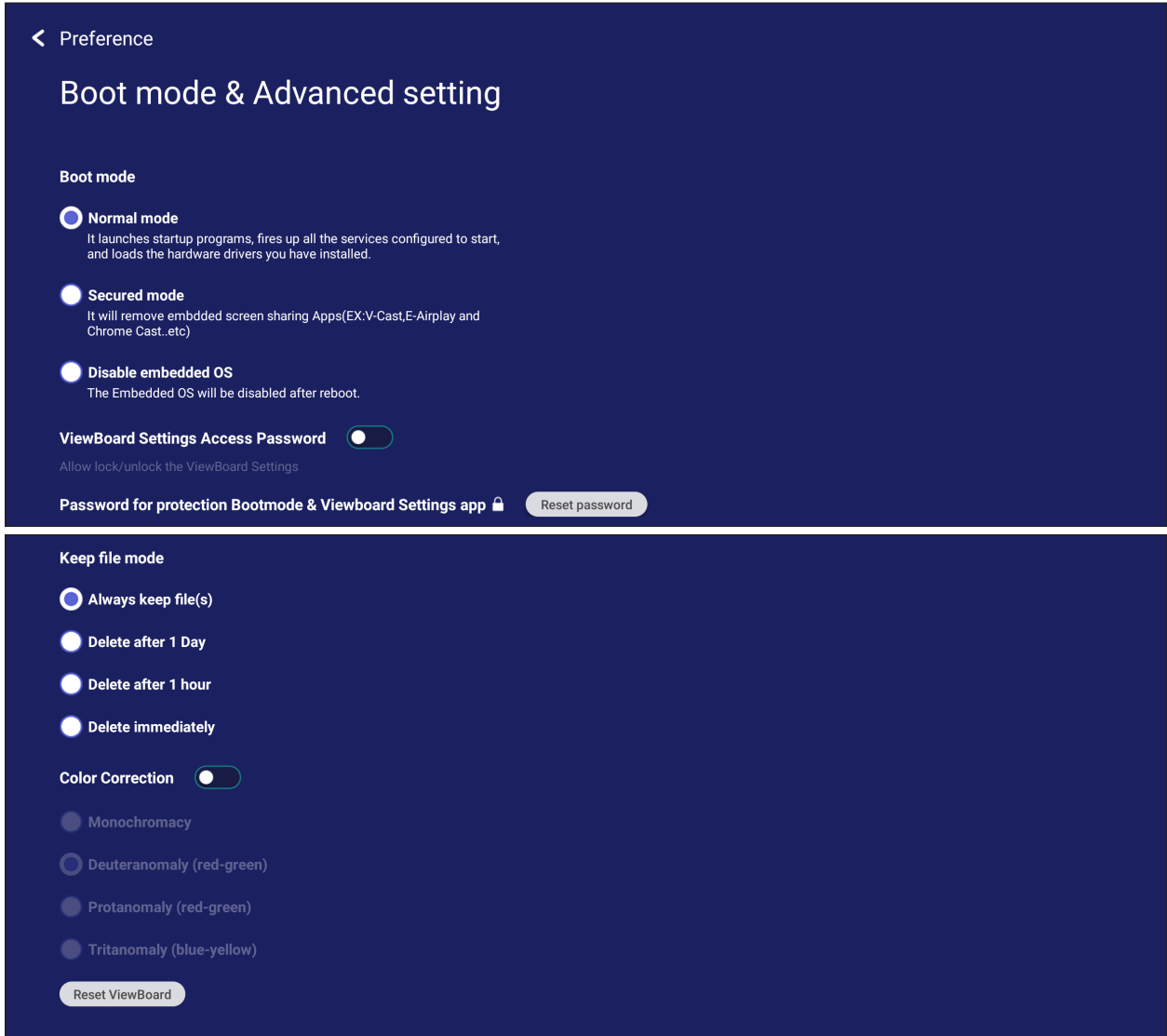

Item	Description
Normal Mode	The embedded screen sharing Apps will run normally.
Secured Mode	The embedded screen sharing Apps will be removed.
Disable Embedded OS	The system will automatically reboot, and then the Embedded OS will not appear.
ViewBoard Settings Access Password	Toggle to lock/unlock the ViewBoard Settings.
Password for Protection	Modify the Boot mode and ViewBoard Settings entry password.
Local File Protection Policy	Choose how long to keep local storage files in the Folder app.
Color Correction	Color correct the ViewBoard display screen for color blind users.
Reset ViewBoard	Rest the ViewBoard to its factory default settings.

Startup & Shutdown

Set the **Startup Input**, **Standby Mode**, **EnergyStar Mode**, **Black Screen After Startup**, **Power off Reminder** timer and **Schedule** settings.

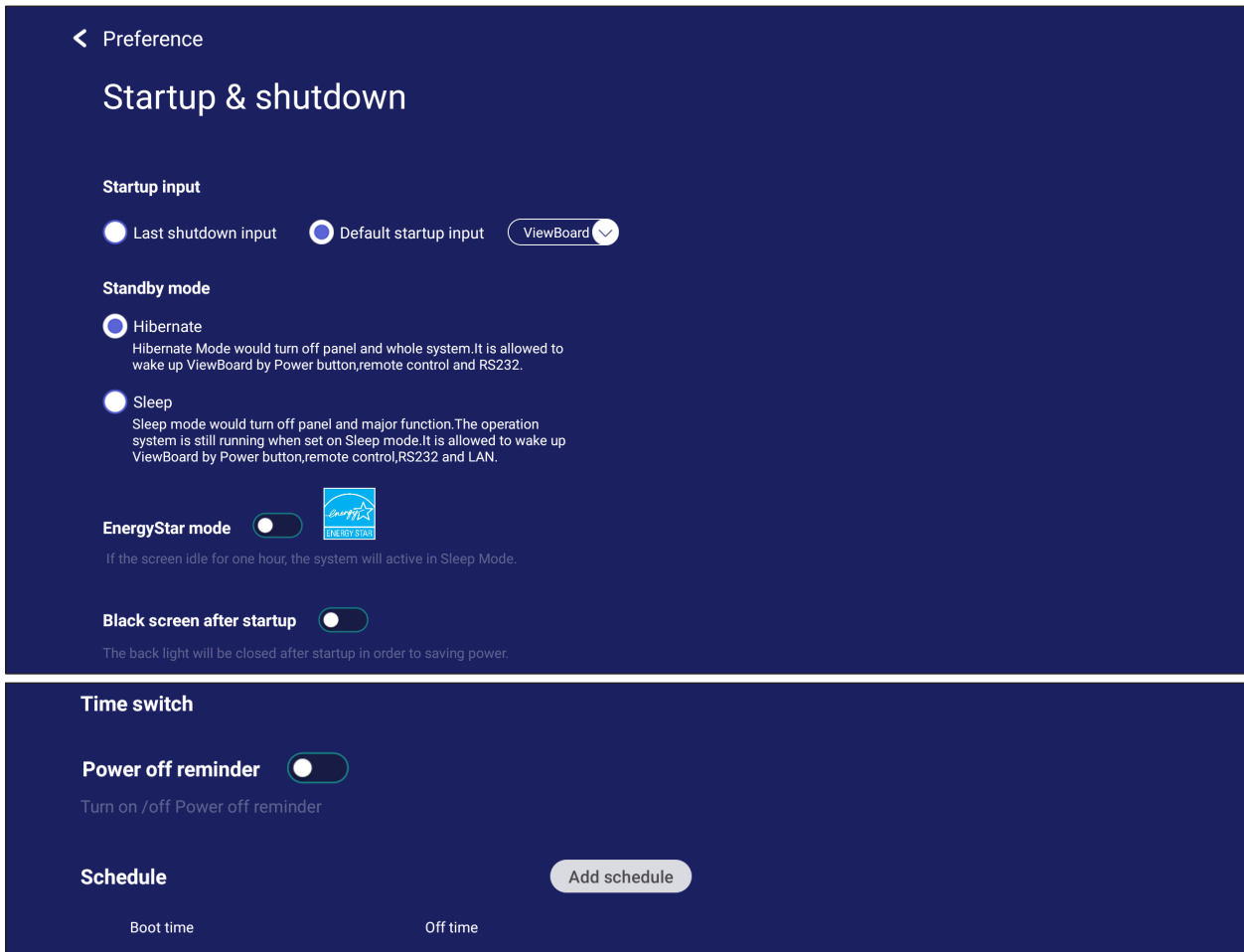

Item	Description
Startup Input	Adjust the Startup Input preference.
Display Setting when No Signal	Decide what happens to the display when there is no signal for HDMI, PC, or VGA sources.
Standby Mode	Decide what happens when you press the Power button while the ViewBoard is <i>On</i> .
EnergyStar Mode	Enable to automatically initiate <i>Sleep Mode</i> when the screen is idle for one hour.
Black Screen After Startup	When enabled, the ViewBoard will turn off the backlight automatically after booting up.
Time Switch Power Off Reminder	When enabled, the ViewBoard will turn off without any reminder after the scheduled off time.
Schedule	Schedule a Boot and Shut off time.

Toolbar Setting

Adjust the Side toolbar settings.



Input Source

Adjust the input source names and settings, as well as the side tool bar settings.

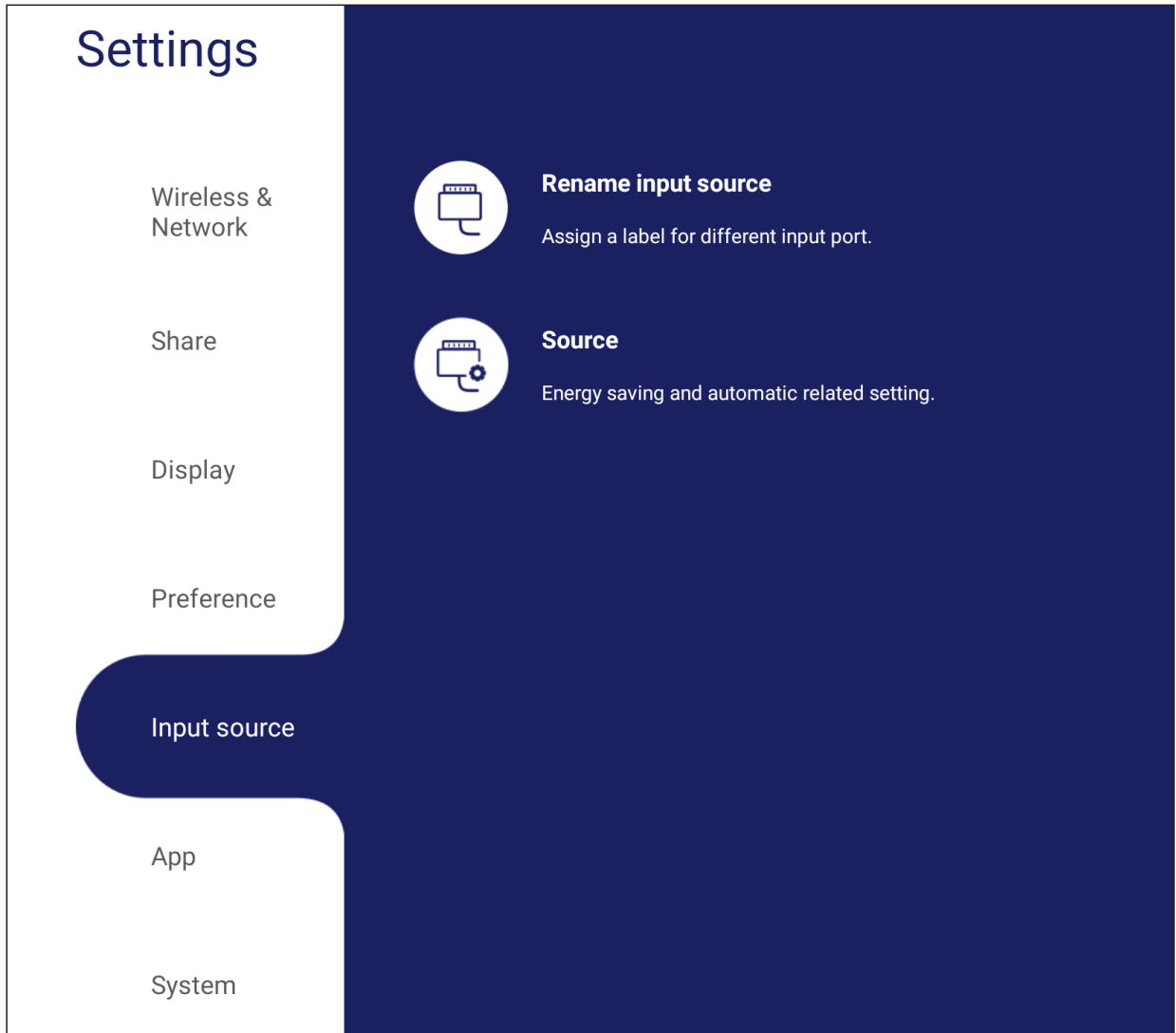

Rename Input Source

Set labels for each input source that will be easily recognized when displayed.

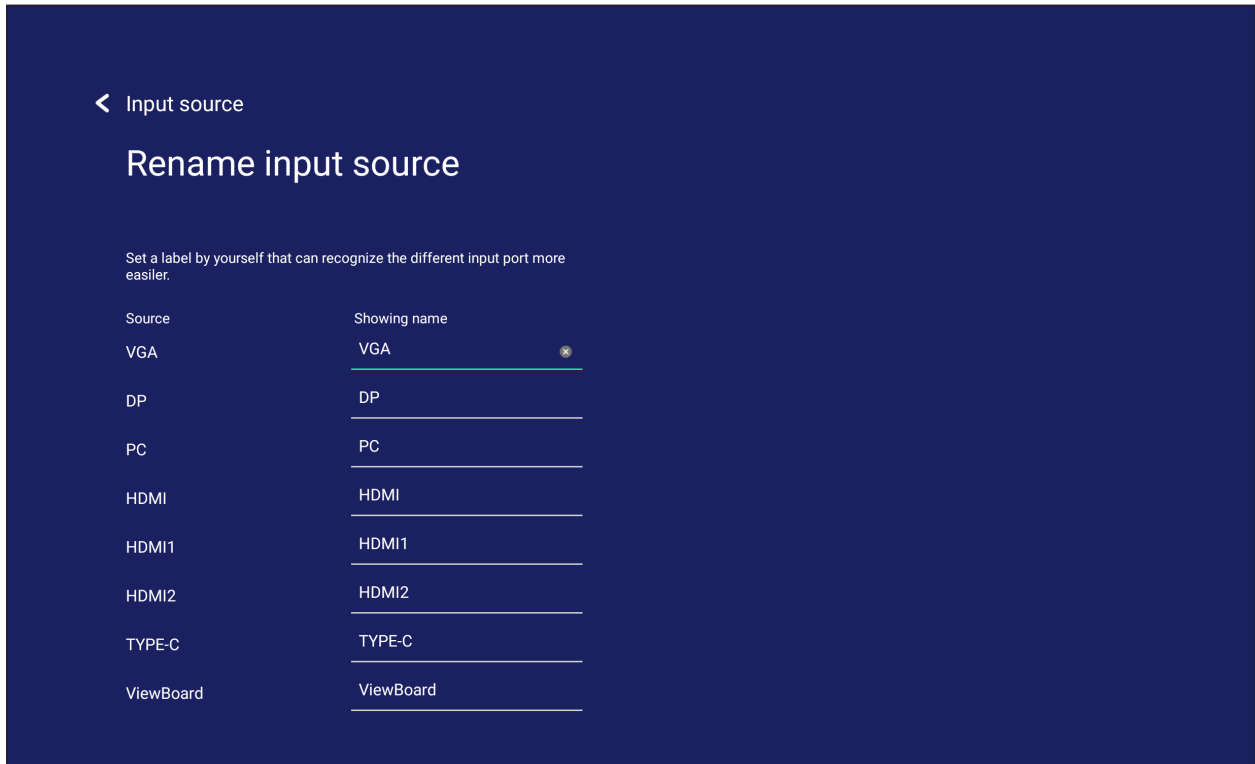

Source

Toggle Wake up by active source, Signal auto search, and HDMI CEC and select Input port auto switch.

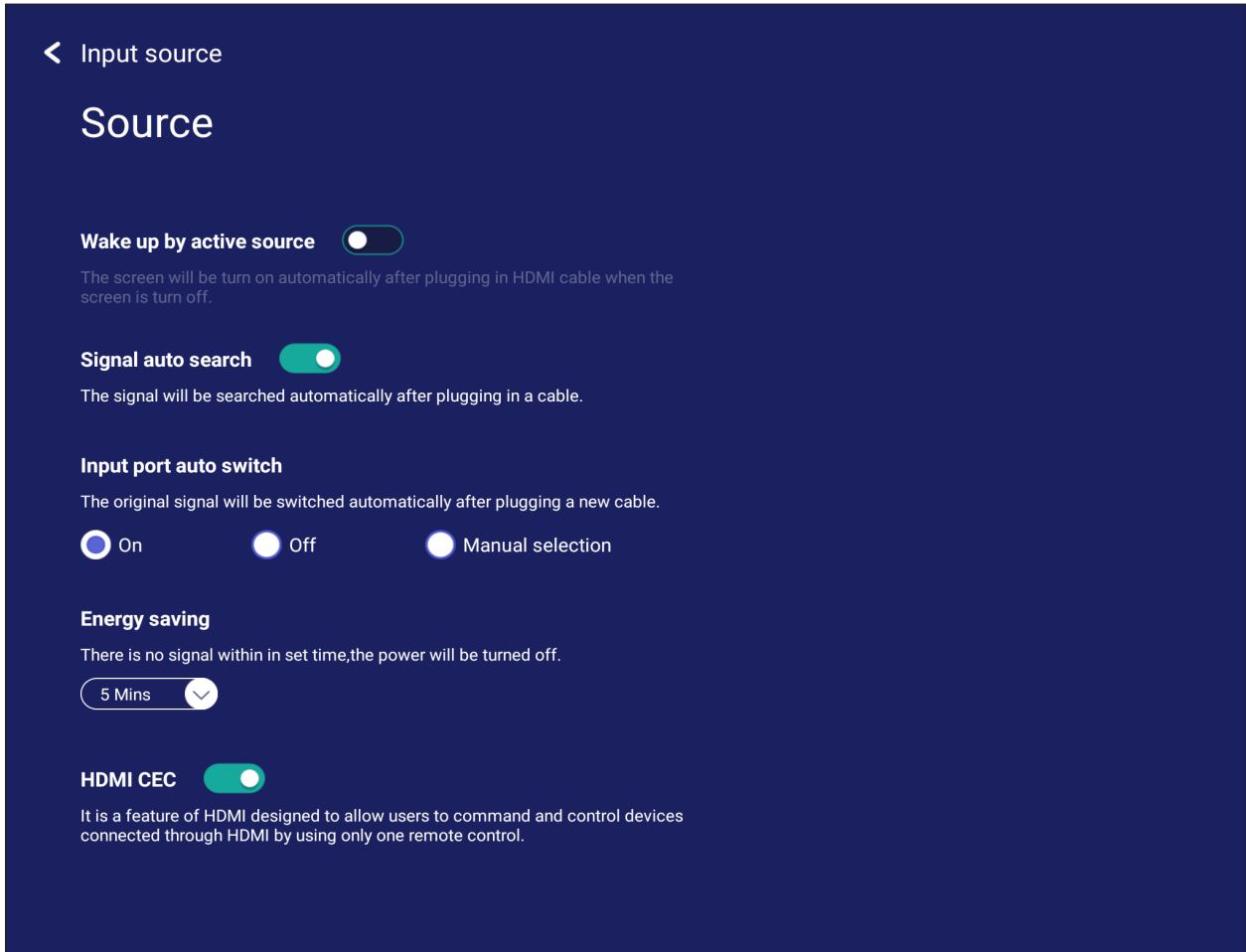

Item	Description
Wake up by Active Source	The screen will turn on automatically after plugging in an HDMI cable when the screen is off.
Signal Auto Search	When enabled, if the current source does not have a signal, the ViewBoard will automatically search for an input source.
Input Port Auto Switch	The original signal will automatically switch to a new cable after it's plugged in.
Energy Saving	Set a time period to power off if no signal is detected.
HDMI CEC	Enable/disable HDMI CEC functions.

App

The user can view App information and force stop, uninstall, clear data, clear cache, and clear defaults.

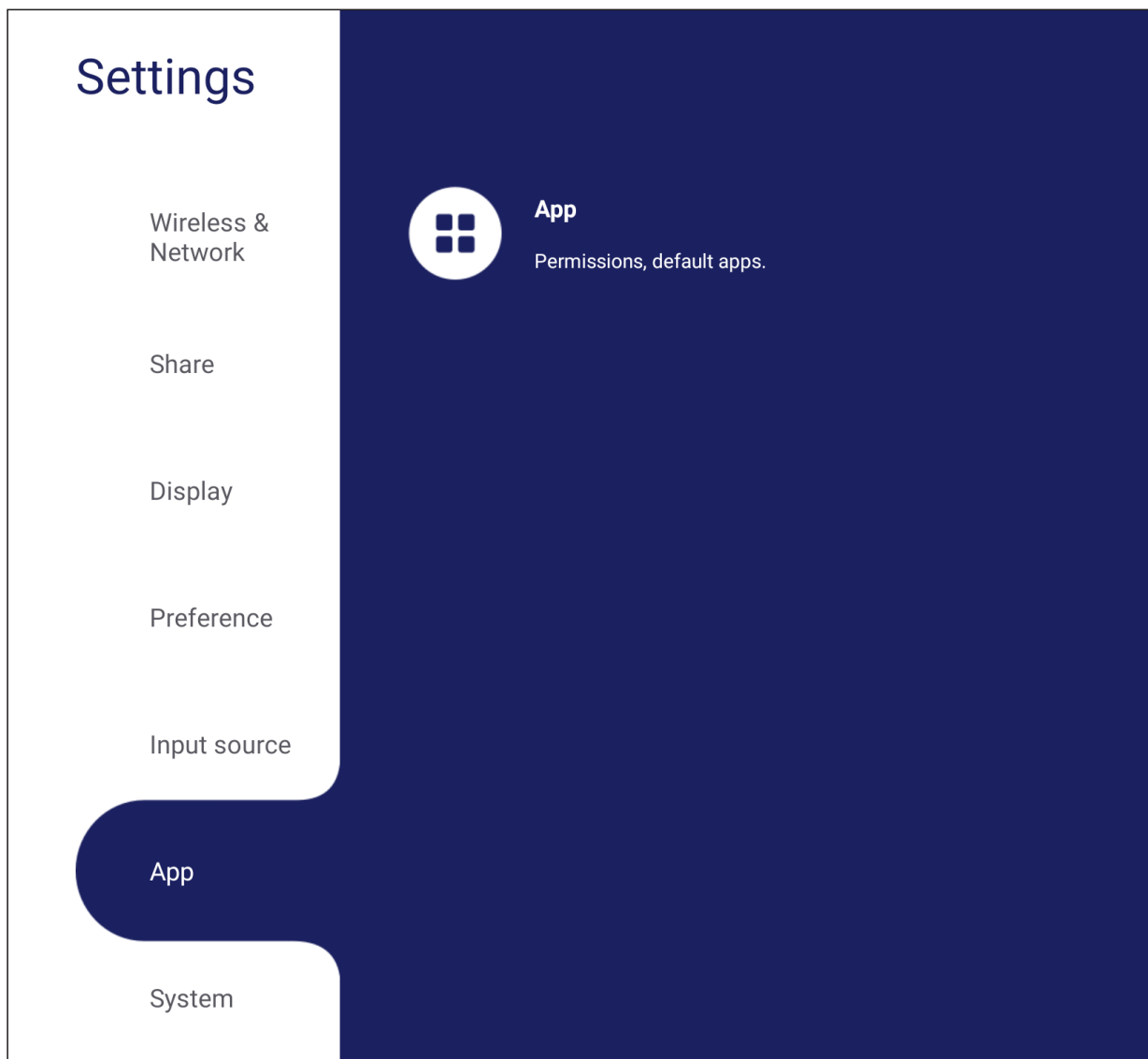

NOTE:

- Pre-loaded apps cannot be uninstalled.
- Not all apps support Clear Defaults.

APP

View any running or installed applications. Tap on them for more detailed information and options.

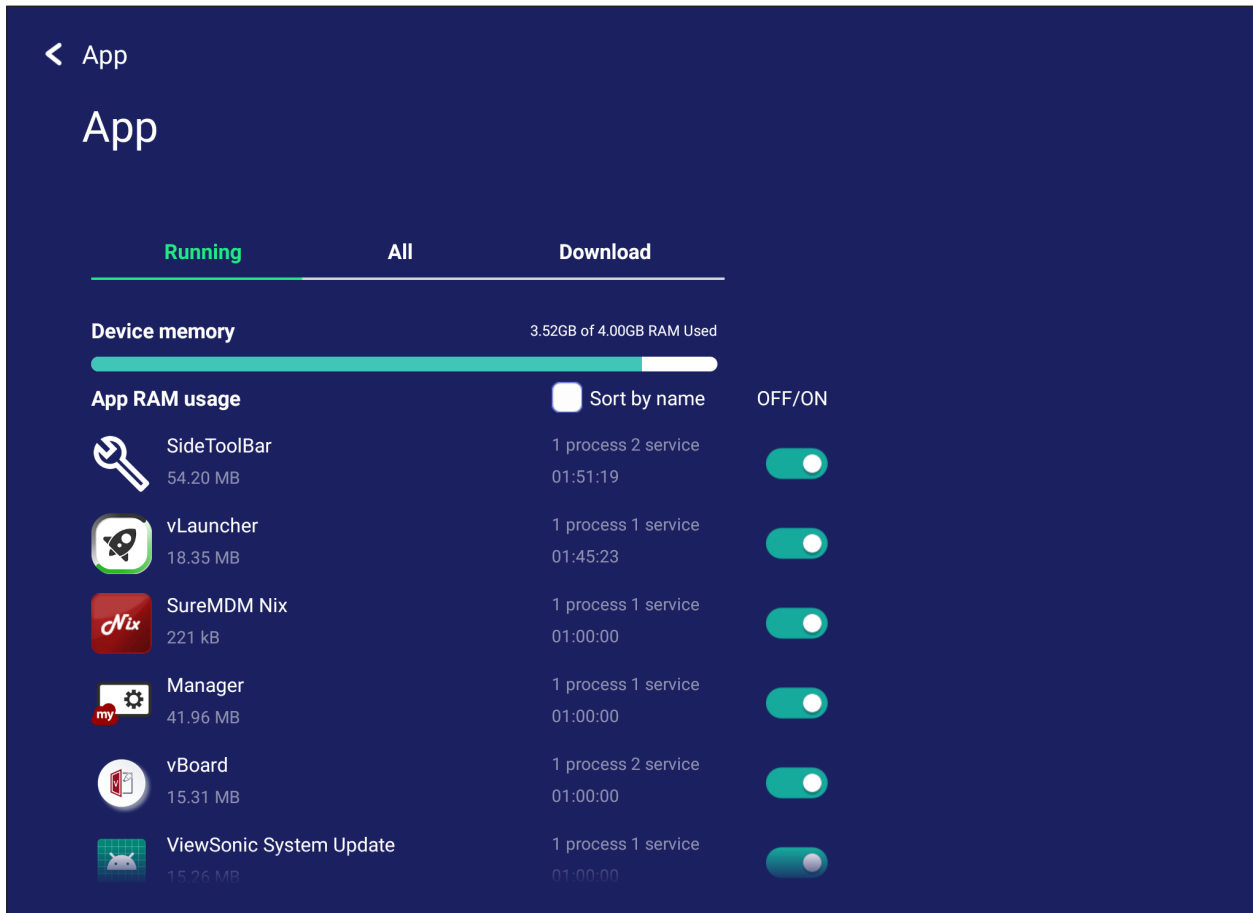

- By tapping on a running application, you can see more information, stop, or report the application.

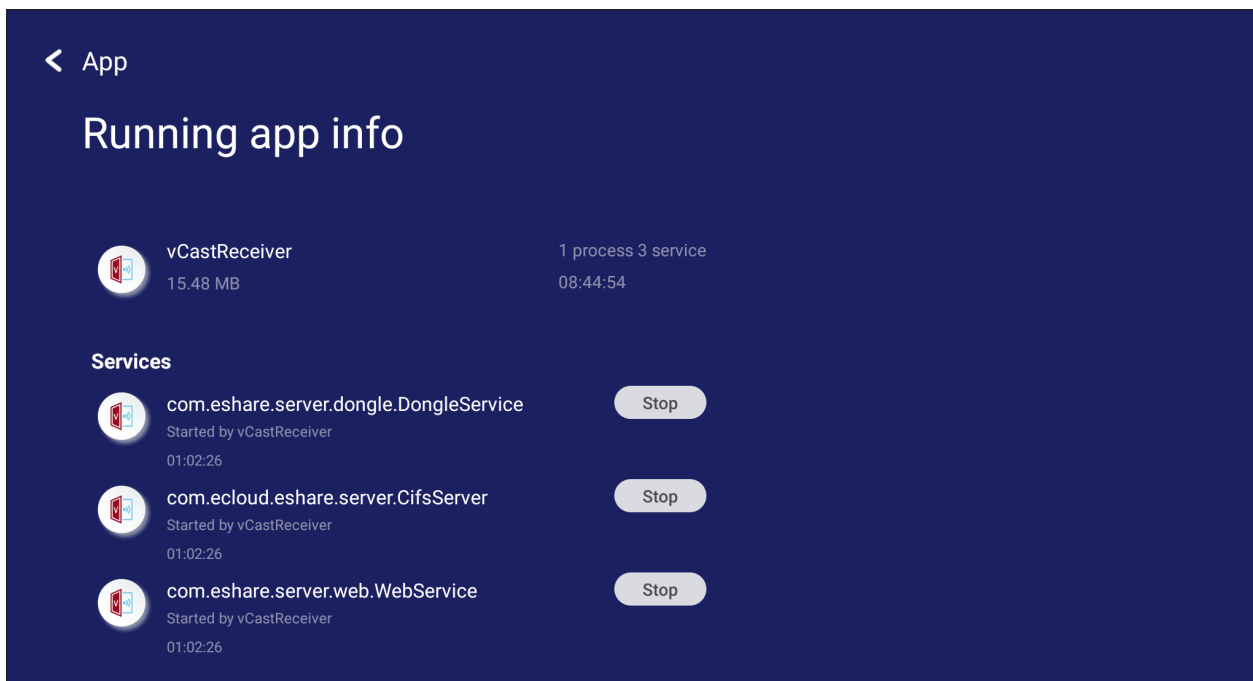

- Selecting **All** or **Download** will list all installed applications.

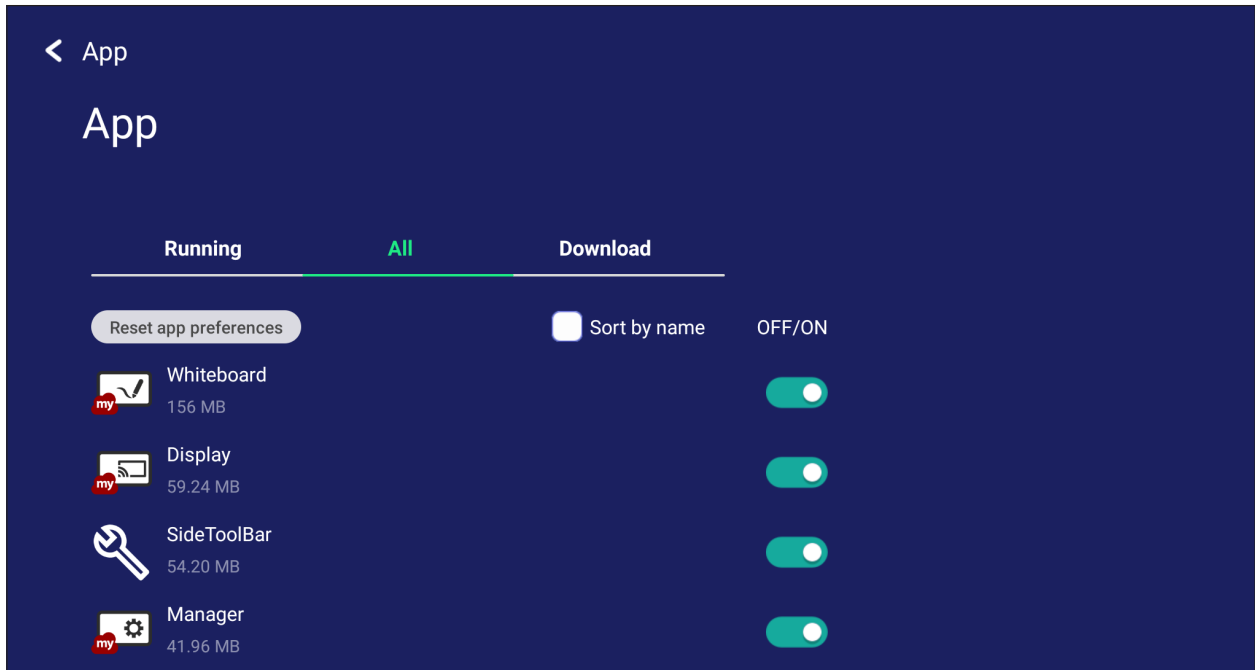

- Tapping on any application will display further information and options.

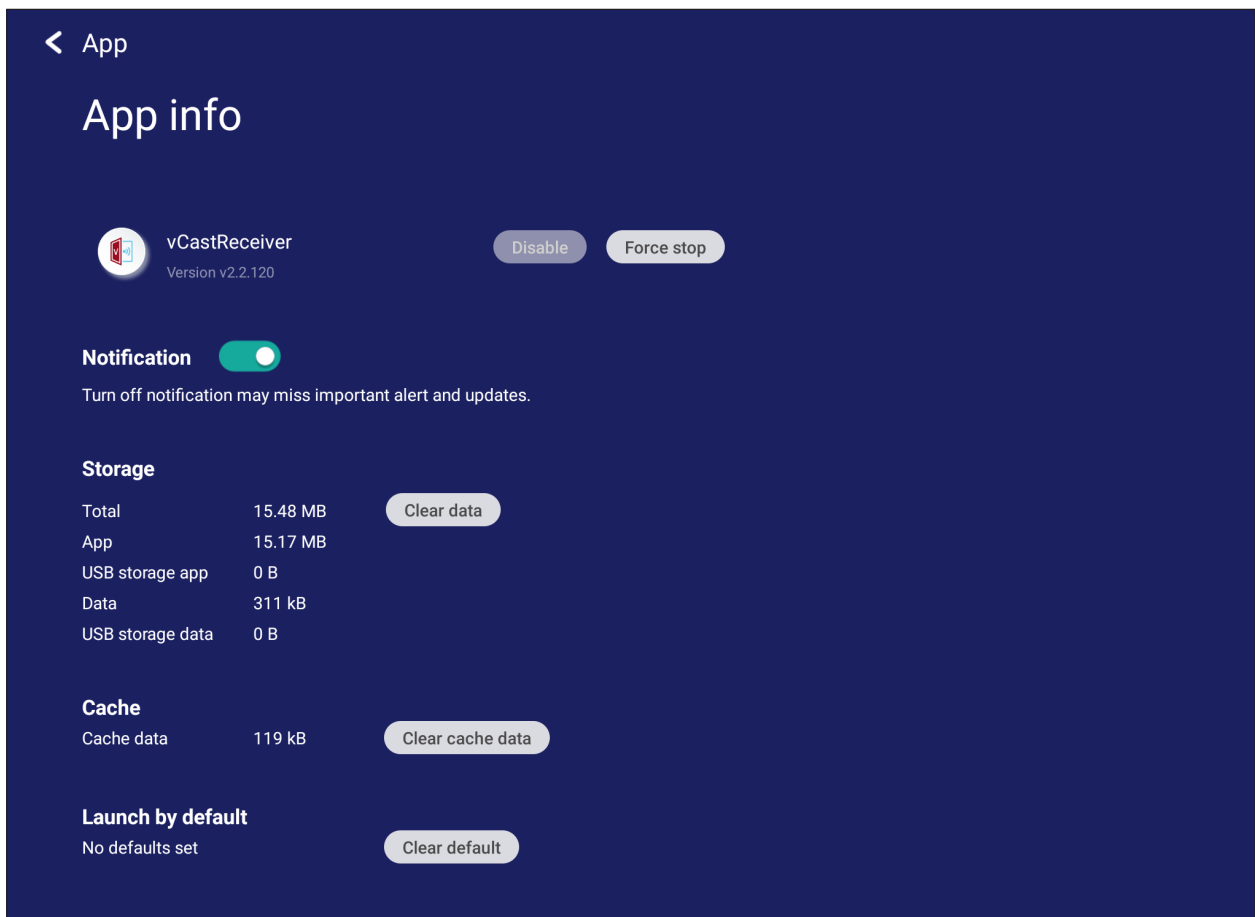

System

View and adjust **Storage**, **Security**, **System Update**, and **About device** settings.

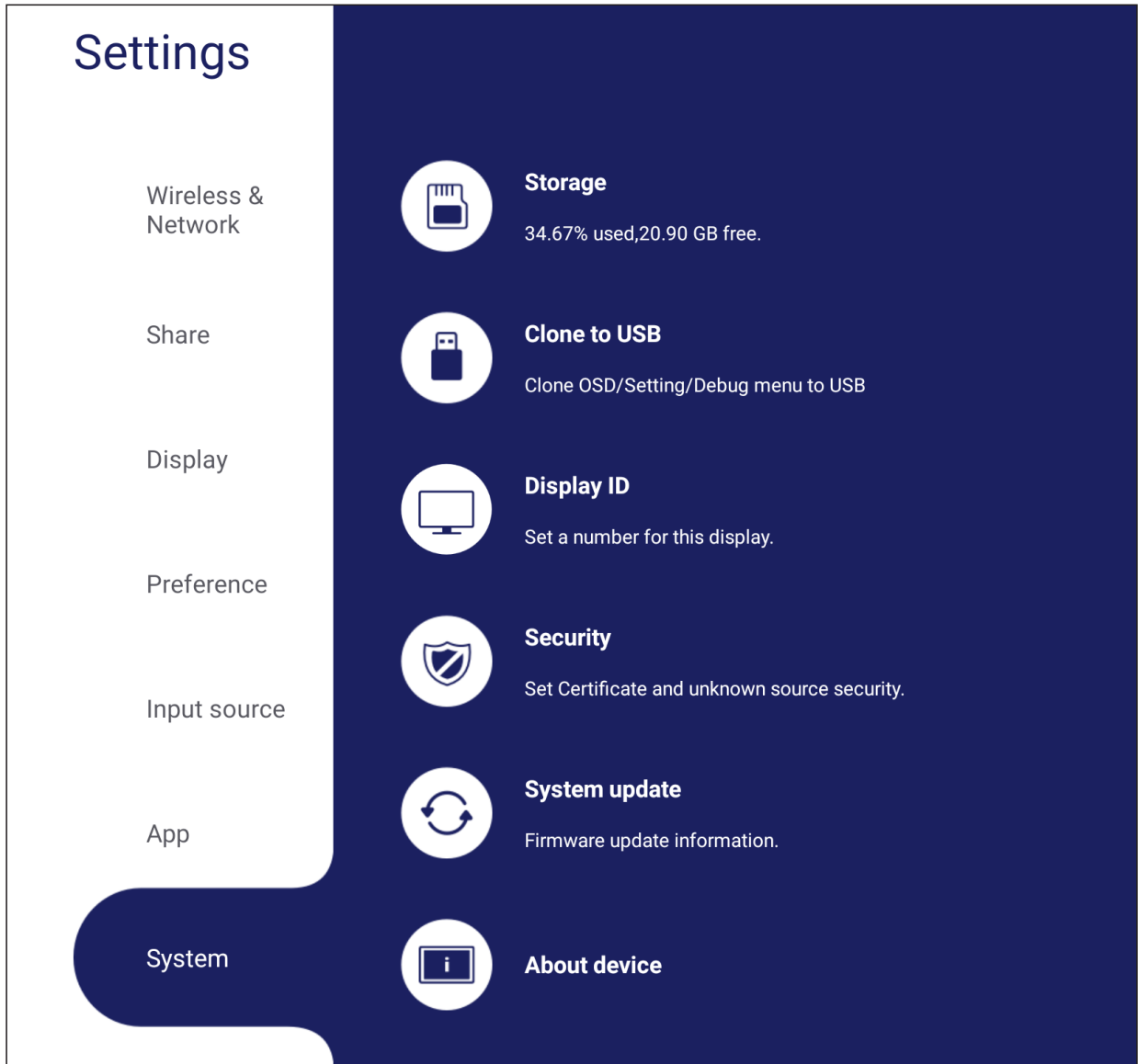

Storage

Users can check the storage status of their ViewBoard.

Clone to USB

Copy settings to an external USB drive.

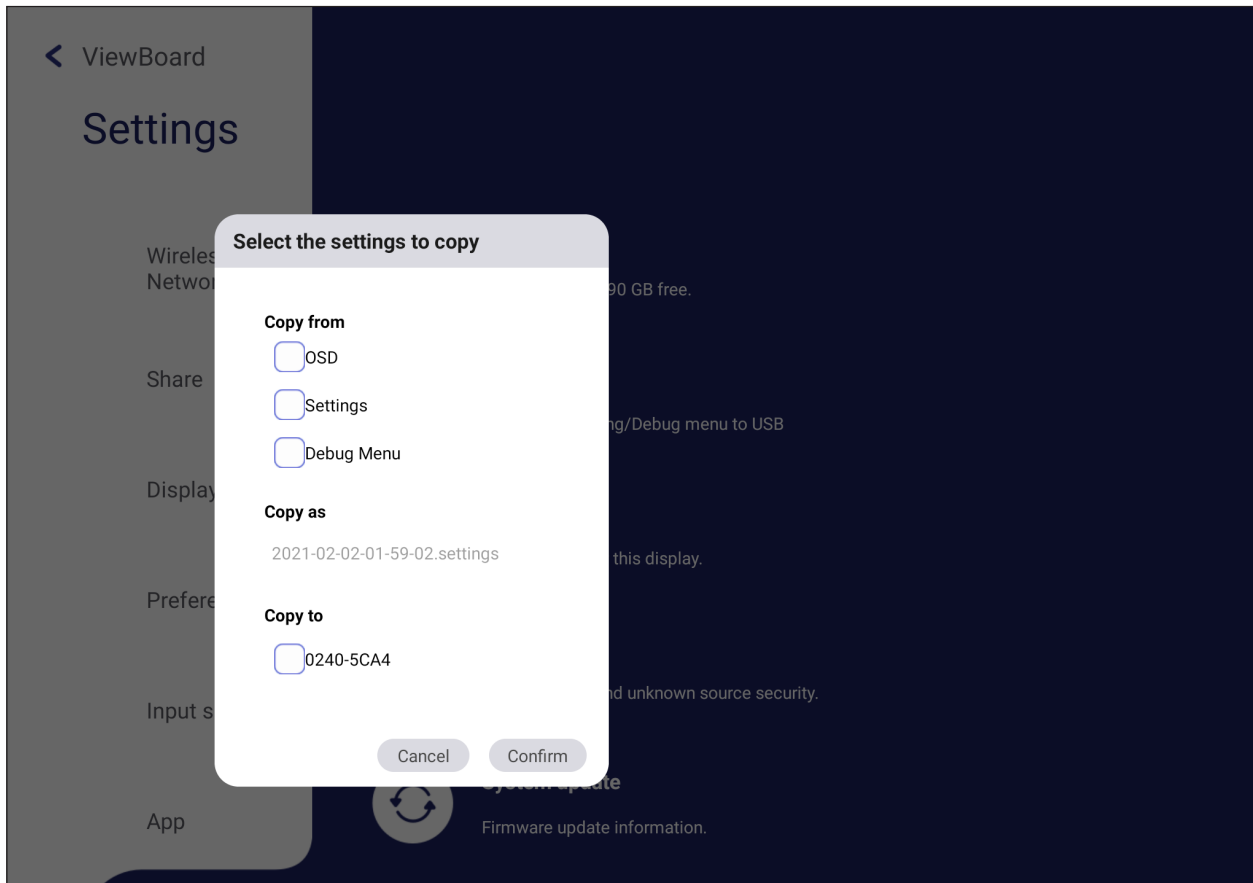

Display ID

Assign a number to remote control the display by RS-232/LAN.

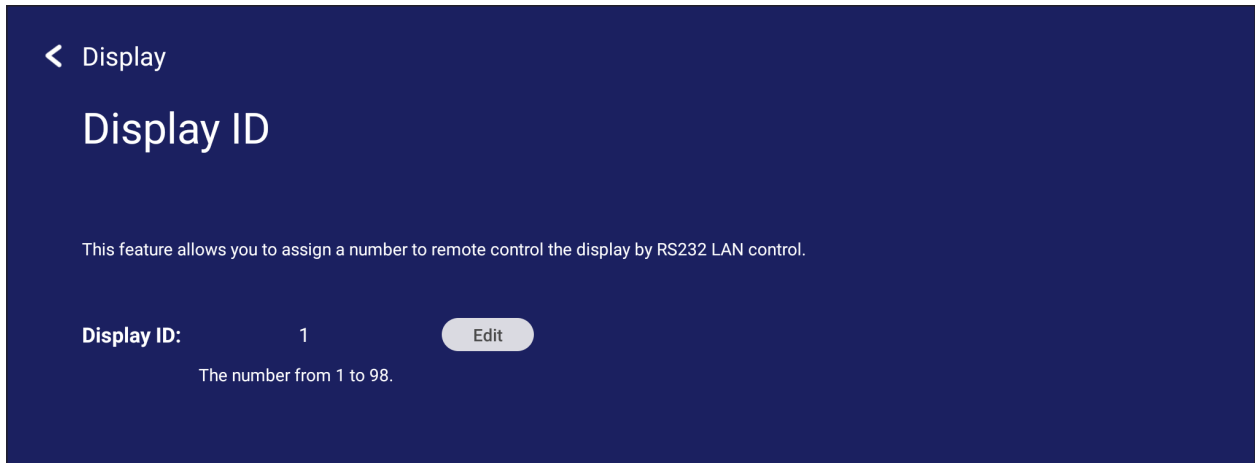

- To assign or change the Display ID, tap **Change** and input a number.

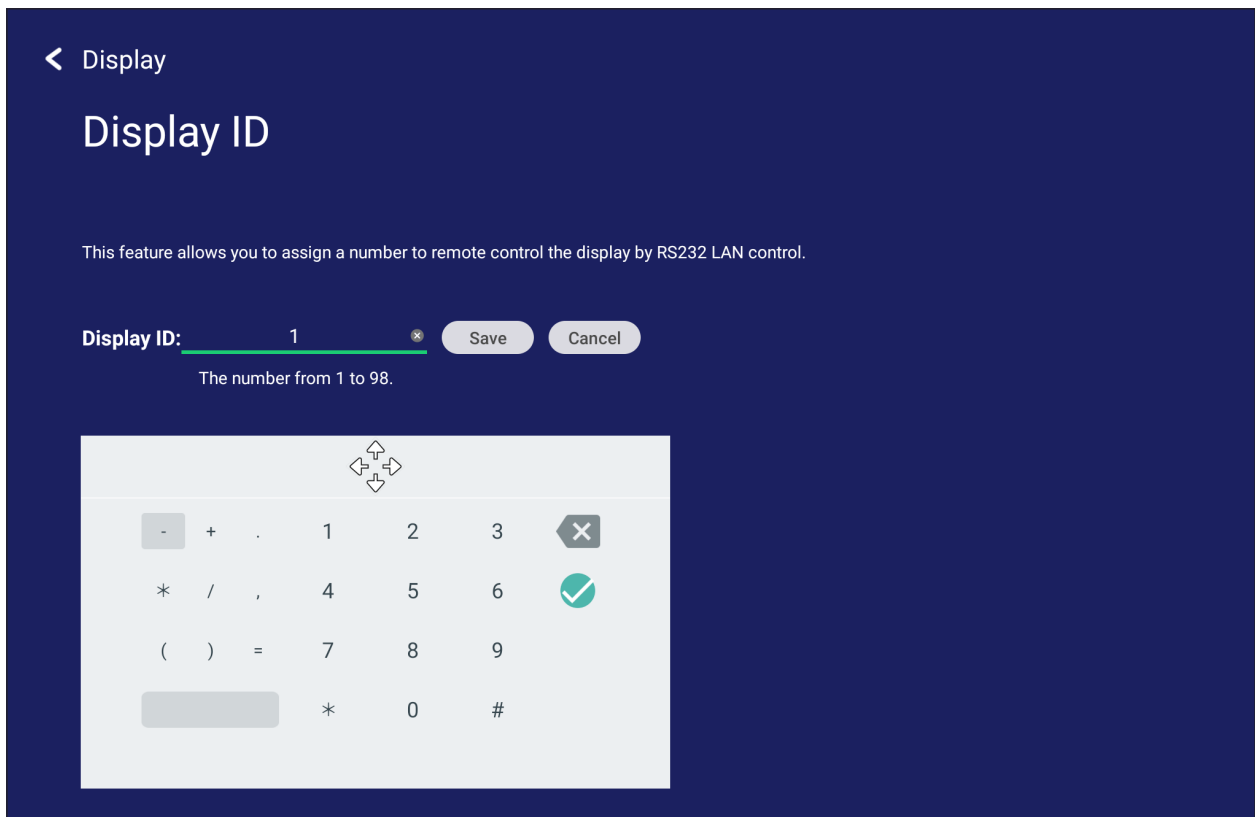

NOTE: The Display ID is for RS-232 users, and the range is 01~99.

Security

Review **Certificate**, **Trusted Credential** storage, and **Unknown sources** install settings.

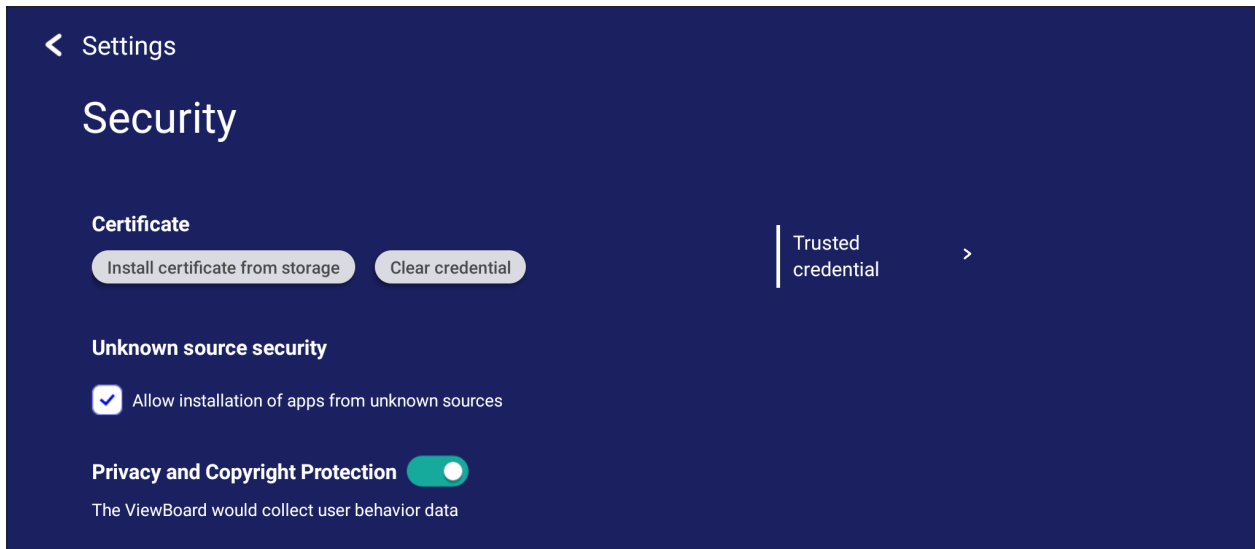

- Tap on **Install certificate from storage** to add additional certificates.

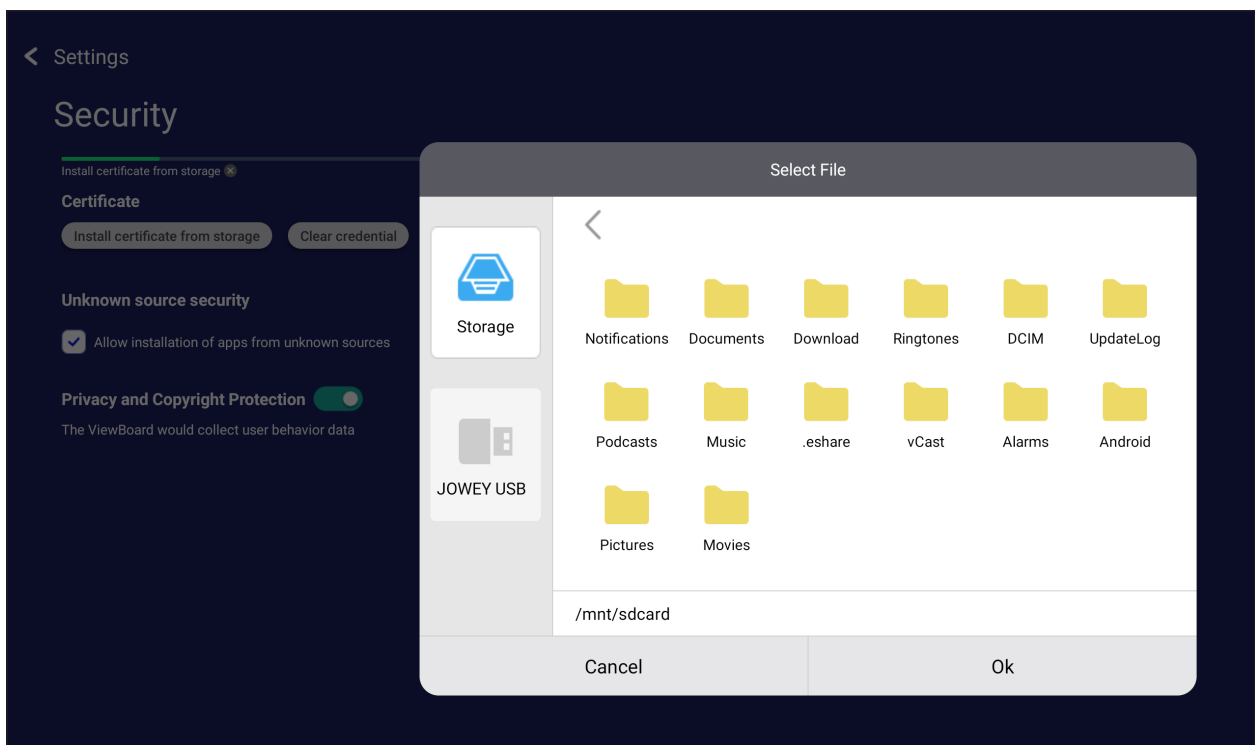

- Selecting **Clear Credentials** will remove all manually installed credentials.

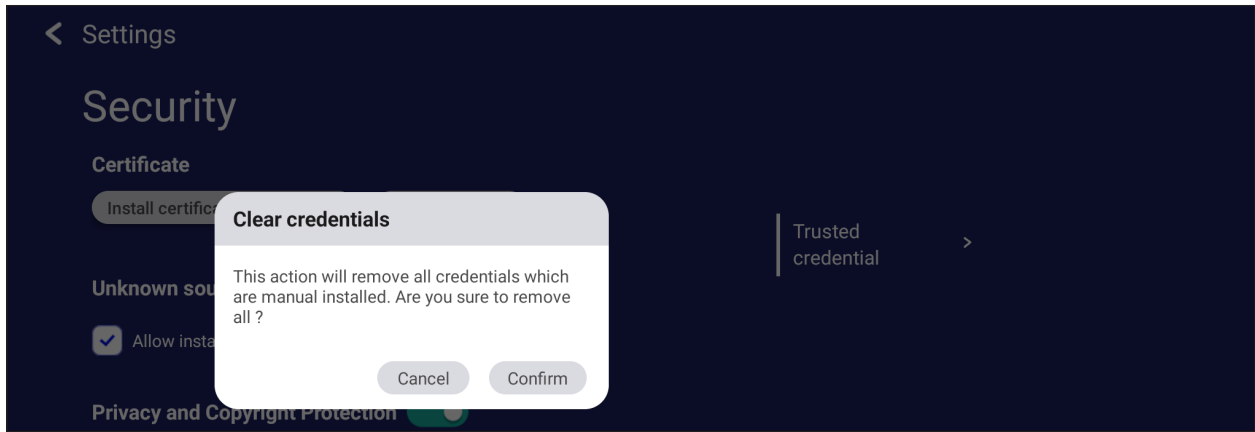

NOTE: Pre-loaded credentials cannot be cleared.

- Under **Trusted Credentials** view and edit all trusted and installed CA certificates.

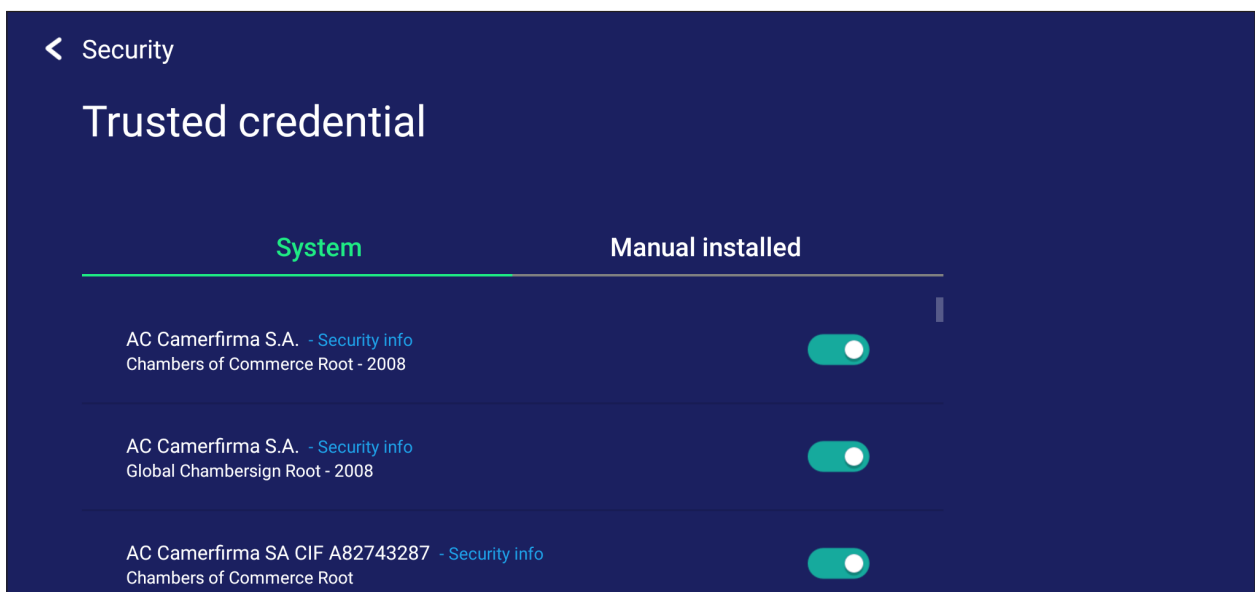

- Tapping on a credential will provide more detailed information.

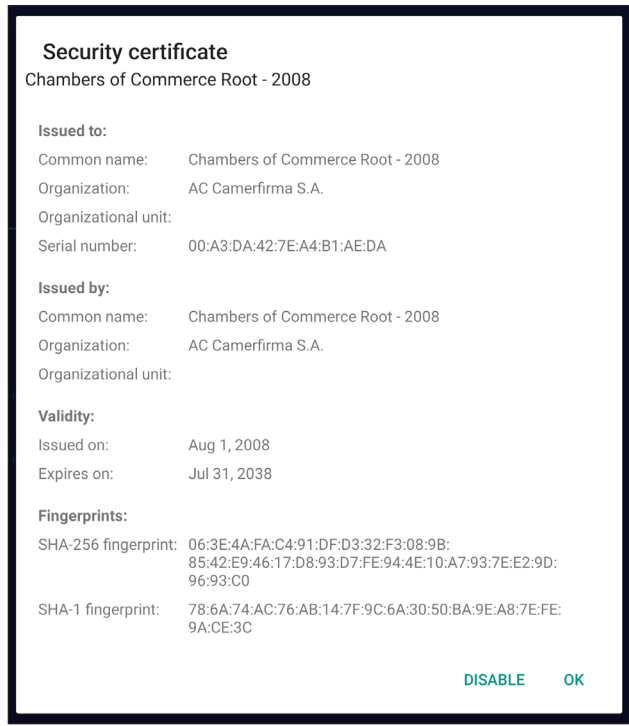

- Allow the installation of applications from unknown sources by selecting the box under **Unknown source security**.

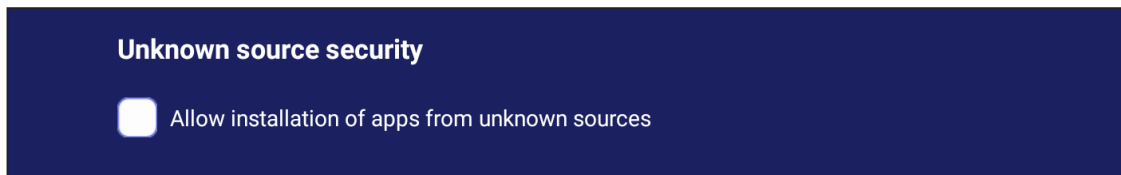

NOTE: Apps from unknown sources may not be compatible or work properly.

Privacy and Copyright Protection

Agree/disagree to allow the ViewBoard to collect user behavior data.

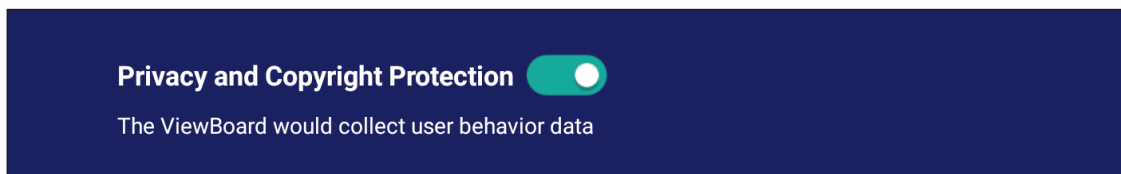

System Update

The ViewBoard automatically searches for software updates whenever connected to the Internet (OTA). With just one click, users can update their version of ViewBoard software.

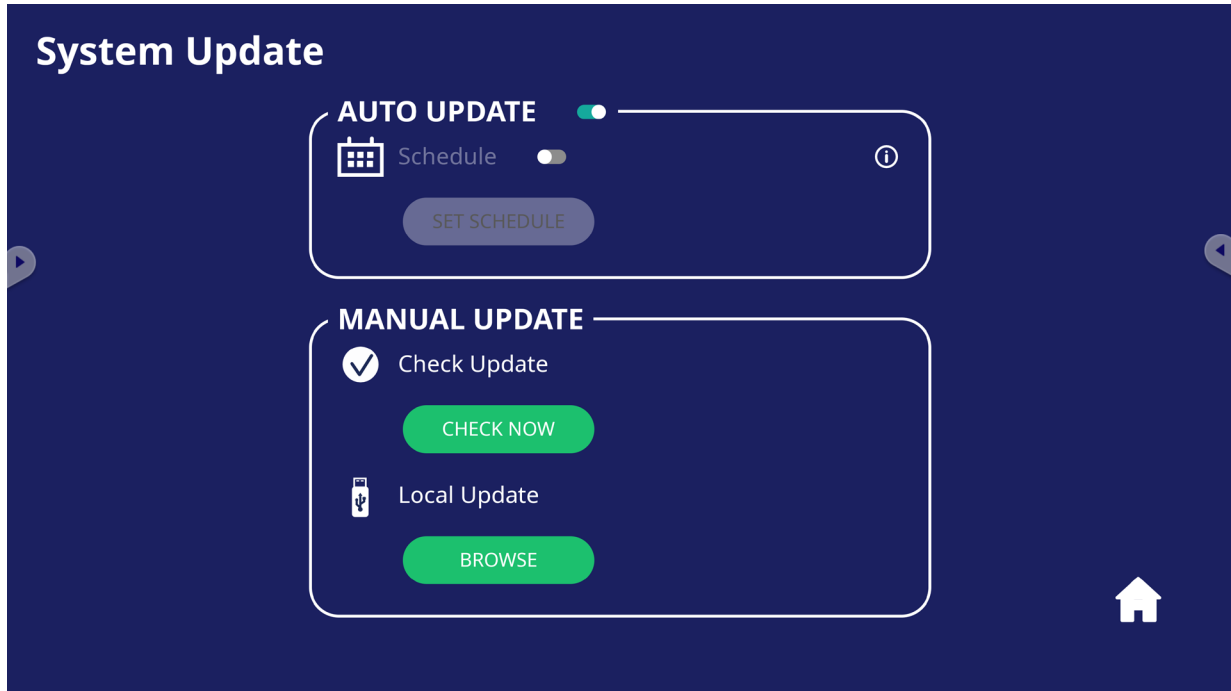

Item	Description
Auto Update	When the display is off, the system will automatically check for a new version. If a new version is found, the system will automatically update. After the update is complete, the system will turn off.
Schedule	Set the update time.
Manual Update	Update the software manually.
Check Update	Check for any available updates.
Local Update	Update the system from an external USB device.

About Device

Display Embedded Player information, **Legal information**, and **Asset Tagging**.

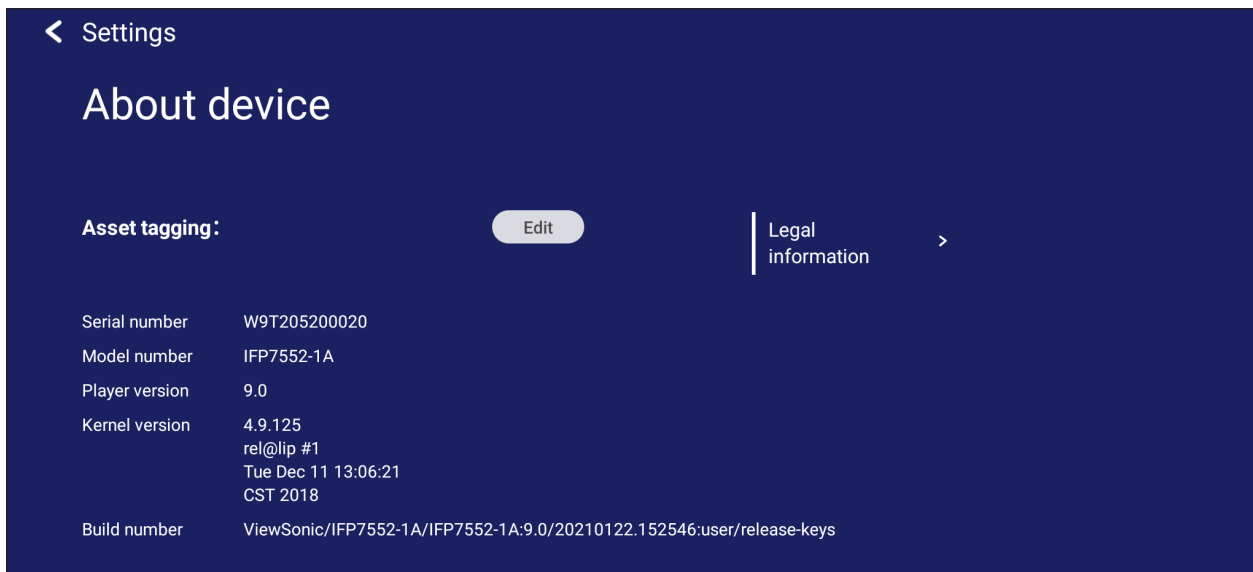

- By selecting **Edit**, the asset information can be adjusted.

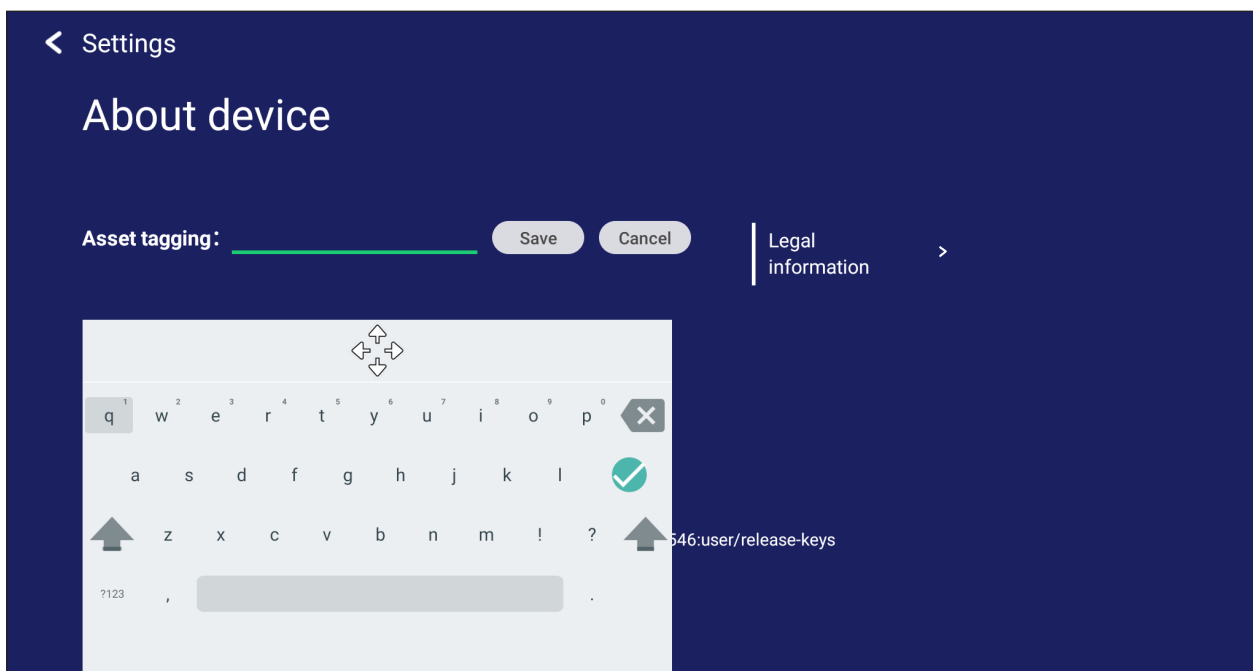

- Tap on **Legal information** to check open source licenses.



> Embedded Applications and Settings

Embedded Digital Whiteboarding App

Within ViewBoard, ViewSonic offers the embedded digital whiteboarding app, Whiteboard.











Whiteboard

Floating Bar

		Move the Floating Bar.	
		Switch between presentation and preparation modes.	
		Paste from the clipboard onto the canvas.	
		Click to open the web browser	
		Go to the previous canvas.	1. New Whiteboard File 2. Open File 3. Save File
		Go to the next canvas.	
		Add a new canvas.	

Toolbar

		Full Screen Capture	
		Toolbar Move Button	Select and hold to move the toolbar to the left side, right side, or bottom of the screen.
		File Button	
			
		1. New Whiteboard File 2. Open File 3. Save File	4. Save as File 5. Export
		Import resources (image, video, audio, etc.) to the whiteboard.	
		Infinite Canvas Button	Select – Use two hands to zoom in/out on/of the working panel.
		Selection Button	Select objects, text, and pictures to get other tools.
		Pen Button	Writing tools, changing colors, transparency, thickness, etc.
		Eraser to erase objects or clear the page.	
		Shape/Line Button	Create shapes, select shape colors, insert arrows.
		Text Box	Creates a Text box.

		Undo Button	Undo previous actions.
		Redo Button	Redo previous actions.
		Page Toggle Button	Select pages, sort pages, delete pages.
		Show or hide the current host information.	
		Whiteboard background management menu.	

ViewBoard Cast

Working with ViewBoard® Cast software, the vCastReceiver app, will allow the ViewBoard® to receive vCastSender laptop screens (Windows/Mac/Chrome) and mobile (iOS/Android) users' screens, photos, videos, annotations, and camera(s).

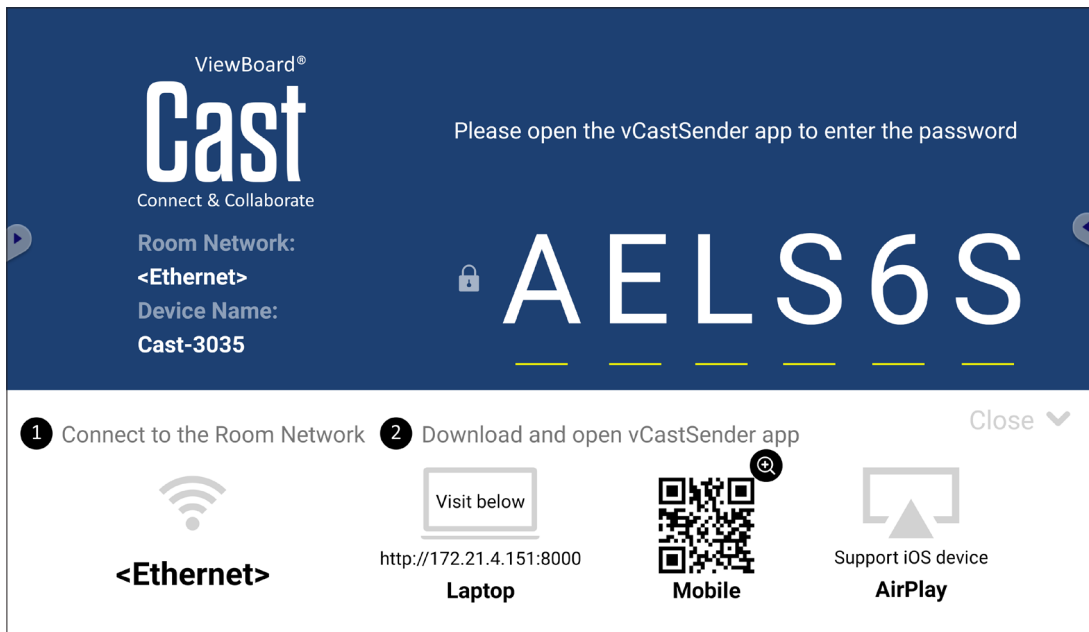

Network Information

- ViewBoard® Cast software, laptops, and mobile devices can connect to both the same subnet and across the subnet network.
- Connected devices will show up under “Device List” on the same subnet connection.
- If the device does not show up under “Device List”, users will need to key-in the on-screen PIN-code.

ViewBoard Cast is a wireless peer to peer data communication, therefore the below port settings are required:

Ports:

- CP: 56789, 25123, 8121, and 8000
- UDP: 48689 and 25123

Port and DNS activation:

- Port: 8001
- DNS: h1.ee-share.com

Cast Sender from Windows-based, Macbook, and Chrome devices.

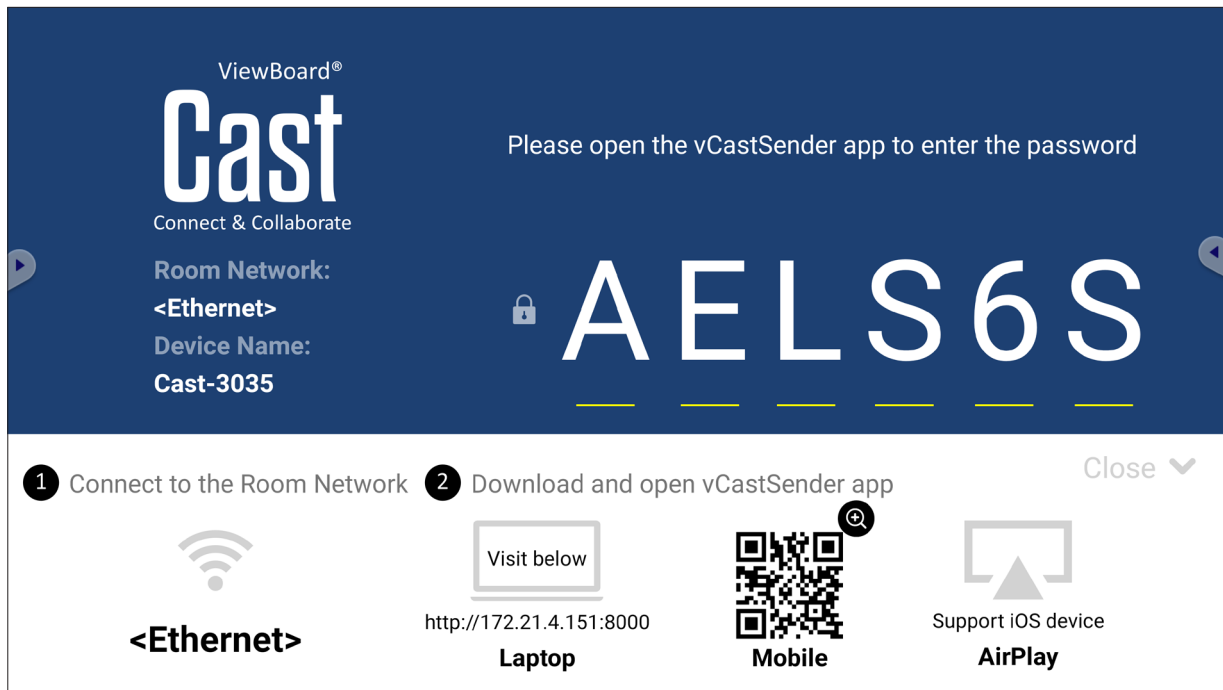

Mac, Windows, Chrome Devices:

1. Make sure your device is connected to the same network as the ViewBoard.
2. Visit the address that is shown on the ViewBoard to download the application.
3. Launch the application and enter the PIN Code or click Device List, then click the connect icon next to the Device Name.

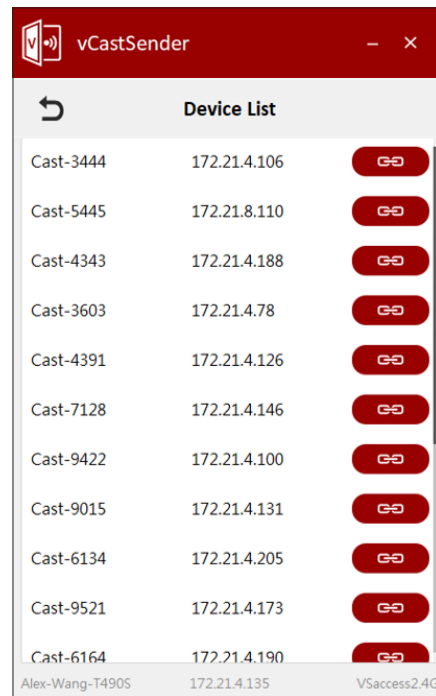
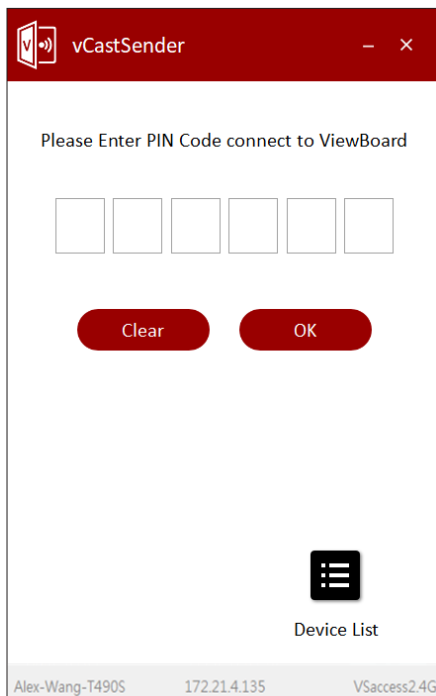

Cast Sender from Mobile Devices: iOS-based (iPhone, iPad) and Android OS based phone/tablet.

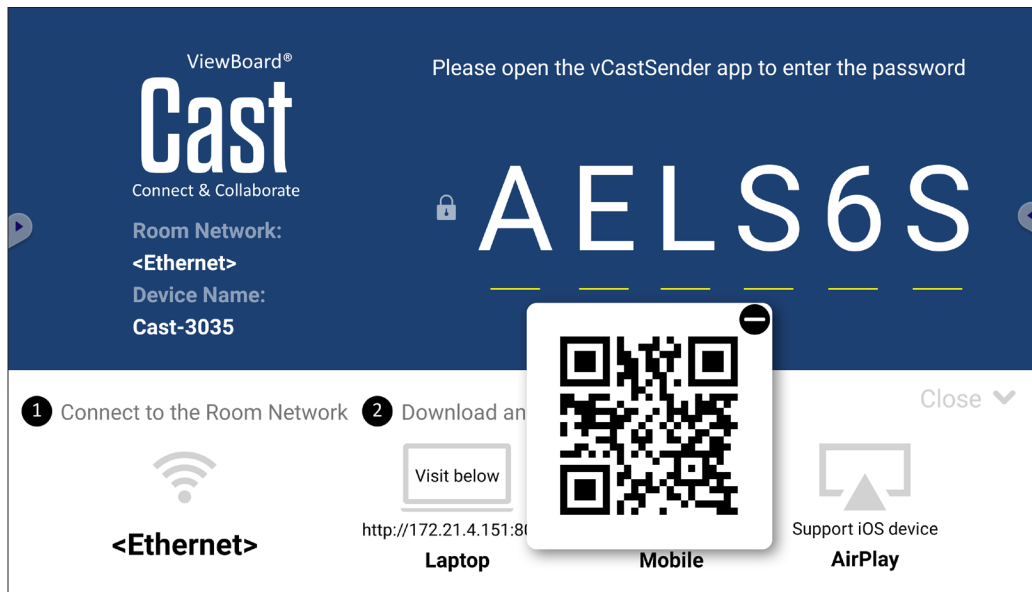

Android/iOS:

1. Make sure your device is connected to the same network as the ViewBoard.
2. Scan the QR Code that is shown on the ViewBoard to download directly from the server, or download from the Google Play Store or the Apple Store.
3. Launch the application and select the correct Device Name and input the pin to connect. You can also directly input the pin-code displayed on the ViewBoard to connect.

Apple AirPlay®:

1. Make sure your device is connected to the same network as the ViewBoard.
2. Directly open AirPlay and select the Device Name to connect.
3. Another "AirPlay Password" will be generated on-screen for connection.

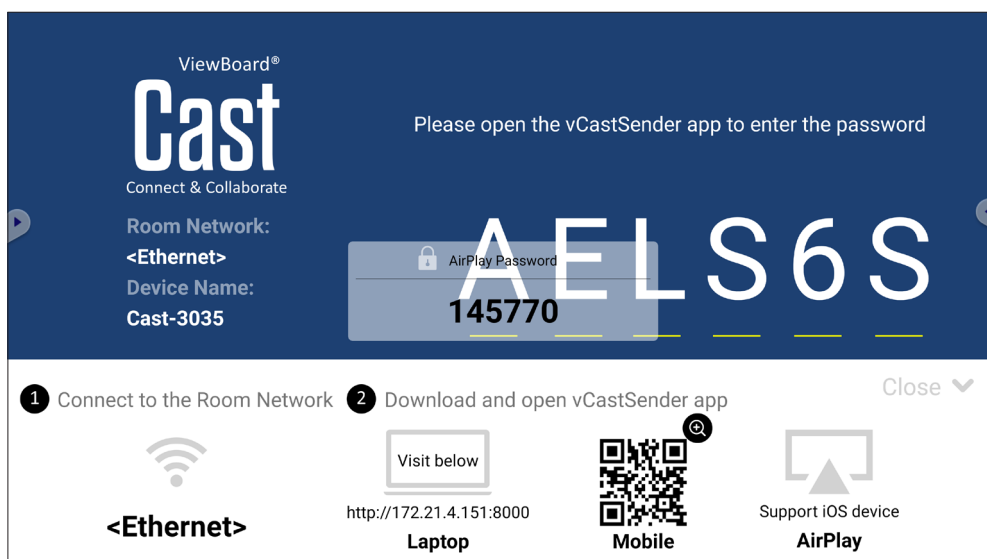

Screen Recorder

Capture everything that is displayed on screen in a video format.

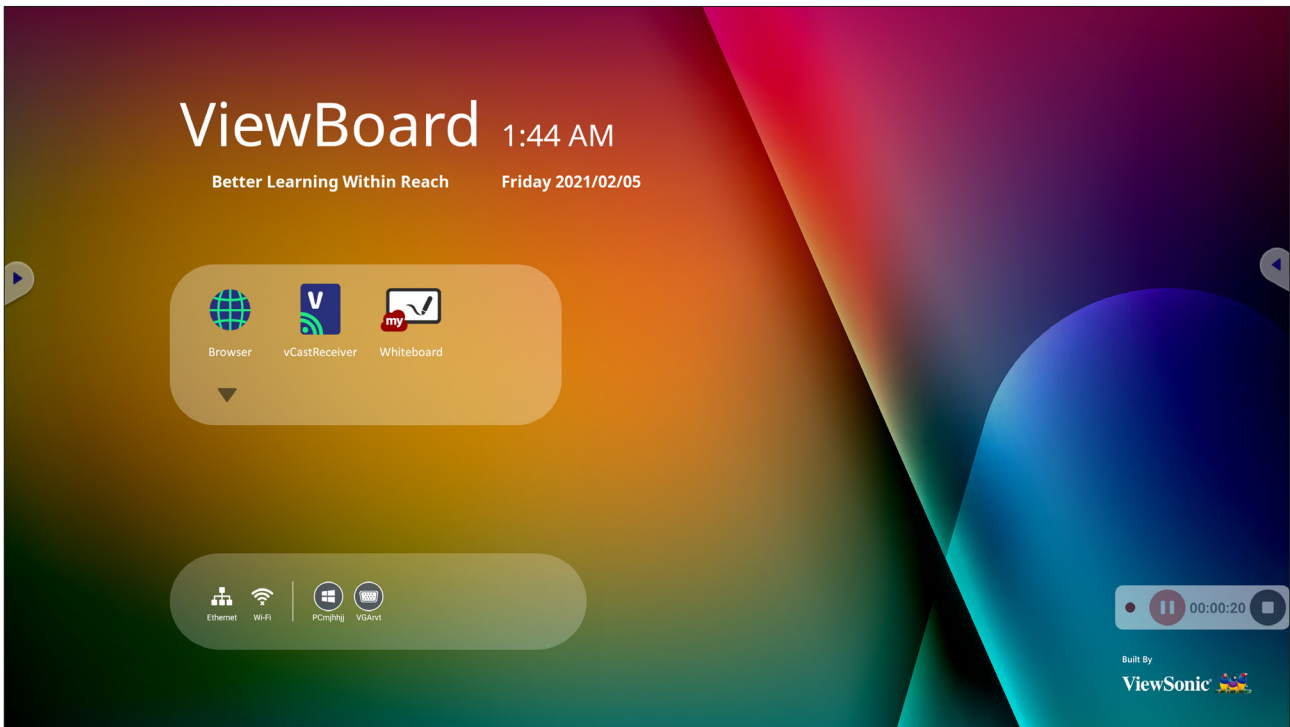

To launch the Screen Recorder application:

1. Select the Screen Recorder icon in the application drawer.
2. Tap the record icon  and select the preferred recording configurations. Then tap the check mark.

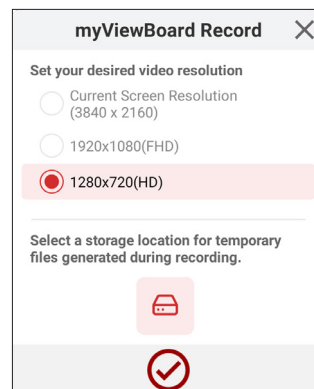

3. Select *Start Now* and a three (3) second countdown will begin. Screen recording will begin immediately after the countdown.
4. After stopping the recording, you will be able to preview the video, save it, or discard it.

Other Default Applications

vSweeper

Clear unnecessary data and unwanted files.

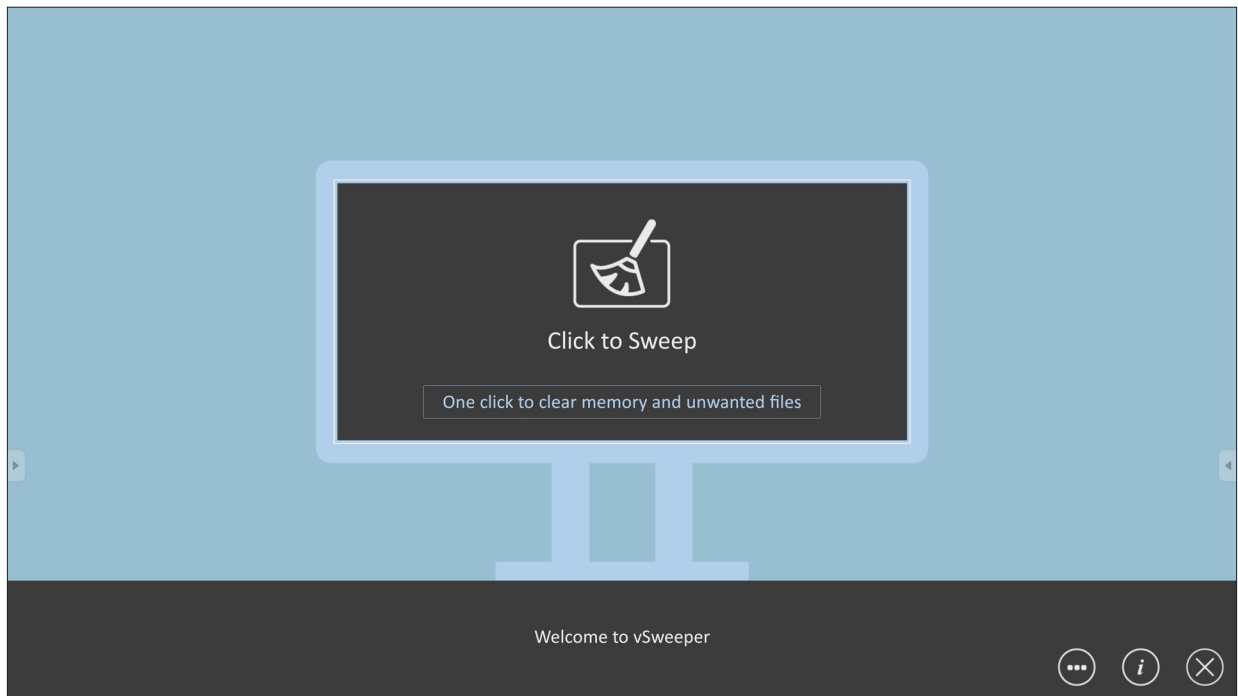

Advanced Settings can also be customized to the user's needs.

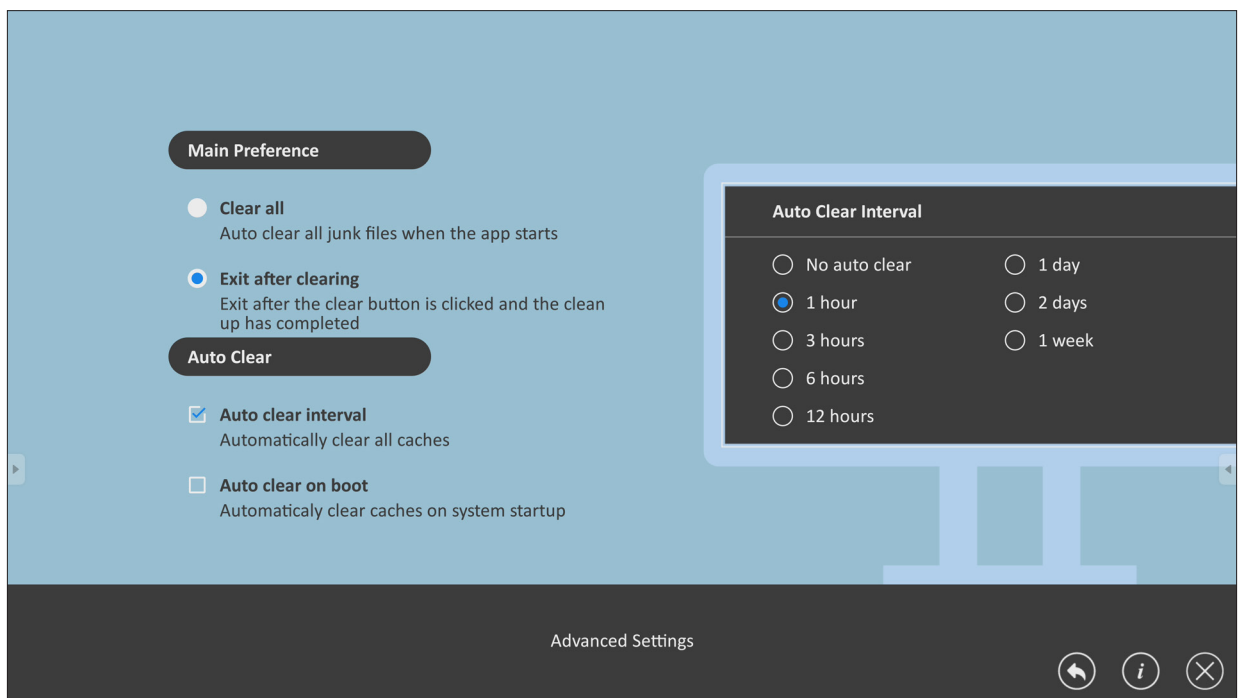

Screen Lock

Set a screen lock password and enable screen lock.

NOTE: If the user forgets the password, use the remote control and press **INPUT-0-2-1-4** to restore the password to default.

To set a screen lock password:

1. Go to: Settings > Protection > Password for screen lock, or select the Screen Lock icon in the apps list.

NOTE: If you select the Screen Lock icon and no password has been set, the below prompt will appear:

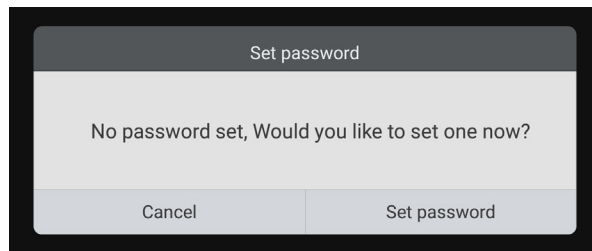

2. Select Set Password, and input a new four (4) digit password. Then select **OK**.

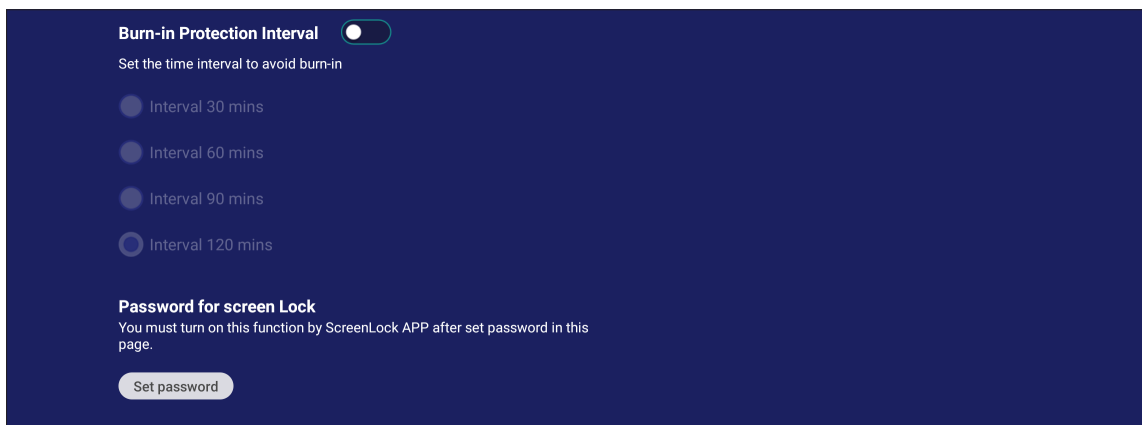

3. Now when selecting the Screen Lock icon, the screen will be locked.

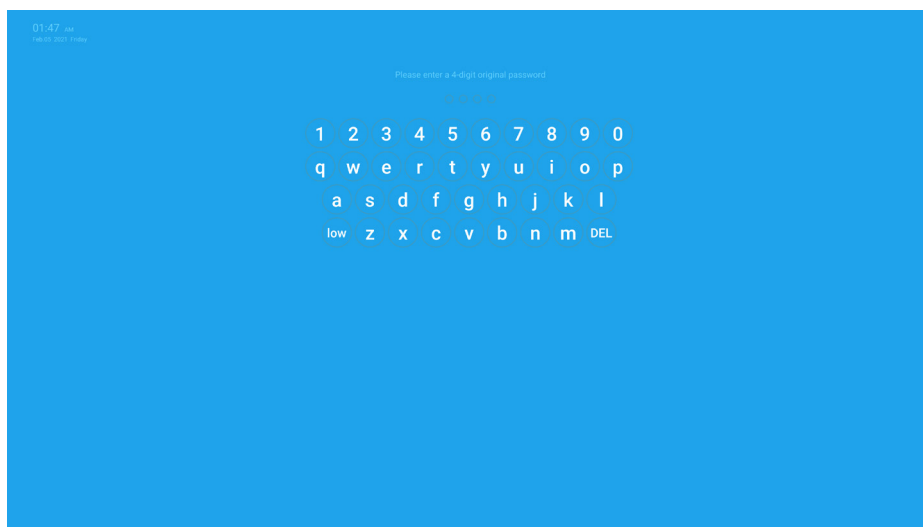

Chromium

Web browser for surfing the Internet.

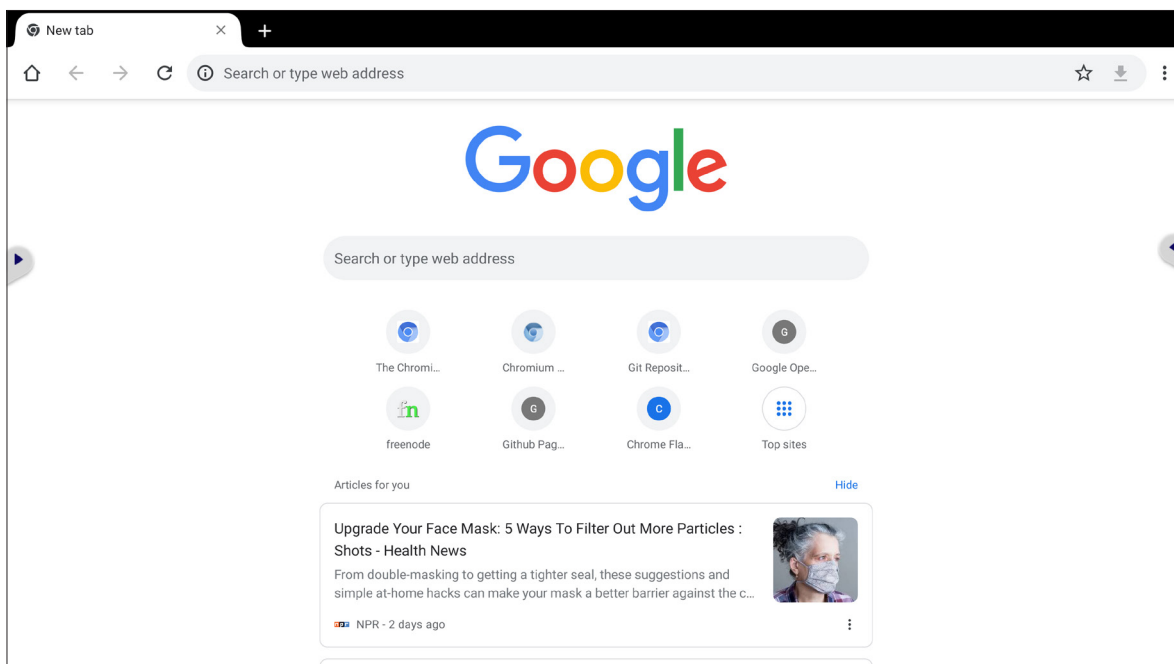

Folders

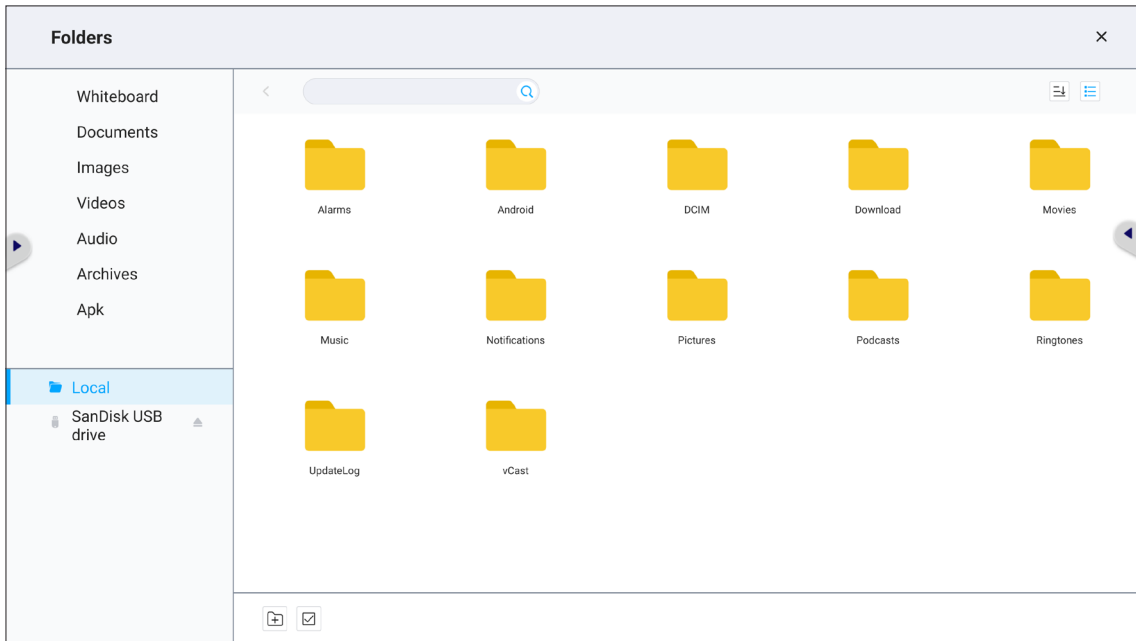

1. Storage Device Display

Select the appropriate storage device.

2. Icons

Item	Description
Exit	Click to exit.
Thumbnail	Click to display file by thumbnail mode.
List	Click to display file by list mode.
Select	Click to select file.
Add Folder	Click to add folder.
Copy	Click to copy file.
Paste	Click to paste file.
Cut	Click to cut file.
Delete	Click to delete file.
Rename	Click to rename file.
Cancel	Click to cancel.

3. File Type Menu

Item	Description
Whiteboard	Interactive whiteboard files
Documents	Office files
Images	Image files
Videos	Video files
Audio	Audio files
Archives	Compressed file
Apk	Apk files

> RS-232 Protocol

This document describes the hardware interface spec and software protocols of the RS-232 interface communication between ViewSonic LFD and a PC or other control units with RS-232 protocol.

The protocol contains three command sections:

- Set-Function
- Get-Function
- Remote control pass-through mode

NOTE: Below, “PC” represents all the control units that can send or receive the RS-232 protocol command.

Description

RS-232 Hardware Specification

ViewSonic LFD communication port on the rear side:

1. Connector type: DSUB 9-Pin Male (female or 3.5 mm barrel connector)
2. Use of crossover (null modem) cable for connection
3. Pin Assignment:

Male DSUB 9-Pin
(preferred)

1 2 3 4 5



6 7 8 9

Female DSUB 9-Pin

5 4 3 2 1



9 8 7 6

3.5 mm barrel
connector (alternative
for limited space)



Pin #	Signal	Remark
1	NC	
2	RXD	Input to Display
3	TXD	Output from Display
4	NC	
5	GND	
6	NC	
7	NC	
8	NC	
9	NC	
frame	GND	

Item	Signal	Remark
Tip	TXD	Output from Display
Ring	RXD	Input to Display
Sleeve	GND	

LAN Hardware Specification

ViewSonic LFD communication port on the rear side:

1. Connector type: 8P8C RJ45
2. Pin Assignment:

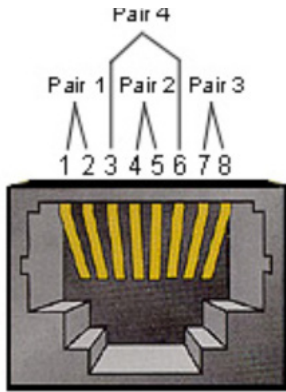

Pin #	Signal	Remark
1	TX+	Output from Display
2	TX-	Output from Display
3	RX+	Input to Display
4	BI_D3+	For 1G case
5	BI_D3-	For 1G case
6	RX-	Input to Display
7	BI_D4+	For 1G case
8	BI_D4-	For 1G case
frame	GND	

RS-232 Communication Setting

- Baud Rate Select: 9600bps (fixed)
- Data bits: 8 bits (fixed)
- Parity: None (fixed)
- Stop Bits: 1(fixed)

LAN Communication Setting

- Type: Ethernet
- Protocol: TCP/IP
- Port: 5000 (fixed)
- WOL Port: 9 (fixed) for UDP ^{*3.2.0}
- Cross subnet: No
- Logon Credentials: No

Command Message Reference

PC sends to LFD command packet followed by “CR”. Every time PC sends control command to Display, the Display shall respond as follows:

1. If the message is received correctly it will send “+” (02Bh) followed by “CR” (00Dh)
2. If the message is received incorrectly it will send “-” (02Dh) followed by “CR” (00Dh)

Protocol

Set-Function Listing

The PC can control the Display for specific actions. The Set-Function command allows you to control the Display behavior at a remote site through the RS-232 port. The Set-Function packet format consists of 9 bytes.

Set-Function Description:

- Length:** Total Byte of Message excluding "CR"
- LFD ID** Identification for each of Display (01~98; default is 01)
ID "99" means to apply the set command for all connected displays. Under such circumstances, only ID#1 display has to reply.
The LFD ID can be set via the OSD menu for each Display.
- Command Type** Identify command type,
"s" (0x73h): Set Command
"+" (0x2Bh): Valid command Reply
"- " (0x2Dh): Invalid command Reply
- Command:** Function command code: One byte ASCII code.
- Value[1~3]:** Three bytes ASCII that defines the value.
- CR** 0x0D

Set-Function Format

Send: (Command Type="s")

Name	Length	ID	Command Type	Command	Value1	Value2	Value3	CR
Byte Count	1 Byte	2 Byte	1 Byte	1 Byte	1 Byte	1 Byte	1 Byte	1 Byte
Bytes order	1	2~3	4	5	6	7	8	9

Reply: (Command Type="+" or "-")

Name	Length	ID	Command Type	CR
Byte Count	1 Byte	2 Byte	1 Byte	1 Byte
Bytes order	1	2~3	4	5

NOTE: When PC applies command to all displays (ID=99), only the #1 set needs to reply by the name of ID=1.

Example 1: Set Brightness as 76 for Display (#02) and this command is valid

Send (Hex Format)

Name	Length	ID	Command Type	Command	Value1	Value2	Value3	CR
Hex	0x38	0x30 0x32	0x73	0x24	0x30	0x37	0x36	0x0D

Reply (Hex Format)

Name	Length	ID	Command Type	CR
Hex	0x34	0x30 0x32	0x2B	0x0D

Example 2: Set Brightness as 75 for Display (#02) and this command is NOT valid

Send (Hex Format)

Name	Length	ID	Command Type	Command	Value1	Value2	Value3	CR
Hex	0x38	0x30 0x32	0x73	0x24	0x30	0x37	0x35	0x0D

Reply (Hex Format)

Name	Length	ID	Command Type	CR
Hex	0x34	0x30 0x32	0x2D	0x0D

Set-Function Table

A. Basic Function

Set Function	Length	ID	Command	Command		Value Range	Comments
				Type (ASCII)	Code (ASCII)		
Power on *3.2.1/ off (standby)	8		s	!	21	000: STBY 001: ON	1. The Power-on via LAN control may work only under specific mode. To see display UG for details. *3.1.1 2. "WOL by MAC address" may available as alternative.*3.2.1
Input Select	8		s	"	22	004: HDMI1 014: HDMI2 024: HDMI 006: VGA 007: Slot-in PC (OPS) 009: DP 019: Type-C *3.2.4 00A: Embedded/ Main (Android)	1. No need for USB 2. For the case of two more same sources, the 2nd digital is used to indicate the extension. 3. The HEX of 00A is 30 30 41.
Brightness	8		s	\$	24	000 ~ 100 900: Bright down (-1) 901: Bright up (+1) *3.1.1	
Backlight *3.2.0	8		A	B	42	000 ~ 100	1. For Android platform whose main mode is controlled by backlight and the other sources are controlled by brightness. 2. Derived from Color calibration. *3.2.0
Power lock	8		s	4	34	000: Unlock 001: Lock	*See note in details
Volume	8		s	5	35	000 ~ 100 900: Volume down(-1) 901:Volume up(+1)	
Mute	8		s	6	36	000: OFF 001: ON (mute)	
Button lock	8		s	8	38	000: Unlock 001: Lock	*See note in details
Menu lock	8		s	>	3E	000: Unlock 001: Lock	*See note in details

Set Function	Length	ID	Command	Command	Value Range	Comments	
Number *3.1.1	8		s	@	40	000~009	
Key Pad *3.1.1	8		s	A	41	000: UP 001: DOWN 002: LEFT 003: RIGHT 004: ENTER 005: INPUT 006: MENU/(EXIT) 007: EXIT	
Remote Control	8		s	B	42	000: Disable 001: Enable 002: Pass through	Disable: RCU will be no function Enabled: RCU controls normally Pass through: Display will bypass the RC code to connected device via the RS-232 port, but not react itself.
Restore default	8		s	~	7E	000	Recover to factory setting

B. Optional Function

Set Function	Length	ID	Command	Command		Value Range (Three ASCII bytes)	Comments
				Type (ASCII)	Code (ASCII) Code (Hex)		
Contrast	8		s	#	23	000 ~ 100	
Sharpness	8		s	%	25	000 ~ 100	
Color	8		s	&	26	000 ~ 100	
Tint	8		s	'	27	000 ~ 100	
Backlight On_Off *3.2.3	8		s	(29	000: Off 001: On	
Color mode	8		s)	29	000: Normal 001: Warm 002: Cold 003: Personal	
Freeze On_Off *3.2.5	8		s	*	2A	000: Off 001: On	
Bass	8		s	.	2E	000 ~ 100	
Treble	8		s	/	2F	000 ~ 100	
Balance	8		s	0	30	000 ~ 100	050 is central
Picture Size	8		s	1	31	000: FULL (16:9) 001: NORMAL (4:3) 002: REAL (1:1) *3.1.0	
OSD language	8		s	2	32	000: English 001: French 002: Spanish	Could be extended for more supported languages by model
Date: Year	8		s	V	56	Y17~Y99	Last 2 digits (20)17~(20)99
Date: Month	8		s	V	56	M01~M12	2 digits
Date: Day	8		s	V	56	D01~D31	2 digits
Time: Hour	8		s	W	57	H00~H23	24-hr format. 2 digits.
Time: Min	8		s	W	57	M00~M59	2 digits
Time: Sec	8		s	W	57	S00~S59	2 digits
Customized Hot Keys *3.2.6	8		s	X	58	001~999 001: Open MVBA app *3.2.6	

> Appendix

Specifications

Item	Category	Specifications
Model	P/N.	IFP4320
	No.	VS18454
Screen Size		43"
Input Signal		1 x HDMI 1 x VGA 1 x DisplayPort 1 x USB Type-C 1 x DVI 1 x Audio In 1 x LAN (RJ45) 2 x USB Type-A (2.0)
Output Signal		1 x Audio Out 1 x SPDIF 1 x USB Type-B
Speaker Output		10W x 2
RS-232		RS-232 Communication
Power	Voltage	100V-240V AC 50/60Hz
Operating Conditions	Temperature	32° F to 104° F (0° C to 40° C)
	Humidity	20%~80% non-condensing
	Altitude	< 2,000 m
Storage Conditions	Temperature	14° F to 140° F (-10° C to 60° C)
	Humidity	10%~80% non-condensing
	Altitude	< 2,000 m
Dimensions	Physical W x H x D (mm)	967 x 558.1 x 55.7
	Physical W x H x D (in)	38.072 x 21.973 x 2.193
Weight	Physical (kg)	17.83
	Physical (lbs)	39.3
Power Consumption	On	120W (Typ.)
	Off	<0.5W

NOTE: Product specifications are subject to change without notice.

Display Modes

VGA Mode

Resolution	Refresh Rate (@)
640 x 480	60Hz, 72Hz, 75Hz
720 x 400	70Hz
800 x 600	56Hz, 60Hz, 72Hz, 75Hz
832 x 624	75Hz
1024 x 768	60Hz, 70Hz, 75Hz
1600 x 1200	60Hz
1920 x 1080	60Hz
1920 x 1200	60Hz

HDMI/DisplayPort/Type-C Mode

Resolution	Refresh Rate (@)
480i	60Hz ¹
576i	50Hz ¹
480p	60Hz
576p	50Hz
720p	60Hz
1080i	50Hz, 60Hz
1080p	30Hz, 50Hz, 60Hz
4K	25, 30, 50, 60Hz

¹ Not supported by DisplayPort.

Troubleshooting

This section describes some common problems that you may experience when using the ViewBoard.

Problem or Issue	Possible Solutions
Remote Control is not working	<ol style="list-style-type: none">1. Check whether something is obstructing the display's remote control receiver.2. Check whether the batteries in the remote control are installed correctly.3. Check whether the batteries need to be replaced.
The unit turns off unexpectedly	<ol style="list-style-type: none">1. Check whether Sleep mode is enabled.2. Check if there is a power outage in your area.3. Turn on the display and see if the problem is with the signal and control system.

PC Mode

Problem or Issue	Possible Solutions
No PC signal	<ol style="list-style-type: none">1. Check the display settings.2. Check the display resolution.3. Adjust the Hs & Vs (synchronization) settings using the OSD menu.
Background streaking	<ol style="list-style-type: none">1. Choose auto adjust.2. Adjust clock and phase.
False color	<ol style="list-style-type: none">1. Check the VGA connection.2. Adjust the chroma, brightness, and contrast settings.
Unsupported format	<ol style="list-style-type: none">1. Choose auto adjust.2. Adjust clock and phase settings.

Touch Function

Problem or Issue	Possible Solutions
Touch function does not work	<ol style="list-style-type: none">1. Check that drivers are installed correctly.2. Reinstall driver(s).3. Check setup and align it.4. Check whether the touch pen is working properly.

Video Not Working Properly

Problem or Issue	Possible Solutions
No picture/ No sound	<ol style="list-style-type: none">1. Check the Power status.2. Check the signal cable.3. Check that the internal PC is installed correctly.
Picture is unclear or cuts in and out	<ol style="list-style-type: none">1. Check the signal cable.2. Check if other electronics are interrupting the signal.
Poor picture	<ol style="list-style-type: none">1. Adjust chroma, brightness, and contrast settings in the menu.2. Check the signal cable.

Audio Not Working Properly

Problem or Issue	Possible Solutions
No sound	<ol style="list-style-type: none">1. Press the Mute/Unmute button.2. Adjust the volume.3. Check the audio cable.
One speaker only	<ol style="list-style-type: none">1. Adjust the sound balance in the menu.2. Check the sound control panel settings of the computer.3. Check the audio cable. <p>NOTE: SPDIF and Earphone only work in ViewBoard Player, HDMI, Type-C, and DisplayPort (DP) channels.</p>

Maintenance

General Precautions

- Make sure the device is turned off and the power cable is unplugged from the power outlet.
- Never spray or pour any liquid directly onto the screen or case.
- Handle the device with care, as a darker-colored device, if scuffed, may show marks more clearly than a lighter-colored device.
- Do not use the system continuously for long periods of time.

Cleaning the Screen

- Wipe the screen with a clean, soft, lint-free cloth. This removes dust and other particles.
- If the screen is still not clean, apply a small amount of non-ammonia, non-alcohol based glass cleaner onto a clean, soft, lint-free cloth; then wipe the screen.

Cleaning the Case

- Use a soft, dry cloth.
- If the case is still not clean, apply a small amount of non-ammonia, non-alcohol based, mild non-abrasive detergent onto a clean, soft, lint-free cloth, then wipe the surface.

Disclaimer

- ViewSonic® does not recommend the use of any ammonia or alcohol-based cleaners on the display screen or case. Some chemical cleaners have been reported to damage the screen and/or case of the device.
- ViewSonic® will not be liable for damage resulting from use of any ammonia or alcohol-based cleaners.

NOTE: If condensation appears between the glass and the panel, keep the display turned on until the moisture disappears.

> Regulatory and Service Information

Compliance Information

This section addresses all connected requirements and statements regarding regulations. Confirmed corresponding applications shall refer to nameplate labels and relevant markings on the unit.

FCC Compliance Statement

This device complies with part 15 of FCC Rules. Operation is subject to the following two conditions: (1) this device may not cause harmful interference, and (2) this device must accept any interference received, including interference that may cause undesired operation. This equipment has been tested and found to comply with the limits for a Class B digital device, pursuant to part 15 of the FCC Rules.

These limits are designed to provide reasonable protection against harmful interference in a residential installation. This equipment generates, uses, and can radiate radio frequency energy, and if not installed and used in accordance with the instructions, may cause harmful interference to radio communications. However, there is no guarantee that interference will not occur in a particular installation. If this equipment does cause harmful interference to radio or television reception, which can be determined by turning the equipment off and on, the user is encouraged to try to correct the interference by one or more of the following measures:

- Reorient or relocate the receiving antenna.
- Increase the separation between the equipment and receiver.
- Connect the equipment into an outlet on a circuit different from that to which the receiver is connected.
- Consult the dealer or an experienced radio/TV technician for help.

Warning: You are cautioned that changes or modifications not expressly approved by the party responsible for compliance could void your authority to operate the equipment.

Industry Canada Statement

CAN ICES-003(B)/NMB-003(B)

CE Conformity for European Countries



The device complies with the EMC Directive 2014/30/EU and Low Voltage Directive 2014/35/EU.

The following information is only for EU-member states:

The mark shown to the right is in compliance with the Waste Electrical and Electronic Equipment Directive 2012/19/EU (WEEE). The mark indicates the requirement NOT to dispose of the equipment as unsorted municipal waste, but use the return and collection systems according to local law.



Declaration of RoHS2 Compliance

This product has been designed and manufactured in compliance with Directive 2011/65/EU of the European Parliament and the Council on restriction of the use of certain hazardous substances in electrical and electronic equipment (RoHS2 Directive) and is deemed to comply with the maximum concentration values issued by the European Technical Adaptation Committee (TAC) as shown below:

Substance	Proposed Maximum Concentration	Actual Concentration
Lead (Pb)	0.1%	< 0.1%
Mercury (Hg)	0.1%	< 0.1%
Cadmium (Cd)	0.01%	< 0.01%
Hexavalent Chromium (Cr6 ⁺)	0.1%	< 0.1%
Polybrominated biphenyls (PBB)	0.1%	< 0.1%
Polybrominated diphenyl ethers (PBDE)	0.1%	< 0.1%
Bis (2-ethylhexyl) phthalate (DEHP)	0.1%	< 0.1%
Butyl benzyl phthalate (BBP)	0.1%	< 0.1%
Dibutyl phthalate (DBP)	0.1%	< 0.1%
Diisobutyl phthalate (DIBP)	0.1%	< 0.1%

Certain components of products as stated above are exempted under the Annex III of the RoHS2 Directives as noted below:

- Lead as an alloying element in aluminium containing up to 0.4% lead by weight.
- Copper alloy containing up to 4% lead by weight.
- Lead in high melting temperature type solders (i.e., lead-based alloys containing 85% by weight or more lead).
- Electrical and electronic components containing lead in a glass or ceramic other than dielectric ceramic in capacitors, (e.g., piezoelectronic devices, or in a glass or ceramic matrix compound).

ENERGY STAR® statement

ENERGY STAR® is a U.S. Environmental Protection Agency voluntary program that helps businesses and individuals save money and protect our climate through superior energy efficiency. Products that earn the ENERGY STAR® prevent greenhouse gas emissions by meeting strict energy efficiency criteria or requirements set by the U.S. Environmental Protection Agency.

As an ENERGY STAR® Partner, ViewSonic is determined to meet the ENERGY STAR® Guidelines and mark all certified models with the ENERGY STAR® logo.

The following logo appears on all ENERGY STAR®-certified models:



NOTE: The power management features significantly reduce energy consumption when the product is not in use. Power management allows the device to automatically enter a low power “sleep” mode after a defined period of inactivity. And the power management features also enter Sleep Mode or Off Mode within 5 minutes of being disconnected from a host computer. Please note any change in energy settings will increase energy consumption.

Indian Restriction of Hazardous Substances

Restriction on Hazardous Substances statement (India). This product complies with the “India E-waste Rule 2011” and prohibits use of lead, mercury, hexavalent chromium, polybrominated biphenyls or polybrominated diphenyl ethers in concentrations exceeding 0.1 weight % and 0.01 weight % for cadmium, except for the exemptions set in Schedule 2 of the Rule.

Product Disposal at End of Product Life

ViewSonic® respects the environment and is committed to working and living green. Thank you for being part of Smarter, Greener Computing. Please visit the ViewSonic® website to learn more.

USA & Canada:

<http://www.viewsonic.com/company/green/recycle-program/>

Europe:

<http://www.viewsoniceurope.com/eu/support/call-desk/>

Taiwan:

<https://recycle.epa.gov.tw/>

Copyright Information

Copyright© ViewSonic® Corporation, 2021. All rights reserved.

Macintosh and Power Macintosh are registered trademarks of Apple Inc.

Microsoft, Windows, and the Windows logo are registered trademarks of Microsoft Corporation in the United States and other countries.

ViewSonic®, the three birds logo, OnView, ViewMatch, and ViewMeter are registered trademarks of ViewSonic® Corporation.

VESA is a registered trademark of the Video Electronics Standards Association. DPMS, DisplayPort, and DDC are trademarks of VESA.

Disclaimer: ViewSonic® Corporation shall not be liable for technical or editorial errors or omissions contained herein; nor for incidental or consequential damages resulting from furnishing this material, or the performance or use of this product.

In the interest of continuing product improvement, ViewSonic® Corporation reserves the right to change product specifications without notice. Information in this document may change without notice.

No part of this document may be copied, reproduced, or transmitted by any means, for any purpose without prior written permission from ViewSonic® Corporation.

Customer Service

For technical support or product service, see the table below or contact your reseller.

NOTE: You will need the product's serial number.

Country/ Region	Website	Country/ Region	Website
Asia Pacific & Africa			
Australia	www.viewsonic.com/au/	Bangladesh	www.viewsonic.com/bd/
中国 (China)	www.viewsonic.com.cn	香港 (繁體中文)	www.viewsonic.com/hk/
Hong Kong (English)	www.viewsonic.com/hk-en/	India	www.viewsonic.com/in/
Indonesia	www.viewsonic.com/id/	Israel	www.viewsonic.com/il/
日本 (Japan)	www.viewsonic.com/jp/	Korea	www.viewsonic.com/kr/
Malaysia	www.viewsonic.com/my/	Middle East	www.viewsonic.com/me/
Myanmar	www.viewsonic.com/mm/	Nepal	www.viewsonic.com/np/
New Zealand	www.viewsonic.com/nz/	Pakistan	www.viewsonic.com/pk/
Philippines	www.viewsonic.com/ph/	Singapore	www.viewsonic.com/sg/
臺灣 (Taiwan)	www.viewsonic.com/tw/	ประเทศไทย	www.viewsonic.com/th/
Việt Nam	www.viewsonic.com/vn/	South Africa & Mauritius	www.viewsonic.com/za/
Americas			
United States	www.viewsonic.com/us	Canada	www.viewsonic.com/us
Latin America	www.viewsonic.com/la		
Europe			
Europe	www.viewsonic.com/eu/	France	www.viewsonic.com/fr/
Deutschland	www.viewsonic.com/de/	Қазақстан	www.viewsonic.com/kz/
Россия	www.viewsonic.com/ru/	España	www.viewsonic.com/es/
Türkiye	www.viewsonic.com/tr/	Україна	www.viewsonic.com/ua/
United Kingdom	www.viewsonic.com/uk/		

Limited Warranty

ViewSonic® Smart White Board

What the warranty covers:

ViewSonic® warrants its products to be free from defects in material and workmanship during the warranty period. If a product proves to be defective in material or workmanship during the warranty period, ViewSonic® will, at its sole option, and as your sole remedy, repair or replace the product with a similar product. Replacement Product or parts may include remanufactured or refurbished parts or components. The repair or replacement unit or parts or components will be covered by the balance of the time remaining on the customer's original limited warranty and the warranty period will not be extended. ViewSonic® provides no warranty for any third-party software whether included with the product or installed by the customer, installation of any unauthorized hardware parts or components (e.g. Projector Lamps). (Please refer to: "What the warranty excludes and does not cover" section).

Who the warranty protects:

This warranty is valid only for the first consumer purchaser.

What the warranty excludes and does not cover:

- Any product on which the serial number has been defaced, modified, or removed.
- Damage, deterioration, or malfunction resulting from:
 - » Accident, misuse, neglect, fire, water, lightning, or other acts of nature, unauthorized product modification, or failure to follow instructions supplied with the product.
 - » Repair or attempted repair by anyone not authorized by ViewSonic®.
 - » Damage to or loss of any programs, data, or removable storage media.
 - » Normal wear and tear.
 - » Removal or installation of the product.
- Software or data loss occurring during repair or replacement.
- Any damage of the product due to shipment.
- Causes external to the product, such as electric power fluctuations or failure.
- Use of supplies or parts not meeting ViewSonic's specifications.
- Failure of owner to perform periodic product maintenance as stated in the User Guide.
- Any other cause which does not relate to a product defect.

- Damage caused by static (non-moving) images displayed for lengthy periods of time (also referred to as image burn-in).
- Software - Any third-party software included with the product or installed by the customer.
- Hardware/Accessories/Parts/Components – Installation of any unauthorized hardware, accessories, consumable parts or components (e.g. Projector Lamps).
- Damage to, or abuse of, the coating on the surface of the display through inappropriate cleaning as described in the product User Guide.
- Removal, installation, and set-up service charges, including wall-mounting of the product.

How to get service:

- For information about receiving service under warranty, contact ViewSonic® Customer Support (Please refer to the “Customer Service” page). You will need to provide your product’s serial number.
- To obtain warranty service, you will be required to provide: (a) the original dated sales slip, (b) your name, (c) your address, (d) a description of the problem, and (e) the serial number of the product.
- Take or ship the product, freight prepaid, in the original container to an authorized ViewSonic® service center or ViewSonic®.
- For additional information or the name of the nearest ViewSonic® service center, contact ViewSonic®.

Limitation of implied warranties:

There are no warranties, express or implied, which extend beyond the description contained herein including the implied warranty of merchantability and fitness for a particular purpose.

Exclusion of damages:

ViewSonic's liability is limited to the cost of repair or replacement of the product. ViewSonic® shall not be liable for:

- Damage to other property caused by any defects in the product, damages based upon inconvenience, loss of use of the product, loss of time, loss of profits, loss of business opportunity, loss of goodwill, interference with business relationships, or other commercial loss, even if advised of the possibility of such damages.
- Any other damages, whether incidental, consequential or otherwise.
- Any claim against the customer by any other party.
- Repair or attempted repair by anyone not authorized by ViewSonic®.

Effect of state law:

This warranty gives you specific legal rights, and you may also have other rights which vary from state to state. Some states do not allow limitations on implied warranties and/or do not allow the exclusion of incidental or consequential damages, so the above limitations and exclusions may not apply to you.

Sales outside the U.S.A. and Canada:

For warranty information and service on ViewSonic® products sold outside of the U.S.A. and Canada, contact ViewSonic® or your local ViewSonic® dealer.

The warranty period for this product in mainland China (Hong Kong, Macao, and Taiwan Excluded) is subject to the terms and conditions of the Maintenance Guarantee Card.

For users in Europe and Russia, full details of warranty provided can be found at: <http://www.viewsonic.com/eu/> under "Support/Warranty Information".

Mexico Limited Warranty

ViewSonic® Smart White Board

What the warranty covers:

ViewSonic® warrants its products to be free from defects in material and workmanship, under normal use, during the warranty period. If a product proves to be defective in material or workmanship during the warranty period, ViewSonic® will, at its sole option, repair or replace the product with a like product. Replacement product or parts may include remanufactured or refurbished parts or components & accessories.

Who the warranty protects:

This warranty is valid only for the first consumer purchaser.

What the warranty excludes and does not cover:

- Any product on which the serial number has been defaced, modified or removed.
- Damage, deterioration, or malfunction resulting from:
 - » Accident, misuse, neglect, fire, water, lightning, or other acts of nature, unauthorized product modification, unauthorized attempted repair, or failure to follow instructions supplied with the product.
 - » Causes external to the product, such as electrical power fluctuations or failure.
 - » Use of supplies or parts not meeting ViewSonic®'s specifications.
 - » Normal wear and tear.
 - » Any other cause which does not relate to a product defect.
- Any product exhibiting a condition commonly known as “image burn-in” which results when a static image is displayed on the product for an extended period of time.
- Removal, installation, insurance, and set-up service charges.

How to get service:

For information about receiving service under warranty, contact ViewSonic® Customer Support (Please refer to the attached “Customer Service” page). You will need to provide your product’s serial number, so please record the product information in the space provided below on your purchase for your future use. Please retain your receipt of proof of purchase to support your warranty claim.

For Your Records

Product Name: _____ Model Number: _____
Document Number: _____ Serial Number: _____
Purchase Date: _____ Extended Warranty Purchase? _____(Y/N)
If so, what date does warranty expire? _____

- To obtain warranty service, you will be required to provide (a) the original dated sales slip, (b) your name, (c) your address, (d) a description of the problem, and (e) the serial number of the product.
- Take or ship the product, in the original container packaging, to an authorized ViewSonic® service center.
- Round trip transportation costs for in-warranty products will be paid by ViewSonic®.

Limitation of implied warranties:

There are no warranties, express or implied, which extend beyond the description contained herein including the implied warranty of merchantability and fitness for a particular purpose.

Exclusion of damages:

ViewSonic®’s liability is limited to the cost of repair or replacement of the product. ViewSonic® shall not be liable for:

- Damage to other property caused by any defects in the product, damages based upon inconvenience, loss of use of the product, loss of time, loss of profits, loss of business opportunity, loss of goodwill, interference with business relationships, or other commercial loss, even if advised of the possibility of such damages.
- Any other damages, whether incidental, consequential or otherwise.
- Any claim against the customer by any other party.
- Repair or attempted repair by anyone not authorized by ViewSonic®.

Contact Information for Sales & Authorized Service (Centro Autorizado de Servicio) within Mexico:	
Name, address, of manufacturer and importers: México, Av. de la Palma #8 Piso 2 Despacho 203, Corporativo Interpalmas, Col. San Fernando Huixquilucan, Estado de México Tel: (55) 3605-1099 http://www.viewsonic.com/la/soporte/index.htm	
NÚMERO GRATIS DE ASISTENCIA TÉCNICA PARA TODO MÉXICO: 001.866.823.2004	
Hermosillo: Distribuciones y Servicios Computacionales SA de CV. Calle Juarez 284 local 2 Col. Bugambilias C.P: 83140 Tel: 01-66-22-14-9005 E-Mail: disc2@hmo.megared.net.mx	Villahermosa: Compumantenimientos Garantizados, S.A. de C.V. AV. GREGORIO MENDEZ #1504 COL, FLORIDA C.P. 86040 Tel: 01 (993) 3 52 00 47 / 3522074 / 3 52 20 09 E-Mail: compumantenimientos@prodigy.net.mx
Puebla, Pue. (Matriz): RENTA Y DATOS, S.A. DE C.V. Domicilio: 29 SUR 721 COL. LA PAZ 72160 PUEBLA, PUE. Tel: 01(52).222.891.55.77 CON 10 LINEAS E-Mail: datos@puebla.megared.net.mx	Veracruz, Ver.: CONEXION Y DESARROLLO, S.A DE C.V. Av. Americas # 419 ENTRE PINZÓN Y ALVARADO Fracc. Reforma C.P. 91919 Tel: 01-22-91-00-31-67 E-Mail: gacosta@qplus.com.mx
Chihuahua: Soluciones Globales en Computación C. Magisterio # 3321 Col. Magisterial Chihuahua, Chih. Tel: 4136954 E-Mail: Cefeo@soluglobales.com	Cuernavaca: Compusupport de Cuernavaca SA de CV Francisco Leyva # 178 Col. Miguel Hidalgo C.P. 62040, Cuernavaca Morelos Tel: 01 777 3180579 / 01 777 3124014 E-Mail: aquevedo@compusupportcva.com
Distrito Federal: QPLUS, S.A. de C.V. Av. Coyoacán 931 Col. Del Valle 03100, México, D.F. Tel: 01(52)55-50-00-27-35 E-Mail : gacosta@qplus.com.mx	Guadalajara, Jal.: SERVICRECE, S.A. de C.V. Av. Niños Héroes # 2281 Col. Arcos Sur, Sector Juárez 44170, Guadalajara, Jalisco Tel: 01(52)33-36-15-15-43 E-Mail: mmiranda@servicrece.com
Guerrero Acapulco: GS Computación (Grupo Sesicomp) Progreso #6-A, Colo Centro 39300 Acapulco, Guerrero Tel: 744-48-32627	Monterrey: Global Product Services Mar Caribe # 1987, Esquina con Golfo Pérsico Fracc. Bernardo Reyes, CP 64280 Monterrey N.L. México Tel: 8129-5103 E-Mail: aydeem@gps1.com.mx
MERIDA: ELECTROSER Av Reforma No. 403Gx39 y 41 Mérida, Yucatán, México CP97000 Tel: (52) 999-925-1916 E-Mail: rrrb@sureste.com	Oaxaca, Oax.: CENTRO DE DISTRIBUCION Y SERVICIO, S.A. de C.V. Murguía # 708 P.A., Col. Centro, 68000, Oaxaca Tel: 01(52)95-15-15-22-22 Fax: 01(52)95-15-13-67-00 E-Mail: gpotai2001@hotmail.com
Tijuana: STD Av Ferrocarril Sonora #3780 L-C Col 20 de Noviembr Tijuana, Mexico	FOR USA SUPPORT: ViewSonic® Corporation 381 Brea Canyon Road, Walnut, CA. 91789 USA Tel: 800-688-6688 E-Mail: http://www.viewsonic.com



ViewSonic®