

User Manual

APPC-15XP



PRO DVX | ALWAYS ON

Content

- Declaration 3
- Product Instruction 3
- Power on the Product..... 5
 - Without Mounting Bracket 5
 - Use Mounting Bracket 5
- Insert SD Card 5
- Insert USB Devices..... 5
- Display different content for double..... 7
- Home Screen..... 11
- System Bar 15
- Applications 18
- Language..... 19
- Date & Time..... 20
- Volume 21
- Brightness 22
- Scheduled 23
- Wi-Fi..... 26
- Ethernet 27
- Bluetooth 28
- Virtual Keyboard..... 30
- Switch Input Methods..... 31
- Surf Online 32
- Browse Files..... 33
- Play Media..... 35
- Install & Uninstall Apps 36
 - Install Apps..... 36
 - Uninstall Apps..... 39
- Reset to Factory Default..... 40

Declaration

- ✓ Please read the instructions carefully before equipment installation and using the device.
- ✓ Do not put the product in high temperature, humid or dusty environment.
- ✓ Do not drop, crash or break down this product.
- ✓ This product is without battery, and after setting up any Settings on the Settings, it is recommended that the user should not immediately shutdown and confirm. Please wait for at least 5s before shutting down. For the system to save Settings data to database.
- ✓ Do not power off the device when it's formatting or upgrading, otherwise it will cause operation system error.
- ✓ This product is not waterproof.
- ✓ Use only approved add-on enhancements.

Product Instruction

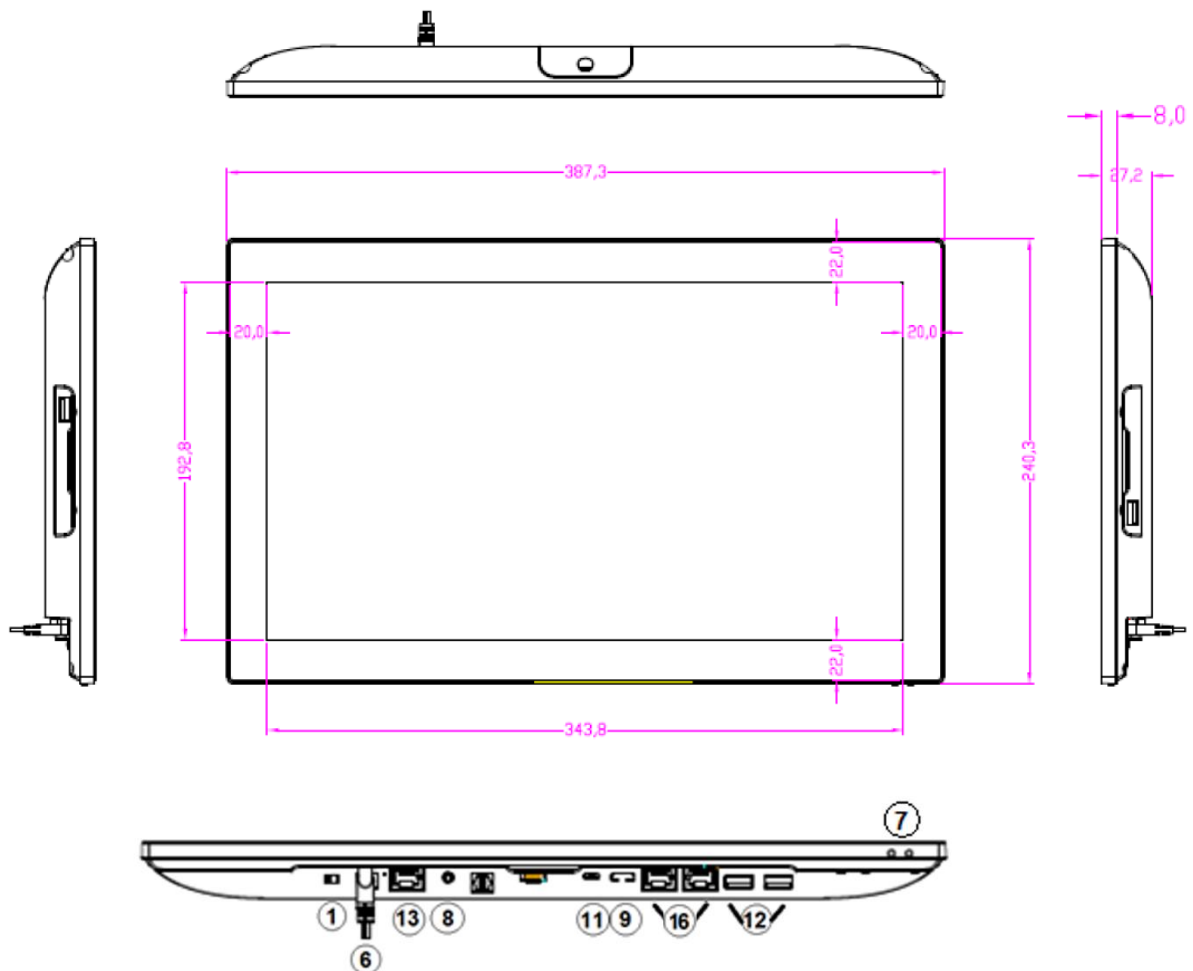

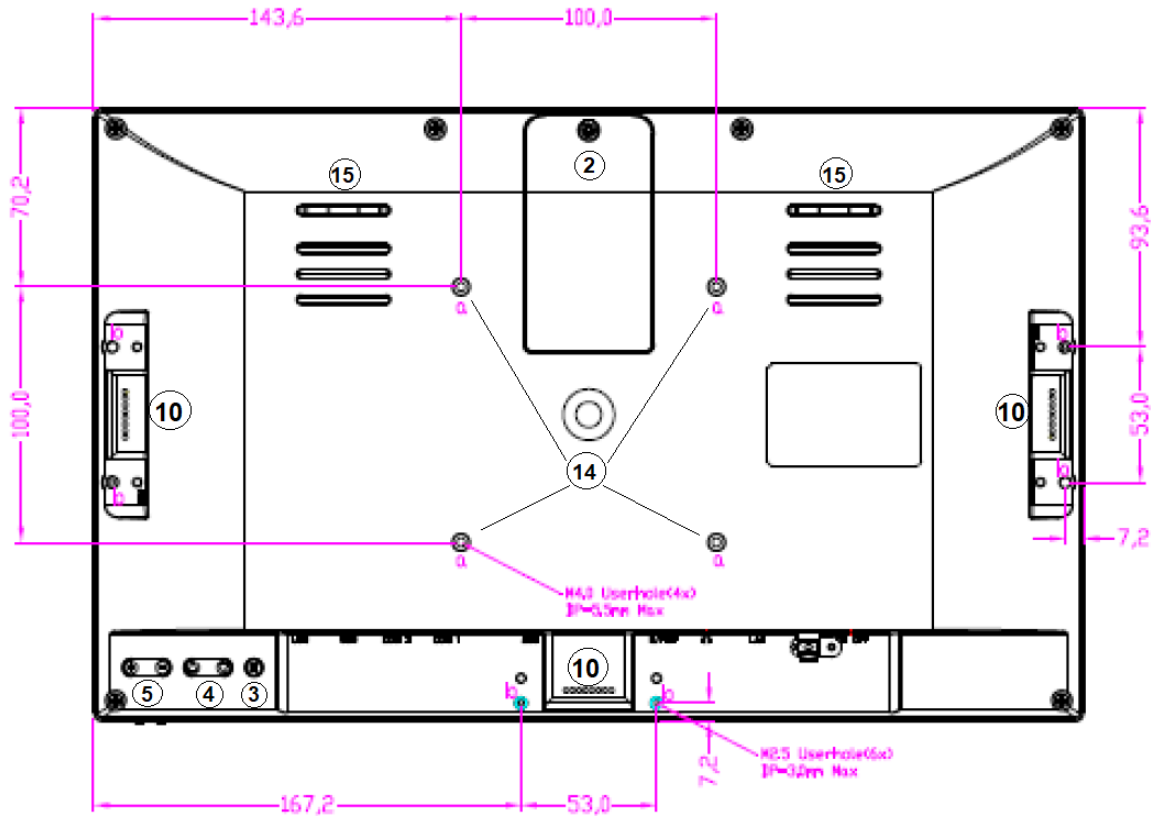

- 1. Power Key:** (1).Short press sleep and wake up
(2).Long press to pop out the power off and reboot dialog box
- 2. SD Card Slot / Cover:** support external SD card
- 3. Exit Button:** return to the previous page. Exit = Home/Back button.
- 4. Function Keys (Up / Down):** select the up/down item
- 5. Function Keys (Vol+ / Vol-):** adjust the system volume
- 6. DC In Jack:** powered by 12V/2A DC input
- 7. LED Indicator:**

Green	Power supply is on.
Red	sleep state.
- 8. Headphone :** 3.5mm Stereo + MIC
- 9. HDMI Port:** HDMI Type A output (covered, for production test only)
- 10. Add-on module slot:** to put optional add-on module
- 11. Micro-USB Port:** support Micro-USB 2.0

- 12. USB Port:** support USB 2.0 Host type A
- 13. 10/100/1000Mbps RJ45 Ethernet Port:** support Ethernet connection
- 14. VESA Mount Holes:** for installing the bracket
- 15. Speakers:** 8ohm / 2W

- 16. RS-232 :** 2 x RS-232
- 17. WIFI:** 802.11b/g/n/ac 2.4G/5G
- 18. Temperature :** Operation: 0°C ~ 40°C (32F ~104F)
Storage: -10°C ~ 55°C (14°F ~ 131°F)
- 19. Bluetooth :** V4.2 of 1, 2 and 3 Mbps.

Power on the Product

Without Mounting Bracket

Step1 Power on the power adapter that connected to this product.

Step2 When the power is switched on, the LED light (#7) shows green.

Use Mounting Bracket

Step1 Put the mounting bracket to the back of the tablet, and tighten the installation screws on the screw holes.

Step2 Plug the power adapter into the DC in jack (#8 in [Product Instruction](#)) at the bottom of the mounting bracket.

Insert SD Card

This product supports external SD card. Please insert your SD card into the SD Card Slot (#2 in [Product Instruction](#)) on the top of this product.

Insert USB Devices

This product supports USB and Micro-USB to deal with your files.

USB

Plug your USB memory into the USB port (#12 in [Product Instruction](#)) on the bottom of this product, and then you can do the file operations via the File Browser. (See in [Browse Files](#)).

Micro-USB

Connect the Micro-USB port (#11 in [Product Instruction](#)) on the bottom of this product and the USB port on your computer with a Micro-USB-to-USB cable.

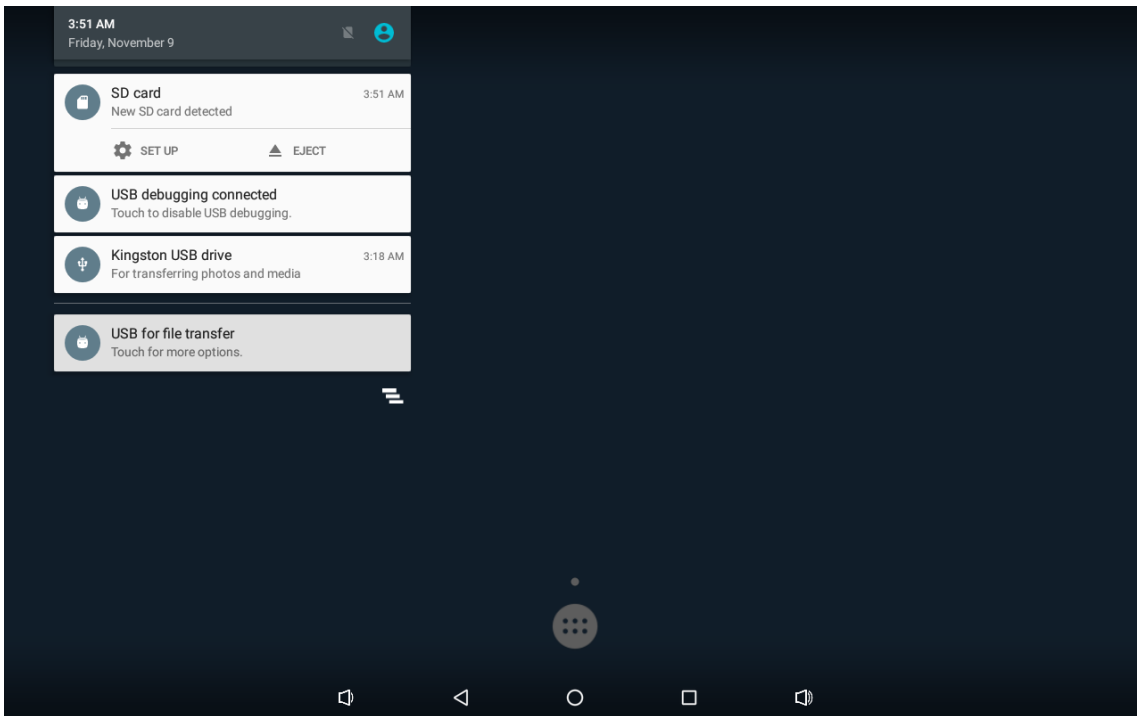

Click the “**USB debugging connected**” Entry “**Developer options**” interface;

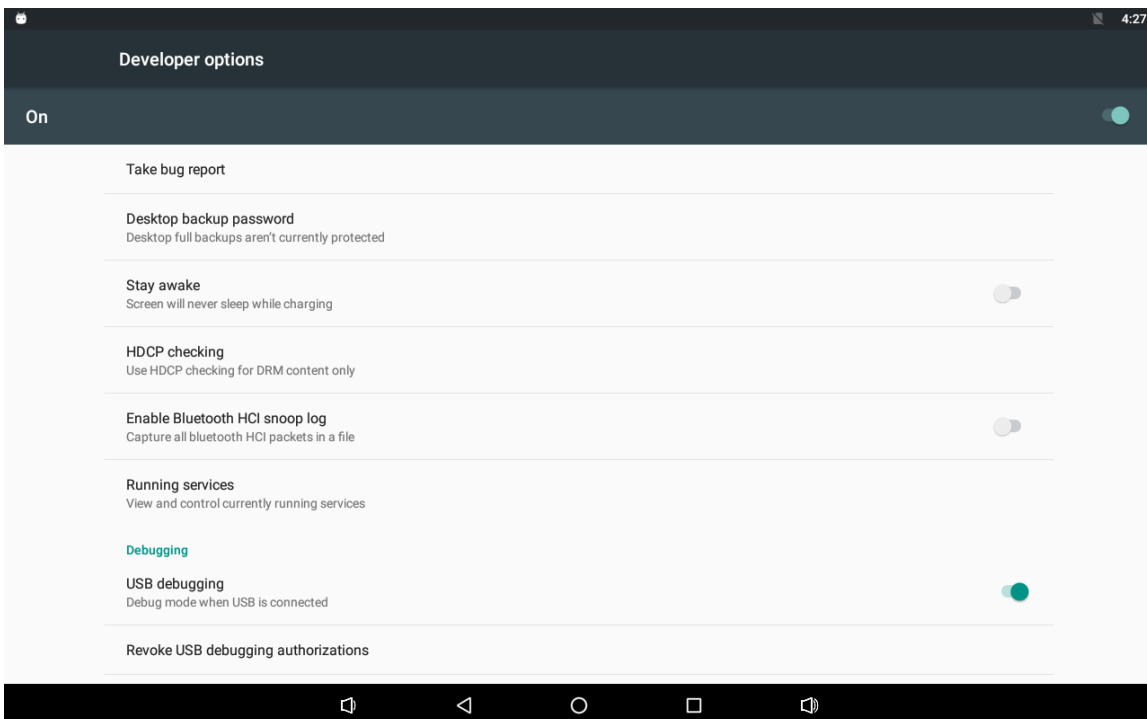

Click the “**USB for file transfer**” access to the USB use options interface.

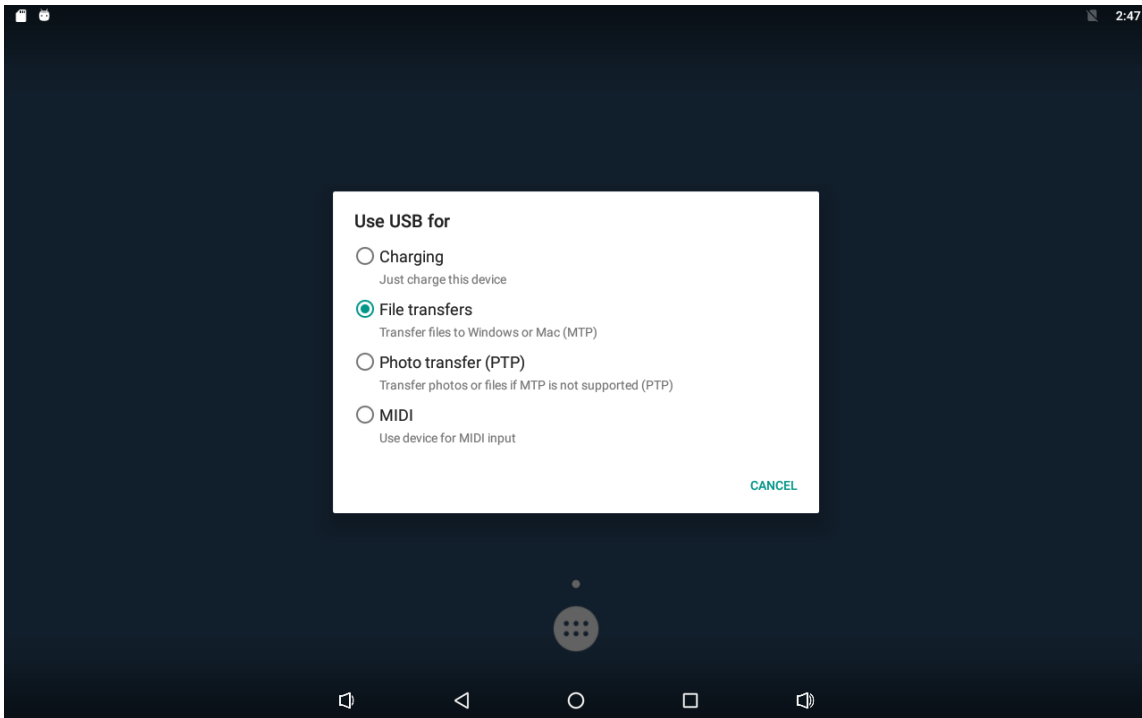

Display different content for double

This product supports display different content for double screen. Please plug one side of the HDMI cable into the HDMI port (#9 in [Product Instruction](#)) on the bottom of this product, and plug the other side of the HDMI cable into the HDMI port of the monitor.

Display screen and this product display different interface.

Dual screen show different content Guide :

1. Enter settings to display outputs;

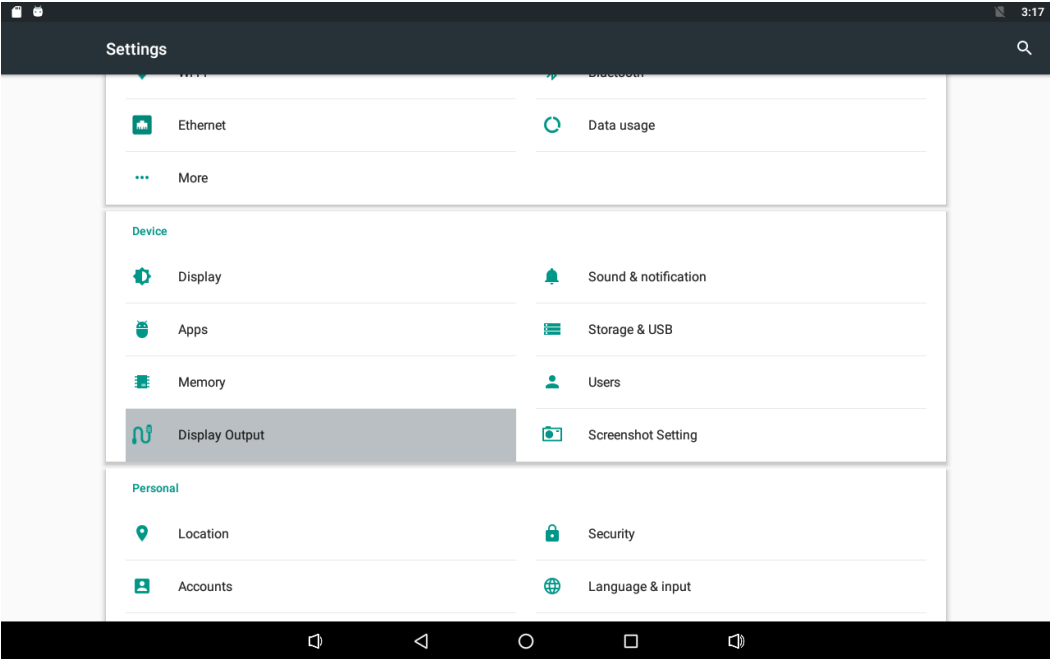

2. Select "Display different content for double screen";

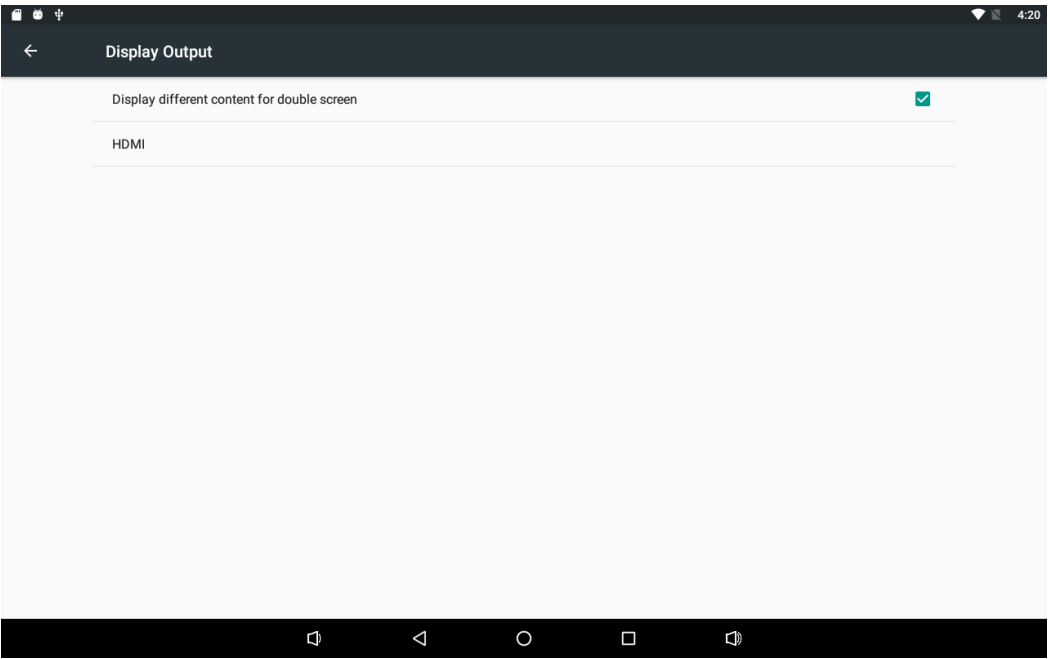



3. Open at least two running programs .For example, video and browser;

4. Slide your finger from the right side to left on the touch panel, then you will see two buttons;



 : This button is different display button.

 : This button is same display button

5. Click the  button, the video display will only stay on HDMI monitor, and the APPC-10X(P)(L) will display previous apk screen;

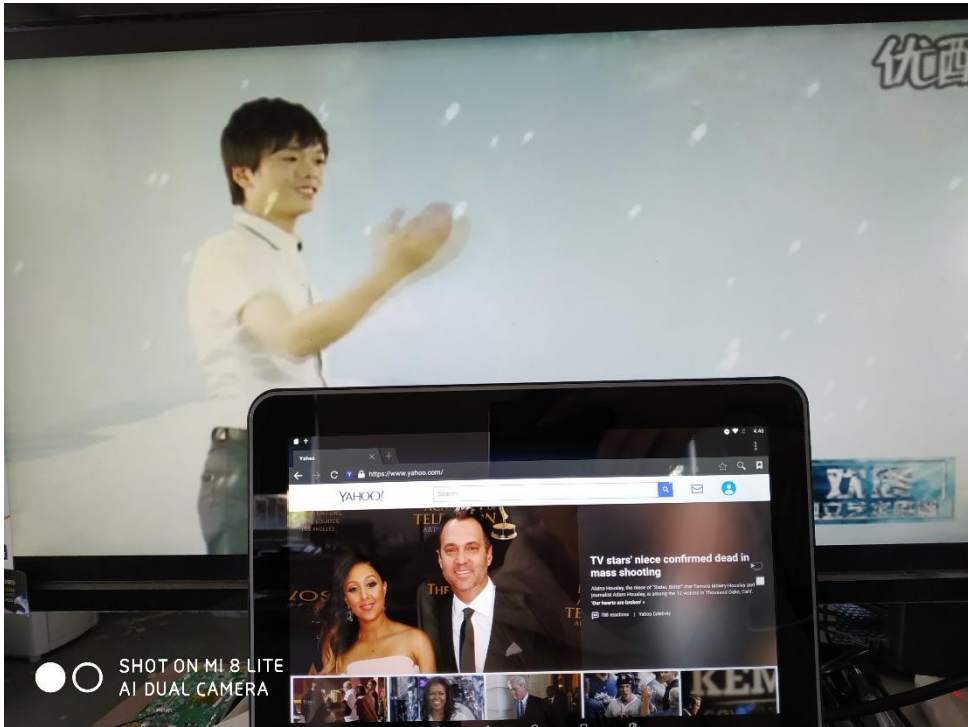

6. If you want close the different display, please repeat step 4 and then click  button, the APPC-10X(P)(L) and HDMI monitor will display same screen.

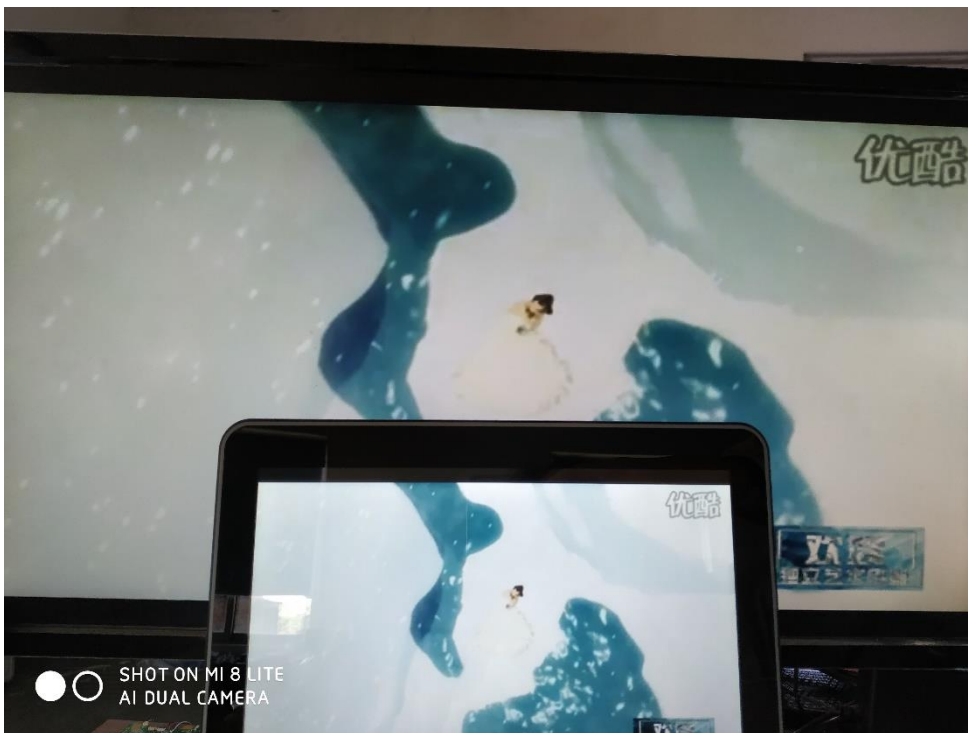

Home Screen

In the home screen, you can long-press the blank space to change the wallpaper or drag widgets to desktop.

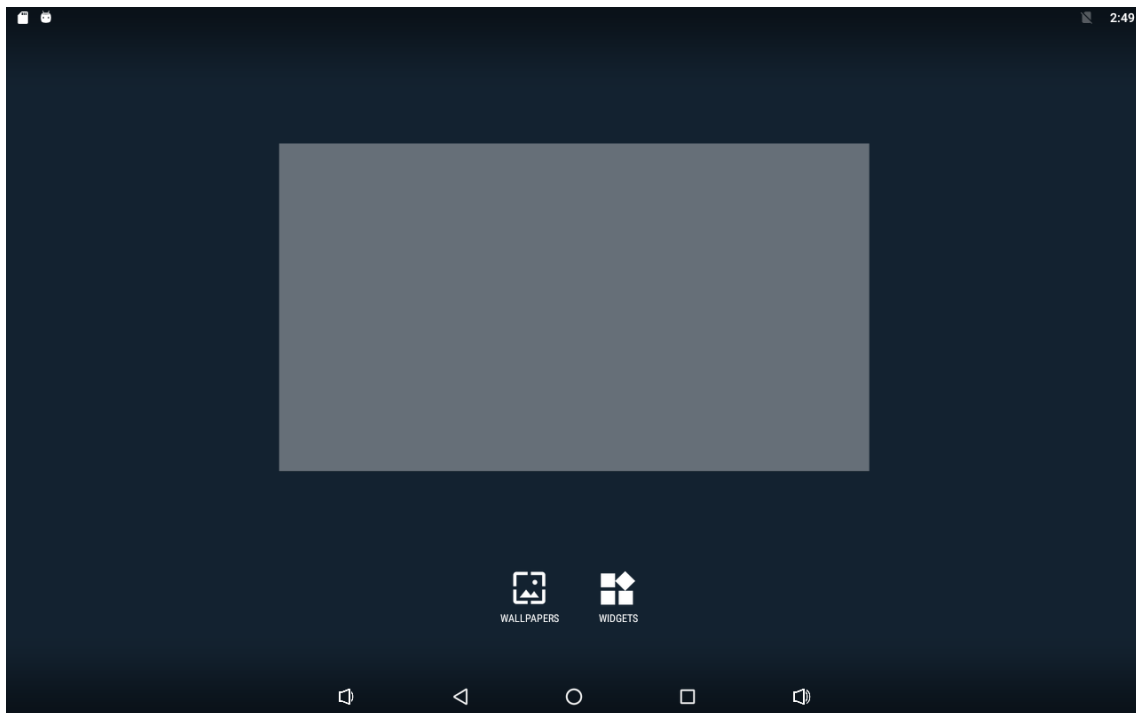

Change Wallpaper:

1. Click "WALLPAPERS".
2. Select one picture from system presets or your own pictures.

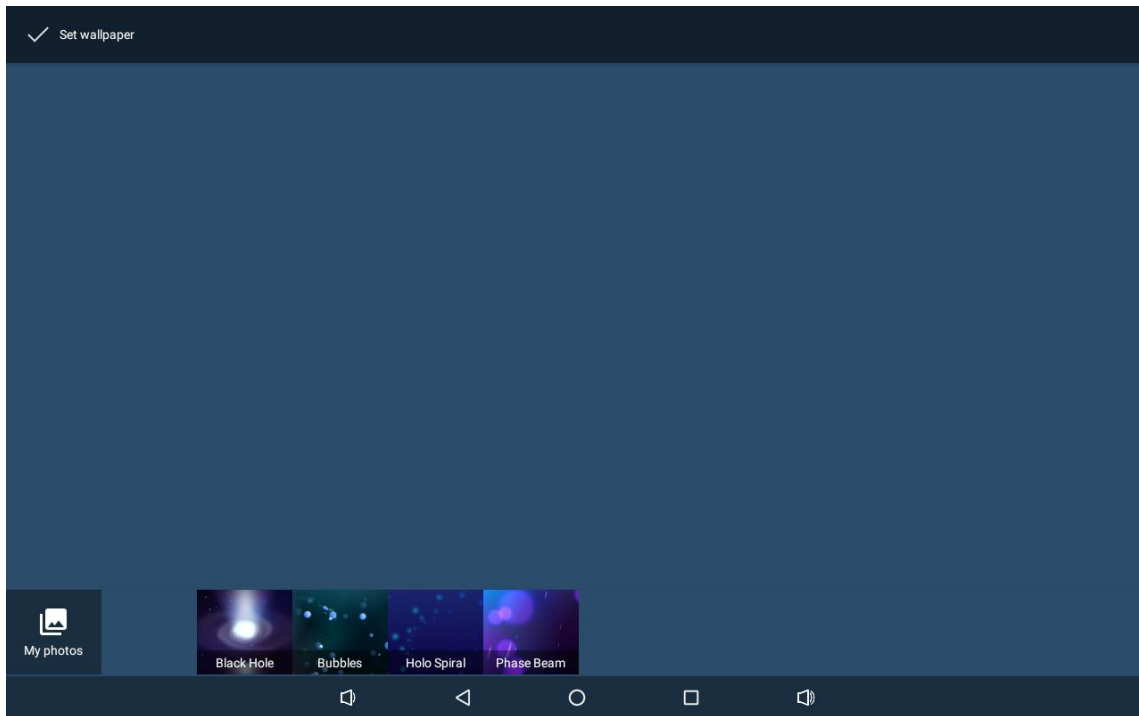

3. Click “Set wallpaper” on the middle corner of the screen to apply the wallpaper.

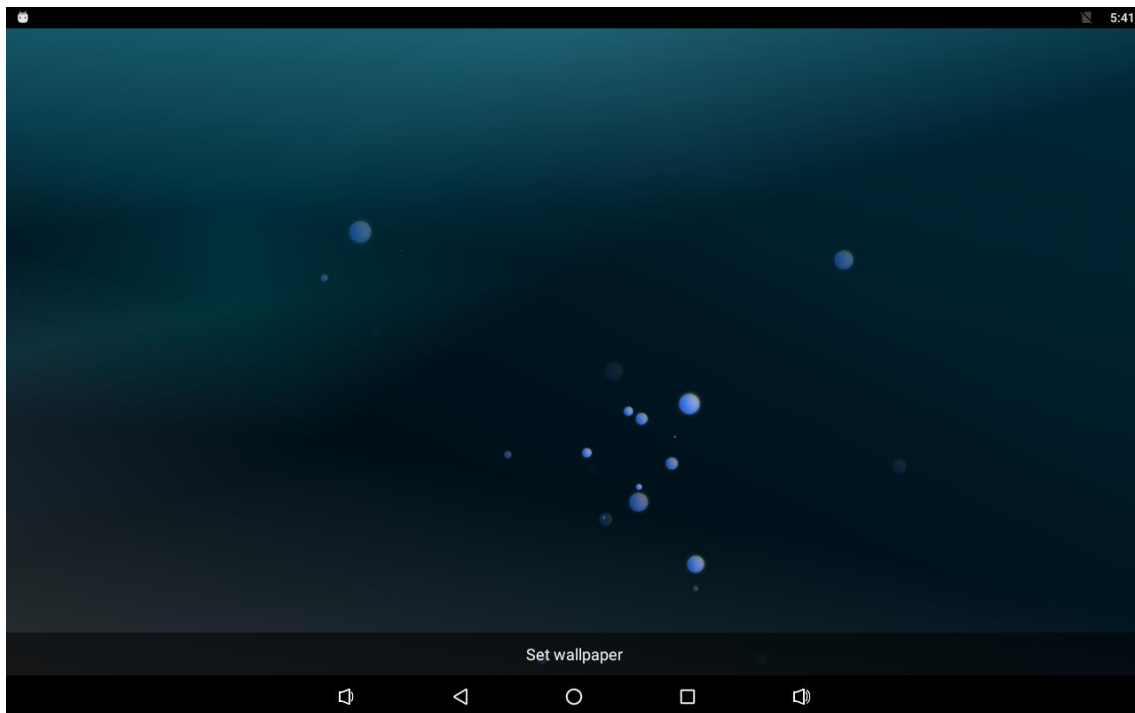

Add Widgets:

1. Click “WIDGETS”.

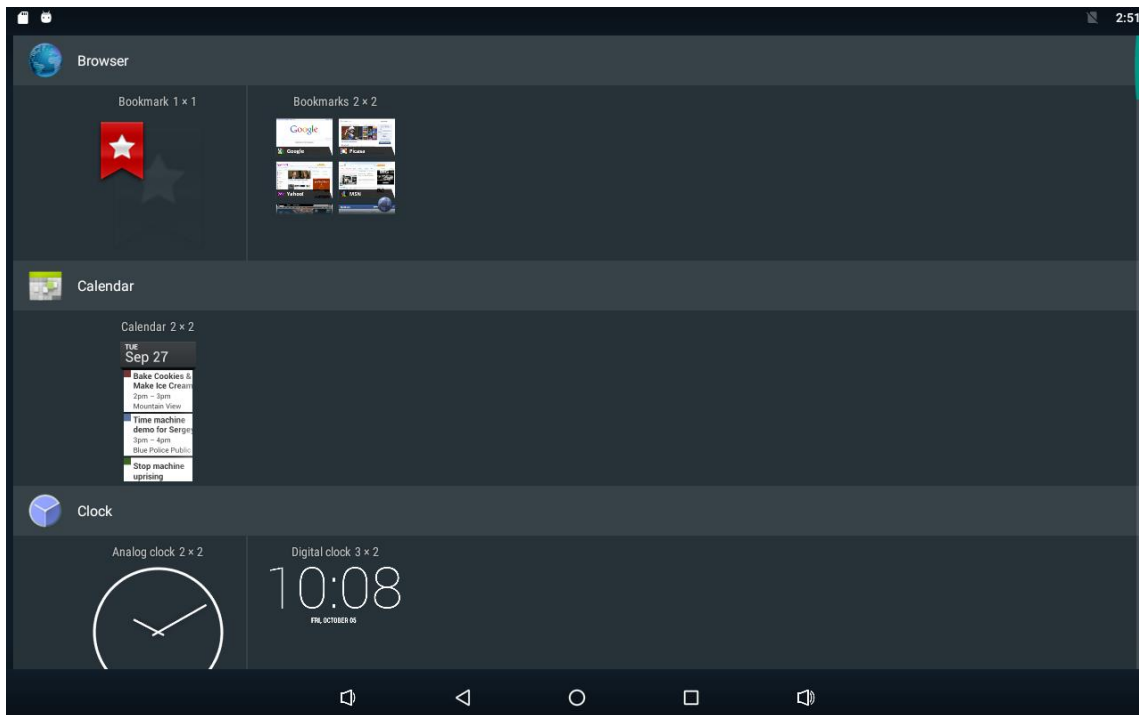

2. Long-press a widget and drag it to desktop.

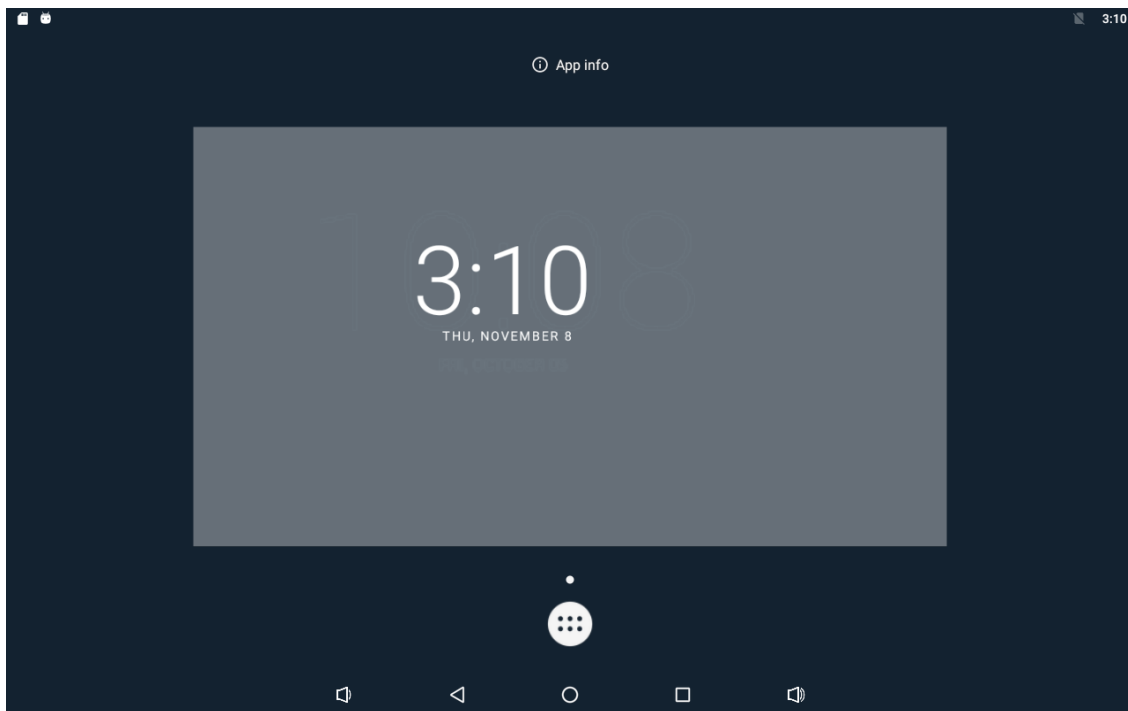

3. If you want to remove an icon, long-press the widget and drag it onto “×Remove” at the top of the screen and drop it until it turns light gray.

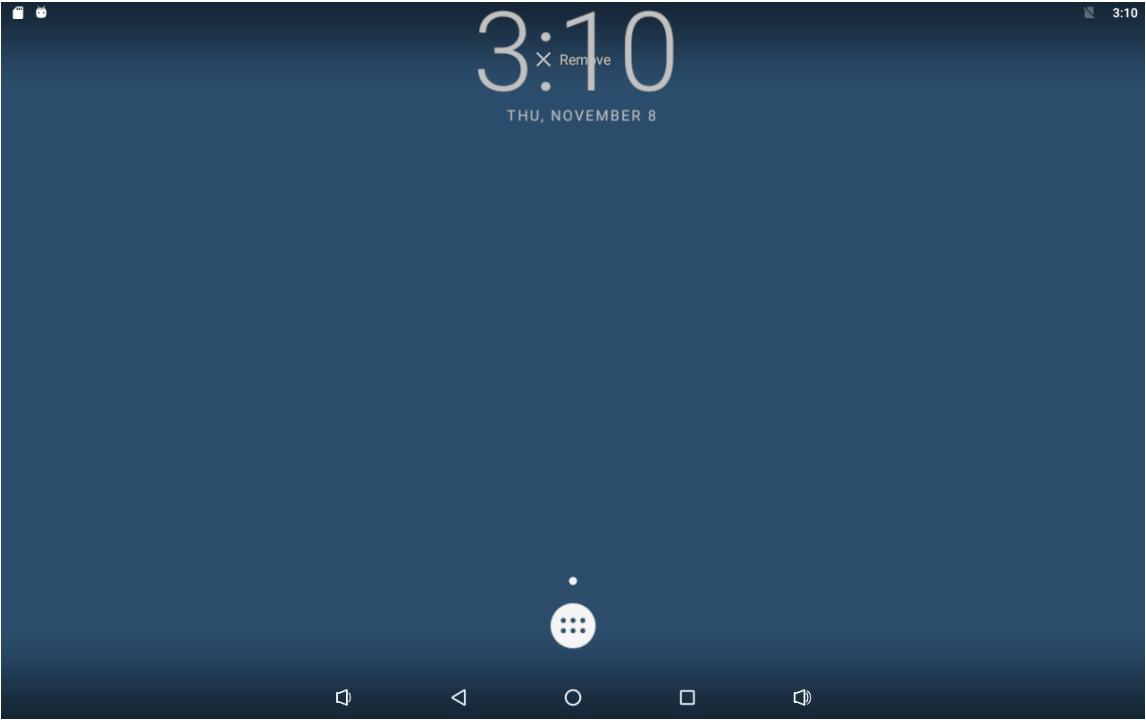

System Bar

Navigation Buttons



- 1. Volume-:** Decrease the system volume.
- 2. Back:** Return to the previous page.
- 3. Home:** Return to the home screen.
- 4. Recents:** Switch between recently used apps.

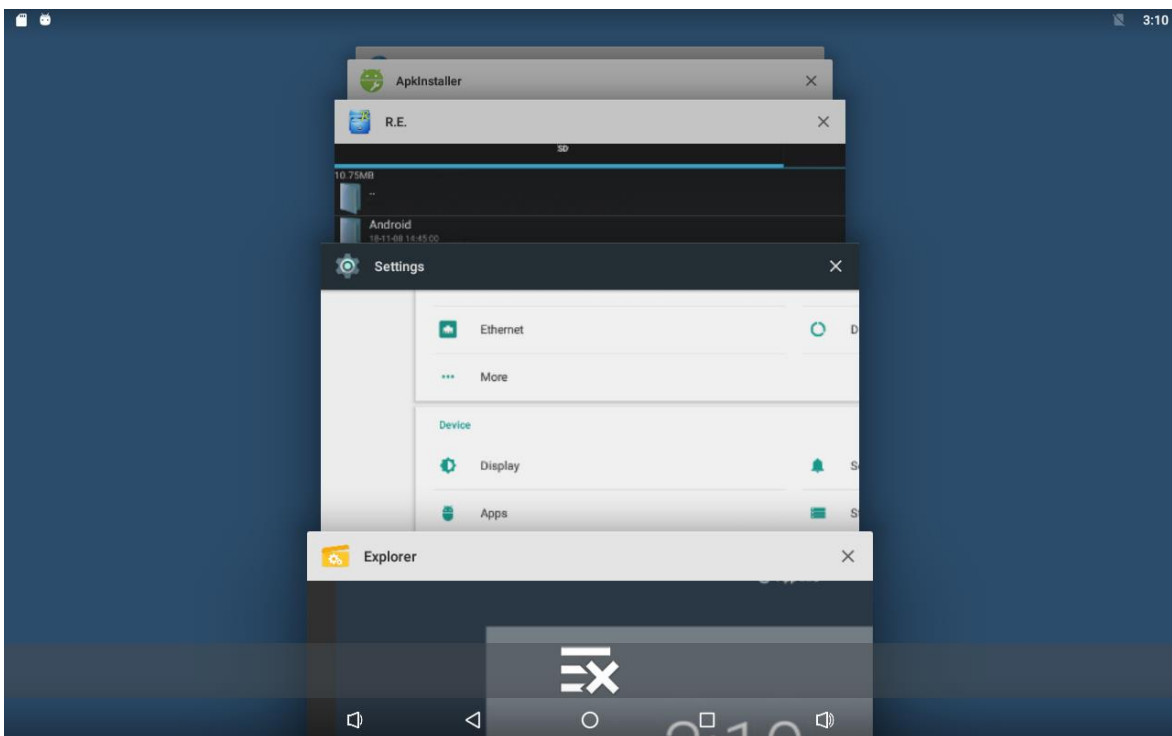

To delete an application from the list, you can delete the application by clicking on the "X" icon in the upper right corner or Left and right removal.

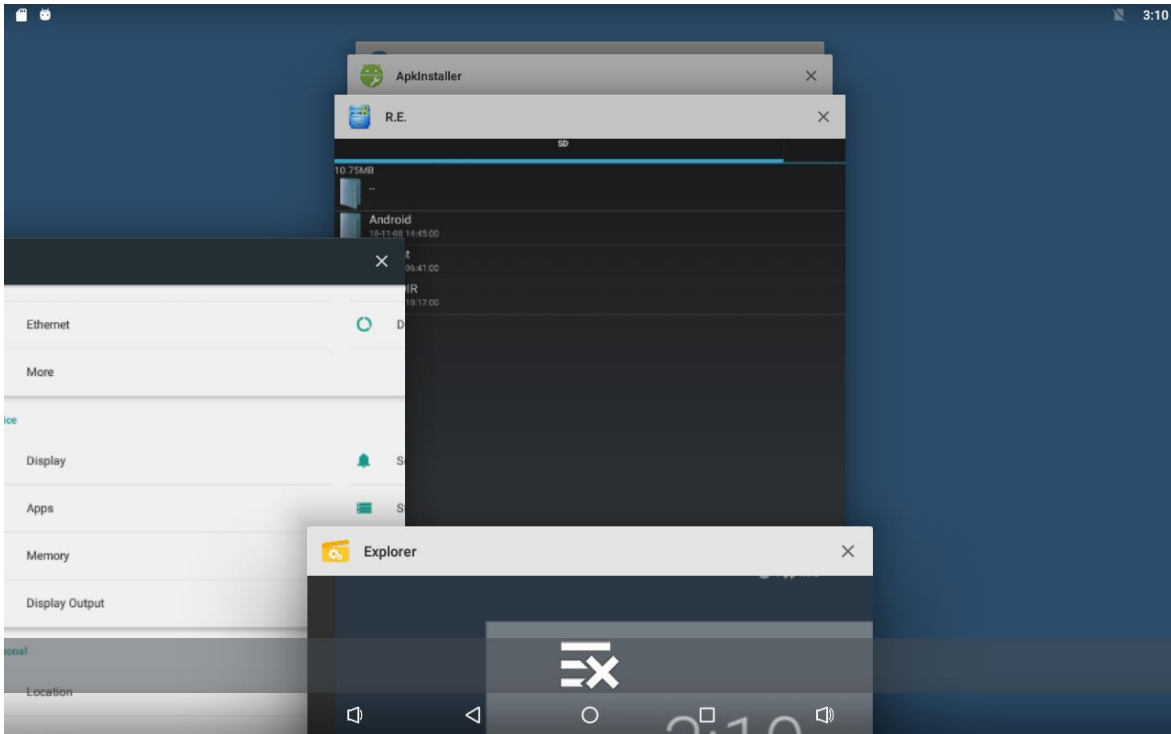

Click on the middle of the three to delete the X Icon.

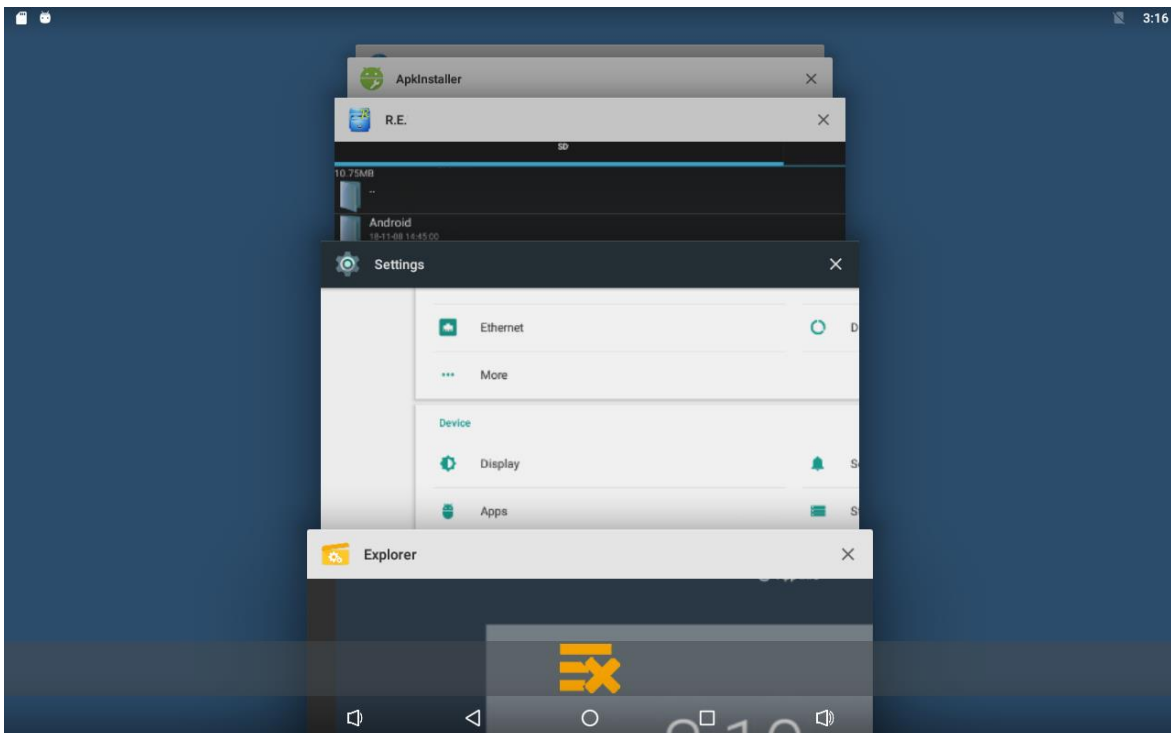

5. Volume+: Increase the system volume.

Status Notifications



Status bar at top of the screen displays system status, such as time, Wi-Fi, and USB connection etc.

Pull down the upper left corner or the upper right corner to open the state window and shortcut windows, including brightness adjustment, Wi-Fi, automatic rotation, Bluetooth, projection, aircraft mode and position switch, and system settings entry

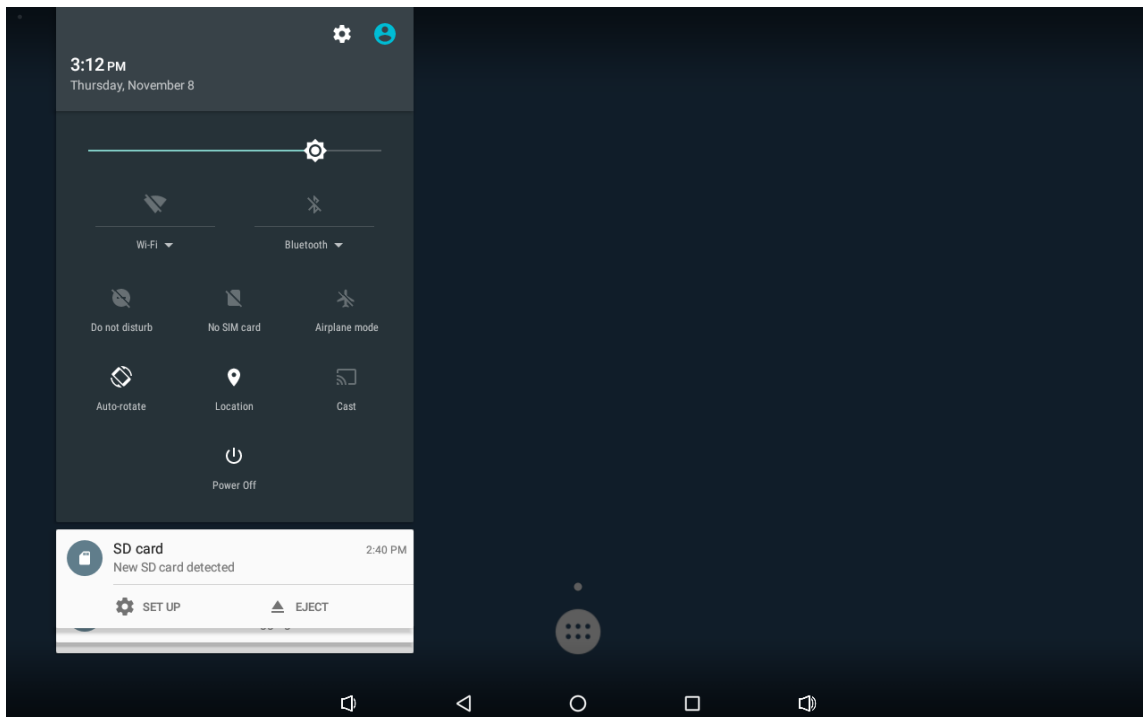

Applications

Click  at the bottom of home screen to enter the applications page.

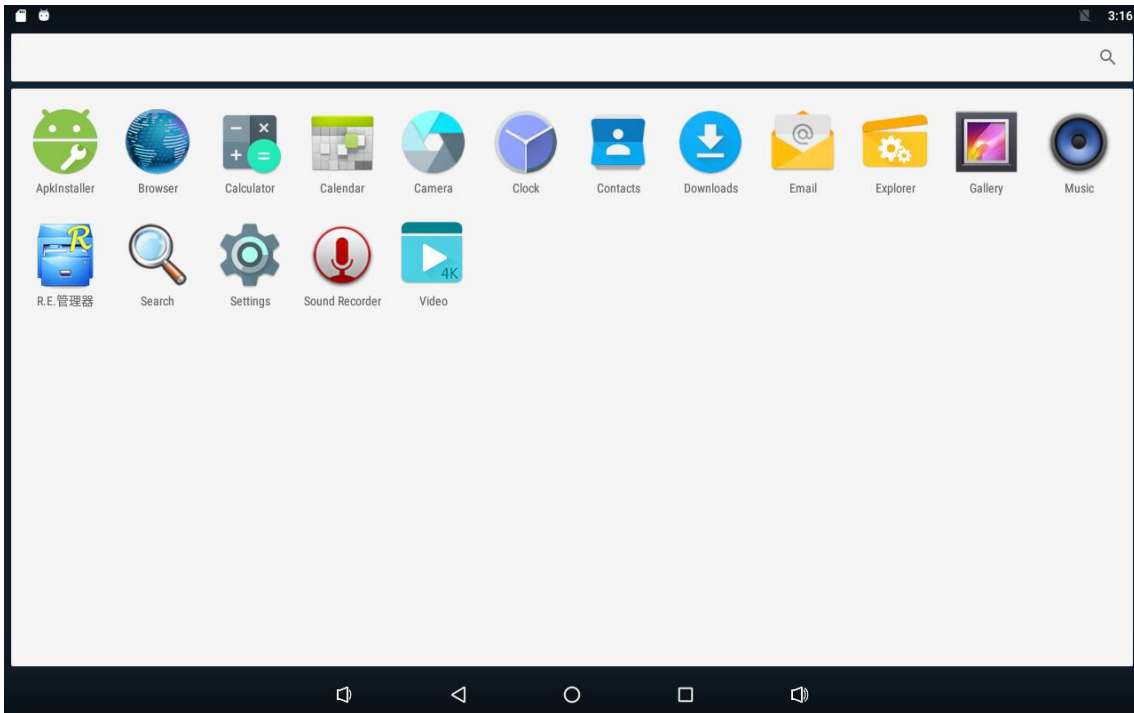

The installed applications will be shown here and you can open an app by clicking its icon.

To find an app easily, you can create a shortcut by long-pressing of the icon and drag it to the home screen.

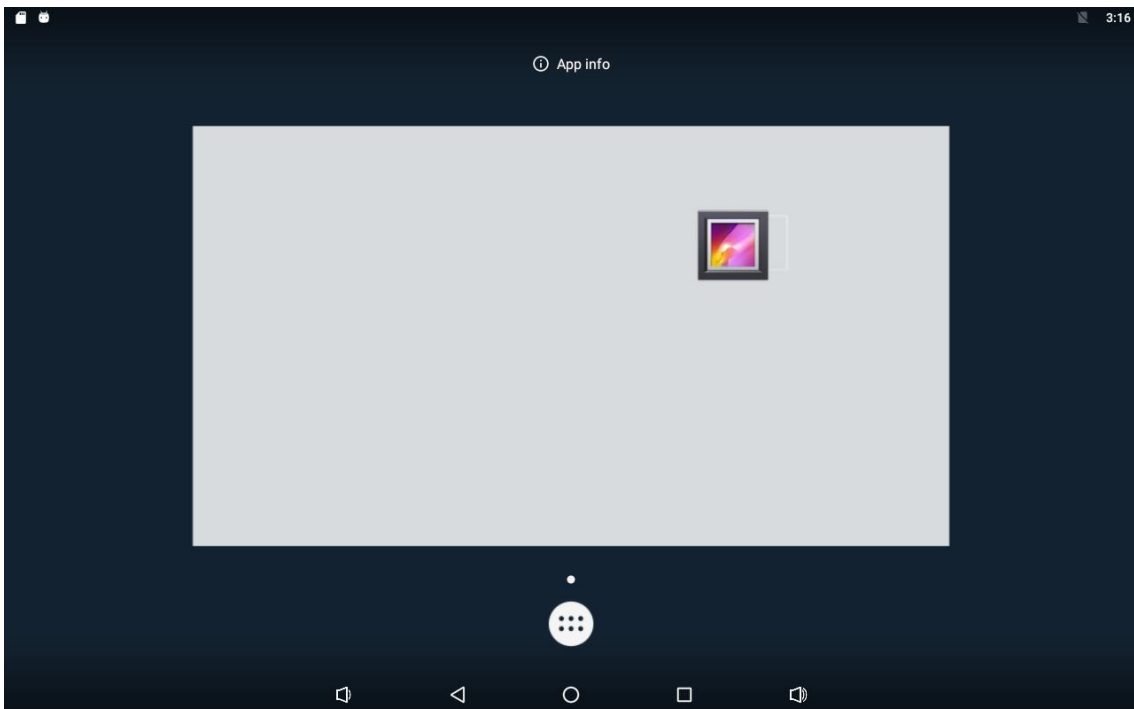

Language

In the App list, click “**Settings**”  to open the system setting app, and select the option “**Language & input**”.

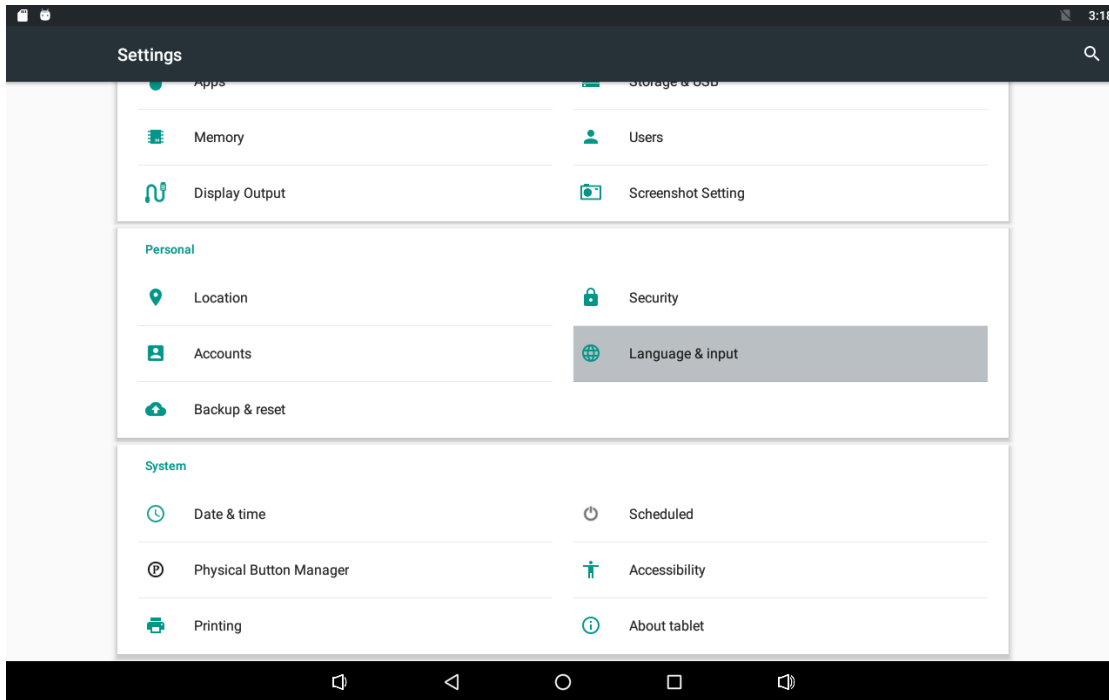

Click the first option “**Language**” under “**Language & input**”, and then you can change the system language according to your preference.

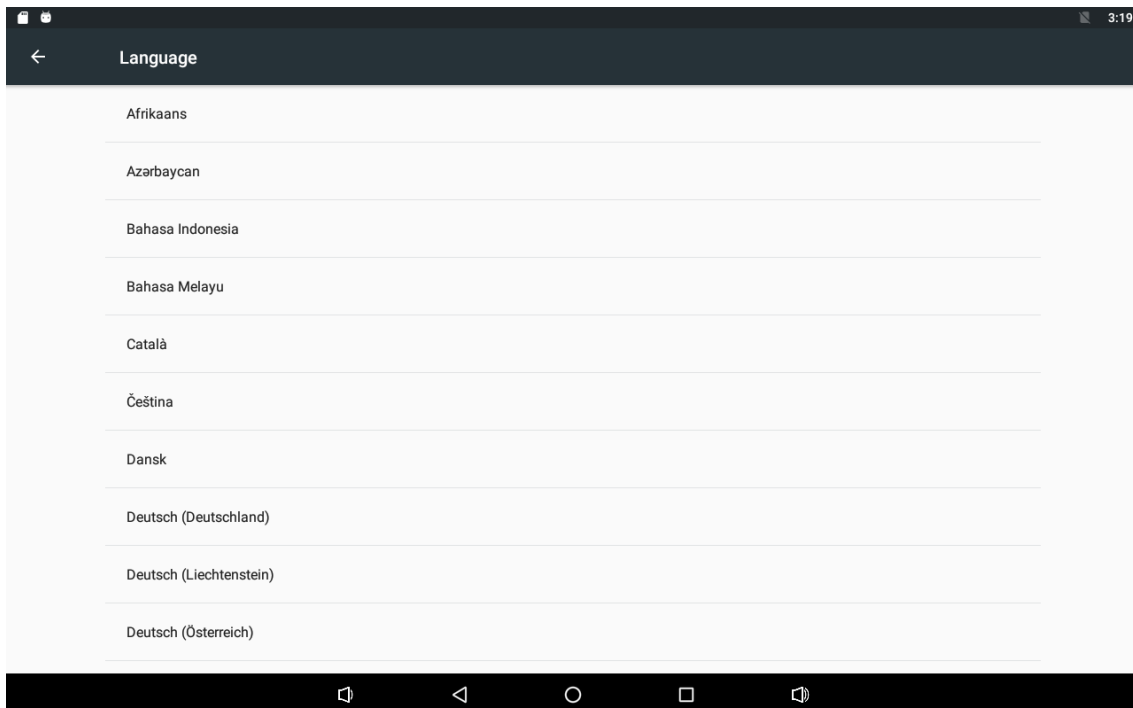

Date & Time

In the App list, click “**Settings**”  to open the system setting app, and select the option “**Date & time**”.

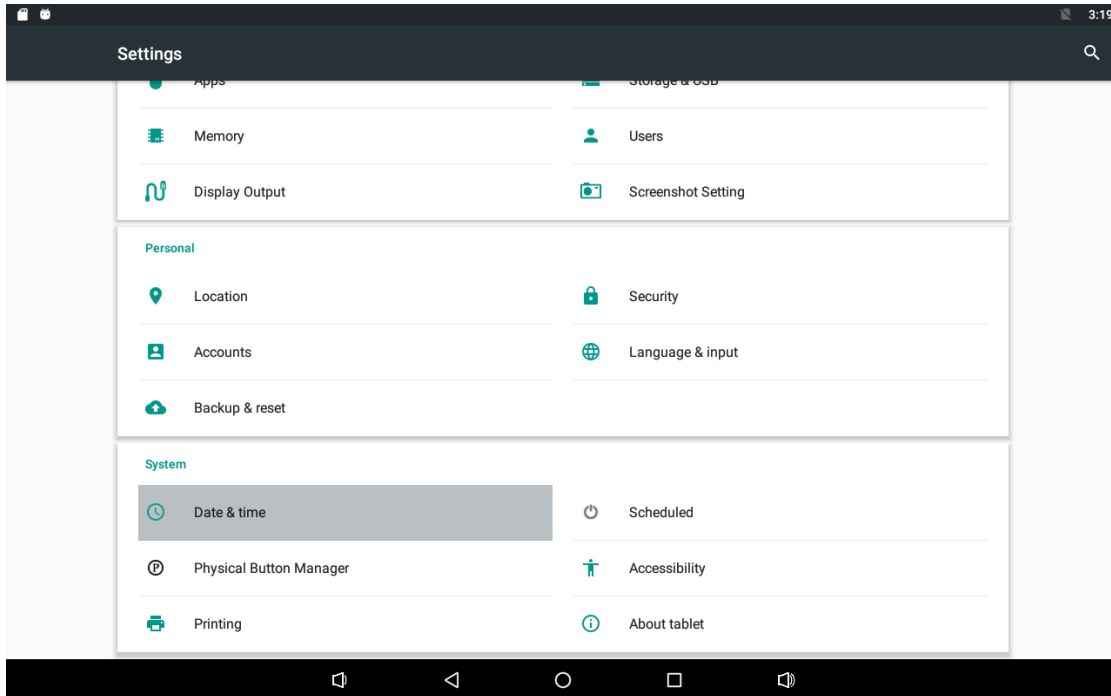

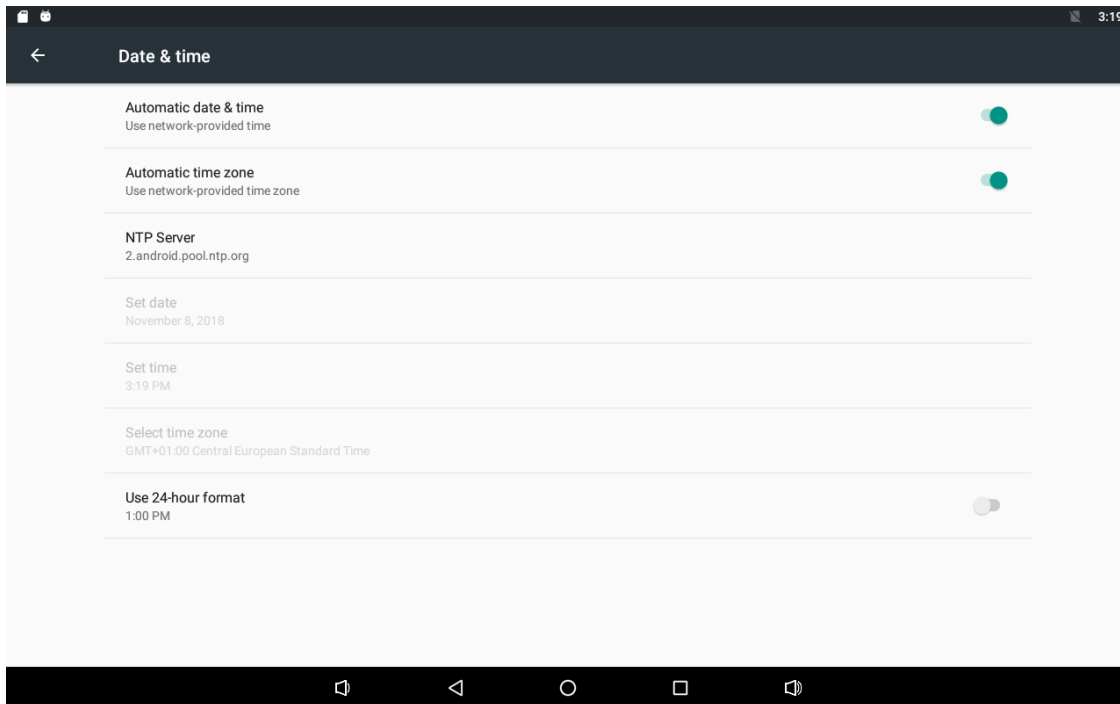

If you enabled the option “**Automatic date & time**” under “**Date & time**”, system date and time will be synchronized automatically with network time when you connected a Wi-Fi network.

If you want to set the time manually, you need to disable “**Automatic date & time**” and “**Automatic time zone**”.



In this option, you can also set time zone, time notation and date format.

Volume

On the system bar, click the **Volume-** icon  to decrease the system volume, and click the **Volume+** icon  to increase the system volume.

Or you can press the function keys (#5 in [Product Instruction](#)) on the top of the product to adjust the volume.

Brightness

Pull down the screen and open the shortcut window, then click "brightness".

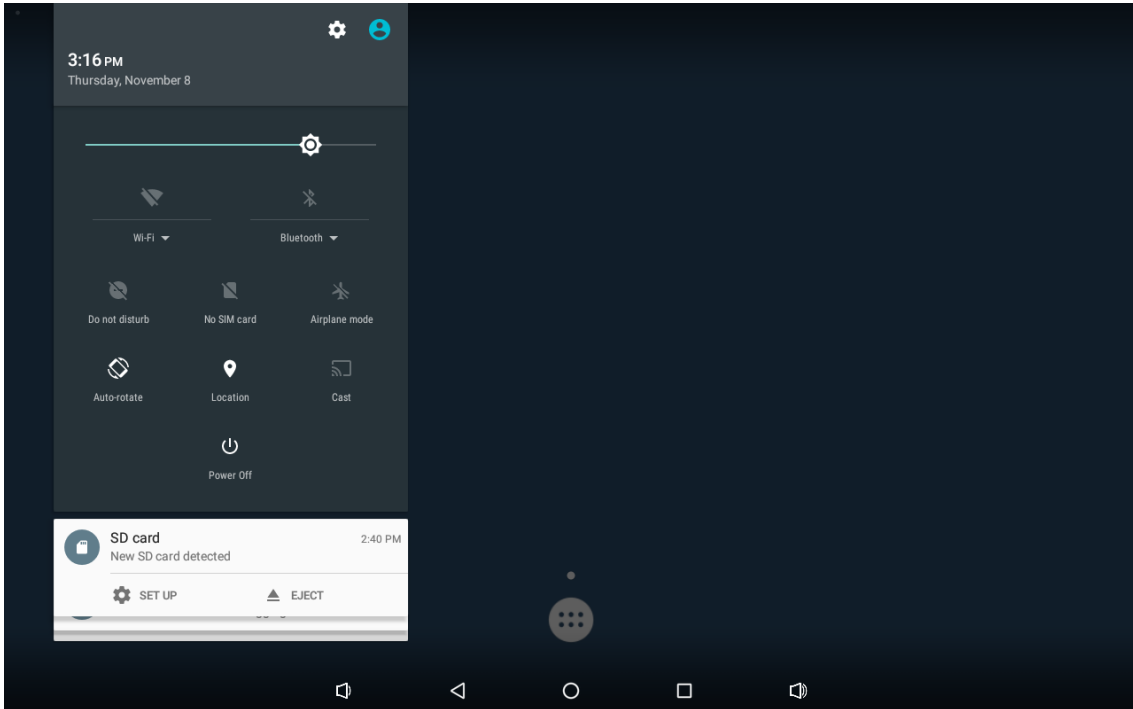

Left and right sliding brightness bar to adjust brightness.

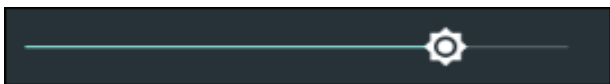

Scheduled

This function is used to power the device on and off automatically at the set time.

In the App list, click “**Settings**”  to open the system setting app, and select the option “**Scheduled**”.

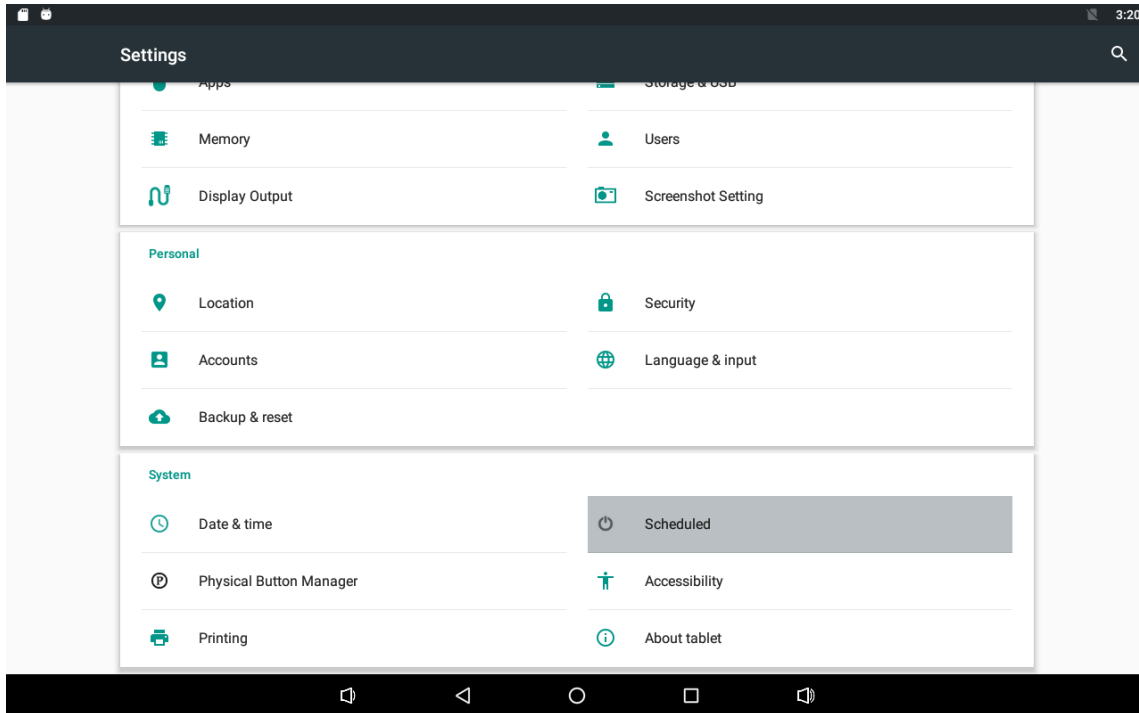

Click the single option “**Set Scheduled Shutdown Clocks**”.

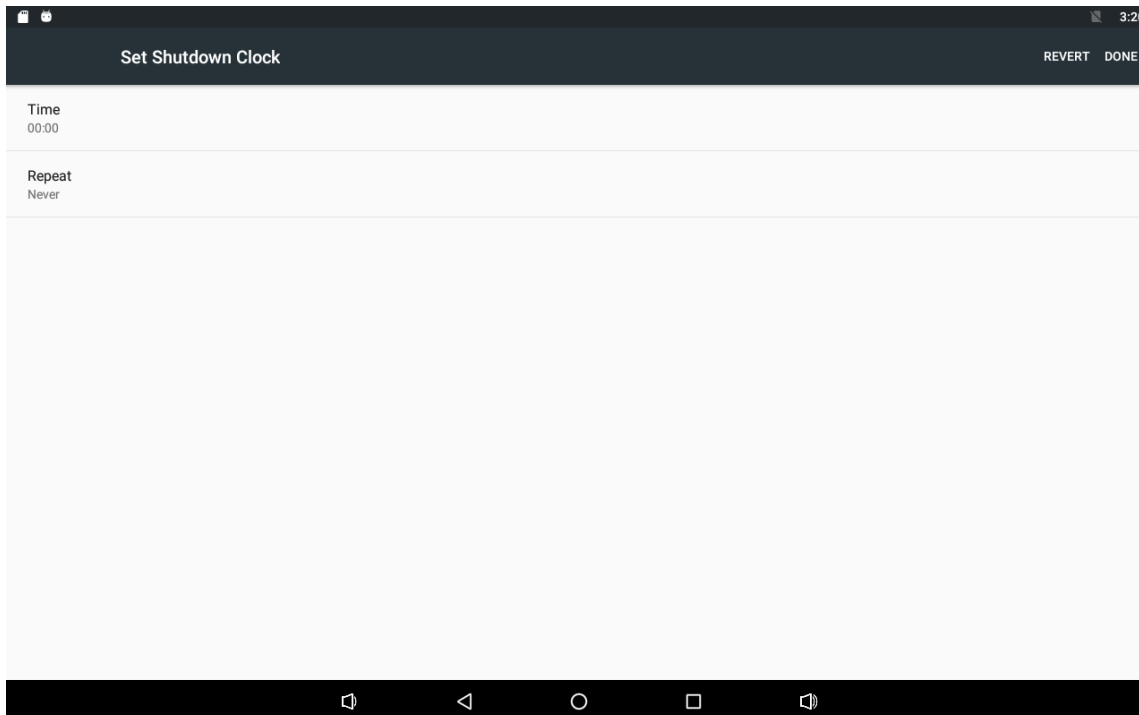

Click the option “**Time**” to set the power off time of this device.

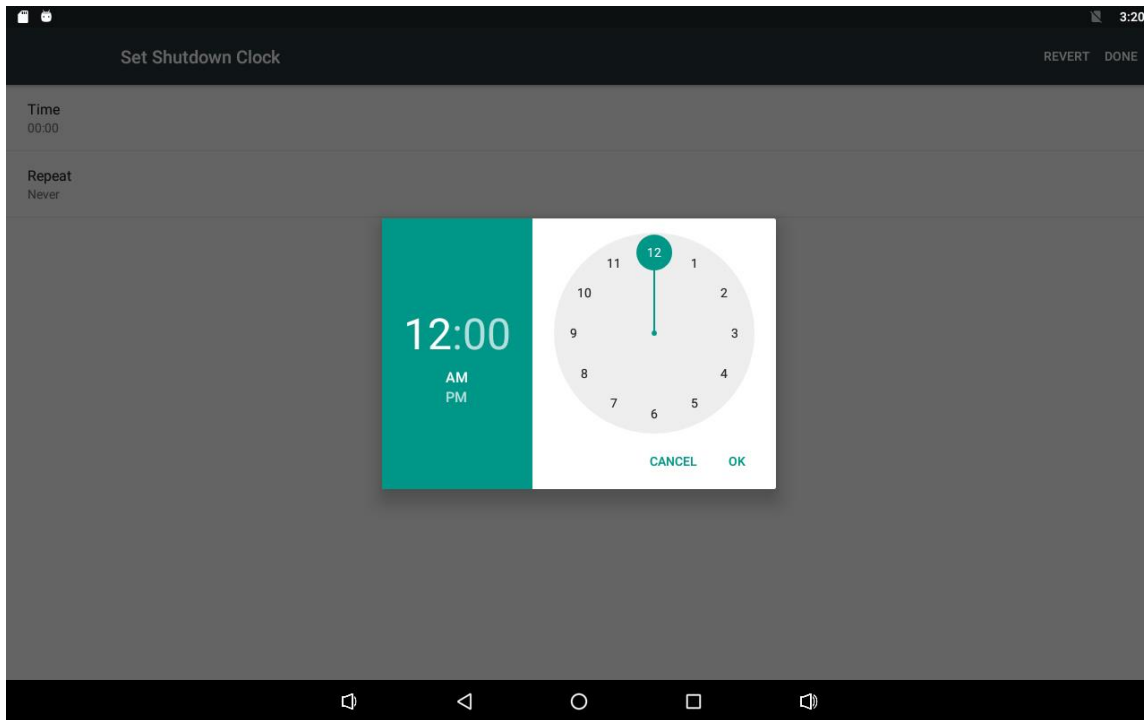

Click the option “**Repeat**” to select the days which will power off this device at the set time.

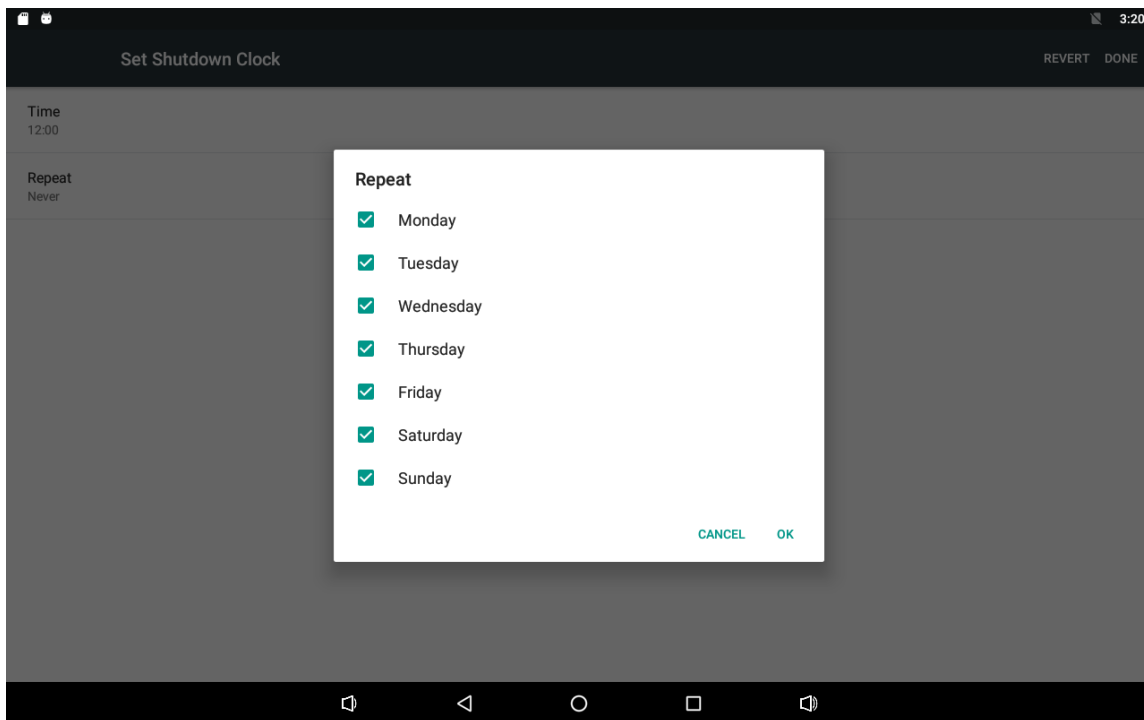

After setting, click **“Done”** at the upper-right corner of the screen to save them.

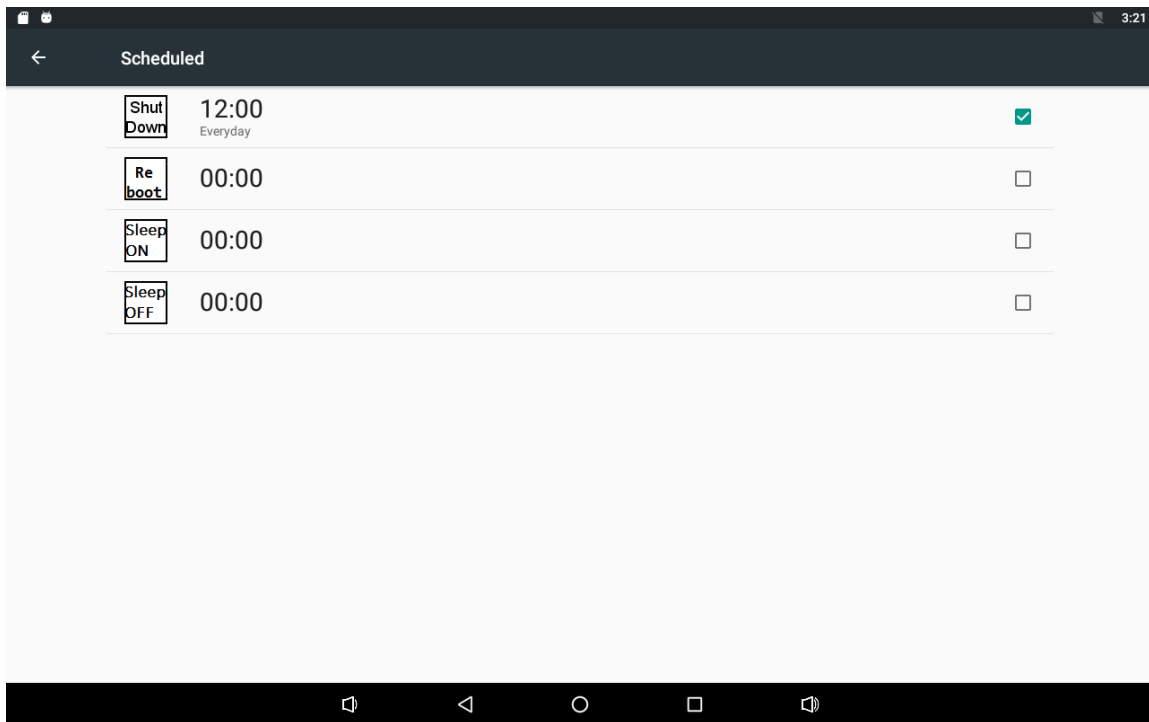

Follow the above steps to set the "Reboot", "Sleep ON" and "Sleep OFF" times.

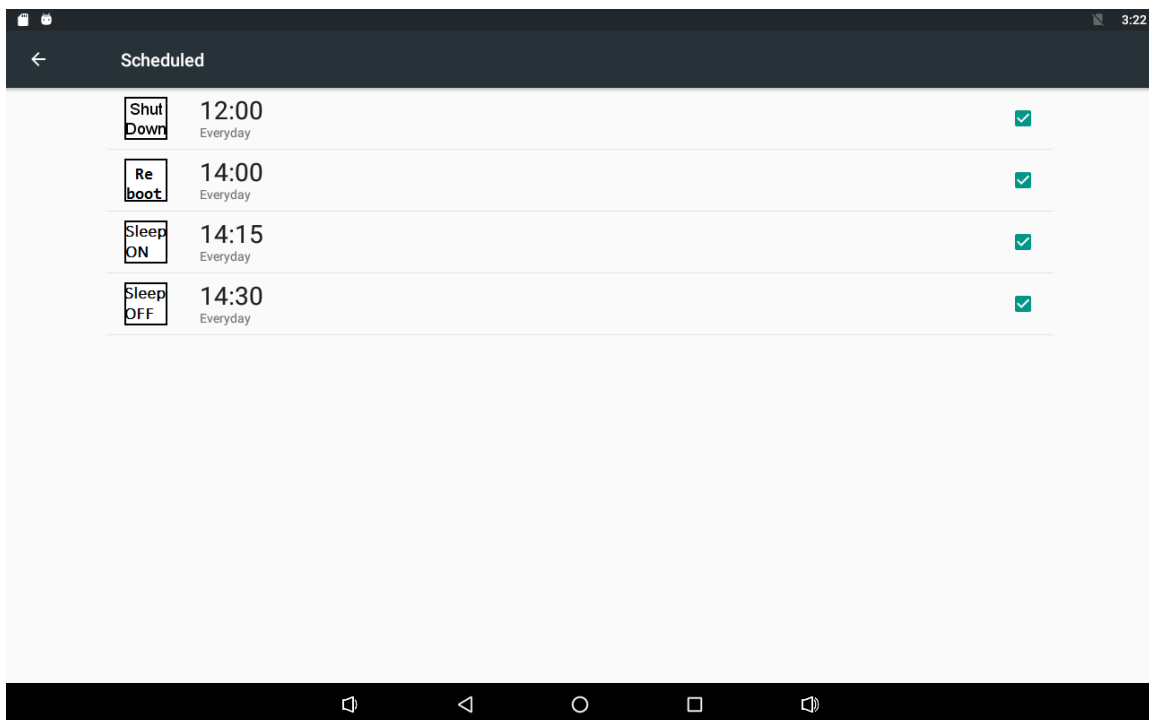

The above operation will be performed at a specified time; (Sleep off time is greater than Sleep on time)

Wi-Fi

In the App list, click “**Settings**”  to open the system setting app, and select the option “**Wi-Fi**”.

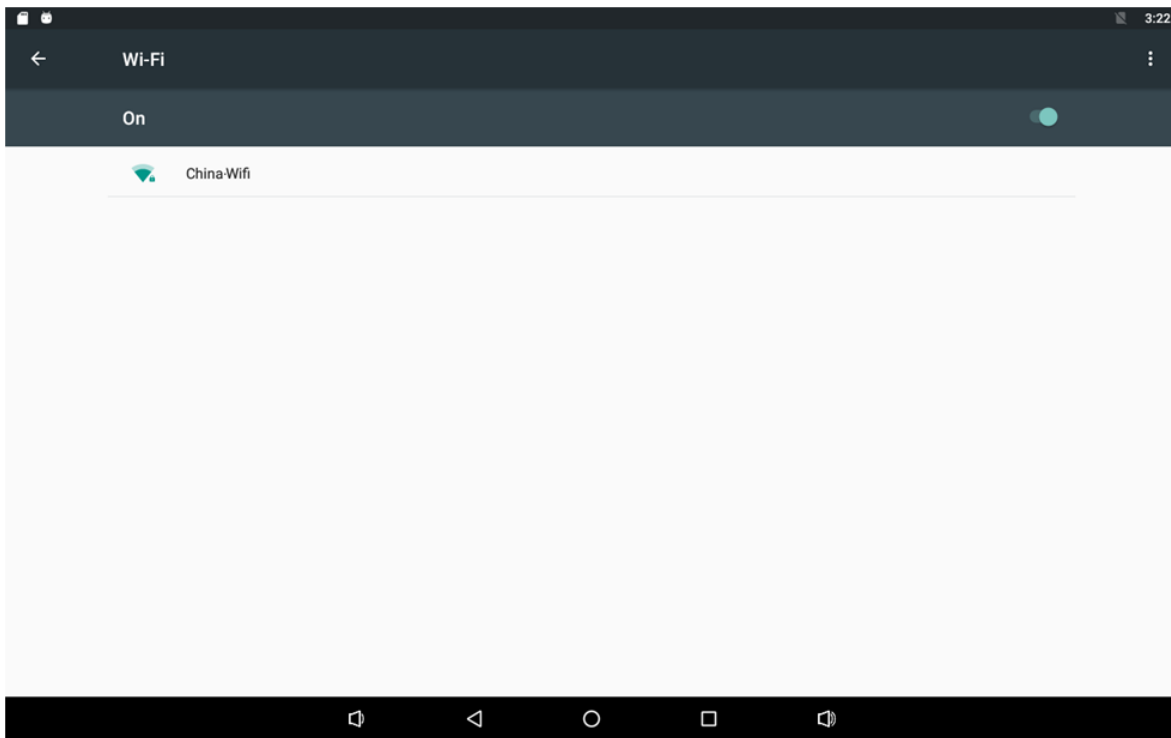

Switch the Wi-Fi button to **ON**. The product will scan available wireless networks automatically. Select a network under Wi-Fi networks and input the password to connect.

Ethernet

In the App list, click “**Settings**”  to open the system setting app, select “**Ethernet**” at the left side.

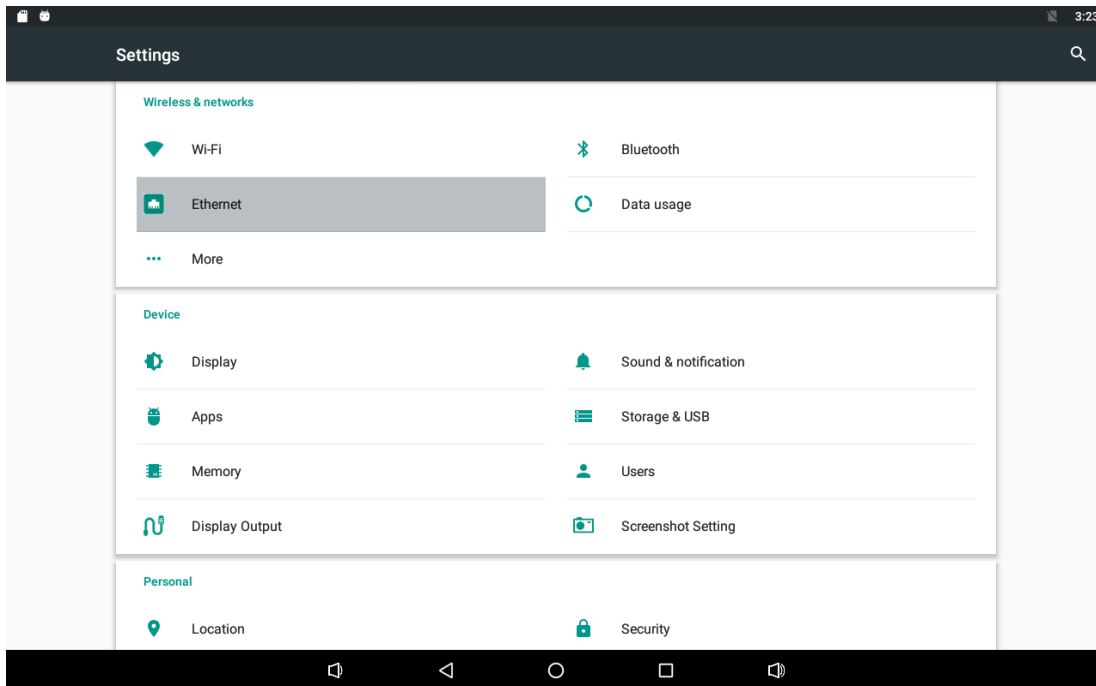

Check “Use Ethernet” and plug the Internet cable into the Ethernet port (**#13 in Product Instruction**). If Wi-Fi is on, please turn off Wi-Fi to allow Ethernet working.

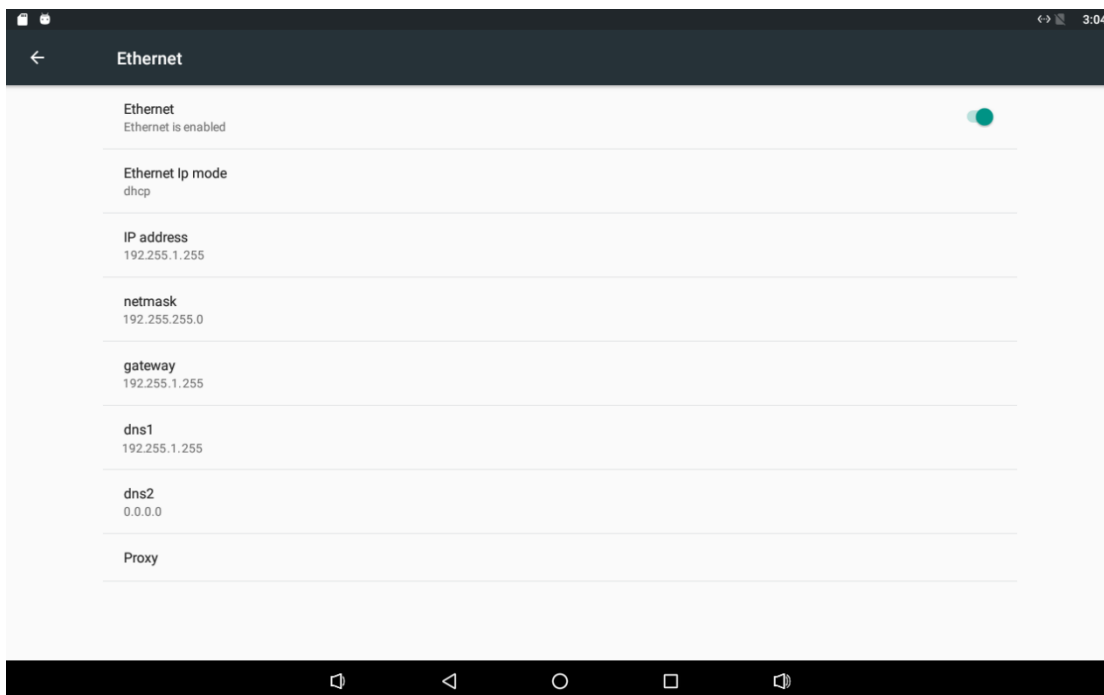

If you are Static IP user, please set the configurations manually.

Bluetooth

In the App list, click “Settings”  to open the system setting app, and select the option “Bluetooth”.

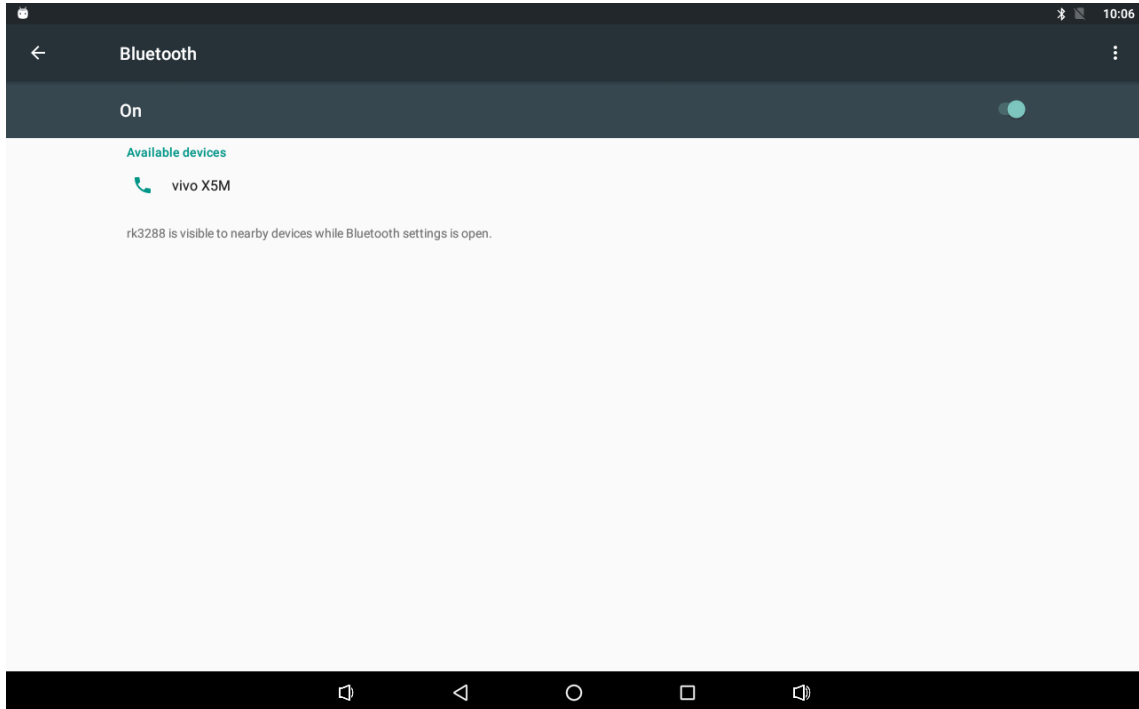

Switch the Bluetooth button to **ON**. The product will scan ambient available Bluetooth devices automatically.

If you want to pair another Bluetooth device, select it from the “Available Devices” list, and then click “Pair” in the pop-up window. At the same time, click “Pair” in the pop-up window of the Bluetooth device to be paired.

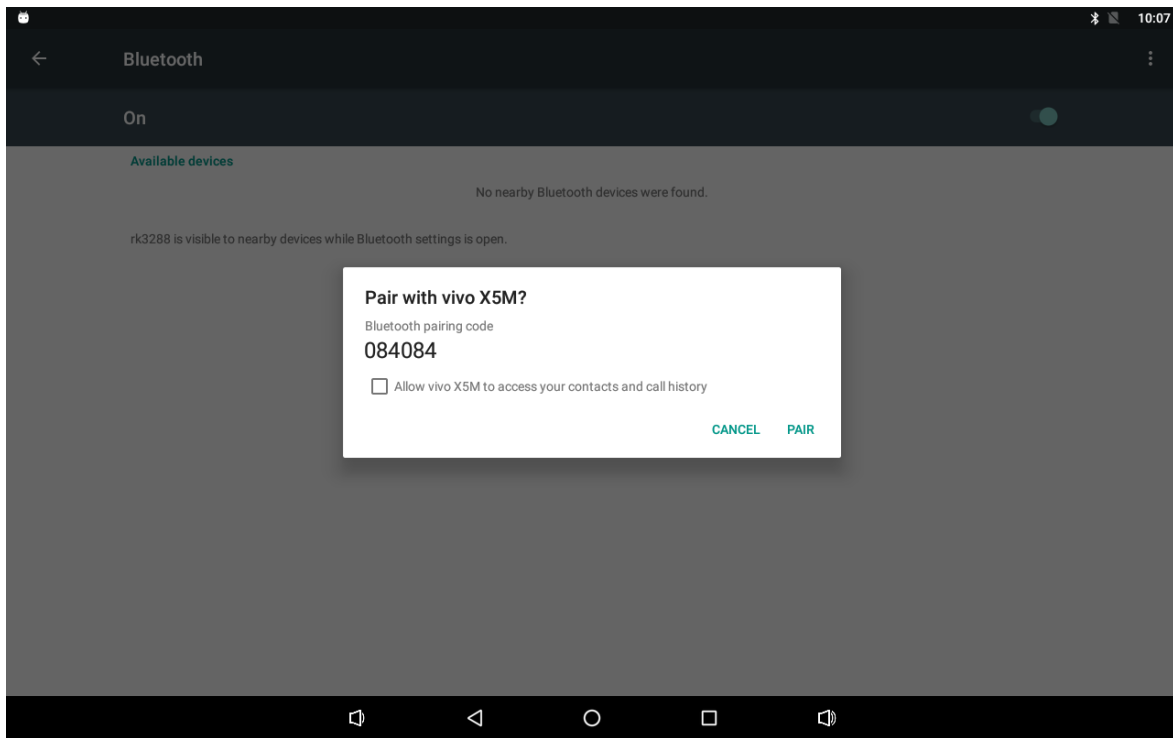

After pairing, the paired device will be moved to the “Paired Devices” list.

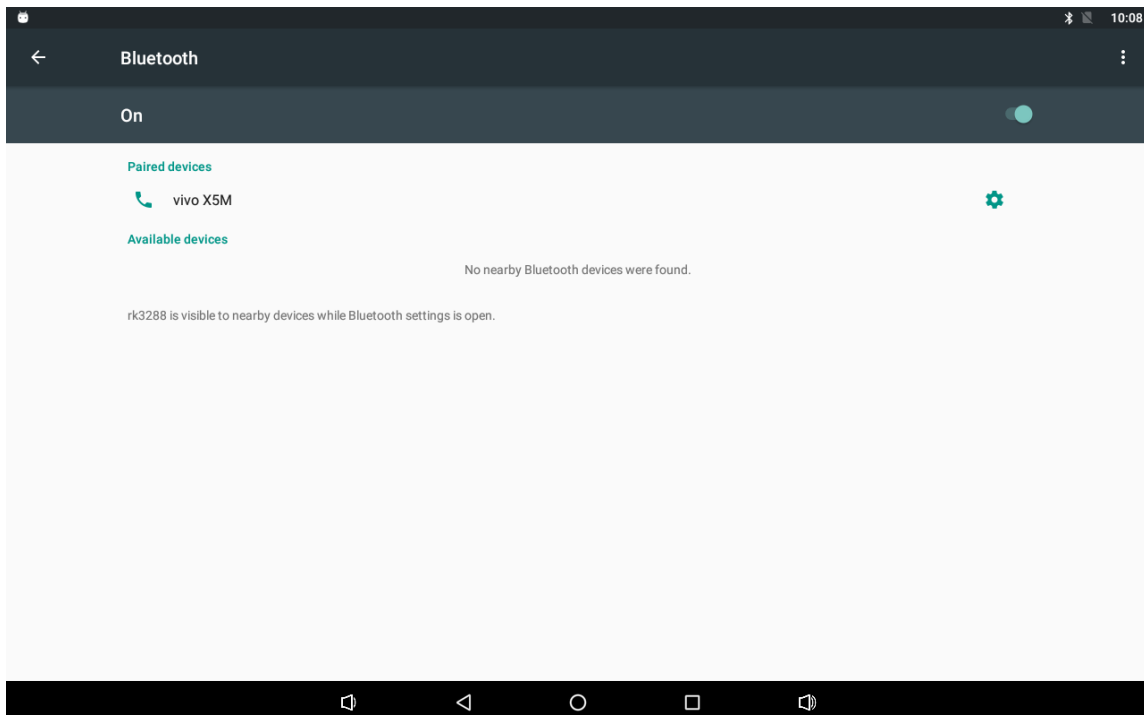

Click the three point icon in the upper right corner to pop up the setting interface, and select refresh、 rename this device and show received files.

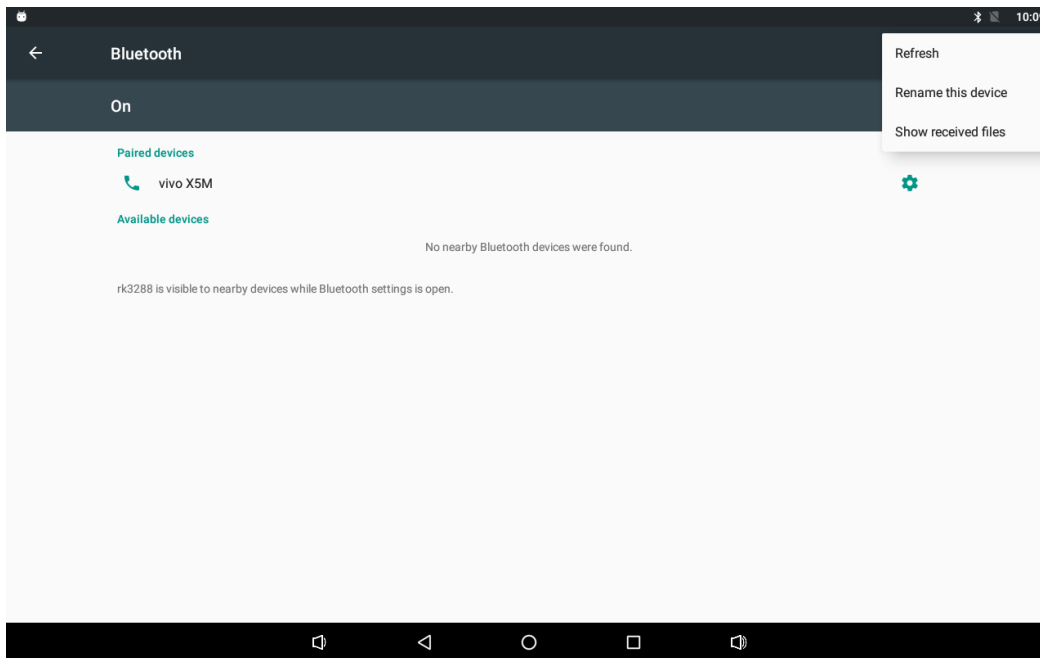

Virtual Keyboard

The device provides a virtual keyboard for typing. You can use it as a real one.

When you click in a text input box, the virtual keyboard will appear at the bottom of the screen.

To collapse the virtual keyboard, you can click the icon  in the system bar.

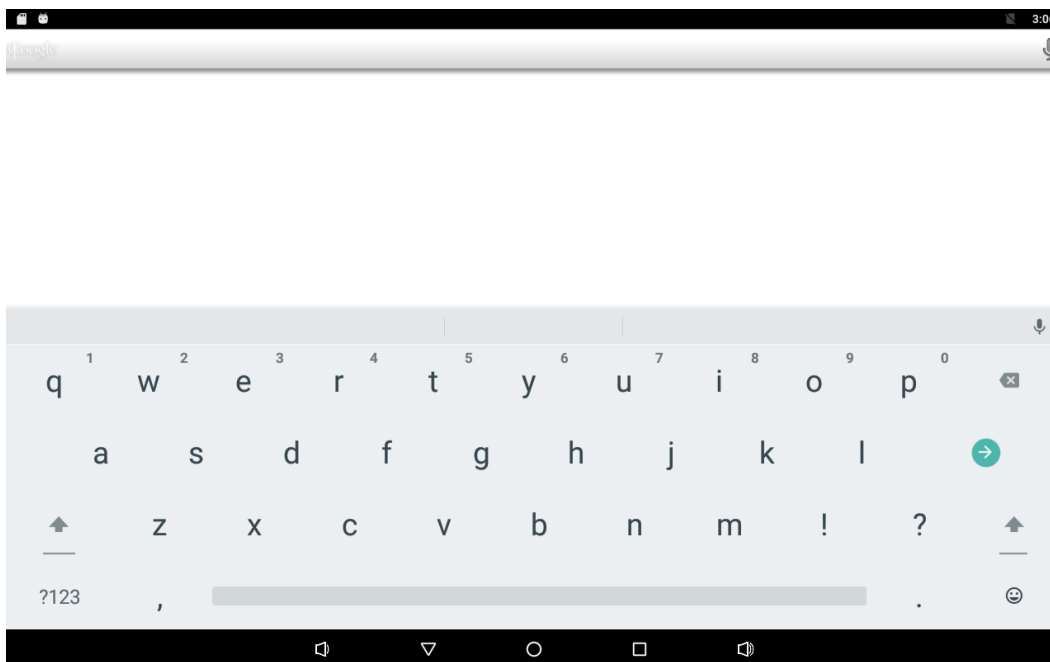

Switch Input Methods

If the keyboard icon is invisible, please check whether the installed input method is selected in the “**Language & input**” option under the system setting app.

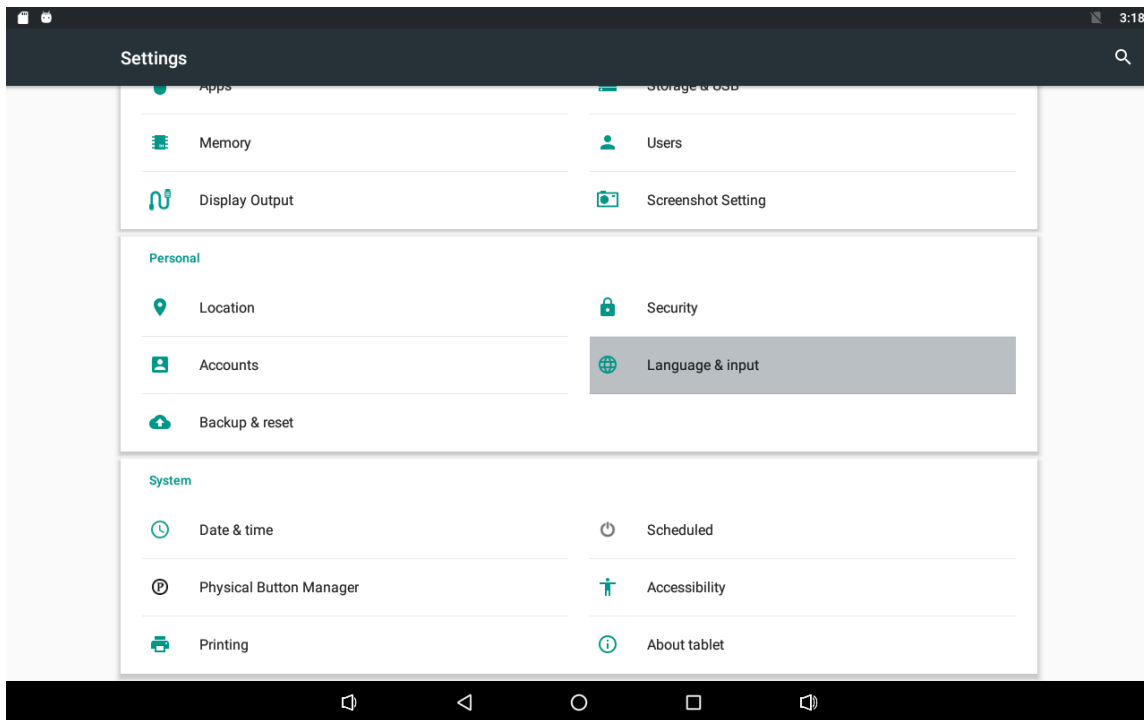

Select the current keyboard option to bring up the change keyboard dialog box.

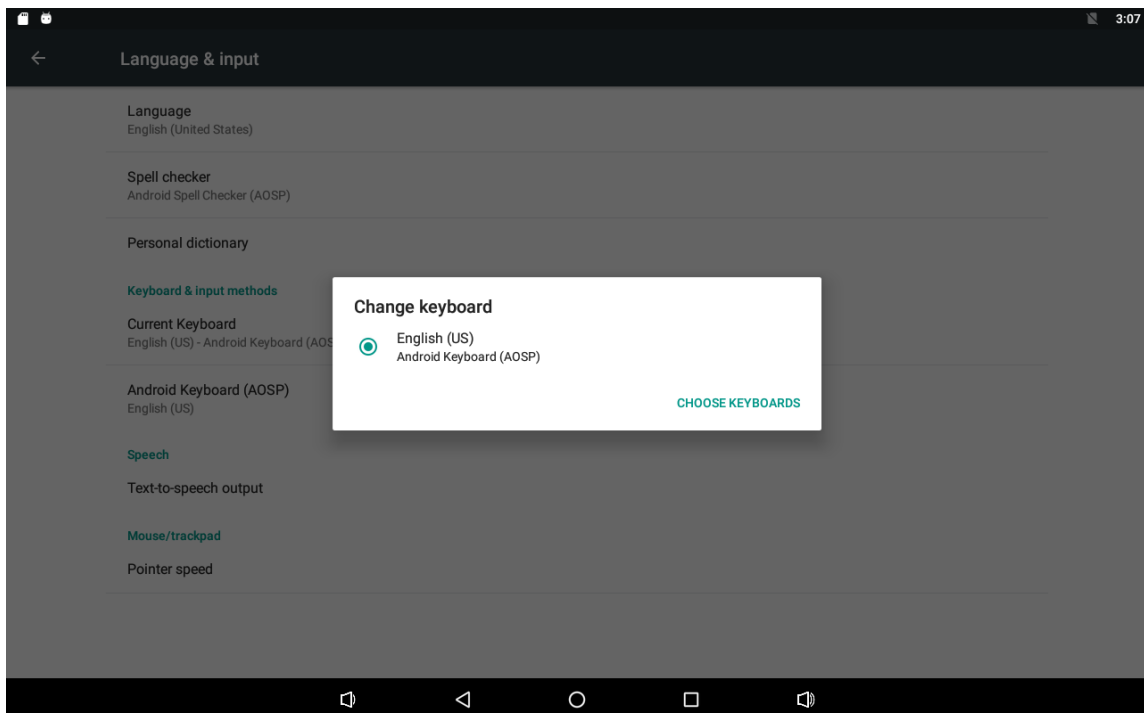

Surf Online

In the App list, open “**Browser**” .

When connecting the device to a network, you can visit websites, play online media or download files via the browser.

In a browser window, enter in a URL in the address bar and click “**Go**” in the virtual keyboard to go.

You can also click  to add new tabs to make multiple tabs opened simultaneously.



Browse Files

In the App list, open “**Explorer**”  to view local files.

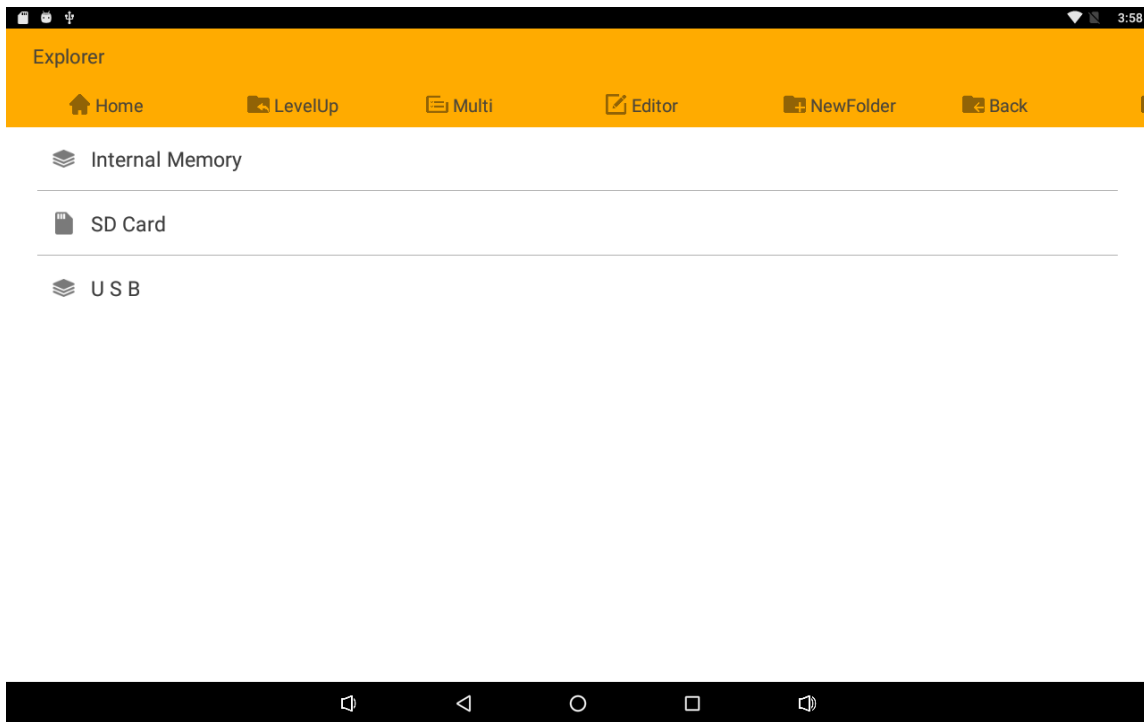

Take the usb drive as an example.

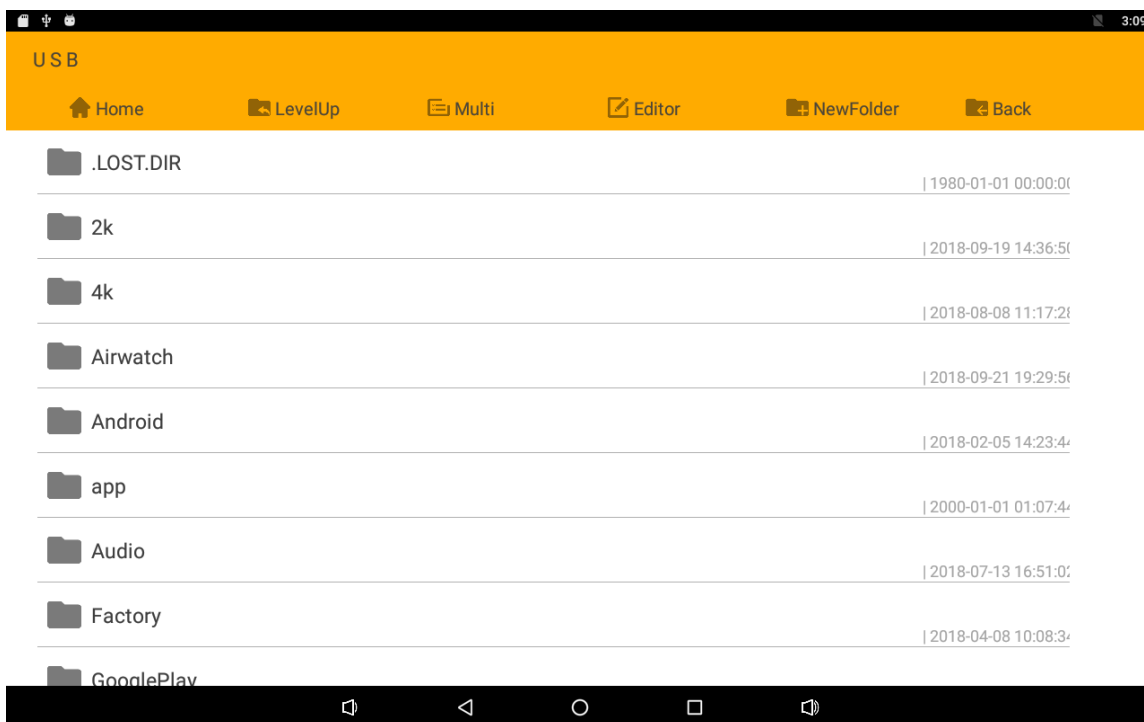

Long-press a file or folder to do file operations, such as copy, delete, move (cut), paste, rename, send (share) and create shortcut.

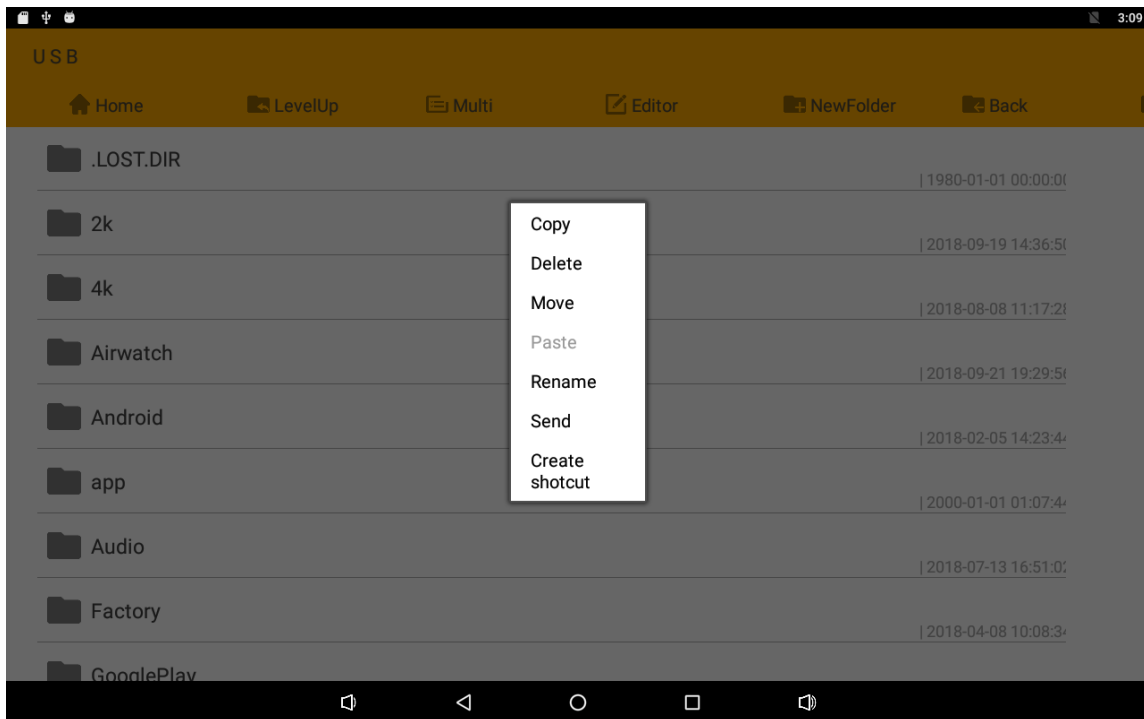

If you want to select several files/folders at once, click “Multi” in the menu, and then select files/folders. The selected files/folders will be highlighted in orange.

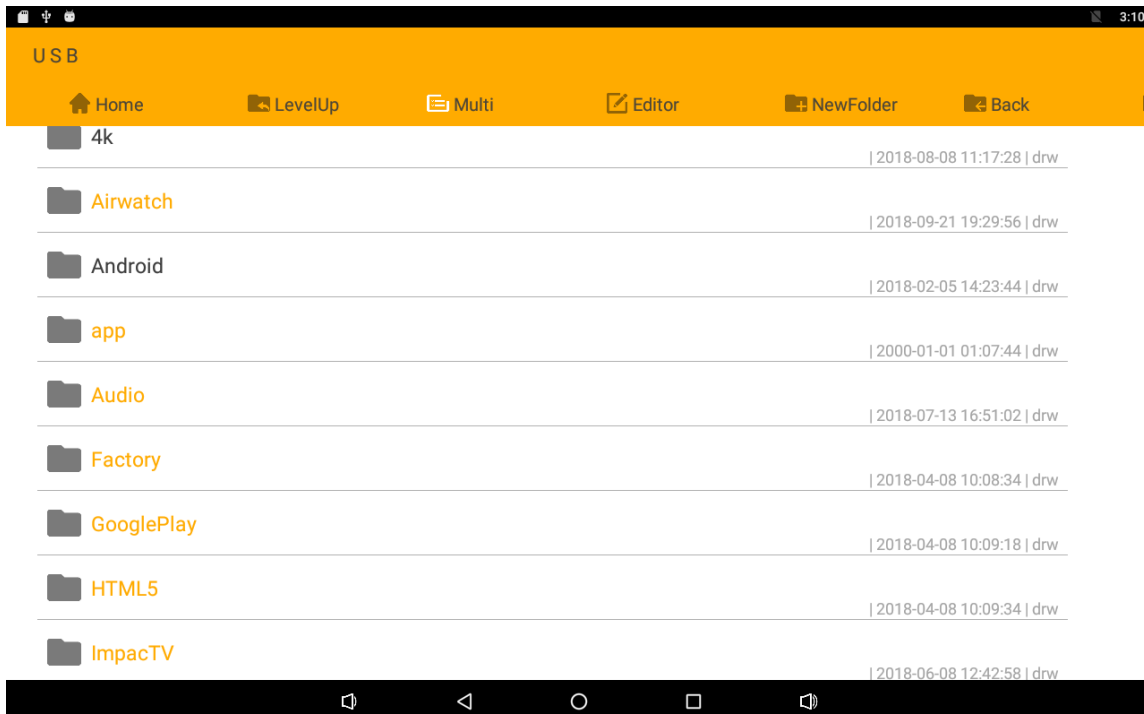

Click “Editor” in the menu to operate the selected files/folders.

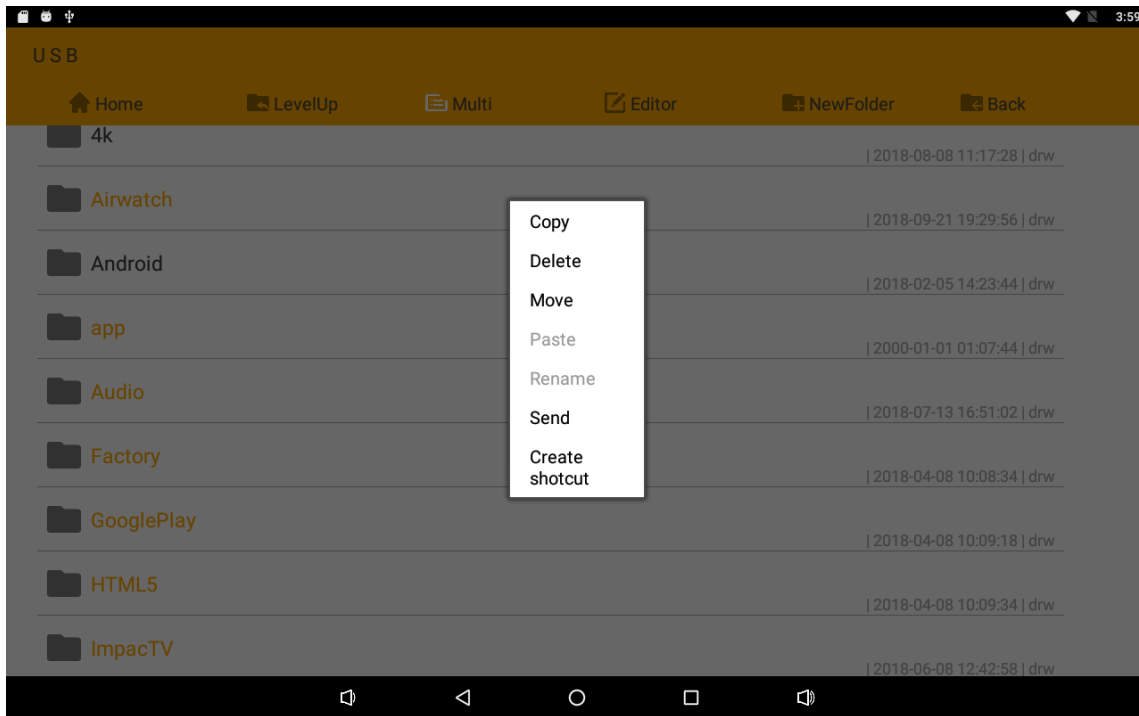

Play Media

With the provided apps, you can play your media files on your storage, such as pictures, music and videos.



Picture Player:

Support JPG, BMP, GIF.



Music Player:

Support MP2, WMA, WAV, AAC, OGG, ASF.



Video Player:

Support MKV, TS, FLV, AVI, VOB, MPG, DAT, ASF, RM, MOV, 3GP, MP4, WMV.

Install & Uninstall Apps

Install Apps

Before installing an app, please download the app (.apk) to via the browser, or copy a downloaded app to the device from your computer.

Then you can open “**ApkInstaller**”  in the App list to install the downloaded app.

First installation prompt “you need grant access READ_EXTERNAL_STORAGE” select ok.

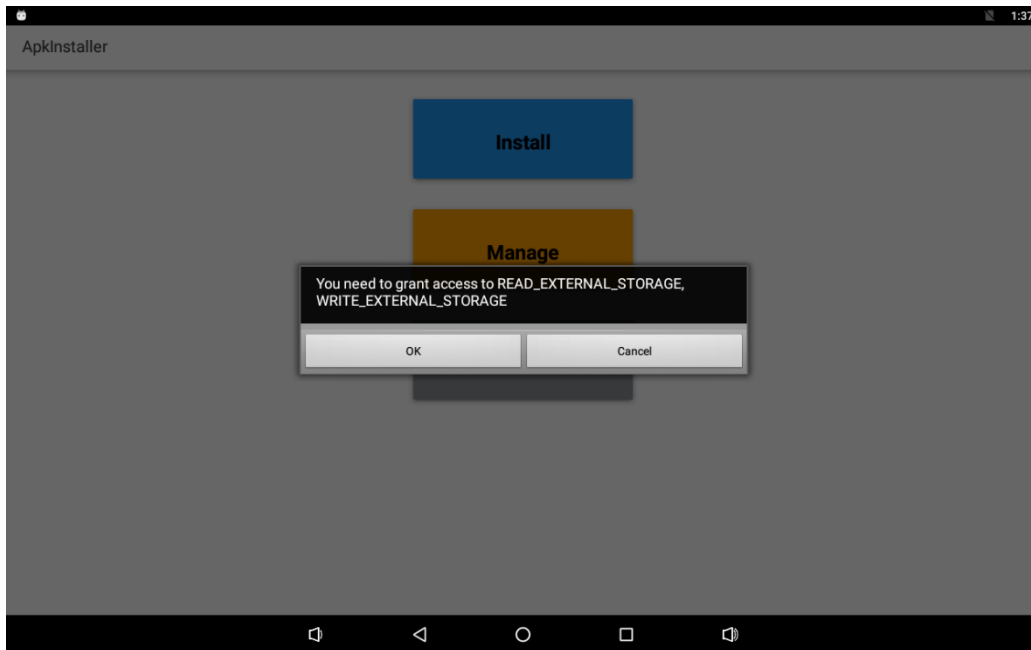

Choose “Allow”.

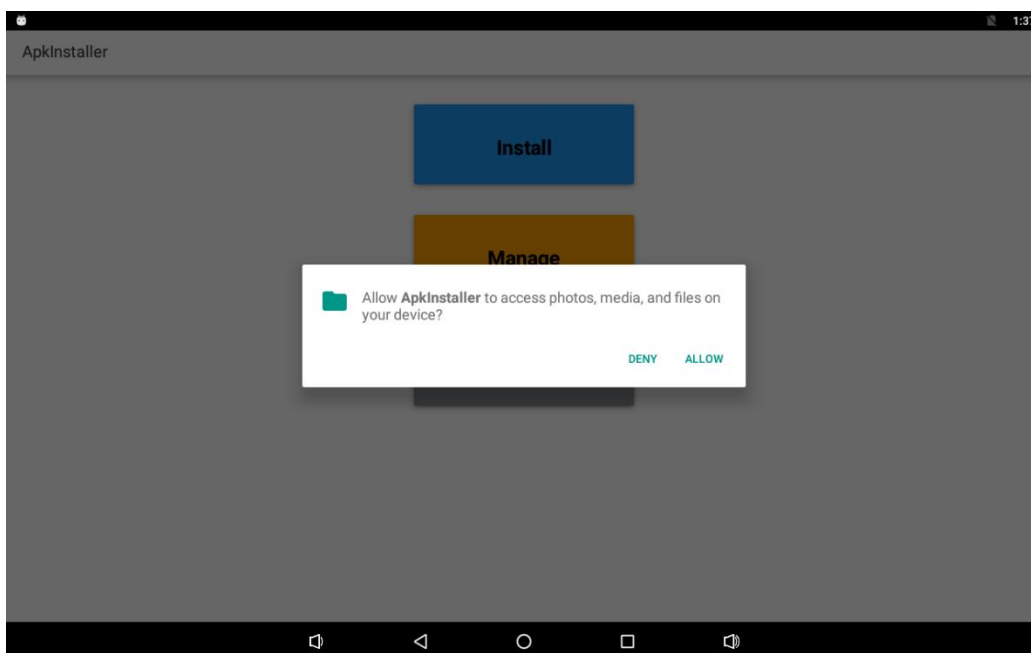

Enter the installation interface and click Install.

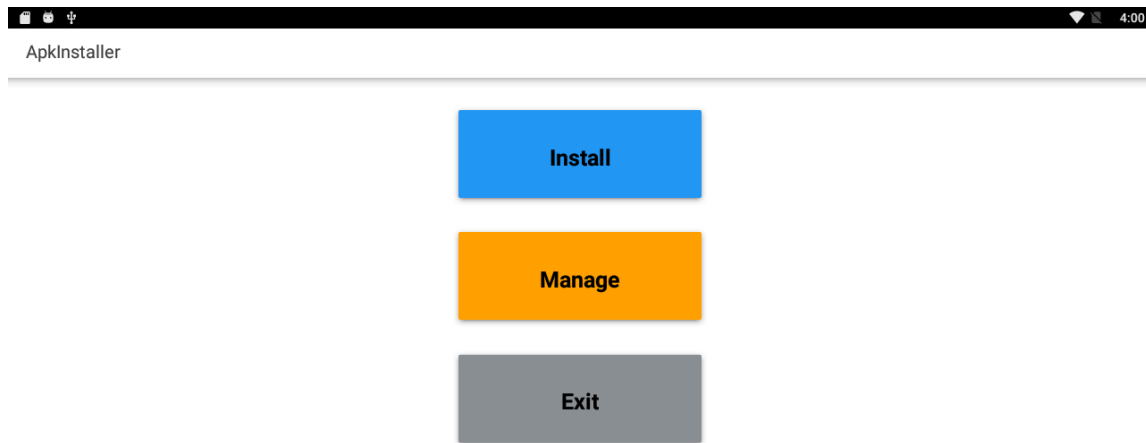

The apk files will be automatically scanned in the right side list.



Click the apk you want to install.

Click “Install” or “Next” until it turns to “Install”, and then waiting for installation finished.

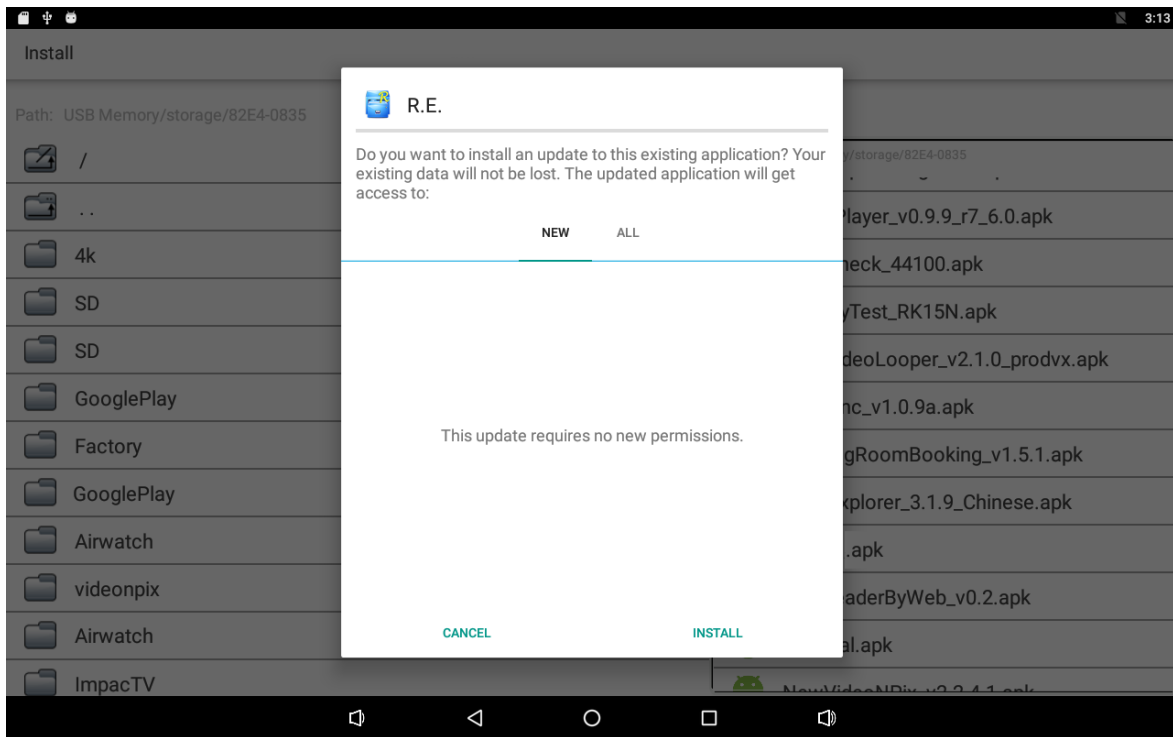

You can also download an android app market, and install the apps via the market.

If “Install blocked” is prompted when installing an app, please open “**Settings**” and select the option “**Security**”, allow “**Unknown sources**” and then back to reinstall the app.

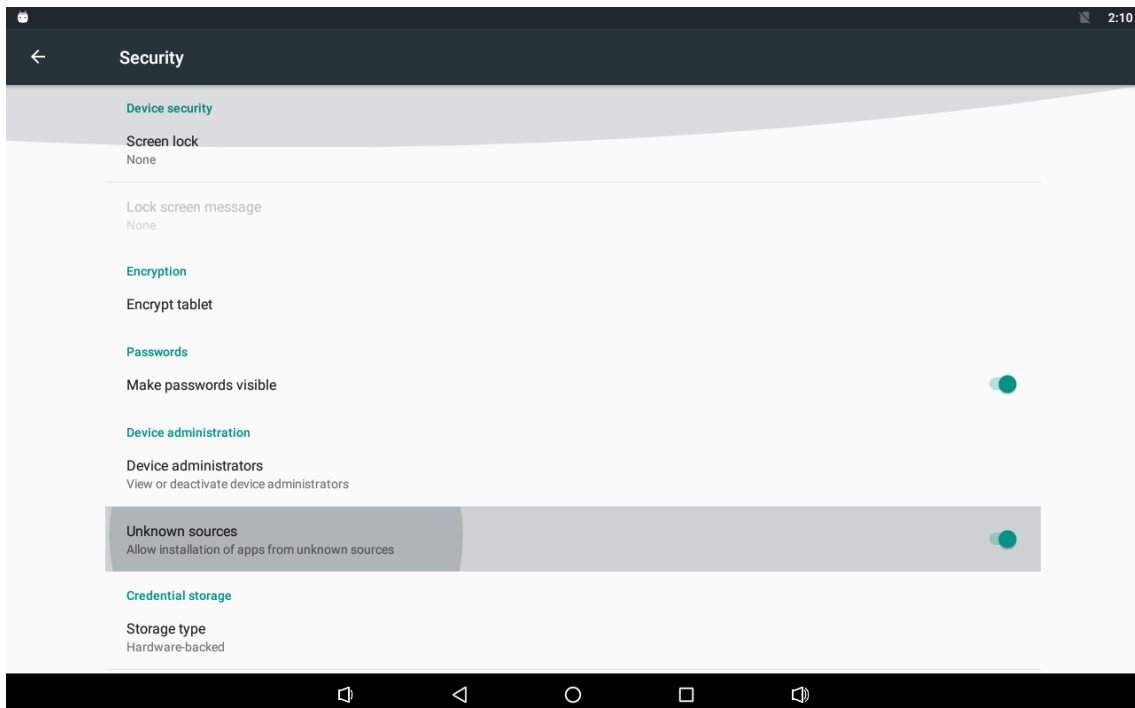

Uninstall Apps

To uninstall an app, please open “**Settings**” in the App list and select the option “**Apps**”. In this option, you will see the installed apps list.

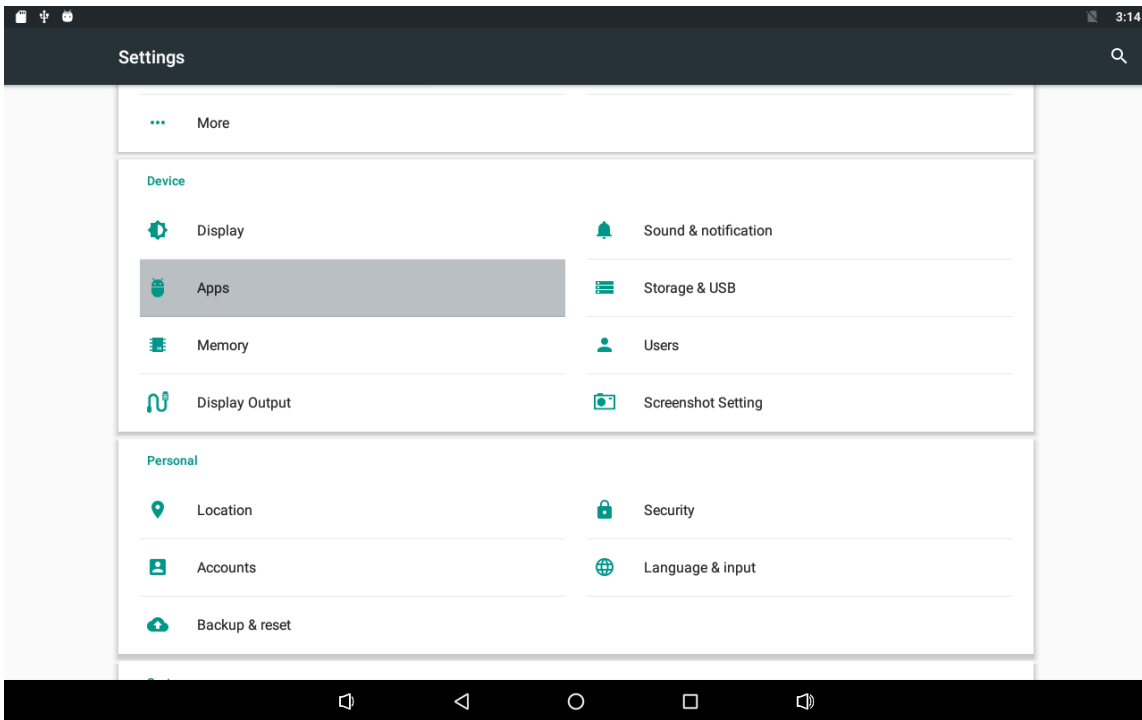

Click the app you want to remove to enter the detail page.

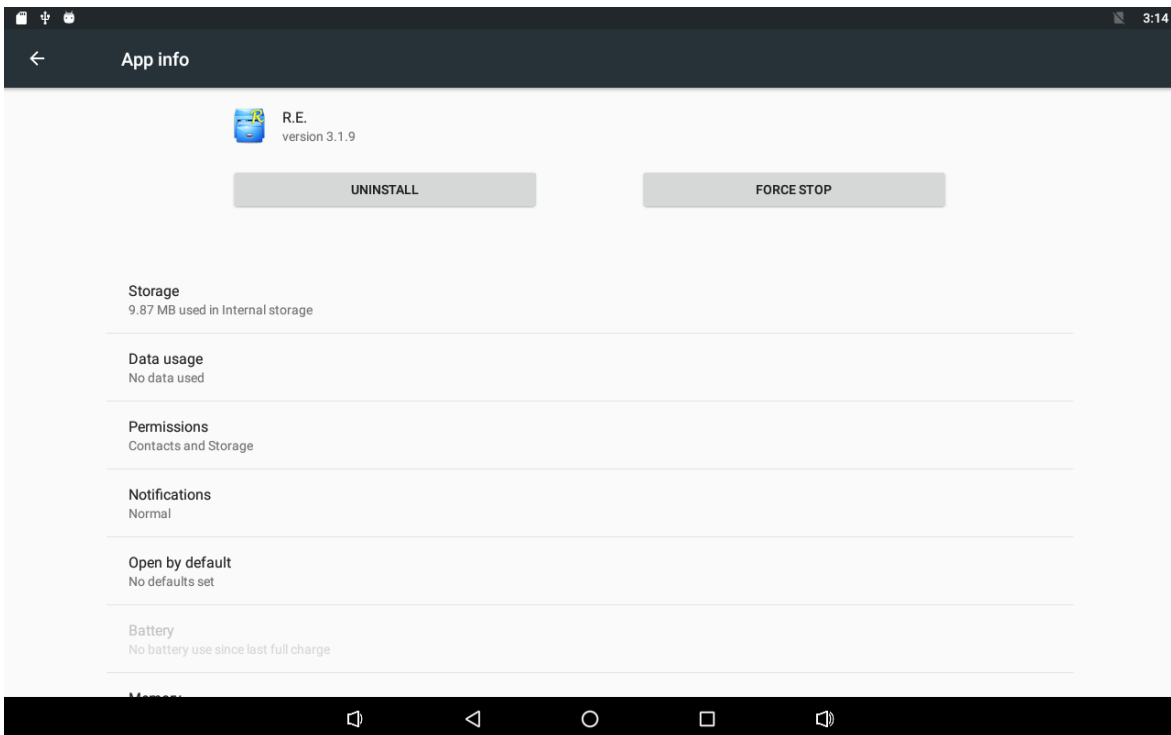

Click the **“Uninstall”** button and select **“OK”**, and then waiting for uninstallation finished.

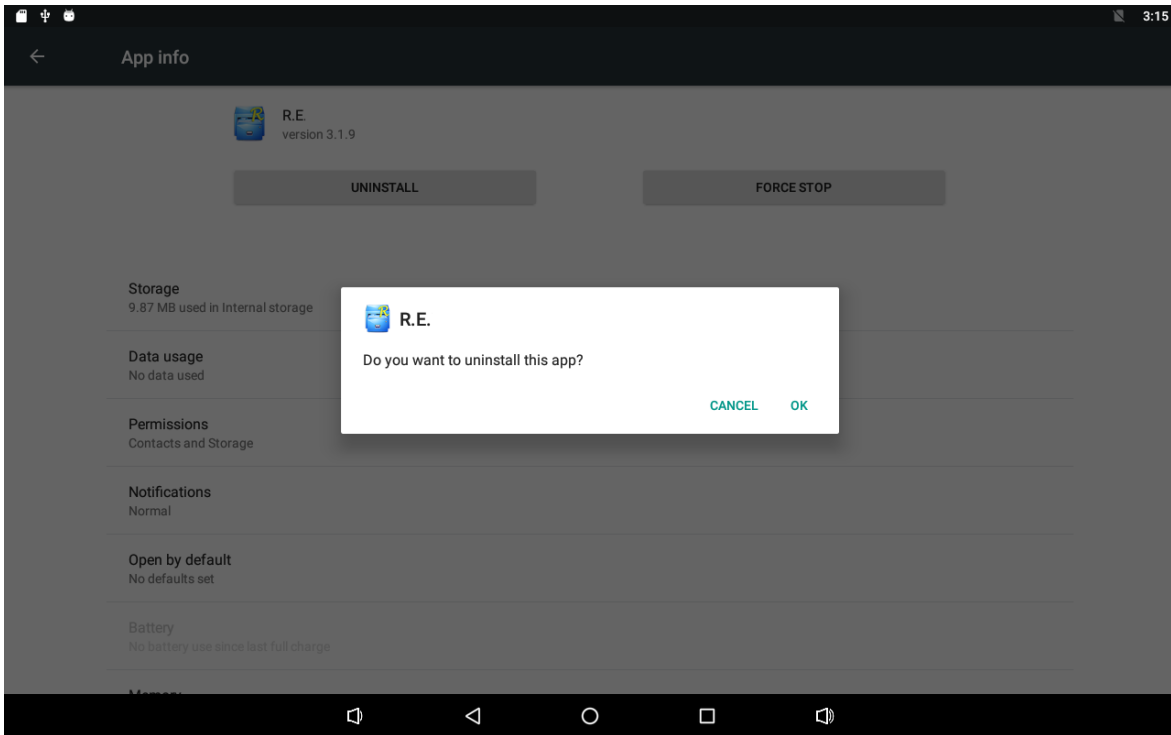

Reset to Factory Default

Please make sure to back up the important data before resetting the device.

In the App list, click **“Settings”**  to open the system setting app, and select the option **“Backup & reset”**.

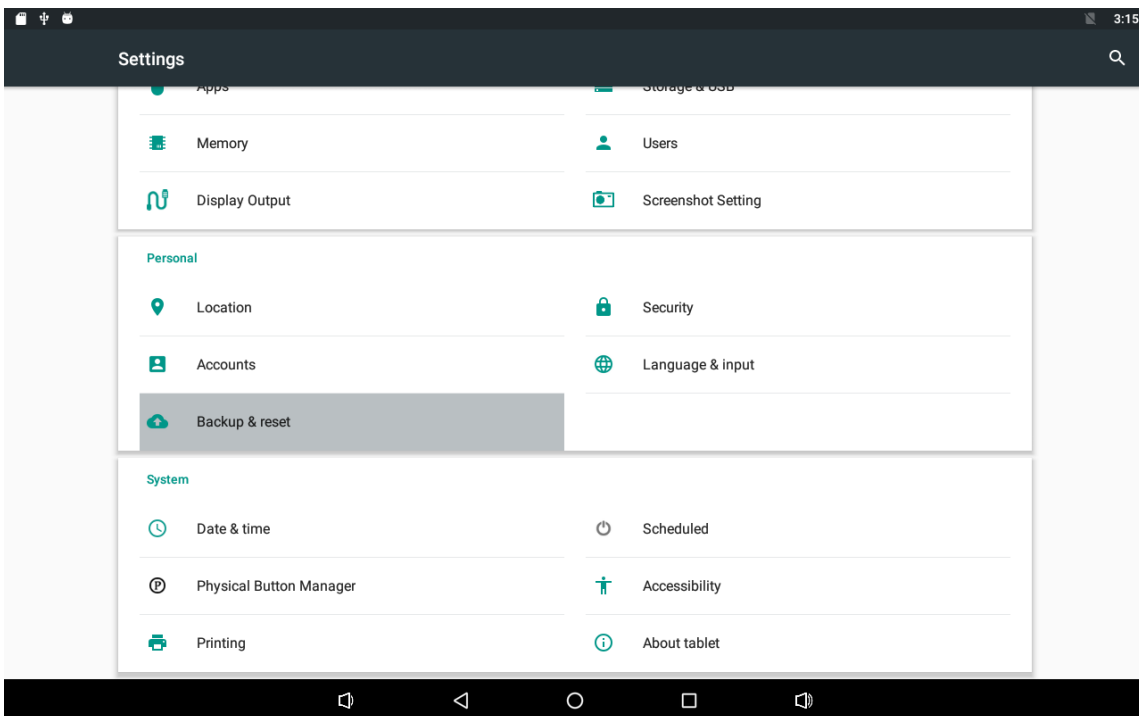

Click “Factory data reset”.

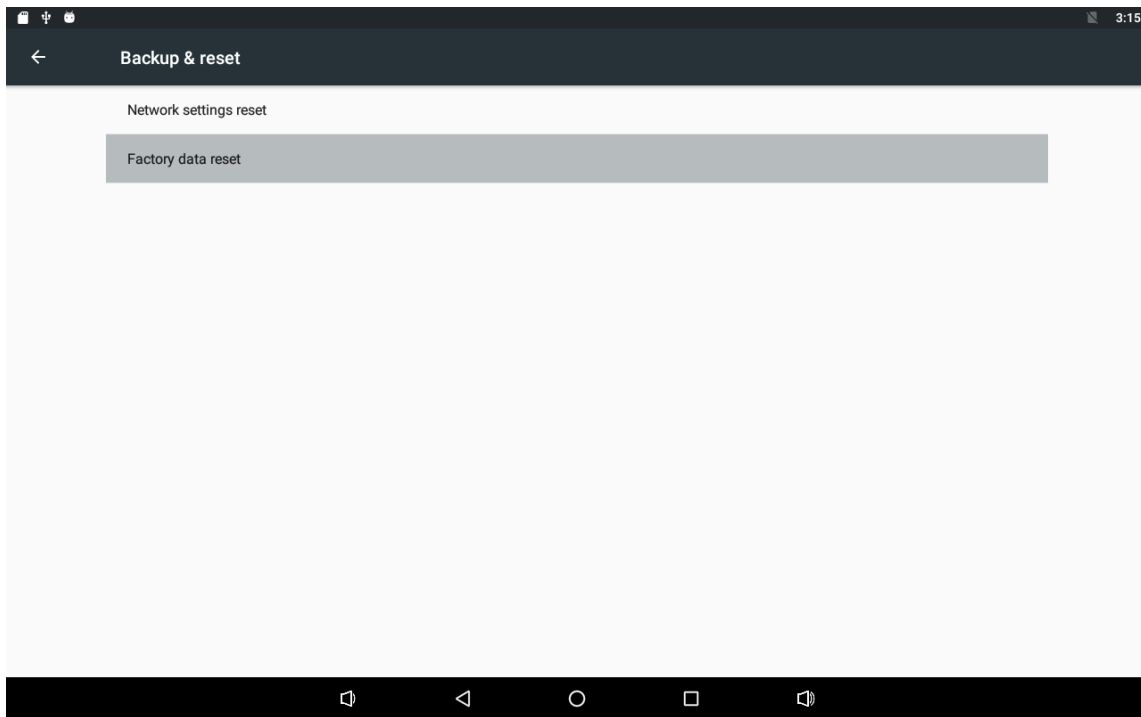

Click “Reset tablet” button.

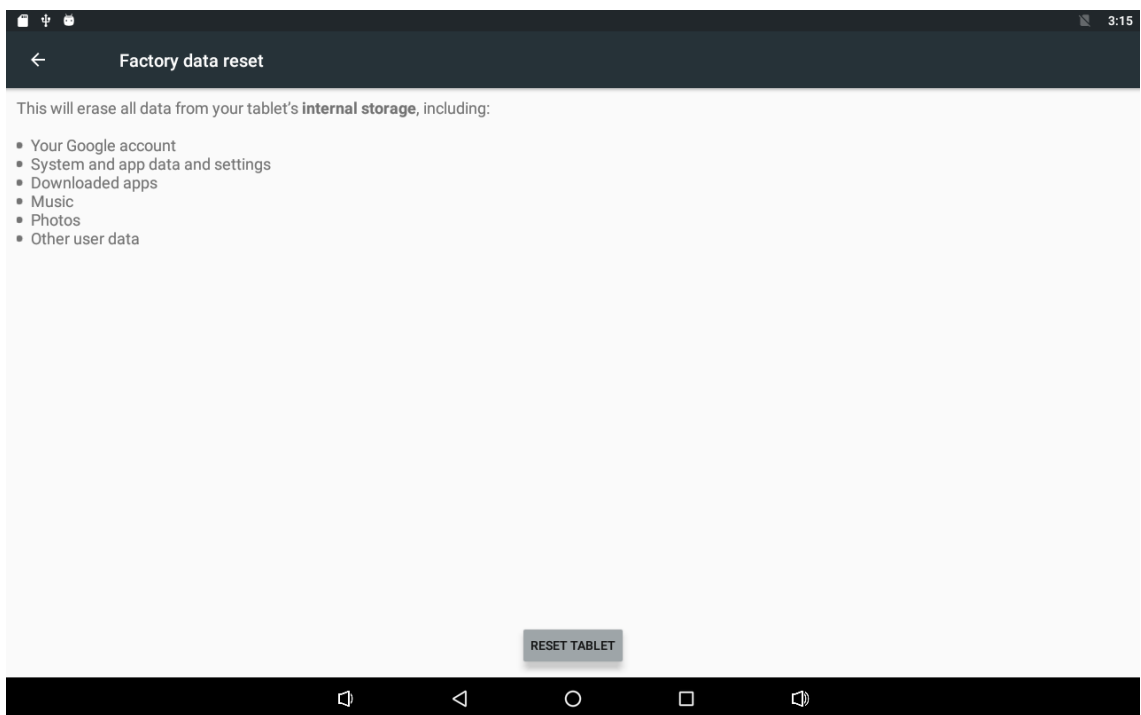

Click “Erase everything” button.

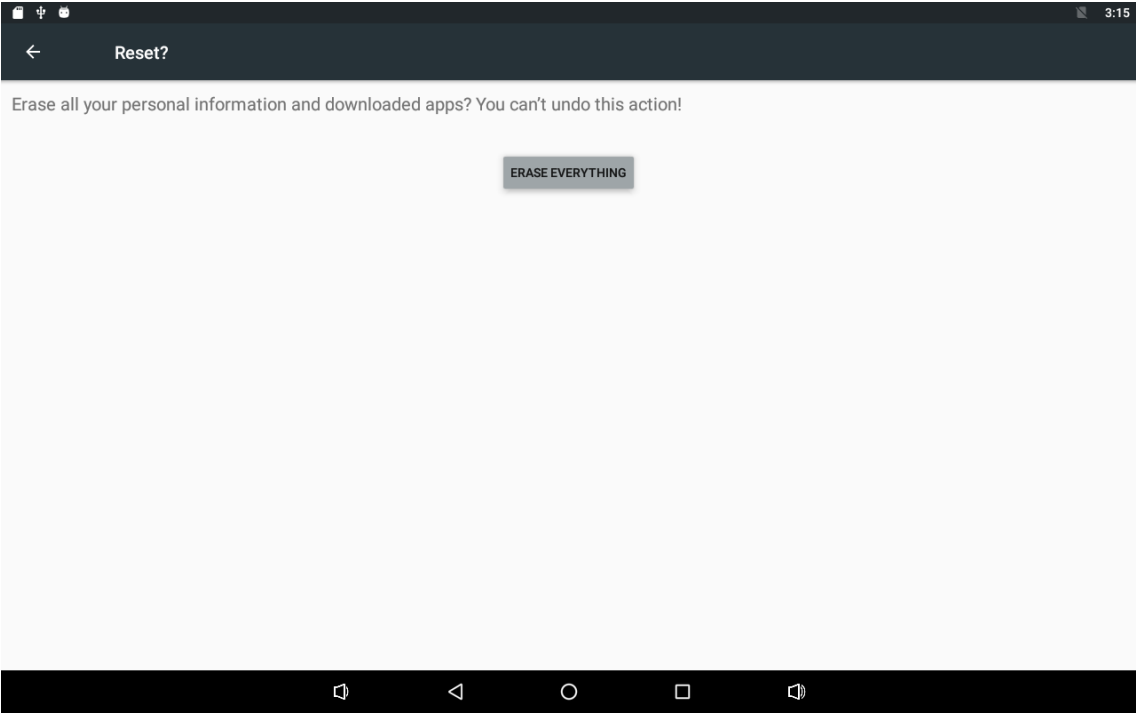

When the factory data reset window appears, wait for the system to restart and reset to the factory default.

