

Instruction manual: FS-10

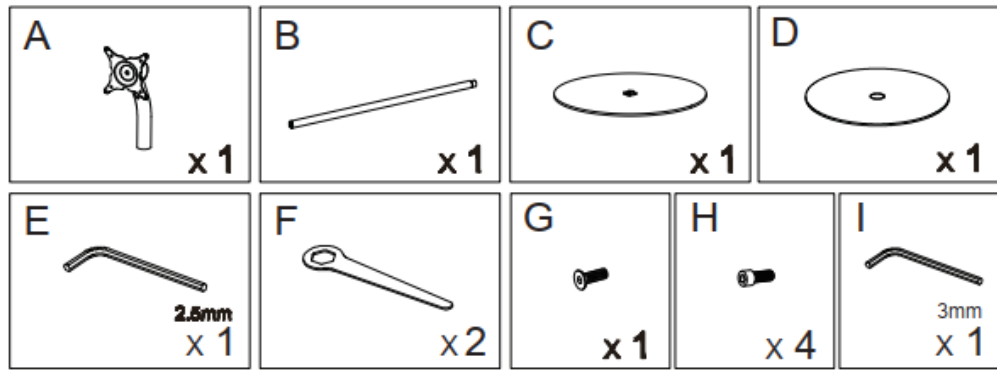

Step 1

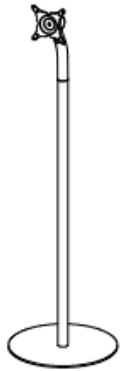
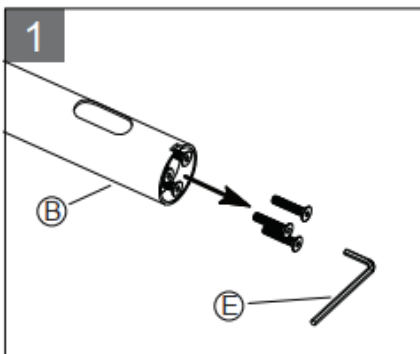

Step 2

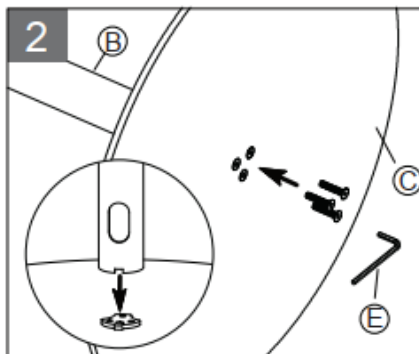

Step 3

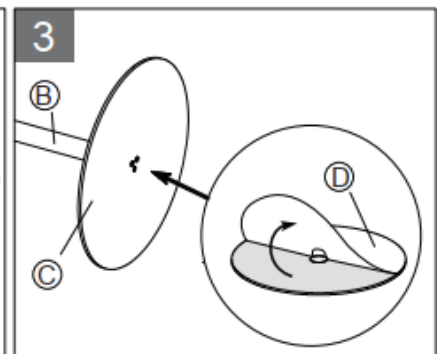

Step 4

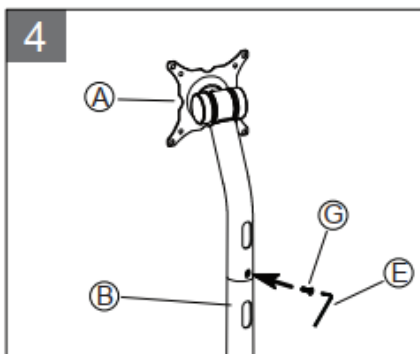

Step 5

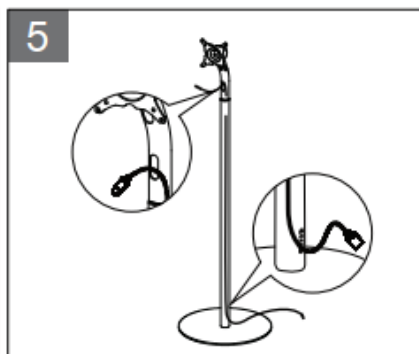

Step 6

