

52.562

Viewmate braccio porta monitor - soffitto 562

Prodotto per il fissaggio di uno schermo piatto al soffitto. Utilizzato ad esempio per terminali, punti informativi, postazioni di vendita, ecc. Durante l'installazione è possibile scegliere una delle sette impostazioni predefinite dell'altezza. Dopodiché, l'altezza si può regolare in tutta facilità utilizzando la leva morsetto.

- Intervallo di regolazione statica dell'altezza di 600 mm
- Profondità fissa
- Componenti principali in acciaio
- Compatibile con VESA MIS-D 75 x 75/100 x 100 mm
- Monitor: inclinazione +90°/-90°, orientabile+90°/-90°, rotazione 360°

- Capacità peso max. di 15 kg per monitor
- Dotato di fissaggio a soffitto
- Dimensioni massime monitor: altezza 1104 mm
- Facile da regolare in altezza utilizzando una leva morsetto
- Dotato di tutti i fissaggi necessari

viewmate ^x

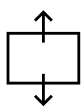
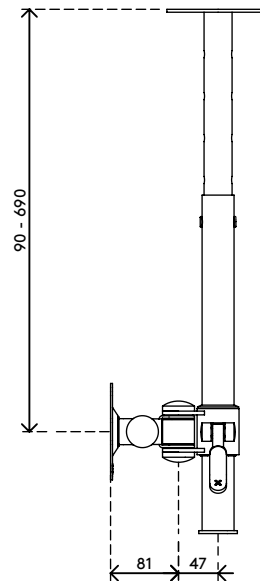
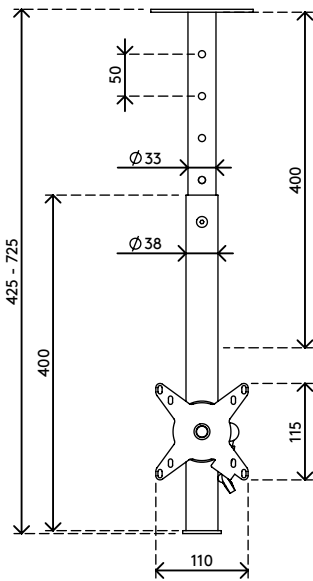
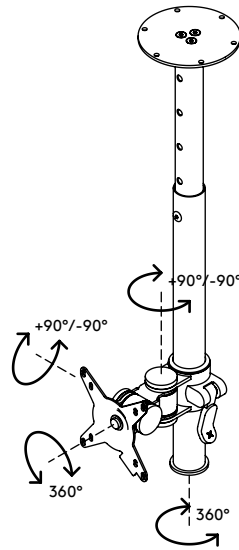
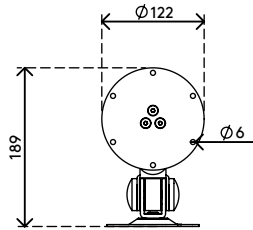

600 mm (23,6")



+90°/-90°

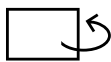

+90°/-90°



360°



1104 mm (43,5")



75 x 75/100 x 100



15 kg

Viewmate braccio porta monitor - soffitto 562

2019/06/27

52.562

 440 x 170 x 135 mm

 1 pcs

 argento

 2,9 kg

 805410525620