

T14s Gen 2 and X13 Gen 2 User Guide

ThinkPad



Lenovo

Read this first

Before using this documentation and the product it supports, ensure that you read and understand the following:

- *Safety and Warranty Guide*
- *Setup Guide*
- [Generic Safety and Compliance Notices](#)

Third Edition (August 2021)

© Copyright Lenovo 2021.

LIMITED AND RESTRICTED RIGHTS NOTICE: If data or software is delivered pursuant to a General Services Administration "GSA" contract, use, reproduction, or disclosure is subject to restrictions set forth in Contract No. GS-35F-05925.

Contents

Discover your Lenovo notebook.iii

Chapter 1. Meet your computer.1

Front view	1
Side view	3
Bottom view	5
Rear view	6
USB specifications	6

Chapter 2. Get started with your computer.9

Access networks	9
Connect to Wi-Fi networks.	9
Connect to the wired Ethernet	9
Connect to a cellular network (for selected models)	10
Turn on the Airplane mode.	10
Interact with your computer	10
Use the keyboard shortcuts	10
Use the TrackPoint pointing device	12
Use the trackpad	13
Use the touch screen (for selected models)	14
Connect to an external display	16

Chapter 3. Explore your computer19

Lenovo apps	19
Smart features (for selected models).	19
Intelligent cooling	22
Manage power	22
Check the battery status	23
Charge the computer.	23
Change the power settings	24
Transfer data	24
Set up a Bluetooth connection	25
Set up an NFC connection (for selected models)	25
Use a smart card (for selected models)	25
Accessories	26
Purchase accessories	26
Docking station	26

Chapter 4. Secure your computer and information31

Lock the computer	31
Log in with your fingerprint (for selected models)	31
Log in with your face ID (for selected models)	32

Detect human presence (for selected Intel models with IR camera)	32
Protect your privacy (for selected models)	33
Protect data against power loss (for selected models)	33
UEFI BIOS passwords	33
Password types	33
Set, change, and remove a password	35
Associate your fingerprints with passwords (for selected models)	36

Chapter 5. Configure advanced settings.37

UEFI BIOS	37
Enter the UEFI BIOS menu.	37
Navigate in the UEFI BIOS interface	37
Set the system date and time.	37
Change the startup sequence	37
Update UEFI BIOS	37
Install a Windows operating system and drivers	38

Chapter 6. CRU replacement41

CRU list	41
Disable Fast Startup and the built-in battery.	41
Replace a CRU	42
Base cover assembly	42
M.2 solid-state drive	44
Wireless WAN card (for selected models)	46
Keyboard (for ThinkPad X13 Gen 2)	48

Chapter 7. Help and support53

Frequently asked questions	53
Error messages	54
Beep errors	55
Self-help resources	56
Windows label	57
Call Lenovo	57
Before you contact Lenovo	57
Lenovo Customer Support Center	58
Purchase additional services.	59

Appendix A. Compliance information.61

Appendix B. Notices and trademarks.65

Discover your Lenovo notebook

Thank you for choosing a Lenovo® notebook! We are dedicated to delivering the best solution to you.

Before starting your tour, please read the following information:







- Illustrations in this documentation might look different from your product.
- Depending on the model, some optional accessories, features, software programs, and user interface instructions might not be applicable to your computer.
- Documentation content is subject to change without notice. To get the latest documentation, go to <https://pcsupport.lenovo.com>.

Chapter 1. Meet your computer

ThinkPad T14s Gen 2 and ThinkPad X13 Gen 2 might be shipped with different microprocessors, namely Intel® and Advanced Micro Devices (AMD). Hereby Intel models and AMD models are used to distinguish computer models with different microprocessors.

Front view



	Microphone*		Infrared (IR) camera* / Camera*
	Webcam privacy shutter*		Touch screen*
	Power button / Power button with fingerprint reader*		TrackPoint® pointing stick

	Near field communication (NFC) mark*		Trackpad
	TrackPoint buttons		Speaker

* for selected models



Webcam privacy shutter

Slide the webcam privacy shutter to cover or uncover the camera lens. It is designed to protect your privacy.

Related topics

- “Log in with your face ID (for selected models)” on page 32
- “Detect human presence (for selected Intel models with IR camera)” on page 32
- “Use the touch screen (for selected models)” on page 14
- “Log in with your fingerprint (for selected models)” on page 31
- “Use the TrackPoint pointing device” on page 12
- “Set up an NFC connection (for selected models)” on page 25
- “Use the trackpad” on page 13

Side view

Intel models

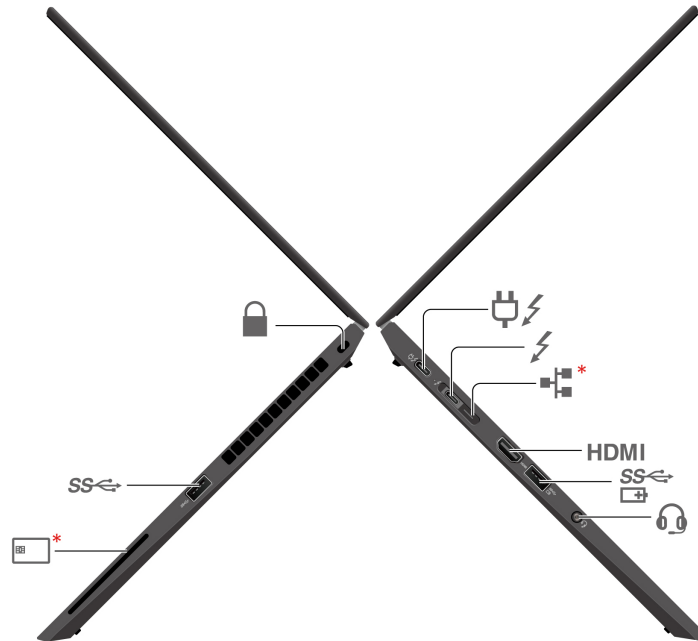

AMD models

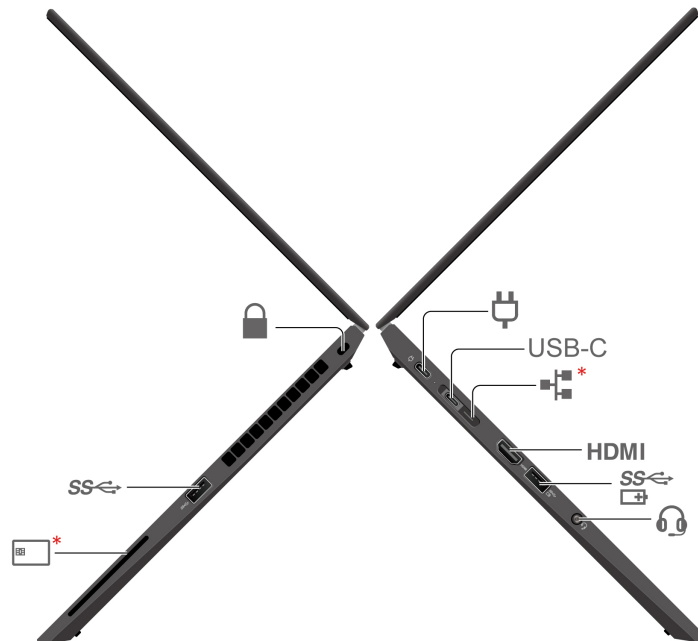

USB-C® (Thunderbolt™ 4) power connector









USB-C (3.2 Gen 2) power connector



USB-C (Thunderbolt 4) connector

USB-C

USB-C (3.2 Gen 2) connector

	Ethernet extension connector Gen 2*	HDMI	HDMI™ connector
	Always On USB 3.2 connector Gen 1		Audio connector
	Smart-card slot*		USB 3.2 connector Gen 1
	Security-lock slot		

* for selected models

Notes:

- For Intel models, the Ethernet extension connector Gen 2 and the adjoining USB-C (Thunderbolt 4) connector cannot be used simultaneously.
- For AMD models, the Ethernet extension connector Gen 2 and the adjoining USB-C (3.2 Gen 2) connector cannot be used simultaneously.



Ethernet extension connector Gen 2

- If your computer has this icon, it supports wired Ethernet connection with ThinkPad Ethernet Extension Adapter or ThinkPad Basic/Pro/Ultra Docking Station.
- If your computer does not have this icon, the Ethernet connector does not support Ethernet connection. We recommend you use the Lenovo USB-C to Ethernet Adapter for Ethernet connection.

Related topics

- “Charge the computer” on page 23
- “USB specifications” on page 6
- “Connect to an external display” on page 16
- “Connect to the wired Ethernet” on page 9
- “Use a smart card (for selected models)” on page 25
- “Lock the computer” on page 31

Bottom view



Emergency-reset hole



Emergency-reset hole

If the computer stops responding and you cannot turn it off by pressing the power button, reset your computer:

1. Disconnect your computer from ac power.
2. Insert a straightened paper clip into the hole to cut off power supply temporarily.
3. Connect your computer to ac power and then turn on your computer.

Rear view



Nano-SIM-card tray*

* for selected models

Related topic

“Connect to a cellular network (for selected models)” on page 10

USB specifications

Note: Depending on the model, some USB connectors might not be available on your computer.

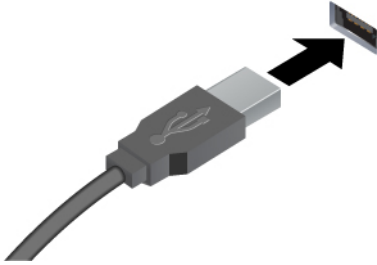
Connector name	Description
 <p>SS USB 3.2 connector Gen 1</p>	<p>Connect USB-compatible devices, such as a USB keyboard, USB mouse, USB storage device, or USB printer.</p>

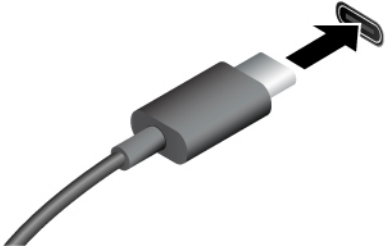
 <ul style="list-style-type: none"> • USB-C (3.2 Gen 2) connector • ⚡ USB-C (Thunderbolt 4) connector 	<ul style="list-style-type: none"> • Charge USB-C compatible devices with the output voltage and current of 5 V and 1.5 A. • Connect to an external display: <ul style="list-style-type: none"> – USB-C to VGA: up to 1920 x 1200 pixels, 60 Hz – USB-C to DP: <ul style="list-style-type: none"> – Intel models: up to 5120 x 3200 pixels, 60 Hz – AMD models: up to 5120 x 2880 pixels, 60 Hz • Connect to USB-C accessories to help expand your computer functionality. To purchase USB-C accessories, go to https://www.lenovo.com/accessories.
--	---

Statement on USB transfer rate

Depending on many factors such as the processing capability of the host and peripheral devices, file attributes, and other factors related to system configuration and operating environments, the actual transfer rate using the various USB connectors on this device will vary and will be slower than the data rate listed below for each corresponding device.

USB device	Data rate (Gbit/s)
3.2 Gen 1 / 3.1 Gen 1	5
3.2 Gen 2 / 3.1 Gen 2	10
3.2 Gen 2 x 2	20
Thunderbolt 3	40
Thunderbolt 4	40

Chapter 2. Get started with your computer

Access networks

This section helps you connect to a wireless or wired network.

Connect to Wi-Fi networks

Click the network icon in the Windows® notification area, and then select a network for connection. Provide required information, if needed.

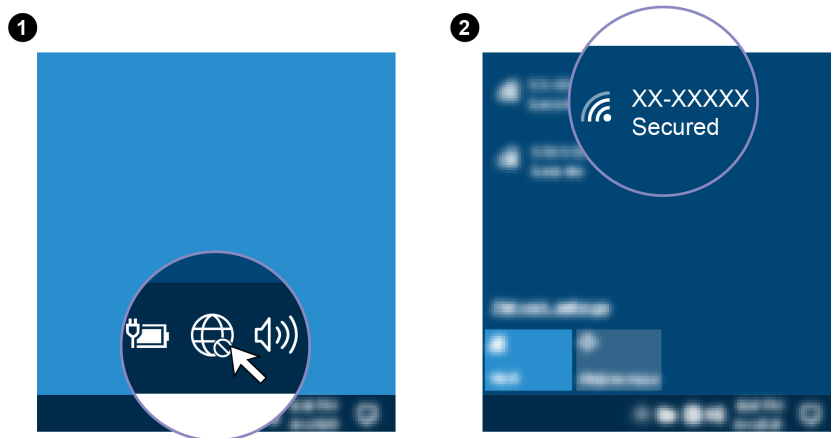

Connect to the wired Ethernet

Connect your computer to a local network through Ethernet extension connector Gen 2 on your computer with an Ethernet cable. To attach an Ethernet cable to your computer, you need one of the following accessories:

- Lenovo USB-C to Ethernet adapter
- ThinkPad Ethernet Extension Adapter Gen 2

Note: ThinkPad Ethernet Extension Adapter is only compatible with computers that have the Ethernet icon



The Ethernet Extension Adapter and USB-C to Ethernet adapter are available as options and shipped with some computer models. You can purchase them from Lenovo at <https://www.lenovo.com/accessories>.

Notes:

- For Intel models, the Ethernet extension connector Gen 2 and the adjoining USB-C (Thunderbolt 4) connector cannot be used simultaneously.
- For AMD models, the Ethernet extension connector Gen 2 and the adjoining USB-C (3.2 Gen 2) connector cannot be used simultaneously.

Connect to a cellular network (for selected models)

To connect a 4G or 5G cellular data network, you must have a wireless wide area network (WWAN) card and a nano-SIM card installed. The nano-SIM card might come with your computer by countries or regions. If no nano-SIM card is shipped, you will need to purchase one from authorized service carriers.

Depending on model, your computer might have no WWAN card installed. For installation procedures of the WWAN card, see “Wireless WAN card (for selected models)” on page 46.

Notes:

- The 4G or 5G cellular service is provided by authorized mobile service carriers in some countries or regions. You must have a cellular plan from a service carrier to connect to the cellular network. The cellular data plan might vary by location.
- Network connection speeds might also vary by location, environment, network conditions and other factors.

To establish a cellular connection:

1. Turn off the computer.
2. Locate the nano-SIM card slot and insert the nano-SIM card as shown. Note the orientation of the card and ensure that it is seated correctly.

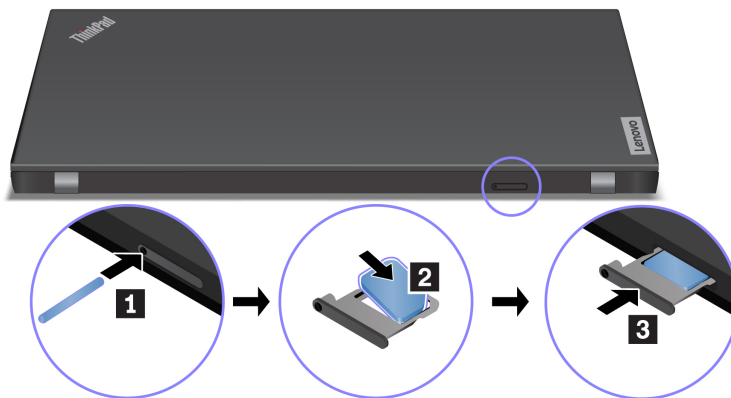

3. Turn on the computer.
4. Click the network icon, and then select the cellular network icon  from the list. Provide required information, if needed.

Turn on the Airplane mode

When the Airplane mode is enabled, all wireless features are disabled.

1. Click the action center icon  in the Windows notification area.
2. Click **Airplane mode** to turn on the Airplane mode.

Interact with your computer

























Your computer provides you various ways to navigate the screen.









Use the keyboard shortcuts

The special keys on the keyboard help you work more effectively.



<https://support.lenovo.com/us/en/videos/vid500145>

		Invoke the special function printed as an icon on each key or standard function of F1–F12 function keys.
		FnLock indicator on: standard function
		FnLock indicator off: special function
		Enable / disable speakers
		Decrease volume
		Increase volume
		Enable / disable microphones
		Darken display
		Brighten display
		Manage external displays
		Enable / disable the Airplane mode
		Open / collapse notification center
		Answer incoming calls on Microsoft Teams.
		Decline incoming calls on Microsoft Teams.
		Customize the function of this key on the Vantage app
		Open Snipping Tool
		Toggle keyboard backlight
		Break operation
		Pause operation
		Scroll contents

 + 	Send system request
 + 	Enter sleep mode To wake up the computer, press Fn or the power button.
 + 	Go to beginning
 + 	Go to end

Use the TrackPoint pointing device

The TrackPoint pointing device enables you to perform all the functions of a traditional mouse, such as pointing, clicking, and scrolling.

Use the TrackPoint pointing device

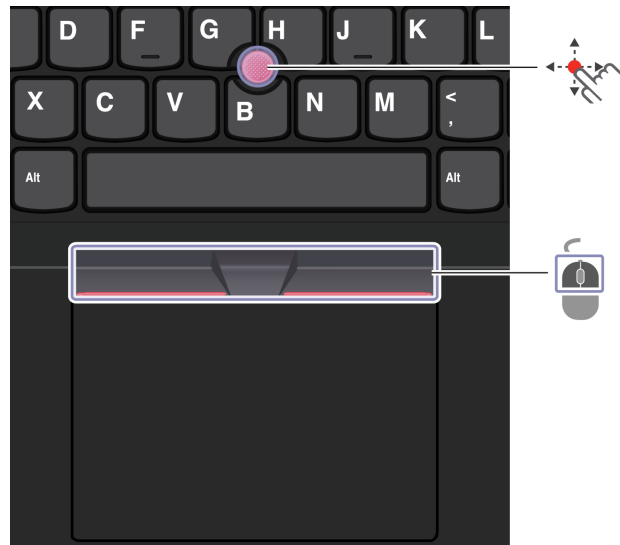

TrackPoint pointing stick

Use your finger to apply pressure to the pointing-stick nonslip cap in any direction parallel to the keyboard. The pointer on the screen moves accordingly. The higher the pressure applied, the faster the pointer moves.



TrackPoint buttons

The left-click button and right-click button correspond to the left and right buttons on a traditional mouse. Press and hold the dotted middle button while using your finger to applying pressure to the pointing stick in the vertical or horizontal direction. Then, you can scroll through the document, Web site, or apps.

Disable the TrackPoint pointing device

The TrackPoint pointing device is active by default. To disable the device:

1. Open the **Start** menu, and then click **Settings → Devices → Mouse**.
2. Follow the on-screen instructions to disable TrackPoint.

Replace the pointing-stick nonslip cap

Note: Ensure that the new cap has grooves **a**.

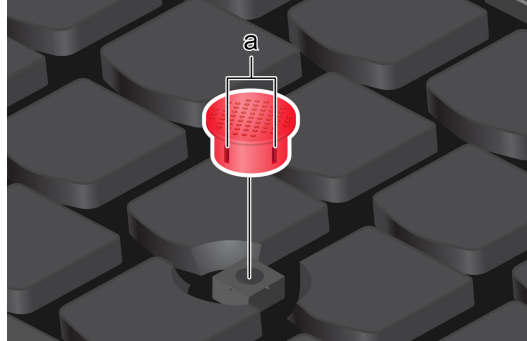

Use the trackpad

You can use the trackpad to perform all the pointing, clicking, and scrolling functions of a traditional mouse.

Use the trackpad

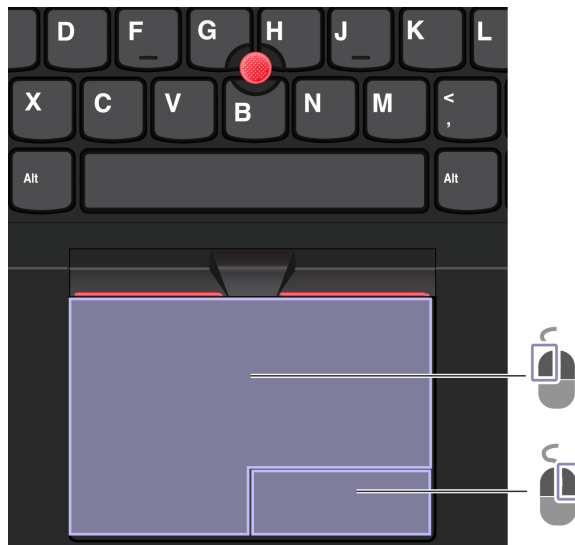

	Left-click zone		Right-click zone
---	-----------------	---	------------------

Use the touch gestures

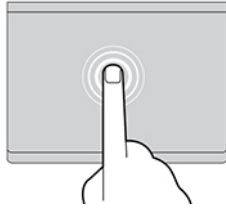

Tap once to select or open an item.

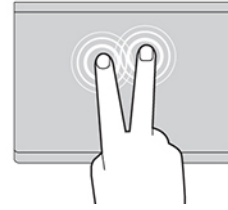

Tap twice quickly to display a shortcut menu.

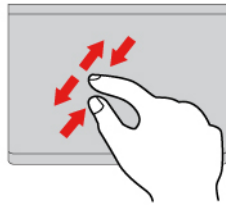

Two-finger zoom in or zoom out.

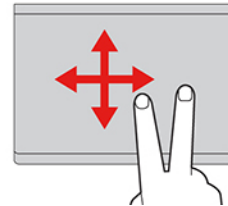

Scroll through items.

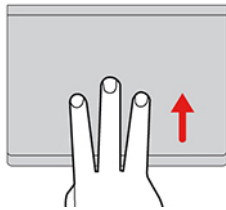

Open the task view to see all open windows.

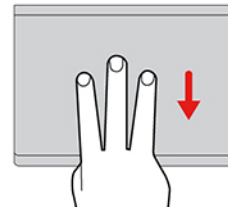

Show the desktop.

Notes:

- When using two or more fingers, ensure that you position your fingers slightly apart.
- Some gestures are not available if the last action was done from the TrackPoint pointing device.
- Some gestures are only available when you are using certain apps.
- If the trackpad surface is stained with oil, turn off the computer first. Then, gently wipe the trackpad surface with a soft and lint-free cloth moistened with lukewarm water or computer cleaner.

For more gestures, see the help information of the pointing device.

Disable the trackpad

The trackpad is active by default. To disable the device:

1. Open the **Start** menu, and then click **Settings** → **Devices** → **Touchpad**.
2. In the Touchpad section, turn off the **Touchpad** control.

Use the touch screen (for selected models)

If your computer display supports the multi-touch function, you can navigate the screen with simple touch gestures.

Note: Some gestures might not be available when you are using certain apps.



Tap once to single click



Tap twice quickly to double-click



Tap and hold to right-click

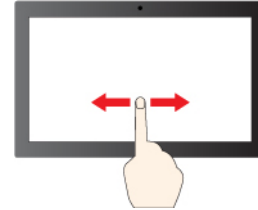

Slide to scroll through items

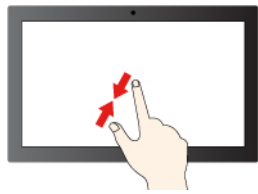

Zoom out

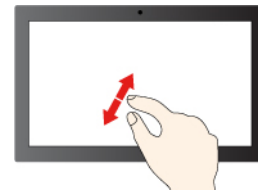

Zoom in

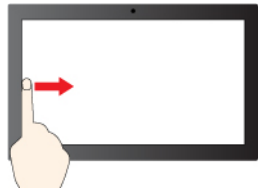

Swipe from the left: view all open windows



Swipe from the right: open action center

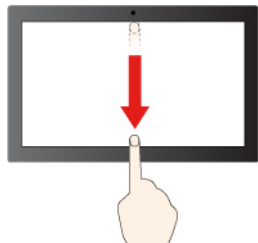

Swipe downwards shortly: show title bar

Swipe downwards: close the current app

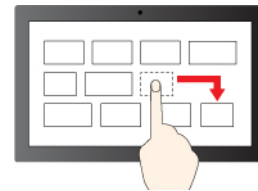

Drag

Maintenance tips:

- Turn off the computer before cleaning the touch screen.
- Use a dry, soft, and lint-free cloth or a piece of absorbent cotton to remove fingerprints or dust from the touch screen. Do not apply solvents to the cloth.
- The touch screen is a glass panel covered with a plastic film. Do not apply pressure or place any metallic object on the screen, which might damage the touch panel or cause it to malfunction.
- Do not use fingernails, gloved fingers, or inanimate objects for input on the screen.
- Regularly calibrate the accuracy of the finger input to avoid a discrepancy.

Connect to an external display

Connect your computer to a projector or a monitor to give presentations or expand your workspace.

Connect to a wired display

If your computer cannot detect the external display, right-click a blank area on the desktop and select display settings. Then follow the on-screen instructions to detect the external display.

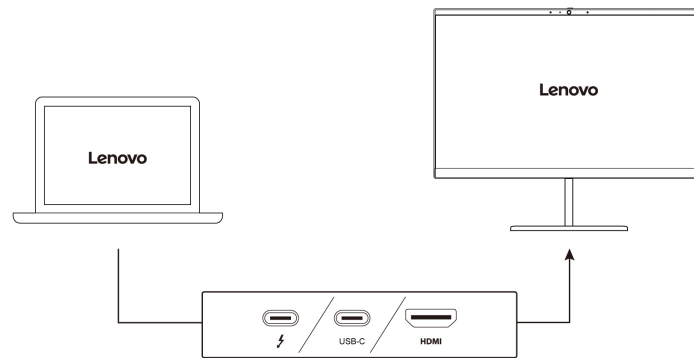

The following tables list the supported maximum resolution of the external display.

Table 1. Intel models

Connect the external display to	Supported resolution
USB-C (Thunderbolt 4) connectors	Up to 5120 x 3200 pixels / 60 Hz
HDMI connector	Up to 4096 x 2160 pixels / 60 Hz

Table 2. AMD models

Connect the external display to	Supported resolution
USB-C (3.2 Gen 2) connectors	Up to 5120 x 2880 pixels / 60 Hz
HDMI connector	Up to 3840 x 2160 pixels / 60 Hz



Notes: For AMD models, the HDMI connector on your computer supports the HDMI 2.0 standard by default. If you connect an external display to your computer through the HDMI connector with an HDMI 1.4 cable, the external display might not work. In this case, do one of the following:

- Use a qualified HDMI 2.0 cable.



- Change the HDMI standard of the HDMI connector from 2.0 to 1.4. To change the HDMI standard, enter the UEFI BIOS menu (see “Enter the UEFI BIOS menu” on page 37), and then configure **HDMI Mode Select** in the **Config** menu.

Connect to a wireless display

To use a wireless display, ensure that both your computer and the external display support the Miracast® feature.

Press  +  and then select a wireless display to connect with.

Set the display mode

Press  or  +  and then select a display mode of your preference.

Change display settings

1. Right-click a blank area on the desktop and select display settings.
2. Select the display that you want to configure and change display settings of your preference.

You can change the settings for both the computer display and the external display. For example, you can define which one is the main display and which one is the secondary display. You also can change the resolution and orientation.

Chapter 3. Explore your computer

Lenovo apps

This section provides introduction to the Vantage and Lenovo Quick Clean apps.

The Vantage app

The preinstalled Vantage app is a customized one-stop solution to help you maintain your computer with automated updates and fixes, configure hardware settings, and get personalized support.

To access the Vantage app, type *Vantage* in the Windows search box.

Key features

The Vantage app enables you to:

- Know the device status easily and customize device settings.
- Download and install UEFI BIOS, firmware, and driver updates to keep your computer up-to-date.
- Monitor your computer health, and secure your computer against outside threats.
- Scan your computer hardware and diagnose hardware problems.
- Look up warranty status (online).
- Access *User Guide* and helpful articles.

Notes:

- The available features vary depending on the computer model.
- The Vantage app makes periodic updates of the features to keep improving your experience with your computer. The description of features might be different from that on your actual user interface.

Lenovo Quick Clean



Depending on the model, your computer might support the Lenovo Quick Clean feature. The preinstalled Lenovo Quick Clean enables you to temporarily disable the keyboard, screen, trackpad, and TrackPoint pointing device for cleaning.

To access Lenovo Quick Clean, do one of the following:

- Type *Lenovo Quick Clean* in the Windows search box.
- Press *Fn* and the right *Shift* key at the same time.

To download the latest version of Lenovo Quick Clean, go to <https://pcsupport.lenovo.com>.

Smart features (for selected models)

Your computer might be preinstalled with *Glance* by Mirametrix®. *Glance* can capture your head movement through camera and makes your computer smarter and more efficient.

Access Glance by Mirametrix

Type Glance in the Windows search box and then press Enter.

Note: If Glance is uninstalled, you can request it through <https://support.lenovo.com/contactus>.

Explore key features

Depending on the model, some features might not be available on your computer.

- **Protect privacy**

- **Presence Detection:** Keep your computer awake when in use and automatically lock the computer when your head moves out of the camera range.

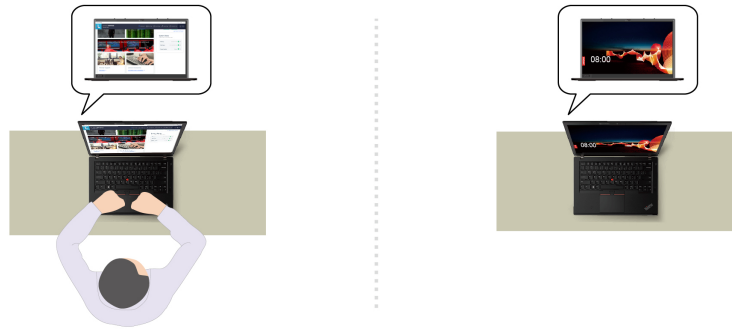

- **Privacy Alert:** When a shoulder surfer is detected, an alert icon appears on your computer screen.



- **Privacy Guard:** When a shoulder surfer is detected, your screen is blurred. Press Alt+F2 to cancel the blur effect.

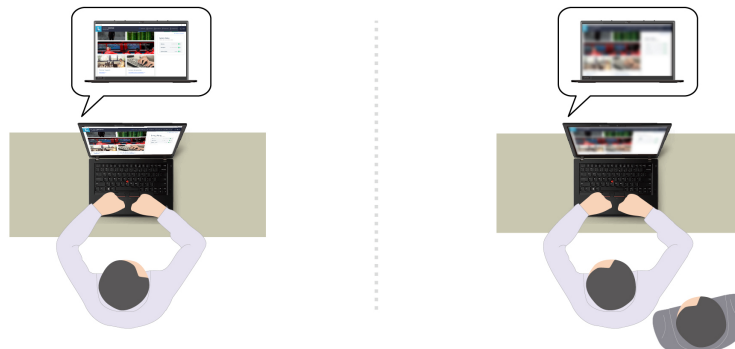

- **Smart Display:** Blur screens you are not looking at. If you are not facing any screen, all screens are blurred. Press Alt+F2 to cancel the blur effect.



Note: If your computer comes with an ePrivacy screen, it can work with Glance to achieve better privacy protection. For details, go to <https://support.lenovo.com/us/en/videos/vid500144>.

- **Improve productivity**

- **Snap Window:** When you select a window on one screen and turn your face to another, the window automatically snaps to the top center of the screen you are facing.

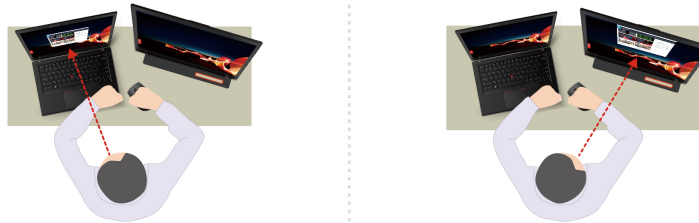

- **Smart Pointer:** Relocate the pointer to the screen you are facing. When the pointer moves from one screen to another, it is temporarily drawn large.

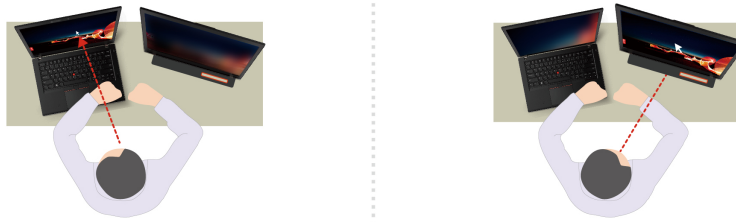

Note: Snap Window and Smart Pointer only work when your computer is connected to external displays. Ensure that external displays are placed at the same height of your computer.

- **Promote digital wellness**

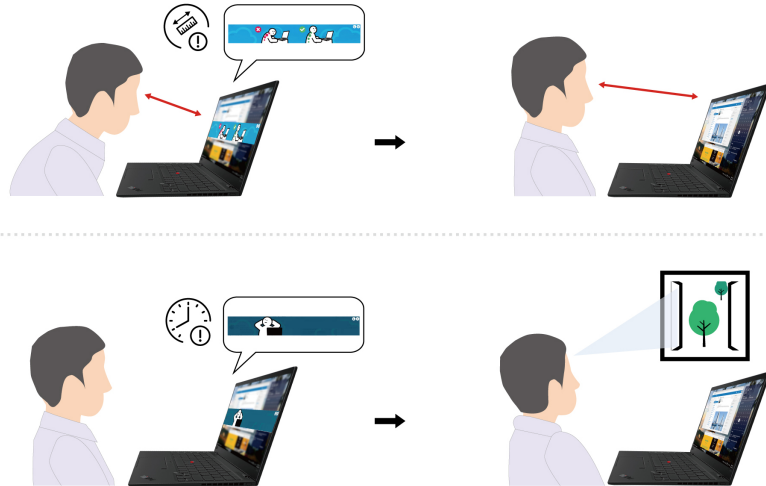

- **Posture check:** Remind you to adjust your posture once you hunch toward the screen.
- **20/20/20 Alert:** Remind you to look away from the screen and relax your eyes for 20 seconds every 20 minutes.



Intelligent cooling

The Intelligent Cooling feature helps you adjust fan speed, computer temperature and performance.

Manual mode

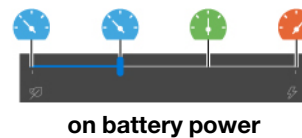
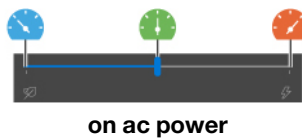

-  Quiet mode: the least fan noise
-  Balanced mode: balanced performance and fan noise
-  Performance mode: the highest performance and normal fan noise



Do the following to select the preferred mode:

1. Click the battery status icon in the Windows notification area.
2. Move the slider to the left or right to select your preferred mode.

Auto mode (for Intel models only)

-  Auto battery mode: Switch between quiet mode and battery mode automatically based on the amount of system activity.
-  Auto performance mode: Switch among quiet mode, balanced mode and performance mode automatically based on the amount of system activity.

Note: The Intelligent Cooling feature works in auto mode by default for Intel models. Press Fn+T to switch between manual mode and auto mode.

Manage power

Use the information in this section to achieve the best balance between performance and power efficiency.

Check the battery status



Click the battery icon in the Windows notification area to check the battery status, view the current power plan, change the power mode, and access battery settings quickly. For more details about your battery, refer to the Vantage app.

Charge the computer

Use ac power

Power source of the ac power adapter:

- Power: 45 W or 65 W (depending on the model)
- Sine-wave input at 50 Hz to 60 Hz
- Input rating of the ac power adapter: 100 V to 240 V ac, 50 Hz to 60 Hz

When the battery power is low, charge your battery by connecting your computer to ac power. The 65 W ac power adapter supports the rapid charge function, the battery is 80% charged in about one hour when the computer is turned off. The actual charging time depends on the battery size, the physical environment, and whether you are using the computer.

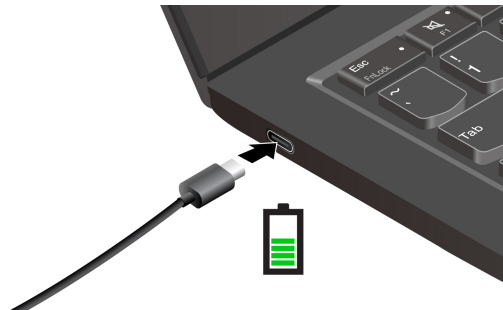

Notes: To maximize the life of the battery:

- Use the battery until the charge is depleted and recharge the battery completely before using it. Once the battery is fully charged, it must discharge to 94% or lower before it will be allowed to recharge again.
- The battery may optimize its full charge capacity based on your usage. After prolonged periods of limited use, full battery capacity may not be available until you discharge to as low as 20% and recharge completely. For more information, refer to the power section of the Vantage app.

Use P-to-P 2.0 (Peer to Peer 2.0) charging function

Both USB-C connectors on the computer feature the Lenovo-unique P-to-P 2.0 charging function. To use the function, ensure that **Always On USB** and **Charge in Battery Mode** are enabled in UEFI BIOS of your computers, so that the function works even when the computers are off or in hibernation mode.

To enable **Always On USB** and **Charge in Battery Mode**:

1. Press F1 to enter the UEFI BIOS menu.
2. Click **Config** → **USB**, and then to enable **Always On USB** and **Charge in Battery Mode**.

- **When no ac power is available:**



Note: The remaining battery power of computer A should be at least 30% and be 3% higher than that of computer B.

- **When ac power is available:**

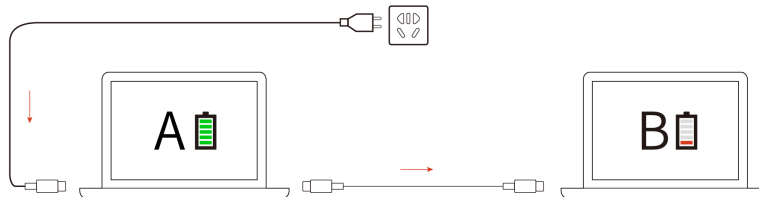

Note: The actual charging speed of your computer depends on many factors, such as the remaining battery power of the computers, the wattage of the ac power adapter, and whether you are using the computers.

Change the power settings

For ENERGY STAR® compliant computers, the following power plan takes effect when your computer has been idle for a specified duration:

- Turn off the display: After 10 minutes
- Put the computer to sleep: After 10 minutes

To reset the power plan:

1. Right-click the battery status icon and select **Power Options**.
2. Choose or customize a power plan of your preference.

To reset the power button function:

1. Right-click the battery status icon and select **Power Options** → **Choose what the power buttons do**.
2. Change the settings as you prefer.

Transfer data

Quickly share your files using the built-in Bluetooth or NFC technology among devices with the same features. You also can insert a microSD card or smart card to transfer data.

Set up a Bluetooth connection

You can connect all types of Bluetooth-enabled devices to your computer, such as a keyboard, a mouse, a smartphone, or speakers. To ensure successful connection, place the devices at most 10 meters (33 feet) from the computer.

1. Type Bluetooth in the Windows search box and then press Enter.
2. Turn on Bluetooth, if it is off.
3. Select a Bluetooth device, and then follow the on-screen instructions.

Set up an NFC connection (for selected models)

If your computer supports NFC, you will see an NFC mark or label  around the trackpad area.

To turn on NFC:

1. Type Airplane mode in the Windows search box and then press Enter.
2. Ensure that the Airplane mode is off and turn on the NFC function.

By using NFC, you can simply tap and connect your computer and another NFC-enabled device over a few centimeters or inches. To pair with an NFC card or smartphone:



Note: Ensure that the NFC card is in NFC Data Exchange Format (NDEF), otherwise the card cannot be detected.

Use a smart card (for selected models)

You can insert a smart card to transfer data.

Supported smart card

Supported smart card specifications: 85.60 mm (3.37 inches) x 53.98 mm (2.13 inches)

Attention: Smart cards with slits are not supported. Do not insert such a smart card into the smart-card slot of your computer. Otherwise, the reader might get damaged.

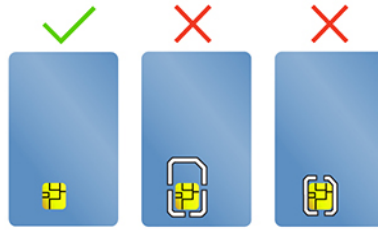

Install or remove a card

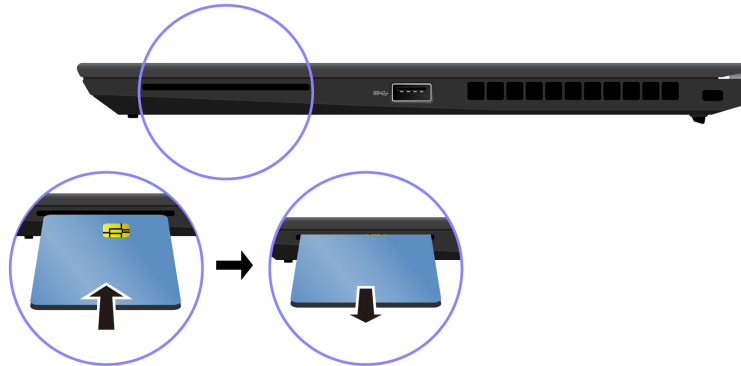

Attention: Before removing the card:

1. Click the triangular icon in the Windows notification area to show hidden icons. Right-click the icon prompting you to safely remove hardware and eject media.
2. Select the corresponding item to eject the card from the Windows operating system.
3. Press the card and remove it from your computer. Store the card safely for future use.

Accessories

This section provides instructions on how to use hardware accessories to expand your computer functionalities.

Purchase accessories

Lenovo has a number of hardware accessories and upgrades to help expand the functionalities of your computer. Options include memory modules, storage devices, network cards, port replicators or docking stations, batteries, power adapters, keyboards, mice, and more.

To shop at Lenovo, go to <https://www.lenovo.com/accessories>.

Docking station

You can use the following docking stations to extend the capacity of your computer:

- ThinkPad Basic Docking Station
- ThinkPad Pro Docking Station
- ThinkPad Ultra Docking Station

Attention: If your computer doesn't have this icon , we don't recommend you to connect the ThinkPad Basic/Pro/Ultra Docking Station to your computer.

Side connectors of docking stations

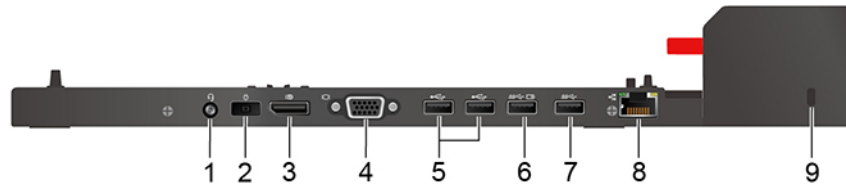

Figure 1. ThinkPad Basic Docking Station

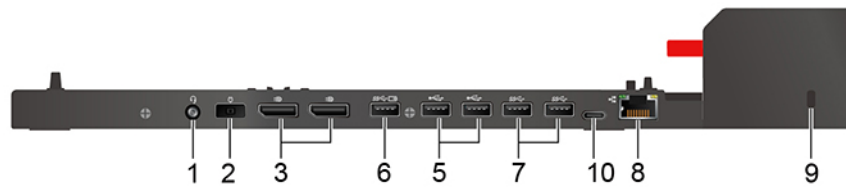

Figure 2. ThinkPad Pro Docking Station

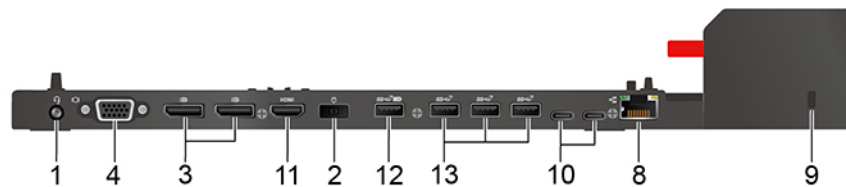

Figure 3. ThinkPad Ultra Docking Station

1. Audio connector	2. ac power connector
3. DisplayPort® connector	4. VGA connector
5. USB 2.0 connector	6. Always On USB 3.2 connector Gen 1
7. USB 3.2 connector Gen 1	8. Ethernet connector
9. Security-lock slot	10. USB-C connector
11. HDMI connector	12. Always On USB 3.2 connector Gen 2
13. USB 3.2 connector Gen 2	

Attach a docking station

Notes:

- ThinkPad Basic Docking Station does not ship with a system lock installed. If you do not purchase and install a system lock, skip step 4 and step 7 in the following instruction.
- If you do not connect the docking station to ac power, the computer attached runs on battery power.

1. Connect the docking station to ac power.
2. Disconnect the cables and devices from the left side of the computer.
3. Turn the system lock key to the unlocked position (🔓).

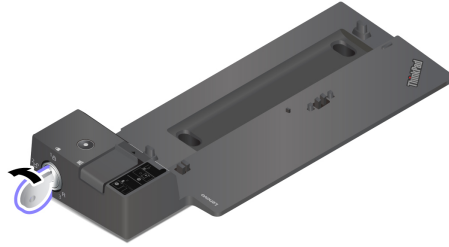

4. Align the top-left corner of the computer with the guide post of the docking station. Attach your computer to the docking station as shown **1** until you hear a click. Slide the latch in the direction as shown **2**.

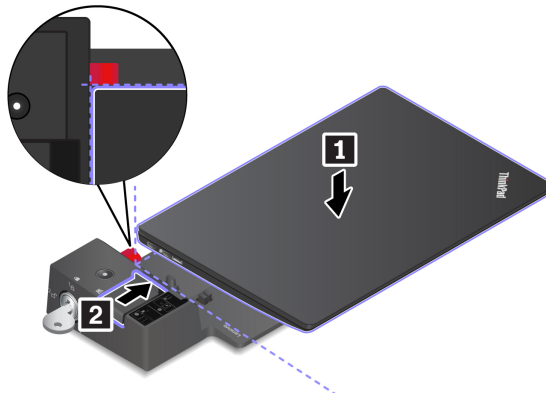

5. Check the docking status indicator. The docking status indicator turns on when the computer is successfully docked.

Note: If the indicator is off, your computer is not attached to the docking station successfully. To solve the problem, detach and reattach the computer.

6. Turn the system lock key to the locked position (**1**).

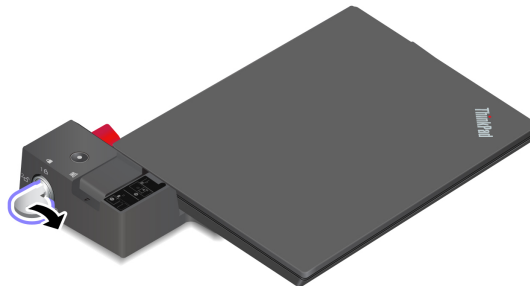

Attention: When the computer is attached to a docking station, always hold the whole assembly when you need to move your computer. Otherwise, the docking station might drop down.

Detach a docking station

Note: ThinkPad Basic Docking Station does not ship with a system lock installed. If you do not purchase and install a system lock, skip step 1 in the following instruction.

1. Turn the system lock key to the unlocked position (**2**).

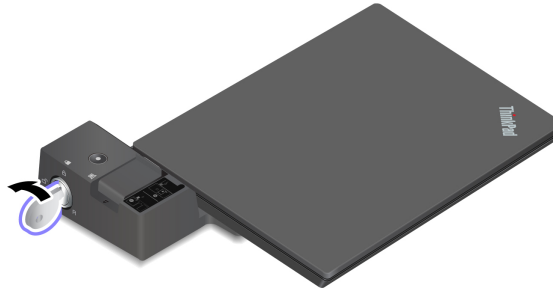

2. Slide the latch in the direction as shown **1** to release the computer, and then grasp both sides of the computer to remove it **2**.

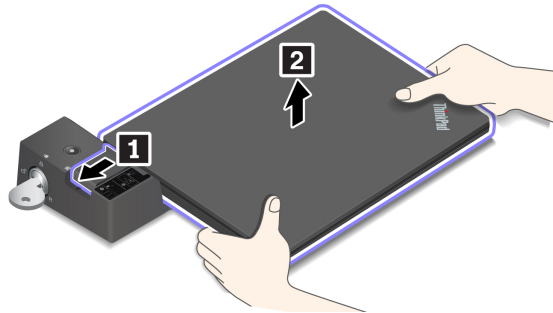

Connect multiple external displays

You can connect multiple external displays to a supported docking station. To ensure that the multiple displays work correctly, refer to the following table and connect the external displays to the appropriate connectors.

Docking station	Connectors supporting external displays
ThinkPad Basic Docking Station	DisplayPort VGA
ThinkPad Pro Docking Station	DisplayPort (x2)
ThinkPad Ultra Docking Station	DisplayPort (x2) HDMI VGA

Chapter 4. Secure your computer and information

Lock the computer

Lock your computer to a desk, table, or other fixtures through a compatible security cable lock.

Note: The slot supports cable locks that conform to the Kensington NanoSaver® lock standards using Cleat™ locking technology. You are responsible for evaluating, selecting, and implementing the locking device and security feature. Lenovo is not responsible for the locking device and security feature. You can purchase the cable locks at <https://smartfind.lenovo.com>.

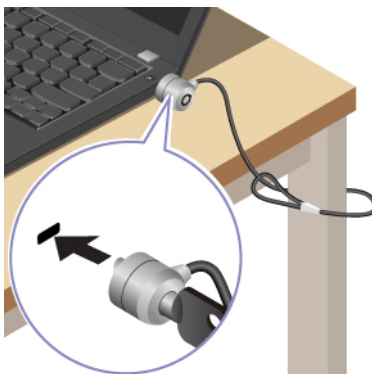

Log in with your fingerprint (for selected models)

The fingerprint reader is integrated with the power button. After enrolling your fingerprint, you can power on and log in to the computer with a simple press on the power button, or unlock the screen with a single touch. It eliminates the need to enter complex passwords, saving your time and boosting your productivity.

1. Type Sign-in options in the Windows search box and then press Enter.
2. Select the fingerprint setting and then follow the on-screen instruction to enroll your fingerprint.

Note: It is recommended that you put your finger at the middle of the fingerprint reader during enrollment and enroll more than one fingerprint in case of any injuries to your fingers. After the enrollment, the fingerprints are associated with the Windows password automatically.

3. Log in with your fingerprint. When the fingerprint reader indicator is solid green, tap your finger on the fingerprint reader for authentication.

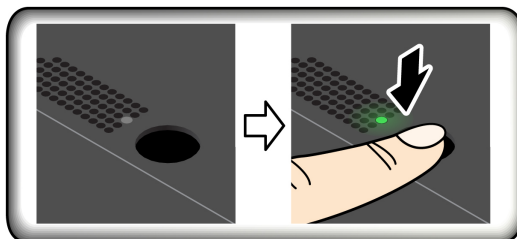

Associate your fingerprints with UEFI BIOS passwords

You can associate your fingerprints with your power-on password and NVMe password. See “Associate your fingerprints with passwords (for selected models)” on page 36.

Maintenance tips:

- Do not scratch the surface of the reader with anything hard.
- Do not use or touch the reader with a wet, dirty, wrinkled, or injured finger.

Log in with your face ID (for selected models)

For models come with a webcam privacy shutter, slide the webcam privacy shutter to uncover the camera lens before using the Windows Hello face recognition.

Create your face ID and unlock your computer by scanning your face:

1. Type Sign-in options in the Windows search box and then press Enter.
2. Select the face ID setting and then follow the on-screen instruction to create your face ID.

Detect human presence (for selected Intel models with IR camera)

Your computer supports the human presence detection function.

- Wake up the computer when you are approaching it. With a face ID created, your computer can recognize your face and log in to the system automatically. You need to face the camera and be at most 1.4 meters (4.6 feet) from the computer. The function does not work when your computer is in hibernation mode or has been turned off.
- Dim the display and lock the computer when you are leaving. The function does not work if you set the power options to never turn off the display.

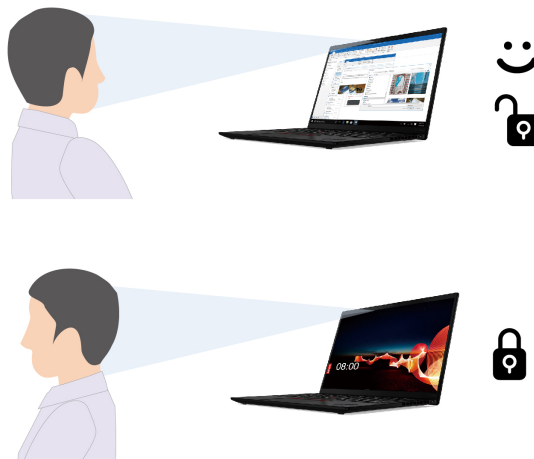

The human presence sensor is enabled by default. To change the settings:



- Open the Vantage app, and then click **Device** → **Smart Assist** to turn on or turn off the **User Presence Sensing** switch. Customize the **Zero Touch Login** and **Zero Touch Lock** settings according to your preference.
- Restart the computer. When the logo screen is displayed, press F1 to enter the UEFI BIOS menu. Select **Security** → **Intelligent Security** to customize detailed settings.

Notes:

- If the Airplane mode is enabled, human presence detection is disabled.
- Your computer uses a human presence sensor to detect your presence and the IR camera to recognize your face. Lenovo does not collect any personal data.
- For some countries or regions, the human presence sensor is disabled according to local regulations.

Protect your privacy (for selected models)

Use the ePrivacy screen



Your computer might come with an ePrivacy screen. It can reduce screen visibility from side angles to protect screen content against visual hacking. By default, this function is disabled. You can press F12 or Fn +D to enable it. You will be prompted by the on-screen icon  or  every time the function is enabled or disabled.

Your ePrivacy screen can be automatically enabled in case that you are required to input passwords. By default, this automatic function for passwords is disabled. You can enable it on the Vantage app.

The ePrivacy screen also can work with the preinstalled Glance app to better protect your privacy. For details, go to <https://support.lenovo.com/us/en/videos/vid500144>.

Set the privacy level

The privacy level of this function varies depending on the screen brightness level, the contrast ratio, and the physical environment where you are using this function.

- Press  to increase the privacy level.
- Press  to decrease the privacy level.

Protect data against power loss (for selected models)

NVMe (Non-Volatile Memory express) M.2 solid-state drive features the Lenovo-unique PLP (Power Loss Protection) function to avoid data loss or damage. If your computer is not responding and you might have to shut down your computer by pressing and holding the power button for several seconds. In this case, the PLP function enables your computer data to be saved timely. However, there is no guarantee that all data is saved in any situation. To check the type of your M.2 solid-state drive:

1. Restart the computer. When the logo screen is displayed, press F10 to enter the Lenovo diagnostics window.
2. On the TOOLS tab, select **SYSTEM INFORMATION** → **STORAGE** using the arrow keys.
3. Locate the **Device Type** section to check the information

UEFI BIOS passwords

You can set passwords in UEFI (Unified Extensible Firmware Interface) BIOS (Basic Input/Output System) to strengthen the security of your computer.

Password types

You can set a power-on password, supervisor password, system management password, or NVMe password in UEFI BIOS to prevent unauthorized access to your computer. However, you are not prompted to enter any UEFI BIOS password when your computer resumes from sleep mode.

Power-on password

If you set a power-on password, a window is displayed on the screen when you turn on the computer. Enter the correct password to use the computer.

Supervisor password

The supervisor password protects the system information stored in UEFI BIOS. When entering the UEFI BIOS menu, enter the correct supervisor password in the window prompted. You also can press Enter to skip the password prompt. However, you cannot change most of the system configuration options in UEFI BIOS.

If you have set both the supervisor password and power-on password, you can use the supervisor password to access your computer when you turn it on. The supervisor password overrides the power-on password.

System management password

The system management password can also protect the system information stored in UEFI BIOS like a supervisor password, but it has lower authority by default. The system management password can be set through the UEFI BIOS menu or through Windows Management Instrumentation (WMI) with the Lenovo client-management interface.

You can enable the system management password to have the same authority as the supervisor password to control security-related features. To customize the authority of the system management password through the UEFI BIOS menu:

1. Restart the computer. When the logo screen is displayed, press F1 to enter the UEFI BIOS menu.
2. Select **Security → Password → System Management Password Access Control**.
3. Follow the on-screen instructions.

If you have set both the supervisor password and the system management password, the supervisor password overrides the system management password. If you have set both the system management password and the power-on password, the system management password overrides the power-on password.

NVMe passwords

The NVMe password prevents unauthorized access to the data on the storage drive. When an NVMe password is set, you are prompted to type a correct password each time you try to access the storage drive.

• Single Password

When a Single NVMe password is set, the user must enter the user NVMe password to access files and applications on the storage drive.

• Dual Password (User + Admin)

The admin NVMe password is set and used by a system administrator. It enables the administrator to access any storage drive in a system or any computer connected in the same network. The administrator can also assign a user NVMe password for each computer in the network. The user of the computer can change the user NVMe password as desired, but only the administrator can remove the user NVMe password.

When prompted to enter an NVMe password, press F1 to switch between the admin NVMe password and user NVMe password.

Notes: The NVMe password is not available in the following situations:

- A Trusted Computing Group (TCG) Opal-compliant storage drive and a TCG Opal management software program are installed in the computer, and the TCG Opal management software program is activated.

- For Intel models, when an eDrive storage drive is installed in the computer preinstalled with the Windows operating system.

Set, change, and remove a password

Before you start, print these instructions.

1. Restart the computer. When the logo screen is displayed, press F1 to enter the UEFI BIOS menu.
2. Select **Security** → **Password** by using the arrow keys.
3. Select the password type. Then, follow the on-screen instructions to set, change, or remove a password.

You should record all your passwords and store them in a safe place. If you forget any of your passwords, any potential repair actions required are not covered under warranty.

What to do if you forget your power-on password

If you forget your power-on password, do the following to remove the power-on password:

- If you have set a supervisor password and remember it:
 1. Restart the computer. When the logo screen is displayed, immediately press F1.
 2. Type the supervisor password to enter the UEFI BIOS menu.
 3. Select **Security** → **Password** → **Power-On Password** by using the arrow keys.
 4. Type the current supervisor password in the **Enter Current Password** field. Then, leave the **Enter New Password** field blank, and press Enter twice.
 5. In the Changes have been saved window, press Enter.
 6. Press F10 to save changes and exit the UEFI BIOS menu.
- If you have not set a supervisor password, contact a Lenovo authorized service provider to have the power-on password removed.

What to do if you forget your NVMe password

If you forget your NVMe password (Single password) or both user and admin NVMe passwords (Dual password), Lenovo cannot reset your passwords or recover data from the storage drive. You can contact a Lenovo authorized service provider to have the storage drive replaced. A fee will be charged for parts and service. If the storage drive is a CRU (Customer Replaceable Unit), you can also contact Lenovo to purchase a new storage drive to replace the old one by yourself. To check whether the storage drive is a CRU and the relevant replacement procedure, see Chapter 6 “CRU replacement” on page 41.

What to do if you forget your supervisor password

If you forget your supervisor password, there is no service procedure to remove the password. You have to contact a Lenovo authorized service provider to have the system board replaced. A fee will be charged for parts and service.

What to do if you forget your system management password

If you forget your system management password, do the following to remove the system management password:

- If you have set a supervisor password and remember it:
 1. Restart the computer. When the logo screen is displayed, immediately press F1.
 2. Type the supervisor password to enter the UEFI BIOS menu.
 3. Select **Security** → **Password** → **System Management Password** by using the arrow keys.

4. Type the current supervisor password in the **Enter Current Password** field. Then, leave the **Enter New Password** field blank, and press Enter twice.
 5. In the Changes have been saved window, press Enter.
 6. Press F10 to save changes and exit the UEFI BIOS menu.
- If you have not set a supervisor password, contact a Lenovo authorized service provider to have the system management password removed.

Associate your fingerprints with passwords (for selected models)

Do the following to associate your fingerprints with the power-on password and NVMe password:

1. Turn off and then turn on the computer.
2. When prompted, scan your finger on the fingerprint reader.
3. Enter your power-on password, NVMe password, or both as required. The association is established.

When you start the computer again, you can use your fingerprints to log in to the computer without entering your Windows password, power-on password, or NVMe password. To change settings, press F1 to enter the UEFI BIOS menu, and then select **Security → Fingerprint**.

Attention: If you always use your fingerprint to log in to the computer, you might forget your passwords. Write down your passwords, and keep them in a safe place.

Chapter 5. Configure advanced settings

UEFI BIOS

UEFI BIOS is the first program that the computer runs. When the computer turns on, UEFI BIOS performs a self test to make sure that various devices in the computer are functioning.

Enter the UEFI BIOS menu

Restart the computer. When the logo screen is displayed, press F1 to enter the UEFI BIOS menu.

Navigate in the UEFI BIOS interface

You can navigate in the UEFI BIOS interface by pressing the following keys:

- F1: General Help
- F9: Setup Defaults
- F10: Save and Exit
- F5 / F6: Change boot priority order
- ↑ ↓ or PgUp / PgDn: Select / Scroll page
- ← →: Move keyboard focus
- Esc: Back / Close dialog
- Enter: Select / Open submenu

Set the system date and time

1. Restart the computer. When the logo screen is displayed, press F1.
2. Select **Date/Time** and set the system date and time as desired.
3. Press F10 to save changes and exit.

Change the startup sequence

1. Restart the computer. When the logo screen is displayed, press F1.
2. Select **Startup → Boot**. Then, press Enter. The default device order list is displayed.

Note: No bootable device is displayed if the computer cannot start from any devices or the operating system cannot be found.

3. Set the startup sequence as desired.
4. Press F10 to save the changes and exit.

To change the startup sequence temporarily:

1. Restart the computer. When the logo screen is displayed, press F12.
2. Select the device that you want the computer to start from and press Enter.

Update UEFI BIOS

When you install a new program, device driver, or hardware component, you might need to update UEFI BIOS.

Download and install the latest UEFI BIOS update package by one of the following methods:

- Open the Vantage app to check the available update packages. If the latest UEFI BIOS update package is available, follow the on-screen instructions to download and install the package.
- Go to <https://pcsupport.lenovo.com> and select the entry for your computer. Then, follow the on-screen instructions to download and install the latest UEFI BIOS update package.

To know more about UEFI BIOS, visit Knowledge Base of your computer at <https://pcsupport.lenovo.com>.

Install a Windows operating system and drivers

This section provides instructions on installing a Windows operating system and device drivers.

Install a Windows operating system

Microsoft constantly makes updates to the Windows operating system. Before installing a particular Windows version, check the compatibility list for the Windows version. For details, go to <https://support.lenovo.com/us/en/solutions/windows-support>.

Attention:

- It is recommended that you update your operating system through official channels. Any unofficial update might cause security risks.
- The process of installing a new operating system deletes all the data on your internal storage drive, including the data stored in a hidden folder.

1. If you are using the Windows BitLocker® Drive Encryption feature and your computer has a Trusted Platform Module, ensure that you have disabled the feature.
2. Ensure that the security chip is set to **Active**.
 - a. Restart the computer. When the logo screen is displayed, press F1 to enter the UEFI BIOS menu.
 - b. Select **Security → Security Chip** and press Enter. The **Security Chip** submenu opens.
 - c. Ensure that the security chip for TPM 2.0 is set to **Active**.
 - d. Press F10 to save the settings and exit.
3. Connect the drive that contains the operating system installation program to the computer.
4. Restart the computer. When the logo screen is displayed, press F1 to enter the UEFI BIOS menu.
5. Select **Startup → Boot** to display the **Boot Priority Order** submenu.
6. Select the drive that contains the operating system installation program, for example, **USB HDD**. Then, press Esc.

Attention: After you change the startup sequence, ensure that you select the correct device during a copy, a save, or a format operation. If you select the wrong device, the data on that device might be erased or overwritten.

7. Select **Restart** and ensure that **OS Optimized Defaults** is enabled. Then, press F10 to save the settings and exit.
8. Follow the on-screen instructions to install the device drivers and necessary programs.
9. After installing the device drivers, apply Windows Update to get the latest updates, for example the security patches.

Install device drivers

You should download the latest driver for a component when you notice poor performance from that component or when you added a component. This action might eliminate the driver as the potential cause of a problem. Download and install the latest driver by one of the following methods:

- Open the Vantage app to check the available update packages. Select the update packages you want, and then follow the on-screen instructions to download and install the packages.
- Go to <https://pcsupport.lenovo.com> and select the entry for your computer. Then, follow the on-screen instructions to download and install necessary drivers and software.

Chapter 6. CRU replacement

Customer Replaceable Units (CRUs) are parts that can be upgraded or replaced by the customer. The computers contain the following types of CRUs:

- **Self-service CRUs:** Refer to parts that can be installed or replaced easily by customer themselves or by trained service technicians at an additional cost.
- **Optional-service CRUs:** Refer to parts that can be installed or replaced by customers with a greater skill level. Trained service technicians can also provide service to install or replace the parts under the type of warranty designated for the customer's machine.

If you intend on installing a CRU, Lenovo will ship the CRU to you. CRU information and replacement instructions are shipped with your product and are available from Lenovo at any time upon request. You might be required to return the defective part that is replaced by the CRU. When return is required: (1) return instructions, a prepaid shipping label, and a container will be included with the replacement CRU; and (2) you might be charged for the replacement CRU if Lenovo does not receive the defective CRU within thirty (30) days of your receipt of the replacement CRU. For full details, see the Lenovo Limited Warranty documentation at https://www.lenovo.com/warranty/llw_02.

CRU list

The following is a list of CRUs of your computer.

Self-service CRUs

- ac power adapter
- Base cover assembly
- Nano-SIM-card tray*
- Power cord

Optional-service CRUs

- Keyboard (for ThinkPad X13 Gen 2)
- M.2 solid-state drive
- M.2 solid-state drive bracket*
- Wireless WAN card*

* for selected models

Note: Replacement of any parts not listed above, including the built-in rechargeable battery, must be done by a Lenovo-authorized repair facility or technician. Go to <https://support.lenovo.com/partnerlocation> for more information.

Disable Fast Startup and the built-in battery

Before replacing any CRU, ensure that you disable Fast Startup first and then disable the built-in battery.

To disable Fast Startup:

1. Go to **Control Panel** and view by Large icons or Small icons.
2. Click **Power Options**, and then click **Choose what the power buttons do** on the left pane.

3. Click **Change settings that are currently unavailable** at the top.
4. If prompted by User Account Control (UAC), click **Yes**.
5. Clear the **Turn on fast startup** check box, and then click **Save changes**.

To disable the built-in battery:

1. Restart your computer. When the logo screen is displayed, immediately press F1 to enter the UEFI BIOS menu.
2. Select **Config** → **Power**. The **Power** submenu is displayed.
3. Select **Disable Built-in Battery** and press Enter.
4. Select **Yes** in the Setup Confirmation window. The built-in battery is disabled and the computer turns off automatically. Wait three to five minutes to let the computer cool.

Replace a CRU

Follow the replacement procedure to replace a CRU.

Base cover assembly

Prerequisite

Before you start, read [Generic Safety and Compliance Notices](#) and print the following instructions.

Note: Do not remove the base cover assembly when your computer is connected to ac power. Otherwise, there might be a risk of short circuits.

For access, do the following:

1. Disable the built-in battery. See “Disable Fast Startup and the built-in battery” on page 41.
2. Turn off the computer and disconnect the computer from ac power and all connected cables.
3. Close the computer display and turn over the computer.

Removal procedure for ThinkPad T14s Gen 2

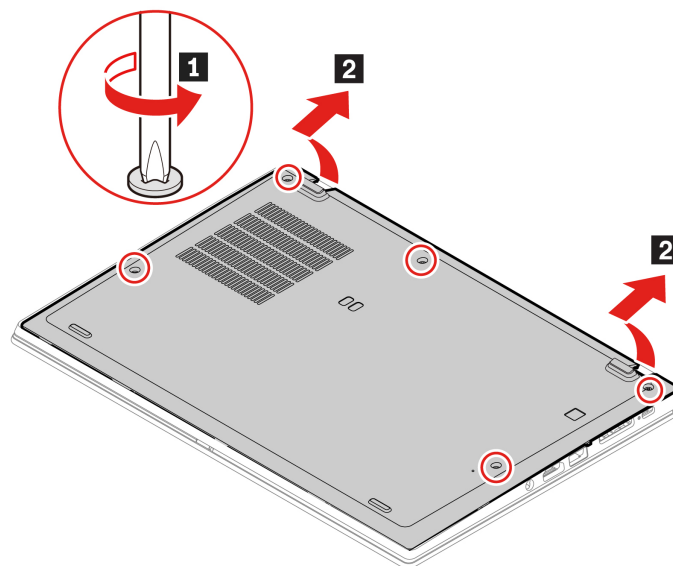

Installation procedure for ThinkPad T14s Gen 2

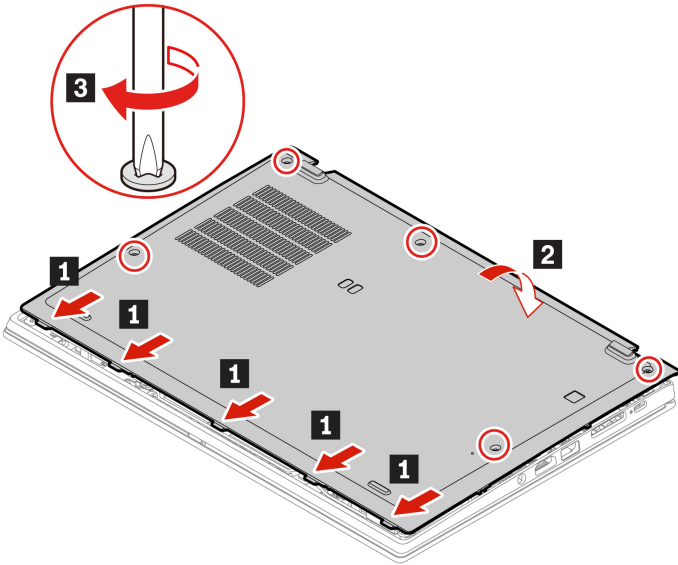

Removal procedure for ThinkPad X13 Gen 2

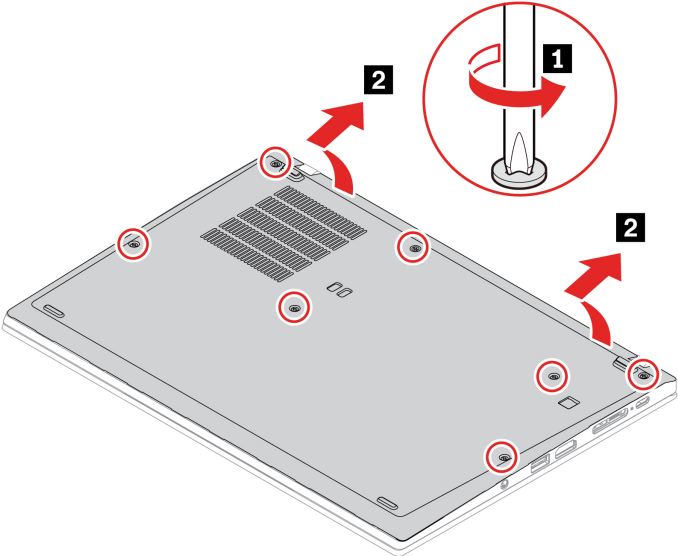

Installation procedure for ThinkPad X13 Gen 2

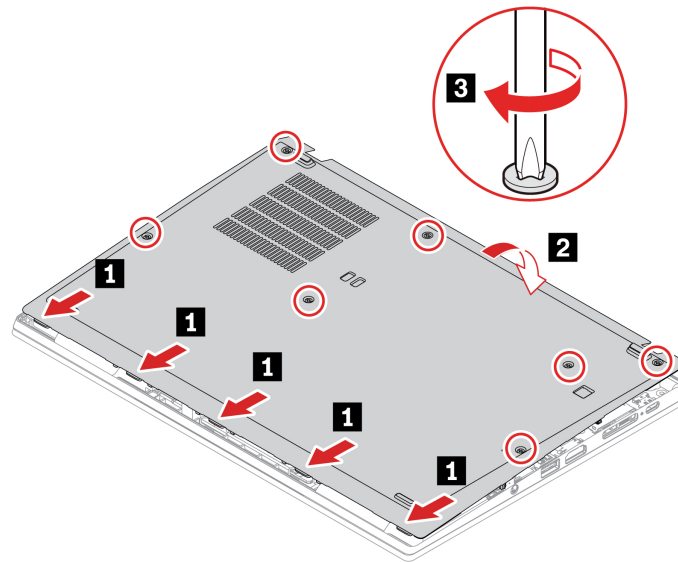

Troubleshooting

If the computer does not start up after you reinstall the base cover assembly, disconnect the ac power adapter and then reconnect it to the computer.

M.2 solid-state drive

Prerequisite

Before you start, read [Generic Safety and Compliance Notices](#) and print the following instructions.

Attention: If you replace a M.2 solid-state drive, you might need to install a new operating system. For details on how to install a new operating system, see “Install a Windows operating system and drivers” on page 38.

The M.2 solid-state drive is sensitive. Inappropriate handling might cause damage and permanent loss of data.

When handling the M.2 solid-state drive, observe the following guidelines:

- Replace the M.2 solid-state drive only for upgrade or repair. The M.2 solid-state drive is not designed for frequent changes or replacement.
- Before replacing the M.2 solid-state drive, make a backup copy of all the data that you want to keep.
- Do not apply pressure to the M.2 solid-state drive.
- Do not touch the contact edge or circuit board of the M.2 solid-state drive. Otherwise, the M.2 solid-state drive might get damaged.
- Do not make the M.2 solid-state drive subject to physical shocks or vibration. Put the M.2 solid-state drive on a soft material, such as cloth, to absorb physical shocks.

For access, do the following:

1. Disable the built-in battery. See “Disable Fast Startup and the built-in battery” on page 41.
2. Turn off the computer and disconnect the computer from ac power and all connected cables.

3. Close the computer display and turn the computer over.
4. Remove the bottom cover. See “Base cover assembly” on page 42.

Removal procedure for the long M.2 solid-state drive and its bracket (if any)

- Type 1

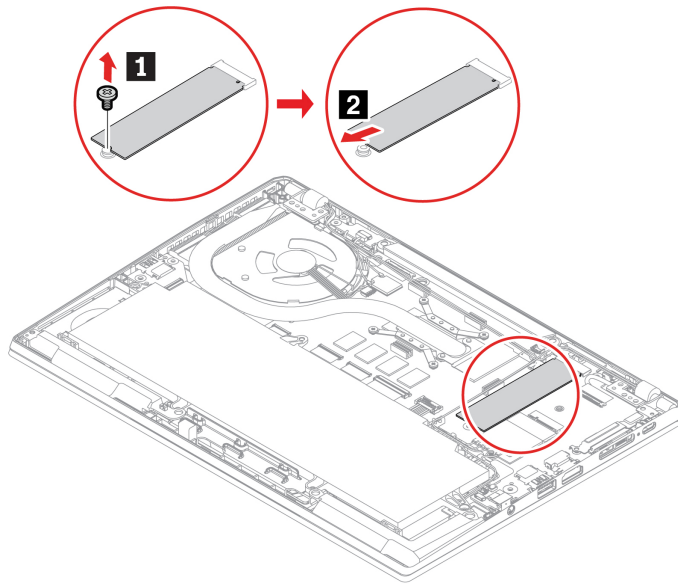

- Type 2

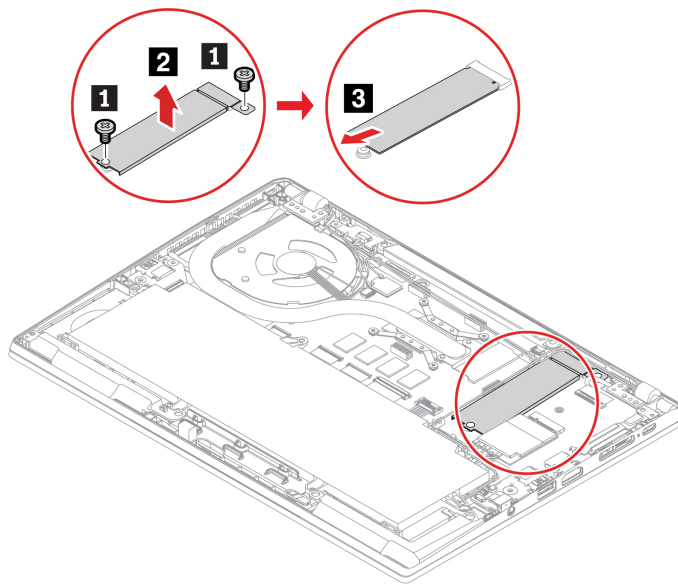

Removal procedure for the short M.2 solid-state drive and its bracket (for ThinkPad X13 Gen 2)

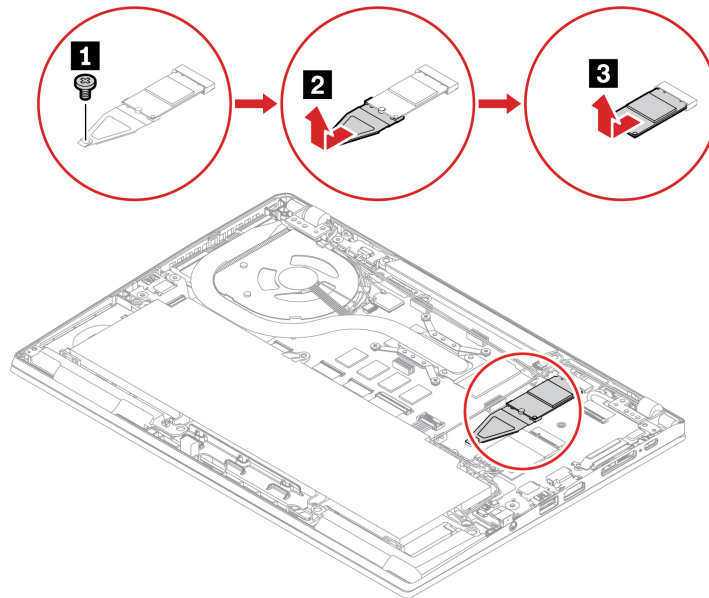

Wireless WAN card (for selected models)

The following information is only for the computer with user-installable modules. Ensure that you use only a Lenovo-authorized wireless module specifically tested for this computer model. Otherwise, the computer will generate an error-code beep sequence when you turn on the computer.

Prerequisite

Before you start, read [Generic Safety and Compliance Notices](#) and print the following instructions.

Attention:

- This slot might be installed with a wireless WAN card or wireless LAN card. If it is a wireless LAN card, you are prohibited from replacing it or removing it. If the device requires replacement due to some problem during warranty, it must be serviced by a Lenovo authorized service personnel. If it is a wireless WAN card, follow the following instructions to remove or replace it.

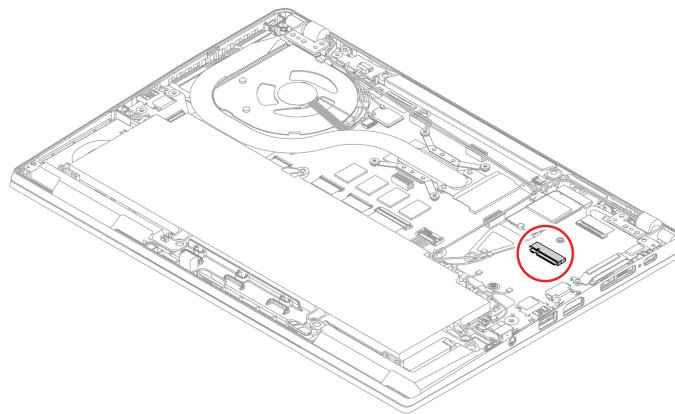

- Do not touch the contact edge of the wireless WAN card. Otherwise, the wireless WAN card might get damaged.

For access, do the following:

1. Disable the built-in battery. See “Disable Fast Startup and the built-in battery” on page 41.
2. Turn off the computer and disconnect the computer from ac power and all connected cables.
3. Close the computer display and turn the computer over.
4. Remove the base cover assembly. See “Base cover assembly” on page 42.

Removal procedure

Note: A Mylar film might cover the wireless WAN card. To access the wireless WAN card, peel off the film first.

Depending on your computer model, do one of the following to remove the wireless WAN card:

- Type 1

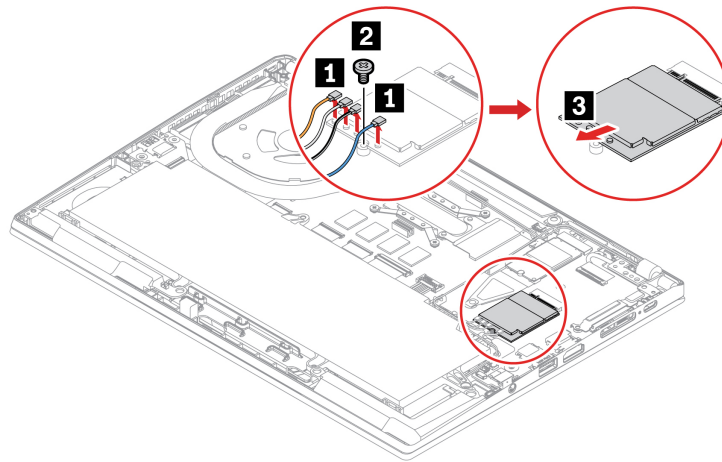

- Type 2

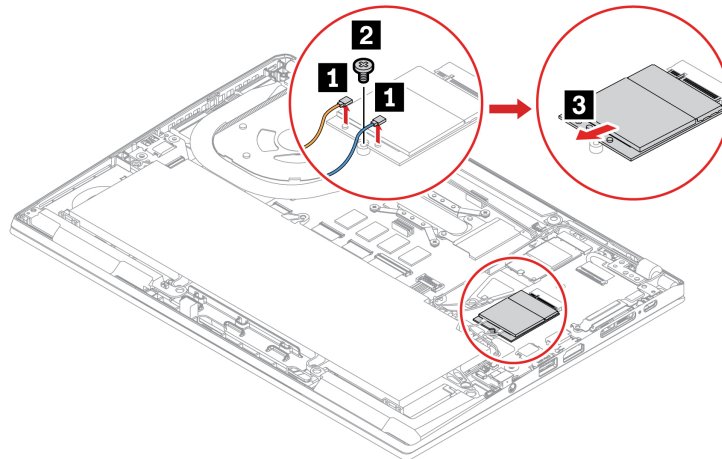

- Type 3

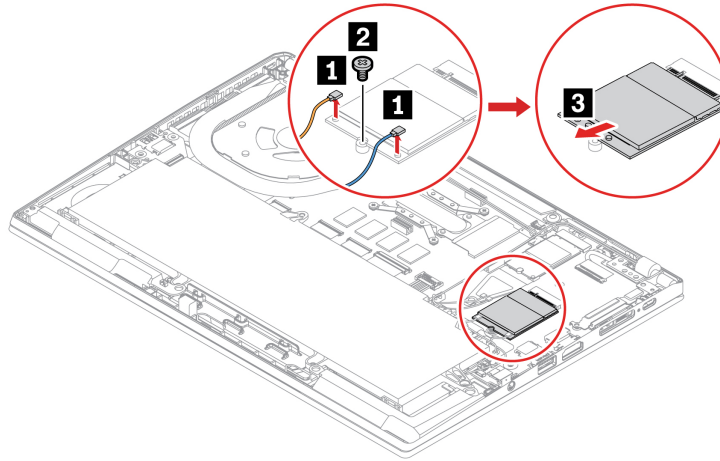

Note: During installation, ensure that you connect the cables with different colors to the corresponding connectors on the card according to the illustrations above: the orange cable to the connector labeled ORANGE, the blue cable to the connector labeled BLUE, the white and grey cable to the connector labeled WHITE GREY, and the black and grey cable to the connector labeled BLACK GREY.

Keyboard (for ThinkPad X13 Gen 2)

Prerequisite

Before you start, read [Generic Safety and Compliance Notices](#) and print the following instructions.

For access, do the following:

1. Disable the built-in battery. See “Disable Fast Startup and the built-in battery” on page 41.
2. Turn off the computer and disconnect the computer from ac power and all connected cables.
3. Close the computer display and turn the computer over.

Removal procedure

Note: You might be instructed to slide the keyboard frame forward or backward in some of the following steps. In this case, ensure that you do not press or hold the keys while sliding the keyboard frame. Otherwise, the keyboard frame cannot be moved.

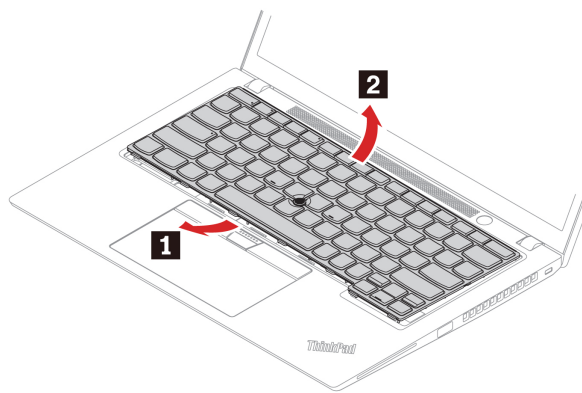
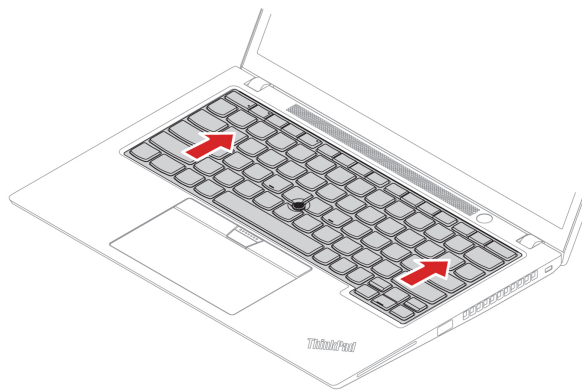
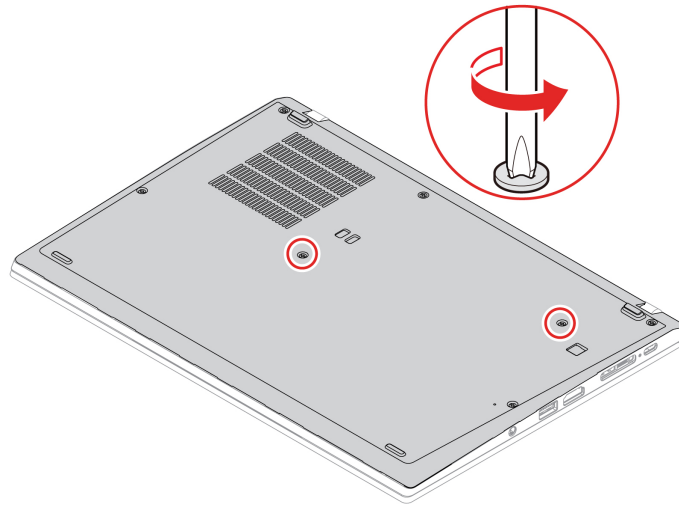

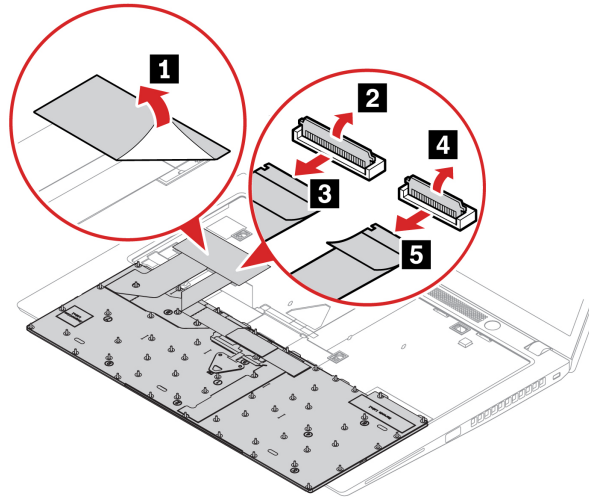

Installation procedure

Note: You might be instructed to slide the keyboard frame forward or backward in some of the following steps. In this case, ensure that you do not press or hold the keys while sliding the keyboard frame. Otherwise, the keyboard frame cannot be moved.

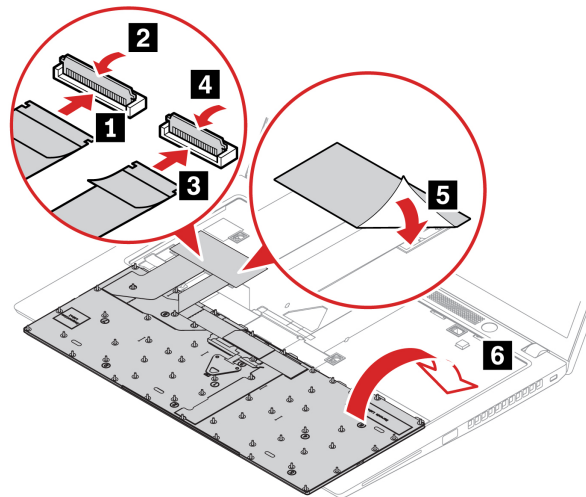

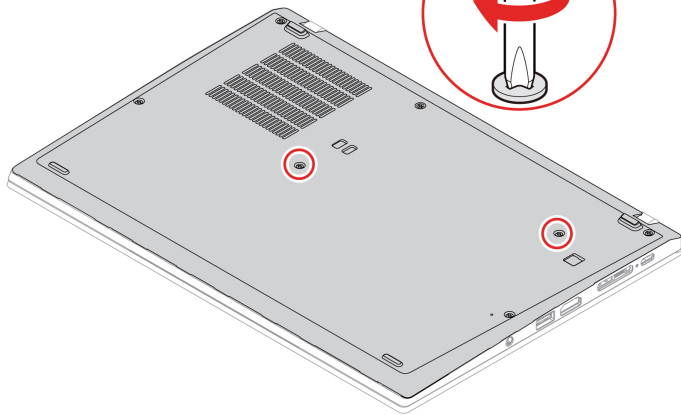
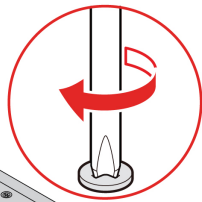
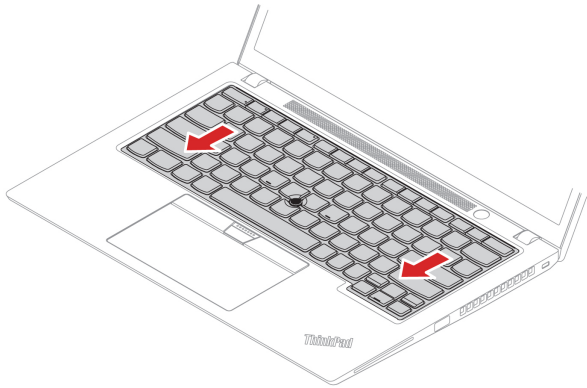
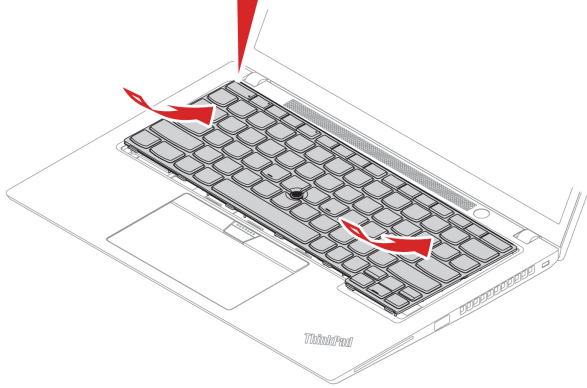
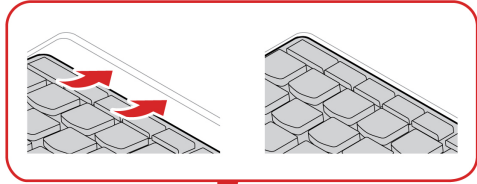

Chapter 7. Help and support

Frequently asked questions

How do I access Control Panel ?	Type Control Panel in the Windows search box and then press Enter.
How do I turn off my computer?	Open the Start menu and click  Power . Then, click Shut down .
How do I partition my storage drive?	https://support.lenovo.com/solutions/ht503851
What do I do if my computer stops responding?	<ol style="list-style-type: none">1. Press and hold the power button until the computer turns off. Then, restart the computer.2. If step 1 does not work:<ul style="list-style-type: none">• For models with an emergency reset hole: Insert a straightened paper clip into the emergency reset hole to cut off power supply temporarily. Then, restart the computer with ac power connected.• For models without an emergency reset hole:<ul style="list-style-type: none">– For models with the removable battery, remove the removable battery and disconnect all power sources. Then, reconnect to ac power and restart the computer.– For models with the built-in battery, disconnect all power sources. Press and hold the power button for about seven seconds. Then, reconnect to ac power and restart the computer.
What do I do if I spill liquid on the computer?	<ol style="list-style-type: none">1. Carefully unplug the ac power adapter and turn off the computer immediately. The more quickly you stop the current from passing through the computer the more likely you will reduce damage from short circuits. Attention: Although you might lose some data or work by turning off the computer immediately, leaving the computer on might make your computer unusable.2. Do not try to drain out the liquid by turning over the computer. If your computer has keyboard drainage holes on the bottom, the liquid will be drained out through the holes.3. Wait until you are certain that all the liquid is dry before turning on your computer.
How do I enter the UEFI BIOS menu?	Restart the computer. When the logo screen is displayed, press F1 to enter the UEFI BIOS menu.
Where can I get the latest device drivers and UEFI BIOS?	<ul style="list-style-type: none">• From the Vantage app. See “Install a Windows operating system and drivers” on page 38 and “Update UEFI BIOS” on page 37.• Download from Lenovo Support Web site at https://pcsupport.lenovo.com.

Error messages

If you see a message that is not included in the following table, record the error message first, then shut down the computer and call Lenovo for help. See “Lenovo Customer Support Center” on page 58.

Message	Solution
0190: Critical low-battery error	The computer turned off because the battery power is low. Connect the ac power adapter to the computer and charge the batteries.
0191: System Security - Invalid remote change requested	The system configuration change has failed. Confirm the operation and try again.
0199: System Security - Security password retry count exceeded.	This message is displayed when you enter a wrong supervisor password more than three times. Confirm the supervisor password and try again.
0271: Check Date and Time settings.	The date or the time is not set in the computer. Enter the UEFI BIOS menu and set the date and time.
210x/211x: Detection/Read error on HDDx/SSDx	The storage drive is not working. Reinstall the storage drive. If the problem still exists, replace the storage drive.
Error: The non-volatile system UEFI variable storage is nearly full.	<p>Note: This error indicates that the operating system or programs cannot create, modify, or delete data in the non-volatile system UEFI variable storage due to insufficient storage space after POST.</p> <p>The non-volatile system UEFI variable storage is used by the UEFI BIOS and by the operating system or programs. This error occurs when the operating system or programs store large amounts of data in the variable storage. All data needed for POST, such as UEFI BIOS setup settings, chipset, or platform configuration data, are stored in a separate UEFI variable storage. Press F1 after the error message is displayed to enter the UEFI BIOS menu. A dialog asks for confirmation to clean up the storage. If you select “Yes”, all data that were created by the operating system or programs will be deleted except global variables defined by the Unified Extensible Firmware Interface Specification. If you select “No”, all data will be kept, but the operating system or programs will not be able to create, modify, or delete data in the storage.</p> <p>If this error happens at a service center, Lenovo authorized service personnel will clean up the non-volatile system UEFI variable storage using the preceding solution.</p>
Fan error. Press ESC to startup with limited performance.	The thermal fan might not work correctly. After the error message is displayed, press ESC within five seconds to start up the computer with limited performance. Otherwise, the computer will shut down immediately. If the problem still exists when you starts up next time, have your computer serviced.

Beep errors

Lenovo SmartBeep technology enables you to decode beep errors with your smartphone when a black screen occurs with beeps from your computer. To decode the beep error with Lenovo SmartBeep technology:

1. Go to <https://support.lenovo.com/smartbeep> or scan the following QR Code.



2. Download the proper diagnostic app and install it on your smartphone.
3. Run the diagnostic app and place the smartphone near the computer.
4. Press Fn on your computer to emit the beep again. The diagnostic app decodes the beep error and shows possible solutions on the smartphone.

Note: Do not attempt to service a product yourself unless instructed to do so by the Customer Support Center or product documentation. Only use a Lenovo-authorized service provider to repair your product.

Self-help resources

Use the following self-help resources to learn more about the computer and troubleshoot problems.

Resources	How to access?
Troubleshooting and FAQ	<ul style="list-style-type: none">• https://www.lenovo.com/tips• https://forums.lenovo.com
Accessibility information	https://www.lenovo.com/accessibility
Reset or restore Windows	<ul style="list-style-type: none">• Use Lenovo recovery options.<ol style="list-style-type: none">1. Go to https://support.lenovo.com/HowToCreateLenovoRecovery.2. Follow the on-screen instructions.• Use Windows recovery options.<ol style="list-style-type: none">1. Go to https://pcsupport.lenovo.com.2. Detect your computer or manually select your computer model.3. Click Diagnostics → Operating System Diagnostics and then follow the on-screen instructions.
Use the Vantage app to: <ul style="list-style-type: none">• Configure device settings.• Download and install UEFI BIOS, drivers, and firmware updates.• Secure your computer from outside threats.• Diagnose hardware problems.• Check the computer warranty status.• Access <i>User Guide</i> and helpful articles.	Type Vantage in the Windows search box and then press Enter.
Note: The available features vary depending on the computer model.	
Product documentation: <ul style="list-style-type: none">• <i>Safety and Warranty Guide</i>• <i>Generic Safety and Compliance Notices</i>• <i>Setup Guide</i>• This <i>User Guide</i>• <i>Regulatory Notice</i>	Go to https://pcsupport.lenovo.com . Then, follow the on-screen instructions to filter out the documentation you want.

Resources	How to access?
<p>Lenovo Support Web site with the latest support information of the following:</p> <ul style="list-style-type: none"> • Drivers and software • Diagnostic solutions • Product and service warranty • Product and parts details • Knowledge base and frequently asked questions 	<p>https://pcsupport.lenovo.com</p>
<p>Windows help information</p>	<ul style="list-style-type: none"> • Open the Start menu and click Get Help or Tips. • Use Windows Search or the Cortana® personal assistant. • Microsoft support Web site: https://support.microsoft.com

Windows label

Your computer might have a Windows Genuine Microsoft label affixed to its cover depending on the following factors:

- Your geographic location
- Edition of Windows that is preinstalled

Go to <https://www.microsoft.com/en-us/howtotell/Hardware.aspx> for illustrations of the various types of Genuine Microsoft labels.

- In the People's Republic of China, the Genuine Microsoft label is required on all computer models preinstalled with any edition of the Windows operating system.
- In other countries and regions, the Genuine Microsoft label is required only on computer models licensed for Windows Pro editions.

The absence of a Genuine Microsoft label does not indicate that the preinstalled Windows version is not genuine. For details on how to tell whether your preinstalled Windows product is genuine, refer to the information provided by Microsoft at <https://www.microsoft.com/en-us/howtotell/default.aspx>.

There are no external, visual indicators of the Product ID or Windows version for which the computer is licensed. Instead, the Product ID is recorded in the computer firmware. Whenever a Windows product is installed, the installation program checks the computer firmware for a valid, matching Product ID to complete the activation.

In some cases, an earlier Windows version might be preinstalled under the terms of the Windows Pro edition license downgrade rights.

Call Lenovo

If you have tried to correct the problem yourself and still need help, you can call Lenovo Customer Support Center.

Before you contact Lenovo

Prepare the following before you contact Lenovo:

1. Record the problem symptoms and details:

- What is the problem? Is it continuous or intermittent?
- Any error message or error code?
- What operating system are you using? Which version?
- Which software applications were running at the time of the problem?
- Can the problem be reproduced? If so, how?

2. Record the system information:

- Product name
- Machine type and serial number

The following illustration shows where to find the machine type and serial number of your computer.

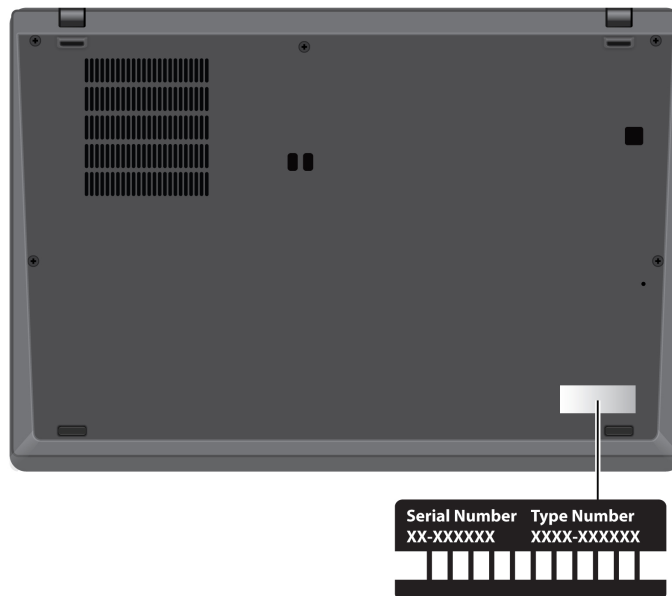

Lenovo Customer Support Center

During the warranty period, you can call Lenovo Customer Support Center for help.

Telephone numbers

For a list of the Lenovo Support phone numbers for your country or region, go to <https://pcsupport.lenovo.com/supportphonenumberlist> for the latest phone numbers.

Note: Phone numbers are subject to change without notice. If the number for your country or region is not provided, contact your Lenovo reseller or Lenovo marketing representative.

Services available during the warranty period

- Problem determination - Trained personnel are available to assist you with determining if you have a hardware problem and deciding what action is necessary to fix the problem.
- Lenovo hardware repair - If the problem is determined to be caused by Lenovo hardware under warranty, trained service personnel are available to provide the applicable level of service.
- Engineering change management - Occasionally, there might be changes that are required after a product has been sold. Lenovo or your reseller, if authorized by Lenovo, will make selected Engineering Changes (ECs) that apply to your hardware available.

Services not covered

- Replacement or use of parts not manufactured for or by Lenovo or nonwarranted parts
- Identification of software problem sources
- Configuration of UEFI BIOS as part of an installation or upgrade
- Changes, modifications, or upgrades to device drivers
- Installation and maintenance of network operating systems (NOS)
- Installation and maintenance of programs

For the terms and conditions of the Lenovo Limited Warranty that apply to your Lenovo hardware product, go to:

- https://www.lenovo.com/warranty/llw_02
- <https://pcsupport.lenovo.com/warrantylookup>

Purchase additional services

During and after the warranty period, you can purchase additional services from Lenovo at <https://pcsupport.lenovo.com/warrantyupgrade>.

Service availability and service name might vary by country or region.

Appendix A. Compliance information

For compliance information, refer to *Regulatory Notice* at <https://pcsupport.lenovo.com> and *Generic Safety and Compliance Notices* at https://pcsupport.lenovo.com/docs/generic_notices.

Certification-related information

Table 3. Intel models

Product name	Compliance ID	Machine type(s)
ThinkPad T14s Gen 2 ThinkPad T14s Gen 2 HPD** ThinkPad T14s Gen 2 LTE1** ThinkPad T14s Gen 2 LTE2** ThinkPad T14s Gen 2 5G** ThinkPad T14s Gen 2 LTE1 HPD** ThinkPad T14s Gen 2 LTE2 HPD** ThinkPad T14s Gen 2 5G HPD**	TP00130A	20WM and 20WN
ThinkPad X13 Gen 2 ThinkPad X13 Gen 2 HPD** ThinkPad X13 Gen 2 LTE1** ThinkPad X13 Gen 2 LTE2** ThinkPad X13 Gen 2 5G** ThinkPad X13 Gen 2 LTE1 HPD** ThinkPad X13 Gen 2 LTE2 HPD** ThinkPad X13 Gen 2 5G HPD**	TP00131A / TP00131A0*** / TP00131A1***	20WK and 20WL

Table 4. AMD models

Product name	Compliance ID	Machine type(s)
ThinkPad T14s Gen 2 ThinkPad T14s Gen 2 AMD** ThinkPad T14s Gen 2 LTE AMD**	TP00130B	20XF and 20XG
ThinkPad X13 Gen 2 ThinkPad X13 Gen 2 AMD** ThinkPad X13 Gen 2 LTE AMD**	TP00131B / TP00131B0***/ TP00131B1***	20XH and 20XJ

** for mainland China only

*** for India only

Further compliance information related to your product is available at <https://www.lenovo.com/compliance>.

Locate the UltraConnect wireless antennas

Your computer has an UltraConnect™ wireless antenna system. You can enable wireless communication wherever you are.

Depending on the computer model, one of the following illustrations shows the antenna locations on your computer:

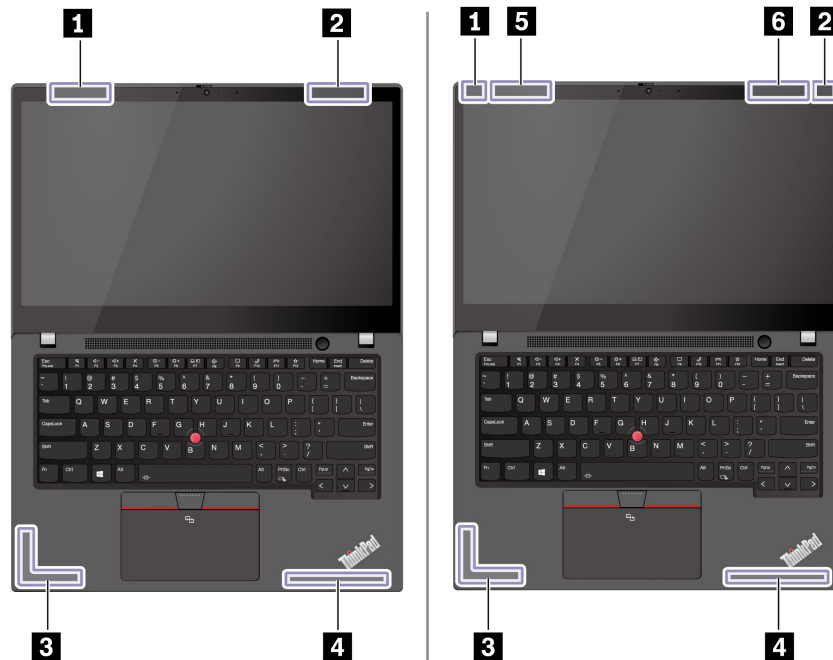

- 1 Wireless LAN antenna (auxiliary)
- 2 Wireless LAN antenna (main)
- 3 Wireless WAN antenna (main)*
- 4 Wireless WAN antenna (auxiliary)*
- 5 Wireless WAN antenna (MIMO 2)*
- 6 Wireless WAN antenna (MIMO 1)*

* for selected models

Federal Communications Commission (FCC) Supplier's Declaration of Conformity

Notes:

- The statements below regarding FCC are only valid for products that are shipping to the United States.
- Refer to the product label information to identify the specific model name and number of your product.

The following information refers to ThinkPad T14s Gen 2 and ThinkPad X13 Gen 2.

Product name	Machine types
ThinkPad T14s Gen 2	20WM, 20WN, 20XF, and 20XG
ThinkPad X13 Gen 2	20WK, 20WL, 20XH, and 20XJ

This equipment has been tested and found to comply with the limits for a Class B digital device, pursuant to Part 15 of the FCC Rules. These limits are designed to provide reasonable protection against harmful interference in a residential installation. This equipment generates, uses, and can radiate radio frequency energy and, if not installed and used in accordance with the instructions, may cause harmful interference to radio communications. However, there is no guarantee that interference will not occur in a particular installation. If this equipment does cause harmful interference to radio or television reception, which can be determined by turning the equipment off and on, the user is encouraged to try to correct the interference by one or more of the following measures:

- Reorient or relocate the receiving antenna.
- Increase the separation between the equipment and receiver.
- Connect the equipment into an outlet on a circuit different from that to which the receiver is connected.
- Consult an authorized dealer or service representative for help.

Lenovo is not responsible for any radio or television interference caused by using other than recommended cables and connectors or by unauthorized changes or modifications to this equipment. Unauthorized changes or modifications could void the user's authority to operate the equipment.

This device complies with Part 15 of the FCC Rules. Operation is subject to the following two conditions: (1) this device may not cause harmful interference, and (2) this device must accept any interference received, including interference that may cause undesired operation.

Responsible Party:
 Lenovo (United States) Incorporated
 7001 Development Drive
 Morrisville, NC 27560
 Email: FCC@lenovo.com



Operating environment

Maximum altitude (without pressurization)

3048 m (10 000 ft)

Temperature

- Operating: 5°C to 35°C (41°F to 95°F)
- Storage and transportation in original shipping packaging: -20°C to 60°C (-4°F to 140°F)
- Storage without packaging: 5°C to 43°C (41°F to 109°F)

Note: When you charge the battery, its temperature must be no lower than 10°C (50°F).

Relative humidity

- Operating: 8% to 95% at wet-bulb temperature 23°C (73°F)
- Storage and transportation: 5% to 95% at wet-bulb temperature 27°C (81°F)

Appendix B. Notices and trademarks

Notices

Lenovo may not offer the products, services, or features discussed in this document in all countries. Consult your local Lenovo representative for information on the products and services currently available in your area. Any reference to a Lenovo product, program, or service is not intended to state or imply that only that Lenovo product, program, or service may be used. Any functionally equivalent product, program, or service that does not infringe any Lenovo intellectual property right may be used instead. However, it is the user's responsibility to evaluate and verify the operation of any other product, program, or service.

Lenovo may have patents or pending patent programs covering subject matter described in this document. The furnishing of this document does not give you any license to these patents. You can send license inquiries, in writing, to:

*Lenovo (United States), Inc.
8001 Development Drive
Morrisville, NC 27560
U.S.A.
Attention: Lenovo Director of Licensing*

LENOVO PROVIDES THIS PUBLICATION "AS IS" WITHOUT WARRANTY OF ANY KIND, EITHER EXPRESS OR IMPLIED, INCLUDING, BUT NOT LIMITED TO, THE IMPLIED WARRANTIES OF NON-INFRINGEMENT, MERCHANTABILITY OR FITNESS FOR A PARTICULAR PURPOSE. Some jurisdictions do not allow disclaimer of express or implied warranties in certain transactions, therefore, this statement may not apply to you.

Changes are made periodically to the information herein; these changes will be incorporated in new editions of the publication. To provide better service, Lenovo reserves the right to improve and/or modify the products and software programs described in the manuals included with your computer, and the content of the manual, at any time without additional notice.

The software interface and function and hardware configuration described in the manuals included with your computer might not match exactly the actual configuration of the computer that you purchase. For the configuration of the product, refer to the related contract (if any) or product packing list, or consult the distributor for the product sales. Lenovo may use or distribute any of the information you supply in any way it believes appropriate without incurring any obligation to you.

The products described in this document are not intended for use in implantation or other life support applications where malfunction may result in injury or death to persons. The information contained in this document does not affect or change Lenovo product specifications or warranties. Nothing in this document shall operate as an express or implied license or indemnity under the intellectual property rights of Lenovo or third parties. All information contained in this document was obtained in specific environments and is presented as an illustration. The result obtained in other operating environments may vary.

Lenovo may use or distribute any of the information you supply in any way it believes appropriate without incurring any obligation to you.

Any references in this publication to non-Lenovo Web sites are provided for convenience only and do not in any manner serve as an endorsement of those Web sites. The materials at those Web sites are not part of the materials for this Lenovo product, and use of those Web sites is at your own risk.

Any performance data contained herein was determined in a controlled environment. Therefore, the result obtained in other operating environments may vary significantly. Some measurements may have been made on development-level systems and there is no guarantee that these measurements will be the same on generally available systems. Furthermore, some measurements may have been estimated through extrapolation. Actual results may vary. Users of this document should verify the applicable data for their specific environment.

This document is copyrighted by Lenovo and is not covered by any open source license, including any Linux® agreement(s) which may accompany software included with this product. Lenovo may update this document at any time without notice.

For the latest information or any questions or comments, contact or visit the Lenovo Web site:

<https://pcsupport.lenovo.com>

Trademarks

LENOVO, LENOVO logo, THINKPAD, THINKPAD logo, TRACKPOINT, and ULTRACONNECT are trademarks of Lenovo. Intel and Thunderbolt are trademarks of Intel Corporation or its subsidiaries in the U.S. and/or other countries. Linux is the registered trademark of Linus Torvalds in the U.S. and other countries. Microsoft, Windows, BitLocker, and Cortana are trademarks of the Microsoft group of companies. DisplayPort is a registered trademark of the Video Electronics Standards Association. NVIDIA is a registered trademark of NVIDIA Corporation. The terms HDMI and HDMI High-Definition Multimedia Interface are trademarks or registered trademarks of HDMI Licensing LLC in the United States and other countries. USB-C is a registered trademark of USB Implementers Forum. Wi-Fi and Miracast are registered trademarks of Wi-Fi Alliance. All other trademarks are the property of their respective owners. © 2021 Lenovo.